











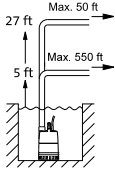

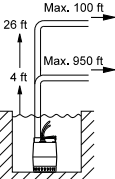
Unilift CC, KP, AP

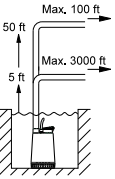
Submersible wastewater pumps
60 Hz

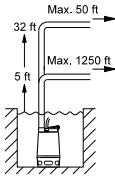

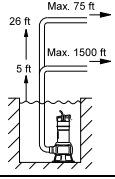
1. Product overview, Unilift	3
2. General data, Unilift	4
Performance range	4
Applications	5
Type keys	6
Construction	6
3. Technical data and performance curves	7
Unilift CC	7
Unilift KP	11
Unilift AP12	15
Unilift AP35	20
Unilift AP35B	25
Unilift AP50	30
Unilift AP50B	35
Duolift System	40
Unolift Systems	42
EF25	44
SU25	46
4. Control panels	48
Model 112, simplex	48
Model 122, duplex	49
IFS 1, simplex	50
IFS 1, duplex	51
5. Alarms	52
Tank Alert® I	52
Tank Alert® 4X	53
Tank Alert® AB	54
6. Accessories	55
Mechanical float switches	55
Basins	55
7. Pump and system sizing instructions	57
Pump and system sizing instructions	57
8. Grundfos Product Center	62
Grundfos GO	63

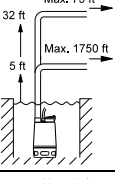
1. Product overview, Unilift

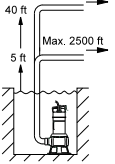
	Application		Technical data	Sizing
	<p>Unilift CC Unilift CC is a submersible pump designed for pumping clean, non-aggressive water and slightly dirty (grey) wastewater. Unilift CC can pump down to 0.12" water level and can be used in permanent installations or as a portable pump.</p>		<ul style="list-style-type: none"> • Max. flow rate, Q: 62 GPM • Max. head, H: 30.8 feet • Liquid temp.: 32 °F to 104 °F • Max. particle size: 0.4" • Material: Composite • Suction down to 0.12". 	 <p>TM04 3028 3508</p>
Drainage	<p>Unilift KP Unilift KP is a submersible pump designed for pumping clean, non-aggressive water and slightly dirty (grey) wastewater such as domestic effluents from septic and sludge treating systems.</p>		<ul style="list-style-type: none"> • Max. flow rate, Q: 65 GPM • Max. head, H: 32 feet • Liquid temp.: 32 °F to 122 °F • Max. particle size: 0.4" • Material: Stainless steel. 	 <p>TM04 3029 3508</p>
	<p>Unilift AP12 Unilift AP12 is a submersible pump designed for pumping clean, non-aggressive water and slightly dirty (grey) wastewater. The pump can be used as a portable unit.</p>		<ul style="list-style-type: none"> • Max. flow rate, Q: 140 GPM • Max. head, H: 52 feet • Liquid temp.: 32 °F to 131 °F • Max. particle size: 0.4" • Material: Stainless steel. 	 <p>TM04 3030 3508</p>
	<p>Unilift AP35 Unilift AP35 is a submersible pump designed for pumping dirty water, untreated wastewater (excluding toilet discharge) and liquids containing fibers from light industry, laundries, etc. with particles up to 1.4".</p>		<ul style="list-style-type: none"> • Max. flow rate, Q: 79 GPM • Max. head, H: 39 feet • Liquid temp.: 32 °F to 131 °F • Max. particle size: 1.4" • Material: Stainless steel. 	 <p>TM04 3031 3508</p>
Effluent	<p>Unilift AP35B Unilift AP35B is a submersible pump designed for pumping effluents (excluding toilet discharge). The pump is suitable for installation on auto coupling; this allows easy access to the pump for maintenance and other purposes.</p>		<ul style="list-style-type: none"> • Max. flow rate, Q: 92 GPM • Max. head, H: 43 feet • Liquid temp.: 32 °F to 104 °F • Max. particle size: 1.4" • Material: Stainless steel 	 <p>TM034 3033 3508</p>
	<p>Unilift AP50 Unilift AP50 is a submersible pump designed for pumping dirty water, untreated wastewater and liquids containing fibers from light industry, laundries, etc. with particles up to 2.0".</p>		<ul style="list-style-type: none"> • Max. flow rate, Q: 140 GPM • Max. head, H: 41 feet • Liquid temp.: 32 °F to 131 °F • Max. particle size: 2.0" • Material: Stainless steel. 	 <p>TM04 3032 3508</p>
Domestic sewage	<p>Unilift AP50B Unilift AP50B is a submersible pump designed for pumping effluents. The pump is suitable for installation on auto-coupling allowing easy access to the pump for maintenance and other purposes.</p>		<ul style="list-style-type: none"> • Max. flow rate, Q: 136 GPM • Max. head, H: 49 feet • Liquid temp.: 32 °F to 104 °F • Max. particle size: 2.0" • Material: Stainless steel 	 <p>TM04 3034 3508</p>

2. General data, Unilift

Performance range

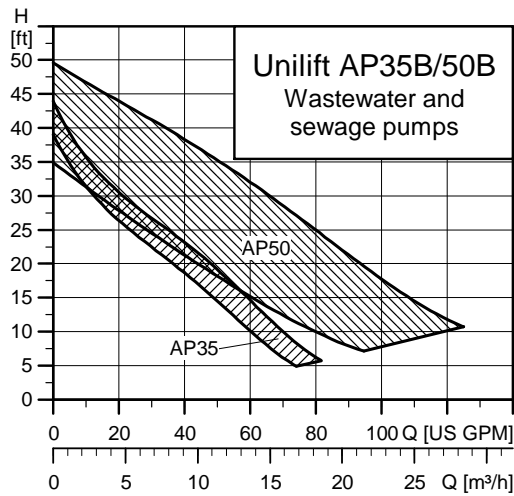
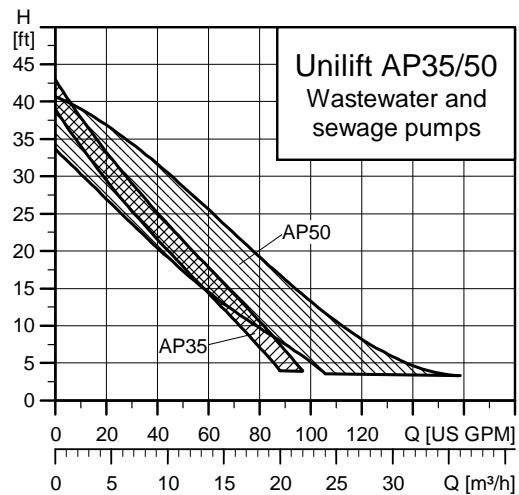
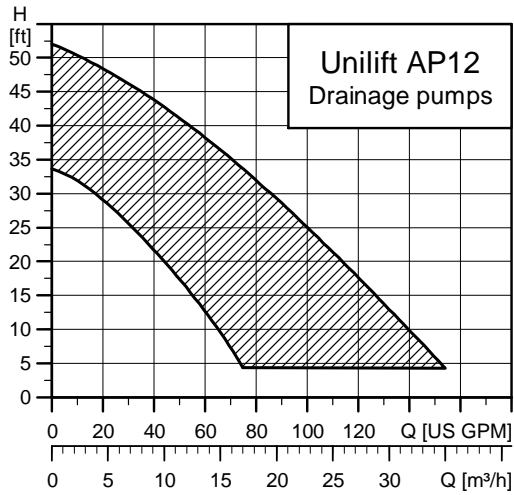
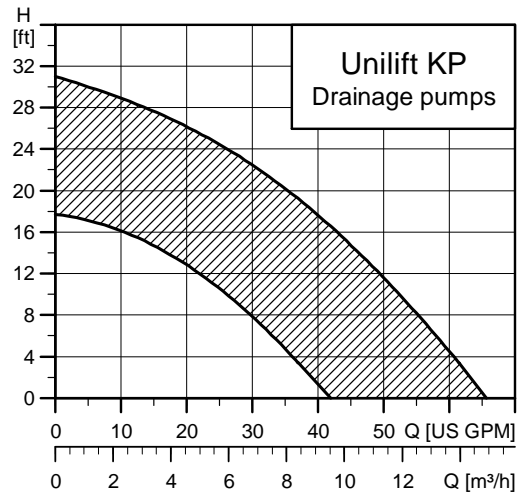
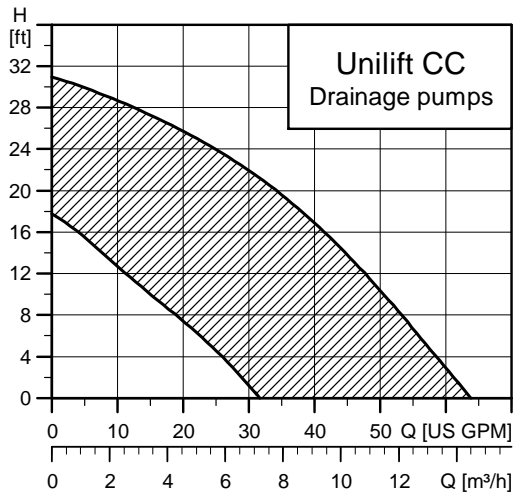

Applications

The Unilift CC, KP and AP are submersible wastewater pumps suitable for temporary as well as permanent free-standing installation.

The pumps are designed for intermittent operation.

pH values:

- Unilift CC: 4 to 9
- Unilift KP: 4 to 9
- Unilift AP: 4 to 10.

Maximum density: 146.88 ounce/gallon.

Maximum installation depth below water level: 34 feet.

Examples of applications

Application	Unilift pump type						
	CC	KP	AP12	AP35	AP35B	AP50	AP50B
Max. liquid temperature	104 °F	122 °F	131 °F	131 °F	104 °F	131 °F	104 °F
Max. particle size [mm] / [inch]	10/0.4	10/0.4	12/0.4	35/1.4	35/1.4	50/2.0	50/2.0
Non-permanent, light-duty applications (used as a portable pump)	•	•	○	○	○	○	○
Non-permanent, heavy-duty applications for installers and light industry (used as a portable pump)			•	•	•	•	•
Pumping of:							
Water and rainwater in horticulture	•	•	•				
Water from rivers and lakes	•	•	•	•	•	•	•
Rainwater, drainage water and water from flooding	•	•	•	•	•	•	•
Water for filling/emptying containers, ponds, tanks, etc.	•	•	•	•	•	•	•
Effluents from showers, washing machines and sinks below sewer level	•	•	•	•	•	•	•
Pool water	•	•	•	•	•	•	•
Ditch drainage water	•	•	•	•	•	•	•
Groundwater (lowering applications)	•	•	•	•	•	•	•
Domestic effluents from septic and sludge-treating systems	○	•	•	•	•	•	•
Liquids containing fibres from light industry, laundries, etc.				•	•	•	•
Effluents from viaducts, underpasses, etc.				•	•	•	•
Drainage water from garage sprinkler systems				○	○	○	○
Domestic wastewater with toilet discharge from pipes and water closets below sewer level, outdoor pump installations						•	•
Domestic wastewater with toilet discharge from pipes and water closets below sewer level, indoor pump installations							Not applicable
• = Recommended pump type ○ = Alternative pump type							

Wastewater definitions

Drainage

Raw water, drainage and untreated wastewater containing solids no larger than 0.4" from households, farms and small industry.

Effluent

Dirty water and untreated wastewater (excluding toilet discharge), containing fibers and solids no larger than 1.4" from dewatering systems, domestic wastewater systems and small industry.

Sewage

Untreated wastewater and raw sewage containing fibers, textiles and other solids, including toilet discharge from domestic sewage systems, farms and industry no larger than 2.0".

Pump overview

Pump range Unilift	Free passage [mm] / [inch]	Impeller type	Number of motor poles
CC	10/0.4	Semi-open	2
KP	10/0.4	Semi-open	2
AP12	12/0.4	Semi-open	2
AP35	35/1.4	Vortex	2
AP35B	35/1.4	Vortex	2
AP50	50/2.0	Vortex	2
AP50B	50/2.0	Vortex	2

Type keys

Unilift CC pumps

Example	Unilift	CC	9	A1
Type range				
Type				
Maximum head [m]				
5				
7				
9				
Operation:				
A1 = Automatic operation				
M1 = Manual operation				

Unilift KP pumps

Example	Unilift	KP	150	A	1
Type range					
Rated motor output, P_2 [W]:					
150					
250					
350					
Level control:					
S = with integrated, electronic sensor (automatic operation)					
A = with float switch (automatic operation)					
M = without level switch (manual operation)					
Motor:					
1 = single-phase					
3 = three-phase					

Unilift AP pumps

Example	Unilift	AP	35	B.	50.	08.	A	1	.V
Type range									
Maximum solids size (mm)									
Pump type:									
Blank = AP pump									
B = AP Basic									
Nominal diameter of discharge port									
Power output P_2 /100 [W]									
Level control:									
A = Automatic operation (with float switch)									
Blank = Manual operation (without float switch)									
Motor:									
1 = Single-phase									
3 = Three-phase									
Impeller:									
V = Vortex impeller									

Construction

Vertical, single-stage, submersible centrifugal pumps with horizontal or vertical discharge port designed for free-standing installation or for installation in collecting tanks.

The pumps are directly connected to an asynchronous submersible motor for 1 x 115 V + 6/- 10 %, 1 x 230 V + 6/- 10 %, 60 Hz.

Enclosure class: IP68

Insulation class: B or F.

Unilift pumps

Single-phase pumps incorporate thermal overload protection and require no additional motor protection.

Installation

The pumps are suitable for free-standing installation.

Pumps for vertical dry tank installation can be installed by means of a stationary stand with suction bend.

Follow current local electrical codes or national electric codes (NEC) for electrical connection of pumps.

3. Technical data and performance curves

Unilift CC

Product description



TM03 1358 1805

Fig. 1 Unilift CC

Unilift CC 5, CC 7 and CC 9 pumps are single-stage submersible pumps able to pump down to 0.12" water level. The pumps are designed for pumping rainwater and grey wastewater from places such as

- washing machines, baths, sinks, etc. from low-lying parts of buildings up to sewer level
- cellars or buildings prone to flooding
- draining wells
- collecting wells for surface water with inlets from roof gutters, tunnels, etc.
- swimming pools, ponds or fountains.

The pumps are suitable for permanent installation or they can be used as portable pumps. They are available in two versions:

- M for manual operation
- A for automatic operation.

The pumps allow free passage of particles up to 0.4".

Approvals



Pumped liquids

The pumps are suitable for these liquids:

- clean, non-aggressive water
- slightly dirty (grey) wastewater.

The pumps are **not** suitable for these liquids:

- liquids containing long fibres
- inflammable liquids (oil, petrol, etc.)
- aggressive liquids.

If the pump has been used for other liquids than clean water, it should be flushed through with clean water immediately after use.

Components included

The pump is supplied with an adapter and a non-return valve.

The adapter has 0.75", 1" and 1.25" NPT external threads. It must be cut to fit the discharge pipe.

The non-return valve can be fitted in the adapter to pre-vent backflow through the pump when it stops.

Pump sleeve and housing

The sleeve is made of composite material cast in one piece with a 1.25" NPT external pipe thread (G) discharge connection. A slot on the handle holds the float switch cable.

The main cable and flow switch cable are introduced into the sleeve through hermetically sealed cable entries.

The suction strainer is fitted to the sleeve by giving it a light push and can be removed easily by means of a screwdriver or similar tool. The water enters the pump through the holes of the suction strainer preventing the passage of large solids. The large holes also ensure a slow flow into the pump.

Suction to low water level is obtained by removing the strainer.

Motor

The motor is a single-phase, asynchronous, dry-rotor motor. The axial rotor position is secured by means of a ball bearing. The motor is cooled by the pumped liquid around the motor.

	Insulation class	Enclosure class
Unilift CC 5	B (115 V) F (230 V)	IP68
Unilift CC 7	B (115 V) F (230 V)	IP68
Unilift CC 9	B	IP68

The motor incorporates automatic overload protection cutting out the motor in case of overload. When cooled to normal temperature, the motor will restart automatically.

Materials

Component	Material	DIN W.-Nr.
Motor sleeve	PP 15 GF	
Pump sleeve	PP 15 GF	
Impeller	PPOm 20 GF	
Suction strainer	Stainless steel class A2	1.4301
V-ring	NBR 50	
O-rings	NBR 70	
Cable	SJTW-A 3AWG18	

Selection

The flow velocity through the discharge pipe must be minimum 2.3 ft/s to ensure self-cleaning.

Example: Schedule 40 PVC discharge pipe with an inner diameter of 0.824" requires a minimum flow velocity of approximately 4 gpm.

The overview below shows the maximum lengths of combined vertical and horizontal Schedule 40 PVC discharge pipes.

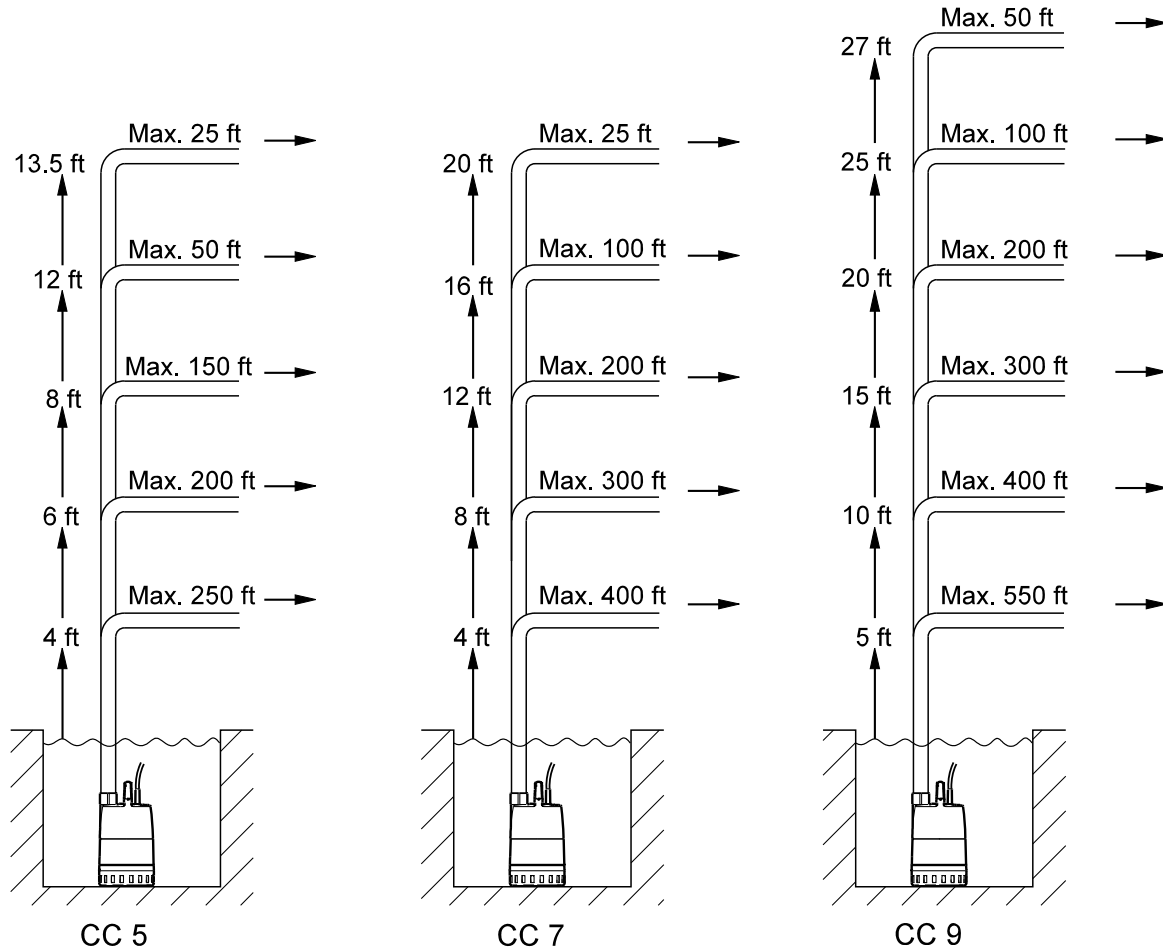

The overview is only intended as a guide. Grundfos is not liable for installations not complying with the overview.

Note: If a non-return valve is used, the pressure drop in the valve will be approximately 0.6 ft head which must be subtracted from the vertical pipe lengths.

The vertical height of the discharge pipe should be measured from the pump stop level.

TM04 3041 3508

Performance curves

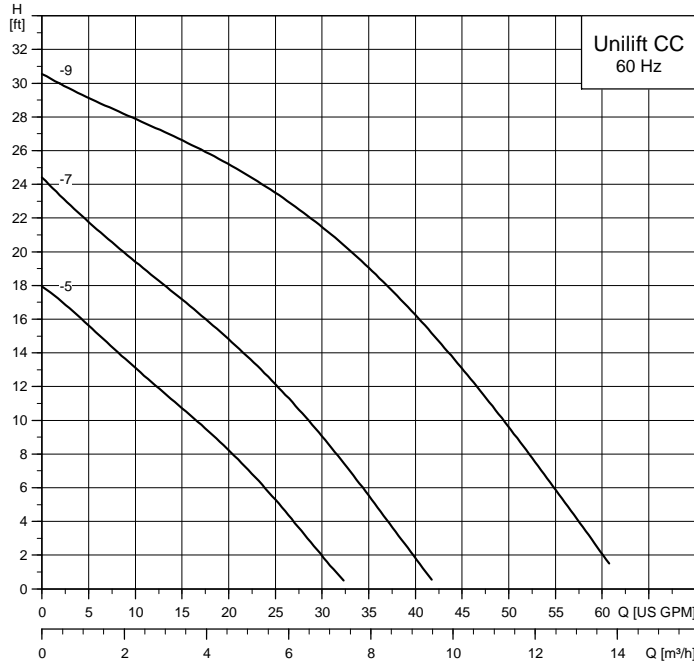

TM04 2257 2208

Operating conditions

Liquid temperature

32 °F to 104 °F.

However, at intervals of at least 30 minutes, the pump is allowed to run at maximum +158 °F for periods not exceeding two minutes.

Installation

The pump can be used in the vertical position as well as in the tilted or horizontal position with the discharge port as the highest point of the pump. The suction strainer must be covered by the pumped liquid.

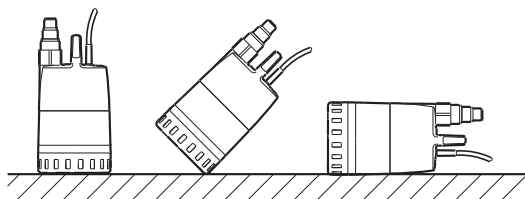

Fig. 2 Pump positions

TM00 1111 1005

Installation depth

Maximum 32 ft below the water surface.

Adjustment of cable length for float switch

The difference in level between start and stop can be adjusted by changing the free cable length between the float switch and the pump handle.

- Increasing the free cable length results in fewer starts/stops and a large difference in level.
- Reducing the free cable length results in more frequent starts/stops and a small difference in level.

In order for the float switch to start and stop the pump, the free cable length must be minimum 3.94" and maximum 7.87".

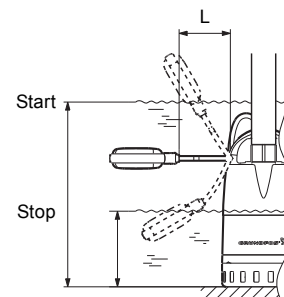

Fig. 3 Start-stop levels, Unilift CC

TM03 0829 0505

Pump type	Cable length (L) Min. 3.94"		Cable length (L) Max. 7.87"	
	Start [inches]	Stop [inches]	Start [inches]	Stop [inches]
Unilift CC 5	13.78	4.53	15.75	2.2
Unilift CC 7	13.78	4.53	15.75	2.2
Unilift CC 9	15.16	5.9	17	3.5

Technical data

Product no.	Pump type	Voltage [V]	P2 [hp]	I _n [A]	I _{Start} [A]	Dimensions [inches]					Weight [lbs]	Cable length and plug
						H	B	H1	B1	B2		
96780906	Unilift CC 5 - M1	1 x 115	0.1	2.1	3.2	20.47	15.75	12.01	6.3	1.04	9.6	8 feet with Nema 5
96781199	Unilift CC 5 - A1	1 x 115	0.1	2.1	3.2	20.47	15.75	12.01	6.3	1.04	9.6	8 feet with Nema 5
96781212	Unilift CC 7 - M1	1 x 115	0.2	2.8	5.6	22.44	19.69	13.39	6.3	1.04	10.1	8 feet with Nema 5
96781220	Unilift CC 7 - A1	1 x 115	0.2	2.8	5.6	20.47	15.75	12.01	6.3	1.04	10.1	8 feet with Nema 5
96781221	Unilift CC 9 - M1	1 x 115	0.6	5.6	16.2	20.47	15.75	12.01	6.3	1.04	14.3	8 feet with Nema 5
96781223	Unilift CC 9 - A1	1 x 115	0.6	5.6	16.2	22.44	19.69	13.39	6.3	1.04	14.3	8 feet with Nema 5
96781224	Unilift CC 5 - M1	1 x 230	0.1	1	1.6	20.47	15.75	12.01	6.3	1.04	9.6	8 feet with Nema 6
96781225	Unilift CC 5 - A1	1 x 230	0.1	1	1.6	20.47	15.75	12.01	6.3	1.04	9.6	8 feet with Nema 6
96781229	Unilift CC 7 - M1	1 x 230	0.2	1.2	2.5	22.44	19.69	13.39	6.3	1.04	10.1	8 feet with Nema 6
96781230	Unilift CC 7 - A1	1 x 230	0.2	1.2	2.5	20.47	15.75	12.01	6.3	1.04	10.1	8 feet with Nema 6
96781231	Unilift CC 9 - M1	1 x 230	0.6	2.5	7.3	20.47	15.75	12.01	6.3	1.04	14.3	8 feet with Nema 6
96781233	Unilift CC 9 - A1	1 x 230	0.6	2.5	7.3	22.44	19.69	13.39	6.3	1.04	14.3	8 feet with Nema 6

With float switch

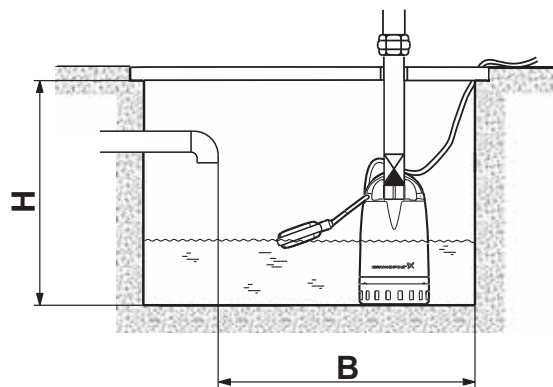

Fig. 4 Minimum well dimensions, Unilift CC

If the pump is installed in a collecting well, the minimum dimensions of the well should be as shown above to ensure free movability of the float switch.

Without float switch

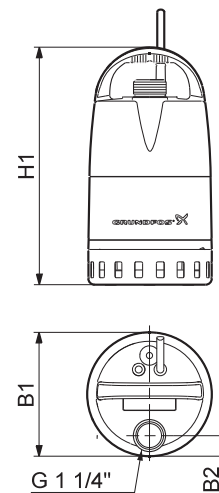

Fig. 5 Pump dimensions

The space required corresponds to the physical dimensions of the pump.

Unilift KP

Product description



Gr0111

Fig. 6 Unilift KP

The Unilift KP pump is designed for liquid transfer and drainage of clean or slightly dirty wastewater with the pump completely or partly submerged in the liquid.

The pump is suitable for these applications:

- drainage of flooded cellars or buildings
- pumping of domestic wastewater without toilet waste
- emptying of pools, tanks and vessels
- pumping within agriculture, the dairy industry, horticulture and the process industry.

Approvals



Pumped liquids

The pumps are suitable for these liquids:

- clean, non-aggressive water
- slightly dirty (grey) wastewater.

If the pump has been used for other liquids than clean water, it should be flushed through with clean water immediately after use. The open-impeller construction ensures a free passage of solids up to a diameter of 0.4".

Operating conditions

Installation depth: Max. 30 ft below liquid level

Min. liquid temperature: 32 °F

Max. liquid temperature at continuous operation: 122 °F

During continuous pumping, the suction strainer must always be completely covered by the liquid.

Max. liquid temperature: 158 °F for periods not exceeding two minutes at intervals of at least 30 minutes.

Discharge port

Unilift KP 150, KP 250 and KP 350: 1.25" NPT.

Construction

Single-stage, submersible, stainless steel, drainage pump in a robust design with upward-pointing discharge port placed on top of the pump.

The water enters the pump through the holes of the suction strainer, preventing the passage of large solids. The sturdy impeller has single-curved vanes with bevelled front edges preventing fibres from jamming the impeller. The guide vanes in the pump housing guide the liquid, lifting sand grains into the liquid flow, thus preventing blocking by sand.

The pump sleeve is made in one piece. The mains cable enters through a vulcanized and water-tight plug, which is secured to the socket of the hermetically sealed stator housing.

Motor

The motor is a single- or three-phase asynchronous canned motor with liquid-filled rotor chamber and water-lubricated bearings. The motor is cooled by the pumped liquid around the motor.

Enclosure class: IP68

Insulation class: F.

The motor incorporates automatic overload protection which cuts out the motor in case of overload. When cooled to normal temperature, the motor restarts automatically.

Materials

Component	Material	DIN W.-Nr.	AISI
Pump sleeve	Stainless steel	1.4301	304
Pump housing	Stainless steel	1.4301	304
Suction strainer	Stainless steel	1.4301	304
Impeller	Stainless steel	1.4301	304
Shaft	Stainless steel	1.4057	431
Stator housing	Stainless steel	1.4301	304
Guide vanes	Stainless steel	1.4301	304
Bearings	Carbon		
O-rings, Seal rings	NBR		
Cables	16 AWG 3/C SJOW 90C		

Selection

The flow velocity through the discharge pipe must be minimum 2.3 ft/s to ensure self-cleaning.

Example: Schedule 40 PVC discharge pipe with an inner diameter of 1.38" requires a minimum flow velocity of approximately 12 gpm.

The overview below shows the maximum lengths of combined vertical and horizontal Schedule 40 PVC discharge pipes.

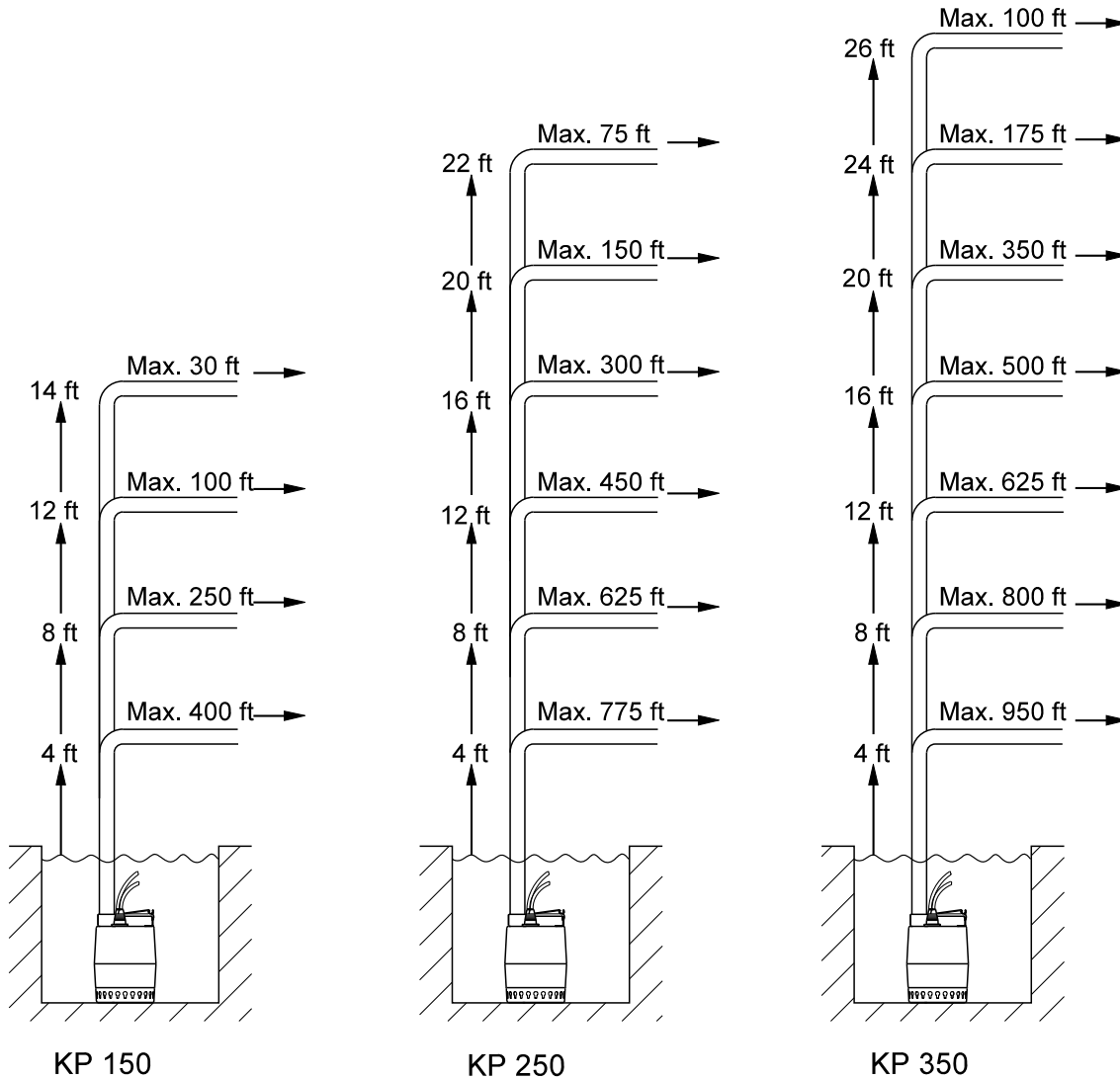

The overview is only intended as a guide. Grundfos is not liable for installations not complying with the overview.

Note: If a non-return valve is used, the pressure drop in the valve will be approximately 0.6 ft head which must be subtracted from the vertical pipe lengths.

The vertical height of the discharge pipe should be measured from the pump stop level.

TM04 3040 3508

Performance curves

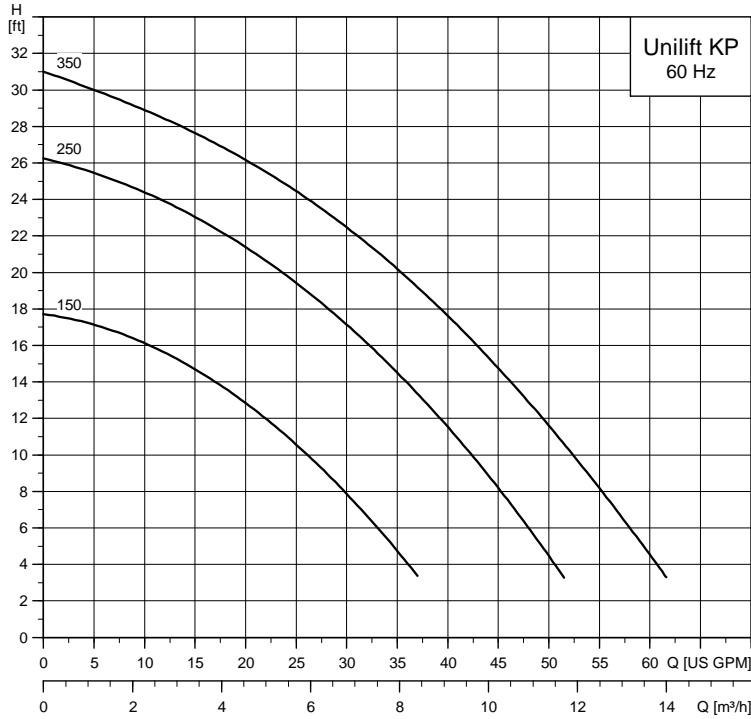

TM04 2409 2508

Installation

Pumps without float switch can be used in vertical position with the discharge port pointing upwards or in horizontal or tilted position with the discharge port as the highest point of the pump.

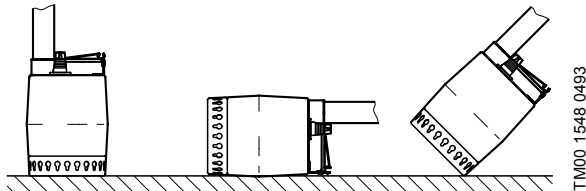

Fig. 7 Pump positions

TM00 1548 0493

Adjustment of cable length for float switch

A clamp on the pump handle holds the float switch cable. The difference in level between start and stop can be adjusted by changing the free cable length between the pump handle and the float switch.

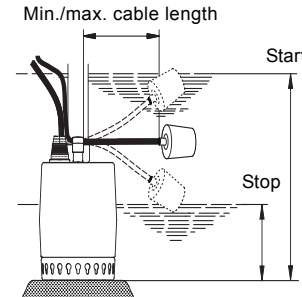

Fig. 8 Start-stop level, Unilift KP

TM03 4331 2006

The start/stop level varies according to the cable length.

	Cable length Min. 2.5"		Cable length Max. 6"	
	Start	Stop	Start	Stop
Unilift KP 150	11.5"	5.5"	12.5"	3.5"
Unilift KP 250	11.5"	5.5"	12.5"	3.5"
Unilift KP 350	12"	6"	13"	4"

Technical data

Product no.	Pump type	Voltage [V]	P2 [hp]	I_n [A]	I_{Start} [A]	Dimensions [inches]			Weight [lbs]	Cable length and plug
						H	B1	B2		
96847184	KP 150 A-1	1x115	1/4	2.9	8.7	8.86	5.87	1.22	14.33	10 feet with Nema 5
96847185	KP 150 A-1	1x115	1/4	2.9	8.7	8.86	5.87	1.22	14.33	25 feet with Nema 5
011DC001	KP 150 M-1	1x115	1/4	2.9	8.7	8.86	5.87	1.22	14.33	10 feet with Nema 5
011DC201	KP 150 M-1	1x115	1/4	2.9	8.7	8.86	5.87	1.22	14.33	25 feet with Nema 5
96847186	KP 250 A-1	1x115	1/3	4.9	14.5	8.86	5.87	1.22	15.43	10 feet with Nema 5
96847425	KP 250 A-1	1x115	1/3	4.9	14.5	8.86	5.87	1.22	15.43	25 feet with Nema 5
012DC001	KP 250 M-1	1x115	1/3	4.9	14.5	8.86	5.87	1.22	15.43	10 feet with Nema 5
012DC201	KP 250 M-1	1x115	1/3	4.9	14.5	8.86	5.87	1.22	15.43	25 feet with Nema 5
96847640	KP 350 A-1	1x115	1/2	7.5	21.4	9.25	5.87	1.22	17.64	10 feet with Nema 5
96847798	KP 350 A-1	1x115	1/2	7.5	21.4	9.25	5.87	1.22	17.64	25 feet with Nema 5
013DC001	KP 350 M-1	1x115	1/2	7.5	21.4	9.25	5.87	1.22	17.64	10 feet with Nema 5
013DC201	KP 350 M-1	1x115	1/2	7.5	21.4	9.25	5.87	1.22	17.64	25 feet with Nema 5

With float switch

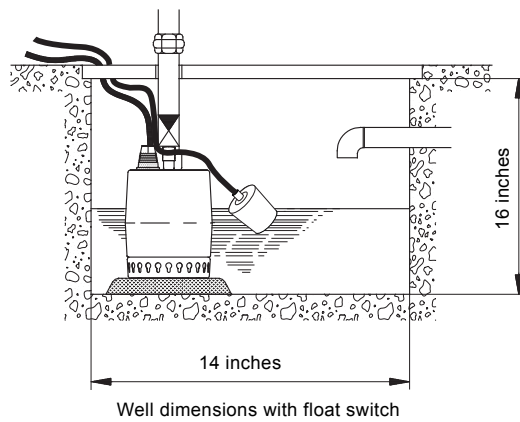

Fig. 9 Minimum well dimensions, Unilift KP

If the pump is installed in a collecting well, the minimum dimensions of the well should be as shown above to ensure free movability of the float switch.

Without float switch

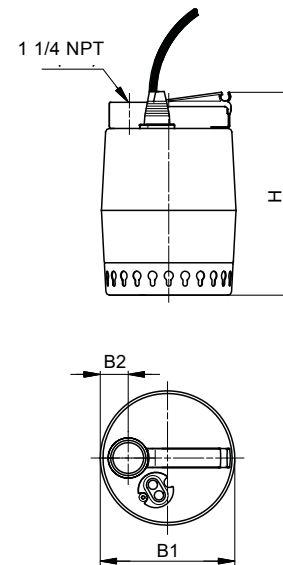

Fig. 10 Pump dimensions

The space required corresponds to the physical dimensions of the pump.

TM03 4330 2006

TM04 31874 4009

Unilift AP12

Product description



Fig. 11 Unilift AP12

The Unilift AP12 pump is a single-stage submersible pump designed for pumping drainage water.

The pump is suitable for these applications:

- groundwater lowering
- pumping in drainage collecting wells
- pumping in surface water collecting wells with inflow from roof gutters, shafts, tunnels, etc.
- emptying ponds, tanks, etc.

Maximum particle size: 0.4".

Liquid temperature range: 32 °F to 131 °F.

Approvals



Operation

The pump can be used for automatic as well as manual operation and can be installed in a permanent installation or used as a portable pump.

To enable automatic operation the pump can be fitted with a float switch or it can be connected to separate level switch and control box for automatic on/off operation.

Pump sleeve and housing

The stainless steel pump sleeve is made in one piece and equipped with an insulated carrying handle. The suction strainer is clipped on to the pump housing for easy removal in connection with maintenance. The strainer prevents the passage of large solids and ensures a slow flow into the pump. As a result, most impurities are prevented from entering the pump.

The stainless steel pump housing is fitted with an internal riser pipe ensuring high efficiency.

The riser pipe has a number of holes enabling efficient cooling of the motor during operation. The cable entry is of the socket and plug connection type for quick and easy dismantling.

Discharge port

All Unilift AP12 pumps have a threaded vertical discharge port.

Unilift AP12.40: 1.5" NPT.

Unilift AP12.50: 2.0" NPT.

Shaft and bearings

The stainless steel shaft rotates in maintenance-free prelubricated ball bearings.

Impeller

The stainless steel impeller is a semi-open impeller with L-shaped blades and a clearance of 0.4". The blades are curved backwards to reduce any harmful effect from solid particles and to minimise power consumption.

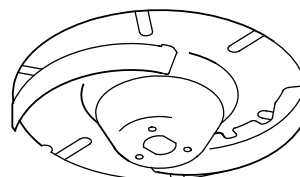

Fig. 12 Impeller, Unilift AP12

Shaft seal

The shaft seal is a combination of a mechanical bellows shaft seal and a lip seal with 2 fl.oz. oil between. Seal faces are made of silicone carbide.

G10113

TM00 5477 0895

Motor

The motor is a single- or three-phase asynchronous dry-rotor motor.

Enclosure class: IP68

Insulation class: F (311 °F)

Cable type: SJOW-A.

Single-phase motors have built-in thermal protection.

Adjustment of cable length for float switch

The difference in level between start and stop can be adjusted by changing the free cable length between the float switch and the pump handle.

- Increasing the free cable length will result in fewer starts/stops and a large difference in level.
- Reducing the free cable length will result in more frequent starts/stops and a small difference in level.

In order for the float switch to start and stop the pump, the free cable length must be min. 4". When adjusting the free cable end, make sure that the suction strainer is always covered by water.

Materials

Component	Material	DIN W.-Nr.	AISI
Pump housing	Stainless steel	1.4301	304
Riser pipe	Stainless steel	1.4301	304
Impeller	Stainless steel	1.4301	304
Pump sleeve	Stainless steel	1.4401	316
Pump shaft - wet end	Stainless steel	1.4301	304
Bearings	Heavy-duty prelubricated ball bearings		
O-rings	NBR rubber		
Screws	Stainless steel	1.4301	304
Oil	Shell Ondina 15, non-toxic		

Selection

The flow velocity through the discharge pipe must be minimum 2.3 ft/s to ensure self-cleaning.

Example: Schedule 40 PVC discharge pipe with an inner diameter of 1.61" requires a minimum flow velocity of approximately 15 gpm (AP12.40).

Schedule 40 PVC discharge pipe with an inner diameter of 2.067" requires a minimum flow velocity of approximately 24 gpm (AP12.50).

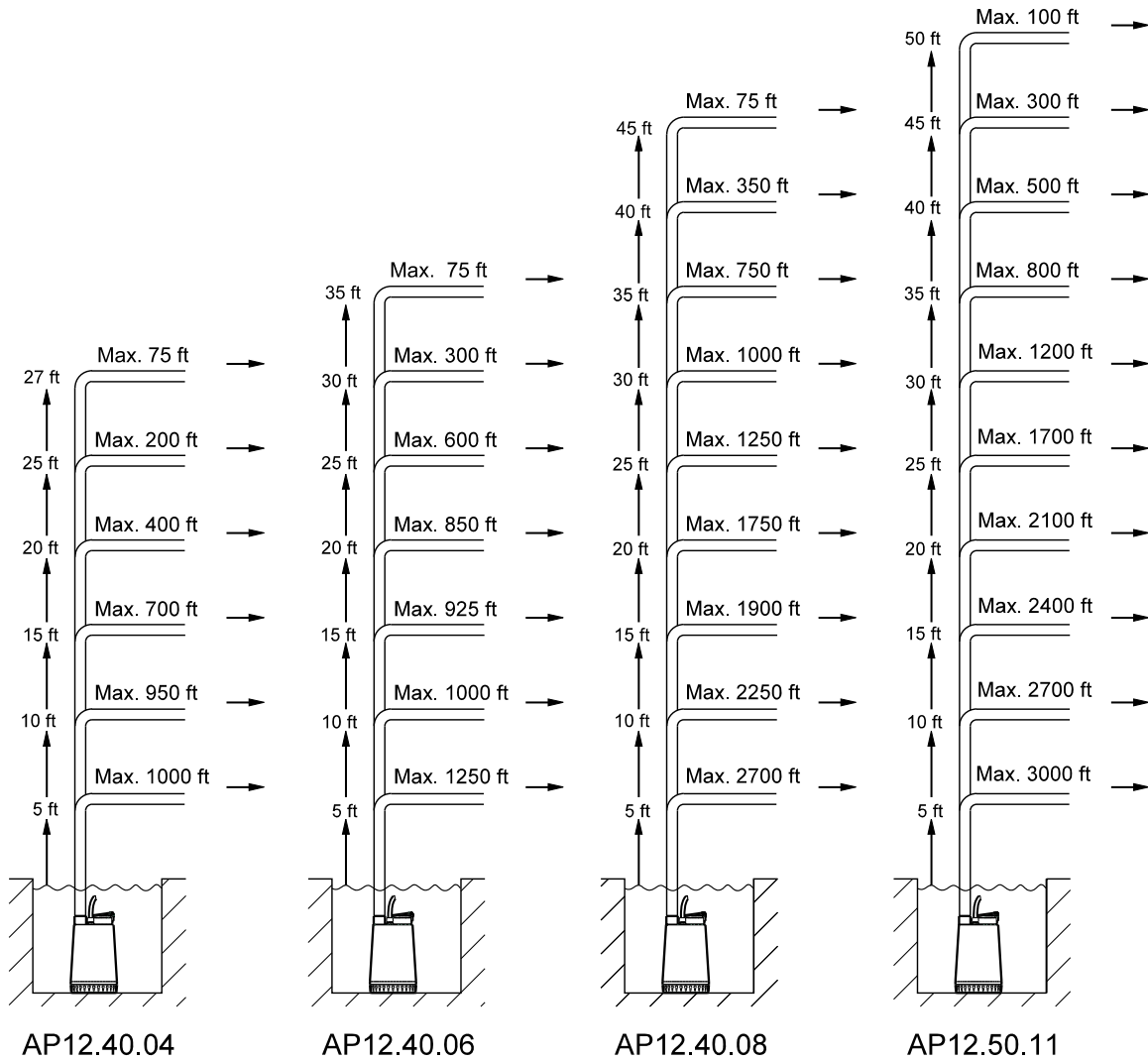

TM04 3035 3508

The overview is only intended as a guide. Grundfos is not liable for installations not complying with the overview.

Note: If a non-return valve is used, the pressure drop in the valve is approximately 0.6 ft head which must be subtracted from the vertical pipe lengths.

The vertical height of the discharge pipe should be measured from the pump stop level.

Performance curves

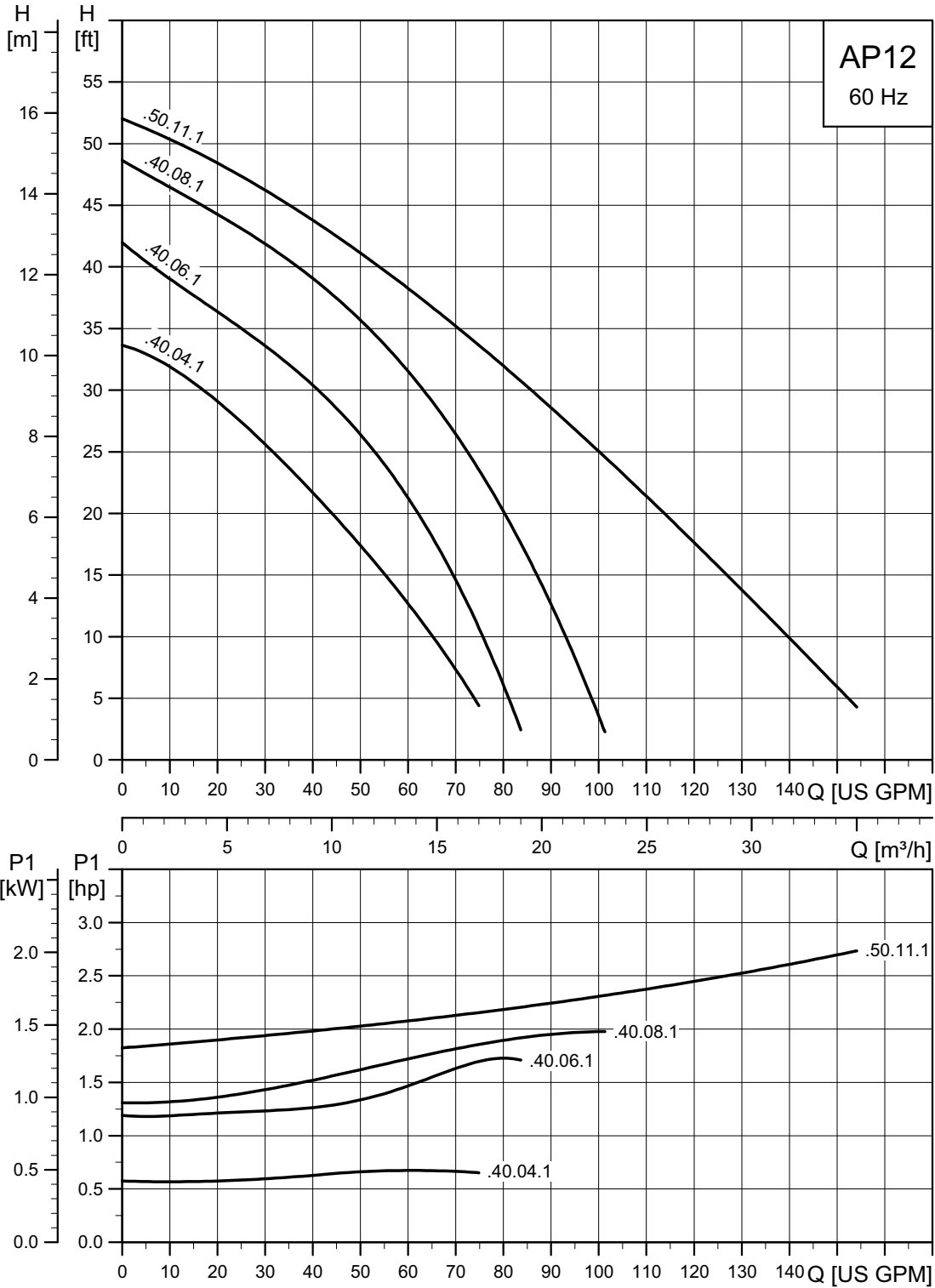

TM04 3001 0615

Technical data

Product no.	Pump type	Voltage [V]	P2 [hp]	I _n [A]	I _{Start} [A]	Dimensions [inches]			Weight [lbs]	Cable length and plug
						A	B	S		
96023926	Unilift AP12.40.04.1	1 x 115	1/2	8	24	12.6	8.5	1.5 NPT	23.1	10 feet with Nema 5
96011036	Unilift AP12.40.04.1	1 x 115	1/2	8	24	12.6	8.5	1.5 NPT	24.3	25 feet with Nema 5
96847167	Unilift AP12.40.04A.1	1 x 115	1/2	8	24	12.6	8.5	1.5 NPT	23.1	10 feet with Nema 5
96847166	Unilift AP12.40.04A.1	1 x 115	1/2	8	24	12.6	8.5	1.5 NPT	24.3	25 feet with Nema 5
96010656	Unilift AP12.40.06.1	1 x 230	3/4	4.4	21	12.6	8.5	1.5 NPT	26.5	10 feet / No Plug
96010658	Unilift AP12.40.06.1	1 x 230	3/4	4.4	21	12.6	8.5	1.5 NPT	24.9	25 feet / No Plug
96847169	Unilift AP12.40.06A.1	1 x 230	3/4	4.4	21	12.6	8.5	1.5 NPT	26.5	10 feet / No Plug
96847168	Unilift AP12.40.06A.1	1 x 230	3/4	4.4	21	12.6	8.5	1.5 NPT	24.9	25 feet / No Plug
96010662	Unilift AP12.40.08.1	1 x 230	1.0	5.8	29	12.6	8.5	1.5 NPT	29.1	10 feet / No Plug
96010664	Unilift AP12.40.08.1	1 x 230	1.0	5.8	29	12.6	8.5	1.5 NPT	30.9	25 feet / No Plug
96847170	Unilift AP12.40.08A.1	1 x 230	1.0	5.8	29	12.6	8.5	1.5 NPT	29.1	10 feet / No Plug
96847171	Unilift AP12.40.08A.1	1 x 230	1.0	5.8	29	12.6	8.5	1.5 NPT	30.9	25 feet / No Plug
96010680	Unilift AP12.50.11.1	1 x 230	1 1/2	9.0	35	12.6	8.5	2.0 NPT	32.8	10 feet / No Plug
96010683	Unilift AP12.50.11.1	1 x 230	1 1/2	9.0	35	12.6	8.5	2.0 NPT	36.4	25 feet / No Plug
96847173	Unilift AP12.50.11A.1	1 x 230	1 1/2	9.0	35	12.6	8.5	2.0 NPT	32.8	10 feet / No Plug
96847172	Unilift AP12.50.11A.1	1 x 230	1 1/2	9.0	35	12.6	8.5	2.0 NPT	36.4	25 feet / No Plug

With float switch

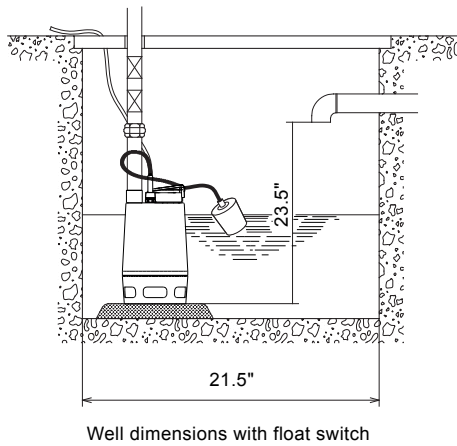

Fig. 13 Minimum well dimensions, Unilift AP12

If the pump is installed in a collecting well, the minimum dimensions of the well should be as shown above to ensure free movability of the float switch.

Without float switch

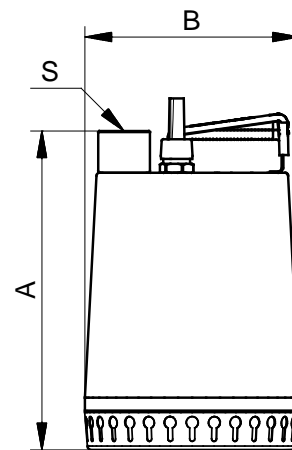

Fig. 14 Pump dimensions

The space required corresponds to the physical dimensions of the pump.

TTM04 3263 4009

TM00 5523 0995

Unilift AP35

Product description



Fig. 15 Unilift AP35

The Unilift AP35 pump is a single-stage, submersible pump designed for pumping drainage water and effluent. The pump is suitable for these applications:

- groundwater lowering
- pumping in drainage collecting tanks
- pumping in surface water collecting tanks with inflow from roof gutters, shafts, tunnels, etc.
- emptying of ponds, tanks, etc.
- pumping of fibre-containing wastewater from laundries and industries
- pumping of domestic wastewater without discharge from water closets.

Maximum particle size: 1.4"

Liquid temperature range: 32 °F to 131 °F.

Approvals



Operation

The pump can be used for automatic as well as manual operation and can be installed in a permanent installation or used as a portable pump.

To enable automatic operation the pump can be fitted with a float switch or it can be connected to separate level switch and control box for automatic on/off operation.

Pump sleeve and housing

The stainless steel pump sleeve is made in one piece and equipped with an insulated carrying handle.

The suction strainer is clipped on to the pump housing for easy removal in connection with maintenance. The strainer prevents the passage of large solids and ensures a slow flow into the pump.

The stainless steel pump housing is fitted with an internal riser pipe ensuring high efficiency. The riser pipe has a number of holes enabling efficient cooling of the motor during operation. The cable entry is of the socket and plug connection type, allowing for quick and easy dismantling.

Discharge port

All Unilift AP35 pumps have a threaded 1.5 NPT vertical discharge port.

Shaft and bearings

The stainless steel shaft rotates in maintenance-free prelubricated ball bearings.

Impeller

The stainless steel impeller is a vortex impeller with L-shaped blades and a clearance of 1.38" in the pump housing. The blades are curved backwards to reduce any harmful effect from solid particles and to minimise power consumption. The impeller has a protective cap to prevent the deposit of long-fibred material.

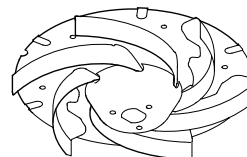

Fig. 16 Impeller, Unilift AP35

Shaft seal

The shaft seal is a combination of a mechanical, bellows shaft seal and a lip seal with 2 fl.oz. oil between. Seal faces are made of silicone carbide.

GR115

TM00 5478 0895

Motor cable

The motor is a single- or three-phase asynchronous dry-rotor motor.

Enclosure class: IP68

Insulation class: F (311 °F)

Cable typea: SJOW-A.

Single-phase motors have built-in thermal protection.

Adjustment of cable length for float switch

The difference in level between start and stop can be adjusted by changing the free cable length between the float switch and the pump handle.

- Increasing the free cable length will result in fewer starts/stops and a large difference in level.
- Reducing the free cable length will result in more frequent starts/stops and a small difference in level.

In order for the float switch to start and stop the pump, the free cable length must be min. 4". When adjusting the free cable end, make sure that the suction strainer is always covered by water.

Materials

Component	Materials	DIN W.-Nr.	AISI
Pump housing	Stainless steel	1.4301	304
Riser pipe	Stainless steel	1.4301	304
Impeller	Stainless steel	1.4301	304
Pump sleeve	Stainless steel	1.4401	316
Pump shaft - wet end	Stainless steel	1.4301	304
Bearings	Heavy-duty prelubricated ball bearings		
O-rings	NBR rubber		
Screws	Stainless steel	1.4301	304
Cables	Neoprene		
Oil	Shell Ondina 15, non-toxic		

Selection

The flow velocity through the discharge pipe must be minimum 2.3 ft/s to ensure self-cleaning.

Example: Schedule 40 PVC discharge pipe with an inner diameter of 1.61" requires a minimum flow velocity of approximately 15 gpm.

The overview below shows the maximum lengths of combined vertical and horizontal Schedule 40 PVC discharge pipes.

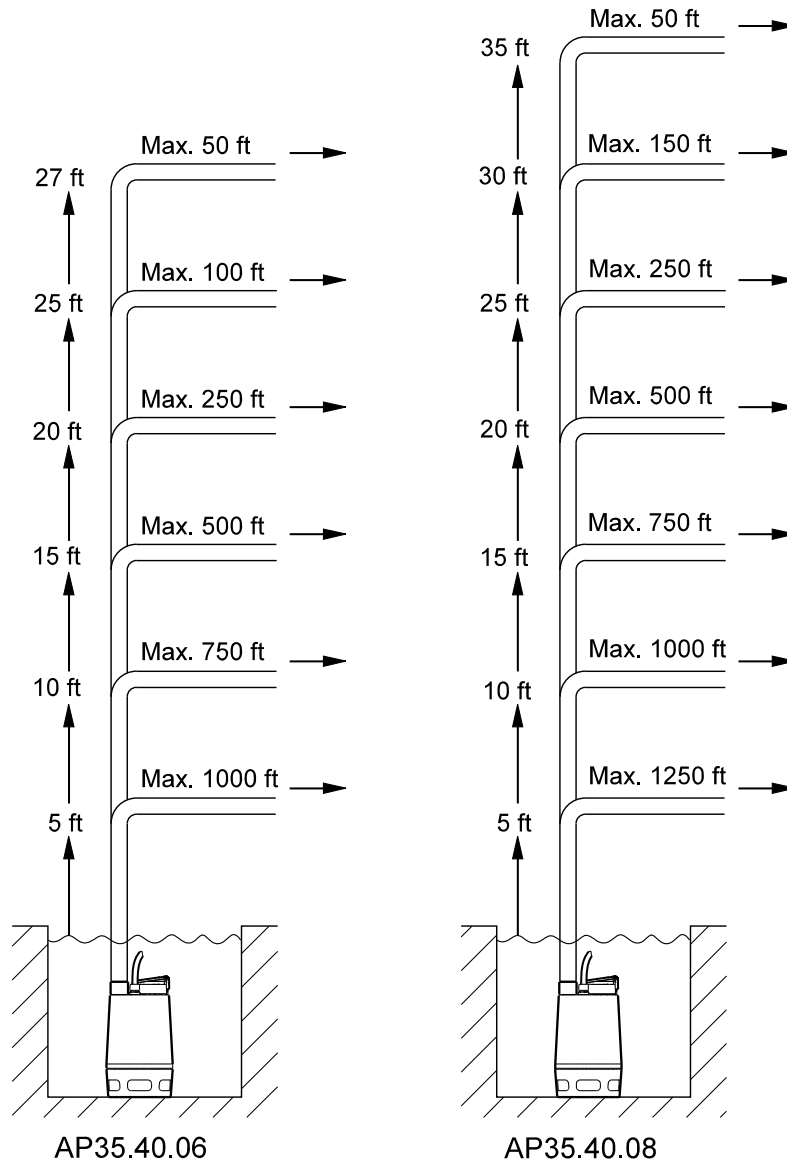

The overview is only intended as a guide. Grundfos is not liable for installations not complying with the overview.

Note: If a non-return valve is used, the pressure drop in the valve is approximately 0.6 ft head which must be subtracted from the vertical pipe lengths.

The vertical height of the discharge pipe should be measured from the pump stop level.

TM04 3036 3508

Performance curve

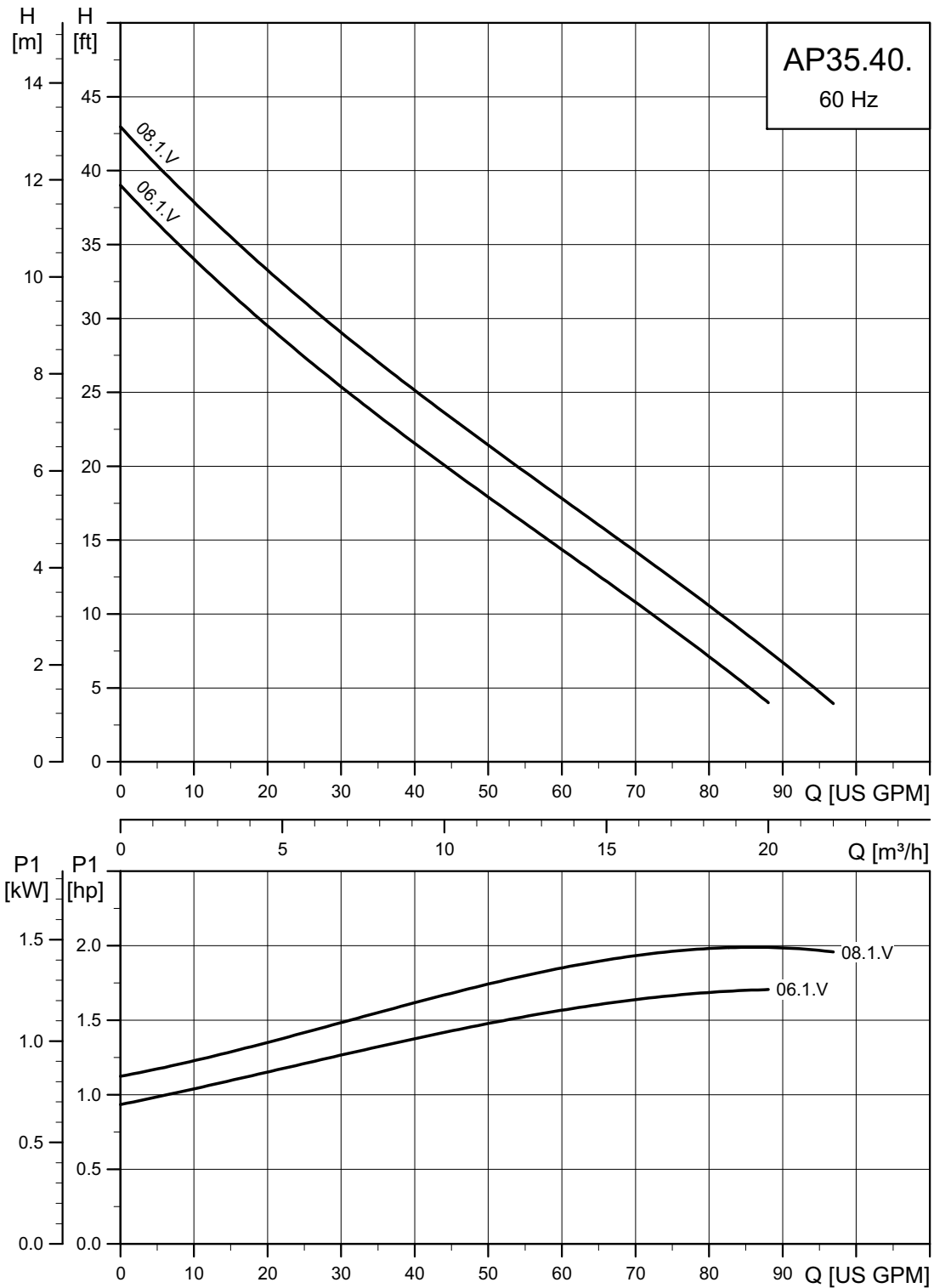

TM04 2999 0615

Technical data

Product no.	Pump type	Voltage [V]	P2 [hp]	I _n [A]	I _{Start} [A]	Dimensions [inches]			Weight [lbs]	Cable length and plug
						A	B	S		
96010668	AP35.40.06.1.V	1 x 230	3/4	3.9	21	14.8	8.5	1.5 NPT	26.7	10 feet / No Plug
96010670	AP35.40.06.1.V	1 x 230	3/4	3.9	21	14.8	8.5	1.5 NPT	26.7	25 feet / No Plug
96847176	AP35.40.06.A.1.V	1 x 230	3/4	3.9	21	14.8	8.5	1.5 NPT	26.7	10 feet / No Plug
96847175	AP35.40.06.A.1.V	1 x 230	3/4	3.9	21	14.8	8.5	1.5 NPT	26.7	25 feet / No Plug
96010674	AP35.40.08.1.V	1 x 230	1.0	5.3	29	16.14	8.5	1.5 NPT	28.0	10 feet / No Plug
96010676	AP35.40.08.1.V	1 x 230	1.0	5.3	29	16.14	8.5	1.5 NPT	28.0	25 feet / No Plug
96847178	AP35.40.08.A.1.V	1 x 230	1.0	5.3	29	16.14	8.5	1.5 NPT	28.0	10 feet / No Plug
96847179	AP35.40.08.A.1.V	1 x 230	1.0	5.3	29	16.14	8.5	1.5 NPT	28.0	25 feet / No Plug

With float switch

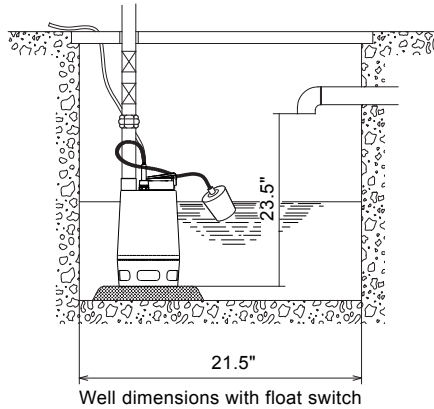

Fig. 17 Minimum well dimensions, Unilift AP35

If the pump is installed in a collecting well, the minimum dimensions of the well should be as shown above to ensure free movability of the float switch.

Without float switch

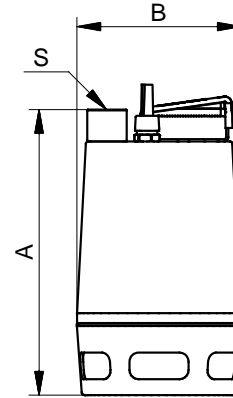

Fig. 18 Pump dimensions

The space required corresponds to the physical dimensions of the pump.

TM04 3263 4009

TM00 5524 0995

Unilift AP35B

Product description



TM03 8260 0907

Fig. 19 Unilift AP35B

The Unilift AP35B pump is a single-stage submersible pump designed for pumping effluent.

The pump is suitable for these applications:

- groundwater lowering
- pumping in drainage collecting tanks
- pumping in surface water collecting tanks with inflow from roof gutters, shafts, tunnels, etc.
- emptying of ponds, tanks, etc.
- pumping of fibre-containing effluent from laundries and industries
- pumping of domestic effluent from septic tanks and sludge treating systems
- pumping of domestic effluent without discharge from water closets.

Maximum particle size: 1.4"

Liquid temperature range: 32 °F to 104 °F.

Approvals



Operation

The pump can be used for automatic as well as manual operation and can be installed in a permanent installation or used as a portable pump.

To enable automatic operation the pump can be fitted with a float switch or it can be connected to separate level switch and control box for automatic on/off operation.

Pump housing

Pump housing with an outstanding design for submersible wastewater pumps, resulting in a high head.

The pump housing is made of a steel tube with a smooth surface and a hydraulically correct shape ensuring free passage of particles.

Ring stand, pump inlet and pump housing are fastened to the motor by means of four springs enabling quick and easy dismantling.

Discharge port

All Unilift AP35B pumps have a threaded 2" NPT horizontal discharge port.

Shaft and bearings

The stainless steel shaft rotates in maintenance-free prelubricated ball bearings.

Impeller

The stainless steel impeller is a vortex impeller with L-shaped blades and a clearance of 1.4" in the pump housing. The blades are curved backwards to reduce any harmful effect from solid particles and to minimize power consumption. The impeller has a protective cap to prevent the deposit of long-fibered material.

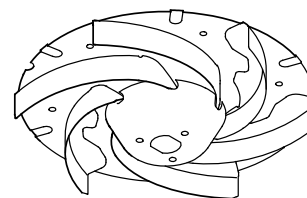

TM00 5478 0895

Fig. 20 Impeller, Unilift AP35B

Shaft seal

The shaft seal is a combination of a mechanical, bellows shaft seal and a lip seal with 2.7 fl.oz. oil between. Seal faces are made of silicone carbide.

Motor cable

The motor is a single- or three-phase asynchronous dry-rotor motor.

Enclosure class: IP68

Insulation class: F (311 °F)

Cable type: SJOW-A.

Single-phase motors have built-in thermal protection.

Adjustment of cable length for float switch

The difference in level between start and stop can be adjusted by changing the free cable length between the float switch and the pump handle.

- Increasing the free cable length will result in fewer starts/stops and a large difference in level.
- Reducing the free cable length will result in more frequent starts/stops and a small difference in level.

In order for the float switch to start and stop the pump, the free cable length must be min. 4". When adjusting the free cable end, make sure that the pump housing is always covered by water.

Intermittent operation

Pumps with float switch are suitable for intermittent operation.

The pump is allowed to run for maximum 5 minutes per 30 minutes without the motor being submerged in the liquid.

Continuous operation

During continuous operation, the pump must always be completely covered by the pumped liquid.

Materials

Component	Material	DIN W.-Nr.	AISI
Pump housing	Stainless steel	1.4301	304
Impeller	Stainless steel	1.4301	304
Washer	Stainless steel	1.4301	304
Protective cap	Novolen 2360 Kx		
Motor unit complete	Parts in contact with liquid: Stainless steel	1.4401	316
Pump shaft - wet end	Stainless steel	1.4301	304
Motor cable	Neoprene		
O-rings	NBR rubber		
Spring	Stainless steel	1.4310	
Pump inlet	Stainless steel	1.4301	304
Ring stand	Polycarbonate		
Oil	Shell Ondina 15, non-toxic		

Selection

The flow velocity through the discharge pipe must be minimum 2.3 ft/s to ensure self-cleaning.

Example: Schedule 40 PVC discharge pipe with an inner diameter of 2.067" requires a minimum flow velocity of approximately 24 gpm.

The overview below shows the maximum lengths of combined vertical and horizontal Schedule 40 PVC discharge pipes.

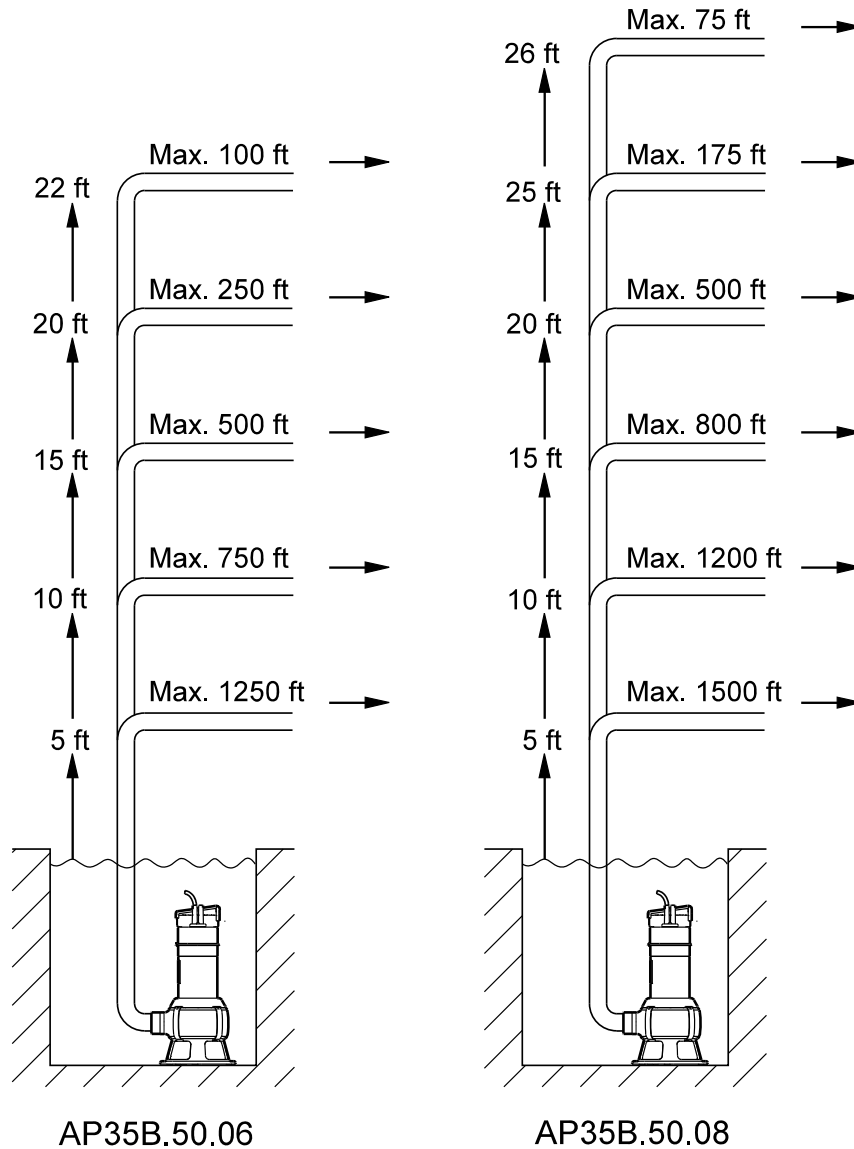

AP35B.50.06

AP35B.50.08

TM04 3038 3508

The overview is only intended as a guide. Grundfos is not liable for installations not complying with the overview.

Note: If a non-return valve is used, the pressure drop in the valve is approximately 0.6 ft head which must be subtracted from the vertical pipe lengths.

The vertical height of the discharge pipe should be measured from the pump stop level.

Performance curves

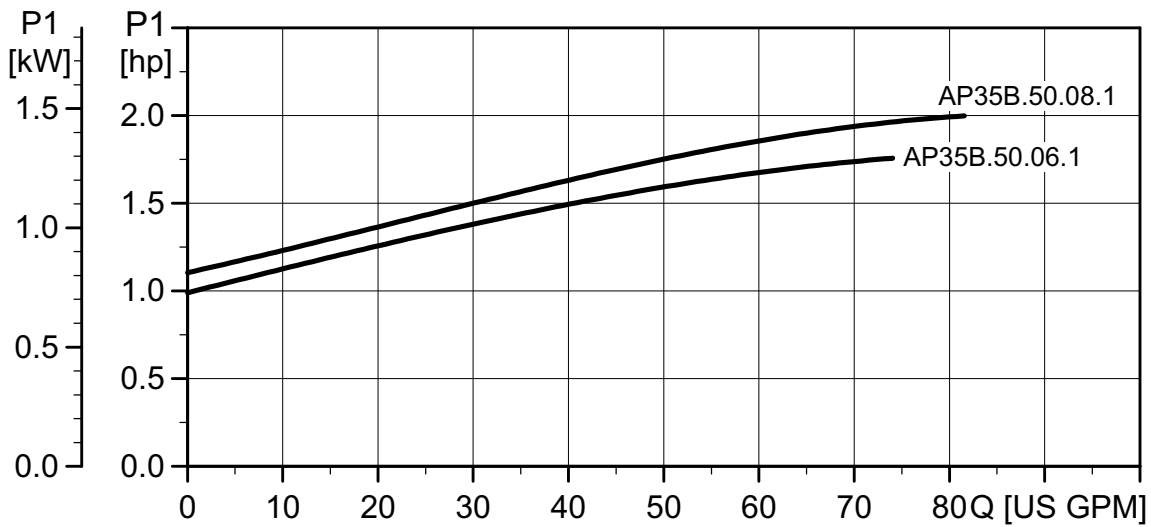
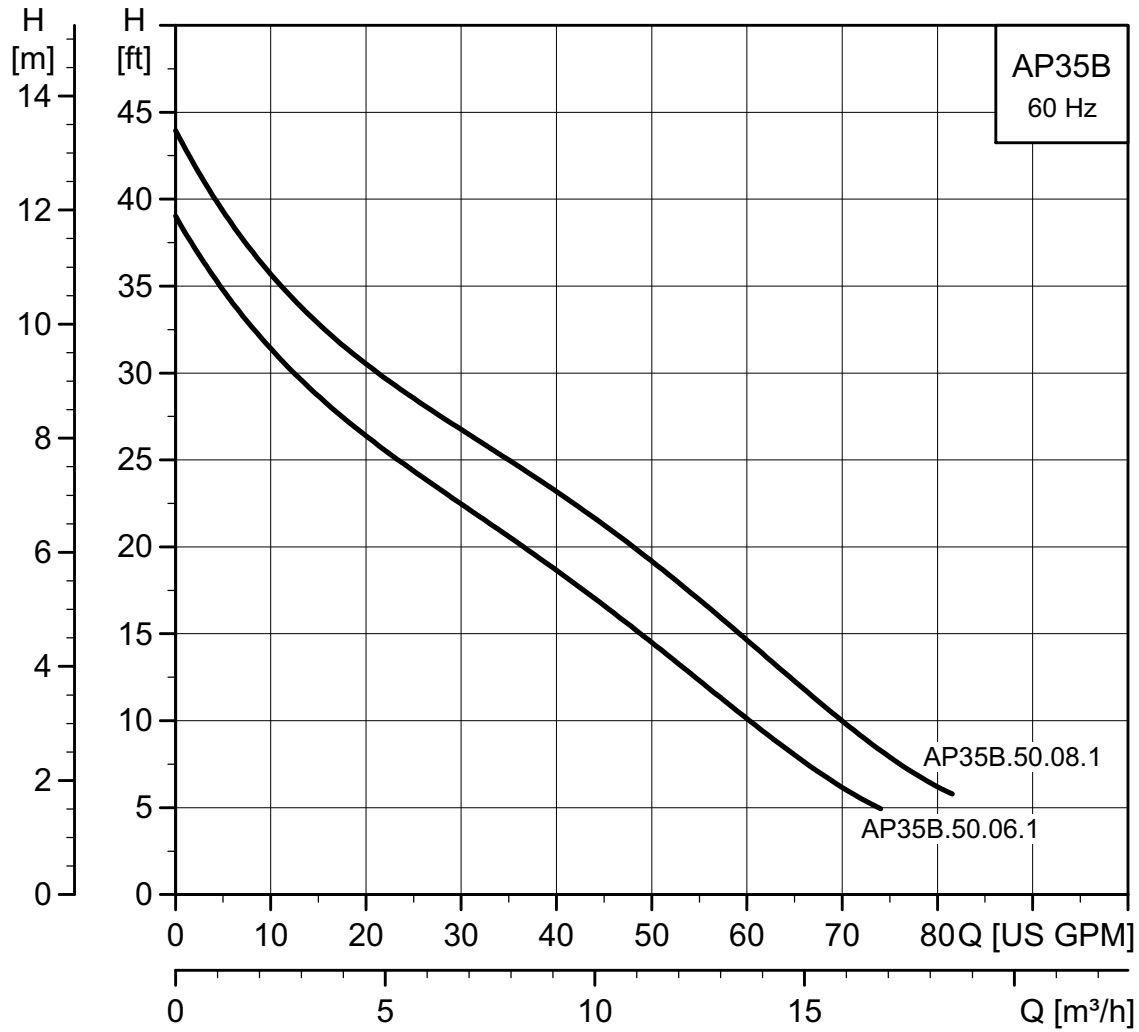

TM04 2996 0615

Technical data

Product no.	Pump type	Voltage [V]	P2 [hp]	I _n [A]	I _{Start} [A]	Dimensions [inches]						Weight [lbs]	Cable length and plug
						A	C	D	S	d1	d2		
96839867	AP35B.50.06.1V	1 x 230	3/4	5.71	18	17.44	4.57	2.87	2 npt	9.21	8.27	20.7	25 feet / No Plug
96839868	AP35B.50.06.1V	1 x 230	3/4	5.71	18	17.44	4.57	2.87	2 npt	9.21	8.27	21.7	10 feet / No Plug
96846954	AP35B.50.06.A1V	1 x 230	3/4	5.71	18	17.44	4.57	2.87	2 npt	9.21	8.27	20.7	25 feet / No Plug
96846957	AP35B.50.06.A1V	1 x 230	3/4	5.71	18	17.44	4.57	2.87	2 npt	9.21	8.27	21.7	10 feet / No Plug
96839947	AP35B.50.06.1V	1 x 115	3/4	**	**	**	**	**	**	**	**	**	25 feet / **
96839948	AP35B.50.06.1V	1 x 115	3/4	**	**	**	**	**	**	**	**	**	10 feet / **
96856959	AP35B.50.06.A1V	1 x 115	3/4	**	**	**	**	**	**	**	**	**	25 feet / **
96846960	AP35B.50.06.A1V	1 x 115	3/4	**	**	**	**	**	**	**	**	**	10 feet / **
96839950	AP35B.50.08.1V	1 x 230	1.0	6.74	24.2	18.43	4.57	2.87	2 npt	9.21	8.27	20.7	25 feet / No Plug
96839951	AP35B.50.08.1V	1 x 230	1.0	6.74	24.2	18.43	4.57	2.87	2 npt	9.21	8.27	21.7	10 feet / No Plug
96846962	AP35B.50.08.A1V	1 x 230	1.0	6.74	24.2	18.43	4.57	2.87	2 npt	9.21	8.27	20.7	25 feet / No Plug
96846963	AP35B.50.08.A1V	1 x 230	1.0	6.74	24.2	18.43	4.57	2.87	2 npt	9.21	8.27	21.7	10 feet / No Plug
96839972	AP35B.50.08.1V	1 x 115	1.0	**	**	**	**	**	**	**	**	**	25 feet / **
96839974	AP35B.50.08.1V	1 x 115	1.0	**	**	**	**	**	**	**	**	**	10 feet / **
96846964	AP35B.50.08.A1V	1 x 115	1.0	**	**	**	**	**	**	**	**	**	25 feet / **
96846965	AP35B.50.08.A1V	1 x 115	1.0	**	**	**	**	**	**	**	**	**	10 feet / **

Note: Contact Grundfos Partner Services for availability of 115 V models.

** Data not available at time of publication

With float switch

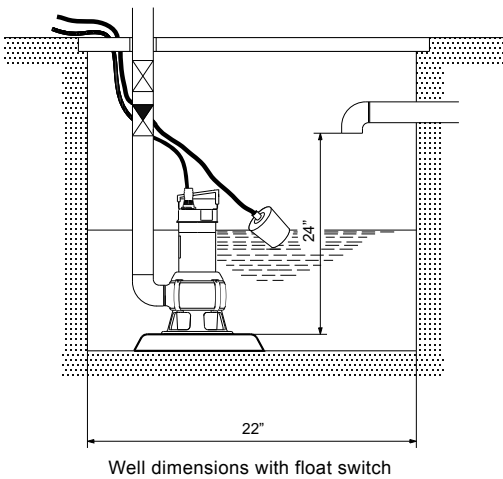

Fig. 21 Minimum well dimensions AP35B

If the pump is installed in a collecting well, the minimum dimensions of the well should be as shown above to ensure free movability of the float switch.

Without float switch

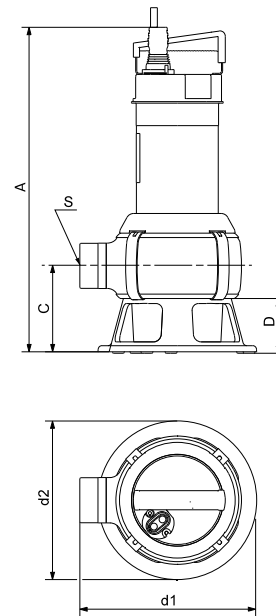

Fig. 22 Pump dimensions

The space required corresponds to the physical dimensions of the pump.

TM04 3182 3909

TM04 3046 3508

Unilift AP50

Product description



Fig. 23 Unilift AP50

The Unilift AP50 pump is a single-stage submersible pump designed for pumping effluent and sewage. The pump is suitable for these applications:

- groundwater lowering
- pumping in drainage collecting tanks
- pumping in surface water collecting tanks with inflow from roof gutters, shafts, tunnels, etc.
- emptying of ponds, tanks, etc.
- pumping of fibre-containing wastewater from laundries and industries
- pumping of domestic wastewater from septic tanks and sludge treating systems
- pumping of domestic wastewater with/without discharge from water closets.

Maximum particle size: 2.0".

Liquid temperature range: 32 °F to 131 °F.

Approvals



Operation

The pump can be used for automatic as well as manual operation and can be installed in a permanent installation or used as a portable pump.

To enable automatic operation the pump can be fitted with a float switch or it can be connected to an separate level switch and control box for automatic on/off operation.

Pump sleeve and housing

The stainless steel pump sleeve is made in one piece and equipped with an insulated carrying handle.

The suction strainer is clipped on to the pump housing and can easily be removed for maintenance. The strainer prevents the passage of large solids and ensures a slow flow into the pump.

The stainless steel pump housing is fitted with an internal riser pipe ensuring high efficiency. The riser pipe has a number of holes enabling efficient cooling of the motor during operation. The cable entry is of the socket and plug connection type, allowing for quick and easy dismantling.

Discharge port

All Unilift AP50 pumps have a threaded 2" NPT vertical discharge port.

Shaft and bearings

The stainless steel shaft rotates in maintenance-free prelubricated ball bearings.

Impeller

The stainless steel impeller is a vortex impeller with L-shaped blades and a clearance of 2.0" in the pump housing. The blades are curved backwards to reduce any harmful effect from solid particles and to minimise power consumption. The impeller has a protective cap to prevent the deposit of long-fibred material.

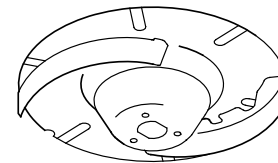

Fig. 24 Impeller, Unilift AP50

Shaft seal

The shaft seal is a combination of a mechanical, bellows shaft seal and a lip seal with 2 fl.oz. oil between. Seal faces are made of silicone carbide.

GR117

TM00 5477 0895

Motor

The motor is a single- or three-phase asynchronous dry-rotor motor.

Enclosure class: IP68

Insulation class: F (311 °F)

Cable type: SJOW-A.

Single-phase motors have built-in thermal protection.

Adjustment of cable length for float switch

The difference in level between start and stop can be adjusted by changing the free cable length between the float switch and the pump handle.

- Increasing the free cable length will result in fewer starts/stops and a large difference in level.
- Reducing the free cable length will result in more frequent starts/stops and a small difference in level.

In order for the float switch to start and stop the pump, the free cable length must be min. 4". When adjusting the free cable end, make sure that the suction strainer is always covered by water.

Materials

Component	Material	DIN W.-Nr.	AISI
Pump housing	Stainless steel	1.4301	304
Riser pipe	Stainless steel	1.4301	304
Impeller	Stainless steel	1.4301	304
Pump sleeve	Stainless steel	1.4401	316
Pump shaft - wet end	Stainless steel	1.4301	304
Bearings	Heavy-duty prelubricated ball bearings		
O-rings	NBR rubber		
Screws	Stainless steel	1.4301	304
Cables	Neoprene		
Oil	Shell Ondina 15, non-toxic		

Selection

The flow velocity through the discharge pipe must be minimum 2.3 ft/s to ensure self-cleaning.

Example: Schedule 40 PVC discharge pipe with an inner diameter of 2.067" requires a minimum flow velocity of approximately 24 gpm.

The overview below shows the maximum lengths of combined vertical and horizontal Schedule 40 PVC discharge pipes.

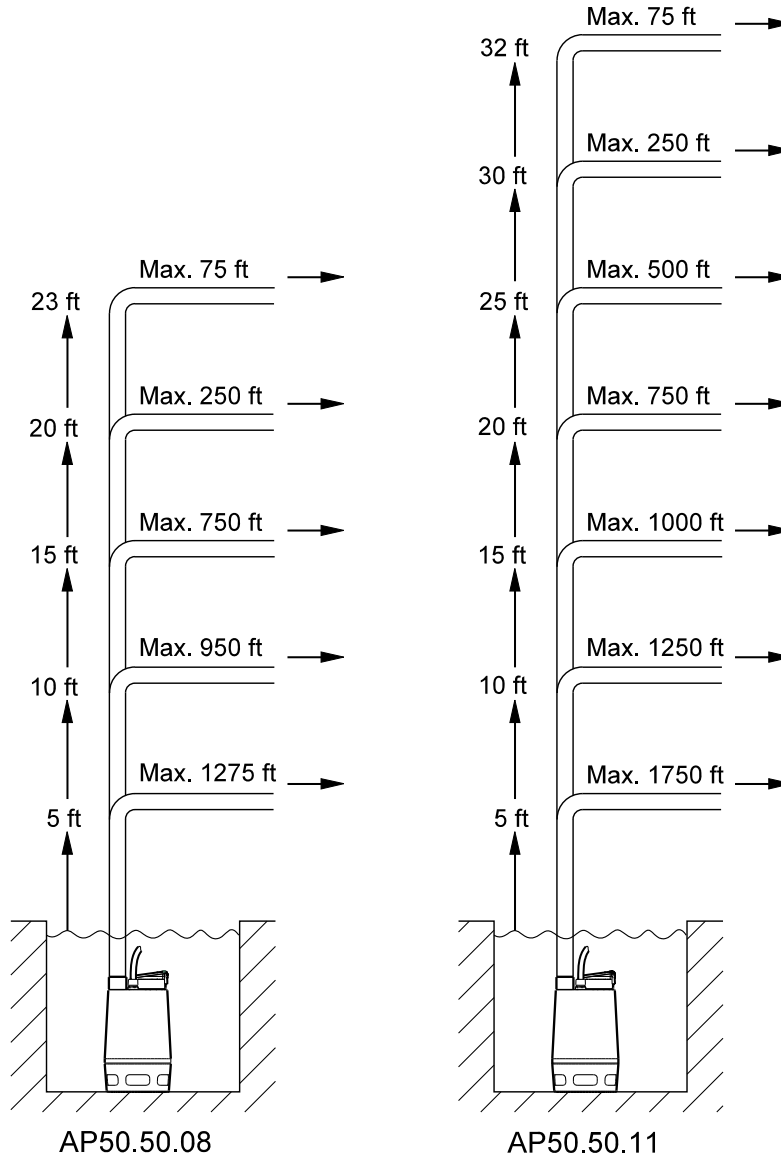

AP50.50.08

AP50.50.11

The overview is only intended as a guide. Grundfos is not liable for installations not complying with the overview.

Note: If a non-return valve is used, the pressure drop in the valve is approximately 0.6 ft head which must be subtracted from the vertical pipe lengths.

The vertical height of the discharge pipe should be measured from the pump stop level.

TM04 3037 3508

Performance curve

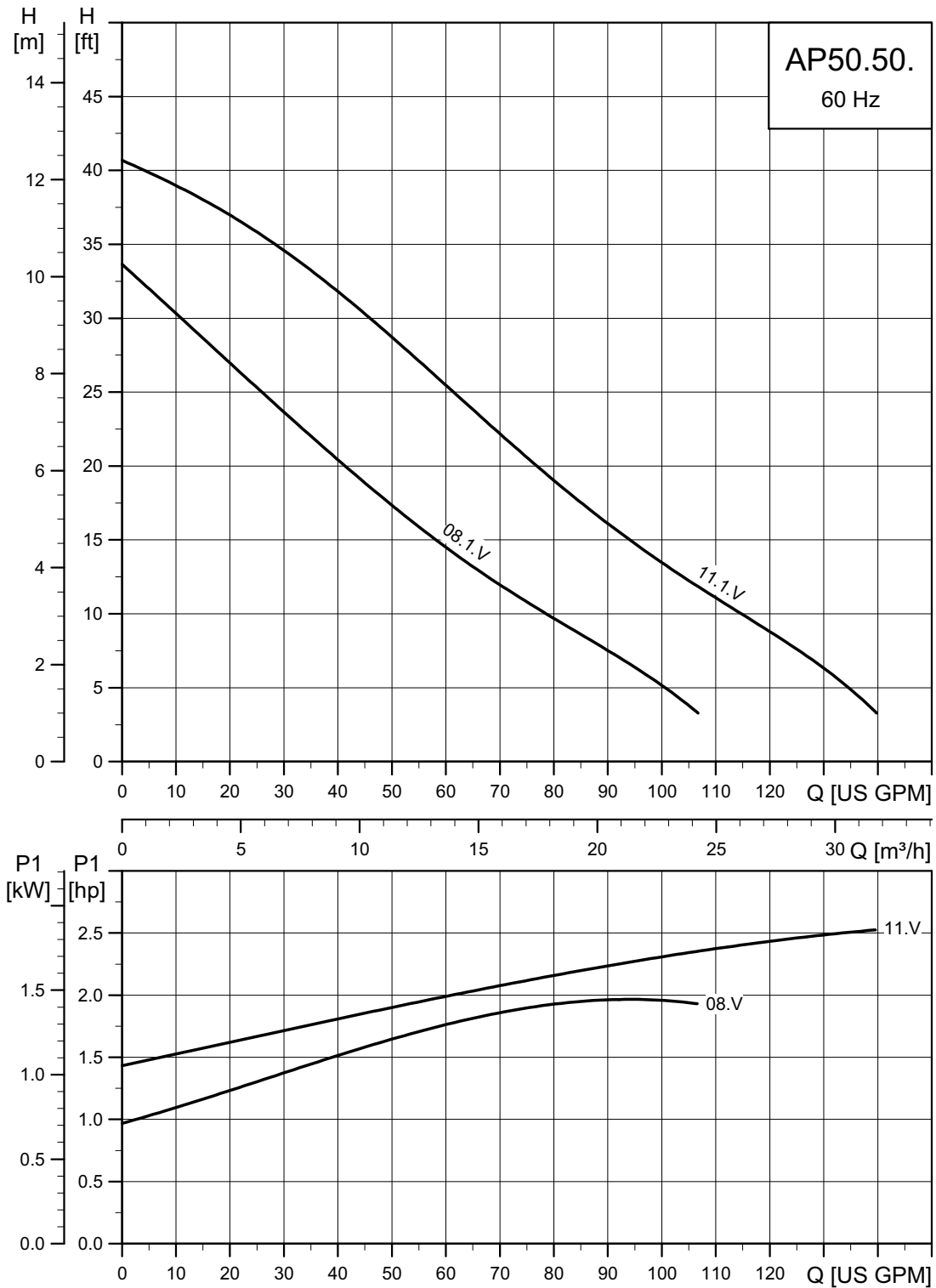

TM04 2997 0615

Technical data

Product no.	Pump type	Voltage [V]	P2 [hp]	I _n [A]	I _{Start} [A]	Dimensions [inches]			Weight [lbs]	Cable length and plug
						A	B	S		
96010686	AP50.50.08..1.V	1 x 230	1.0	6.3	29	17.17	9.49	2 NPT	35.3	10 feet / No Plug
96010689	AP50.50.08.1.V	1 x 230	1.0	6.3	29	17.17	9.49	2 NPT	35.3	25 feet / No Plug
96847180	AP50.50.08.A.1.V	1 x 230	1.0	6.3	29	17.17	9.49	2 NPT	35.3	10 feet / No Plug
96847181	AP50.50.08.A.1.V	1 x 230	1.0	6.3	29	17.17	9.49	2 NPT	37.3	25 feet / No Plug
96010692	AP50.50.11.1.V	1 x 230	1 1/2	8.4	35	17.17	9.49	2 NPT	35.3	10 feet / No Plug
96010695	AP50.50.11.1.V	1 x 230	1 1/2	8.4	35	17.17	9.49	2 NPT	35.3	25 feet / No Plug
96847182	AP50.50.11.A.1.V	1 x 230	1 1/2	8.4	35	17.17	9.49	2 NPT	37.0	10 feet / No Plug
96847183	AP50.50.11.A.1.V	1 x 230	1 1/2	8.4	35	17.17	9.49	2 NPT	37.3	25 feet / No Plug

With float switch

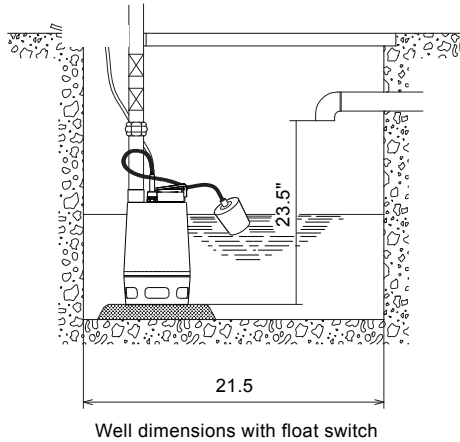

Fig. 25 Minimum well dimensions AP50

If the pump is installed in a collecting well, the minimum dimensions of the well should be as shown above to ensure free movability of the float switch.

Without float switch

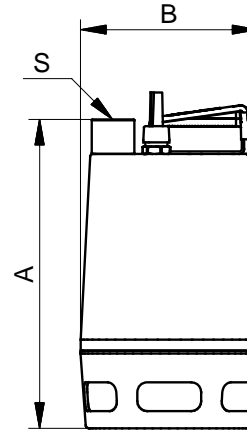

Fig. 26 Pump dimensions

The space required corresponds to the physical dimensions of the pump.

Unilift AP50B

Product description



Fig. 27 Unilift AP50B

The Unilift AP50B pump is a single-stage submersible pump designed for pumping effluent.

The pump is suitable for these applications:

- groundwater lowering
- pumping in drainage collecting tanks
- pumping in surface water collecting tanks with inflow from roof gutters, shafts, tunnels, etc.
- emptying of ponds, tanks, etc.
- pumping of fibre-containing effluent from laundries and industries
- pumping of domestic effluent from septic tanks and sludge treating systems
- pumping of domestic effluent without discharge from water closets.

Maximum particle size: 2.0".

Liquid temperature range: 32 °F to 104 °F.

Approvals



Operation

The pump can be used for automatic as well as manual operation and can be installed in a permanent installation or used as a portable pump.

To enable automatic operation the pump can be fitted with a float switch or it can be connected to separate level switch and control box for automatic on/off operation.

Pump housing

Pump housing with an outstanding design for submersible wastewater pumps resulting in a high head.

The pump housing is made of a steel tube with a smooth surface and a hydraulically correct shape ensuring free passage of particles.

Base, pump inlet and pump housing are fastened to the motor by means of four springs enabling quick and easy dismantling.

Discharge port

All Unilift AP50B pumps have a threaded 2" NPT horizontal discharge port.

Shaft and bearings

The stainless steel shaft rotates in maintenance-free prelubricated ball bearings.

Impeller

The stainless steel impeller is a vortex impeller with L-shaped blades and a clearance of 2.0" in the pump housing. The blades are curved backwards to reduce any harmful effect from solid particles and to minimize power consumption. The impeller has a protective cap to prevent the deposit of long-fibered material.

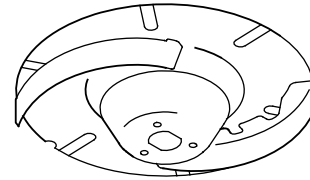

Fig. 28 Impeller, Unilift AP50B

Shaft seal

The shaft seal is a combination of a mechanical, bellows shaft seal and a lip seal with 2.7 fl.oz. oil between. Seal faces are made of silicone carbide.

TM03 8260 0907

TM00 5477 0895

Motor

The motor is a single- or three-phase asynchronous dry-rotor motor.

Enclosure class: IP68

Insulation class: F (311 °F)

Cable type: SJOW-A.

Single-phase motors have built-in thermal protection.

Adjustment of cable length for float switch

The difference in level between start and stop can be adjusted by changing the free cable length between the float switch and the pump handle.

- Increasing the free cable length will result in fewer starts/stops and a large difference in level.
- Reducing the free cable length will result in more frequent starts/stops and a small difference in level.

In order for the float switch to start and stop the pump, the free cable length must be min. 4". When adjusting the free cable end, make sure that the pump housing is always covered by water.

Intermittent operation

Pumps with float switch are suitable for intermittent operation.

The pump is allowed to run for maximum 5 minutes per 30 minutes without the motor being submerged in the liquid.

Continuous operation

During continuous operation, the pump must always be completely covered by the pumped liquid.

Materials

Component	Materials	DIN W.-Nr.	AISI
Pump housing	Stainless steel	1.4301	304
Impeller	Stainless steel	1.4301	304
Washer	Stainless steel	1.4301	304
Protective cap	Novolen 2360 Kx		
Motor unit complete	Parts in contact with liquid: Stainless steel	1.4401	316
Pump shaft	Stainless steel	1.4301	304
Motor cable	Neoprene		
O-rings	NBR rubber		
Spring	Stainless steel	1.4310	
Pump inlet	Stainless steel	1.4301	304
Ring stand	Polycarbonate		
Oil	Shell Ondina 15, non-toxic		

Selection

The flow velocity through the discharge pipe must be minimum 2.3 ft/s to ensure self-cleaning.

Example: Schedule 40 PVC discharge pipe with an inner diameter of 2.067" requires a minimum flow velocity of approximately 24 gpm.

The overview below shows the maximum lengths of combined vertical and horizontal Schedule 40 PVC discharge pipes.

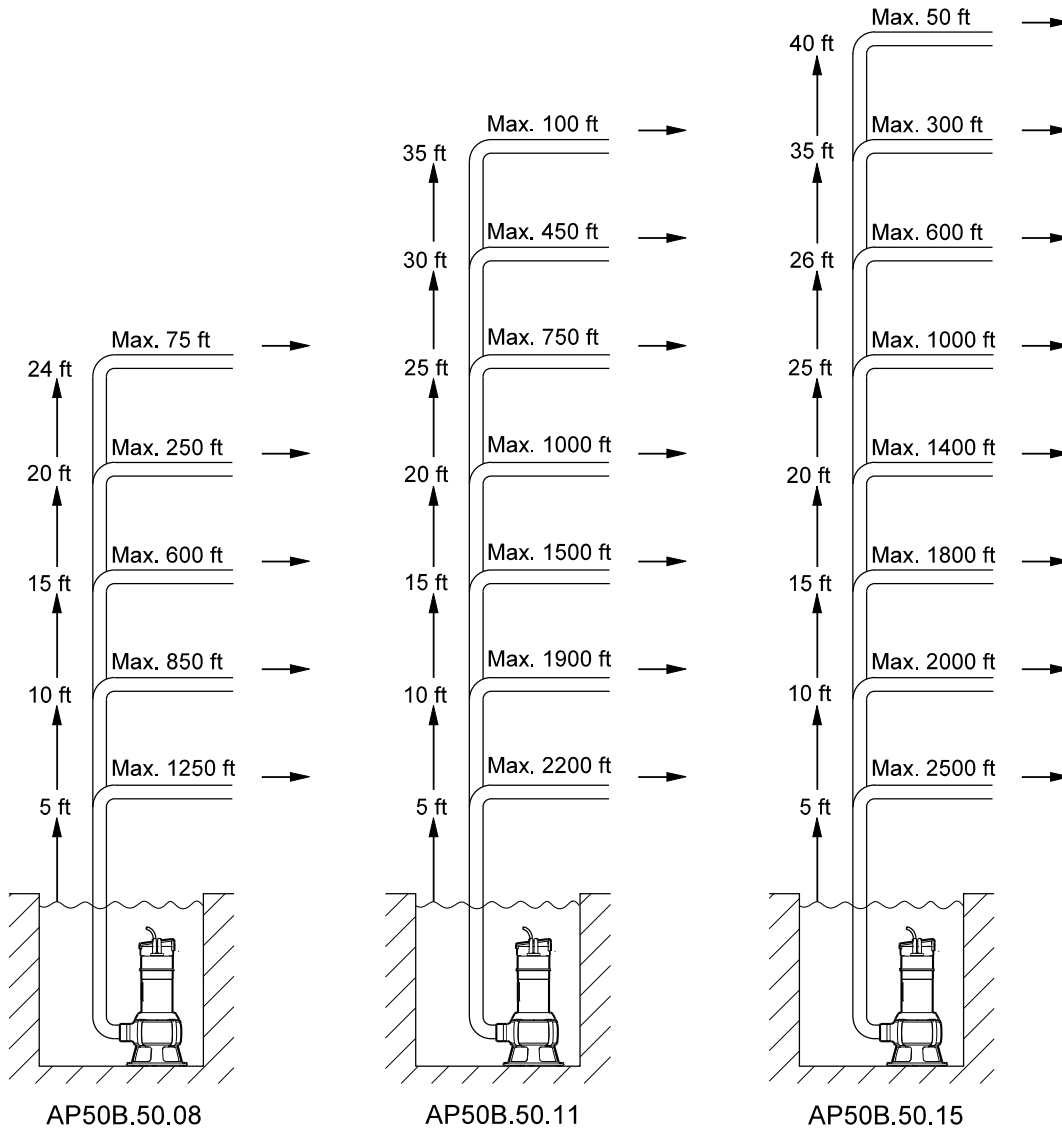

TM04 3039 3508

The overview is only intended as a guide. Grundfos is not liable for installations not complying with the overview.

Note: If a non-return valve is used, the pressure drop in the valve is approximately 0.6 ft head which must be subtracted from the vertical pipe lengths.

The vertical height of the discharge pipe should be measured from the pump stop level.

Performance curves

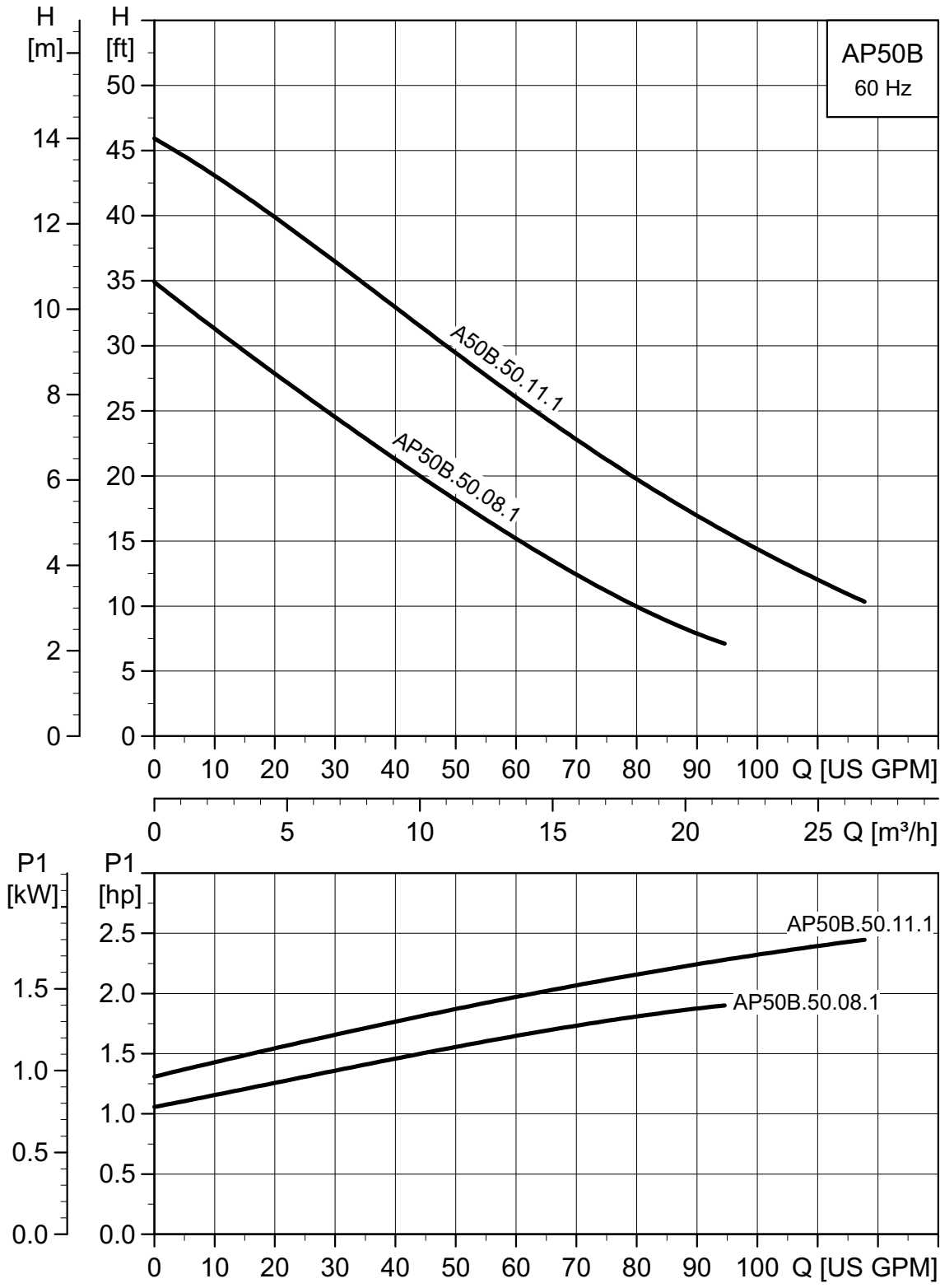

TM04 3690 0615

Technical data

Product no.	Pump type	Voltage [V]	P2 [hp]	I _n [A]	I _{Start} [A]	Dimensions [inches]						Weight [lbs]	Cable length and plug
						A	C	D	S	d1	d2		
96839975	AP50B.50.08.1V	1 x 230	1.0	6.4	24.2	18.43	4.57	2.87	2 NPT	9.21	8.27	24.2	25 feet / No Plug
96839978	AP50B.50.08.1V	1 x 230	1.0	6.4	24.2	18.43	4.57	2.87	2 NPT	9.21	8.27	25.2	10 feet / No Plug
96846966	AP50B.50.08.A1V	1 x 230	1.0	6.4	24.2	18.43	4.57	2.87	2 NPT	9.21	8.27	24.2	25 feet / No Plug
96846967	AP50B.50.08.A1V	1 x 230	1.0	6.4	24.2	18.43	4.57	2.87	2 NPT	9.21	8.27	25.2	10 feet / No Plug
96839982	AP50B.50.08.1V	1 x 115	1.0	**	**	**	**	**	**	**	**	**	25 feet / **
96839983	AP50B.50.08.1V	1 x 115	1.0	**	**	**	**	**	**	**	**	**	10 feet / **
96846968	AP50B.50.08.A1V	1 x 115	1.0	**	**	**	**	**	**	**	**	**	25 feet / **
96846970	AP50B.50.08.A1V	1 x 115	1.0	**	**	**	**	**	**	**	**	**	10 feet / **
96839985	AP50B.50.11.1V	1 x 230	1 1/2	8.42	30	18.43	4.57	2.87	2 NPT	9.21	8.27	24.2	25 feet / No Plug
96839987	AP50B.50.11.1V	1 x 230	1 1/2	8.42	30	18.43	4.57	2.87	2 NPT	9.21	8.27	25.2	10 feet / No Plug
96846971	AP50B.50.11.A1V	1 x 230	1 1/2	8.42	30	18.43	4.57	2.87	2 NPT	9.21	8.27	24.2	25 feet / No Plug
96846972	AP50B.50.11.A1V	1 x 230	1 1/2	8.42	30	18.43	4.57	2.87	2 NPT	9.21	8.27	25.2	10 feet / No Plug

Note: Contact Grundfos Partner Services for availability of 115 V models.

** Data not available at time of publication

With float switch

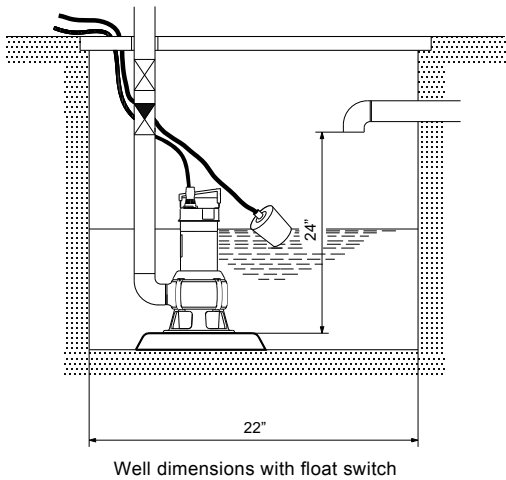

Fig. 29 Minimum well dimensions AP50B

If the pump is installed in a collecting well, the minimum dimensions of the well should be as shown above to ensure free movability of the float switch.

Without float switch

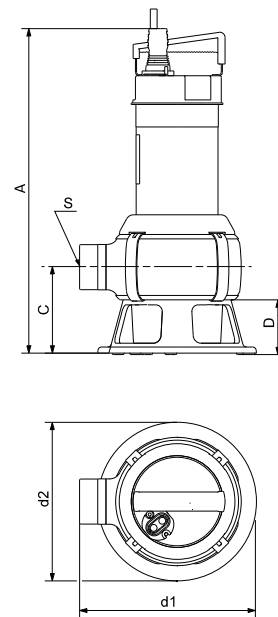

Fig. 30 Pump dimensions

The space required corresponds to the physical dimensions of the pump.

TM04 3182 3909

TM04 3046 3508

Duolift System

Product description

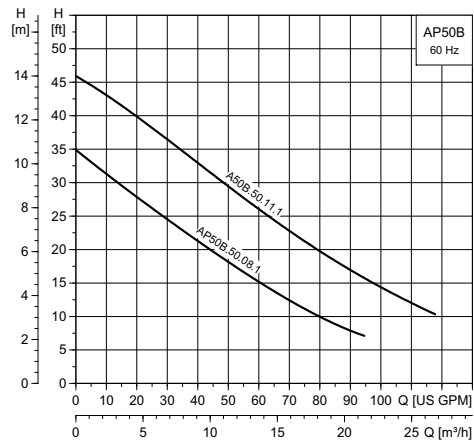

Fig. 31 Duolift System

Grundfos Duolift Systems are suitable for the collection and pumping of wastewater below sewer level from cellars/basements of private homes (shower, bath, washing machine, and toilets), hospitals, industries, hotels, restaurants, etc.)

Duolift Systems are supplied with two Grundfos AP 50B pumps. For further information about AP 50B pumps, see *Unilift AP50B* on page 35.

Performance curve



TM04 6435 1010

TM04 3690 4808

Technical data

Product number	Pump type	Hp	Ph	Voltage [V]	Run	Start	Cable	Cover
96966621	AP50B.50.08	1	1	115	-	-	25 ft	One piece
96966622	AP50B.50.08	1	1	230	6.4	29	25 ft	One piece
96966623	AP50B.50.11	1 1/2	1	230	8.4	35	25 ft	One piece

Basin

Dimensions [in]	Operating capacity [gal]	Inlet [in]	Discharge [in]	Vent [in]	Solids [in]	Panel type	Approx. shipping weight [lbs]
30 x 36	63	4	2	2	2	Duplex	120

Notes:

- Duolift systems are not designed for traffic loads.
- Contact Grundfos Partner Services for availability of 115 V Duolift.

Dimensions drawings

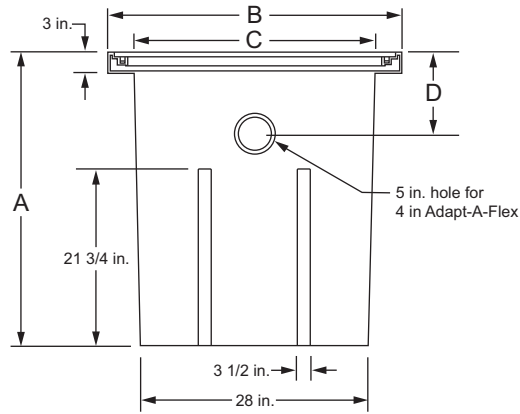

Fig. 32 Doulift dimensions

A	B	C	D
[in]			
36.3	36	30	10

Components and materials

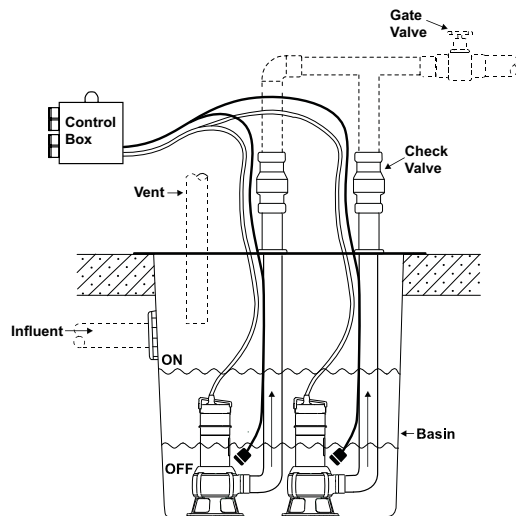

Fig. 33 Doulift components

Description	Duo
Basin	Polyethylene
Lid	Fiberglass
Inlet hub	Neoprene
Elbow	PVC
Discharge pipe	PVC
Swing Check Valve	PVC
Control Panel	Quantity 2
SJE Rhombus	Model 122
Pumps	Grundfos AP50B Quantity 2

Unilift Systems

Product description

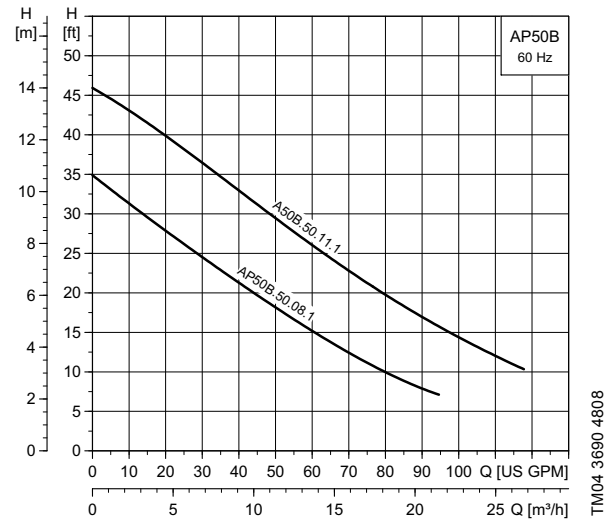

Fig. 34 Unilift Systems

Grundfos Unilift Systems are suitable for the collection and pumping of wastewater below sewer level from cellars/basements of private homes (shower, bath, washing machine, and toilets), hospitals, industries, hotels, restaurants, etc.)

Unilift Systems are supplied with one Grundfos AP 50B pump. For further information about AP 50B pumps, see *Unilift AP50B* on page 35.

Performance curve



TM04 3690 4808

Technical data

Product number	Pump type	Hp	Ph	Voltage [V]	Run	Start	Cable	Cover
96966599	AP50B.50.08	1	1	115	**	**	10	One piece
96966612	AP50B.50.08	1	1	115	**	**	25	One piece
96966614	AP50B.50.08	1	1	230	6.4	29	10	One piece
96966616	AP50B.50.11	1 1/2	1	230	8.4	35	10	One piece
96966617	AP50B.50.08	1	1	230	6.4	29	25	One piece
96966618	AP50B.50.11	1 1/2	1	230	8.4	35	25	One piece
96966619	AP50B.50.08	1	1	115	**	**	10	Split
96966620	AP50B.50.08	1	1	230	6.4	29	10	Split

Basin

Dimensions [in]	Operating capacity [gal]	Inlet [in]	Discharge [in]	Vent [in]	Solids [in]	Panel type	Approx. ship. weight [lbs]
18 x 30	22	4	2	2	2	Simplex	60

Notes:

- Unilift systems are not designed for traffic loads.
- Contact Grundfos Partner Services for availability of 115 V Unilift.

** Data not available at time of publication.

Dimensional drawings

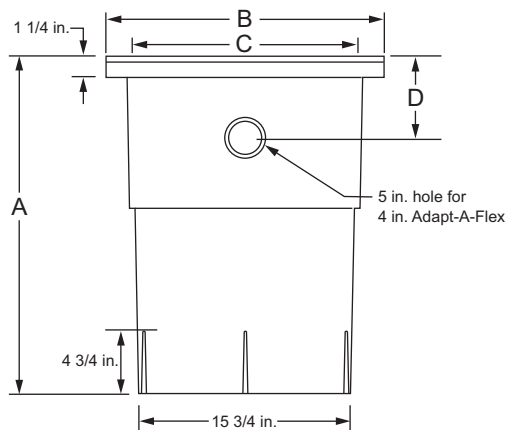

Fig. 35 Unolift dimensions

A	B	C	D
[in]			
30	21	18	8

Components and materials

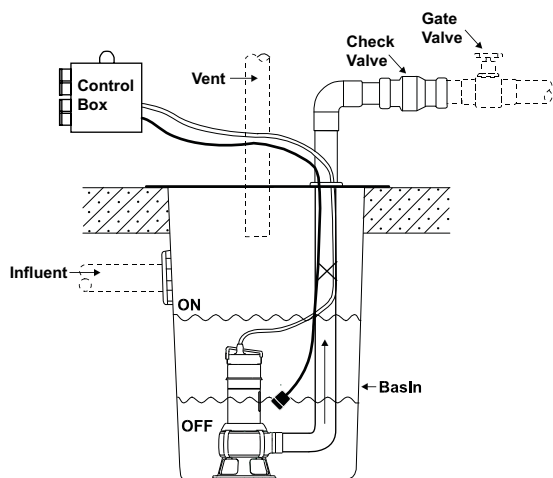

Fig. 36 Unolift components

Description	Uno
Basin	Polyethylene
Lid	Fiberglass
Inlet hub	Neoprene
Elbow	PVC
Discharge pipe	PVC
Swing Check Valve	PVC
Control Panel SJE Rhombus	Model 115
Pump	Grundfos AP50B

EF25

Product description



Fig. 37 EF25 pump

Technical data

Performance Range:

- Flow range: 1-28 GPM
- Head: 0-17 ft.

Solids Handling:

- 0.5" spherical solids.

Motor:

- AC induction
 - Oil filled
 - Insulation class: C
 - Automatic thermal reset
- If motor is cut out by the thermal protection, it will cut in again after cooling off.

Operation:

Semi-continuous operation

- If fully submerged: Max. 8 hours in a 24 hour period.

Intermittent operation

- Max. 20 starts per hour - evenly distributed once every 3 minutes.

Liquid temperature limits when fully submerged:

- 40 °F (4.4 °C)
- 120 °F (48.9 °C).

Discharge port:

- 1.25" female NPT and 0.75" adjustable hose fitting (included).

Performance curve

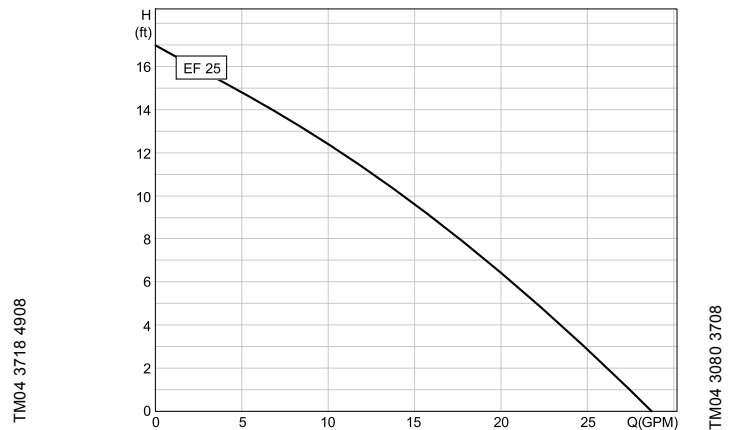

Impeller:

- Vortex.

Installation depth:

- Max. 30 ft below water level.

Approvals:

- CSA-approved
- UL-listed.

Power Cable:

- 8 ft.

Electrical data

Product number	Pump type	Cable length [ft]	Float switch	hp	Service factor	pH	Input voltage [V]	Max. power consumption [W]	Max. current [A]	Locked-rotor current [A]	Rated speed [rpm]
96001478	EF25	8	No	0.25	1.0	1	115	530	6.2	6.84	3000

Dimensional drawing

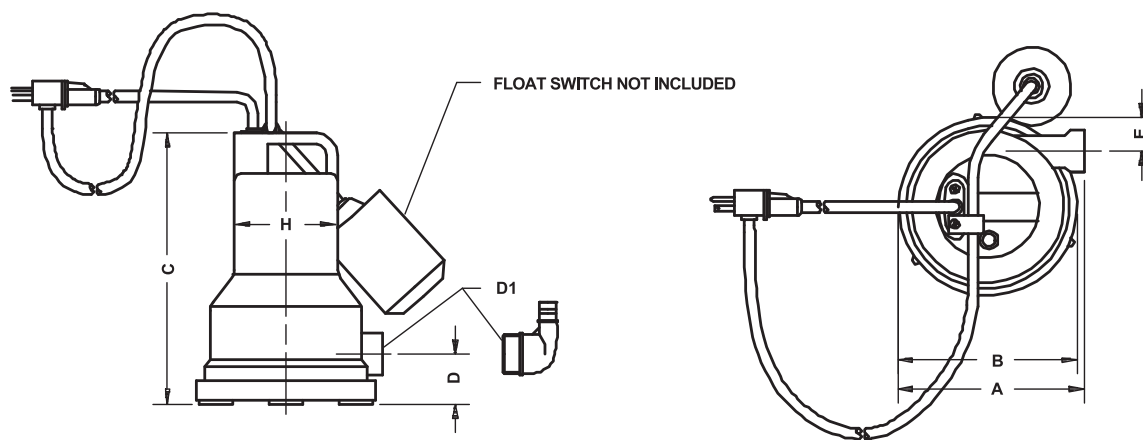

Fig. 38 Dimensional drawings

Dimensions and weight

Pump type	D1 discharge port [inches]	Dimensions [inches]						Shipping weight [lbs]	Shipping volume [cu ft]
		A	B	C	D	E	H		
EF25	1.25 NPT	6.5	6.25	9.5	1.75	1.75	3.625	7	0.26

Materials

Description	Material
Motor housing	Glass-reinforced thermoplastics
Volute	Glass-reinforced thermoplastics
Impeller	Glass-reinforced thermoplastics
Shaft	AISI 416 SS
Lip seal and O-rings	Buna N
Power cable	Neoprene (3-prong)
Interior of motor	Oil filled - Polyalphaolefin

SU25

Product description



Fig. 39 SU25 pump

Technical data

Performance Range:

- Flow range: 1-36 GPM
- Head: 0-16 ft.

Solids handling:

- 0.2" spherical solids

Motor:

- AC induction
- Oil filled
- insulation Class: C.

Operation:

Semi-continuous operation

- If fully submerged: Max. 8 hours in a 24 hour period.

Intermittent operation

- Max. 20 starts per hour - evenly distributed once every 3 minutes.

Thermal protection

- Automatic reset
If motor is cut out by the thermal protection, it will cut in again after cooling off.

Liquid temperature limits when fully submerged:

- Minimum: 40 °F (4.4 °C)
- Maximum: 120 °F (48.9 °C).

Performance curve

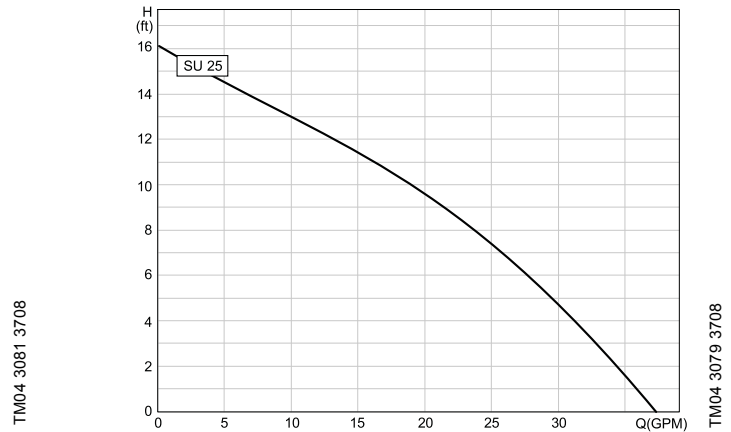

Discharge port:

- 1.5" female NPT.

Impeller:

- Semi-Open.

Installation depth:

- Max. 30 ft below water level.

Approvals:

- CSA-approved
- UL-listed.

Start level:

- 14".

Stop level:

- 7".

Minimum internal diameter of basin:

- 13".

Electrical data

Product number	Pump type	Cable length [ft]	Float switch	hp	Service factor	pH	Input voltage [V]	Max. power consumption [W]	Max. current [A]	Locked-rotor current [A]	Rated speed [rpm]
96001566	SU25	8	Yes	0.25	1.0	1	115	460	5.6	6.84	3000

Dimensional drawing

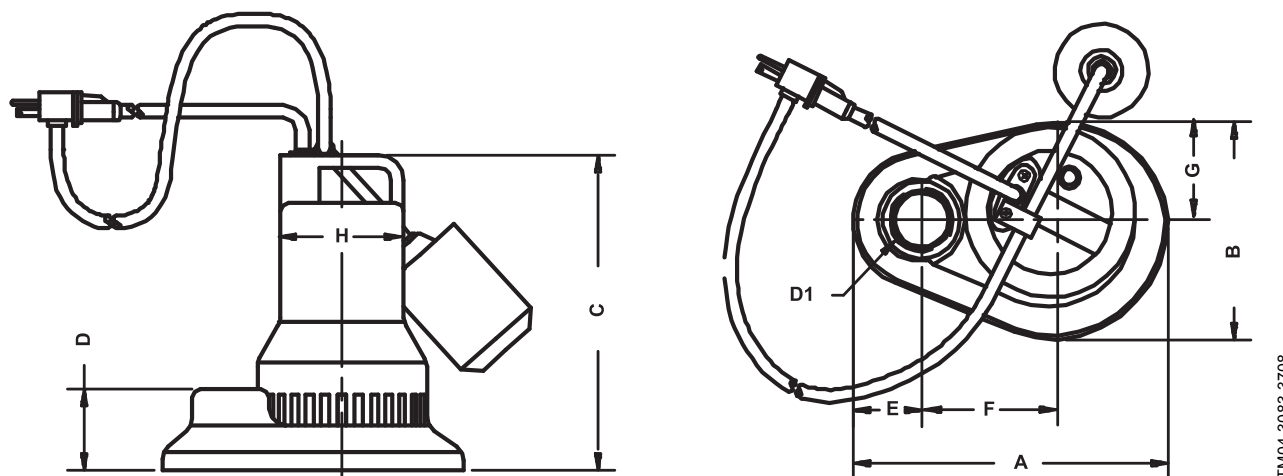

Fig. 40 Dimensional drawing

Dimensions and weight

Pump type	Motor data				D1 discharge port [inches]	Dimensions [inches]								Shipping weight [lbs]	Shipping volume [cu ft]
	hp	SF	pH	Volt		A	B	C	D	E	F	G	H		
SU25	0.25	1.0	1	115	1.5 NPT	9.25	6.375	9.25	2.375	2	4	2.875	3.625	7.1	0.52

Materials

Description	Material
Motor housing	Glass-reinforced thermoplastics
Volute	Glass-reinforced thermoplastics
Impeller	Glass-reinforced thermoplastics
Shaft	AISI 416 SS
Lip seal and O-rings	Buna N
Power cable	Neoprene, 3-prong, 8 ft
Interior of motor	Oil filled - Polyalphaolefin

4. Control panels

Model 112, simplex

Demand Dose



Fig. 41 Model 112, simplex, control box

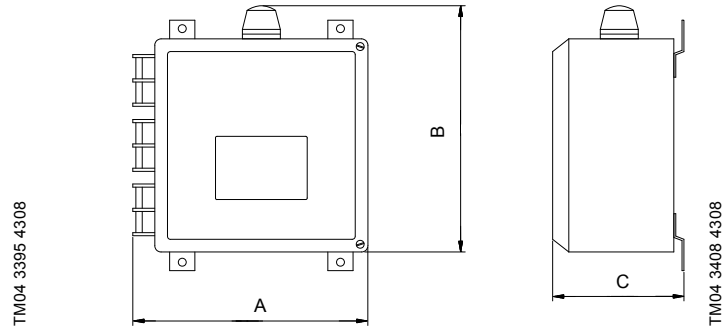

Fig. 42 Dimensional drawings

Technical data

Product number	Model	Full-load current [A]	Number of phases	Voltage [V]	Dimensions [inches]			Shipping weight [lbs]	Shipping volume [cu ft]
					A	B	C		
96900631	112	7-15	1	120/208/240	9.29	9.73	5.19	16	1.06

Description

Single-phase, simplex motor contactor and control panel.

The Model 112 control panel provides a reliable means of controlling one 120, 208, or 240 VAC single-phase pump in tanks, pump basins, irrigation systems and lifting stations.

Function

Two float switches activate a magnetic motor contactor to turn the pump on and off.

If an alarm condition occurs, an additional alarm float switch will activate the audio/visual alarm system.

Features

- The entire control system (panel and switches) is UL-listed to meet and/or exceed industry safety standards
- Dual safety certification for the United States and Canada
- Standard package includes three Sensor Float[®] float switches with 20 ft cables.
- Complete with step-by-step installation instructions
- Three-year limited warranty.

Model 122, duplex

Demand Dose



Fig. 43 Model 122, duplex, control box

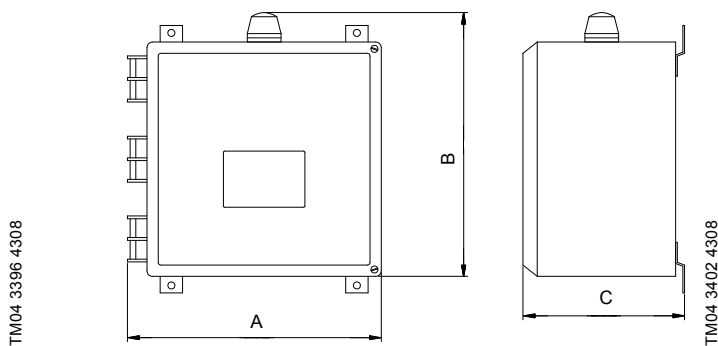

Fig. 44 Dimensional drawings

Technical data

Product number	Model	Full-load current [A]	Number of phases	Voltage [V]	Dimensions [inches]			Shipping weight [lbs]	Shipping volume [cu ft]
					A	B	C		
96900632	122	7-15	1	120/208/240	11.29	11.73	7.19	20	2.16

Description

Single-phase, duplex, alternating pump control panel with override.

The Model 122 control panel is designed to alternately control two 120, 208, or 240 VAC single-phase pumps in water and sewage installations.

Common applications include tanks, pump basins, irrigation systems and lifting stations.

Function

The alternating action equalizes pump wear. In addition to the alternating pump control, this system provides override control, should either pump fail).

If an alarm condition occurs, an alarm switch will activate the audio/visual alarm system.

Features

- The entire control system (panel and switches) is UL-listed to meet and/or exceed industry safety standards
- Dual safety certification for the United States and Canada
- Standard package includes three Sensor Float[®] float switches with 20 ft cables.
- Complete with step-by-step installation instructions
- Three-year limited warranty.

IFS 1, simplex

Timed dose



Fig. 45 IFS 1, simplex, control box

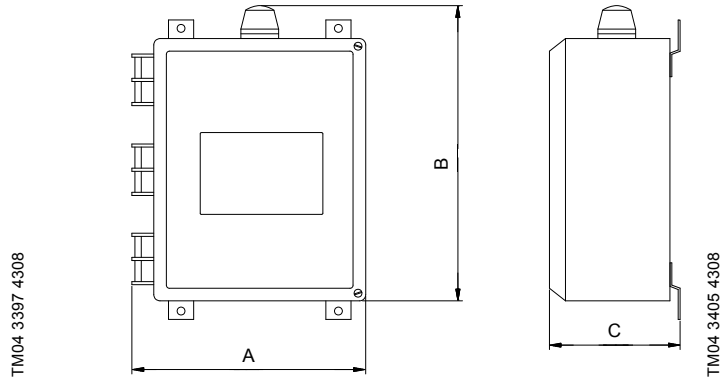

Fig. 46 Dimensional drawings

Technical data

Product number	Model	Full-load current [A]	Number of phases	Voltage [V]	Dimensions [inches]			Shipping weight [lbs]	Shipping volume [cu ft]
					A	B	C		
96900636	IFS1	7-15	1	120/208/240	9.29	11.73	5.19	20	2.16

Description

The Installer Friendly Series[®], single-phase, simplex is a demand dose or timed dose, float controlled system.

The IFS simplex control panel is designed to control one 120, 208, 240 VAC single-phase pump in water and sewage installations.

Common applications include tanks, pump basins, irrigation systems and lifting stations.

The IFS control panel has an easy-to-use touch pad with display on the inner door for programming and system monitoring.

The panel configuration can be easily converted in the field to either a timed dose or demand dose control system.

Features

- The entire control system (panel and switches) is UL-listed to meet and/or exceed industry safety standards
- Dual safety certification for the United States and Canada
- Standard package includes:
Demand Dose three Sensor Float[®] float switches with 20 ft cables.
Timed Dose two Sensor Float[®] float switches with 20 ft cables.
- Complete with step-by-step installation instructions
- Three-year limited warranty.

IFS 1, duplex

Timed dose



Fig. 47 IFS 1, duplex, control box

TM04 3397 4308

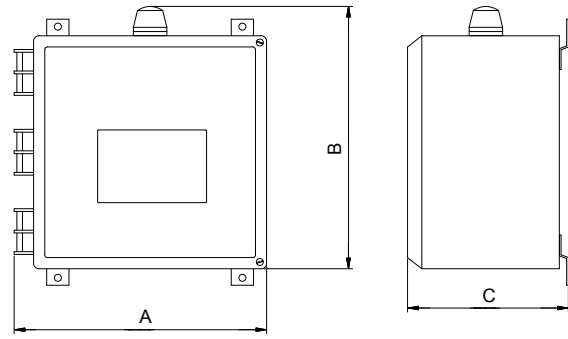

Fig. 48 Dimensional drawings

TM04 3404 4308

Technical data

Product number	Model	Full-load current [A]	Number of phases	Voltage [V]	Dimensions [inches]			Shipping weight [lbs]	Shipping volume [cu ft]
					A	B	C		
96900637	IFS1	7-15	1	120/208/240	11.29	11.73	7.19	20	2.16

Description

The Installer Friendly Series[®], single-phase, duplex is a demand dose or timed dose, float controlled system. The IFS duplex control panel is designed to control two (alternating) 120, 208, 240 VAC single-phase pumps in water and sewage installations.

Common applications include tanks, pump basins, irrigation systems and lifting stations.

The IFS control panel has an easy-to-use touch pad with display on the inner door for programming and system monitoring.

The panel configuration can be easily converted in the field to either a timed dose or demand dose control system.

Features

- The entire control system (panel and switches) is UL-listed to meet and/or exceed industry safety standards
- Dual safety certification for the United States and Canada
- Standard package includes:
Demand Dose three Sensor Float[®] float switches with 20 ft cables.
Timed Dose two Sensor Float[®] float switches with 20 ft cables.
- Complete with step-by-step installation instructions
- Three-year limited warranty.

5. Alarms

Tank Alert® I



Fig. 49 Tank Alert® I control box

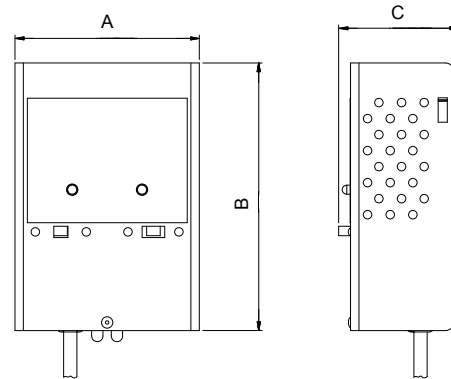

Fig. 50 Dimensional drawings

TM04 3397 4308

TM04 3407 4308

Technical data

Product number	Model	Full-load current [A]	Number of phases	Voltage [V]	Dimensions [inches]			Shipping weight [lbs]	Shipping volume [cu ft]
					A	B	C		
96001042	TA1	5.0	1	120	4.07	6.16	2.66	4	0.15

Description

Tank Alert® I is an easy-to-install, liquid level alarm system for indoor use.

This alarm system monitors liquid levels in lifting stations, pump basins, sewage tanks, agricultural storage tanks, and other non-potable water applications.

Function

The Tank Alert® I alarm system can serve as a high- or low-level alarm depending on the float switch model used.

The alarm horn will sound when a critically high liquid level occurs. The horn can be turned off, but the warning light will remain on until the condition has been remedied.

A green "power on" light indicates power to the alarm panel.

Features

- NEMA 1 enclosure, designed for easy installation, rated for indoor use.
- Red "WARNING LIGHT", green "POWER ON" light, alarm "TEST" switch, and "HORN SILENCE" switch.
- Alarm horn will sound at 86 dB at 10 ft (3 m) distance.
- Can be used with any UL-listed/-recognized switching mechanism rated to include 1 Amp, 12 VAC load.
- Alarm system (when installed on a separate circuit) operating even if the power to the pump fails.
- Complete package includes standard Sensor Float® float switch with 15 ft (4.57 m) cable and mounting clamp. Other cable lengths are available.
- Switching mechanism operates on low voltage and is isolated from the power line to reduce the risk of shock.
- UL-listed.
- CSA-certified.
- Three-year limited warranty.

Tank Alert® 4X



Fig. 51 Tank Alert® 4X, control box

TM04 3400 4308

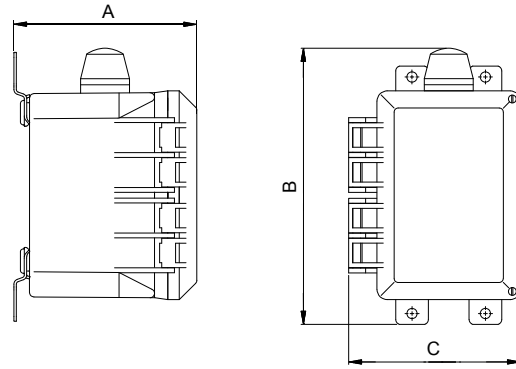

Fig. 52 Dimensional drawings

TM04 3408 4308

Technical data

Product number	Model	Full-load current [A]	Number of phases	Voltage [V]	Dimensions [inches]			Shipping weight [lbs]	Shipping volume [cu ft]
					A	B	C		
96001043	TA4X	5.0	1	120	5.61	8.47	5.27	4	0.15

Description

Tank Alert® 4X is an easy-to-install liquid level alarm system which has a NEMA 4X enclosure for indoor or outdoor use.

This alarm system monitors liquid levels in lifting stations, pump basins, sewage tanks, agricultural storage tanks, and other non-potable water applications.

Function

The Tank Alert® 4X alarm system can serve as a high- or low-level alarm depending on the float switch model used.

The stainless steel alarm horn will sound and the red beacon will illuminate when a critically high liquid level occurs.

Features

- NEMA 4X enclosure rated for indoor or outdoor use.
- Automatic alarm reset and alarm test/normal/silence switch.
- Alarm system (when installed on separate circuit) operating even if the power to the pump fails.
- Complete package includes standard Sensor Float® float switch with 15 ft (4.57 m) cable and mounting clamp. Other cable lengths are available.
- UL/CUL-listed.
- Three-year limited warranty.

Tank Alert® AB



Fig. 53 Tank Alert® AB, control box

TM04 3398 4308

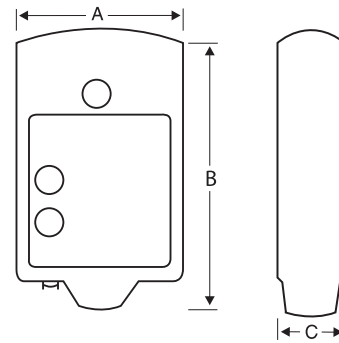

Fig. 54 Dimensional drawings

TM04 3406 4308

Technical data

Product number	Model	Full-load current [A]	Number of phases	Voltage [V]	Dimensions [inches]			Shipping weight [lbs]	Shipping volume [cu ft]
					A	B	C		
96901182	TAA8	2.4	1	120	4.05	6.86	2.37	4	0.15

Description

Tank Alert® AB is an easy-to-install liquid level alarm system with auto-reset and battery backup features for indoor use.

This alarm system monitors liquid levels in lifting stations, pump basins, sewage tanks, agricultural storage tanks, and other non-potable water applications.

Function

The Tank Alert® AB alarm system can serve as a high- or low-level alarm depending on the float switch model used.

The alarm horn will sound when a critically high liquid level occurs. The horn can be turned off, but the alarm light will remain on until the condition has been remedied. Once the condition is cleared, the alarm will automatically reset.

A green "POWER ON" light indicates 120 VAC primary power to the alarm. Low-battery chirp function will indicate when battery should be replaced.

Features

- NEMA 1 enclosure, designed for easy installation, rated for indoor use.
- Automatic alarm reset.
- Red "ALARM" light and green "POWER ON" light, alarm "TEST" switch, and horn "SILENCE" switch.
- Alarm horn will sound at 87 dB at 10 ft (3 m) distance.
- Can be used with any UL-listed/-recognized switching mechanism rated to include 1 Amp, 9 VDC load.
- If primary power fails, the alarm system will continue functioning due to battery backup feature. (Battery not included.)
- Complete package includes standard SJE SignalMaster® float switch with 15 ft (4.57 m) cable and mounting clamp. Other cable lengths are available.
- Switching mechanism operates on low voltage and is isolated from the power to the pump to reduce the risk of shock.
- Low battery chirp.
- Easy access battery compartment.
- External terminal block for easy float switch installation.
- CSA-certified.
- UL-listed.
- Three-year limited warranty.

6. Accessories

Mechanical float switches

For Unilift Series

Description	Voltage [V]	Cable length [ft]	Fits pump model	Product number
Wide angle, piggyback connection	115	10	KP, AP and AP-B	96001059
Wide angle, piggyback connection	115	25	KP, AP and AP-B	96901187
Wide angle, without plug	230	10	AP and AP-B	96001062
Wide angle, without plug	230	25	AP and AP-B	96901188
Vertical, piggyback connection	115	10	CC, KP, AP and AP-B	96030395
Vertical, piggyback connection	115	25	CC, KP, AP and AP-B	96933675
Vertical, without plug	230	10	CC, AP and AP-B	96933676
Vertical, without plug	230	25	CC, AP and AP-B	96933677

For Series 25

Description	Voltage [V]	Cable length [ft]	Fits pump model	Product number
Wide angle, piggyback connection	115	10	SU 25 and EF 25	96001643

For alarms & panels

Description	Cable length [ft]	Product number
Tank alarms	15	96934589
112/122 panels	20	96934590
1FS panels	20	96934591

Basins

Ejector basins

Size DxH [inches]	Material	Product number
18 x 30	Polypropylene	96742101
24 x 36	Polyethylene	96001005
30 x 36	Fiberglass	96001006
36 x 36	Fiberglass	96001007

Basin hubs and fittings

Material	Product number
3-inch, cast iron, caulking inlet hub with four 0.313" mounting holes	96001507
4-inch, cast iron, caulking inlet hub with four 0.313" mounting holes	96001508
6-inch, cast iron, caulking inlet hub with four 0.313" mounting holes	96001509
4-inch, cast iron, flat inlet hub with four 0.313" mounting holes	96001510
3-inch, pipe gasket for tank sidewall mounting	96001504
4-inch, pipe gasket for tank sidewall mounting	96001505
6-inch, pipe gasket for tank sidewall mounting	96001506

Basin covers

Size, diameter [inches]	Discharge x vent [inches]	Type	Material	Product number
18	2 x 2	Simplex	Steel	96001008
18	2 x 3	Simplex	Steel	96001009
18	2 x 2	Simplex	Steel/split	91122139
18	2 x 3	Simplex	Steel/split	91122140
24	2 x 2	Simplex	Steel	96001012
24	2 x 3	Simplex	Steel	96001013
30	2 x 2	Simplex	Steel	96001016
30	2 x 3	Simplex	Steel	96001017
30	2 x 2	Duplex	Steel	96001020
30	2 x 3	Duplex	Steel	96001021
36	2 x 2	Simplex	Steel	96001024
36	2 x 3	Simplex	Steel	96001025
36	2 x 2	Duplex	Steel	96001028
36	2 x 3	Duplex	Steel	96001029

Screw and gasket kits for basin covers

Contents of kits		Remarks	Product number	To be used with basin cover, product number
<ul style="list-style-type: none"> • (2) 2" Adaptaflex fittings • (1) rubber plug (electric) • (8) 0.25" x 1.25" lag screws 	<ul style="list-style-type: none"> • (8) 0.25" flat washers • (1) roll of gasket material • (1) 4" Adaptaflex/inlet 	New eight-screw design	96742102	96001008
<ul style="list-style-type: none"> • (1) 2" Adaptaflex fitting • (1) 3" Adaptaflex fitting • (1) rubber plug (electric) • (8) 0.25" x 1.25" lag screws 	<ul style="list-style-type: none"> • (8) 0.25" flat washers • (1) roll of gasket material • (1) 4" Adaptaflex/inlet 	New eight-screw design	96742103	96001009
<ul style="list-style-type: none"> • (1) rubber electric plug • (1) 2.5" O-ring seal • (6) 0.375" x 1.5" screws 	<ul style="list-style-type: none"> • (6) flat washers • (1) 0.125" x 0.5" gasket tape • (1) 0.125" x 1" gasket tape 		96001014	96001012, 96001013, 96001016, 96001017, 96001024, 96001025
<ul style="list-style-type: none"> • (2) rubber electric plugs • (2) 2.5" O-ring seals • (6) 0.375" x 1.5" screws 	<ul style="list-style-type: none"> • (6) flat washers • (2) 0.125" x 0.5" gasket tape • (1) 0.125" x 1" gasket tape 		96001015	96001020, 96001021, 96001028, 96001029

Swing check valves

Description	Product number
PVC 1.5", w/compression fittings, 7.5" body length	96001644
PVC 2", w/compression fittings, 9.75" body length	96001645
PVC 2", w/compression fittings, 9.75" body length	96001049
PVC 3", w/compression fittings, 14" body length	96001050
PVC 1.5", w/solvent fittings, 5.75" body length	96001046
PVC 2", w/solvent fittings, 6" body length	96001047

Junction box

Description	Product number
NEMA 4X	96001051

7. Pump and system sizing instructions

Pump and system sizing instructions

The information needed and steps required to properly size a wastewater pump and pumping system are listed below:

1. System capacity (GPM required)
2. Total dynamic head
3. Size of solids
4. Pump selection
5. Basin size
6. Simplex or duplex system

The following pages explain how this information is obtained and used to properly size the pump and pumping system.

1. System capacity

System capacity is calculated in US gallons per minute (GPM).

The best method to determine this figure is through the "Fixture unit" method. Proceed in this way:

A. Count the water fixtures (faucets, showers, water closets and other draw-off points) in the building and their unit values as shown in the chart on page 5.

B. Refer to the graph below to determine GPM.

Note: It must also be determined if there is a liquid velocity of at least 2 ft per second through the pipe to carry the solids without clogging. This is ensured if the flow rate is at least:

9	GPM	through a	1.25" pipe
13	GPM	through a	1.5" pipe
21	GPM	through a	2" pipe
30	GPM	through a	2.5" pipe
46	GPM	through a	3" pipe
MINIMUM FLOW RATE REQUIRED			

Fixture unit values

Fixture unit	Qty.	Total	
Bathroom group: Wash basin, bathtub or shower and (direct flush) water closet	8		
Bathroom group: Wash basin, bathtub or shower and (flush tank) water closet	6		
Bathtub with 1.5" trap	2		
Bathtub with 2" trap	3		
Bidet with 1.5" trap	3		
Dental unit or cuspidor	1		
Drinking fountain	1/2		
Dishwasher (non-commercial)	2		
Kitchen sink, domestic	2		
Kitchen sink, domestic with garbage disposal	3		
Wash basin with 1.5" plug	1		
Wash basin (barber or beauty shop)	2		
Laundry tray, two-compartment	2		
Shower stall	2		
Shower (group) per head	3		
Sink (direct flush valve)	8		
Sink (service type with floor drain)	3		
Sink (scullery)	4		
Sink, surgery	3		
Urinal (with flush valve)	8		
Urinal (with flush tank)	4		
Water closet (with flush valve)	8		
Water closet (with flush tank)	4		
Swimming pool (per 1000 gal capacity)	1		
Water softener (domestic)	1		
Washing machine	2		
Unlisted fixture with 1.25" trap size	3		
Unlisted fixture with 1.5" trap size	4		
Unlisted fixture with 2" trap size	5		
Unlisted fixture with 2.5" trap size	6		
Unlisted fixture with 3" trap size	4		
Unlisted fixture with 4" trap size	2		
		Total fixture units =	

System capacity based on total value of fixture units

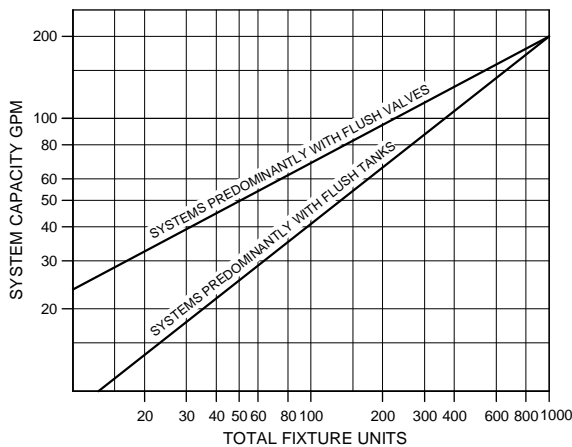

TM04 2425 2508

2. Total dynamic head

Dynamic head is expressed in feet of head (ft H₂O).

Total dynamic head is a combination of static head and friction loss:

A. Static head

The actual vertical distance of "lift" in feet from the minimum water level in the basin to the highest point in the discharge piping.

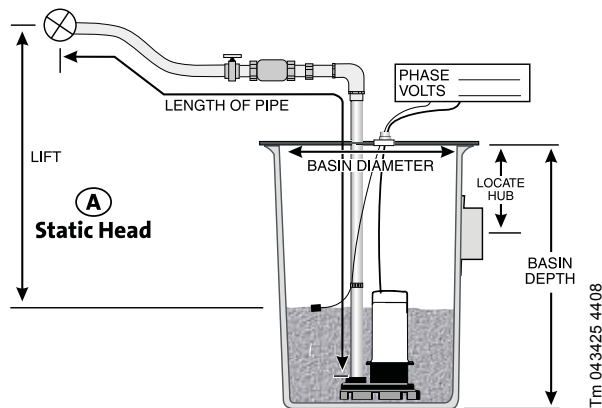

Fig. 55 Illustration of static head for an ejector basin with pump and piping

B. Friction loss

Friction losses are caused by pumping the solids/liquids through the various piping and fittings.

Every foot of pipe and every valve or fitting is rated for various friction losses at a given rate of capacity (GPM).

Use the figure above and the friction loss tables below to determine the friction loss.

Table A

Friction losses for fittings (equivalent feet of piping):

Nominal pipe diameter	90 ° elbow	45 ° elbow	Tee (through-flow)	Tee (branch-flow)	Swing check valve	Gate valve (open)
1.25"	3.5	1.8	2.3	6.9	11.5	0.9
1.5"	4.0	2.2	2.7	8.1	13.4	1.1
2"	5.2	2.8	3.5	10.3	17.2	1.4
2.5"	6.2	3.3	4.1	12.3	20.6	1.7
3"	7.7	4.1	5.1	15.3	25.5	2.0

Table B

Friction losses for pipes (per 100 feet of piping):

GPM	1.25" diameter		1.5" diameter		2" diameter		2.5" diameter		3" diameter	
	Plastic	Steel*	Plastic	Steel*	Plastic	Steel*	Plastic	Steel*	Plastic	Steel*
4	0.34	0.35								
6	0.71	0.72	0.33							
8	1.19	1.2	.056	0.57						
10	1.78	1.74	0.83	0.85						
12	2.48	2.45	1.16	1.18	0.34	0.35				
14	3.29	3.24	1.54	1.51	0.45	0.46				
16	4.21	4.15	1.97	1.93	0.58	0.59				
18	5.25	5.17	2.41	2.40	0.72	0.73				
20	6.42	6.31	2.96	2.92	0.88	0.88				
25	10.39	9.61	4.80	4.80	1.38	1.39				
30	13.60	13.00	6.27	6.23	1.81	1.82	0.75	0.77		
35	19.20	18.20	8.82	8.82	2.40	2.40	1.01	0.99		
40			10.70	10.80	3.12	3.10	1.28	1.30		
45			14.00	14.00	3.80	3.80	1.50	1.60	0.55	0.56
50			16.50	16.50	4.70	4.70	1.90	1.90	0.66	0.68
60					6.50	6.60	2.70	2.70	0.94	0.91
70					8.60	8.80	3.70	3.60	1.20	1.20
80					11.10	11.40	4.70	4.60	1.60	1.60
90					13.80	14.30	5.80	5.80	2.00	2.00
100					16.80	17.50	7.10	7.10	2.40	2.40
125							10.90	10.90	3.70	3.60
150							15.90	15.90	5.20	5.10
175									6.90	6.90

* Steel piping based on Schedule 40 pipe.

Friction loss worksheet

Fittings		
Diameter of fittings _____	From table "A"	Equals this pipe length
# of 90 ° elbows _____	x Each _____	= _____ ft
# of 45 ° elbows _____	x Each _____	= _____ ft
# of through-flow tees _____	x Each _____	= _____ ft
# of branch-flow tees _____	x Each _____	= _____ ft
# of swing check valves _____	x Each _____	= _____ ft
# of gate valves _____	x Each _____	= _____ ft
	Feet of pipe equivalent	_____ ft
		+
Piping:	Feet of pipe actual	_____ ft
Diameter of pipe _____	Total feet of pipe	= _____ ft
	Friction loss (from table "B")	<input style="width: 100px;" type="text"/>

Static head		_____ feet
Friction loss	+	_____ feet
Total dynamic head calculated	=	_____ feet

3. Size of solids

If the building has a water closet of any kind, it will pass 2" solids and require a sewage pump. If it does not have a water closet, it will only need to pass at least 0.75" or smaller solids, and will require an effluent pump.

4. Pump selection

Proceed as follows:

1. Go back to steps 1, 2 and 3 and find this information:
 - capacity (GPM)
 - total dynamic head required
 - solids handling requirements.
2. refer to the pump performance curves
3. find the best pump for the application
4. select the smallest pump that meets the capacity and head requirements and can pass the required solids size. (See performance curves in this product guide).

5. Basin size

To determine the proper basin size, refer to the required capacity of the system. Convert this to the volume the pump must be able to pump out of the basin during each cycle ("pumpable volume", see figure below) using this formula:

$$\text{GPM} \times \text{run time} = \text{volume}$$

The run time must be at least two minutes to ensure against short cycling (which would greatly reduce the service life of the pump). Therefore, if the flow rate is 50 GPM, the pumpable volume required in the basin must be 100 gallons.

GPM	x	Run time [mins.]	=	Volume [gals]
50	x	2	=	100

Referring to the figure below and the table on the following page, select a basin diameter and float switch free cable length that will guarantee a sufficient pumpable volume. Make sure that these requirements are fulfilled:

- The basin must be deep and wide enough to allow space for the ON/OFF range of the float switch to move freely.
- The bottom of the basin inlet must be at least 24" above the bottom of the basin.
- See descriptions of the individual pumps for water level required above the pump (submergence).

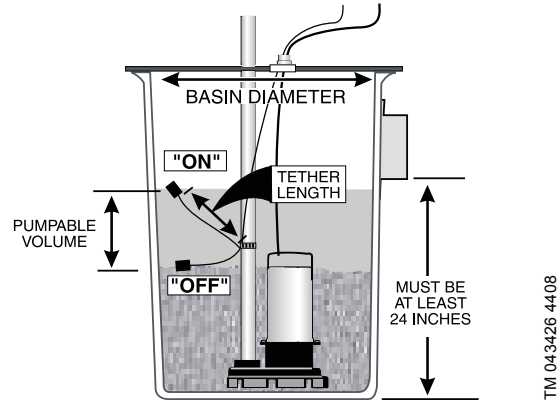

Fig. 56 Schematic drawing of ejector basin with pump, piping and float switch

Approximate pumpable volume (in gallons) for various combinations of basin diameter and float switch free cable lengths.

Basin diameter	Free cable length of float switch [inches]										
	OFF 3.5	6	8	10	12	14	16	18	20	22	24
ON	5.5	10	12	16	18	22	25	28	30	32	36
Basin diameter	Approximate pumpable volume [gallons]										
18"	6	11	13	17	20						
24"	11	20	23	29	35	41	47				
30"	17	31	37	46	55	64	73				
36"	24	44	53	66	79	93	106	123	132	145	159
48"	43	78	94	117	141	164	188	219	235	258	282
60"	67	122	147	184	220	257	294	343	367	404	440
72"	97	176	211	264	317	370	423	493	529	581	634

The values are approximate only. Volume may differ slightly due to basin construction.

6. Simplex or duplex System

Local plumbing codes will often determine whether a wastewater pumping system must be duplex (two pumps), or whether a simplex system (one pump) is sufficient. Most commercial applications are of the duplex type, however - not necessarily for the increased capacity offered by two pumps, but more for the standby safety factor that many municipalities require (public health concerns). In most residential installations, a simplex system is adequate - but be sure to check the local plumbing codes.

Additional information on pipe volume and flow velocity:

Storage of water in pipes of various sizes

Pipe size [inches]	Volume [gallons per foot]	Pipe size [inches]	Volume [gallons per foot]
1.25	0.06	6	1.4
1.25	0.09	8	2.6
2	0.16	10	4.07
3	0.36	12	5.87
4	0.652		

Minimum flow rate to maintain 2 ft/sec* flow velocity in various pipes

Pipe size [inches]	Minimum flow rate [GPM]	Pipe size [inches]	Minimum flow rate [GPM]
1.25	9	6	180
1.25	13	8	325
2	21	10	500
3	46	12	700
4	80		

* Failure to maintain or exceed this flow velocity will result in clogged pipes. Information is based on Schedule 40 nominal pipe.

8. Grundfos Product Center

Online search and sizing tool to help you make the right choice.

<http://product-selection.grundfos.com>



SIZING enables you to size a pump based on entered data and selection choices.

REPLACEMENT enables you to find a replacement product. Search results will include information on

- the lowest purchase price
- the lowest energy consumption
- the lowest total life cycle cost.

The screenshot shows the Grundfos Product Center website. At the top, there is a navigation bar with the URL 'www.grundfos.us', a 'Login' button, and the text 'Product range: USA | 60 Hz | Language: English (USA) Change settings'. Below this is a main navigation menu with links for 'HOME', 'FIND PRODUCT', 'COMPARE', 'YOUR PROJECTS', 'SAVED ITEMS', and 'HELP'. The main content area is titled 'FIND PRODUCTS AND SOLUTIONS' and features a search bar with a magnifying glass icon and a 'SEARCH' button. Below the search bar are four main categories: 'SIZING' (Enter pump sizing), 'CATALOG' (Product and services), 'REPLACEMENT' (Replace an old pump with a new), and 'LIQUIDS' (Find liquid pump). The 'SIZING' section is expanded, showing a 'QUICK SIZING' form. This form has two columns: 'Enter duty point:' with input fields for 'Flow (Q)*' (with a 'US gpm' dropdown) and 'Head (H)*' (with a 'ft' dropdown); and 'Select what to size by:' with radio buttons for 'Size by application', 'Size by pump design', and 'Size by pump family'. A 'START SIZING' button is located to the right of the 'Select what to size by:' section. At the bottom of the 'QUICK SIZING' section, there is an 'ADVANCED SIZING:' section with two toggle switches: 'Advanced sizing by application' and 'Guided selection'.

CATALOG gives you access to the Grundfos product catalog.

LIQUIDS enables you to find pumps designed for aggressive, flammable or other special liquids.

All the information you need in one place

Performance curves, technical specifications, pictures, dimensional drawings, motor curves, wiring diagrams, spare parts, service kits, 3D drawings, documents, system parts. The Product Center displays any recent and saved items — including complete projects — right on the main page.

Downloads

On the product pages, you can download Installation and Operating Instructions, Data Booklets, Service Instructions, etc. in PDF format.

Subject to alterations.

Grundfos GO

Mobile solution for professionals on the GO!

Grundfos GO is the mobile tool box for professional users on the go. It is the most comprehensive platform for mobile pump control and pump selection including sizing, replacement and documentation. It offers intuitive, handheld assistance and access to Grundfos online tools, and it saves valuable time for reporting and data collection.











L-UNI-PG-01

96900036 0315

ECM: 1155034

Grundfos Kansas City

17100 West 118th Terrace
Olathe, Kansas 66061
Phone: 913-227-3400
Fax: 913-227-3500
www.grundfos.us

Grundfos Canada

2941 Brighton Road
Oakville, Ontario L6H 6C9 Canada
Phone: +1-905-829-9533
Fax: +1-905-829-9512
www.grundfos.ca

Grundfos México

Boulevard TLC No. 15
Parque Industrial Stiva Aeropuerto
C.P. 66600 Apodaca, N.L. Mexico
Phone: 011-52-81-8144 4000
Fax: 011-52-81-8144 4010
www.grundfos.mx