



LC 231

Emptying application



Further product documentation
net.grundfos.com/qr/i/99381576



Further product documentation
net.grundfos.com/qr/i/99480674

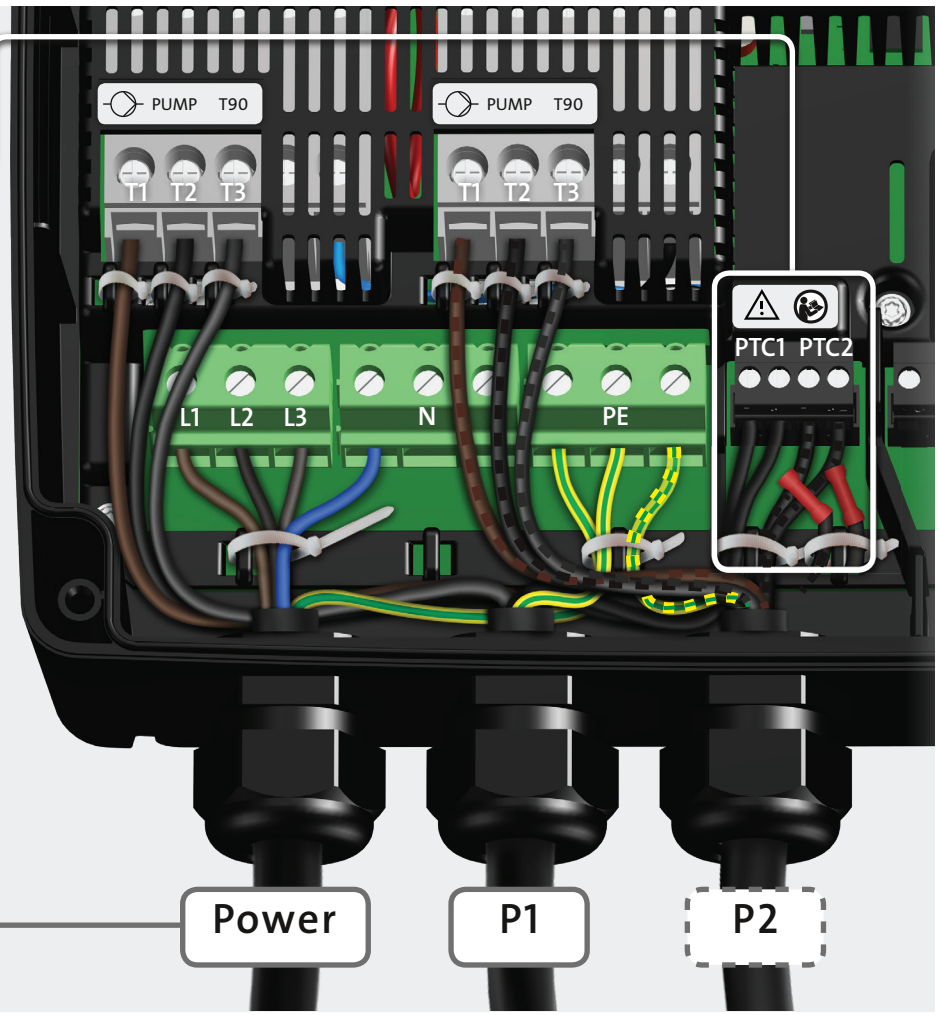
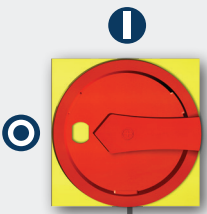
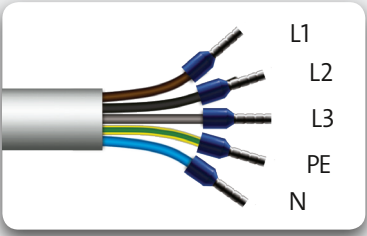
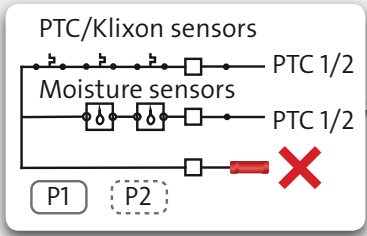

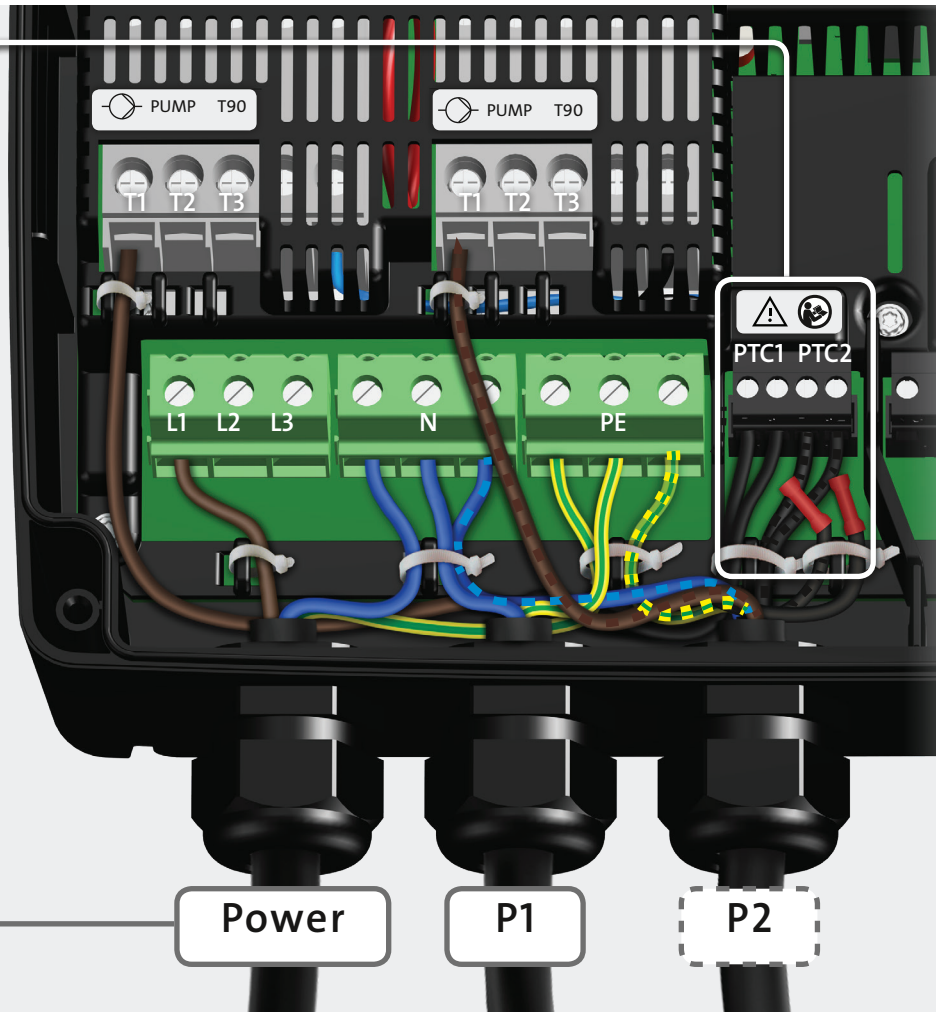
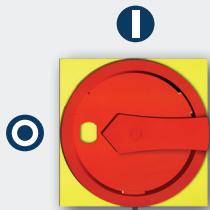
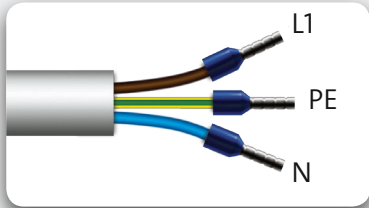
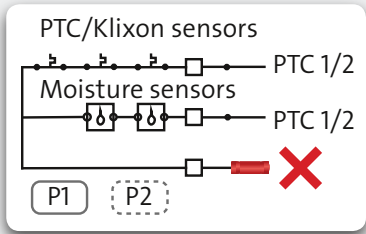

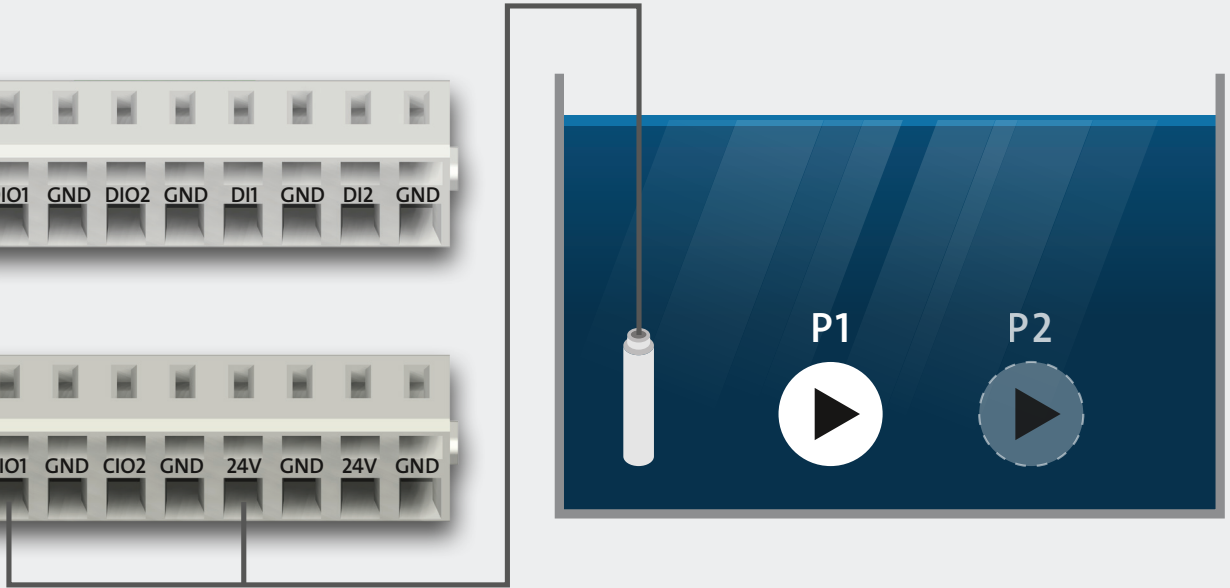
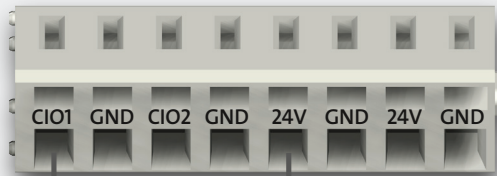
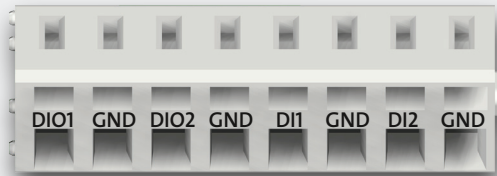

S-1 = analog

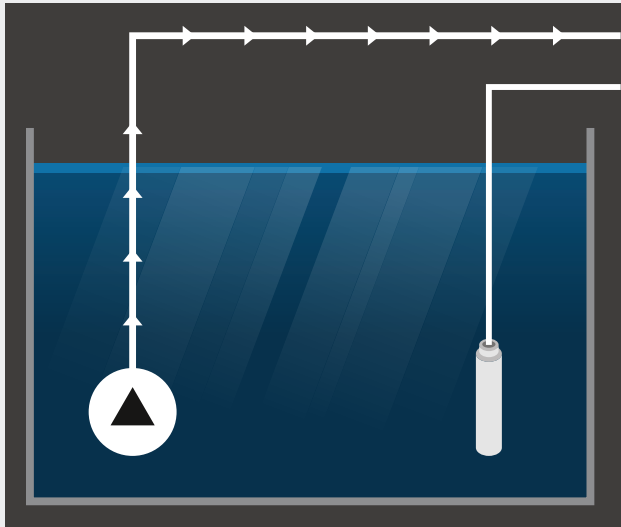



OK → ↑ ↓ → OK x 2

LC 231

On Off Auto On Off Auto

1 2

GRUNDFOS



↑ ↓ → OK x 2

LC 231

On Off Auto On Off Auto

1 2

GRUNDFOS

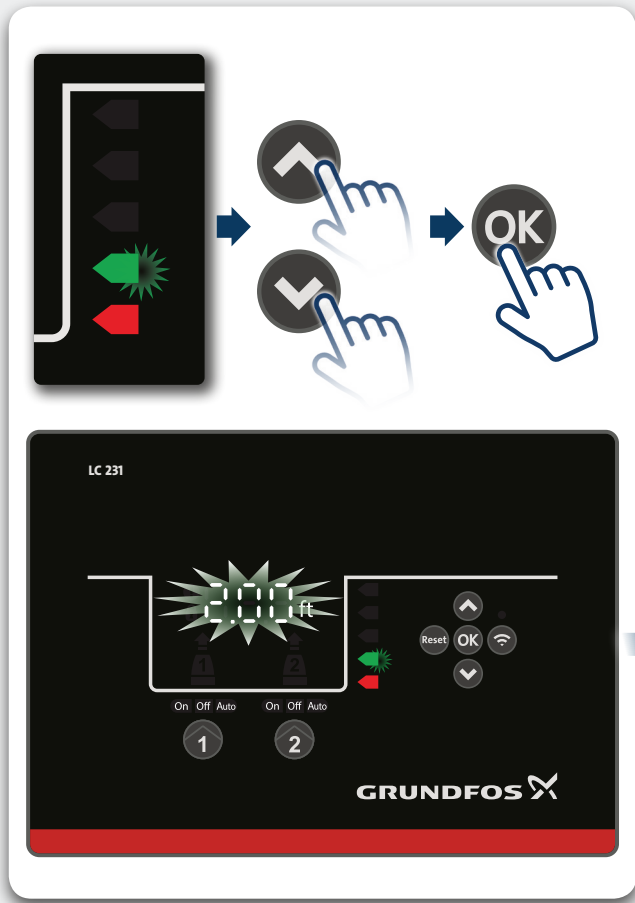
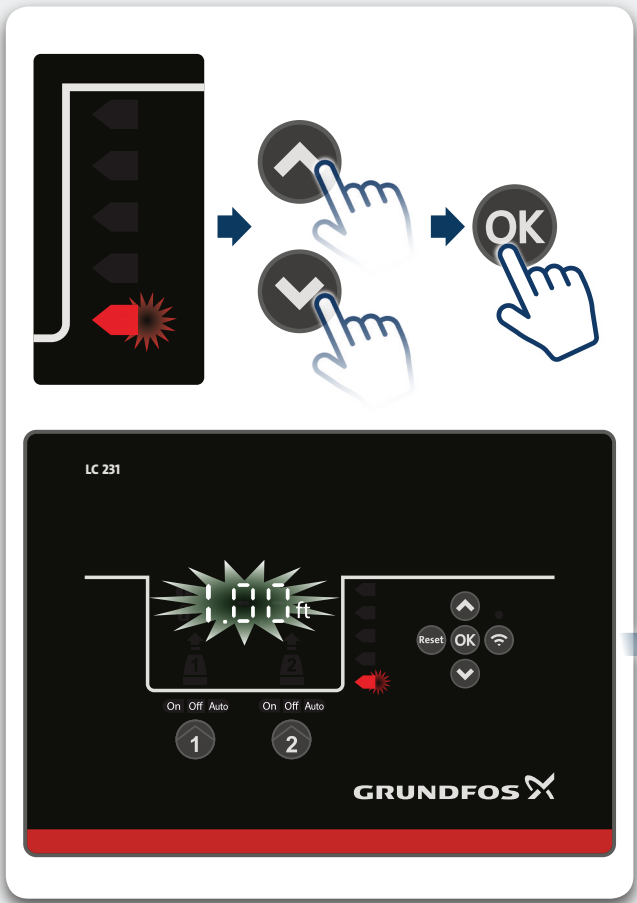



LC 231

5.00 ft

On Off Auto On Off Auto

1 2

GRUNDFOS

1 2

LC 231

5.00 ft

On Off Auto On Off Auto

1 2

GRUNDFOS

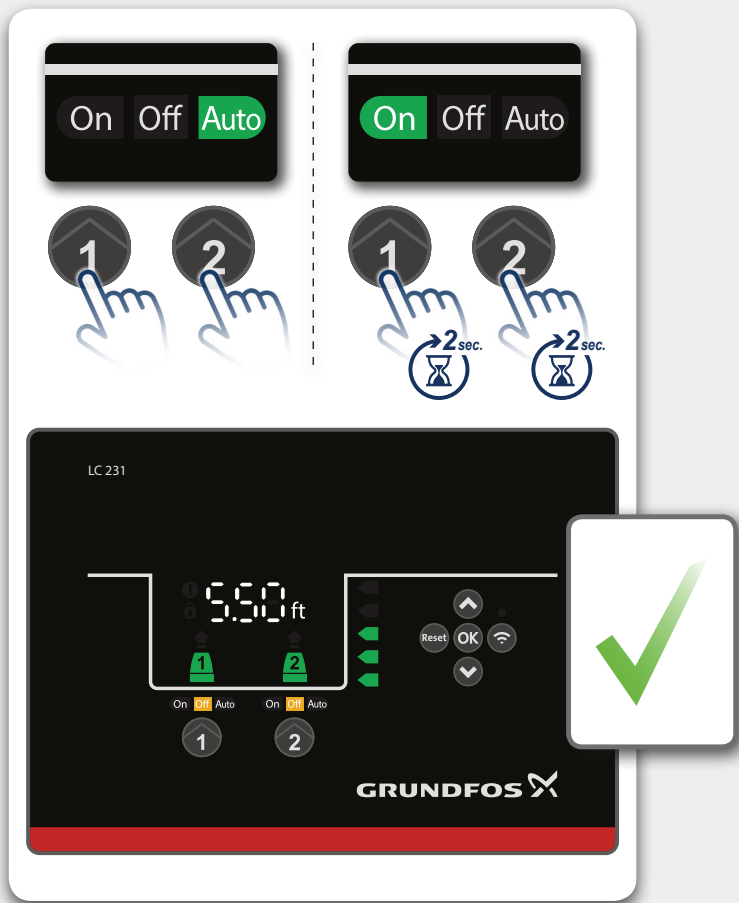
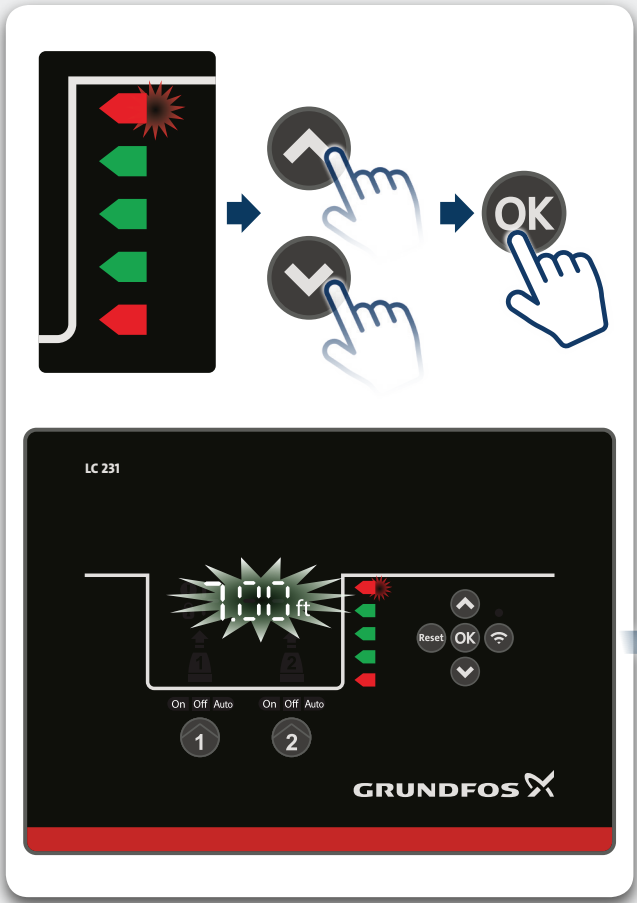

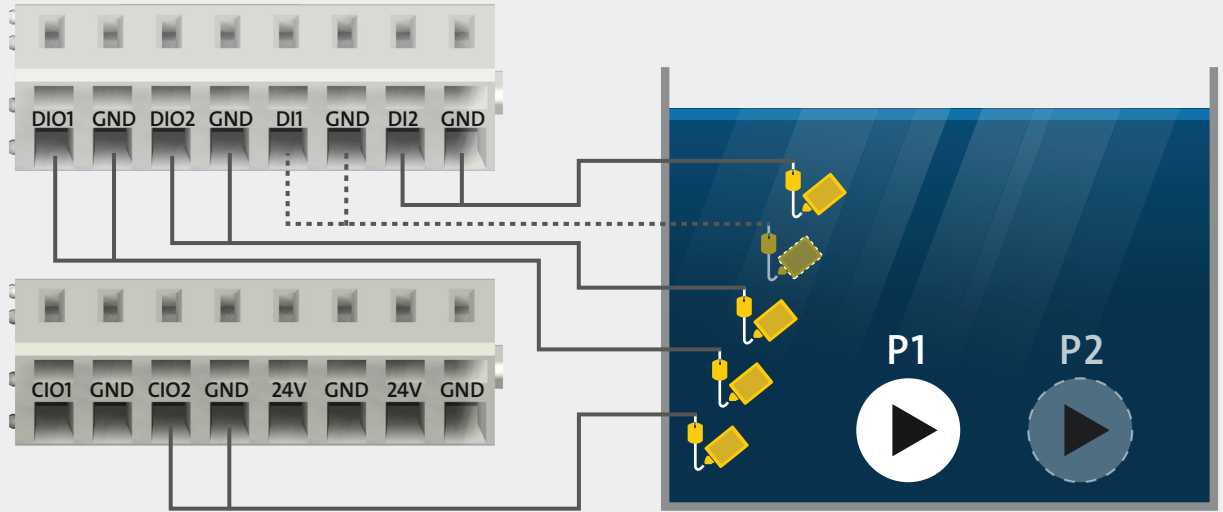

S-2 = digital

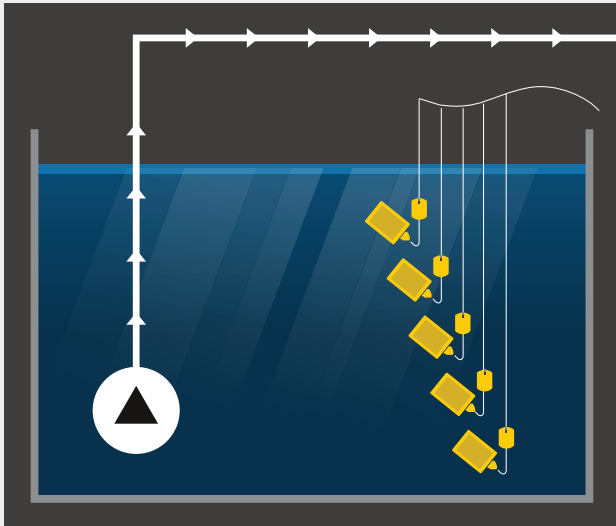

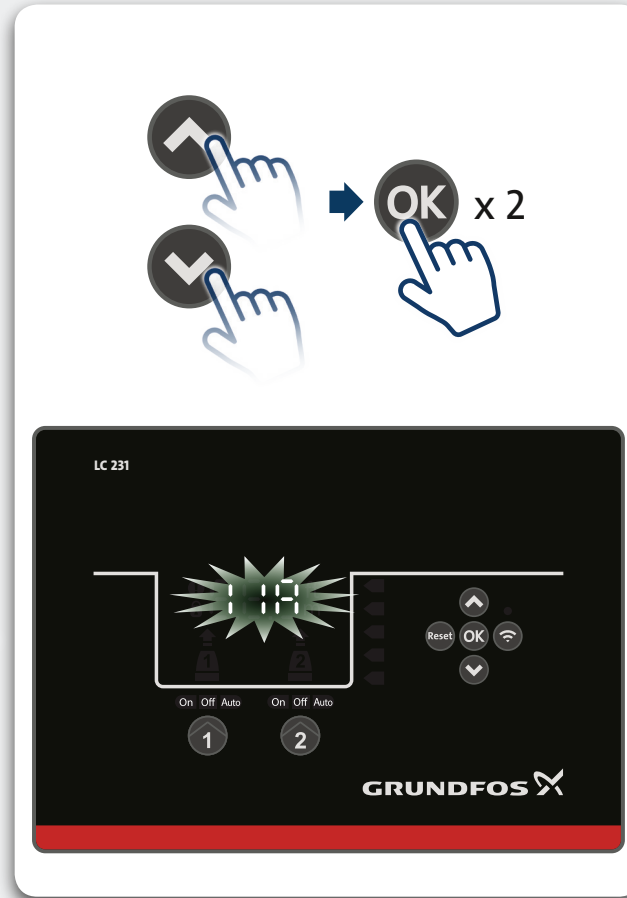
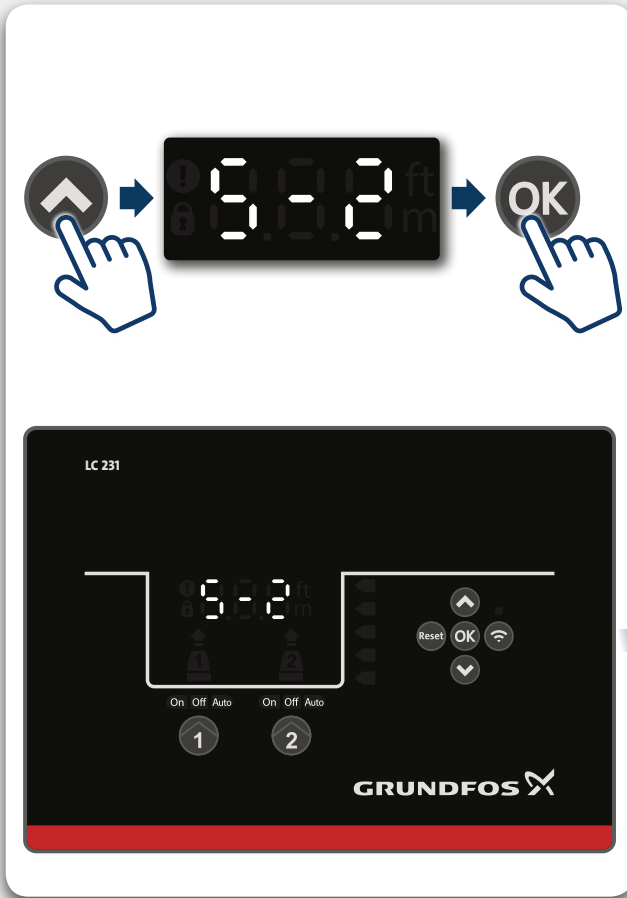

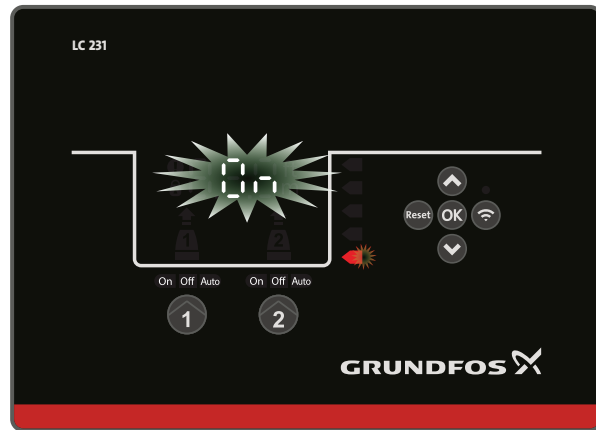
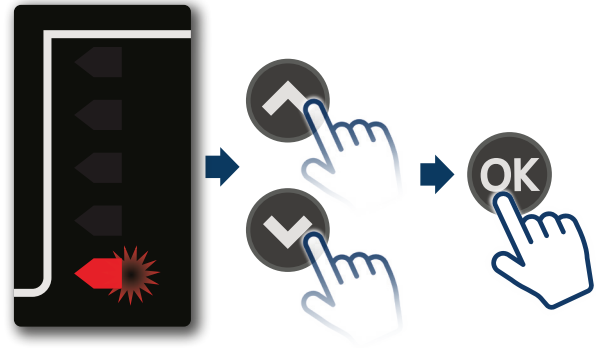
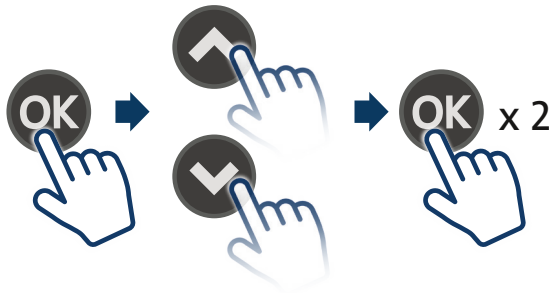



1 2

LC 231

Reset OK Wi-Fi

On Off Auto On Off Auto

1 2

GRUNDFOS

LC 231

Reset OK Wi-Fi

On Off Auto On Off Auto

1 2

GRUNDFOS

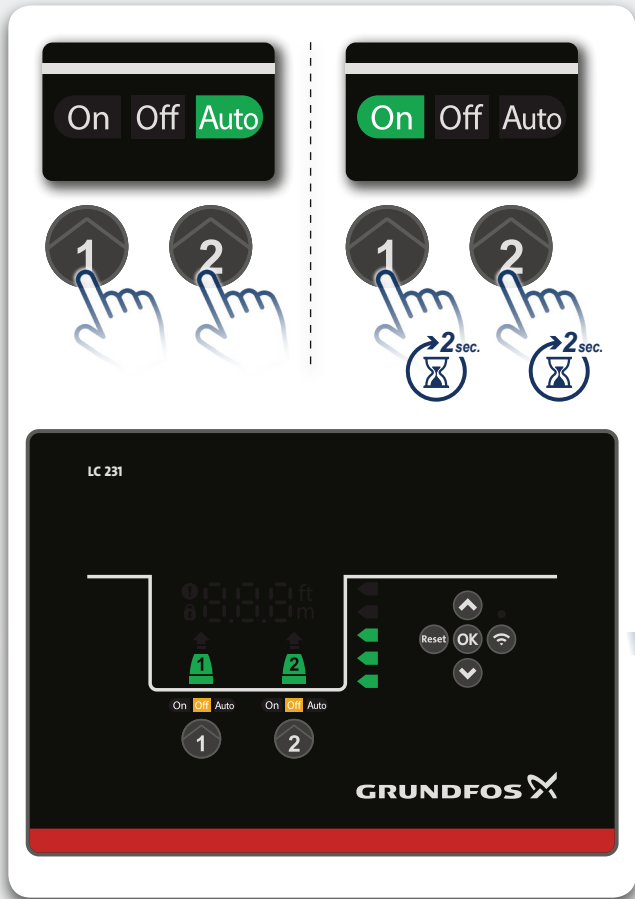

be think innovate

99725698 0820

ECM: 1288742

Grundfos Americas
Brookshire, TX 77423

www.grundfos.us
www.grundfos.ca
www.grundfos.mx

GRUNDFOS 

Trademarks displayed in this material, including but not limited to Grundfos, the Grundfos logo and "be think innovate" are registered trademarks owned by The Grundfos Group. All rights reserved. © 2020 Grundfos Holding A/S. All rights reserved. LWU1C231GG 0820