



CRN3-H

Parts List & Kits

Contents

Parts List
Spare Part Kits
Accessories
Special Tools
Standard Tools
Tools for Torques

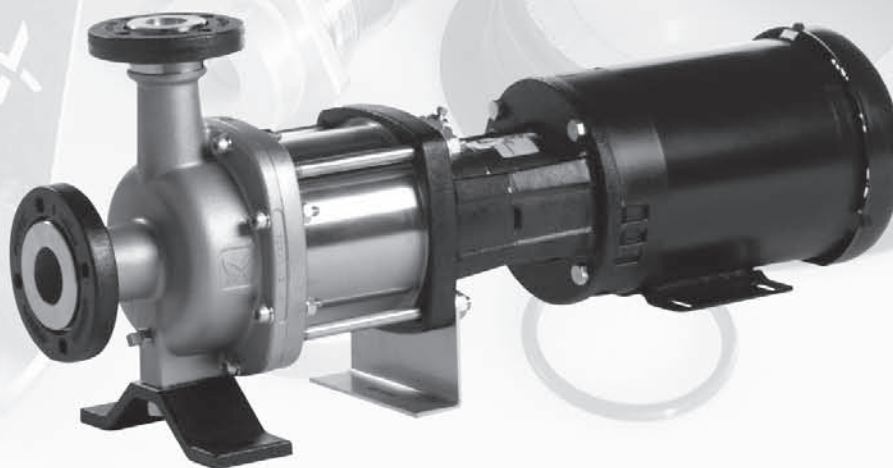

Exploded View CRN3-H

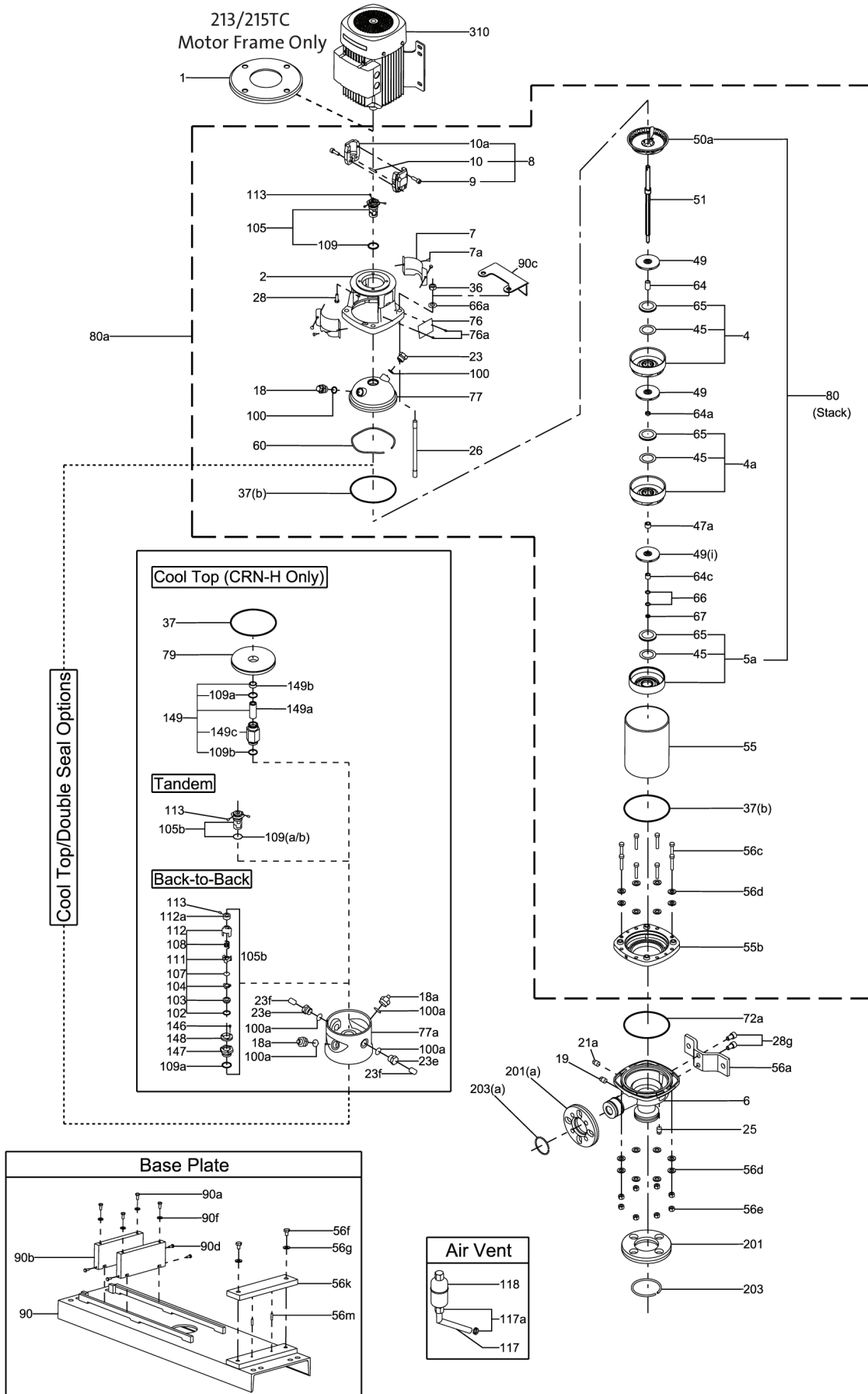

Parts List & Kits CRN3-H

Pos. No.	Part Description	Model	Stages	No. Used	Comments/Dimensions	B.O.M. Ref. No.	Material No.	Included in kits ?
PARTS LIST								
1	Adapter for Motor Stool			1	For NEMA, 213/215TC, 7.5 - 10HP	96476208		No
2	Motor Stool-Cat. Cast Iron, w/o insert Pos. 77		3/2-12	1	NEMA, 56C, 1/3 - 2HP	96436510		No
			13-25	1	NEMA, 182/184TC, 3 - 5HP Add Pos. 1, NEMA, 213TC, 7.5 - 10HP	96436511 96436511		No
	Motor Stool-Stainless Option for GI-w/o Pos. 77		3/2-12	1	NEMA, 56C, 1/3 - 2HP	96497267		No
			13-25	1	NEMA, 182/184TC, 3 - 5HP	96497271		No
				1	Add Pos. 1, NEMA, 213TC, 7.5 - 10HP	96497271		No
4	Chamber, Complete with Pos. 45 & 65		3/2-36	^^^	PTFE Pos. 45	96439481		No
4a	Chamber Cpl. w/Pos. 45 & 65 & Bearing		3/2-36	^^^	PTFE Pos. 45, (97690021 is a qty. of 5)	96439482	97690021	No
			3/2-36	^^^^	Silicon Carbide Bearing, PTFE Pos. 45	96439476		YES
5a	Chamber Cpl. w/Pos. 45 & 65 & Brg. (option)		3/2-36	^^^^	Graflon Bearing, PTFE Pos. 45	96440615		YES
			3/2-36	1*	PTFE Pos. 45	96439485	96588149	No
6	Volute		3/2-36	1	GA, Stainless Steel	95922064		No
7	Coupling Guard		3/2-12	2	NEMA-56C	96438137		No
7a	Screw for Coupling Guard		13-25	2	NEMA, 182-215TC	96438138		No
			3/2-36	4	Screw comb. slot torx/straight slot 4 x 8mm	96488481		No
9	Allen Screw		3/2-12	4	M6 x 20mm, Delta Tone/Seal	00ID7899		YES
			13-25	4	M8 x 25mm, Delta Tone/Seal	00ID7900		YES
				4	M10 x 25mm, Delta Tone/Seal	00ID7901		YES
10	Shaft Pin		3/2-36	1	ø5 x 26mm	310192		YES
10a	Coupling Half		3/2-12	2	NEMA, 56C, 1/3 - 2HP, ø15.8 / ø12	410108		YES
			3/2-12	1	NEMA, 143/5TC, 1/3-3HP, ø22.225 / ø12 (Mach)	97851501		YES
			13-25	2	NEMA, 182/184TC, 3-5HP, ø28.5/ø12	410109		YES
				2	NEMA, 213TC, 7.5-10HP, ø34.9/ø12	96472175		YES
18(a)	Priming/Vent Plug		3/2-36	*	G 1/2A, NV24 with NV9 x M8 stem	405150	95061351	No
19(a)	Pipe Plug		3/2-36	**	1/4" NPT,SS SQHD, with Loctite	91136507		No
21a	Pipe Plug		3/2-36	**	1/4" NPT,SS SQHD, with Loctite	91136507		No
23(c)	Plug		3/2-36	**	G 1/2A, Solid No port, NV24	370025	95061733	No
23a, e	Plug (option)		3/2-36	**	G 1/2A, w/1/4"port, NV24	91120659		No
23b, f	Pipe Plug for Pos. 23a, 23e		3/2-36	**	1/4" NPT,SS SQHD, with Loctite	91136507		No
23d	Plug, Vented for Pos. 77a Cool Top® option only		3/2-36	2	G 1/2A, NV24, Vented	96510323		No
25	Drain Plug		3/2-36	1	1/4" NPT,SS SQHD, with Loctite	91136507		No
26	Staybolt		3/2-3	4	M12, ø10,7 x 69mm	97683238		No
			4	4	M12, ø10,7 x 87mm	97683239		No
			5	4	M12, ø10,7 x 106mm	97683241		No
			6	4	M12, ø10,7 x 123mm	97683242		No
			7	4	M12, ø10,7 x 141mm	97683243		No
			8	4	M12, ø10,7 x 160mm	97683245		No
			9	4	M12, ø10,7 x 177mm	97683246		No
			10	4	M12, ø10,7 x 195mm	97683247		No
			11	4	M12, ø10,7 x 214mm	97683250		No
			12	4	M12, ø10,7 x 231mm	97683251		No
			13	4	M12, ø10,7 x 249mm	97683252		No
			15	4	M12, ø10,7 x 285mm	97683255		No
			17	4	M12, ø10,7 x 322mm	97683258		No
			19	4	M12, ø10,7 x 357mm	97683260		No
			21	4	M12, ø10,7 x 393mm	97683262		No
			23	4	M12, ø10,7 x 430mm	97683264		No
			25	4	M12, ø10,7 x 465mm	97683266		No
			27	4	M12, ø10,7 x 501mm, 4 pole & 50 Hz.	97683268		No
			29	4	M12, ø10,7 x 537mm, 4 pole & 50 Hz.	97683270		No
			31	4	M12, ø10,7 x 573mm, 4 pole & 50 Hz.	97683272		No
33	4	M12, ø10,7 x 609mm, 4 pole & 50 Hz.	97683273		No			
36	4	M12, ø10,7 x 663mm, 4 pole & 50 Hz.	97683274		No			
Staybolt (Cool Top®, Back-to-Back & Tandem Seal Option)			3/2-3	4	M12, ø10,7 x 177mm	97683246		No
			4	4	M12, ø10,7 x 195mm	97683247		No
			5	4	M12, ø10,7 x 214mm	97683250		No
			6	4	M12, ø10,7 x 231mm	97683251		No
			7	4	M12, ø10,7 x 249mm	97683252		No
			8	4	M12, ø10,7 x 267mm	97683254		No
			9	4	M12, ø10,7 x 285mm	97683255		No
			10	4	M12, ø10,7 x 303mm	97683256		No
			11	4	M12, ø10,7 x 322mm	97683258		No
			12	4	M12, ø10,7 x 339mm	97683259		No
			13	4	M12, ø10,7 x 357mm	97683260		No
			15	4	M12, ø10,7 x 393mm	97683262		No
			17	4	M12, ø10,7 x 430mm	97683264		No
			19	4	M12, ø10,7 x 465mm	97683266		No
			21	4	M12, ø10,7 x 501mm	97683268		No
23	4	M12, ø10,7 x 537mm	97683270		No			

Due to part changes over time, all position numbers (1-203) may not be used.

This column indicates which model uses the spare part. If blank, the part is used in all models.

B.O.M. Ref. Number is only available if it is not included in a kit or does not have a material number listed. If it is included in a kit (YES), or has a material number, request one of these numbers. If not included in a kit (No), but has a Material Number, use Material Number.

Parts List & Kits CRN3-H

Pos. No.	Part Description	Model	Stages	No. Used	Comments/Dimensions	B.O.M. Ref. No.	Material No.	Included in kits ?			
PARTS LIST											
28	Motor Bolt		25	4	M12, ϕ 10,7 x 573mm	97683272		No			
			27	4	M12, ϕ 10,7 x 609mm, 4 pole & 50 Hz.	97683273		No			
			29	4	M12, ϕ 10,7 x 645mm, 4 pole & 50 Hz.	98284269		No			
			31	4	M12, ϕ 10,7 x 681mm, 4 pole & 50 Hz.	98284270		No			
			33	4	M12, ϕ 10,7 x 717mm, 4 pole & 50 Hz.	97683275		No			
			36	4	M12, ϕ 10,7 x 771mm, 4 pole & 50 Hz.	97683276		No			
			3/2-12	4	NEMA, 56C, 1/3 - 2HP. UNC 3/8" x 25mm	00ID1839		No			
			13-25	4	NEMA, 182/184TC, 3 - 5HPUNC1/2" x 25mm	00ID1840		No			
				4	NEMA, 213TC, 7.5 -10HP. UNC 1/2" x 1.25"	91128631		No			
28g	Bolt for foot Pos. 56a		3/2-36	2	M12 x 1.75 x 20mm, 316SS, Delta Tone/Seal	97672732		No			
36	Staybolt Nut		3/2-36	4	19mm x M12, 316SS	00ID0876		No			
37	Sleeve O-ring		3/2-36	◆◆	EPDM, ϕ 137.5 x 3.3mm	96438743		YES			
37b	Sleeve O-ring (option)		3/2-36	◆◆	FKM, ϕ 137.5 x 3.3mm	96438744		YES			
			3/2-36	◆◆	FXM, ϕ 137.5 x 3.3mm	96458109		YES			
			3/2-36	◆◆	FFKM, ϕ 136.12 x 3.53mm	96466718		YES			
45	Neck Ring		3/2-36	# stgs	ϕ 41.3 x ϕ 30.6 x .75mm, PTFE	400003		YES			
47a	Bearing Ring/Spacer Brg. Ring/Spacer (option for Grafkon Pos. 4a)		3/2-36	^^^^	SiC 150, ϕ 17.37 x ϕ 13.10 x ϕ 10.9 x 13mm	96437488		YES			
			3/2-36	^^^^	TC, ϕ 15.92 x ϕ 13.10 x ϕ 10.9 x 9.7mm	400041		YES			
49	Impeller		3/2-36	# stgs	ϕ 73.6 x ϕ 30.6 x 9.55mm (back-plate .5mm)	96433169	96547601	No			
			3/2-36	# stgs	96547601 has a qty. of 24	96433169		No			
49i	Impeller (Low NPSH option)		3/2-36	1	ϕ 73.0 x ϕ 35.0 x 13.2mm (back-plate 1.0mm)	96437503		No			
50a	Top Guide Vane Top Guide Vane Plate (option for destaging)		3-36	1		96457638		No			
			3/2	1		96478562		No			
51	Shaft, Complete		3/2-3	1	ϕ 12 x 160.5mm	96439607	96588198	No			
			4	1	ϕ 12 x 180.5mm	96440386	96588199	No			
			5	1	ϕ 12 x 196.5mm	96440387	96588230	No			
			6	1	ϕ 12 x 214.5mm	96440388		No			
			7	1	ϕ 12 x 234.5mm	96440389	96588231	No			
			8	1	ϕ 12 x 250.5mm	96440390		No			
			9	1	ϕ 12 x 268.5mm	96440391		No			
			10	1	ϕ 12 x 288.5mm	96440392		No			
			11	1	ϕ 12 x 304.5mm	96440393		No			
			12	1	ϕ 12 x 322.5mm	96440394	96588233	No			
			13	1	ϕ 12 x 342.5mm	96440395	96588234	No			
			15	1	ϕ 12 x 376.5mm	96440396	96588235	No			
			17	1	ϕ 12 x 412.5mm	96440398		No			
			19	1	ϕ 12 x 450.5mm	96440400		No			
			21	1	ϕ 12 x 484.5mm	96440401	96588236	No			
			23	1	ϕ 12 x 520.5mm	96440403		No			
			25	1	ϕ 12 x 556.5mm	96440405	96588237	No			
			27	1	ϕ 12 x 592.5mm, 4 pole & 50 Hz.	96440406		No			
			29	1	ϕ 12 x 628.5mm, 4 pole & 50 Hz.	96440407		No			
			31	1	ϕ 12 x 664.5mm, 4 pole & 50 Hz.	96440409		No			
			33	1	ϕ 12 x 700.5mm, 4 pole & 50 Hz.	96440410		No			
			36	1	ϕ 12 x 754.5mm, 4 pole & 50 Hz.	96440411	96588238	No			
				Shaft, Cpl. (Cool Top®, Back-to-Back & Tandem Seal option)		3/2-3	1	ϕ 12 x 265.5mm	96457560		No
						4	1	ϕ 12 x 285.5mm	96457561		No
						5	1	ϕ 12 x 301.5mm	96457562		No
						6	1	ϕ 12 x 319.5mm	96457563		No
						7	1	ϕ 12 x 339.5mm	96457564		No
8	1	ϕ 12 x 355.5mm				96457565		No			
9	1	ϕ 12 x 373.5mm				96457566		No			
10	1	ϕ 12 x 393.5mm				96457567		No			
11	1	ϕ 12 x 409.5mm				96457568		No			
12	1	ϕ 12 x 427.5mm				96457569		No			
13	1	ϕ 12 x 447.5mm				96457570		No			
15	1	ϕ 12 x 481.5mm				96457571		No			
17	1	ϕ 12 x 517.5mm				96457573		No			
19	1	ϕ 12 x 555.5mm				96457575		No			
21	1	ϕ 12 x 589.5mm				96457576		No			
23	1	ϕ 12 x 625.5mm				96457578		No			
25	1	ϕ 12 x 661.5mm				96457580		No			
27	1	ϕ 12 x 697.5mm, 4 pole & 50 Hz.				96457581		No			
29	1	ϕ 12 x 733.5mm, 4 pole & 50 Hz.				96457582		No			
31	1	ϕ 12 x 769.5mm, 4 pole & 50 Hz.				96457584		No			
33	1	ϕ 12 x 805.5mm, 4 pole & 50 Hz.	96457585		No						
36	1	ϕ 12 x 859.5mm, 4 pole & 50 Hz.	96457586		No						
55	Outer Sleeve		3/2-3	1	ϕ 138 x 44.6mm	96439996		No			
			4	1	ϕ 138 x 62.6mm	96440025		No			
			5	1	ϕ 138 x 80.6mm	96441528		No			

Due to part changes over time, all position numbers (1-203) may not be used.

This column indicates which model uses the spare part. If blank, the part is used in all models.

B.O.M. Ref. Number is only available if it is not included in a kit or does not have a material number listed. If it is included in a kit (YES), or has a material number, request one of these numbers. If not included in a kit (No), but has a Material Number, use Material Number.

Parts List & Kits CRN3-H

Pos. No.	Part Description	Model	Stages	No. Used	Comments/Dimensions	B.O.M. Ref. No.	Material No.	Included in kits ?
PARTS LIST								
55	Outer Sleeve <i>(Continued)</i>		6	1	ø138 x 98.6mm	96440014		No
			7	1	ø138 x 116.6mm	96441529		No
			8	1	ø138 x 134.6mm	96441531		No
			9	1	ø138 x 152.6mm	96440015		No
			10	1	ø138 x 170.6mm	96441532		No
			11	1	ø138 x 188.6mm	96441534		No
			12	1	ø138 x 206.6mm	96440016		No
			13	1	ø138 x 224.6mm	96441535		No
			15	1	ø138 x 260.6mm	96440017		No
			17	1	ø138 x 296.6mm	96441538		No
			19	1	ø138 x 332.6mm	96441539		No
			21	1	ø138 x 368.6mm	96440019		No
			23	1	ø138 x 404.6mm	96441542		No
			25	1	ø138 x 440.6mm	96441543		No
			27	1	ø138 x 476.6mm, 4 pole & 50 Hz.	96440021		No
			29	1	ø138 x 512.6mm, 4 pole & 50 Hz.	96441544		No
			31	1	ø138 x 548.6mm, 4 pole & 50 Hz.	96441545		No
			33	1	ø138 x 584.6mm, 4 pole & 50 Hz.	96440023		No
			36	1	ø138 x 638.6mm, 4 pole & 50 Hz.	96439997		No
		55b	Sleeve flange		3/2-36	1	Cast stainless Din 1.4408 (316C16)	96834154
56a	Foot for Pos. 6 Cast Iron		3/2-36	1	H=43mm, W=196mm, ø16mm hole CL 152mm, CI	95922025		No
	Foot for Pos. 6 Stainless Steel option for GI		3/2-36	1	H=43mm, W=196mm, ø16mm hole CL 152mm, SS	95922078		No
56b(d)	Washer for bolt Pos. 56c		3/2-36	16	M8, ø16 x ø8.4x 1.6mm, 316 SS	97672740		No
56c	Bolt for sleeve flange Pos. 55b		3/2-36	8	M8x1.25-6g x45mm, 316 SS, Delta Tone/Seal	97672731		No
56e	Nut for bolt Pos. 56c		3/2-36	8	M8, NV13 x1.25-6H 316 SS, DeltaTone/Seal	97672737		No
56f	Bolt for base Pos. 90	56C/182TC	3/2-36	2	Hex Hd.1/2 -13 UNC x 1" SAE 5, Zinc plated			YES
56g	Washer for bolt Pos. 56f		3/2-36	2	1/2" SAE, Zinc plated			YES
60	Stack Compression Spring		3/2-36	1	ø136 x 3.5mm	96439662		No
64	Spacing Pipe		2-36	^^^	ø15.85 x ø12.85 x 17.52mm	400035	95061339	No
64a	Spacing Pipe		3/2-36	^^^^	ø15.85 x ø12.85 x 4.5mm	96440292		YES
	Spacing Pipe (option for Grafalon Pos. 4a)		3/2-36	^^^^	Use with TC Pos.47a, ø15 x ø12.7 x 7.8mm	400016		YES
64c	Clamp, Splined		3/2-36	1	ø15 x ø13.10 x ø10.9 x 13mm	96439668		YES
65	Neck Ring Retainer		3/2-36	# stgs	ø43.5 x ø34.0 x 3.6mm	96438746		YES
66	Lock Washer Set for Shaft		3/2-36	1	ø13.5 x ø8.2 x 2.6mm	96417297		YES
66a	Washer for Staybolt		3/2-36	4	DIN 125A, 304SS, ø24 x ø13 x 2.5mm	00ID3103		No
67	Lock Nut for Shaft		3/2-36	1	13mm x M8	00ID2061		YES
69	Spacing Pipe		3/2	1	ø15.85 x 12.85 x 18.0mm	400125	95061443	No
72a	Sleeve Flange O-ring		3/2-36	1	EPDM, ø137.5 x 3.3mm	96438743	97683277	YES
			3/2-36	1	FKM, ø137.5 x 3.3mm	96438744	97683278	YES
			3/2-36	1	FXM, ø137.5 x 3.3mm	96458109	97683279	YES
	Sleeve Flange O-ring (option)		3/2-36	1	FFKM, ø136.12 x 3.53mm	96466718	97683280	YES
76	Nameplate		3/2-36	1	304SS, 60 x 45mm	96439820		No
76a	Rivet for Nameplate		3/2-36	2	304SS, ø3 x 5mm	96022882		No
77	Pump Head Cover for Motor Stool Pos. 2		3/2-36	1	Cast Stainless	96436340		No
77a	Pump Head Cover for Back-to-Back & Tandem Seal		3/2-36	1	Cast Stainless	96456293		No
77a	Pump Head Cover for Cool Top® (option)		3/2-36	1	Cast Stainless	96456294		No
79	Disc / Plate for Cool Top®		3/2-36	1	Stainless	96456296		No
90	Main Support Baseplate	GA	3/2-17	1	BP. Cpl.139, L=991mm x W=305mm x H=106.5mm	96956336		YES
	Main Support Baseplate - Longer versions	GA	19-25	1	XLBP1 (139), L=1500mmxW=381mmxH=106.5mm	96956376		YES
90a	Bolt for motor to slider Pos. 90b	56C	3/2-12	4	Hex Head 5/16 -18 UNC x .75" SAE 5, Zinc plated			YES
		182TC	13-25	4	Hex Head 3/8 -16 UNC x .5" SAE 5, Zinc plated			YES
90b	Motor support /slide rail	56C	3/2-12	2	BP139, L=204mm x H=45.5mm x W=25.4mm	96956339		YES
		182TC	13-25	2	BP139, L=230mm x H=23.0mm x W=25.4mm	96956338		YES
90c	Support Bracket for Pump Cartridge		3/2-36	1	304 SS, H=74mm CL of hole, GA	95131235		No
90d	Bolt for motor slide rail Pos. 90b to base Pos. 90	56C	3/2-12	4	Hex Head 1/4 -20 UNC x 1" SAE 5, Zinc plated			YES
		182TC	13-25	4	Hex Head 1/4-20 UNC x1.75" SAE 5, Zinc plated			YES
90f	Washer for motor bolt Pos. 90a to slide rail Pos. 90b	56C	3/2-12	4	5/16" SAE, Zinc plated			YES
		182TC	13-25	4	3/8" SAE, Zinc plated			YES
100	Priming/Vent Plug O-ring		3/2-36	■	EPDM, ø16.3 x 2.4mm	00ID1288		YES
			3/2-36	■	FKM, ø16.3 x 2.4mm	00ID2231		YES
100(a)	Priming/Vent Plug O-ring (option)		3/2-36	■	FFKM, ø16.3 x 2.4mm	96428162		YES
			3/2-36	■	FXM, ø16.3 x 2.4mm	96442869		YES
102	O-ring for Pos. 105b Back-to-Back		3/2-36	1	EPDM, ø18 x 2.5mm	00ID2041		YES
			3/2-36	1	FKM, ø17.86 x 2.62mm	00ID2187		YES
			3/2-36	1	FFKM, ø17.86 x 2.62mm	96440281		No
			3/2-36	1	FXM, ø17.86 x 2.62mm	96472584		No
103	Stationary Seal Ring for 105b Back-to-Back		3/2-36	1	TC, 12mm	980190		No
103	Stationary Seal Ring for 105b Back-to-Back (opt.)		3/2-36	1	SiC, 12mm	980746		YES
104	Rotating Seal Ring for 105b Back-to-Back		3/2-36	1	TC, 12mm	980163		No
	Rotating Seal Ring for 105b Back-to-Back (opt.)		3/2-36	1	SiC, 12mm	980733		YES

Due to part changes over time, all position numbers (1-203) may not be used.

This column indicates which model uses the spare part. If blank, the part is used in all models.

B.O.M. Ref. Number is only available if it is not included in a kit or does not have a material number listed. If it is included in a kit (YES), or has a material number, request one of these numbers. If not included in a kit (No), but has a Material Number, use Material Number.

Parts List & Kits CRN3-H

Pos. No.	Part Description	Model	Stages	No. Used	Comments/Dimensions	B.O.M. Ref. No.	Material No.	Included in kits ?
PARTS LIST								
105(b)	Shaft Seal HQBE		3/2-36	***	SiC, Carbon with resin-impregnated, EPDM	96441879		YES
	Shaft Seal HQBV		3/2-36	***	SiC, Carbon with resin-impregnated, FKM	96441880		YES
	Shaft Seal HQBK (option)		3/2-36	***	SiC, Carbon with resin-impregnated, FFKM	96489537		YES
	Shaft Seal HQQE		3/2-36	***	SiC, SiC, EPDM	96441877		YES
	Shaft Seal HQQV		3/2-36	***	SiC, SiC, FKM	96441878		YES
	Shaft Seal HQQF (option)		3/2-36	***	SiC, SiC, FXM	96472620		YES
	Shaft Seal HQQK (option)		3/2-36	***	SiC, SiC, FFKM	96464381		YES
	Shaft Seal HUBE		3/2-36	***	TC, Carbon with resin-impregnated, EPDM	96441873		YES
	Shaft Seal HUBV		3/2-36	***	TC, Carbon with resin-impregnated, FKM	96441874		YES
	Shaft Seal HUBF (option)		3/2-36	***	TC, Carbon with resin-impregnated, FXM	96481464		YES
	Shaft Seal HUBK (option)		3/2-36	***	TC, Carbon with resin-impregnated, FFKM	96481463		YES
	Shaft Seal HUUE		3/2-36	***	TC, TC, EPDM	96441875		YES
	Shaft Seal HUUV		3/2-36	***	TC, TC, FKM	96441876		YES
	Shaft Seal HUUF (option)		3/2-36	***	TC, TC, FXM	96475542		YES
	Shaft Seal HUUK (option)		3/2-36	***	TC, TC, FFKM	96467885		YES
105b	Shaft Seal/inboard for Back-to-Back OQQE		3/2-36	1	SiC, SiC, EPDM	985200		YES
	Shaft Seal/inboard for Back-to-Back OQQV		3/2-36	1	SiC, SiC, FKM	985760		YES
	Shaft Seal/inboard for Back-to-Back OUUE		3/2-36	1	TC, TC, EPDM	985189	405145	YES
	Shaft Seal/inboard for Back-to-Back OUUV		3/2-36	1	TC, TC, FKM	985190	405145	YES
107	O-ring for Pos. 105b Back-to-Back		3/2-36	1	EPDM, ϕ 11.5 x 4.3mm	00ID2040		YES
			3/2-36	1	FKM, ϕ 11.5 x 4.3mm	00ID2186		YES
	O-ring for Pos. 105b Back-to-Back (option)		3/2-36	1	FFKM, ϕ 11.5 x 4.3mm	96440282		No
			3/2-36	1	FXM, ϕ 11.5 x 3.18mm	96472618		No
108	Spring for Pos. 105b Back-to-Back		3/2-36	1	12mm	980195		YES
109(a)	O-ring for Shaft Seal Pos. 105		3/2-36	1	EPDM, ϕ 21.3 x 3.0mm	00ID1798		YES
			3/2-36	1	FKM, ϕ 21.2 x 3.0mm	00ID2339		YES
109b	O-ring for Shaft Seal Pos. 105 (option)		3/2-36	1	FXM, ϕ 22 x 2.75mm	96458111		YES
			3/2-36	1	FFKM, ϕ 23.47 x 2.62mm	96464384		YES
111	Seal Driver (small) for Pos. 105b Back-to-Back		3/2-36	1		980192		YES
112	Seal Driver (large) for Pos. 105b Back-to-Back		3/2-36	1		980191		YES
112a	Seal Drv threaded for 112, Pos. 105b Back-to-Back		3/2-36	1		400203		YES
113	Set Screw for 112a, for Pos. 105b Back-to-Back		3/2-36	1	3mm x M5 x 6mm	00ID7392		YES
117	Air Vent Pipe for 118		3/2-36	1	G1/2, 316SS, 60 x 43mm	96525189		YES
117a	Counter Nut for Pipe 117		3/2-36	1	NV24, internal G1/2, 316SS	96506709		YES
118	Air Vent		3/2-36	1	Air vent type 1511-AV - 5/6430	96427483		YES
146	Allen Bolt for 147/148, for Pos. 105b Back-to-Back		3/2-36	1	2.5mm x M3 x 5mm	96462639		YES
147	Stationary Seal Retainer - Pos. 105b Back-to-Back		3/2-36	1	NV36, 316SS	96457354		No
148	Seal Retainer Washer - Pos. 105b Back-to-Back		3/2-36	1	316SS, ϕ 36.0 x ϕ 21.6 x 5.0mm	96457355		No
149	Connecting Pipe for Cool Top®		3/2-36	1	NV36, 316SS, FXM & EPDM	96460414		No
			3/2-36	1	NV36, 316SS, FXM & FKM	96460415		No
149a	Retainer for bushing		3/2-36	1	316SS, ϕ 22.0 x ϕ 17.0 x 9mm	96457639		YES
149b	Bushing		3/2-36	1	Graflon®, ϕ 21.2 x ϕ 12.4 x 53mm	96456297		YES
149c	Connecting Pipe less 109 a&b and 149 a&b		3/2-36	1	NV36, 316SS	96456295		YES
201	Flange, Suction, Cast Iron		3/2-15	1	1.5" 150#, 4x1/2"-13 UNC threaded flange, e-c	96922828		No
			3/2-36	1	1.5" 300#, 4x3/4"-10 UNC threaded flange, e-c	96956145		No
	Flange, Suction, Stainless Steel option for GI		3/2-15	1	1.5" 150#, 4x1/2"-13 UNC threaded flange	97644306		No
			3/2-36	1	1.5" 300#, 4x3/4"-10 UNC threaded flange	97644307		No
201a	Flange, Discharge, Cast Iron		3/2-15	1	1" 150#, 4x1/2"-13 UNC threaded flange, e-coat	96922827		No
			3/2-36	1	1" 300#, 4x5/8"-11 UNC threaded flange, e-coat	96956144		No
	Flange, Discharge, Stainless Steel option for GI		3/2-15	1	1" 150#, 4x1/2"-13 UNC threaded flange	97644302		No
			3/2-36	1	1" 300#, 4x3/4"-10 UNC threaded flange	97644304		No
203	Retaining ring for 201, 1.5" flange		3/2-36	1	Stainless, ϕ 72.6 x 5	96475395		No
203a	Retaining ring for 201a, 1.0" flange		3/2-36	1	Stainless, ϕ 53.6 x 3.2	96439718		No

Due to part changes over time, all position numbers (1-203) may not be used.

This column indicates which model uses the spare part. If blank, the part is used in all models.

B.O.M. Ref. Number is only available if it is not included in a kit or does not have a material number listed. If it is included in a kit (YES), or has a material number, request one of these numbers. If not included in a kit (No), but has a Material Number, use Material Number.

Notes:

The first number is total number of impellers. An exception to this format is the CRN3-2H. **Example: a CRN3-2H is actually a CRN3-3/2H, it has 3 chambers and 2 impellers (de-staged by 1) - it uses a 3 stage shaft.**

- ^^^ 3/2 to 9 stage= # of Stages less 2
10 to 19 stage= # of stages less 3
21 to 27 stage = # of stages less 4
29 to 36 stage = # of stages less 5
Exception: When de-staging pump by 2 impellers, replace top chamber Pos. 4 with Pos. 5a
- ^^^^ 3/2 to 9 stage= use 1
10 to 19 stage= use 2
21 to 27 stage = use 3
29 to 36 stage = use 4
- * Standard use 1. Back-to-Back or Tandem pump version use 3
- ** Standard use 1. Back-to-Back or Tandem pump version use 3
- *** 1 used in Hxxx (Standard), 2 used in Pxxx (Tandem) pump version
- ◆◆ Standard use 2. Back-to-Back or Tandem pump version use 3
- Standard use 2. Back-to-Back or Tandem pump version use 6
- 1* Standard use 1. When de-staging pump by 2 impellers, replace top chamber Pos. 4 with an additional Pos. 5a

Key to Symbols:

KITS	Recommended spare part
∅	Diameter
ANSI	American National Standards Institute
CPL	Complete Assembly – these parts consist of more than one component
EPDM	Ethylene Propylene (also known as EPR and EPT) – an elastic substance similar to rubber
FFKM	Kalrez Elastomer made by DuPont
FKM	Fluoro Elastomer (generic for Viton)
FXM	Fluoraz Elastomer made by Greene Tweed
M	International standard thread size designation (thread diameter in mm)
mm	Millimeter
MG	Identifies Grundfos motor type/size
N	Stainless
NBR	Buna - N (also known as Nitrile) – an elastic substance similar to rubber
NEMA	National Electrical Manufacturers Association
PTFE	Teflon
SiC	Silicon Carbide
TC	Tungsten Carbide
UNC	Unified National Coarse – a standard for threads on bolts

Spare Part Kits CRN3-H

Spare Part Kits

Since certain pump parts can be expected to exhibit wear at the same time as related pump parts, they have been grouped into the following kits for your convenience. The numbers indicate the quantity of the part within each kit. Please order these kits using the kit material number at the top of the columns.

CR(I, N)15, 1, & 3 SiC Bearing		Kit No. 96455095				
WEAR PARTS KIT 2-9		Kit No. 96455092				
WEAR PARTS KIT 10-19		Kit No. 96455093				
WEAR PARTS KIT 20-27		Kit No. 96455094				
WEAR PARTS KIT 28-36		Kit No. 96455094				
Pos. No.	Description	Material No.	Qty. Included in each Kit			
4a	Chamber N Cpl. w/Pos.45 & 65 & SiC Bearing	96439476	1	2	3	4
39	Gasket for Oval Flange, 95 x 55 x ø35 x 2mm	400189	2	2	2	2
45	Neck Ring, ø41.3 x ø30.6 x .75mm, PTFE	400003	8	17	24	32
47a	Bearing Ring/Spacer, SiC 150, 13mm	96437488	1	2	3	4
64a	Spacing Pipe, ø15.85 x ø12.85 x 4.5mm	96440292	1	2	3	4
64c	Clamp, Splined, ø15 x ø13.10 x ø10.9 x 13mm	96439668	1	1	1	1
65	Neck Ring Retainer, N, ø43.5 x ø34.0 x 3.6mm	96438746	8	17	24	32
66	Lock Washer Set of 2, ø13.5 x ø8.2 x 2.6mm	96417297	1	1	1	1
67	Lock Nut, 13mm x M8	00ID2061	1	1	1	1

CR(I, N)15, 1, & 3 Graflon Bearing		Kit No. 96460140				
WEAR PARTS KIT 2-9		Kit No. 96455110				
WEAR PARTS KIT 10-19		Kit No. 96455111				
WEAR PARTS KIT 20-27		Kit No. 96455112				
WEAR PARTS KIT 28-36		Kit No. 96455112				
Pos. No.	Description	Material No.	Qty. Included in each Kit			
4a	Chamber N Cpl. w/Pos.45 & 65 & Graflon Brg.	96440615	1	2	3	4
39	Gasket for Oval Flange, 95 x 55 x ø35 x 2mm	400189	2	2	2	2
45	Neck Ring, ø41.3 x ø30.6 x .75mm, PTFE	400003	8	17	24	32
47a	Bearing Ring/Spacer, TC, 9.7mm	400041	1	2	3	4
64a	Spacing Pipe, ø15.85 x ø12.85 x 7.8mm	400016	1	2	3	4
64c	Clamp, Splined, ø15 x ø13.10 x ø10.9 x 13mm	96439668	1	1	1	1
65	Neck Ring Retainer, N, ø43.5 x ø34.0 x 3.6mm	96438746	8	17	24	32
66	Lock Washer Set of 2, ø13.5 x ø8.2 x 2.6mm	96417297	1	1	1	1
67	Lock Nut, 13mm x M8	00ID2061	1	1	1	1

STANDARD SHAFT SEAL KIT, BALANCED CARTRIDGE		Kit No. 96455088							
(Maximum allowed working PSI is 435)		Kit No. 96491375							
(Tandem Seal option Pumps require 2 of each Seal Kit)		Kit No. 96455089							
		Kit No. 96455086							
		Kit No. 96533327							
		Kit No. 96533326							
		Kit No. 96455087							
Pos. No.	Description	Material No.	Qty. Included in each Kit						
105	HQBE	96441879	1						
	HQBK	96489537		1					
	HQBV	96441880			1				
	HQQE	96441877				1			
	HQQF	96472620					1		
	HQQK	96498109						1	
	HQQV	96441878							1
N/A	Grinding Device Tool for Emery Cloth	370711	1	1	1	1	1	1	1
N/A	Emery Cloth	370712	1	1	1	1	1	1	1

OPTIONAL SHAFT SEAL KIT, BALANCED CARTRIDGE		Kit No. 96455082							
(Maximum allowed working PSI is 435)		Kit No. 96533323							
(Tandem Seal option Pumps require 2 of each Seal Kit)		Kit No. 96533322							
		Kit No. 96455083							
		Kit No. 96455084							
		Kit No. 96533325							
		Kit No. 96533324							
		Kit No. 96455085							
Pos. No.	Description	Material No.	Qty. Included in each Kit						
105	HUBE	96441873	1						
	HUBF	96481464		1					
	HUBK	96481463			1				
	HUBV	96441874				1			
	HUUE	96441875					1		
	HUUF	96475542						1	
	HUUK	96498108							1
	HUUV	96441876							1
N/A	Grinding Device Tool for Emery Cloth	370711	1	1	1	1	1	1	1
N/A	Emery Cloth	370712	1	1	1	1	1	1	1

STACK KITS	
Model	Material No.
CRN3-3/2	96453552
CRN3-3	96453553
CRN3-4	96453554
CRN3-5	96453555
CRN3-6	96453556
CRN3-7	96453557
CRN3-8	96453558
CRN3-9	96453559
CRN3-10	96453560
CRN3-11	96453561
CRN3-12	96453562
CRN3-13	96453563
CRN3-15	96453564
CRN3-17	96453565
CRN3-19	96453566
CRN3-21	96453567
CRN3-23	96453568
CRN3-25	96453569
CRN3-27	96453570
*** CRN3-29	96453571
*** CRN3-31	96453572
*** CRN3-33	96453573
CRN3-36	96453574

***For 4 pole & 50 Hz operation only.

Spare Part Kits (continued)

INBOARD SHAFT SEAL & Gasket KIT, Back to Back OQQE		Kit No.	96533360		
INBOARD SHAFT SEAL & Gasket KIT, Back to Back OQQV		Kit No.	96533361		
INBOARD SHAFT SEAL & Gasket KIT, Back to Back OQQW		Kit No.	96989183		
INBOARD SHAFT SEAL & Gasket KIT, Back to Back OQQX		Kit No.	96536168		
INBOARD SHAFT SEAL & Gasket KIT, Back to Back OQQY/V		Kit No.	405145		
(An HQQX or HUUx seal kit must also be used for respectively to complete seal repairs)					
Pos. No.	Description	Material No.	Qty. Included in each Kit		
37	Sleeve O-ring, EPDM, $\phi 137.5 \times 3.3$ mm	96438743	3		
	Sleeve O-ring, FKM, $\phi 137.5 \times 3.3$ mm	96438744		3	
38, 100(a)	Drain Plug O-ring, EPDM, $\phi 16.3 \times 2.4$ mm	00ID1288	7		
	Drain Plug O-ring, FKM, $\phi 16.3 \times 2.4$ mm	00ID2231		7	
102	O-ring, EPDM, $\phi 18 \times 2.5$ mm	00ID2041	1		1
	O-ring, FKM, $\phi 17.86 \times 2.62$ mm	00ID2187		1	1
	O-ring, FFKM, $\phi 17.86 \times 2.62$ mm	96440281			1
103	Stationary Seal Ring, SiC, 12mm	980746	1		
	Stationary Seal Ring, TC, 12mm	980190			1
104	Rotating Seal Ring, SiC, 12mm	980733	1	1	1
	Rotating Seal Ring, TC, 12mm	989163			1
107	O-ring, EPDM, $\phi 11.5 \times 4.3$ mm	00ID2040	1		1
	O-ring, FKM, $\phi 11.5 \times 4.3$ mm	00ID2186		1	1
	O-ring, FFKM, $\phi 11.5 \times 4.3$ mm	96440282			1
108	Spring, 12mm	980195	1	1	1
109a	O-ring, EPDM, $\phi 21.3 \times 3.0$ mm	00ID1798	1		
	O-ring, FKM, $\phi 21.2 \times 3.0$ mm	00ID2339		1	
	O-ring, FFKM, $\phi 23.47 \times 2.62$ mm	96464384			1
111	Driver for pos.104	980192	1	1	1
112	Driver for pos.111	980191	1	1	1
112a	Driver for pos.112	400203	1	1	1
113	Set Screw for pos.112a	00ID7392	2	2	2
146	Allen Bolt for pos.147 & 148, 2.5mm x M3 x 5mm	96462639	3	3	3
147	Stationary Seal Retainer - NV36, 316SS	96457354		1	1
148	Seal Retainer Washer -316SS, $\phi 36.0 \times \phi 21.6 \times 5.0$ mm	96457355		1	1
N/A	Grinding Device Tool for Emery Cloth	370711			1
N/A	Emery Cloth	370712			1

GASKET KIT (EPDM)		Kit No.	96455090		
GASKET KIT (FKM)		Kit No.	96455091		
GASKET KIT (FKM)		Kit No.	96463944		
GASKET KIT (FFKM)		Kit No.	96533328		
GASKET KIT (EPDM)-Double Seal option.		Kit No.	96533362		
GASKET KIT (FKM)-Double Seal option.		Kit No.	96533363		
GASKET KIT (FFKM)-Double Seal option.		Kit No.	96533364		
GASKET KIT (FKM, & EPDM) - Cool-Top option		Kit No.	96533329		
Pos. No.	Description	Material No.	Qty. Included in each Kit		
37	Sleeve O-ring, EPDM, $\phi 137.5 \times 3.3$ mm	96438743	2		3
	Sleeve O-ring, FKM, $\phi 137.5 \times 3.3$ mm	96438744		2	3
37b	Sleeve O-ring, FXM, $\phi 137.5 \times 3.3$ mm	96458109		2	
	Sleeve O-ring, FFKM, $\phi 136.12 \times 3.53$ mm	96466718		2	3
38, 100(a)	Drain Plug O-ring, EPDM, $\phi 16.3 \times 2.4$ mm	00ID1288	3		7
	Drain Plug O-ring, FKM, $\phi 16.3 \times 2.4$ mm	00ID2231		3	7
38, 100a	Drain Plug O-ring, FXM, $\phi 16.3 \times 2.4$ mm	96442869		3	
	Drain Plug O-ring, FFKM, $\phi 16.3 \times 2.4$ mm	96428162		3	7
109(a)	O-ring for Pos.105(b) & 149, EPDM, $\phi 21.3 \times 3.0$ mm	00ID1798	1		1
	O-ring for Pos.105(b) & 149, FKM, $\phi 21.2 \times 3.0$ mm	00ID2339		1	1
109b	O-ring for Pos.105(b) & 149, FXM, $\phi 22.0 \times 2.75$ mm	96458111		1	2
	O-ring for Pos.105(b) & 149, FFKM, $\phi 23.47 \times 2.62$ mm	96464384		1	2

Add to above standard gaskets to complete desired CRH, CRNH model

Kit, O-ring EPDM CRN-H1s to 5		Kit No.	97683277		
Kit, O-ring FKM CRN-H1s to 5		Kit No.	97683278		
Kit, O-ring FXM CRN-H1s to 5		Kit No.	97683279		
Kit, O-ring FFKM CRN-H1s to 5		Kit No.	97683280		
Pos. No.	Description	Material No.	Qty. Included in each Kit		
72a	O-ring EPDM $\phi 145.6 \times 3.5$ mm 2-256	97644314	1		
	O-ring FKM $\phi 145.6 \times 3.5$ mm 2-256	97672715		1	
	O-ring FXM $\phi 145.6 \times 3.5$ mm 2-256	97672716			1
	O-ring FFKM $\phi 145.6 \times 3.5$ mm 2-256	97672717			1

NEMA COUPLING KIT					
$\phi 15.8/\phi 12$		Kit No.	415314		
$\phi 28.5/\phi 12$		Kit No.	415315		
$\phi 34.9/\phi 12$		Kit No.	96478700		
Pos. No.	Description	Material No.	Qty. Included in each Kit		
9	Allen Screw, M6 x 20mm, Delta Seal	00ID7899	4		
	Allen Screw, M8 x 25mm, Delta Seal	00ID7900		4	
	Allen Screw, M10 x 25mm, Delta Seal	00ID7901			
10	Shaft Pin, $\phi 5 \times 26$ mm, Stainless	310192	1	1	1
10a	Coupling Half, 56C, 1/3 - 2HP, $\phi 15.8 / \phi 12$	410108	2		
	Coupling Half, 182/184TC, 3-5HP, $\phi 28.5/\phi 12$	410109		2	
	Coupling Half, 213TC, 7.5-10HP, $\phi 34.9/\phi 12$	96472175			2

Spare Part Kits • Accessories CRN3-H

Spare Part Kits (continued)

COUPLING GUARD KIT				
NEMA 56C, 1/3-2HP		Kit No. 96505131		
NEMA 182-215TC, 3-10HP		Kit No. 96505132		
Pos. No.	Description	Material No.	Qty. Included in each Kit	
7	Coupling Guard, W=127mm x H=90.5mm	96438137	2	
	Coupling Guard, W=157mm x H=171mm	96438138		2
7a	Screw comb.slot torx/straight slot 4 x 8mm	96488481	4	4

Air Vent Kit - Horizontal Units				
CR-H, CRN-H15 to 20		Kit No. 91136720		
Pos. No.	Description	Material No.	Qty. Included in each Kit	
117	Air Vent Pipe, short for 118, G1/2, 60x43	96525189	1	
117a	Counter Nut for Pipe 117, G1/2	96506709	2	
118	Air vent type 1511-AV - 5/6430	96427483	1	

Connecting Pipe for Cool Top				
(EPDM, FKM & FXM)		Kit No. 96578704		
Pos. No.	Description	Material No.	Qty. Included in each Kit	
109a	O-ring for Pos.105(b) & 149, EPDM, Ø21.3 x 3.0mm	00ID1798	1	
	O-ring for Pos.105(b) & 149, FKM, Ø21.2 x 3.0mm	00ID2339	1	
109b	O-ring for Pos.105(b) & 149, FXM, Ø22.0 x 2.75mm	96458111	1	
149a	Retainer for bushing, 316SS, ø22.0 x ø17.0 x 9mm	96457639	1	
149b	Bushing, Graflon®, ø21.2 x ø12.4 x 53mm	96456297	1	
149c	Connecting pipe, NV36, 316SS	96456295	1	

Accessories

ANSI COMPANION FLANGES FOR CR-H, CRN-H15 to 20				
1-1/2" and 1" Threaded Stainless, 150 Lb. Class		Kit No. 97698645		
Pos. No.	Description	Material No.	Qty. Included in each Kit	
N/A	Hex Head Cap Screw/Bolt 1/2"-13X 2" 316SS	97743748	8	
N/A	Flange ANSI #150 1.5" NPT 316SS	96983498	1	
N/A	Flange ANSI #150 1" NPT 316SS	96983497	1	
N/A	Gasket 1 1/2" Full Face 150 Lb. ANSI	97694409	1	
N/A	Gasket 1" Full Face 150 Lb. ANSI	97692916	1	

ANSI COMPANION FLANGES FOR SMALL CR				
1-1/2" and 1" Threaded Stainless, 300 Lb. Class		Kit No. 97698646		
Pos. No.	Description	Material No.	Qty. Included in each Kit	
N/A	Hex Head Cap Screw/Bolt 3/4"-10 X 2.5" 316SS	91143035	4	
N/A	Hex Head Cap Screw/Bolt 5/8"-11 X 2.25" 316SS	91143029	4	
N/A	Flange ANSI #300 1.5" NPT 316SS	96983496	1	
N/A	Flange ANSI #300 1" NPT 316SS	96983495	1	
N/A	Gasket 1 1/2" Full Face 300 Lb. ANSI	97694408	1	
N/A	Gasket 1" Full Face 300 Lb. ANSI	97694407	1	

Baseplate Kit				
139 56C for GA		Kit No. 97534517		
182TC for GA		Kit No. 97534518		
XLBP1 56C for GA		Kit No. 97534573		
182TC for GA		Kit No. 97534574		
Pos. No.	Description	Material No.	Qty. Included in each Kit	
90	Baseplate Cpl. 139, L=991" x W=305" x H=106.5"	96956336	1	1
	Baseplate Cpl. XLBP1, L=1500" x W=305" x H=106.5"	96956376		1
N/A	Slider & fasteners for 56C (consists of slider & hardware)	96983855	1	1
N/A	Slider & fastner for 182TC (consists of slider & hardware)	96983858	1	1
N/A	Hardware Kit -96983855/68/78(cont. pos.56f, g, 90a,d& f)**	97501470	1	1
N/A	Hardware Kit -96983858 (cont. pos.56f & g, 90a, d & f)**	97501481	1	1
56f	Bolt, Hex Head 1/2-13 UNC x 1" SAE 5, Zinc plated	N/A	2	2
56g	Washer, 1/2" SAE, Zinc plated	N/A	2	2
90a	Bolt, Hex Head 5/16-18 UNC x .75" SAE 5, Zinc plated	N/A	4	4
	Bolt, Hex Head 3/8-16 UNC x .5" SAE 5, Zinc plated	N/A	4	4
90b	Slider, GA/B/C 56C/139BP, L=204" x H=45.5" x W=25.4"	96956339	2	2
	Slider, GA/B/C 182TC/139 BP, L=230" x H=23" x W=25.4"	96956338	2	2
90d	Bolt, Hex Head 1/4-20 UNC x 1" SAE 5, Zinc plated	N/A	4	4
	Bolt, Hex Head 1/4-20 UNC x 1.75" SAE 5, Zinc plated	N/A	4	4
90f	Washer, 5/16" SAE, Zinc plated	N/A	4	4
	Washer, 3/8" SAE, Zinc plated	N/A	4	4







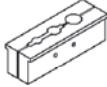

* Values in mm, Length (L) is +/- 2mm, Height (H) is +/- 1mm, Width (W). ** Hardware kits 97501470 and 81 are also available for sale.

Baseplate Kit				
148 213TC for GA		Kit No. 97534520		
XLBP2 213TC for GA		Kit No. 9753875		
Pos. No.	Description	Material No.	Qty. Included in each Kit	
90	Baseplate Cpl. 148, L=1219" x W=381" x H=107.9"	96956346	1	1
	Baseplate Cpl. XLBP2, L=1777.8" x W=381" x H=107.9"	96956377		1
N/A	Slider & fasteners for 213TC (consists of slider & hardware)	96983859	1	1
N/A	Hardware Kit -96983859 (consists of pos.56f, g, 90a,d& f)**	97501482	1	1
56f	Bolt, Hex Head 1/2-13 UNC x 1.25" SAE 5, Zinc plated	N/A	2	2
56g	Washer, 1/2" SAE, Zinc plated	N/A	2	2
90a	Bolt, Hex Head 3/8-16 UNC x 5/8" SAE 5, Zinc plated	N/A	4	4
90b	Slider, GA/B/C 213TC/148BP, L=252" x H=20" x W=25.4"	96956347	2	2
90d	Bolt, Hex Head 1/4-20 UNC x 1.75" SAE 5, Zinc plated	N/A	4	4
90f	Washer, 3/8" SAE, Zinc plated	N/A	4	4

* Values in mm, Length (L) is +/- 2mm, Height (H) is +/- 1mm, Width (W). ** Hardware kits 97501482 is also available for sale.

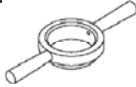





Special Tools

Tools not generally available from normal sources.

Mat. No.	Description and Use	
00SV0040	Shaft Holder for Dismantling/Assembly Used to hold and protect the shaft during dismantling and assembly.	
00SV2007	Tubular Box Spanner for Shaft Seal 36.1 mm Used to install and remove the shaft seal. Fits a 1/2" drive ratchet.	
00SV0239	Puller for Neck Ring Used to remove the Neck Ring from Chamber.	
00SV2014	Circlip Pliers for Flange Lock Ring Used to remove the Lock Ring for the Flange.	
00SV2066	Tool for Outer Sleeve Used to press sleeve into base. (optional)	
00SV2011	Bit Holder Used with Bits Kit, 1/4"	
00SV2010	Bits Kit NV 5 mm for M6, 1/4" NV 6 mm for M8, 1/4" NV 8 mm for M10, 1/4"	
00SV2012	Hexagon Socket Bit Used for Shaft Seal NV 2.5 mm for M5, 1/4"	

Standard Tools

In addition to being available from Grundfos, comparable tools can be purchased through normal sources.

Mat. No.	Description and Use	
00SV0083 00SV0055 00SV0056 00SV0054 00SV0122	Wrenches Used to tighten various nuts. NV 10 mm for M6 NV 13 mm for M8 NV 17 mm for M10 NV 19 mm for M12 NV 24 mm for M16	
00SV0292 00SV0269 00SV0400	Torque Wrench Used to torque various screws. 4-20 Nm, 9 x 12 20-100 Nm, 9 x 12 40-200 Nm, 14x18	
00SV0438	Torque Screwdriver Used to tighten various nuts. 1-6 Nm, 1/4"	
00SV0295	Ratchet Spanner for all Adapters 9 mm x 12 mm, 1/2"	
00SV0296 00SV0297 00SV0298	Socket Spanner with Inside Hex NV 5 mm for M6, 1/2" x 1/2" NV 6 mm for M8, 1/2" x 1/2" NV 8 mm for M10, 1/2" x 1/2"	
00SV0310 00SV0294 00SV0270 00SV0271 00SV0524	Ring Spanner NV 10 mm for M6 NV 13 mm for M8 NV 17 mm for M10 NV 19 mm for M12 NV 24 mm for M16	
00SV2013	Socket Spanner NV 13 mm for M8, 9 x 12	

be think innovate

Being responsible is our foundation
Thinking ahead makes it possible
Innovation is the essence



L-CR-SM-062 | 8/12
PRINTED IN USA

Subject to alterations.

GRUNDFOS Pumps Corporation
17100 W. 118th Terrace
Olathe, Kansas 66062
Phone: 913.227.3400
Fax: 913.227.3500
www.grundfos.com

GRUNDFOS Canada, Inc.
2941 Brighton Road
Oakville, Ontario L6H 6C9 Canada
Phone: 905.829.9533
Fax: 905.829.9512

Bombas GRUNDFOS de Mexico S.A. de C.V.
Boulevard TLC No. 15
Parque Industrial Stiva Aeropuerto
Apodaca, N.L. Mexico 66600
Phone: 52.81.8144.4000
Fax: 52.81.8144.4010

GRUNDFOS 