

# FAB32ULOR3

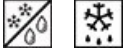

Product family	Refrigerator
Installation	Free-standing
Category	Bottom mount
Reference width	Until 60
No-frost system	Total
Cooling type	No Frost
Defrost	Automatic
Hinge position	Left
EAN code	8017709271985



## Aesthetic

Aesthetics	Retro-style	Logo	Applied
Color	Orange	Door shelf profile color	Chromed
Finishing	Glossy	Drawers profile color	Chromed
Handle color	Chromed	Glass shelf profile color	Chromed
Side material	Steel	Display	7 segment
Side color	Orange		

## Refrigerator compartment features



No. of adjustable shelves	3	Type of crisper cover	Glass
Number of fruit and vegetables drawers	1	LifePlus zone - 32°F	Yes
Type of adjustable shelves	Glass	Refrigerator lighting	Yes
Crisper drawer type	Standard	Refrigerator lighting	LED
Crisper cover	Yes		

## Refrigerator Inner Door

No. of door shelves with transparent cover	1	No. of bottle shelves	1
Number of adjustable door shelves	2	Door bin with wire support	Yes

**Adjustable door bins with wire support** Yes

## Other Refrigerator features



**Accessories**  
MultiFlow

**Egg tray**  
Yes

**Fan**

Yes

## Freezer features

**Number of drawers** 2  
**No. of compartments with flap** 1

**Shelf type** Plastic

## Other Freezer features



**Accessories**

1 x ice box

**Fast-freezing compartment**

Yes

## Other technical features



**Display functions**

Holiday, Fast-freezing, Fast-cooling, ECO, Temperature alarm

**Fast-freezing button**

Yes

**Power-on light**

Yes

**Temperature alarm**

Yes

**Door open alarm**

Acoustic and visual

**Temperature Alarm**

Yes

**Temperature setting type**

Electronic

**No. of compressors**

1

**Refrigerant gas type**

R600a

**Compressor type**

Inverter

**Refrigerant quantity**

2.1 oz

**Foam agent**

Cyclopentane

## Performance / Energy Label NEW

**Noise level** 37 dB(A) re 1pW

**Freezer capacity** 3.99 cu. ft.

## Electrical Connection

**Plug** (A) USA & Mexico

**Voltage (V)** 115 V

Electrical connection rating 127 W  
Current 1.2 A



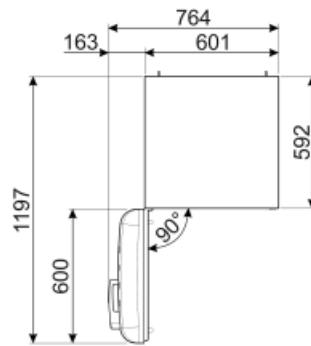
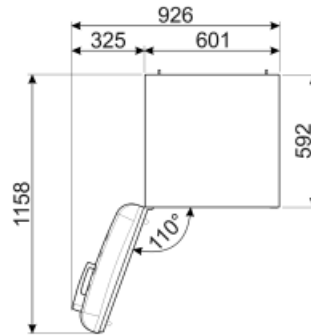
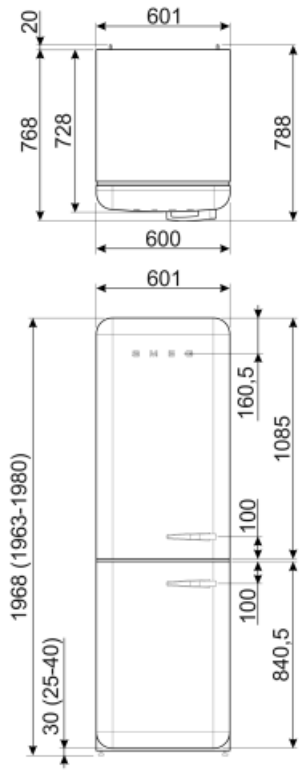







Frequency (Hz) 50/60 Hz  
Power cord length 78 3/4 "



---

## Symbols glossary (TT)

---

- |  |  |   |   |
|--|--|---|---|
|  | The automatic defrost system works by automatically defrosting at regular intervals eliminating the need to defrost altogether.            |  | Economical mode: Analyzes fridge functioning during the activation and optimizes the operating cycle in order to reduce power consumption.  |
|  | Ventilated: Forced distribution of cold air in the refrigerator compartment, which allows even temperature distribution within the fridge. |  | Fast freezing: The fast freezing function brings the temperature of the compartment down when activated a few hours prior to usage.   |
|  | Power saving mode: The power saving mode allows you to disable the refrigerator and keep the freezer working.                              |  | LED interior lighting: is a more energy efficient and long lasting way of illuminating the interior of the appliance.   |
|  | Life Plus 0°C: The temperature in the Lifeplus compartments is kept at 0°C, which preserves fresh meat and fish longer.                    |  | Inverter technology: The evolution of Smeg's driers towards more intelligent and environmentally sustainable models has led to the choice of using Inverter technology with heat pumps, which reduces significantly energy consumption. |
|  | Air plus: keeps food fresher for longer.   |  | No Frost: The No Frost and Frost free systems prevent ice from forming so that no defrosting is required.   |