

FAB32ULWH3



Product family	Refrigerator
Installation	Free-standing
Category	Bottom mount
Reference width	Until 60
No-frost system	Total
Cooling type	No Frost
Defrost	Automatic
Hinge position	Left
EAN code	8017709272098



Aesthetic

Aesthetics	Retro-style	Logo	Applied
Color	White	Door shelf profile color	Chromed
Finishing	Glossy	Drawers profile color	Chromed
Handle color	Chromed	Glass shelf profile color	Chromed
Side material	Steel	Display	7 segment
Side color	White		

Refrigerator compartment features



No. of adjustable shelves	3	Type of crisper cover	Glass
Number of fruit and vegetables drawers	1	LifePlus zone - 32°F	Yes
Type of adjustable shelves	Glass	Refrigerator lighting	Yes
Crisper drawer type	Standard	Refrigerator lighting	LED
Crisper cover	Yes		

Refrigerator Inner Door

No. of door shelves with transparent cover	1	No. of bottle shelves	1
Number of adjustable door shelves	2	Door bin with wire support	Yes

Adjustable door bins with wire support Yes

Other Refrigerator features



Accessories
MultiFlow

Egg tray
Yes

Fan

Yes

Freezer features

Number of drawers 2
No. of compartments with flap 1

Shelf type Plastic

Other Freezer features



Accessories

1 x ice box

Fast-freezing compartment

Yes

Other technical features



Display functions

Holiday, Fast-freezing, Fast-cooling, ECO, Temperature alarm

Fast-freezing button

Yes

Power-on light

Yes

Temperature alarm

Yes

Door open alarm

Acoustic and visual

Temperature Alarm

Yes

Temperature setting type

Electronic

No. of compressors

1

Refrigerant gas type

R600a

Compressor type

Inverter

Refrigerant quantity

2.1 oz

Foam agent

Cyclopentane

Performance / Energy Label NEW

Noise level 37 dB(A) re 1pW

Freezer capacity 3.99 cu. ft.

Electrical Connection

Plug (A) USA & Mexico







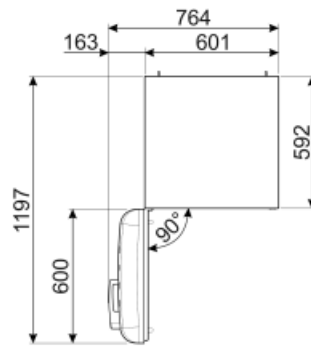
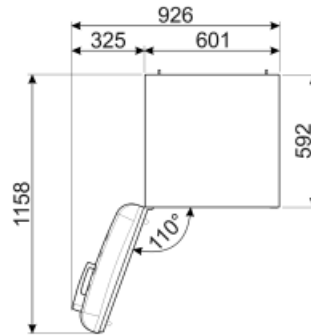
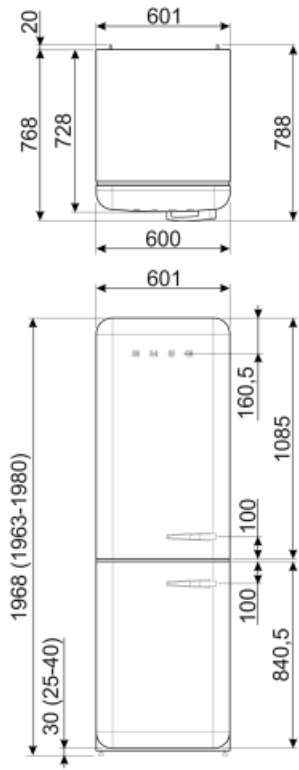



Voltage (V) 115 V

Electrical connection rating 127 W
Current 1,2 A

Frequency (Hz) 50/60 Hz
Power cord length 78 3/4 "



Symbols glossary (TT)

- | | | | |
|--|--|---|---|
|  | The automatic defrost system works by automatically defrosting at regular intervals eliminating the need to defrost altogether. |  | Economical mode: Analyzes fridge functioning during the activation and optimizes the operating cycle in order to reduce power consumption. |
|  | Ventilated: Forced distribution of cold air in the refrigerator compartment, which allows even temperature distribution within the fridge. |  | Fast freezing: The fast freezing function brings the temperature of the compartment down when activated a few hours prior to usage. |
|  | Power saving mode: The power saving mode allows you to disable the refrigerator and keep the freezer working. |  | LED interior lighting: is a more energy efficient and long lasting way of illuminating the interior of the appliance. |
|  | Life Plus 0°C: The temperature in the Lifeplus compartments is kept at 0°C, which preserves fresh meat and fish longer. |  | Inverter technology: The evolution of Smeg's driers towards more intelligent and environmentally sustainable models has led to the choice of using Inverter technology with heat pumps, which reduces significantly energy consumption. |
|  | Air plus: keeps food fresher for longer. |  | No Frost: The No Frost and Frost free systems prevent ice from forming so that no defrosting is required. |