

CPF30UGMOR

Cooker size	30"
N. of cavities with energy label	1
Cavity heat source	ELECTRICITY
Type of main oven	Thermo-ventilated
EAN code	8017709256708











Aesthetics

	Aesthetic	Portofino	No. of controls	7
	Colour	Orange	Serigraphy colour	Black
	Design	Flush fit	Handle	Smeg Portofino
	Door	With frame	Handle Colour	coloured
	Upstand	Yes	Glass type	Grey
	Type of pan stands	Cast Iron	Feet	Stainless steel
	Hob colour	Stainless steel	Plinth	Black
	Command panel finish	Enamelled metal	Storage compartment	Door
	Control knobs	Smeg Portofino	Logo	Assembled st/steel
	Controls colour	Stainless steel	Logo position	Facia below the oven
	Display	Touch		

Programs / Functions

No. of cooking functions 9

Traditional cooking functions

 Static	 Fan assisted	 Circulaire
 Small grill	 Large grill	 Fan grill (large)
 Base	 Fan assisted bottom	 Pizza

Other functions



Defrost by time

Hob technical features



Total no. of cook zones 4

Left - Gas - 2UR (dual) - 5.86 kW - 20000 BTU

Front centre - Gas - Semi Rapid - 2.34 kW - 8000 BTU

Rear centre - Gas - AUX - 1.31 kW - 4500 BTU

Right - Gas - UR - 5.86 kW - 20000 BTU

Type of gas burners Standard

Gas safety valves Yes

Automatic electronic ignition Yes

Burner caps Matt black enamelled

Main Oven Technical Features



No. of lights 2

Fan number 1

Gross volume, 1st cavity 0.13 cu. ft.

Cavity material Ever Clean enamel

No. of shelves 4

Type of shelves Metal racks

Light type Halogen

Light Power 40 W

Cooking time setting Start and Stop

Light when oven door is open Yes

Door opening Flap down

Removable door Yes

Full glass inner door Yes

Removable inner door Yes

Total no. of door glasses 3

No. of thermo-reflective door glasses 2

Safety Thermostat Yes

Cooling system Tangential

Usable cavity space dimensions (HxWxD) 340 x 640 x 430 "

Temperature control Electro-mechanical

Lower heating element power 1700 W

Upper heating element - Power 1200 W

Grill element 1700 W

Large grill - Power 2900 W

Circular heating element - Power 2700 W

Grill type Electric

Soft Close system Yes

Options Main Oven

Timer Yes

Minimum Temperature 49 °F

End of cooking acoustic alarm Yes

Maximum temperature 500 °F

Accessories included for Main Oven & Hob



Cast iron wok support	1	20mm deep tray	1
Oven grid with stop, tray support	1	Grill mesh	1
TOP Oven grid with back stop	1	Telescopic Guide rails, partial Extraction	1
Wide baking tray	1		

Electrical Connection

Electrical connection rating	3700 W	Power supply cable length	47 1/4 "
Current	20 A	Frequency	60 Hz
Voltage	240/208 V	Terminal block	5 poles

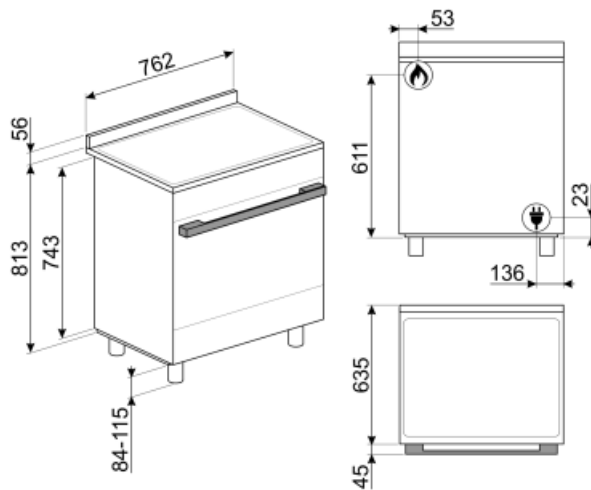

Not included accessories



GT91P

Partially extractable telescopic guides suitable for CPF30 cookers, USA



SFLK1

Child lock

BGCPF30

Cast iron grill plate suitable for 30" Portofino Cookers, USA



PRTX

Refractory pizza stone with handles. D=35cm Not suitable for microwave ovens. Suitable for gas ovens, to be put on the griddle.



TPKCPF30

Stainless steel Teppanyaki plate, suitable for Portofino 30" cookers





















PALPZ

Pizza shovel with folding handle. Dimensions L31.5 x H32.5 cm. Easy and convenient to use and store. Perfect for serving pizza, bread and savory pastries in a safe and professional way.



Symbols glossary (TT)

 <p>Heavy duty cast iron pan stands: for maximum stability and strength.</p>	 <p>Air cooling system: to ensure a safe surface temperatures.</p>
 <p>Defrost by time: Manual defrost function. At the end of the set duration, the function stops.</p>	 <p>Triple glazed doors: Number of glazed doors.</p>
 <p>Ever Clean Enamel: Ever Clean enamel is applied electrostatically, corner to corner and edge to edge to prevent cracking or cracks over time. It is a particular pyrolytic enamel, resistant to acids which, in addition to being pleasantly bright, promotes greater cleaning of the oven walls, thanks to its lower porosity. It is baked at over 850 ° C and slowly polymerized at a scientifically determined rate to ensure uniform depth and strength Ever Clean enamel creates an impeccable finish both on the inside of the oven and on the trays, making the surfaces of the oven incredibly easy to maintain over time as it reduces the adhesion of fat during cooking</p>	 <p>Fan assisted base: the mix of fan and lower heating element alone allows to finish cooking foods already cooked on the surface but not internally more quickly. This system is recommended to finish cooking foods that are already well cooked on the surface, but not internally, which therefore require a moderate higher heat. Ideal for any type of food.</p>
 <p>Fan assisted: Intense and homogeneous traditional cooking, also suitable for complex recipes. The fan is active and the heat comes from below and from above at the same time. Ventilated cooking ensures a faster and more homogeneous result, leaving fragrant foods outside and moister inside. Ideal for baked pasta, biscuits, roasts and cobblers.</p>	 <p>Static: Traditional cooking suitable for the preparation of one dish at a time. The fan is not active and the heat comes from below and from above at the same time. Static cooking is slower and more delicate, ideal in order to get well cooked and dry dishes even inside. Ideal for cooking all types of roasts, fatty meats, bread, filled cakes.</p>
 <p>Base: the heat comes only from the bottom of the cavity. The fan is not active. Ideal for sweet and savory pies, cobblers and pizzas. Designed to complete cooking and make food more crunchy This symbol in gas ovens indicates the gas burner.</p>	 <p>Circulaire: it is the perfect function for cooking all types of dishes in a more delicate way. The heat comes from the back of the oven and is distributed quickly and evenly The fan is active. It is also ideal for cooking on multiple levels without mixing smells and flavors.</p>
 <p>Grill: Very intense heat coming only from above from a double heating element. The fan is not active. Provides excellent grilling and gratinating results. Used at the end of cooking, it gives a uniform browning to dishes.</p>	 <p>Half grill: For rapid cooking and browning of foods. Best results can be obtained by using the top shelf for small items, the lower shelves for larger ones, such as chops or sausages. For half grill heat is generated only at the centre of the element, so is ideal for smaller quantities.</p>
 <p>Fan grill: very intense heat coming only from above from a double heating element The fan is active. It allows the optimal grilling of thickest meats. Ideal for large cuts of meat.</p>	 <p>Pizza function: Specific function for cooking pizza in a pan. It allows to obtain a pizza that is soft inside and crispy outside with the topping perfectly cooked, not dry and not burnt.</p>
 <p>All glass inner door: All glass inner door, a single flat surface which is simple to keep clean.</p>	 <p>The inner door glass: can be removed with a few quick movements for cleaning.</p>
 <p>Side lights: Two opposing side lights increase visibility inside the oven.</p>	 <p>The oven cavity has 4 different cooking levels.</p>



Soft close: all models are equipped with advanced function of smooth closing of the door, which allows the device to close smoothly and quietly.



Telescopic rails: allow you to pull out the dish and check it without having to remove it from the oven entirely.



Ultra rapid burners: Powerful ultra rapid burners offer up to 5kw of power.