

CPF30UGMYW

| | |
|----------------------------------|-------------------|
| Range size | 30" |
| N. of cavities with energy label | 1 |
| Oven energy source | Electricity |
| Main oven | Thermo-ventilated |
| EAN code | 8017709256715 |



Aesthetic











| | | | |
|-----------------------------|-----------------|----------------------------|-----------------------|
| Aesthetics | Portofino | No. of controls | 7 |
| Color | Yellow | Silkscreen color | Black |
| Design | Flush mounted | Handle | Portofino |
| Door | With frame | Handle color | Colored |
| Upstand | Yes | Door glass type | Gray |
| Grates | Cast Iron | Feet | Stainless steel |
| Cooktop color | Stainless steel | Plinth | Black |
| Control panel finish | Metal enameled | Storage compartment | Storage drawer |
| Control knobs | Portofino | Logo | Stainless steel |
| Controls color | Stainless steel | Logo position | Fascia below the oven |
| Display | Touch | | |

Programs / Functions

No. of cooking functions 9

Traditional cooking functions

| | | |
|--|---|--|
|  Static |  Fan-assisted |  True European convection |
|  Small grill |  Large grill |  Large grill + Fan |
|  Bottom |  Convection bottom |  Pizza |

Other functions



Defrost by time

Cooktop technical features



Cooking zones 4

Left - Gas - Dual ultra-rapid - 5.86 kW - 20000 BTU
 Front-center - Gas - Semi-rapid - 2.34 kW - 8000 BTU
 Rear-center - AUX - 1.31 kW - 4500 BTU
 Right - Gas - Ultra-rapid - 5.86 kW - 20000 BTU

| | | | |
|-------------------------------|----------|--------------------------|----------------------|
| Burners type | Standard | Gas safety valves | Yes |
| Automatic gas ignition | Yes | Burner caps | Enameled matte black |

Main Oven Technical Features



| | | | |
|-----------------------------------|------------------|--|--------------------|
| No. of lights | 2 | Total no. of door glasses | 3 |
| Fan number | 1 | No. of thermo-reflective door glasses | 2 |
| Volume | 0.13 cu. ft. | Safety thermostat | Yes |
| Cavity material | EverClean enamel | Cooling system | Tangential |
| No. of shelves | 4 | Inner cavity dimensions (HxWxD) | 340 x 640 x 430 " |
| Shelves type | Metal racks | Temperature control | Electro-mechanical |
| Light type | Halogen | Bottom heating element - Power | 1700 W |
| Light Power | 40 W | Upper heating element - Power | 1200 W |
| Time setting | Start and end | Grill power | 1700 W |
| Light on when door is open | Yes | Large grill - Power | 2900 W |
| Door opening | Drop-down | Circular heating element - Power | 2700 W |
| Removable door | Yes | Grill type | Electric |
| Full-glass inner door | Yes | Soft Close system | Yes |
| Removable inner door | Yes | | |

Main oven options

| | | | |
|-----------------------------|-----|----------------------------|--------|
| Timer | Yes | Minimum Temperature | 120 °F |
| End-of-cooking alarm | Yes | Maximum temperature | 500 °F |

Accessories included for main oven and cooktop



| | | | |
|------------------------------|---|-----------------------|---|
| Cast iron wok support | 1 | 0.8"-deep tray | 1 |
|------------------------------|---|-----------------------|---|

| | | | |
|--|---|--|---|
| Oven grid with back-stop, tray support | 1 | Grill mesh | 1 |
| TOP Oven grid with back stop | 1 | Telescopic Guide rails, partial Extraction | 1 |
| Wide baking tray | 1 | | |

Electrical Connection

| | | | |
|------------------------------|-----------|-------------------|----------|
| Electrical connection rating | 3700 W | Power cord length | 47 1/4 " |
| Current | 20 A | Frequency | 60 Hz |
| Voltage | 240/208 V | Terminal block | 5 poles |

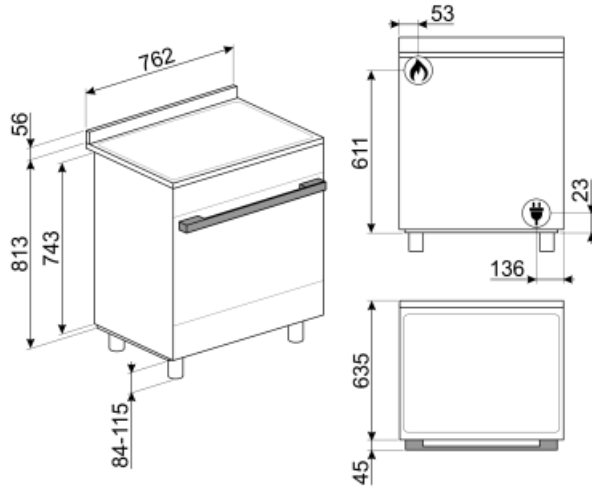

Not included accessories



GT91P

Partial-extraction telescopic guides for 30" Portofino ranges



SFLK1

Child lock



BGCPF30

Cast iron grill plate suitable for 30" Portofino FS Cookers



PRTX

Refractory pizza stone with handles. D=35cm Not suitable for microwave ovens. Suitable for gas ovens, to be put on the griddle.

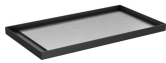



















TPKCPF30



PALPZ

Pizza shovel with fold away handle width: 315mm length : 325mm

Symbols glossary (TT)

| | |
|--|---|
|  <p>Heavy duty cast iron pan stands: for maximum stability and strength.</p> |  <p>Air cooling system: to ensure a safe surface temperatures.</p> |
|  <p>Defrost by time: with this function the time of thawing of foods are determined automatically.</p> |  <p>Triple glazed doors: Number of glazed doors.</p> |
|  <p>Enamel interior: The enamel interior of all Smeg ovens have a special antacid lining which helps keep the interior clean by reducing the amount of cooking grease adhering to it.</p> |  <p>Circogas: In gas ovens the fan distributes the heat quickly and evenly throughout the oven cavity, avoiding flavour transfer when cooking a number of different dishes at the same time. In electric ovens this combination completes cooking more quickly of foods that are ready on the surface, but that require more cooking inside, without further browning.</p> |
|  <p>Fan with upper and lower elements: The elements combined with the fan aim to provide more uniform heat, a similar method to conventional cooking, so pre-heat is required. Most suitable for items requiring slow cooking methods.</p> |  <p>Upper and lower element only: a traditional cooking method best suited for single items located in the centre of the oven. the top pf the oven will always be hottest. Ideal for roast, fruit cakes, bread etc.</p> |
|  <p>Lower heating element only: This function is ideal for foods that require extra base temperature without browning, e.g. pastry dishes, pizza. Also suitable for slow cooking of stews and casseroles.</p> |  <p>Circulaire: The combination of the fan and circular element around it gives a hot air cooking method. This provides many benefits including no preheat if cook time is more than 20 minutes, no flavour transfer when cooking different foods at the same time, less energy, and shorter cook times. Good for all types of food.</p> |
|  <p>Grill element: Using of grill gives excellent results when cooking meat of medium and small portions, especially when combined with a rotisserie (where possible). Also ideal for cooking sausages and bacon.</p> |  <p>Half grill: For rapid cooking and browning of foods. Best results can be obtained by using the top shelf for small items, the lower shelves for larger ones, such as chops or sausages. For half grill heat is generated only at the centre of the element, so is ideal for smaller quantities.</p> |
|  <p>Fan with grill element: The fan reduces the fierce heat from the grill, providing an excellent method of grilling various foods, chops, steaks, sausages etc. giving even browning and heat distribution, without drying out the food. The top two levels recommended for use, and the lower part of the oven can be used to keep items warm at the same time, an excellent facility when cooking a grilled breakfast. Half grill (centre portion only) is ideal for small quantities of food.</p> |  <p>Pizza function: The simultaneous operation of three elements ensures an optimum cooking facility when used with the Smeg pizza stone.</p> |
|  <p>All glass inner door: All glass inner door, a single flat surface which is simple to keep clean.</p> |  <p>The inner door glass: can be removed with a few quick movements for cleaning.</p> |
|  <p>Side lights: Two opposing side lights increase visibility inside the oven.</p> |  <p>The oven cavity has 4 different cooking levels.</p> |



Soft close: all models are equipped with advanced function of smooth closing of the door, which allows the device to close smoothly and quietly.



Telescopic rails: allow you to pull out the dish and check it without having to remove it from the oven entirely.



Ultra rapid burners: Powerful ultra rapid burners offer up to 5kw of power.