

CPF30UGGAN

Range size	30"
N. of cavities with energy label	1
Oven energy source	Gas
Main oven	Gas with grill
EAN code	8017709270292



Aesthetic



Aesthetics	Portofino	No. of controls	7
Color	Anthracite	Silkscreen color	Silver
Design	Flush mounted	Handle	Portofino
Door	With frame	Handle color	Colored
Upstand	Yes	Door glass type	Gray
Grates	Cast Iron	Feet	Stainless steel
Cooktop color	Stainless steel	Plinth	Black
Control panel finish	Metal enameled	Storage compartment	Storage drawer
Control knobs	Portofino	Logo	Stainless steel
Controls color	Stainless steel	Logo position	Fascia below the oven
Display	Touch		

Programs / Functions

No. of cooking functions	2
--------------------------	---

Cooktop technical features



Cooking zones	4
Left - Gas - Dual ultra-rapid	5.86 kW - 20000 BTU
Front-center - Gas - Semi-rapid	2.34 kW - 8000 BTU
Rear-center - AUX	1.31 kW - 4500 BTU
Right - Gas - Ultra-rapid	5.86 kW - 20000 BTU

Burners type	Standard	Gas safety valves	Yes
Automatic gas ignition	Yes	Burner caps	Enameled matte black

Main Oven Technical Features



No. of lights	2	Removable door	Yes
Fan number	1	Full-glass inner door	Yes
Volume	0.13 cu. ft.	Removable inner door	Yes
Cavity material	EverClean enamel	Total no. of door glasses	3
No. of shelves	4	No. of thermo-reflective door glasses	2
Shelves type	Metal racks	Safety thermostat	Yes
Light type	Halogen	Cooling system	Tangential
Light Power	40 W	Inner cavity dimensions (HxWxD)	317 x 640 x 430 "
Time setting	Start and end	Temperature control	Electro-mechanical
Light on when door is open	Yes	Grill type	Gas
Door opening	Drop-down	Soft Close system	Yes

Main oven options

Timer	Yes	Minimum Temperature	120 °F
End-of-cooking alarm	Yes	Maximum temperature	500 °F

Accessories included for main oven and cooktop



Cast iron wok support	1	1.6"-deep tray	1
Oven grid with back-stop, tray support	1	Grill mesh	1
TOP Oven grid with back stop	2	Telescopic Guide rails, partial Extraction	1

Electrical Connection

Plug	(B) USA 120V	Type of electric cable installed	Yes, Single phase
Electrical connection rating	200 W	Power cord length	55 1/8 "
Current	2 A	Frequency	60 Hz
Circuit breaker	15 A	Terminal block	3 pins
Voltage	120 V		

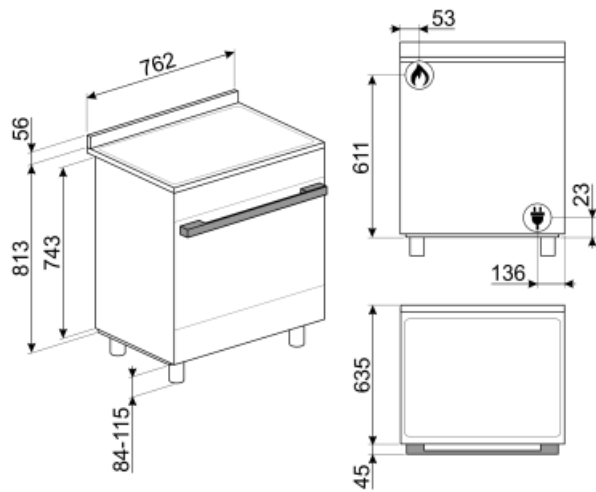

Not included accessories



GT91P

Partial-extraction telescopic guides for 30" Portofino ranges



SFLK1

Child lock

BGCPF30

Cast iron grill plate suitable for 30" Portofino FS Cookers



PRTX

Refractory pizza stone with handles. D=35cm Not suitable for microwave ovens. Suitable for gas ovens, to be put on the griddle.



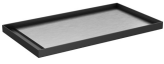









TPKCPF30



PALPZ

Pizza shovel with fold away handle width: 315mm length : 325mm

Symbols glossary (TT)

	Heavy duty cast iron pan stands: for maximum stability and strength.		Air cooling system: to ensure a safe surface temperatures.
	Triple glazed doors: Number of glazed doors.		Enamel interior: The enamel interior of all Smeg ovens have a special antacid lining which helps keep the interior clean by reducing the amount of cooking grease adhering to it.
	Gas ovens offer instantaneous heat control, reduced cooking times and the ability to bake at much lower temperatures than electric ovens.		All glass inner door: All glass inner door, a single flat surface which is simple to keep clean.
	The inner door glass: can be removed with a few quick movements for cleaning.		Side lights: Two opposing side lights increase visibility inside the oven.
	The oven cavity has 4 different cooking levels.		Soft close: all models are equipped with advanced function of smooth closing of the door, which allows the device to close smoothly and quietly.
	Telescopic rails: allow you to pull out the dish and check it without having to remove it from the oven entirely.		Ultra rapid burners: Powerful ultra rapid burners offer up to 5kw of power.