

# CPF36UGGAN

Range size	36"
N. of cavities with energy label	1
Oven energy source	Gas
Main oven	Gas with grill
EAN code	8017709260637



## Aesthetic



<b>Aesthetics</b>	Portofino	<b>No. of controls</b>	8
<b>Color</b>	Anthracite	<b>Silkscreen color</b>	Silver
<b>Design</b>	Flush mounted	<b>Handle</b>	Portofino
<b>Door</b>	With frame	<b>Handle color</b>	Colored
<b>Upstand</b>	Yes	<b>Door glass type</b>	Gray
<b>Grates</b>	Cast Iron	<b>Feet</b>	Stainless steel
<b>Cooktop color</b>	Stainless steel	<b>Plinth</b>	Black
<b>Control panel finish</b>	Metal enameled	<b>Storage compartment</b>	Push-pull
<b>Control knobs</b>	Portofino	<b>Logo</b>	Stainless steel
<b>Controls color</b>	Stainless steel	<b>Logo position</b>	Fascia below the oven
<b>Display</b>	Touch		

## Programs / Functions

No. of cooking functions 3

Traditional cooking functions



Large grill



Bottom



Convection bottom

Other functions



Defrost by time

## Cooktop technical features

UR

**Cooking zones 5**

Left - Gas - Dual ultra-rapid - 5.86 kW - 20000 BTU  
 Rear-center - Gas - AUX - 1.31 kW - 4500 BTU  
 Front-center - Gas - Rapid - 3.08 kW - 10500 BTU  
 Rear-right - Gas - Rapid - 3.51 kW - 12000 BTU  
 Front-right - Gas - Semi-rapid - 2.34 kW - 8000 BTU

<b>Burners type</b>	Standard	<b>Gas safety valves</b>	Yes
<b>Automatic gas ignition</b>	Yes	<b>Burner caps</b>	Enameled matte black

**Main Oven Technical Features**



<b>No. of lights</b>	2	<b>Full-glass inner door</b>	Yes
<b>Fan number</b>	3	<b>Removable inner door</b>	Yes
<b>Volume</b>	0.16 cu. ft.	<b>Total no. of door glasses</b>	3
<b>Cavity material</b>	EverClean enamel	<b>No. of thermo-reflective door glasses</b>	2
<b>No. of shelves</b>	5	<b>Safety thermostat</b>	Yes
<b>Shelves type</b>	Metal racks	<b>Cooling system</b>	Tangential
<b>Light type</b>	Halogen	<b>Inner cavity dimensions (HxWxD)</b>	345 x 690 x 415 "
<b>Light Power</b>	40 W	<b>Temperature control</b>	Electro-mechanical
<b>Time setting</b>	Start and end	<b>Grill type</b>	Gas
<b>Door opening</b>	Drop-down	<b>Soft Close system</b>	Yes
<b>Removable door</b>	Yes		

**Main oven options**

<b>Timer</b>	Yes	<b>Minimum Temperature</b>	120 °F
<b>End-of-cooking alarm</b>	Yes	<b>Maximum temperature</b>	500 °F

**Accessories included for main oven and cooktop**



<b>Cast iron wok support</b>	1	<b>Grill mesh</b>	1
<b>TOP Oven grid with back stop</b>	2	<b>Telescopic Guide rails, total Extraction</b>	1
<b>0.8"-deep tray</b>	1		

**Electrical Connection**

<b>Plug</b>	(B) USA 120V	<b>Type of electric cable installed</b>	Yes, Single phase
<b>Electrical connection rating</b>	200 W	<b>Power cord length</b>	47 1/4 "
<b>Current</b>	2 A	<b>Frequency</b>	60 Hz
<b>Circuit breaker</b>	15 A	<b>Terminal block</b>	3 pins
<b>Voltage</b>	120 V		

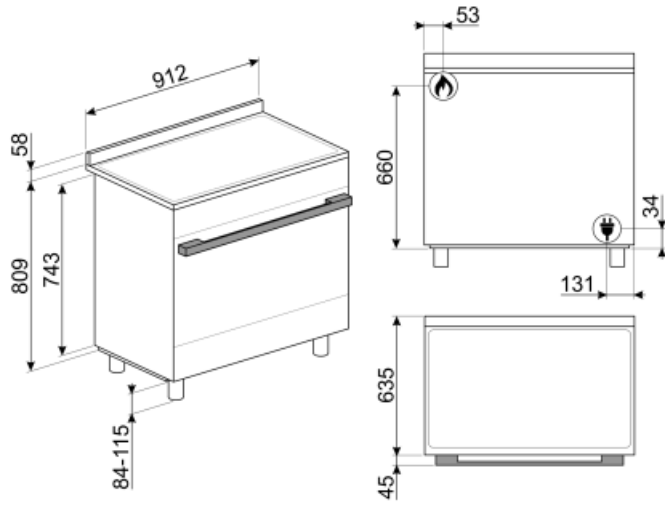

---

## Not included accessories

---



### TPKTR9

Teppanyaki grill plate for Victoria TR9, Master and Sinfonia cookers



### SFLK1

Child lock



### PRTX

Refractory pizza stone with handles. D=35cm Not suitable for microwave ovens. Suitable for gas ovens, to be put on the griddle.



### BGTR9

Cast iron grill plate suitable for 90 cm Victoria, 60 and 90 cm Master and Sinfonia cookers

### GT3T



### PPR9

Refractory pizza stone without handles. Squared stone (HxWxD): 0.9" x 25.2" x 14.75". Also suitable for gas ovens, to be placed on a rack



















### PALPZ

Pizza shovel with fold away handle width: 315mm length : 325mm



## Symbols glossary (TT)

 <p>Heavy duty cast iron pan stands: for maximum stability and strength.</p>	 <p>Air cooling system: to ensure a safe surface temperatures.</p>
 <p>Defrost by time: with this function the time of thawing of foods are determined automatically.</p>	 <p>Triple glazed doors: Number of glazed doors.</p>
 <p>Enamel interior: The enamel interior of all Smeg ovens have a special antacid lining which helps keep the interior clean by reducing the amount of cooking grease adhering to it.</p>	 <p>Circogas: In gas ovens the fan distributes the heat quickly and evenly throughout the oven cavity, avoiding flavour transfer when cooking a number of different dishes at the same time. In electric ovens this combination completes cooking more quickly of foods that are ready on the surface, but that require more cooking inside, without further browning.</p>
 <p>Lower heating element only: This function is ideal for foods that require extra base temperature without browning, e.g. pastry dishes, pizza. Also suitable for slow cooking of stews and casseroles.</p>	 <p>Grill element: Using of grill gives excellent results when cooking meat of medium and small portions, especially when combined with a rotisserie (where possible). Also ideal for cooking sausages and bacon.</p>
 <p>Gas ovens offer instantaneous heat control, reduced cooking times and the ability to bake at much lower temperatures than electric ovens.</p>	 <p>All glass inner door: All glass inner door, a single flat surface which is simple to keep clean.</p>
 <p>The inner door glass: can be removed with a few quick movements for cleaning.</p>	 <p>Side lights: Two opposing side lights increase visibility inside the oven.</p>
 <p>The oven cavity has 5 different cooking levels.</p>	 <p>Soft close: all models are equipped with advanced function of smooth closing of the door, which allows the device to close smoothly and quietly.</p>
 <p>Telescopic rails: allow you to pull out the dish and check it without having to remove it from the oven entirely.</p>	 <p>Ultra rapid burners: Powerful ultra rapid burners offer up to 5kw of power.</p>