

CPF36UGMR

Cooker size	36"
N. of cavities with energy label	1
Cavity heat source	ELECTRICITY
Type of main oven	Thermo-ventilated
Cleaning system main oven	Vapor Clean
EAN code	8017709248987













Aesthetics

			
Aesthetic	Portofino	No. of controls	8
Colour	Red	Serigraphy colour	Black
Design	Flush fit	Handle	Smeg Portofino
Door	With frame	Handle Colour	coloured
Upstand	Yes	Glass type	Grey
Type of pan stands	Cast Iron	Feet	Stainless steel
Hob colour	Stainless steel	Plinth	Black
Command panel finish	Enamelled metal	Storage compartment	Push pull
Control knobs	Smeg Portofino	Logo	Assembled st/steel
Controls colour	Stainless steel	Logo position	Facia below the oven
Display	Touch		

Programs / Functions

No. of cooking functions	10
--------------------------	----

Traditional cooking functions

 Static	 Fan assisted	 Circulaire
 Small grill	 Large grill	 Fan grill (large)
 Base	 Fan assisted bottom	 Pizza
 Rotisserie		

Cleaning functions

 Vapor clean
--









Other functions

 Defrost by time
--

Hob technical features

UR			
Total no. of cook zones	5		
Left - Gas - 2UR (dual) - 5.86 kW - 20000 BTU			
Rear centre - Gas - AUX - 1.31 kW - 4500 BTU			
Front centre - Gas - Rapid - 3.08 kW - 10500 BTU			
Rear right - Gas - Rapid - 3.51 kW - 12000 BTU			
Front right - Gas - Semi Rapid - 2.34 kW - 8000 BTU			
Type of gas burners	Standard	Gas safety valves	Yes
Automatic electronic ignition	Yes	Burner caps	Matt black enamelled

Main Oven Technical Features

									
No. of lights	2	Total no. of door glasses	3						
Fan number	3	No. of thermo-reflective door glasses	2						
Gross volume, 1st cavity	0.16 cu. ft.	Safety Thermostat	Yes						
Cavity material	Ever Clean enamel	Cooling system	Tangential						
No. of shelves	5	Usable cavity space dimensions (HxWxD)	370 x 690 x 415 "						
Type of shelves	Metal racks	Temperature control	Electro-mechanical						
Light type	Halogen	Lower heating element power	1700 W						
Light Power	40 W	Upper heating element - Power	1200 W						
Cooking time setting	Start and Stop	Grill element	1700 W						
Light when oven door is open	Yes	Large grill - Power	2900 W						
Door opening	Flap down								
Removable door	Yes								

Full glass inner door	Yes	Circular heating element	2 x 1550 W
Removable inner door	Yes	- Power	
		Grill type	Electric
		Soft Close system	Yes

Options Main Oven

Timer	Yes	Minimum Temperature	49 °F
End of cooking acoustic alarm	Yes	Maximum temperature	500 °F

Accessories included for Main Oven & Hob



Cast iron wok support	1	40mm deep tray	1
TOP Oven grid with back stop	2	Telescopic Guide rails, total Extraction	1

Electrical Connection

Electrical connection rating	3800 W	Type of electric cable installed	Yes, Double phase
Current	20 A	Power supply cable length	47 1/4 "
Circuit breaker	20 A	Frequency	60 Hz
Voltage	240/208 V	Terminal block	5 poles

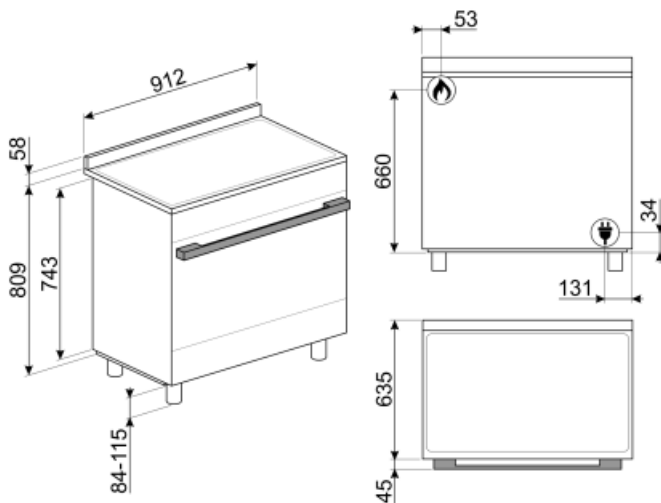

Not included accessories



TPKTR9

Stainless steel teppanyaki plate, suitable for Victoria TR9, Master and Sinfonia cookers



PRTX

Refractory pizza stone with handles. D=35cm Not suitable for microwave ovens. Suitable for gas ovens, to be put on the griddle.



GT3T

Totally extractable telescopic guides



PALPZ

Pizza shovel with folding handle. Dimensions L31.5 x H32.5 cm. Easy and convenient to use and store. Perfect for serving pizza, bread and savory pastries in a safe and professional way.



SFLK1

Child lock



BGTR9



















Cast iron grill plate suitable for 90 cm Victoria, 60 and 90 cm Master and Sinfonia cookers







PPR9

Refractory pizza stone without handles. Squared shaped stone: L64xH2,3xP37,5 cm Suitable also for gas ovens, to be put on the griddle.

Symbols glossary (TT)

 <p>Heavy duty cast iron pan stands: for maximum stability and strength.</p>	 <p>Air cooling system: to ensure a safe surface temperatures.</p>
 <p>Defrost by time: Manual defrost function. At the end of the set duration, the function stops.</p>	 <p>Triple glazed doors: Number of glazed doors.</p>
 <p>Ever Clean Enamel: Ever Clean enamel is applied electrostatically, corner to corner and edge to edge to prevent cracking or cracks over time. It is a particular pyrolytic enamel, resistant to acids which, in addition to being pleasantly bright, promotes greater cleaning of the oven walls, thanks to its lower porosity. It is baked at over 850 ° C and slowly polymerized at a scientifically determined rate to ensure uniform depth and strength Ever Clean enamel creates an impeccable finish both on the inside of the oven and on the trays, making the surfaces of the oven incredibly easy to maintain over time as it reduces the adhesion of fat during cooking</p>	 <p>Fan assisted base: the mix of fan and lower heating element alone allows to finish cooking foods already cooked on the surface but not internally more quickly. This system is recommended to finish cooking foods that are already well cooked on the surface, but not internally, which therefore require a moderate higher heat. Ideal for any type of food.</p>
 <p>Fan assisted: Intense and homogeneous traditional cooking, also suitable for complex recipes. The fan is active and the heat comes from below and from above at the same time. Ventilated cooking ensures a faster and more homogeneous result, leaving fragrant foods outside and moister inside. Ideal for baked pasta, biscuits, roasts and cobblers.</p>	 <p>Static: Traditional cooking suitable for the preparation of one dish at a time. The fan is not active and the heat comes from below and from above at the same time. Static cooking is slower and more delicate, ideal in order to get well cooked and dry dishes even inside. Ideal for cooking all types of roasts, fatty meats, bread, filled cakes.</p>
 <p>Base: the heat comes only from the bottom of the cavity. The fan is not active. Ideal for sweet and savory pies, cobblers and pizzas. Designed to complete cooking and make food more crunchy This symbol in gas ovens indicates the gas burner.</p>	 <p>Circulaire: it is the perfect function for cooking all types of dishes in a more delicate way. The heat comes from the back of the oven and is distributed quickly and evenly The fan is active. It is also ideal for cooking on multiple levels without mixing smells and flavors.</p>
 <p>Grill: Very intense heat coming only from above from a double heating element. The fan is not active. Provides excellent grilling and gratinating results. Used at the end of cooking, it gives a uniform browning to dishes.</p>	 <p>Half grill: For rapid cooking and browning of foods. Best results can be obtained by using the top shelf for small items, the lower shelves for larger ones, such as chops or sausages. For half grill heat is generated only at the centre of the element, so is ideal for smaller quantities.</p>
 <p>Fan grill: very intense heat coming only from above from a double heating element The fan is active. It allows the optimal grilling of thickest meats. Ideal for large cuts of meat.</p>	 <p>Pizza function: Specific function for cooking pizza in a pan. It allows to obtain a pizza that is soft inside and crispy outside with the topping perfectly cooked, not dry and not burnt.</p>
 <p>Rotisserie: The rotisserie (where installed) works in combination with the grill element to brown foods to perfection.</p>	 <p>All glass inner door: All glass inner door, a single flat surface which is simple to keep clean.</p>
 <p>The inner door glass: can be removed with a few quick movements for cleaning.</p>	 <p>Side lights: Two opposing side lights increase visibility inside the oven.</p>

-  The oven cavity has 5 different cooking levels.
-  Soft close: all models are equipped with advanced function of smooth closing of the door, which allows the device to close smoothly and quietly.
-  Telescopic rails: allow you to pull out the dish and check it without having to remove it from the oven entirely.
-  Ultra rapid burners: Powerful ultra rapid burners offer up to 5kw of power.
-  Vapor Clean: a simple cleaning function using steam to loosen deposits in the oven cavity.