

CPF36UGGYW

Range size	36"
N. of cavities with energy label	1
Oven energy source	Gas
Main oven	Gas with grill
EAN code	8017709265243



Aesthetic



Aesthetics	Portofino	No. of controls	8
Color	Yellow	Silkscreen color	Black
Design	Flush mounted	Handle	Portofino
Door	With frame	Handle color	Colored
Upstand	Yes	Door glass type	Gray
Grates	Cast Iron	Feet	Stainless steel
Cooktop color	Stainless steel	Plinth	Black
Control panel finish	Metal enameled	Storage compartment	Push-pull
Control knobs	Portofino	Logo	Stainless steel
Controls color	Stainless steel	Logo position	Fascia below the oven
Display	Touch		

Programs / Functions

No. of cooking functions 3

Traditional cooking functions



Large grill



Bottom



Convection bottom

Other functions



Defrost by time

Cooktop technical features

UR

Cooking zones 5

Left - Gas - Dual ultra-rapid - 5.86 kW - 20000 BTU
 Rear-center - Gas - AUX - 1.31 kW - 4500 BTU
 Front-center - Gas - Rapid - 3.08 kW - 10500 BTU
 Rear-right - Gas - Rapid - 3.51 kW - 12000 BTU
 Front-right - Gas - Semi-rapid - 2.34 kW - 8000 BTU

Burners type	Standard	Gas safety valves	Yes
Automatic gas ignition	Yes	Burner caps	Enameled matte black

Main Oven Technical Features



No. of lights	2	Full-glass inner door	Yes
Fan number	3	Removable inner door	Yes
Volume	0.16 cu. ft.	Total no. of door glasses	3
Cavity material	EverClean enamel	No. of thermo-reflective door glasses	2
No. of shelves	5	Safety thermostat	Yes
Shelves type	Metal racks	Cooling system	Tangential
Light type	Halogen	Inner cavity dimensions (HxWxD)	345 x 690 x 415 "
Light Power	40 W	Temperature control	Electro-mechanical
Time setting	Start and end	Grill type	Gas
Door opening	Drop-down	Soft Close system	Yes
Removable door	Yes		

Main oven options

Timer	Yes	Minimum Temperature	120 °F
End-of-cooking alarm	Yes	Maximum temperature	500 °F

Accessories included for main oven and cooktop



Cast iron wok support	1	Grill mesh	1
TOP Oven grid with back stop	2	Telescopic Guide rails, total Extraction	1
0.8"-deep tray	1		

Electrical Connection

Plug	(B) USA 120V	Power cord length	47 1/4 "
Electrical connection rating	200 W	Frequency	60 Hz
Current	2 A	Terminal block	3 pins
Voltage	120 V		

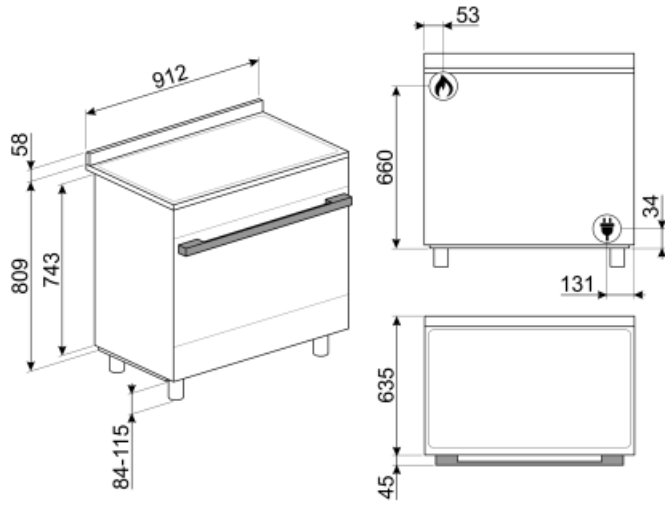

Not included accessories



TPKTR9

Teppanyaki grill plate for Victoria TR9, Master and Sinfonia cookers



SFLK1

Child lock



PRTX

Refractory pizza stone with handles. D=35cm Not suitable for microwave ovens. Suitable for gas ovens, to be put on the griddle.



BGTR9

Cast iron grill plate suitable for 90 cm Victoria, 60 and 90 cm Master and Sinfonia cookers



GT3T

PPR9

















Refractory pizza stone without handles. Squared stone (HxWxD): 0.9" x 25.2" x 14.75". Also suitable for gas ovens, to be placed on a rack



PALPZ

Pizza shovel with fold away handle width: 315mm length : 325mm

Symbols glossary (TT)

 <p>Heavy duty cast iron pan stands: for maximum stability and strength.</p>	 <p>Air cooling system: to ensure a safe surface temperatures.</p>
 <p>Defrost by time: with this function the time of thawing of foods are determined automatically.</p>	 <p>Triple glazed doors: Number of glazed doors.</p>
 <p>Enamel interior: The enamel interior of all Smeg ovens have a special antacid lining which helps keep the interior clean by reducing the amount of cooking grease adhering to it.</p>	 <p>Circogas: In gas ovens the fan distributes the heat quickly and evenly throughout the oven cavity, avoiding flavour transfer when cooking a number of different dishes at the same time. In electric ovens this combination completes cooking more quickly of foods that are ready on the surface, but that require more cooking inside, without further browning.</p>
 <p>Lower heating element only: This function is ideal for foods that require extra base temperature without browning, e.g. pastry dishes, pizza. Also suitable for slow cooking of stews and casseroles.</p>	 <p>Grill element: Using of grill gives excellent results when cooking meat of medium and small portions, especially when combined with a rotisserie (where possible). Also ideal for cooking sausages and bacon.</p>
 <p>Gas ovens offer instantaneous heat control, reduced cooking times and the ability to bake at much lower temperatures than electric ovens.</p>	 <p>All glass inner door: All glass inner door, a single flat surface which is simple to keep clean.</p>
 <p>The inner door glass: can be removed with a few quick movements for cleaning.</p>	 <p>Side lights: Two opposing side lights increase visibility inside the oven.</p>
 <p>The oven cavity has 5 different cooking levels.</p>	 <p>Soft close: all models are equipped with advanced function of smooth closing of the door, which allows the device to close smoothly and quietly.</p>
 <p>Telescopic rails: allow you to pull out the dish and check it without having to remove it from the oven entirely.</p>	 <p>Ultra rapid burners: Powerful ultra rapid burners offer up to 5kw of power.</p>