

CPF36UGMOG

Cooker size	36"
N. of cavities with energy label	1
Cavity heat source	ELECTRICITY
Type of main oven	Thermo-ventilated
Cleaning system main oven	Vapor Clean
EAN code	8017709254018













Aesthetics

	Aesthetic	Portofino	No. of controls	8
	Colour	Olive green	Serigraphy colour	Black
	Design	Flush fit	Handle	Smeg Portofino coloured
	Door	With frame	Handle Colour	coloured
	Upstand	Yes	Glass type	Grey
	Type of pan stands	Cast Iron	Feet	Stainless steel
	Hob colour	Stainless steel	Plinth	Black
	Command panel finish	Enamelled metal	Storage compartment	Push pull
	Control knobs	Smeg Portofino	Logo	Assembled st/steel
	Controls colour	Stainless steel	Logo position	Facia below the oven
	Display	Touch		

Programs / Functions

No. of cooking functions	10
--------------------------	----

Traditional cooking functions

 Static	 Fan assisted	 Circulaire
 Small grill	 Large grill	 Fan grill (large)
 Base	 Fan assisted bottom	 Pizza
 Rotisserie		

Cleaning functions

 Vapor clean

Other functions

 Defrost by time

Hob technical features

UR			
Total no. of cook zones	5		
Left - Gas - 2UR (dual)	- 5.86 kW - 20000 BTU		
Rear centre - Gas - AUX	- 1.31 kW - 4500 BTU		
Front centre - Gas - Rapid	- 3.08 kW - 10500 BTU		
Rear right - Gas - Rapid	- 3.51 kW - 12000 BTU		
Front right - Gas - Semi Rapid	- 2.34 kW - 8000 BTU		
Type of gas burners	Standard	Gas safety valves	Yes
Automatic electronic ignition	Yes	Burner caps	Matt black enamelled

Main Oven Technical Features



No. of lights	2	Total no. of door glasses	3
Fan number	3	No. of thermo-reflective door glasses	2
Gross volume, 1st cavity	0.16 cu. ft.	Safety Thermostat	Yes
Cavity material	Ever Clean enamel	Cooling system	Tangential
No. of shelves	5	Usable cavity space dimensions (HxWxD)	370 x 690 x 415 "
Type of shelves	Metal racks	Temperature control	Electro-mechanical
Light type	Halogen	Lower heating element power	1700 W
Light Power	40 W	Upper heating element - Power	1200 W
Cooking time setting	Start and Stop	Grill element	1700 W
Light when oven door is open	Yes	Large grill - Power	2900 W
Door opening	Flap down		
Removable door	Yes		

Full glass inner door Yes
Removable inner door Yes

Circular heating element 2 x 1550 W
- Power
Grill type Electric
Tilting grill Yes
Soft Close system Yes

Options Main Oven

Timer Yes
End of cooking acoustic alarm Yes

Minimum Temperature 49 °F
Maximum temperature 500 °F

Accessories included for Main Oven & Hob



Cast iron wok support 1
TOP Oven grid with back stop 2

40mm deep tray 1
Telescopic Guide rails, total Extraction 1

Electrical Connection

Electrical connection rating 3800 W
Current 20 A
Voltage 240/208 V

Power supply cable length 47 1/4 "
Frequency 60 Hz
Terminal block 5 poles

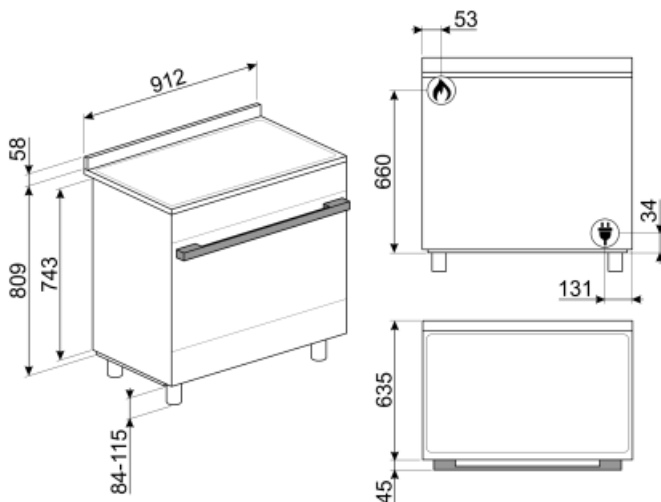

Not included accessories



TPKTR9

Stainless steel teppanyaki plate, suitable for Victoria TR9, Master and Sinfonia cookers



SFLK1

Child lock



PRTX

Refractory pizza stone with handles. D=35cm Not suitable for microwave ovens. Suitable for gas ovens, to be put on the griddle.



BGTR9

Cast iron grill plate suitable for 90 cm Victoria, 60 and 90 cm Master and Sinfonia cookers



GT3T

Totally extractable telescopic guides

PPR9



















Refractory pizza stone without handles. Squared shaped stone: L64xH2,3xP37,5 cm Suitable also for gas ovens, to be put on the griddle.









PALPZ

Pizza shovel with folding handle. Dimensions L31.5 x H32.5 cm. Easy and convenient to use and store. Perfect for serving pizza, bread and savory pastries in a safe and professional way.

Symbols glossary (TT)

 <p>Heavy duty cast iron pan stands: for maximum stability and strength.</p>	 <p>Air cooling system: to ensure a safe surface temperatures.</p>
 <p>Defrost by time: Manual defrost function. At the end of the set duration, the function stops.</p>	 <p>Triple glazed doors: Number of glazed doors.</p>
 <p>Ever Clean Enamel: Ever Clean enamel is applied electrostatically, corner to corner and edge to edge to prevent cracking or cracks over time. It is a particular pyrolytic enamel, resistant to acids which, in addition to being pleasantly bright, promotes greater cleaning of the oven walls, thanks to its lower porosity. It is baked at over 850 ° C and slowly polymerized at a scientifically determined rate to ensure uniform depth and strength Ever Clean enamel creates an impeccable finish both on the inside of the oven and on the trays, making the surfaces of the oven incredibly easy to maintain over time as it reduces the adhesion of fat during cooking</p>	 <p>Fan assisted base: the mix of fan and lower heating element alone allows to finish cooking foods already cooked on the surface but not internally more quickly. This system is recommended to finish cooking foods that are already well cooked on the surface, but not internally, which therefore require a moderate higher heat. Ideal for any type of food.</p>
 <p>Fan assisted: Intense and homogeneous traditional cooking, also suitable for complex recipes. The fan is active and the heat comes from below and from above at the same time. Ventilated cooking ensures a faster and more homogeneous result, leaving fragrant foods outside and moister inside. Ideal for baked pasta, biscuits, roasts and cobblers.</p>	 <p>Static: Traditional cooking suitable for the preparation of one dish at a time. The fan is not active and the heat comes from below and from above at the same time. Static cooking is slower and more delicate, ideal in order to get well cooked and dry dishes even inside. Ideal for cooking all types of roasts, fatty meats, bread, filled cakes.</p>
 <p>Base: the heat comes only from the bottom of the cavity. The fan is not active. Ideal for sweet and savory pies, cobblers and pizzas. Designed to complete cooking and make food more crunchy This symbol in gas ovens indicates the gas burner.</p>	 <p>Circulaire: it is the perfect function for cooking all types of dishes in a more delicate way. The heat comes from the back of the oven and is distributed quickly and evenly The fan is active. It is also ideal for cooking on multiple levels without mixing smells and flavors.</p>
 <p>Grill: Very intense heat coming only from above from a double heating element. The fan is not active. Provides excellent grilling and gratinating results. Used at the end of cooking, it gives a uniform browning to dishes.</p>	 <p>Half grill: For rapid cooking and browning of foods. Best results can be obtained by using the top shelf for small items, the lower shelves for larger ones, such as chops or sausages. For half grill heat is generated only at the centre of the element, so is ideal for smaller quantities.</p>
 <p>Fan grill: very intense heat coming only from above from a double heating element The fan is active. It allows the optimal grilling of thickest meats. Ideal for large cuts of meat.</p>	 <p>Pizza function: Specific function for cooking pizza in a pan. It allows to obtain a pizza that is soft inside and crispy outside with the topping perfectly cooked, not dry and not burnt.</p>
 <p>Rotisserie: The rotisserie (where installed) works in combination with the grill element to brown foods to perfection.</p>	 <p>All glass inner door: All glass inner door, a single flat surface which is simple to keep clean.</p>
 <p>The inner door glass: can be removed with a few quick movements for cleaning.</p>	 <p>Side lights: Two opposing side lights increase visibility inside the oven.</p>

-
- | | |
|--|--|
|  The oven cavity has 5 different cooking levels. |  Soft close: all models are equipped with advanced function of smooth closing of the door, which allows the device to close smoothly and quietly. |
|  Telescopic rails: allow you to pull out the dish and check it without having to remove it from the oven entirely. |  Tilting grill: the tilting grill can be easily unhooked to move the heating element and clean the roof of the appliance in one simple step. |
|  Ultra rapid burners: Powerful ultra rapid burners offer up to 5kw of power. |  Vapor Clean: a simple cleaning function using steam to loosen deposits in the oven cavity. |