

CPF48UGMOG

Cooker size	48"
Type of main oven	Thermo-ventilated
Type of second oven	Static
EAN code	8017709266752













Aesthetics

	Aesthetic	Portofino	Serigraphy colour	Black
	Colour	Olive green	Handle	Smeg Portofino
	Design	Flush fit	Plinth	Black
	Type of pan stands	Cast Iron	Storage compartment	Door
	Hob colour	Stainless steel	Logo	Assembled st/steel
	Display	Touch	Logo position	Facia below the oven
	No. of controls	10		

Programs / Functions

No. of cooking functions 9

Traditional cooking functions

 Static	 Fan assisted	 Circulaire
 Small grill	 Large grill	 Fan grill (large)
 Base	 Fan assisted bottom	 Pizza
 Rotisserie		

Cleaning functions

 Vapor clean
--

Other functions

 Defrost by time

Programs / Functions Auxiliary Oven

Bottom element + fan



Hob technical features

Total no. of cook zones 6

Left - 5.3 kW - 18000 BTU

Rear centre - 3.5 kW - 12000 BTU

Front centre - 1.31 kW - 4500 BTU

Rear right - 3.5 kW - 12000 BTU

Front right - 2.34 kW - 8000 BTU

Central - 1.90 kW - 6500 BTU

1.60 (BBQ) kW - 5500 (BBQ) BTU

Gas safety valves Yes

Burner caps

Matt black enamelled

Main Oven Technical Features



No. of lights 2

Fan number 3

Gross volume, 1st cavity 0.16 cu. ft.

Cavity material Ever Clean enamel

No. of shelves 5

Type of shelves Metal racks

Light type Halogen

Light Power 40 W

Cooking time setting Start and Stop

Light when oven door is open Yes

Removable door Yes

Total no. of door glasses 3

Safety Thermostat Yes

Cooling system Tangential

Lower heating element power 1700 W

Upper heating element - Power 1200 W

Grill element 1700 W

Large grill - Power 2900 W

Circular heating element - Power 1500 W

Grill type Electric

Tilting grill Yes

Soft Close system Yes

Options Main Oven

Timer Yes

End of cooking acoustic alarm Yes

Minimum Temperature 49 °F

Maximum temperature 500 °F

Second Oven Technical Features



Fan number	1	Removable door	Yes
Gross volume, 2nd cavity	1.5 cu. ft.	No. total door glasses	3
Cavity material	Ever Clean enamel	Safety Thermostat	Yes
No. of shelves	5	Cooling system	Tangential
Type of shelves	Metal racks	Lower heating element - power	750 W
No. of lights	2	Large grill - Power	2050 W
Light type	Halogen	Circular heating element - Power	1500 W
Light Power	40 W	Tilting grill	Yes
Light when oven door is open	Yes		

Options Auxiliary Oven

Minimum Temperature	49 °F	Maximum temperature	450 °F
----------------------------	-------	----------------------------	--------

Accessories included for Main Oven & Hob



Cast iron wok support	1	40mm deep tray	1
TOP Oven grid with back stop	2	Telescopic Guide rails, total Extraction	1

Accessories included for Secondary Oven



Rack with back and side stop	1	Grill mesh	1
Wide baking tray	1	Telescopic Guide rails, total Extraction	1

Electrical Connection

Plug	Not present	Power supply cable length	47 1/4 "
Electrical connection rating	8000 W	Frequency	60 Hz
Current	50 A	Terminal block	5 poles
Voltage	240/208 V		

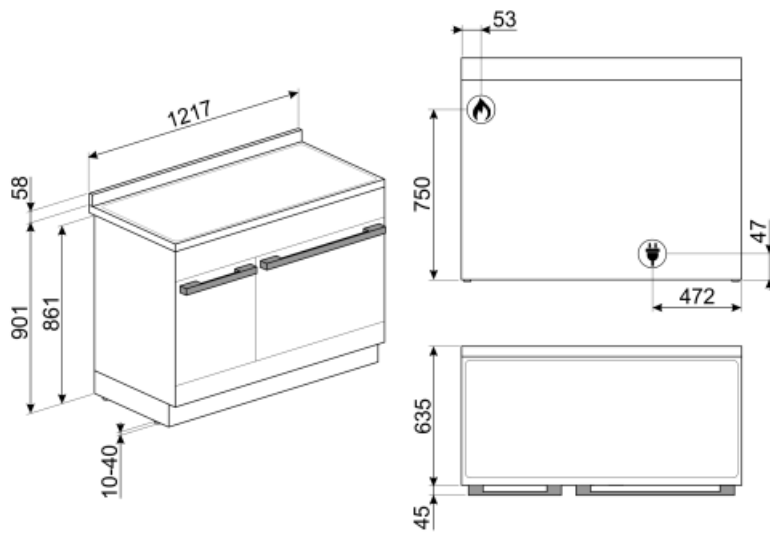

Not included accessories



SFLK1
Child lock



PPR9
Refractory pizza stone without handles.
Squared shaped stone: L64xH2,3xP37,5
cm Suitable also for gas ovens, to be
put on the griddle.



GTT
Totally extractable telescopic guides (1
level), suitable for traditional ovens.
Made in stainless steel, they guarantee
stability and facilitate the smooth
extraction of the trays.





















PRTX
Refractory pizza stone with handles.
D=35cm Not suitable for microwave
ovens. Suitable for gas ovens, to be
put on the griddle.



PALPZ
Pizza shovel with folding handle.
Dimensions L31.5 x H32.5 cm. Easy
and convenient to use and store.
Perfect for serving pizza, bread and
savory pastries in a safe and
professional way.

Symbols glossary (TT)

 <p>Heavy duty cast iron pan stands: for maximum stability and strength.</p>	 <p>Air cooling system: to ensure a safe surface temperatures.</p>
 <p>Defrost by time: Manual defrost function. At the end of the set duration, the function stops.</p>	 <p>Triple glazed doors: Number of glazed doors.</p>
 <p>Ever Clean Enamel: Ever Clean enamel is applied electrostatically, corner to corner and edge to edge to prevent cracking or cracks over time. It is a particular pyrolytic enamel, resistant to acids which, in addition to being pleasantly bright, promotes greater cleaning of the oven walls, thanks to its lower porosity. It is baked at over 850 ° C and slowly polymerized at a scientifically determined rate to ensure uniform depth and strength Ever Clean enamel creates an impeccable finish both on the inside of the oven and on the trays, making the surfaces of the oven incredibly easy to maintain over time as it reduces the adhesion of fat during cooking</p>	 <p>Fan assisted base: the mix of fan and lower heating element alone allows to finish cooking foods already cooked on the surface but not internally more quickly. This system is recommended to finish cooking foods that are already well cooked on the surface, but not internally, which therefore require a moderate higher heat. Ideal for any type of food.</p>
 <p>Fan assisted: Intense and homogeneous traditional cooking, also suitable for complex recipes. The fan is active and the heat comes from below and from above at the same time. Ventilated cooking ensures a faster and more homogeneous result, leaving fragrant foods outside and moister inside. Ideal for baked pasta, biscuits, roasts and cobblers.</p>	 <p>Static: Traditional cooking suitable for the preparation of one dish at a time. The fan is not active and the heat comes from below and from above at the same time. Static cooking is slower and more delicate, ideal in order to get well cooked and dry dishes even inside. Ideal for cooking all types of roasts, fatty meats, bread, filled cakes.</p>
 <p>Base: the heat comes only from the bottom of the cavity. The fan is not active. Ideal for sweet and savory pies, cobblers and pizzas. Designed to complete cooking and make food more crunchy This symbol in gas ovens indicates the gas burner.</p>	 <p>Circulaire: it is the perfect function for cooking all types of dishes in a more delicate way. The heat comes from the back of the oven and is distributed quickly and evenly The fan is active. It is also ideal for cooking on multiple levels without mixing smells and flavors.</p>
 <p>Grill: Very intense heat coming only from above from a double heating element. The fan is not active. Provides excellent grilling and gratinating results. Used at the end of cooking, it gives a uniform browning to dishes.</p>	 <p>Half grill: For rapid cooking and browning of foods. Best results can be obtained by using the top shelf for small items, the lower shelves for larger ones, such as chops or sausages. For half grill heat is generated only at the centre of the element, so is ideal for smaller quantities.</p>
 <p>Fan grill: very intense heat coming only from above from a double heating element The fan is active. It allows the optimal grilling of thickest meats. Ideal for large cuts of meat.</p>	 <p>Pizza function: Specific function for cooking pizza in a pan. It allows to obtain a pizza that is soft inside and crispy outside with the topping perfectly cooked, not dry and not burnt.</p>
 <p>Rotisserie: The rotisserie (where installed) works in combination with the grill element to brown foods to perfection.</p>	 <p>Side lights: Two opposing side lights increase visibility inside the oven.</p>
 <p>The oven cavity has 5 different cooking levels.</p>	 <p>Soft close: all models are equipped with advanced function of smooth closing of the door, which allows the device to close smoothly and quietly.</p>



Telescopic rails: allow you to pull out the dish and check it without having to remove it from the oven entirely.



Tilting grill: the tilting grill can be easily unhooked to move the heating element and clean the roof of the appliance in one simple step.



Vapor Clean: a simple cleaning function using steam to loosen deposits in the oven cavity.