

USER GUIDE

# VP320

Chamber Vacuum Sealer



**VACMASTER**

# Welcome

Thank you for purchasing the VacMaster® VP320 Chamber Vacuum Sealer. You are about to use one of the most powerful vacuum sealers available.

With the help of the VP320, you will now be able to keep food fresh for longer, deliver consistent portion control, and streamline your operations with programmable seal and vacuum time settings.

The VP320 is a chamber vacuum system, which offers two distinct advantages over non-chamber, external suction units. First, a much higher level of vacuum can be achieved, which means a longer shelf life for foods that you package. Secondly, liquids and liquid-rich foods can be effectively vacuum packaged. Foods like fresh meats, fish, soups, stews and marinated vegetables are packaged quickly with ease and no mess. The VacMaster® VP320 is perfect for storage, cook chill, portion control, sous vide, processing game and more.

Register your product and get support at  
[www.VacMasterFresh.com](http://www.VacMasterFresh.com)

## Contents

Safeguards .....	4
Tips.....	5
Features .....	6
Control Panel.....	7
How To.....	8
Troubleshooting.....	14
Cleaning and Storage.....	15
Maintenance .....	16
Vacuum Packaging Guidelines.....	18
Parts.....	19
Packaging Info.....	22
More Resources.....	23
Specs.. ..	24
Notes .....	25
Warranty and Registration .....	27



# YOU MUST ADD OIL BEFORE USE!

**FAILURE TO DO SO WILL DAMAGE THE PUMP!**

Read and complete the following to prevent any damage.

Oil must be added to the vacuum pump before using.

VacMaster® model VP320 uses an oil vacuum pump.  
For shipping purposes there is no oil in the pump. Oil must be added.

## Adding Oil to Vacuum Pump

Turn off and unplug machine to prevent electrocution.

1. Using VacMaster approved 10W non-detergent hydraulic oil , fill the enclosed plastic oil bottle.
2. Locate the **oil fill bolt (A)** on the top of the vacuum pump.
3. Remove oil fill bolt.
4. Watching **oil site glass (B)** insert end of oil bottle into hole.
5. Fill oil level between 1/2 to 3/4 of site glass.
  - Do not overfill. Overfill can cause damage to the vacuum pump.
6. Replace and tighten bolt to vacuum pump.

**NOTE:** Pump requires approximately 8 fluid ounces of oil (approx. 1 cup).  
Use only approved VacMaster® vacuum oil.

## Side of Cabinet Housing

A. Oil Fill Bolt

B. Oil Site Glass



## *Important Safeguards*

**WARNING** – When using electrical appliances, basic safety precautions should always be followed to reduce the risk of fire, electric shock, and/or injury to persons, including the following:

1. Read all instructions.
2. This appliance is not intended for use by persons with reduced physical, sensory, or mental capabilities, or lack of experience and knowledge, unless they are closely supervised and instructed concerning use of the appliance by a person responsible for their safety.
3. This appliance is not to be used by children. Close supervision is necessary when any appliance is used near children. Children should be supervised to ensure that they do not play with the appliance.
4. Never let the vacuum sealer run unattended. Disconnect the vacuum sealer from the power source before leaving the work area.
5. To protect against risk of electric shock, do not immerse cord, plug, or vacuum sealer in water or other liquid.
6. To reduce the risk of electric shock and injury to persons, disconnect from power supply when not in use, before cleaning and before servicing.
7. To provide continued protection against risk, do not operate any appliance with a damaged supply cord or plug, or after the appliance malfunctions or has been dropped or damaged in any manner. Supply cord replacement and repairs must be conducted by the manufacturer, its service agent, or similarly qualified persons in order to avoid a hazard. Call the provided customer service number for information on examination, repair, or adjustment.
8. The use of accessory attachments not recommended by the appliance manufacturer may cause injuries.
9. Do not use outdoors. Optimal operating temperature range is 65° to 75°.
10. Do not let cord hang over edge of table or counter, or touch hot surfaces, including stove.
11. Do not disassemble this appliance beyond instructions provided. Doing so may result in personal injury.
12. Do not place on or near a hot gas or electric burner, or in a heated oven.
13. Do not use for other than intended purpose.
14. This appliance is designed for a maximum vacuum ON time of 70 seconds and a minimum OFF time of 10 seconds between cycles. Stop the appliance and allow it to cool to ambient temperature if the appliance has been in use for 45 minutes.
15. This appliance is for commercial use only.



## *Important Tips*

- Vacuum packaging is not a substitute for canning. All perishables still need to be refrigerated or frozen.
- Follow all food safety regulations as outlined by the FDA at [www.FDA.gov](http://www.FDA.gov).
- Use only VacMaster® Vacuum Chamber Pouches and accessories.
- Some fruits and vegetables may release gases, known as outgassing. When packaging these fruits and vegetables, outgassing can cause the vacuum to be gradually lost over time. Blanching or freezing before vacuum packaging helps prevent this from occurring.
- Delicate foods can be frozen prior to packaging to protect them from getting crushed by the vacuum.
- Use VacMaster® Bone Guards to cover an item's sharp edges to prevent pouch punctures.
- Allow foods and liquids to cool to room temperature before vacuum packaging.
- Avoid overfilling the pouch. Leave a minimum of 3" of space between the contents and the open end of the pouch. This is called head space. This will prevent spills during the vacuum sealing process.
- To prevent wrinkles from forming in the seal, gently stretch the pouch flat along the seal bar before closing the lid.
- VacMaster® pouches are boilable, freezable, and microwavable. When microwaving, it is important to pierce or make a small cut in the pouch.

# VP320 Features



1. **Lid Gasket**
2. **Seal Pads**
3. **Control Panel**
4. **Vacuum Chamber**
5. **Lid Lock** - This feature is used to keep the lid closed while the machine is in storage. **DO NOT USE** while the machine is operating.
6. **Power Switch**
7. **Filler Plates** - Used to occupy space in the chamber. The plates allow for faster vacuum. When more space is occupied, there is less air to be removed from the chamber.
8. **Seal Bar**



# VP320 Control Panel

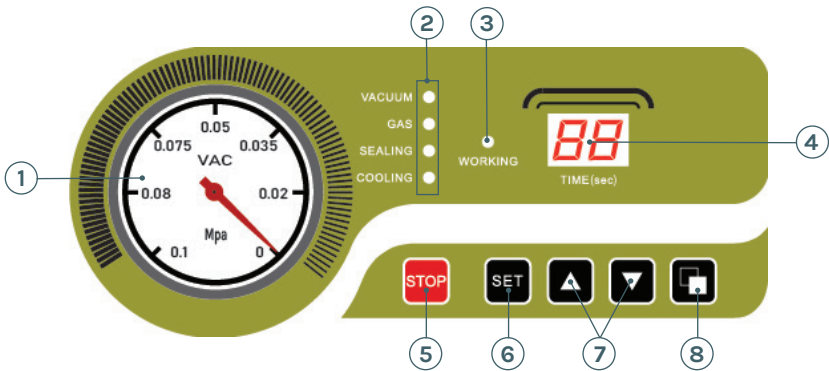

- 1. Vacuum Gauge**- Indicates the vacuum level inside the chamber.
- 2. Function Lights:**
  - Vacuum** - Illuminates to adjust vacuum time as well as during the vacuum process. During set up, adjust the vacuum time using the UP/DOWN Buttons.
  - Gas** - This model does not offer the gas flush option.
  - Sealing** - Illuminates to adjust vacuum time as well as during the sealing process. During set up, adjust the sealing time using the UP/DOWN Buttons.
  - Cooling** - Illuminates to adjust vacuum time as well as during the cooling process. During set up, adjust the cooling using the UP/DOWN buttons.
- 3. Working Indicator Light** - Illuminates to indicate the machine is in use.
- 4. LED Screen (Time)** - Displays current function or cycle time, measured in seconds.
- 5. STOP Button** - Press to stop the cycle and immediately seal the pouch. This button will only work when the machine is in the vacuum process.
- 6. SET Button** - Press to select the vacuum time, sealing time, or cooling time. Use with the UP/DOWN buttons.
- 7. UP/DOWN Buttons** - Press to increase or decrease vacuum time, sealing time, or cooling time.
- 8. Program Button** - Use to program 10 unique vacuum and seal time cycles

### How to Change the Oil

1. Run vacuum process a couple of times to "warm up" the oil.
2. Turn off machine and unplug to prevent electrocution.
3. Locate the drain & fill plugs on the side of the unit.
4. Locate drain bolt on underneath side of vacuum pump.
5. For access and ease of draining the oil, position machine so the drain bolt is "clear" and the dirty oil can be captured.
6. Oil will flow immediately when bolt is removed. Place catch cup underneath before removing drain bolt.
7. Capture oil from pump. When oil is completely drained, replace and tighten bolt. (Dispose of old oil properly, according to your local and state regulations.)
8. Follow the "Adding Oil to Vacuum Pump" instructions at beginning of manual. Do not use machine until oil has been added.



### Vacuum Pump Maintenance

The VP320 vacuum pump requires periodic oil changes. Required oil change schedule:

- First oil change: 1 week after use.
- Future oil changes: every 3 months or 250 cycles.

Using pump site glass, check the oil level and color frequently.

- Oil must remain between  $\frac{1}{4}$  and  $\frac{3}{4}$  of site glass.
- With use, the pump oil will become cloudy, dark or even "milky". Once oil becomes discolored, change oil replacing with new VacMaster® vacuum oil.

## How to Use

### Set Up - Powering up the VP320

1. Attach the power cord and plug the machine into a grounded electrical outlet - Properly insert the electrical cord into the power outlet on the back of the machine and then plug the cord into the wall outlet.
2. Open the machine lid - Release the lid lock, located on the right side of the machine, and allow the lid to lift and remain open.
3. Do not stand over the lid

**IMPORTANT:** Do not turn the machine on until the lid lock has been released. The lid lock feature is used *ONLY* to keep the lid closed while the machine is in storage.

4. To power ON press "I" on the power switch.
5. To power OFF, press "O" on the power switch.



### Set Up - Adjusting the VP320 Timing Controls

**NOTE:** All timing adjustments must be made with the lid lock off and the lid open.

To adjust/set the timing controls, press the SET button on the control panel until the required label (Vacuum, Sealing or Cooling) is illuminated. For each selection, the current time setting will show on the LED Screen. All time settings are displayed in seconds.

For initial testing, the time settings should be:

**Vacuum Time** - 40 seconds

**Sealing Time** - 0.6 seconds

**Cooling Time** - 2.0 seconds

To change the settings, please read the instructions for each control on Page 7.

## How to Use

### Set Up - Adjusting the VP320 Timing Controls

**Vacuum Time:** To increase or decrease the vacuum time, press the SET button until VACUUM is illuminated and then use the UP/DOWN buttons to adjust the vacuum time accordingly. The time setting will display on the LED Screen on the control panel.

**NOTE:** *Filler plates can be used to reduce the vacuum time required. Place the filler plates inside the chamber as desired. Filler plates occupy space, leaving less air to be removed from the chamber. If you require more space inside the chamber, remove the filler plates to accommodate your product.*

**Sealing Time:** To increase or decrease the sealing time, press the SET button until SEALING is illuminated and then use the UP/DOWN buttons to adjust the sealing time to accommodate your application. It is recommended that you make adjustments in 0.2 second increments to avoid melting the pouch.

**NOTE:** *For thicker pouches, increase the seal time in 0.2 second increments until the pouch seals completely. In addition, for thinner pouches, decrease the seal time in 0.2 second increments to avoid over-sealing the pouch.*

**Cooling Time:** To increase or decrease the cooling time, press the SET button until COOLING is illuminated and then use the UP/DOWN buttons to adjust the cooling time accordingly.

**NOTE:** *The VP320 settings will always default to the most recently used settings on the machine*

**TIP:** To prolong the life of your seal bar, set the cooling time to twice the sealing time.

**NOTE:** *After setting the timing controls, press the SET button until the function lights on the control panel are no longer illuminated. The machine will not start until all function lights are off.*

#### 1. Select a vacuum chamber pouch

Select the proper size of vacuum chamber pouch for the product that you are packaging. Make sure that the mouth of the pouch does not exceed the length of the seal bar and make sure the entire pouch fits inside the chamber. Allow 3" of extra headspace at the top of the pouch to ensure a quality, air-tight seal. The VP320 accepts vacuum chamber pouches up to 16"W x 18"L in size.



# How to Use

## 2. Fill the pouch and place inside the chamber

Fill the pouch with the product to be vacuum packaged and place the pouch inside the chamber. Keep pouches that contain liquids or wet product below the height of the seal bar. Lay the pouch flat inside the chamber, with the opening of the pouch across the seal bar. Make sure that the pouch lies flat across the seal bar and is free of wrinkles. Note: The entire pouch, including the opening, must remain inside the chamber.

## 3. Close the machine lid to vacuum and seal

Close the lid and press down firmly for 2-3 seconds or until the vacuum gauge begins to move.

## 4. Inspect the pouch

When the lid opens, remove and inspect the pouch.

**Vacuum confirmation** - Check the quality of the vacuum by looking at the tightness of the pouch and the product. Look for air pockets or air leaks. If you notice that the product is not vacuum packaged tightly, then increase the vacuum time by 5 seconds, vacuum and seal again.

**Seal confirmation** - Inspect the pouch seal. A positive seal will appear clear upon inspection. If the seal is spotty or incomplete, increase the seal time by 0.1 second. If the seal appears white or milky, decrease the seal time by 0.1 second. Once the settings are determined for your application, vacuum and seal again. If the product is vacuumed and sealed tightly, then the process is complete.

## 5. ED Code - stands for end of demonstration. You are ready for a new cycle.

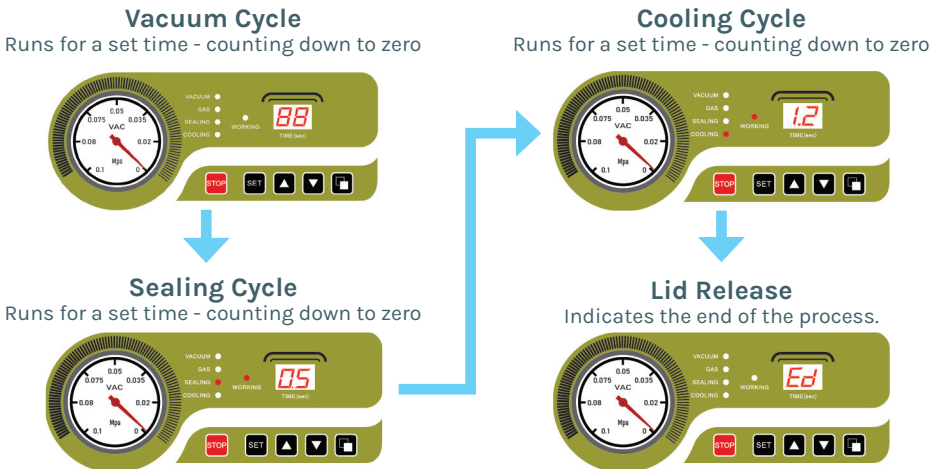

## How to Use

### Programmable Vacuum Cycle Instructions

This VacMaster chamber vacuum sealer is now equipped with a new feature that allows you to program and store up to 10 different seal cycle settings. Changing from liquids to solids to delicate items has never been easier to get that perfect amount of vacuum and a double seal for an additional layer of protection.

Also included is an oil change alert that, after 250 uses, reminds you to change the oil. This reminder is intended to keep your machine in tip-top shape. As a rule of thumb change your oil at the 250 uses alert or after 3 months whichever comes first.

**CO Code** - This stands for change oil.

Once complete, press "Set" "Up" "Down" (all 3) at the same time for 3 seconds. This will reset and clear this code.

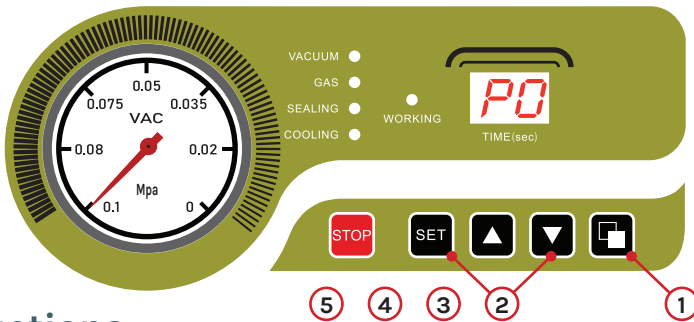

### Instructions

1. Press the program button  on the right side of the control panel to bring up P0 on the LED Display.
2. Press the SET button to change your desired vacuum time. Use up or down arrows to adjust desired vacuum time.
3. Press SET again to change the seal time. Use up or down arrows to adjust desired seal time.
4. Press SET button again to change your cool-down time. Use up or down arrows to adjust desired cool-down time. Add at least 1 Second more to cooling time over sealing time.
5. Press SET one last time to save the settings.
6. You are now ready to vacuum seal.
7. To create a new preset, press the program button to change to P1 and repeat the process stated above.
8. Set up and save up to 10 unique settings.
9. To change programed setting, simply press the program button

## *How to Use*

### Tips & Suggestions for Program Settings

- The vacuum time can be adjusted to your desired length.
- Suggested vacuum time should be set to
  - 18-20 for liquids/powders.
  - 35-40 is a good starting point for other products.

All settings are for 3 mil bags. The seal time and cool down time should only be changed if you move up in thickness of bags. For different thickness bags, increase both seal and cool down times by .2 seconds at a time until you get a good seal.

**Please scan the QR code for an instructional video on the programmable functions.**



# Troubleshooting

## VP320 will not turn on -

- Make sure the machine is properly plugged into a grounded outlet.
- Check the power cord for tears and frays. Do not use this machine if the power cord is damaged.
- Make sure the power switch is turned on. The LED screen will be illuminated when on.
- If you see 'F1' displayed on the LED screen and the machine will not function, make sure the lid is open and turn the power off. Turn the machine back on and it should return to working order.

## VP320 does not pull a complete vacuum with pouch -

- The vacuum time may not be set high enough. Set the vacuum time higher and vacuum again.
- To vacuum and seal properly, the opening of the pouch must be within the vacuum chamber. For detailed instructions, refer to "How To Use the VacMaster® VP320 Chamber Vacuum Sealer".
- The seal bar, lid gasket and vacuum pouch need to be clean, dry and free of debris for the vacuum process to be successful. Wipe surface of the seal bar, lid gasket and the inside of the pouch and try again.

## Vacuum pouch loses vacuum after being sealed -

- Sharp items can poke small holes in pouches. To prevent this, cover sharp edges with VacMaster" Bone Guard and vacuum in a new pouch.
- Some fruits and vegetables can release gases (outgassing) if not properly blanched or frozen before packaging. Open the pouch. If you think food spoilage has begun, discard the food. If food spoilage has not yet begun, consume immediately. If in doubt, discard the food.

## High elevation may cause the gauge to not go all the way green.

## VP320 is not sealing pouch properly -

- The seal time may not be long enough. Increase the seal time and try again.
- Pouches will not seal if any moisture, food particles or debris are present in the seal area. Wipe the inside of the pouch clean and try again.
- Pouches must be properly placed along the seal bar. Make sure the entire pouch is over the seal bar and there are no wrinkles in the pouch material.

If problems persist, contact customer support at  
**(800) 821-7849 or TechSupportARY@aryinc.com**  
for further assistance.

## Cleaning & Storage

- Disconnect the power cord from the electrical outlet by unplugging it. DO NOT disconnect by pulling on the cord.
- DO NOT immerse in water or spray directly with liquid.
- Check the Vacuum Chamber and Gasket, making sure they are clean and free of debris. If needed, use a clean, damp cloth with mild soap.
  - a. Wipe the vacuum chamber clean.
  - b. Wipe the gasket clean.
  - c. Wipe the seal area clean.
- Do not store the VP320 outside. 65° to 75° recommended.
- DO NOT use any acetone-based or abrasive cleaners on the lid or other plastic parts. Only clean lid with a damp cloth and mild soap.

## Maintenance Kit

- 1. Exhaust Filter:** Spare filter; should be checked every 6 -12 months. If the filter looks dirty or saturated in oil; it will need to be changed. If the filter looks clean; it is ok to put back into the pump & motor assembly.
- 2. Double Sided Tape:** Used for adhering the top bar that holds the seal pad in the lid.
- 3. 15-Amp Fuses (2x):** Can be used for replacing fuses located on the control transformer and the cord receptacle. NSF models will have a fuse on the seal transformer.
- 4. Seal Wire:** Used to replace seal wire that spans the length of the seal bar; should be replaced if the wire shows heavy discoloration.
- 5. Seal Tape:** Used to replace seal tape the covers the seal wires; should be replaced if the tape shows heavy discoloration, is torn, or is starting to lose the adhesive.
- 6. Oil Fill Bottle:** Used to fill pump with oil.
- 7. Hex/ Allen Wrench:** Used to removed tension blocks that hold the seal wire to the base of the seal bar.
- 8. #1 Screwdriver:** Used to un-thread screws on the cabinet of the machine and the screws to move the chamber.



# Maintenance

## Maintaining the Vacuum Pump

Using the pump site glass, check the oil level and color frequently.



1. Oil must remain between  $\frac{1}{2}$  to  $\frac{3}{4}$  of site glass.
2. With use, the pump oil will become cloudy, dark, or even "milky." Once oil becomes discolored, change the oil using new VacMaster® vacuum oil.

**NOTE:** The VP320 vacuum pump requires periodic oil changes. Follow this oil change schedule to ensure proper maintenance of your VP320.

- First oil change: one week after use.
- Future oil changes: every 3 months, or 250 cycles; whichever comes first.

## Changing/Replacing Oil



**IMPORTANT:** Make sure the VP320 is turned OFF and unplugged before adding oil. Do not plug in or use machine until oil has been properly filled.

**TIP:** Prepare oil in the pump - Run the vacuum process a few times. This will warm up the oil, allowing it to drain freely and remove any contaminants.



Remove the oil drain bolt - Locate the oil fill bolt on the side of the machine. Place an oil catch cup under drain bolt. Using your 7/8" socket wrench, remove the oil drain bolt. Oil will immediately begin to flow out of the machine.

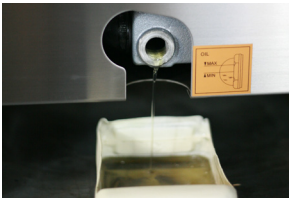

Capture oil - When oil is completely drained, replace the drain bolt. Dispose of old oil properly, according to your local and state regulations.

Refill pump with new oil - Follow the "Adding Oil to the VP320" instructions on page 3.



# Maintenance

## Changing the Filter

1. Remove the back panel
2. Remove the screws that hold the Upper Chamber in place - Two located on the front corners and two located on the back.
3. Pull the chamber assembly back about 3-4 inches
4. Remove the 4 screws that hold the filter plate on the end of the pump
5. Remove the plate and spring
6. Remove the exhaust filter
7. Install new filter
8. Reassemble all of the pieces in reverse order!

Plate  
Screws  
(Step #4)

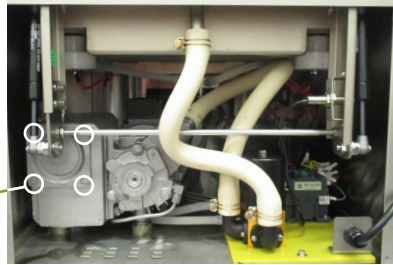

# Vacuum Packaging Guidelines

- Follow all food safety regulations as outlined by the FDA at [www.FDA.gov](http://www.FDA.gov).
- Vacuum packaging is NOT a substitute for canning.
- Vacuum packaging cannot reverse the deterioration of foods.
- Vacuum packaging is NOT a substitute for refrigeration or freezing.
- Some fruits and vegetables may release gases, known as outgassing. When packaging these fruits and vegetables, outgassing can cause the vacuum to be gradually lost over time. Blanching or freezing before vacuum packaging helps prevent this from occurring.

**NOTE:** Due to the risk of anaerobic bacteria, soft cheeses, fresh mushrooms, garlic and onions should never be vacuum packaged.

- It is critical that food handling and storage are maintained at low temperatures. You can reduce the growth of microorganisms at temperatures of 34°F or less. Freezing at 0°F will not kill microorganisms, but reduces the chances of them growing. For long-term food storage, always freeze foods that have been vacuumed packaged.

**NOTE:** Beef and other proteins may look darker after being vacuum packaged. This is due to the removal of oxygen and is not an indication of spoilage.

- All perishable foods must be refrigerated or frozen.

# Parts Information

## DOME ASSEMBLY

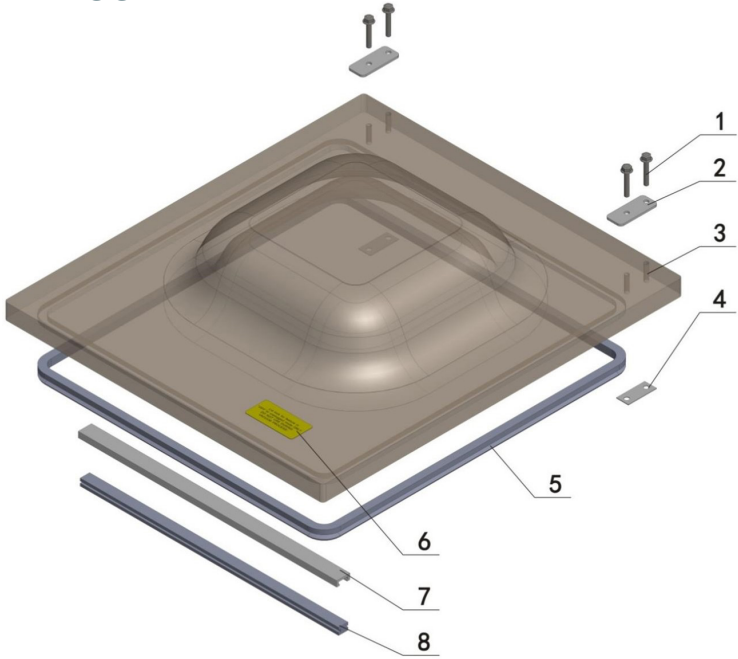

	Description	Qty	Part Number
<b>1</b>	Bolt	4	
<b>2</b>	Upper pressing plate	2	
<b>3</b>	Lid	1	979301
<b>4</b>	Lower pressing plate	2	
<b>5</b>	Lid Gasket	1	979426
	Lid Gasket (2nd option)	5	979263
<b>6</b>	Warning label	1	
<b>7</b>	Top Bar	1	979305
<b>8</b>	Seal Pad	1	979417

# Parts Information

## CHAMBER ASSEMBLY

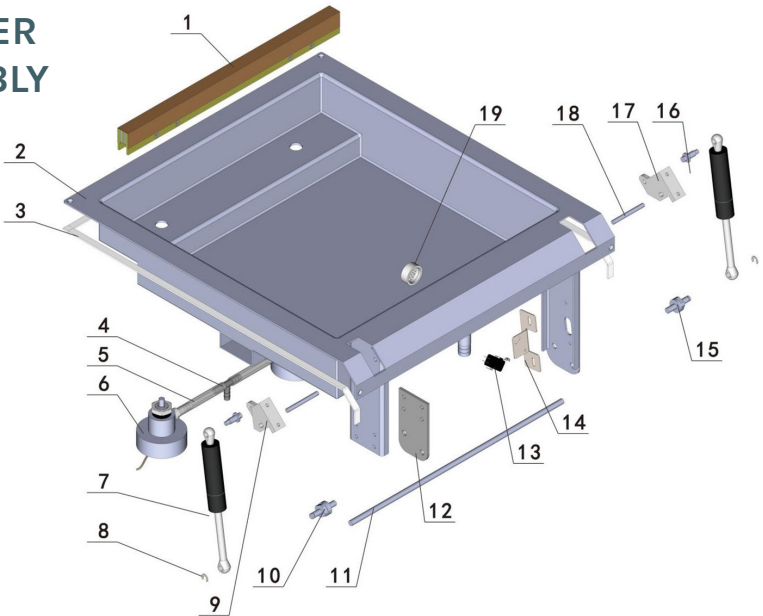

	Description	Qty	Part Number
1	Seal bar	1	979300
2	Chamber assembly	1	
3	White rubber strip	3	
4	T type connector	1	979254
5	Hose	2	979156
6	Piston assembly	2	979380
7	Gas shock	2	979356
8	Washer	2	
9	Left hinge	1	979352
10	Left fixation shaft	1	979357
11	Hinge support	1	
12	Gas shock support	1	
13	Microswitch	1	977482
14	Seat,microswitch	1	979399
15	Right fixation shaft	1	979357
16	Short shaft	2	979358-8
17	Right hinge	1	979352
18	Pin	2	979353
19	Cover, nozzle	1	

# Parts Information

## Housing Parts

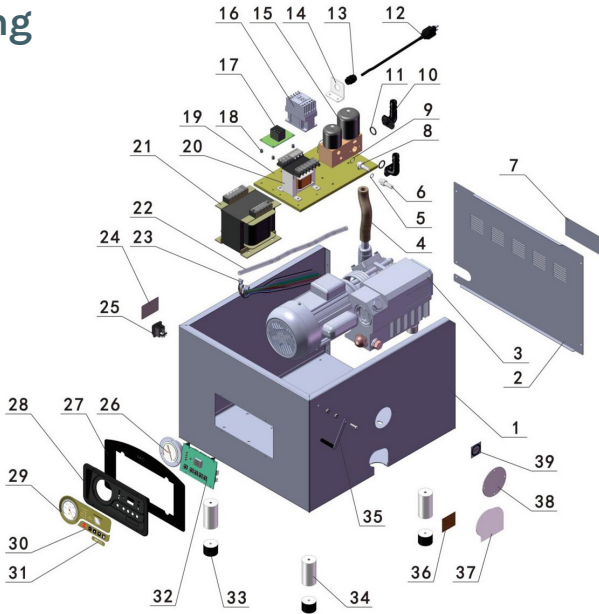

Part #	Part Name	Qty	Part #	Part Name	Qty
1	Machine hull	1	21	Heating transformer	1
2	Back cover	1	22	979156 Hose	1.5
3	979320 Pump	1	23	921785 Wire harness	1
4	977264 Hose	1	24	Adhesive sticker	1
5	O ring	1	25	979468 Power switch NSF	1
6	M10x1 pipe joint	1	26	979138 Power switch	1
7	Adhesive label	1	27	979126 Gauge	1
8	M14x1 pipe joint	1	27/28	979131 Faceplate, panel	1
9	O ring	1	29/30	977504 Green Panel decal stickers	1
10	Right angle joint	2	31	977505 Green Panel decal stickers for VP320	1
11	O ring	2	32	977501 Green Panel Programmable board	1
12	979404 Power cord	1	33	979159 Rubber Foot	1
13	Joint	1	34	Foot assembly	1
14	Bracket	1	35	979170 Lid latch assembly	
15	979360 Solenoid valve	1	36	Adhesive label	4
16	979141 AC contactor relay	1	37	976156 Cover, for Oil Drain	4
17	979136 Relay	1	38	976155 Cover, for Fill Hole	1
18	Relay seat		39	Adhesive label	1
19	Installation board	4			
20	979139 Control transformer	1			

# Packaging Information

With the VP320, you can easily package a wide variety of sizes and shapes. You can also prep and store smaller individual serving portions as well as bulk items.

- Keeps food fresh 3-5 times longer than conventional storage bags.
- Several sizes available to meet your packaging needs.
- Terrific for hundreds of applications in and out of the kitchen
- Safe for freezer, refrigeration, and microwave use.
- Re-Therm pouches are reinforced to be able to handle being boiled for up to 30 minutes. The other bags can be boiled, but not for that long without being compromised. When a normal bag becomes compromised, the pouch will begin to delaminate.
- Bag thickness available in standard 3mil or heavy duty 4mil.
- Bags are economically priced, giving you a better value.

The chamber of the VP320 can easily vacuum package the following sizes of vacuum pouches:

ITEM #	BAG DESCRIPTION	#	ITEM #	BAG DESCRIPTION	#
30765	2.5" X 10" Vacuum Chamber Pouches 3-Mil 2000/Box	6x	50724	10 X 12 Zipper Vacuum Chamber Pouches 3-Mil 1000/Box	1x
30766	6" X 7" Vacuum Chamber Pouches 3-Mil - 1000/Box	2x	30620	10 X 12 Vacuum Chamber Pouches 4-Mil 1000/Box	1x
30742	6" X 8" Vacuum Chamber Pouches 3-Mil - 1000/Box	2x	40725	10" X 13" Pouches 3-Mil Vacuum Chamber Pouches 250/Box	1x
30608	6" X 8" Vacuum Chamber Pouches 4-Mil - 1000/Box	2x	30725	10" X 13" Vacuum Chamber Pouches 3-Mil 1000/Box	1x
30720	6" X 8.5" Vacuum Chamber Pouches 3-Mil - 1000/Box	2x	30778	10" X 13" Vacuum Chamber Pouches 4-Mil 1000/Box	1x
30750	6" X 8.5" Re-Therm Vacuum Chamber Pouches 3-Mil 1-000/Box	2x	30776	10 X 13 Vacuum Chamber Pouches 5-Mil 1000/Box	1x
30721	6" X 10" Vacuum Chamber Pouches 3-Mil - 1000/Box	2x	30726	10" X 15" Vacuum Chamber Pouches 3-Mil 1000/Box	1x
30610	6" X 10" Vacuum Chamber Pouches 4-Mil - 1000/Box	2x	30749	10 X 15 Re-Therm Vacuum Chamber Pouches 3-Mil 1000/Box	1x
50717	6" X 10" Zipper Vacuum Chamber Pouches 3-Mil - 1000/Box	2x	50721	10 X 15 Zipper Vacuum Chamber Pouches 3-Mil 1000/Box	1x
40721	6" X 12" Pouches 3-Mil Flat Vacuum Chamber Pouches - 500/Box	2x	30752	10 X 16 Re-Therm Vacuum Chamber Pouches 3-Mil 1000/Box	1x
30743	6" X 12" Vacuum Chamber Pouches 3-Mil - 1000/Box	2x	30755	10 X 16 Vacuum Chamber Pouches 4-Mil 1000/Box	1x
30612	6" X 12" Vacuum Chamber Pouches 4-Mil - 1000/Box	2x	30745	10" X 18" Vacuum Chamber Pouches 3-Mil 500/Box	1x
50718	6" X 12" Zipper Vacuum Chamber Pouches 3-Mil - 1000/Box	2x	30622	10 X 18 Vacuum Chamber Pouches 4-Mil 500/Box	1x
30787	6" X 15" Vacuum Chamber Pouches 3-Mil - 1000/Box	2x	40726	11.5 X 13 Vacuum Chamber Pouches 3-Mil 250/Box	1x
30788	7 X 9 Vacuum Chamber Pouches 3-Mil 1000/Box	2x	40732	12 X 8 Horizontal Vacuum Chamber Pouches 3-Mil 250/Box	1x
30789	7 X 11 Vacuum Chamber Pouches 3-Mil 1000/Box	2x	40733	12 X 10 Horizontal Vacuum Chamber Pouches 3-Mil 250/Box	1x
30791	7 X 12 Vacuum Chamber Pouches 3-Mil 1000/Box	2x	30727	12" X 12" Vacuum Chamber Pouches 3-Mil 1000/Box	1x
40722	8" X 10" Pouches 3-Mil Flat Vacuum Chamber Pouches 500/Box	2x	40728	12 X 14 Vacuum Chamber Pouches 3-Mil 250/Box	1x
30722	8" X 10" Vacuum Chamber Pouches 3-Mil 1000/Box	2x	30728	12" X 14" Vacuum Chamber Pouches 3-Mil 1000/Box	1x
30614	8 X 10 Vacuum Chamber Pouches 4-Mil 1000/Box	2x	30624	12 X 14 Vacuum Chamber Pouches 4-Mil 1000/Box	1x
50719	8 X 10 Zipper Vacuum Chamber Pouches 3-Mil 1000/Box	2x	50726	12 X 14 Zipper Vacuum Chamber Pouches 3-Mil 1000/Box	1x
30723	8" X 12" Vacuum Chamber Pouches 3-Mil 1 000/Box	2x	30746	12" X 15" Vacuum Chamber Pouches 3-Mil 500/Box	1x
40751	8 X 12 Re-Therm Vacuum Chamber Pouches 3-Mil 1000/Box	2x	30731	12" X 16" Vacuum Chamber Pouches 3-Mil 500/Box	1x
30754	8 X 12 Vacuum Chamber Pouches 4-Mil 1000/Box	2x	30786	12 X 16 Vacuum Chamber Pouches 4-Mil 500/Box	1x
50720	8 X 12 Zipper Vacuum Chamber Pouches 3-Mil 1000/Box	2x	40796	12" X 16" Re-Therm Vacuum Chamber Pouches 4-Mil 500/Box	1x
30744	8" X 15" Vacuum Chamber Pouches 3-Mil 1000/Box	2x	30732	12" X 18" Vacuum Chamber Pouches 3-Mil 500/Box	1x
30618	8 X 15 Vacuum Chamber Pouches 4-Mil 1000/Box	2x	30757	12 X 18 Vacuum Chamber Pouches 4-Mil 500/Box	1x
50722	8 X 16 Zipper Vacuum Chamber Pouches 3-Mil 1000/Box	2x	30734	14" X 16" Vacuum Chamber Pouches 3-Mil 500 /Box	1x
30767	8 X 20 Vacuum Chamber Pouches 4-Mil 1000/Box	2x	30753	14 X 18 Re-Therm Vacuum Chamber Pouches 3-Mil 500/Box	1x
30777	9 X 12 Vacuum Chamber Pouches 3-Mil 1000/Box	1x	30783	16 X 16 Vacuum Chamber Pouches 3-Mil 500/Box	1x
40731	10 X 8 Horizontal Vacuum Chamber Pouches 3-Mil 250/Box	1x			
30724	10" X 10" Vacuum Chamber Pouches 3-Mil 1000/Box	1x			



## More Resources

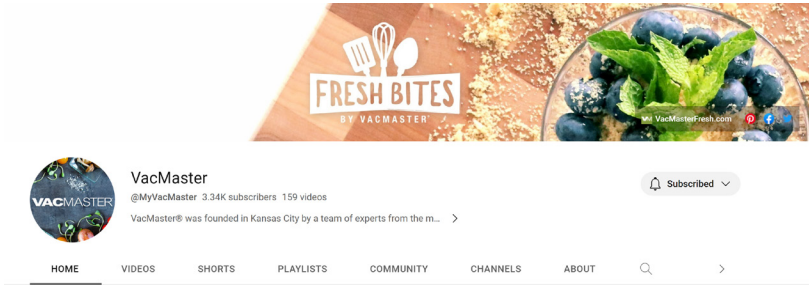

Check out our YouTube channel

[youtube.com/MyVacMaster](https://youtube.com/MyVacMaster)

to see how use VacMaster® products, get tips, and see our recipes!

Check out our Blog

[vacmasterfresh.com/fresh-bites-blog/](https://vacmasterfresh.com/fresh-bites-blog/)

We're also on

Facebook:

<https://www.facebook.com/vacmasterfresh>

Twitter:

<https://twitter.com/VacMasterFresh>

Instagram:

<https://www.instagram.com/vacmasterfresh/>

## Specs

SKU:	Machine Type:	Chamber Size:
VP320	Tabletop Chamber	16.75" x 18" x 7"
Seal Bar Length:	Vacuum Pump:	Cycle Time:
16"	1.5 HP Rotary Oil Pump	20-40 Seconds
Electrical Specs:	Machine Dimensions:	Weight:
Single Phase 110 V 30 Amp	22.25" x 20" x 20"	185 lbs
Maximum Bag/ Pouch Size:	Compatible Bags/ Pouches:	
16" x 18"	Chamber Vacuum Sealer Pouches	
Includes:		

60 Assorted Vacuum Chamber Pouches:

- 20 (8" X 8")
- 20 (8" X 12")
- 20 (10" X 13")

2 Filler Plates

Maintenance Kit

User's Guide



# *Notes*





# *Notes*



# Limited Warranty

ARY, Inc., a distributor and manufacturer of vacuum packaging and other machines (collectively, the "Goods"), extends to the purchaser of the Goods a Limited One Year Warranty, from the receipt of the Goods, under terms and conditions set out herein.

All Goods sold by ARY, Inc. are warranted to be free from defects in material and workmanship at the time of delivery to purchaser. Defective material may be returned to ARY, Inc. after inspection by an agent of ARY, Inc. and upon receipt from ARY, Inc. of shipping instructions specific to the defective Goods authorized by ARY, Inc. to be returned. ARY, Inc. at its sole option, may either (i) replace or repair any defective materials and workmanship (and return the Goods to purchaser without charge), (ii) refund the purchase price, or (iii) grant a reasonable allowance with the foregoing procedure.

This warranty is subject to the following limitations:

- i. ARY, Inc.'s responsibility and the purchaser's exclusive remedy under this warranty is limited to the repair or replacement of defects in material and workmanship, refund of the purchase price, or grant of a reasonable allowance on account of such defects, all as set forth above. ARY, Inc. is not responsible for any consequential damages resulting from the breach of this or any other express or implied warranty with respect to the Goods.
- ii. This express warranty is the only warranty applicable. It excludes all other express oral or written warranties and all warranties implied by law with respect to the Goods, including any warranties or merchantability or fitness for a particular purpose.
- iii. Every claim under this warranty shall be deemed waived by purchaser unless made in writing within one (1) year of the receipt of the Goods to which such claim relates.
- iv. This warranty, as to the Goods, is void (a) to repairs made by anyone other than ARY, Inc. without prior authorization from ARY, Inc., (b) to performance of any system of which ARY, Inc.'s Goods are a component part, (c) to deterioration by corrosion or any cause of failure other than defect of material or workmanship, (d) to any components of the Goods, including, without limitation, Teflon tape, lid gaskets and seal wire, or (e) if any of the Good or parts thereof have been tampered with or altered by someone other than ARY, Inc., or subjected to misuse, neglect, abuse, or misuse in application.

ARY, Inc.'s maximum liability hereunder, arising from any cause whatsoever, whether based in contract, tort (including negligence), strict liability, or any other theory of law, shall not exceed the purchase price. A suit based on any aforementioned cause of action must be commenced within one year from the date said action accrues.

Register your product and get technical support at:

[www.vacmasterfresh.com/product-registration/](http://www.vacmasterfresh.com/product-registration/)  
[vacmasterfresh.com/contact-us/](http://vacmasterfresh.com/contact-us/)

A Product of  
**VACMASTER**

P.O. Box 412888  
Kansas City, MO 64141

**VacMasterFresh.com**

800.821.7849