



USA CAN

AUTOMATIC RICE COOKER & WARMER

OPERATING INSTRUCTIONS

NS-RPC10/NS-RPC18

INDEX

IMPORTANT SAFEGUARDS.....	2
PARTS NAMES.....	6
COOKING RICE.....	7
CLEANING AND MAINTENANCE.....	10
TROUBLESHOOTING GUIDE.....	11
SPECIFICATIONS.....	12

IMPORTANT SAFEGUARDS

WHEN USING ELECTRICAL APPLIANCES, BASIC SAFETY PRECAUTIONS SHOULD ALWAYS BE FOLLOWED, INCLUDING THE FOLLOWING:

- 1** Read all instructions thoroughly.
- 2** Avoid touching hot surfaces and do not close or clog the steam vent opening under any circumstances. The handles and knobs are provided for your safety and protection.
- 3** To prevent hazardous operation or electric shock, do not immerse power cord, power plug, or rice cooker (except inner cooking pan and inner lid) in water or other liquids.
- 4** Close supervision is necessary when the appliance is used by or near children.
- 5** Unplug from outlet when not in use and before cleaning. Allow the appliance to cool before adding or removing parts, and before cleaning the appliance.
- 6** Do not use or operate the appliance with a damaged cord or plug. If the appliance malfunctions or has been damaged in any manner, unplug the appliance and return it to the nearest authorized service facility or dealer for examination, repair or adjustment.
- 7** The use of accessories or attachments not recommended by the appliance manufacturer may be hazardous or may cause malfunction.
- 8** Do not use outdoors.
- 9** Keep the power cord away from hot surfaces and do not let the cord hang over the edge of tables or counters.
- 10** Do not place the appliance on or near a heated surface such as a gas or electric stove, or in a heated oven.
- 11** Always use extreme caution when moving appliances containing hot contents or liquids.
- 12** To disconnect, turn the switch to "KEEP WARM" then remove plug from an electric outlet.
- 13** Do not use the appliance for other than intended or specified purposes.
- 14** To reduce the risk of electric shock, use only the supplied inner cooking pan.
- 15** The plug to the appliance should be attached first before plugging the cord into a wall outlet.

SAVE THESE INSTRUCTIONS

THIS APPLIANCE IS FOR HOUSEHOLD USE ONLY.



- a) A short power-supply cord (or detachable power-supply cord) is provided to reduce the risk resulting from becoming entangled in or tripping over a longer cord.
- b) Longer detachable power-supply cords or extension cords are available and may be used if care is exercised in their use.
- c) If a longer detachable power-supply cord or extension cord is used:
 - 1) The marked electrical rating of the cord set or extension cord should be at least as great as the electrical rating of the appliance;
 - 2) The cord should be arranged so that it will not drape over the countertop or tabletop where it can be pulled on by children or tripped over unintentionally; and
 - 3) If the appliance is of the grounded type, the cord set or extension cord should be a grounding-type 3-wire cord.

IMPORTANT SAFEGUARDS

Be sure to follow these instructions.









These WARNINGS and CAUTIONS are intended to prevent property damage or personal injury to you and others.

■ The degree of danger or damage by the misuse of this product is indicated as follows:

 WARNING Indicates risk of serious injury or death.	 CAUTION Indicates risk of injury, household or property damage if mishandled.
---	--

■ Prohibited or required actions are indicated as follows:

 Indicates a prohibited operation.	 Indicates a requirement or instruction that must be followed.
---	---

 WARNING	
 Do not modify the Rice Cooker. Only a repair technician should disassemble or repair this unit. Attempting to do so may cause fire, electric shock or injury. Make any repair inquiries to Zojirushi Customer Service.	 Only use this Rice Cooker to cook rice and keep rice warm as indicated in the Operating Instructions. Do not use the Rice Cooker if the Power Cord or Power Plug is damaged or if the Power Plug is loosely inserted into the electrical outlet. Doing so may cause electric shock, short circuit or fire. Do not damage the Power Cord. Do not bend, pull, twist, bundle or attempt to modify the Power Cord. Do not place it on or near high temperature surfaces or appliances, under heavy items or between objects. A damaged Power Cord can cause fire or electric shock. Do not use a power source other than 120V AC. Use of any other power supply voltage may cause fire or electric shock.
 Do not place your hands or face near the Steam Vent. Doing so may cause burns or scalding. Take special precautions with children and infants.	 Insert the Power Plug completely and securely into the electrical outlet. A loosely inserted Power Plug may cause electric shock, short circuit, smoke or fire. Use only an electrical outlet rated at 15 amperes minimum, and do not plug other devices into the same outlet. Plugging other devices into the same outlet may cause the electrical outlet to overheat, resulting in fire.
 Do not plug or unplug the Power Cord if your hands are wet. Doing so may cause electric shock or injury.	
 Do not immerse the Rice Cooker in water or splash it with water. Do not pour water directly into the Rice Cooker. Doing so may cause short circuit or electric shock.	
 Do not put any metal objects such as pins or wires into the Air Vent or crevices located at the bottom of the Rice Cooker. Doing so may cause electric shock or malfunction, resulting in injury. Do not allow children to use the Rice Cooker unsupervised. Keep it out of the reach of infants. Children are at risk of burns, electric shock or injury. Do not open the Outer Lid or move the Rice Cooker during cooking. Doing so may cause burns.	

● The illustrations used in these Operating Instructions may vary from the actual product you have purchased.

IMPORTANT SAFEGUARDS (cont.)

WARNING



If the blades or surface of the Power Plug become soiled, wipe them clean.
A dirty Power Plug may cause fire.

Stop using the Rice Cooker immediately in the event of malfunction or breakdown.

Continued use of the Rice Cooker under these circumstances may cause smoke, fire, electric shock, or injury.

Use a grounded electrical outlet.

Failing to do so may cause electric shock or injury.



This appliance is not intended for use by persons (including children) with reduced physical, sensory or mental capabilities, or lack of experience and knowledge, unless they have been given supervision or instruction concerning use of the appliance by a person responsible for their safety. Children should be supervised to ensure that they do not play with the appliance.

CAUTION



Do not touch hot surfaces during or immediately after use.
(Just removing the Inner Cooking Pan will not turn off the power.)
Be careful of steam when opening the Outer Lid. Be careful not to touch the Inner Cooking Pan when loosening rice.
Touching hot surfaces may cause burns.



Do not touch the Open Button when moving the Rice Cooker.
Doing so may cause the Outer Lid to open, resulting in injury or burns.

Do not use the Rice Cooker where it may come into contact with water or near heat sources.
Doing so may cause electric shock, short circuit, or can deform the Rice Cooker.

Do not use cookware other than the provided Inner Cooking Pan.
Doing so may cause the cookware to overheat or the Rice Cooker to malfunction.

Do not place or use the Rice Cooker on unstable surfaces, surfaces that are vulnerable to heat, or on induction heating (IH) cookers.
Doing so may cause injury or fire.



Do not use the Rice Cooker near walls or furniture. Allow enough room for steam to escape if using the Rice Cooker under shelving.
Failing to allow enough room may cause breakdown. Steam or heat may also damage, discolor, or deform walls, furniture, or shelving.

Do not use the Rice Cooker on a surface where the Air Vent located at the bottom of the Rice Cooker can become blocked or covered (such as on paper, cloth, carpet, plastic bag or aluminum sheet).
Doing so may cause breakdown or malfunction.

Do not use other Power Cords than the one provided.
Do not use the Power Cord for other appliances.
Doing so may cause malfunction or fire.



Unplug the Power Plug from the outlet when the Rice Cooker is not in use.
Leaving the Power Plug in an outlet may cause the insulation to become damaged, resulting in burns, injury, electric shock, short circuit or fire.

IMPORTANT SAFEGUARDS (cont.)

CAUTION



Please allow the Rice Cooker to cool down before cleaning.

Hot parts such as the Inner Lid, Inner Cooking Pan and Heating Plate may cause burns.

Always unplug the Rice Cooker by holding the Power Plug, not by pulling the Power Cord.

Pulling the Power Cord to unplug the Rice Cooker may cause electric shock, short circuit or fire.



Insert the Appliance Plug into the Plug Receptacle securely.

Failing to do so may cause electric shock, short circuit, smoke or fire.

If the Power Cord is damaged, it must be replaced with an appropriate cord or assembly made available by the manufacturer or its service agent.

IMPORTANT

When you are finished, be sure to unplug the Power Plug from the electrical outlet.

Just removing the Inner Cooking Pan will not turn off the power.

Do not cover the Main Body, especially the Steam Vent, with a cloth or other objects.

Doing so may cause deformation and/or discoloration of the Main Body or Outer Lid.

Do not place any utensils that will scratch the inside of the Inner Cooking Pan.

Doing so may deform or dent the Inner Cooking Pan, preventing the Rice Cooker from cooking properly.

Do not use the Rice Cooker where its steam may come into contact with other electrical appliances.

The steam may cause fire, malfunction, discoloration or deformation to other electrical appliances.

Do not operate the Rice Cooker if rice or other matter is stuck on the inside of the Main Body, the outside surface of the Inner Cooking Pan, the Center Sensor or the Heating Plate.

Doing so may burn the rice or otherwise cause imperfect cooking.

Do not damage, drop or deform the Inner Cooking Pan.

A damaged Inner Cooking Pan may not cook properly.

Do not cook when the Inner Cooking Pan is empty.

Doing so may cause breakdown of the Rice Cooker.

Do not use the Rice Cooker on top of an induction heating (IH) cooker.

Doing so may cause breakdown.

This appliance is intended for household use and similar applications listed below:

- Staff (employee) kitchen area in shops, offices and other working environments.
- * This appliance is not intended for use by many unspecified people for a long period of time.

This appliance must not be used in the following areas:

- Farm houses.
- By clients in hotels, motels and other commercial type environments.
- Bed and breakfast type environments.

PARTS NAMES

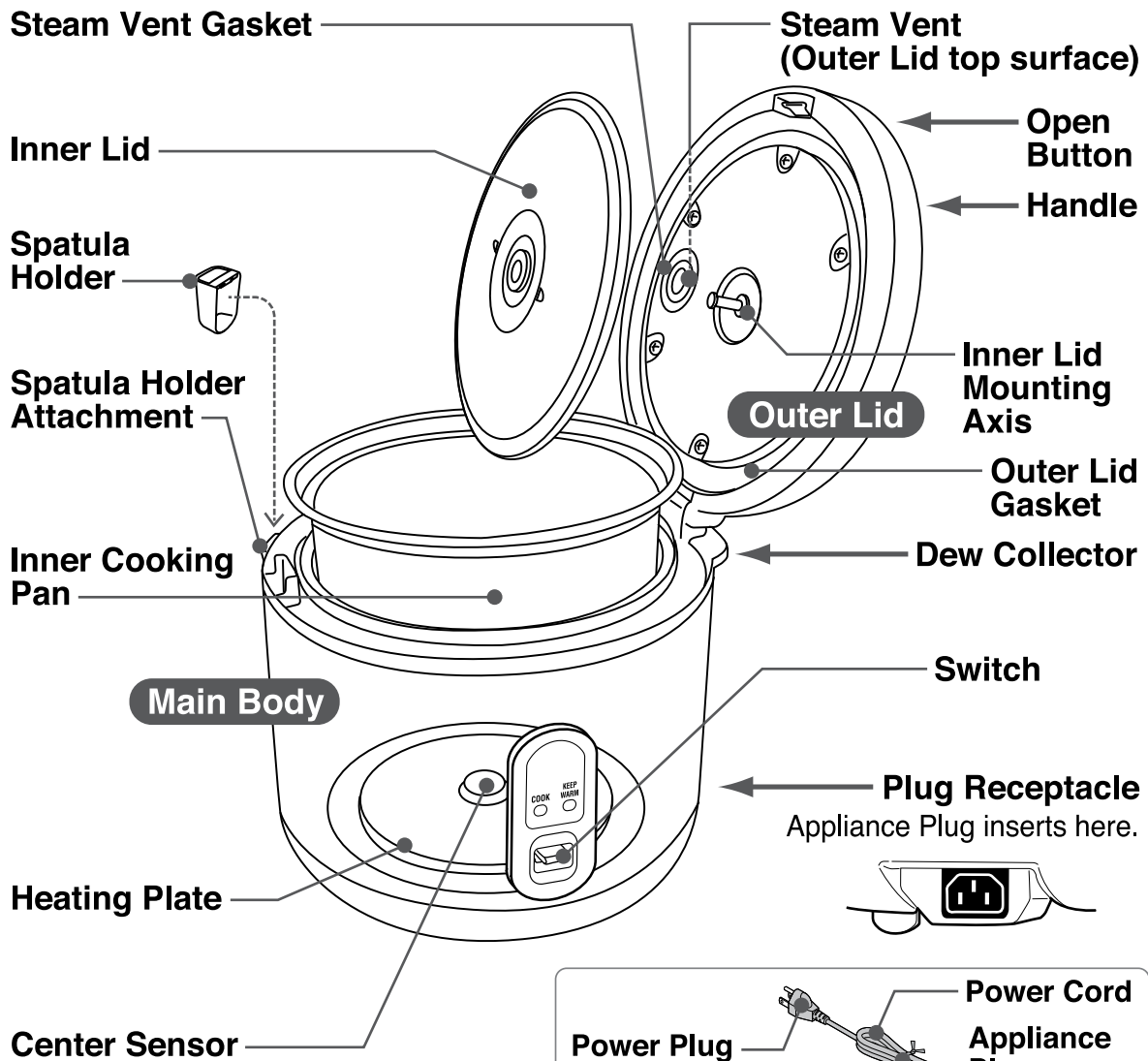

Power Cord

Power Plug

Twist Tie

Appliance Plug

- Please remove the Twist Tie holding the Power Cord before use.
- Do not use the Power Cord bundled up. Doing so may cause the Power Cord to become excessively hot, resulting in malfunction.

Accessories

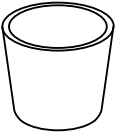

Measuring Cup
(1 Cup = approx. 6.1 oz. / approx. 180 mL)



Spatula Holder

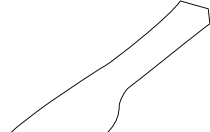

Spatula

COOKING RICE

● Please wash the Inner Cooking Pan, Inner Lid, and accessories before initial use. → pg. 10

1

Measure rice with the provided Measuring Cup.

Overfill the Measuring Cup with rice, then level off.



2

Clean the rice.

- Clean the rice in a different container, not the provided Inner Cooking Pan.
- Do not clean the rice or adjust the amount of water using hot water (95°F/35°C or above).

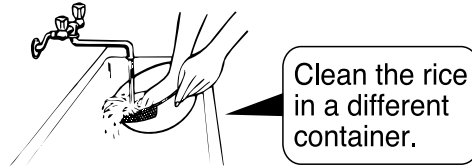

3

Adjust the amount of water.

- Place cleaned rice in the Inner Cooking Pan.
- On a flat surface, pour water over the rice in the Inner Cooking Pan, filling to the line that matches the number of cups of rice.
- Level the surface of rice.
- The water level serves as a standard guideline and the amount of water should be adjusted according to preference. (Adjust 1-2mm above or below the indicated water level.)
- When cooking 5.5 cups of rice, fill the Inner Cooking Pan with water to the 1.0 liter line.
- When not using the provided Measuring Cup, adjust the amount of water according to the liter lines on the left side.

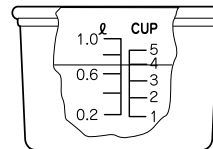

When cooking 4 cups of rice measured with the provided Measuring Cup, place the cleaned rice into the Inner Cooking Pan, and then fill with water to the 4 line on the right side, as shown in the figure on the left.

4

Place the Inner Cooking Pan into the Main Body and attach the Inner Lid. Close the Outer Lid.

Be sure to wipe moisture and foreign matter off the outer surface of the Inner Cooking Pan, the inside of the Main Body, and the Inner Lid.

- Rice or foreign matter adhering to the outside of the Inner Cooking Pan or the Heating Plate may lead to malfunction during cooking.
- Level the surface of rice.
- Make sure to insert the Inner Cooking Pan all the way into, and turn it left and right to align it properly with the Heating Plate.
- Be sure to attach the Inner Lid and Steam Vent Gasket securely.
- If the Outer Lid is not closed completely, the texture of the rice after cooking will be poor.

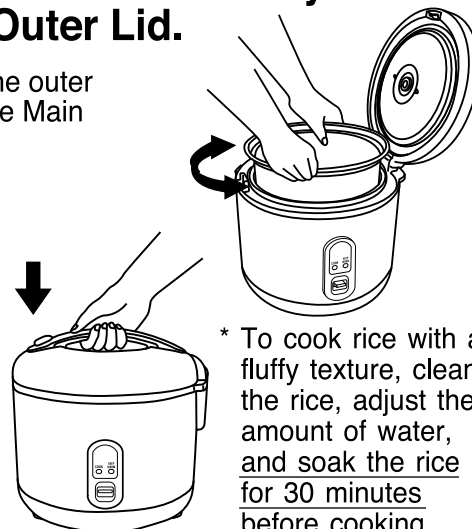

COOKING RICE (cont.)

5

Insert the plugs and start cooking.

- ① Insert the Appliance Plug into the Main Body securely.
- ② Insert the Power Plug into an electrical outlet.

When you push the Switch down, the KEEP WARM light turns off, the COOK light turns on, and the Rice Cooker switches to the Cooking mode.

- Do not cook rice other than white rice or mix anything else into the white rice that you are cooking.

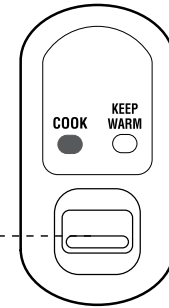
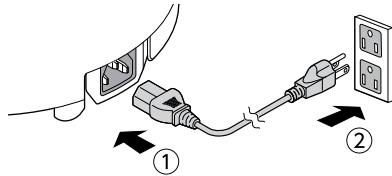

- If you are not cooking rice, do not insert the plug into the power supply. When the plug is inserted, the Rice Cooker turns on to the Keep Warm mode. The rice will expand if it is left to soak in water for a long period of time in the Keep Warm Mode, which will lead to the rice with a poor texture. Leaving the Rice Cooker in Keep Warm mode also wastes electricity.

- If the Switch springs up and the KEEP WARM light turns on automatically before the rice finishes cooking, do not forcefully push the Switch down. In this situation, promptly contact Zojirushi Customer Service.

Approximate Cooking Time (Indicated in minutes)

Amount of Rice Model No.	1 cup	2 cups	4 cups	5.5 cups	6 cups	8 cups	10 cups
NS-RPC10	12	16	21	24	—	—	—
NS-RPC18	—	15	19	—	23	27	30

- The approximate cooking time is for reference only. The actual time required to cook will vary depending on factors such as room or water temperature, voltage, and the amount of water.
- The above table is based on the testing conditions of 120 volts, a room temperature of 68°F (20°C), and a water temperature of 64.4°F (18°C).
- The above lengths of time are measured from the start of Cooking to the Keep Warm process.

6

Keep the Outer Lid closed.

- Do not open the Outer Lid until the cooking process is completed. For better results, after the Rice Cooker switches to “KEEP WARM”, it is recommended to keep the Outer Lid closed for about 15 minutes so that the rice can be steamed and softened by its own moisture. This is an important process to make fluffy, tasty rice.

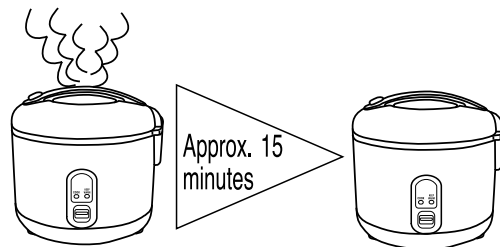

COOKING RICE (cont.)

7

Loosen the rice.

After the KEEP WARM light turns on and the rice is steamed, mix and loosen the rice as soon as possible.

- Be sure to completely remove any rice that has adhered to the edge of the Inner Cooking Pan.
- Note that the Outer Lid may close if the Main Body is moved with the Outer Lid open.
- If you do not mix and loosen the rice, it will not be soft and delicious.

* Depending on the cooking conditions, the bottom portion of the rice may become slightly browned, but this is normal.

* Depending on the heat convection while cooking, the surface of the finished rice may look uneven.

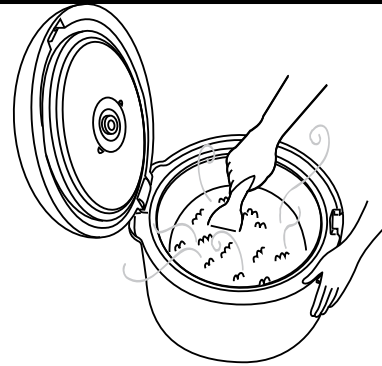

8

Discard the water in the Dew Collector.

- Leaving the collected water droplets as is will result in a bad odor. Discard the water droplets each time after you cook rice.

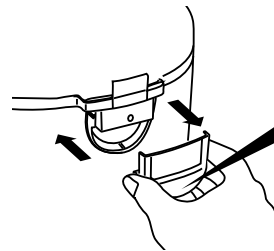

Press in both sides to remove the Dew Collector.

9

Keep the rice warm. (The optimal length of time is 8 hours or less.)

Level the surface of the rice before keeping it warm.

- Also keep warm the rice remaining in the Rice Cooker while you eat your meal.
- When keeping rice in the Inner Cooking Pan for later consumption, be sure to use the Keep Warm function.

To end Keep Warm mode, and when the Rice Cooker will not be used for some time:

Be sure to unplug the Power Plug from the electrical outlet.

- Always unplug the Power Plug by holding the Power Plug, not by pulling the Power Cord.
- Please do not handle the Power Plug or Appliance Plug while your hands are wet. (Doing so may cause short circuit or electric shock.)

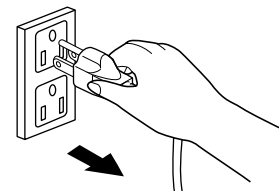

CLEANING AND MAINTENANCE

- Clean the Rice Cooker thoroughly after every use.

- Be sure to unplug the Power Cord and allow the Main Body and the Inner Cooking Pan to cool down.
- Do not use such items as thinner, abrasive cleaners, bleach, scrubbing brushes (nylon, metal, etc.), melamine sponges or sponges with a nylon surface. (Doing so may damage the surface, causing discoloration, scratches, degradation in quality, or corrosion.)
- Do not use a dishwasher or dish-dryer. Doing so may cause scratches, deformation or discoloration.
- After cleaning, be sure to reattach the Inner Lid, Dew Collector, and Spatula Holder correctly.

THE EXTERIOR

Open Button

If the Open Button becomes clogged with rice or other matter, remove with a bamboo stick.

- The Outer Lid may not open.

Air Vent

Clean using a vacuum cleaner (once a month).

Air Vent

Bottom view of the product

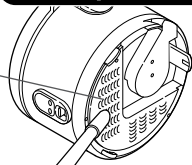

- Using the Rice Cooker with clogged Air Vent may cause the internal temperature to become abnormally high, resulting in breakdown.



Steam Vent

Wipe clean with a well-wrung soft cloth.

Control Panel

Wipe with a dry soft cloth.

Wipe with a dry soft cloth.

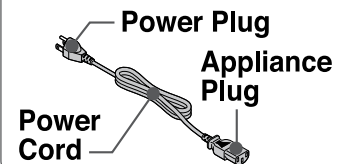

INNER COOKING PAN / SPATULA / MEASURING CUP / SPATULA HOLDER / INNER LID / DEW COLLECTOR

Wash using a neutral kitchen detergent and a soft sponge.

- Do not use polishing powder, metal or nylon scrubbing brushes.



THE INTERIOR

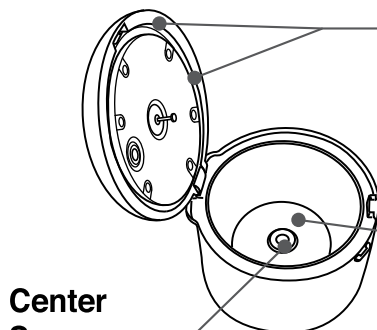

Outer Lid / Outer Lid Gasket

Hold the Outer Lid securely and wipe with a well-wrung soft cloth.

Remove any rice or residue on the inside of the Outer Lid.

- Do not use kitchen detergents.

Center Sensor

Wipe with a well-wrung soft cloth. If it becomes clogged with rice or other matter, remove with a bamboo stick.

Heating Plate

Wipe the surface with a well-wrung soft cloth.

If rice or other matter become stuck to the Heating Plate, lightly polish them off with a sand paper of about No. 320 after dipping in water.

If it becomes clogged with rice or other matter, remove with a bamboo stick.

TROUBLESHOOTING GUIDE

● Please check the following points before calling for service.

Problems		Cause (Points to check)
COOKING RICE	Rice cooks too hard or too soft:	<ul style="list-style-type: none"> ● Make sure the Inner Cooking Pan and the Inner Lid have not deformed. ● Rice may not have been cleaned sufficiently, allowing too much bran to be left on the rice grain. ● Did you loosen the rice after cooking was completed? → Loosen the rice immediately after cooking is completed. ● Is there moisture or foreign matter on the outer surface of the Inner Cooking Pan, the inside of the Main Body, the Inner Lid, the Center Sensor, or the Heating Plate? → Wipe them off. ● Did you cook the rice immediately after cleaning it?
	Rice is scorched:	<ul style="list-style-type: none"> ● Foreign matter such as rice may be stuck to the outside of the Inner Cooking Pan, the inside of the Main Body, on the Center Sensor or the Heating Plate. ● Rice may not have been cleaned sufficiently, allowing too much bran to be left on the rice grain. ● Make sure the Inner Cooking Pan has not deformed.
	The surface of the cooked rice is uneven:	<ul style="list-style-type: none"> ● Depending on the heat convection while cooking, the surface of the cooked rice may look uneven. ● Make sure the Inner Cooking Pan and the Inner Lid have not deformed.
	Boils over while cooking:	<ul style="list-style-type: none"> ● Did you use the wrong amount of water? ● Rice may not have been cleaned sufficiently, allowing too much bran to be left on the rice grain. ● Make sure the Inner Cooking Pan and the Inner Lid have not deformed. ● Did you use the provided Inner Cooking Pan? ● Is the Inner Lid attached correctly? ● Is there any foreign matter on the edge of the Inner Lid or Inner Cooking Pan? ● Did you cook rice other than white rice or mix something else into the white rice that you were cooking?
	Unable to start cooking:	<ul style="list-style-type: none"> ● Did you plug the Power Plug into the electrical outlet? ● Is the Appliance Plug disconnected from the Plug Receptacle? ● Did you press the Switch? ● Did you press the Switch immediately after cooking completed?
	Steam comes out from the gap between the Outer Lid and the Main Body:	<ul style="list-style-type: none"> ● Please check that the Inner Lid and Inner Cooking Pan have not been dropped or deformed and that the Outer Lid Gasket is not torn. ● Has the Outer Lid Gasket become soiled? → Clean the Outer Lid Gasket.
COOKING RICE / KEEP WARM	A noise is heard during Cooking / Keep Warm:	<ul style="list-style-type: none"> ● There is a spark-like noise when there is water left on the outside of the Inner Cooking Pan. → Always take precautions to wipe the outer surface of the Inner Cooking Pan and the inside of the Main Body clean, especially of moisture and foreign matters, before placing the Inner Cooking Pan into the Main Body.

TROUBLESHOOTING GUIDE (cont.)

Problems		Cause (Points to check)
KEEP WARM	During Keep Warm, rice has an odor, or rice becomes watery:	<ul style="list-style-type: none"> ● Was the Keep Warm mode used for more than 8 hours? ● Was the rice kept warm with the spatula left in the Inner Cooking Pan? ● Was cold rice reheated? ● Did you loosen the rice after cooking was completed? → Loosen the rice immediately after cooking is completed. ● Rice may not have been cleaned sufficiently, allowing too much bran to be left on the rice grain. ● The Keep Warm mode may not have been used for keeping rice warm. ● Did you clean the Rice Cooker thoroughly after every use? ● Is the Inner Lid attached correctly? ● Did you close the Outer Lid completely? ● Is there any foreign matter on the edge of the Inner Lid or Inner Cooking Pan? ● Did you unplug the Power Plug during Keep Warm mode?
	During Keep Warm, rice becomes yellow or dry:	<ul style="list-style-type: none"> ● Are you keeping warm a small amount of rice in the Inner Cooking Pan? ● Was the Keep Warm mode used for more than 8 hours? ● The type of rice and water used may make the rice appear yellow.

SPECIFICATIONS

Model No.	NS-RPC10	NS-RPC18
Cooking Capacity	0.18–1.0 L (1–Approx. 5.5 cups)	0.36–1.8 L (2–10 cups)
Rating (AC 120 V / 60 Hz)	485 W	650 W
Average Power Consumption during Keep Warm	27 W	35 W
Rice Cooking System	Direct Heating	
External Dimensions (Approx. inches)	10- ¹ / ₄ (W)×10- ¹ / ₄ (D)×10- ¹ / ₄ (H)	11- ¹ / ₄ (W)×11- ³ / ₈ (D)×11- ³ / ₄ (H)
Weight	Approx. 6.5 lbs.	Approx. 8.3 lbs.
Cord length	Approx. 1.1 m (Approx. 3.7 ft.)	
Accessories	Measuring Cup, Spatula Holder, Spatula	

Zojirushi Customer Service

1-800-733-6270

www.zojirushi.com