

CRE, CRIE, CRNE, SPKE, CRKE, MTRE

North America

Grundfos E-pumps with MLE frequency-controlled, asynchronous motors

Installation and operating instructions



CRE, CRIE, CRNE, SPKE, CRKE, MTRE

English (US)

Installation and operating instructions 4

Français (CA)

Notice d'installation et de fonctionnement 37

Español (MX)

Instrucciones de instalación y operación 71

Appendix A **105**

Original installation and operating instructions

Table of contents

1. Limited warranty	4
2. General information	5
2.1 Hazard statements	5
2.2 Notes	5
3. Product introduction	5
3.1 Pumps without factory-fitted sensor	5
3.2 Pumps with pressure sensor	5
3.3 Settings	5
3.4 Identification	6
4. Installing the product	6
4.1 Mechanical installation	6
4.2 Outdoor installation	6
4.3 Electrical connection	6
4.4 Three-phase pumps, 20-30 hp	7
4.5 E-pump electrical connections	9
4.6 Bus connection cable	11
4.7 Modes	11
5. Control functions	12
5.1 Displays in general	12
5.2 Menu OPERATION	12
5.3 Menu STATUS	14
5.4 Menu INSTALLATION	15
5.5 Typical display settings for constant-pressure E-pumps	22
5.6 Typical display settings for analog-input E-pumps	23
5.7 Digital input	24
5.8 External setpoint signal	24
5.9 Bus signal	25
5.10 Other bus standards	25
5.11 Indicator lights and signal relay	26
6. Setting the product	28
6.1 Factory settings	28
6.2 Setting by means of control panel	28
6.3 Setting of operating mode	28
6.4 Setpoint setting	28
6.5 Setting by means of R100	29
6.6 Grundfos GO	31
6.7 Setting by means of PC Tool E-products	32
6.8 Priority of settings	32
6.9 External forced-control signals	32
7. Taking the product out of operation	33
7.1 Emergency operation (only 20-30 hp)	33
7.2 Insulation resistance	34
8. Servicing the product	34
8.1 Cleaning of the motor	34
8.2 Relubrication of motor bearings	34
8.3 Replacement of motor bearings	34
8.4 Replacement of varistor (only 20-30 hp)	34
8.5 Service parts and service kits	34
9. Technical data	35
9.1 Three-phase pumps, 20-30 hp	35
9.2 Other technical data	36
10. Disposing of the product	36
11. Document quality feedback	36

1. Limited warranty

Products manufactured by Grundfos Pumps Corporation (Grundfos) are warranted to the original user only to be free of defects in material and workmanship for a period of 24 months from date of installation, but not more than 30 months from date of manufacture. Grundfos' liability under this warranty shall be limited to repairing or replacing at Grundfos' option, without charge, F.O.B. Grundfos' factory or authorized service station, any product of Grundfos manufacture. Grundfos will not be liable for any costs of removal, installation, transportation, or any other charges that may arise in connection with a warranty claim.

Products which are sold, but not manufactured by Grundfos, are subject to the warranty provided by the manufacturer of said products and not by Grundfos' warranty.

Grundfos will not be liable for damage or wear to products caused by abnormal operating conditions, accident, abuse, misuse, unauthorized alteration or repair, or if the product was not installed in accordance with Grundfos' printed installation and operating instructions and accepted codes of good practice. The warranty does not cover normal wear and tear.

To obtain service under this warranty, the defective product must be returned to the distributor or dealer of Grundfos' products from which it was purchased together with proof of purchase and installation date, failure date and supporting installation data. Unless otherwise provided, the distributor or dealer will contact Grundfos or an authorized service station for instructions. Any defective product to be returned to Grundfos or a service station must be sent freight prepaid; documentation supporting the warranty claim and/or a Return Material Authorization must be included if so instructed.

Grundfos will not be liable for any incidental or consequential damages, losses, or expenses arising from installation, use, or any other causes. There are no express or implied warranties, including merchantability or fitness for a particular purpose, which extend beyond those warranties described or referred to above. Some jurisdictions do not allow the exclusion or limitation of incidental or consequential damages and some jurisdictions do not allow limitations on how long implied warranties may last. Therefore, the above limitations or exclusions may not apply to you. This warranty gives you specific legal rights and you may also have other rights which vary from jurisdiction to jurisdiction.

Products which are repaired or replaced by Grundfos or authorized service center under the provisions of these limited warranty terms will continue to be covered by Grundfos warranty only through the remainder of the original warranty period set forth by the original purchase date.

2. General information



Read this document before you install the product. Installation and operation must comply with local regulations and accepted codes of good practice.

These installation and operating instructions are a supplement to installation and operating instructions for the corresponding standard pumps CR, CRI, CRN, CRK, SPK, MTR. For instructions not mentioned specifically here, please see installation and operating instructions for the standard pump.

2.1 Hazard statements

The symbols and hazard statements below may appear in Grundfos installation and operating instructions, safety instructions and service instructions.



DANGER

Indicates a hazardous situation which, if not avoided, will result in death or serious personal injury.



WARNING

Indicates a hazardous situation which, if not avoided, could result in death or serious personal injury.



CAUTION

Indicates a hazardous situation which, if not avoided, could result in minor or moderate personal injury.

The hazard statements are structured in the following way:



SIGNAL WORD

Description of the hazard

Consequence of ignoring the warning

- Action to avoid the hazard.

2.2 Notes

The symbols and notes below may appear in Grundfos installation and operating instructions, safety instructions and service instructions.



Observe these instructions for explosion-proof products.



A blue or grey circle with a white graphical symbol indicates that an action must be taken.



A red or grey circle with a diagonal bar, possibly with a black graphical symbol, indicates that an action must not be taken or must be stopped.



If these instructions are not observed, it may result in malfunction or damage to the equipment.



Tips and advice that make the work easier.

3. Product introduction

Grundfos E-pumps have standard motors with integrated frequency converter. The pumps are for three-phase power supply connection.

3.1 Pumps without factory-fitted sensor

The pumps have a built-in PI controller and can be set up for an external sensor enabling control of the following parameters:

- pressure
- differential pressure
- temperature
- differential temperature
- flow rate
- liquid level in a tank.

From factory, the pumps have been set to control mode uncontrolled. The PI controller can be activated by means of R100.

3.2 Pumps with pressure sensor

The pumps have a built-in PI controller and are set up with a pressure sensor enabling control of the pump discharge pressure.

The pumps are set to control mode controlled. The pumps are typically used to hold a constant pressure in variable-demand systems.

3.3 Settings

The description of settings apply both to pumps without factory-fitted sensor and to pumps with a factory-fitted pressure sensor.

Setpoint

The desired setpoint can be set in three different ways:

- directly on the pump control panel
- via an input for external setpoint signal
- by means of Grundfos wireless remote control R100.

Other settings

All other settings can only be made by means of the R100.

Important parameters such as actual value of control parameter, power consumption, etc. can be read via the R100.

If special or customized settings are required, use Grundfos PC Tool E-products. Contact your local Grundfos company for more information.

3.4 Identification

3.4.1 Nameplate

The information on the pump nameplate is described below.

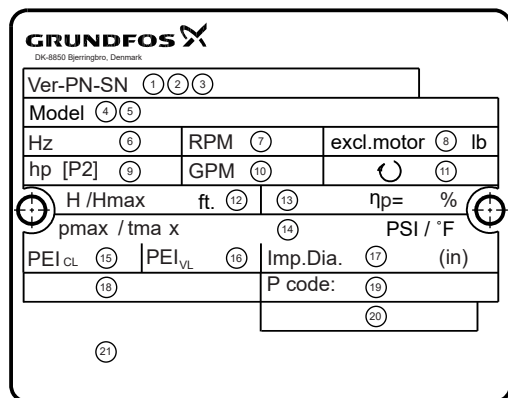

TM075722

Example of a nameplate

Pos.	Description
1	Version
2	Product number
3	Serial number
4	Model
5	Type designation
6	Frequency
7	Rated speed
8	Weight excluding motor
9	Motor-rated power output
10	Rated flow rate
11	Direction of rotation CCW: Counterclockwise CW: Clockwise
12	Head at rated flow rate / Maximum head
13	Hydraulic efficiency at rated flow rate
14	Maximum system pressure / Maximum liquid temperature. Note that this field may have two sets of data.
15	Pump Energy Index, constant load
16	Pump Energy Index, variable load
17	Impeller diameter
18	External reference (Other Equipment Manufacturer number)
19	Production code
20	Country of origin
21	Approval marks

4. Installing the product

4.1 Mechanical installation

The pump must be secured to a solid foundation by means of bolts through the holes in the flange or baseplate.



In order to retain the UL/cUL approval, follow the additional installation procedures found in the Appendix.

4.1.1 Motor cooling

To ensure sufficient cooling of motor and electronics, observe the following requirements:

- Make sure that sufficient cooling air is available.
- Keep the temperature of the cooling air below 104 °F (40 °C).
- Keep cooling fins and fan blades clean.

4.2 Outdoor installation

When installed outdoors, the pump must be provided with a suitable cover to avoid condensation on the electronic components. See the figures below.

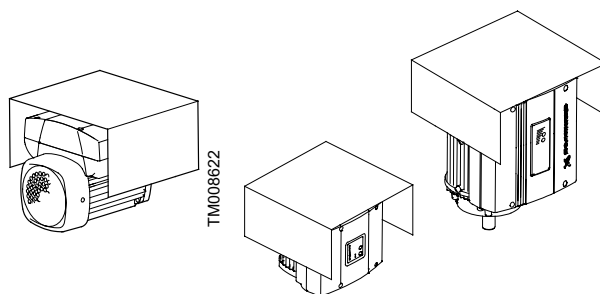

Examples of covers

Remove the drain plug pointing downwards in order to avoid moisture and water build-up inside the motor.

Vertically mounted pumps are IP55 after removal of the drain plug. Horizontally mounted pumps change enclosure class to IP54.



In order to retain the UL mark, additional requirements apply to the equipment. See the Appendix.

4.3 Electrical connection

For description of how to connect E-pumps electrically, see the section on three-phase pumps, 20-30 hp.

Related information

[4.4 Three-phase pumps, 20-30 hp](#)

4.4 Three-phase pumps, 20-30 hp

DANGER

Electric shock

Death or serious personal injury



- The user or the installer is responsible for the installation of correct grounding and protection according to current national and local standards. All operations must be carried out by qualified personnel.

DANGER

Electric shock

Death or serious personal injury



- Never make any connections in the pump terminal box unless all electric supply circuits have been switched off for at least 5 minutes.
- Note for instance that the signal relay may be connected to an external supply which is still connected when the power supply is disconnected.

WARNING

Hot surface

Death or serious personal injury



- The surface of the terminal box may be above 158 °F (70 °C) when the pump is operating.

4.4.1 Preparation

Before connecting the E-pump to the power supply, take the issues illustrated in the figure below into consideration.

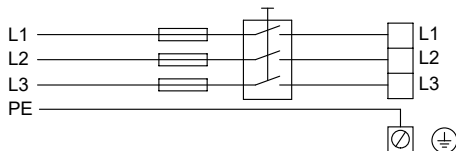

TM083398

Power supply-connected pump with power switch, backup fuses and protective grounding

4.4.2 Protection against electric shock - indirect contact

DANGER

Electric Shock

Death or serious personal injury



- The pump must be grounded in accordance with national regulations.
- As the leakage current of 20-30 hp motors is > 10 mA, take extra precautions when grounding these motors.

EN 61800-5-1 specifies that the pump must be stationary and installed permanently when the leakage current is > 10 mA.

One of the following requirements must be fulfilled:

- A single protective ground lead (7 AWG minimum copper)

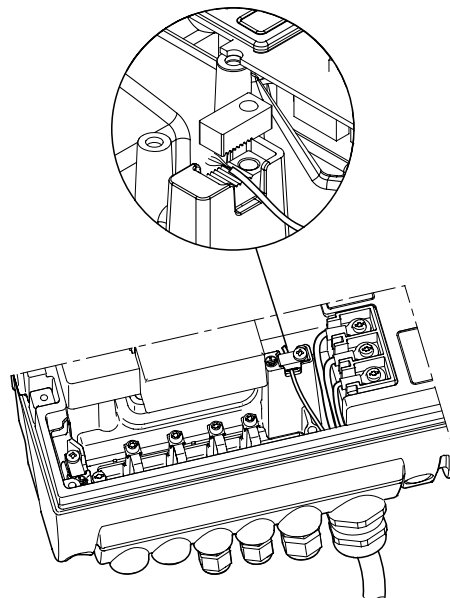

TM043021

Connection of a single protective ground lead using one of the leads of a 4-core power cable (7 AWG minimum)

- Two protective ground leads of the same cross-sectional area as the power supply leads, with one lead connected to an additional ground terminal in the terminal box.

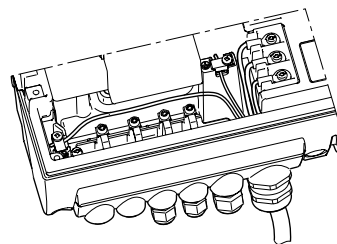

TM038606

Connection of two protective ground leads using two of the leads of a 5-core power supply cable

Protective ground leads must always have a yellow/green (PE) or yellow/green/blue (PEN) color marking.

4.4.3 Backup fuses

For recommended fuse sizes, see the section on supply voltage.

Related information

[9.1.1 Supply voltage](#)

[9.1.1 Tension d'alimentation](#)

[9.1.1 Tensión de alimentación](#)

4.4.4 Additional protection

The total leakage current of all the electrical equipment in the installation must be taken into account.

For leakage current of the motor in normal operation, see the section on leakage current.

During start and at asymmetrical supply systems, the leakage current can be higher than normal.

Related information

[9.1.3 Leakage current](#)

4.4.5 Motor protection

The pump requires no external motor protection. The motor incorporates thermal protection against slow overloading and blocking (IEC 34-11, TP 211).

4.4.6 Protection against voltage transients

The pump is protected against voltage transients in accordance with EN 61800-3 and is capable of withstanding a VDE 0160 pulse. The pump has a replaceable varistor which is part of the transient protection.

Over time this varistor will be worn and need to be replaced. When the time for replacement has come, R100 and PC Tool E-products will indicate this as a warning. See the section on servicing the product.

Related information

8.1 Cleaning of the motor

4.4.7 Supply voltage

3 x 460-480 V - 10 %/+ 10 %, 50/60 Hz, PE.

The supply voltage and frequency are marked on the pump nameplate. Make sure that the motor is suitable for the power supply of the installation site.

The wires in the terminal box must be as short as possible. Excepted from this is the protective ground lead which must be so long that it is the last one to be disconnected in case the cable is inadvertently pulled out of the cable entry.

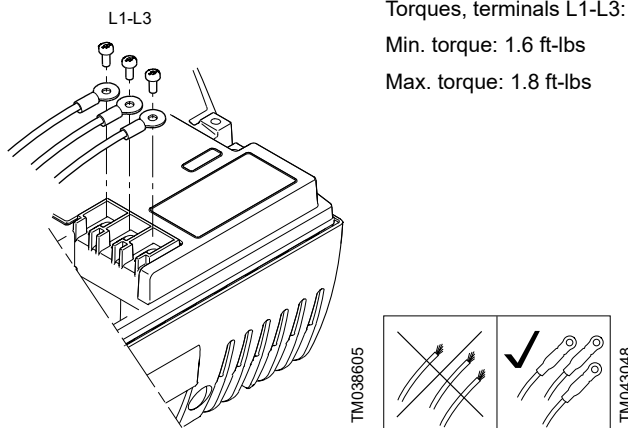

Power connection

Cable glands

Cable glands comply with EN 50626.

- 1 x M40 cable gland
- 1 x M20 cable gland
- 2 x M16 cable gland
- 2 x M16 knock-out cable entries.



If the supply cable is damaged, it must be replaced by qualified personnel.

Grid types

Three-phase E-pumps can be connected to all grid types.



Could result in personal injury

- Do not connect three-phase E-pumps to a power supply with a voltage between phase and ground of more than 440 V.

4.4.8 Start/stop of pump



The number of starts and stops via the power supply must not exceed 4 times per hour.

When the pump is switched on via the power supply, it will start after approx. 5 seconds.

If a higher number of starts and stops is desired, use the input for external start/stop when starting/stopping the pump.

When the pump is switched on via an external On/Off switch, it will start immediately.

4.4.9 Connections



If no external on-off switch is connected, connect terminals 2 and 3 using a short wire.

As a precaution, the wires to be connected to the following connection groups must be separated from each other by reinforced insulation in their entire lengths:

Group 1: Inputs

- start/stop terminals 2 and 3
- digital input terminals 1 and 9
- setpoint input terminals 4, 5 and 6
- sensor input terminals 7 and 8
- GENibus terminals B, Y and A

All inputs (group 1) are internally separated from the power-conducting parts by reinforced insulation and galvanically separated from other circuits.

All control terminals are supplied with protective extra-low voltage (PELV), thus ensuring protection against electric shock.

Group 2: Output (relay signal, terminals NC, C, NO)

The output (group 2) is galvanically separated from other circuits. Therefore, the supply voltage or protective extra-low voltage can be connected to the output as desired.

Group 3: Power supply (terminals L1, L2, L3)

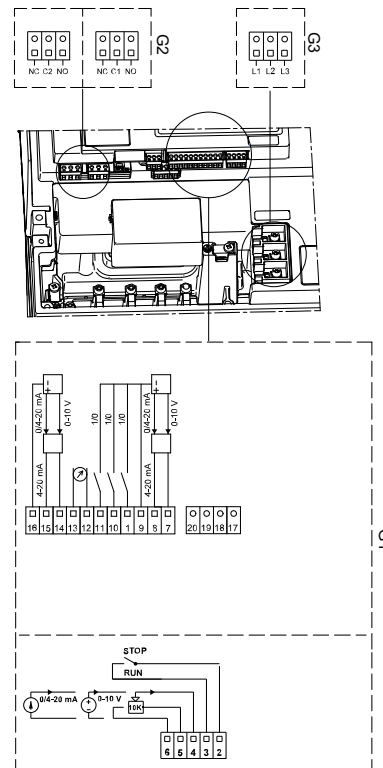

Connection terminals

Pos.	Description
1	Digital input 2
2	Start/stop
3	GND (frame)
4	Setpoint input
5	+10 V
6	GND (frame)
7	Sensor input
8	+24 V
9	GND (frame)
10	Digital input 3
11	Digital input 4
12	Analog output
13	GND
14	Sensor input 2
15	+24 V
16	GND (frame)
17	PT 100 A
18	PT 100 A
19	PT 100 B
20	PT 100 B
G1	Group 1
G2	Group 2
G3	Group 3
A	RS-485A
B	RS-485B
Y	Screen

A galvanic separation must fulfill the requirements for reinforced insulation including creepage distances and clearances specified in EN 61800-5-1.

4.4.10 Signal cables

- Use screened cables with a conductor cross-section of min. 28 AWG and max. 16 AWG for external on/off switch, digital input and setpoint signals.
- Connect the screens of the cables to frame at both ends with good frame connection. The screens must be as close as possible to the terminals. See the figure below.

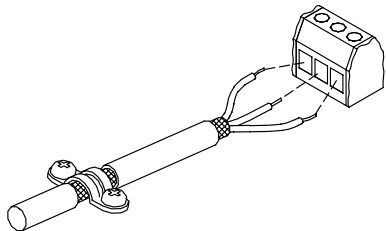

TM021325

Stripped cable with screen and wire connection

- Always tighten screws for frame connections whether a cable is fitted or not.
- Make the wires in the pump terminal box as short as possible.

4.5 E-pump electrical connections

4.5.1 Connection of Danfoss pressure sensor MBS3000 to E-pump



TM051533

Danfoss pressure sensor

Use screened cables with a cross-sectional area of minimum 28 AWG and maximum 16 AWG.

The blue wire of the pressure sensor is connected to the #7 terminal of the E-pump. The brown wire of the pressure sensor is connected to the #8 terminal of the E-pump.

Related information

[4.4.10 Signal cables](#)

4.5.2 Connection of Grundfos pressure sensor ISP44 to E-pump



TM083396

ISP44 pressure sensor

Use unshielded cables with a cross-sectional area of minimum 28 AWG and maximum 16 AWG.

The blue wire of the pressure sensor is connected to the #7 terminal of the E-pump. The brown wire of the pressure sensor is connected to the #8 terminal of the E-pump.

4.5.3 Connection of E-pump to LiqTec®

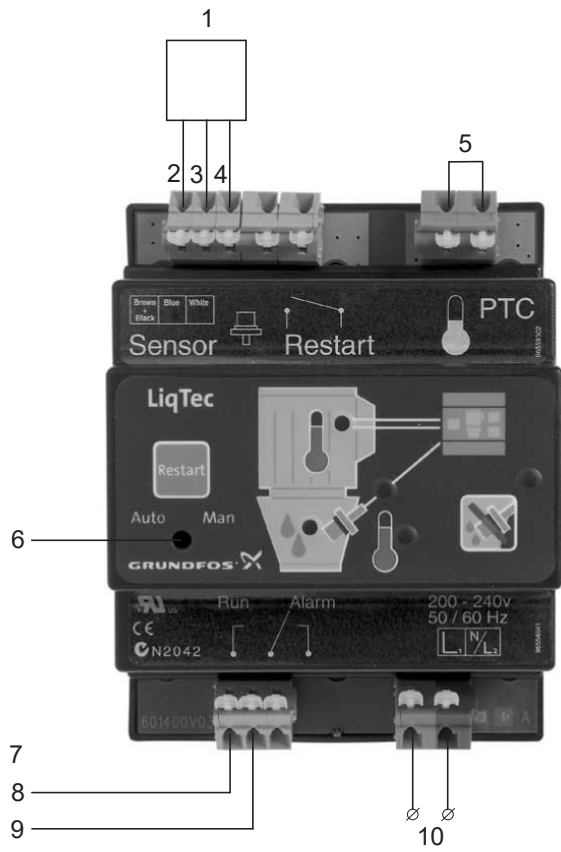

TM030437

Connection of E-pump to LiqTec

Pos.	Description
1	Dry-running sensor
4	Brown
5	Black
6	Blue
7	White
8	Jumper cable
9	Set to automatic resetting
10	Connection terminals on E-pump: 2 (Start/Stop) and 3 (GND)
11	1 x 200-240 VAC or 1 X 80-130 VAC

4.6 Bus connection cable

4.6.1 New installations

For the bus connection, use a screened 3-core cable with a conductor cross-section of 28-16 AWG.

- If the pump is connected to a unit with a cable clamp which is identical to the one on the pump, connect the screen to this cable clamp.
- If the unit has no cable clamp as shown in the figure below, leave the screen unconnected at this end.

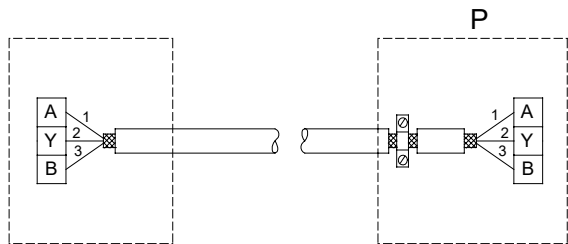

TM028841

Connection with screened 3-core cable

Pos.	Description
P	Pump

4.6.2 Replacing an existing pump

- If a screened 2-core cable is used in the existing installation, connect it as shown in figure below.

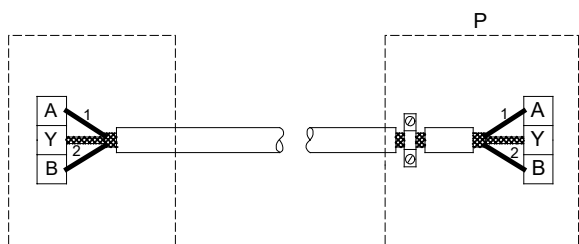

TM028842

Connection with screened 2-core cable

Pos.	Description
P	Pump

- If a screened 3-core cable is used in the existing installation, follow the instructions in the section on new installations.

Related information

- [4.6.1 New installations](#)
- [4.6.1 Nouvelles installations](#)
- [4.6.1 Instalaciones nuevas](#)

4.7 Modes

Grundfos E-pumps are set and controlled according to operating and control modes.

4.7.1 Overview of modes

Operating modes	Normal	—	Stop	—	Min	—	Max
Control modes	Uncontrolled	—	Controlled				
	Constant curve		Constant pressure ¹⁾				

¹⁾ For this control mode the pump is equipped with a pressure sensor. The pump may also be equipped with a temperature sensor in which case the description would be constant temperature in control mode controlled.

4.7.2 Operating mode

When the operating mode is set to Normal, the control mode can be set to controlled or uncontrolled. See the section on control mode.

The other operating modes that can be selected are Stop, Min. or Max.

- Stop: the pump has been stopped
- Min: the pump is operating at its minimum speed
- Max: the pump is operating at its maximum speed.

The figure below is a schematic illustration of min. and max. curves.

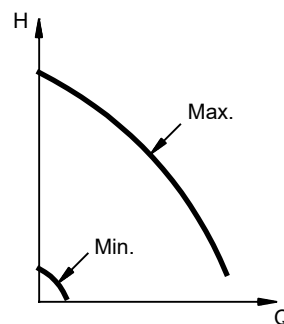

TM005547

Min. and max. curves

The max. curve can for instance be used in connection with the venting procedure during installation.

The min. curve can be used in periods in which a minimum flow is required.

If the power supply to the pump is disconnected, the mode setting will be stored.

The remote control R100 offers additional possibilities of setting and status displays. See the section on setting by means of R100.

Related information

- [4.7.3 Control mode](#)
- [6.5 Setting by means of R100](#)

4.7.3 Control mode

Pumps without factory-fitted sensor

The pumps are factory-set to control mode **uncontrolled**.

In control mode uncontrolled, the pump will operate according to the constant curve set, see the figure below.

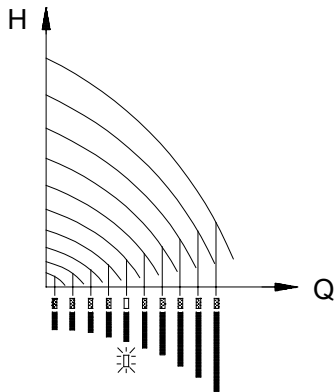

Pump in control mode **uncontrolled** (constant curve)

4.7.4 Pumps with pressure sensor

The pump can be set to one of two control modes, i.e. controlled and uncontrolled, see the figure below.

In control mode controlled, the pump will adjust its performance, i.e. pump discharge pressure, to the desired setpoint for the control parameter.

In control mode uncontrolled, the pump will operate according to the constant curve set.

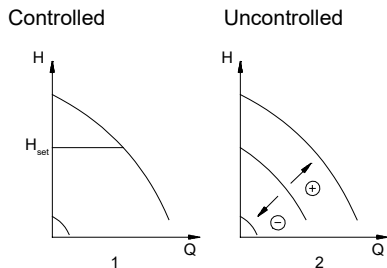

Pump in control mode controlled (constant pressure) or uncontrolled (constant curve)

5. Control functions

5.1 Displays in general

In the following explanation of the functions, one or two displays are shown.

One display

Pumps without or with factory-fitted sensor have the same function.

Two displays

Pumps without or with factory-fitted pressure sensor have different functions and factory settings.

5.2 Menu OPERATION

The first display in this menu is this:

5.2.1 Setpoint

Without sensor (uncontrolled)

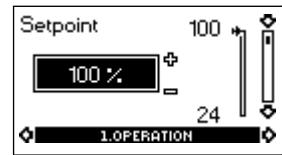

- ▶ Setpoint set
 - ▬ Actual setpoint
 - Actual value
- Set the setpoint in %.

With pressure sensor (controlled)

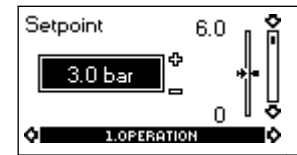

- ▶ Setpoint set
 - ▬ Actual setpoint
 - Actual value
- Set the desired pressure in bar.

In control mode **uncontrolled**, the setpoint is set in % of the maximum performance. The setting range will lie between the min. and max. curves.

In control mode **controlled**, the setting range is equal to the sensor measuring range.

If the pump is connected to an external setpoint signal, the value in this display will be the maximum value of the external setpoint signal. See the section on external setpoint signal.

Setpoint and external signal

The setpoint cannot be set if the pump is controlled via external signals (Stop, Min. curve or Max. curve). R100 will give this warning: External control!

Check if the pump is stopped via terminals 2-3 (open circuit) or set to min. or max. via terminals 1-3 (closed circuit).

See fig. 'Menu overview'.

Setpoint and bus communication

The setpoint cannot be set either if the pump is controlled from an external control system via bus communication. R100 will give this warning: Bus control!

To override bus communication, disconnect the bus connection. See fig. 'Menu overview'.

Related information

[5.6 Typical display settings for analog-input E-pumps](#)

[5.8 External setpoint signal](#)

TM007746

TM007668

5.2.2 Operating mode

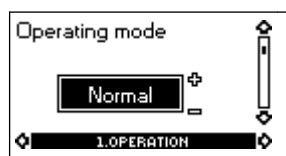

Set one of the following operating modes:

- Normal (duty)
- Stop
- Min.
- Max.

The operating modes can be set without changing the setpoint setting.

5.2.3 Fault indications

In E-pumps, faults may result in two types of indication: alarm or warning.

An "alarm" fault will activate an alarm indication in R100 and cause the pump to change operating mode, typically to stop. However, for some faults resulting in alarm, the pump is set to continue operating even if there is an alarm.

A "warning" fault will activate a warning indication in R100, but the pump will not change operating or control mode.



The indication, Warning, only applies to three-phase pumps.

Alarm

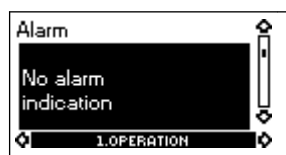

In case of alarm, the cause will appear in this display.

Possible causes:

- No alarm indication
- Too high motor temperature
- Undervoltage
- Mains voltage asymmetry (20-30 hp)
- Overvoltage
- Too many restarts (after faults)
- Overload
- Underload
- Sensor signal outside signal range
- Setpoint signal outside signal range
- External fault
- Duty/standby, Communication fault
- Dry running
- Other fault.

If the pump has been set up to manual restart, an alarm indication can be reset in this display if the cause of the fault has disappeared.

Warning (only three-phase pumps)

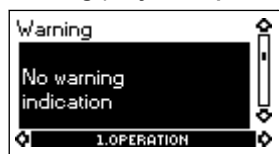

In case of warning, the cause will appear in this display.

Possible causes:

- No warning indication.
- Sensor signal outside signal range.
- Relubricate motor bearings, see the section on the relubrication of motor bearings.
- Replace motor bearings, see the section on the replacement of motor bearings.
- Replace varistor, see the section on the replacement of varistor (only 20-30 hp).

A warning indication will disappear automatically once the fault has been remedied.

Related information

[8.2 Relubrication of motor bearings](#)

[8.3 Replacement of motor bearings](#)

[8.4 Replacement of varistor \(only 20-30 hp\)](#)

5.2.4 Fault log

For both fault types, alarm and warning, the R100 has a log function.

Alarm log

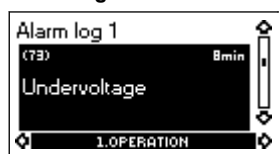

In case of "alarm" faults, the last five alarm indications will appear in the alarm log. "Alarm log 1" shows the latest fault, "Alarm log 2" shows the latest fault but one, etc.

The example above gives this information:

- the alarm indication Undervoltage
- the fault code (73)
- the number of minutes the pump has been connected to the power supply after the fault occurred, 8 min.

Warning log

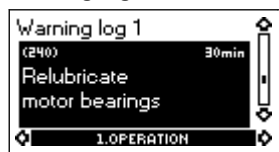

In case of "warning" faults, the last five warning indications will appear in the warning log. "Warning log 1" shows the latest fault, "Warning log 2" shows the latest fault but one, etc.

The example above gives this information:

- the warning indication Relubricate motor bearings
- the fault code (240)
- the number of minutes the pump has been connected to the power supply since the fault occurred, 30 min.

5.3 Menu STATUS

The displays appearing in this menu are status displays only. It is not possible to change or set values.

The displayed values are the values that applied when the last communication between the pump and the R100 took place. If a status value is to be updated, point the R100 at the control panel and press "OK". If a parameter, e.g. speed, should be called up continuously, press "OK" constantly during the period in which the parameter in question should be monitored.

The tolerance of the displayed value is stated under each display. The tolerances are stated as a guide in % of the maximum values of the parameters.

5.3.1 Actual setpoint

Without sensor (uncontrolled)

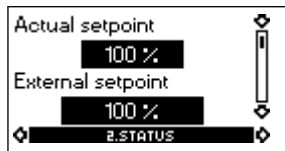

Tolerance: $\pm 2\%$.

With pressure sensor (controlled)



Tolerance: $\pm 2\%$.

This display shows the actual setpoint and the external setpoint in % of the range from minimum value to the setpoint set. See the section on external setpoint signal.

Related information

[5.8 External setpoint signal](#)

[5.8 Signal externe du point de consigne](#)

[5.8 Señal de punto de ajuste externo](#)

5.3.2 Operating mode

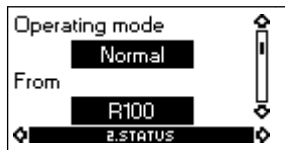

This display shows the actual operating mode (Normal (duty), Stop, Min., or Max.). Furthermore, it shows where this operating mode was selected (R100, Pump, Bus, External or Stop func.). For further details about the stop function (Stop func.), see the section on stop function.

Related information

[5.4.8 Stop function](#)

5.3.3 Actual value

Without sensor (uncontrolled)

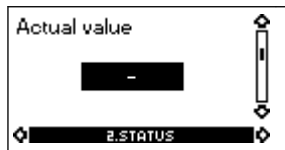

With pressure sensor (controlled)



This display shows the value actually measured by a connected sensor.

If no sensor is connected to the pump, "-" will appear in the display.

5.3.4 Speed



Tolerance: $\pm 5\%$

The actual pump speed will appear in this display.

5.3.5 Power input and power consumption

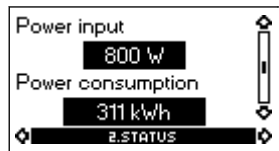

Tolerance: $\pm 10\%$

This display shows the actual pump input power from the power supply. The power is displayed in W or kW.

The pump power consumption can also be read from this display. The value of power consumption is an accumulated value calculated from the pump's birth and it cannot be reset.

5.3.6 Operating hours



Tolerance: $\pm 2\%$

The value of operating hours is an accumulated value and cannot be reset.

5.3.7 Lubrication status of motor bearings (only 20-30 hp)



This display shows how many times the motor bearings have been relubricated and when to replace the motor bearings.

When the motor bearings have been relubricated, confirm this action in the INSTALLATION menu. See the section on confirming relubrication/replacement of motor bearings (only three-phase pumps). When relubrication is confirmed, the figure in the above display will be increased by one.

Related information

[5.4.14 Confirming relubrication/replacement of motor bearings \(only three-phase pumps\)](#)

5.3.8 Time till relubrication of motor bearings



This display shows when to relubricate the motor bearings. The controller monitors the operating pattern of the pump and calculates the period between bearing relubrications. If the operating pattern changes, the calculated time till relubrication may change as well.

The displayable values are these:

- in 2 years
- in 1 year
- in 6 months
- in 3 months
- in 1 month
- in 1 week
- Now!

5.3.9 Time till replacement of motor bearings

When the motor bearings have been relubricated a prescribed number of times stored in the controller, the display in the section on time till relubrication of motor bearings will be replaced by the display below.



This display shows when to replace the motor bearings. The controller monitors the operating pattern of the pump and calculates the period between bearing replacements.

The displayable values are these:

- in 2 years
- in 1 year
- in 6 months
- in 3 months
- in 1 month
- in 1 week
- Now!

Related information

[5.3.8 Time till relubrication of motor bearings](#)

5.4 Menu INSTALLATION

5.4.1 Control mode

Without sensor (uncontrolled)



Select one of the following control modes. See fig. 'Pump in control mode controlled (constant pressure) or uncontrolled (constant curve)':

- Controlled
- Uncontrolled.

With pressure sensor (controlled)



Select one of the following control modes. See fig. 'Pump in control mode controlled (constant pressure) or uncontrolled (constant curve)':

- Controlled
- Uncontrolled.



If the pump is connected to a bus, the control mode cannot be selected via the R100. See the section on bus signal.

Related information

[4.7.4 Pumps with pressure sensor](#)

[5.9 Bus signal](#)

5.4.2 Controller

E-pumps have a factory default setting of gain (K_p) and integral time (T_i). However, if the factory setting is not the optimum setting, the gain and the integral time can be changed in the display below.

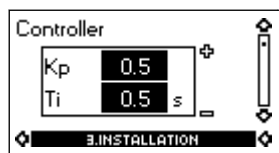

- The gain (K_p) can be set within the range from 0.1 to 20.
- The integral time (T_i) can be set within the range from 0.1 to 3600 s. If 3600 s is selected, the controller will function as a P controller.
- Furthermore, it is possible to set the controller to inverse control, meaning that if the setpoint is increased, the speed will be reduced. In the case of inverse control, the gain (K_p) must be set within the range from -0.1 to -20.

Guidelines for setting of PI controller

The tables below show the recommended controller settings:

Constant differential pressure	K_p	T_i
	0.5	0.5
	0.5	$L1 < 5 \text{ m}: 0.5$ $L1 > 5 \text{ m}: 3$ $L1 > 10 \text{ m}: 5$

L1: distance in meters between pump and sensor.

Constant temperature	K_p		T_i
	Heating system	Cooling system	
	0.5	-0.5	$10 + 5L2$
	0.5	-0.5	$30 + 5L2$

- In heating systems, an increase in pump performance results in a rise in temperature at the sensor.
- In cooling systems, an increase in pump performance results in a drop in temperature at the sensor.

L2: distance in meters between heat exchanger and sensor.

Constant differential temperature	K_p	T_i
	-0.5	$10 + 5L2$

L2: Distance [m] between heat exchanger and sensor.

Constant flow rate	K_p	T_i
	0.5	0.5
Constant pressure	K_p	T_i
	0.5	0.5
	0.5	0.5
Constant level	K_p	T_i
	-20	0
	20	0

General rules of thumb

If the controller is too slow-reacting, increase the gain.
 If the controller is hunting or unstable, dampen the system by reducing the gain or increasing the integral time.

How to set the PI controller

For most applications, the factory setting of the controller constants K_p and T_i will ensure optimum pump operation. However, in some applications an adjustment of the controller may be needed.

Proceed as follows:

- Increase the gain (K_p) until the motor becomes unstable. Instability can be seen by observing if the measured value starts to fluctuate. Furthermore, instability is audible as the motor starts hunting up and down. Some systems, such as temperature controls, are slow-reacting, meaning that it may be several minutes before the motor becomes unstable.
- Set the gain (K_p) to half of the value which made the motor unstable. This is the correct setting of the gain.
- Reduce the integral time (T_i) until the motor becomes unstable.
- Set the integral time (T_i) to twice the value which made the motor unstable. This is the correct setting of the integral time.

General rules of thumb:

- If the controller is too slow-reacting, increase K_p .
- If the controller is hunting or unstable, dampen the system by reducing K_p or increasing T_i .

5.4.3 External setpoint

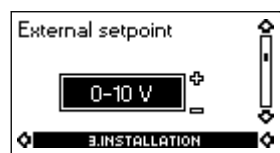

The input for external setpoint signal can be set to different signal types.

Select one of the following types:

- 0-10 V
- 0-20 mA
- 4-20 mA
- Not active.

If Not active is selected, the setpoint set by means of the R100 or on the control panel will apply.

If one of the signal types is selected, the actual setpoint is influenced by the signal connected to the external setpoint input. See the section on external setpoint signal.

Related information

[5.8 External setpoint signal](#)

5.4.4 Signal relay

Pumps of 20-30 hp have two signal relays. Signal relay 1 is factory set to Alarm and signal relay 2 to Warning.

In one of the displays below, select in which one of three or six operating situations the signal relay should be activated.

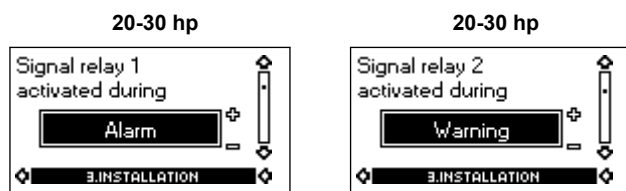

- | | |
|--|--|
| <ul style="list-style-type: none"> • Ready • Alarm • Operation • Pump running • Warning • Relubricate. | <ul style="list-style-type: none"> • Ready • Alarm • Operation • Pump running • Warning • Relubricate. |
|--|--|



Fault and Alarm cover faults resulting in Alarm. Warning covers faults resulting in Warning. Relubricate covers only that one individual event. For distinction between alarm and warning, see the section on fault indications.

For further information, see the section on indicator lights and signal relay.

Related information

[5.2.3 Fault indications](#)

[5.11 Indicator lights and signal relay](#)

5.4.5 Buttons on pump

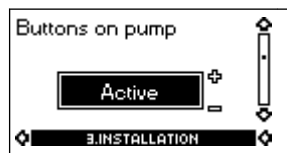

The operating buttons ☺ and ☹ on the control panel can be set to these values:

- Active
- Not active.

When set to Not active (locked), the buttons do not function. Set the buttons to Not active if the pump should be controlled via an external control system.

5.4.6 Pump number



A number between 1 and 64 can be allocated to the pump. In the case of bus communication, a number must be allocated to each pump.

5.4.7 Digital inputs

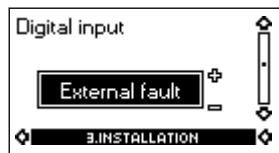

The digital inputs of the pump can be set to different functions.

Select one of the following functions:

- Min. (min. curve)
- Max. (max. curve)
- External fault
- Flow switch
- Dry running (from external sensor) (only three-phase pumps).

The selected function is activated by closing the contact between terminals 1 and 9, 1 and 10 or 1 and 11.

See also the section on digital input.

Min.:

When the input is activated, the pump will operate according to the min. curve.

Max.:

When the input is activated, the pump will operate according to the max. curve.

External fault:

When the input is activated, a timer will be started. If the input is activated for more than 5 seconds, the pump will be stopped and a fault will be indicated. If the input is deactivated for more than 5 seconds, the fault condition will cease and the pump can only be restarted manually by resetting the fault indication.

Flow switch:

When this function is selected, the pump will be stopped when a connected flow switch detects low flow.

It is only possible to use this function if the pump is connected to a pressure sensor.

If the input is activated for more than 5 seconds, the stop function incorporated in the pump will take over. See the section on stop function.

Dry running

When this function is selected, lack of inlet pressure or water shortage can be detected. This requires the use of an accessory, such as these:

- a Grundfos Liqtec® dry-running sensor
- a pressure switch installed on the suction side of a pump
- a float switch installed on the suction side of a pump.

When lack of inlet pressure or water shortage (Dry running) is detected, the pump will be stopped. The pump cannot restart as long as the input is activated.

Related information

[5.4.8 Stop function](#)

[5.7 Digital input](#)

5.4.8 Stop function

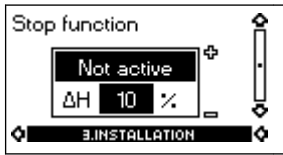

The stop function can be set to these values:

- Active
- Not active.

When the stop function is active, the pump will be stopped at very low flows. The controller will stop the pump to protect the pump as follows:

- avoid unnecessary heating of the pumped liquid
- reduce wear of the shaft seals
- reduce noise from operation.

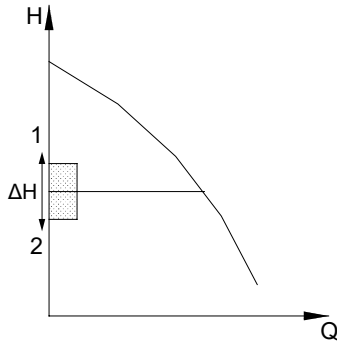

Difference between start and stop pressures (ΔH)

Pos.	Description
1	Stop pressure
2	Start pressure

ΔH is factory-set to **10 % of actual setpoint**.

ΔH can be set within the range from 5 % to 30 % of actual setpoint.

Low flow can be detected in two different ways:

1. A built-in "low-flow detection function" which functions if the digital input is not set up for flow switch.
2. A flow switch connected to the digital input.

1. Low-flow detection function

The pump will check the flow regularly by reducing the speed for a short time. If there is no or only a small change in pressure, this means that there is low flow. The speed will be increased until the stop pressure (actual setpoint + 0.5 x ΔH) is reached and the pump will stop. When the pressure has fallen to the start pressure (actual setpoint - 0.5 x ΔH), the pump will restart.

When restarting, the pumps will react differently according to pump type:

Three-phase pumps

1. If the flow is higher than the low-flow limit, the pump will return to continuous operation at constant pressure.
2. If the flow is still lower than the low-flow limit, the pump will continue in start/stop operation. It will continue in start/stop operation until the flow is higher than the low-flow limit; when the flow is higher than the low-flow limit, the pump will return to continuous operation.

2. Flow switch

When the digital input is activated for more than 5 seconds because there is low flow, the speed will be increased until the stop pressure (actual setpoint + 0.5 x ΔH) is reached, and the pump will stop.

When the pressure has fallen to start pressure, the pump will start again. If there is still no flow, the pump will quickly reach stop pressure and stop. If there is flow, the pump will continue operating according to the setpoint.

Operating conditions for the stop function

It is only possible to use the stop function if the system incorporates a pressure sensor, a non-return valve and a diaphragm tank.



The non-return valve must always be installed before the pressure sensor. See the figures below.

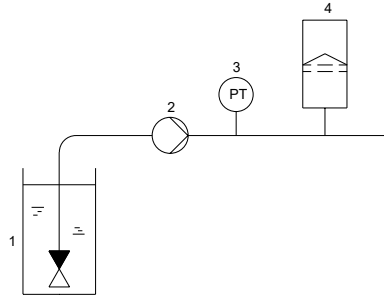

Position of the non-return valve and pressure sensor in system with suction lift operation

Pos.	Description
1	Non-return valve
2	Pump
3	Pressure sensor
4	Diaphragm tank

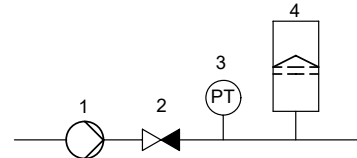

Position of the non-return valve and pressure sensor in system with positive inlet pressure

Pos.	Description
1	Pump
2	Non-return valve
3	Pressure sensor
4	Diaphragm tank

Diaphragm tank

The stop function requires a diaphragm tank of a certain minimum size. The tank must be installed immediately after the pump and the precharge pressure must be 0.7 x actual setpoint.

Recommended diaphragm tank size:

Rated flow of pump [gpm (m ³ h)]	CRE pump	Typical diaphragm tank size [gal (liter)]
0-26 (0 - 5.9)	1s, 1, 3	2 (7.6)
27-105 (6.1 - 23.8)	5, 10, 15	4.4 (16.7)
106-176 (24.2 - 40)	20, 32	14 (53.0)
177-308 (40.2 - 70.0)	45	34 (128.7)
309-440 (70.2 - 99.9)	64, 90	62 (234.7)
441-750 (100-170)	120, 150	86 (325.5)

If a diaphragm tank of the above size is installed in the system, the factory setting of ΔH is the correct setting.

If the tank installed is too small, the pump will start and stop too often. This can be remedied by increasing ΔH .

5.4.9 Flow limit for the stop function



Flow limit for the stop function only works if the system is not set up for flow switch.

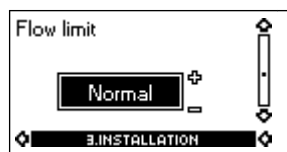

In order to set at which flow rate the system is to go from continuous operation at constant pressure to start/stop operation, select among these four values of which three are preconfigured flow limits:

- Low
- Normal
- High
- Custom.

The default setting of the pump is Normal, representing approx. 10 % of the rated flow rate of the pump.

If a lower flow limit than normal is desired or the tank size is smaller than recommended, select Low.

If a higher flow than normal is wanted or a large tank is used, set the limit to High.

The value Custom can be seen in R100 but it can only be set by means of the PC Tool E-products. Custom is for customized set-up and optimizing to the process.

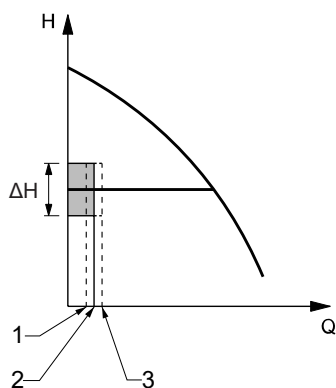

Three preconfigured flow limits, Low, Normal and High

TM039060

Pos.	Description
1	Low
2	Normal
3	High

5.4.10 Sensor

Without sensor
(uncontrolled)

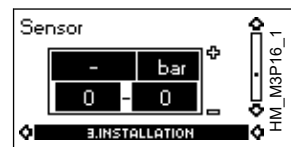

With pressure sensor
(controlled)

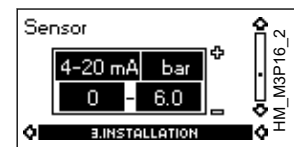

The setting of the sensor is only relevant in the case of controlled operation.

Select among the following values:

- Sensor output signal
 - 0-10 V
 - 0-20 mA
 - 4-20 mA.
- Unit of measurement of sensor: bar, mbar, m, kPa, psi, ft, m³/h, m³/s, l/s, gpm, °C, °F, %,
- Sensor measuring range.

5.4.11 Duty/standby

The duty/standby function applies to two pumps connected in parallel and controlled via GENIBus.



The duty/standby function can be set to these values:

- Active
- Not active.

When the function is set to Active, the following applies:

- Only one pump is running at a time.
- The stopped pump (standby) will automatically be cut in if the running pump (duty) has a fault. A fault will be indicated.
- Changeover between the duty pump and the standby pump will take place every 24 hours.

Activate the duty/standby function as follows:

1. Install and prime the two pumps according to the installation and operating instructions supplied with the pumps.
2. Check that the power supply is connected to the first pump according to the installation and operating instructions.
3. Use Grundfos R100 to set the duty/standby to Not active in the installation menu.
4. Use Grundfos R100 to set the Operating mode to Stop in the operation menu.
5. Use Grundfos R100 to set the other displays as required for the pump application (such as setpoint).
6. Disconnect the power supply to both pumps.

7. Installation of the AYB cable (91125604):
 - a. Remove the plug from each MLE terminal box with a flat head screw driver. See fig. 'Removing the plug and connecting cable gland to the terminal box'.
 - b. Screw a new cable gland into each MLE terminal box with a crescent wrench. See fig. 'Removing the plug and connecting cable gland to the terminal box'.
 - c. Loosen the new cable gland caps and push the cable ends through the cable glands and into MLE motors.
 - d. Remove the AYB connector plug from the first MLE motor. See fig. 'AYB connector plug'.
 - e. Connect the black wire to the A terminal of the AYB connector plug.
 - f. Connect the orange wire to the Y terminal of the AYB connector plug.
 - g. Connect the red wire to the B terminal of the AYB connector plug.
 - h. Reconnect the AYB connector plug to the first MLE motor.
 - i. Tighten the cable gland cap to secure the cable. See fig. 'Removing the plug and connecting cable gland to the terminal box'.
 - j. Repeat steps d to i for the second MLE motor.
8. Connect the power supply to the two pumps according to the installation and operation instructions.
9. Use Grundfos R100 to check that the Operating mode is set to Normal in the operation menu of the second pump.
10. Use Grundfos R100 to set the other displays as required for the pump application (such as Setpoint).
11. Use Grundfos R100 to set the duty/standby to Active in the installation menu of the second pump. Please note the second pump will search for the first pump and automatically set the duty/standby to Active in the installation menu.
12. The second pump will operate for the first 24 hours. The two pumps will then alternate operation every 24 hours.

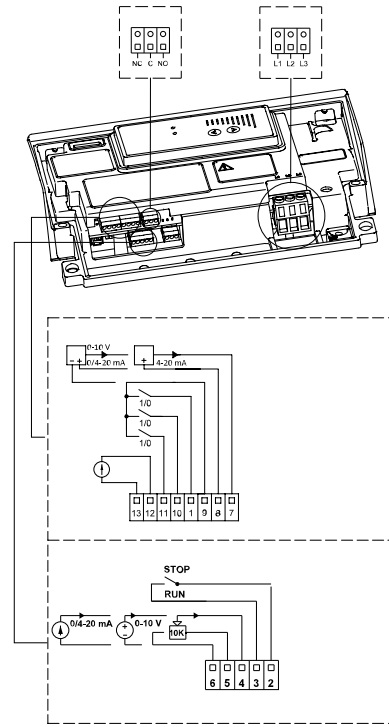

AYB connector plug

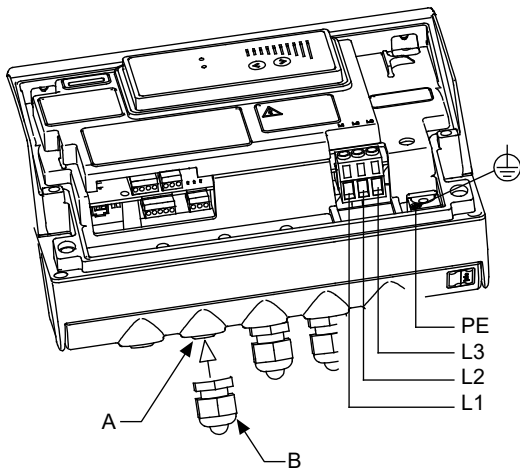

TM051626

Removing the plug and connecting cable gland to the terminal box

Pos.	Description
A	Plug
B	Cable gland

TM052985

5.4.12 Operating range

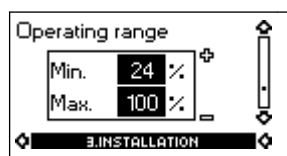

How to set the operating range:

- Set the min. curve within the range from max. curve to 12 % of maximum performance. The pump is factory-set to 24 % of maximum performance.
- Set the max. curve within the range from maximum performance (100 %) to min. curve.

The area between the min. and max. curves is the operating range.

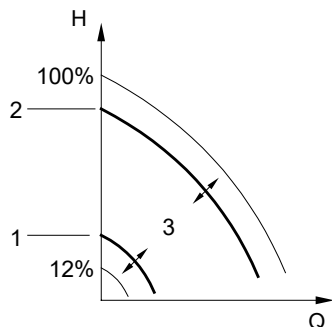

TM007747

Setting of the min. and max. curves in % of maximum performance

Pos.	Description
1	Min. curve
2	Max. curve
3	Operating range

5.4.13 Motor bearing monitoring (only three-phase pumps)



The motor bearing monitoring function can be set to these values:

- Active
- Not active.

When the function is set to Active, a counter in the controller will start counting the mileage of the bearings. See the section on lubrication status of motor bearings (only 11-22 kW).



The counter will continue counting even if the function is switched to Not active, but a warning will not be given when it is time for relubrication. When the function is switched to Active again, the accumulated mileage will again be used to calculate the relubrication time.

Related information

[5.3.7 Lubrication status of motor bearings \(only 20-30 hp\)](#)

[5.3.7 État de lubrification des roulements moteur \(20-30 HP uniquement\)](#)

[5.3.7 Estado de lubricación de los cojinetes del motor \(solo modelos de 20-30 HP\)](#)

5.4.14 Confirming relubrication/replacement of motor bearings (only three-phase pumps)



This function can be set to these values:

- Relubricated (only 20-30 hp)
- Replaced
- Nothing done.

When the bearing monitoring function is Active, the controller will give a warning indication when the motor bearings are due to be relubricated or replaced. See the section on fault indications.

When the motor bearings have been relubricated or replaced, confirm this action in the above display by pressing OK.



Relubricated cannot be selected for a period of time after confirming relubrication.

Related information

[5.2.3 Fault indications](#)

5.4.15 Standstill heating (only three-phase pumps)



The standstill heating function can be set to these values:

- Active
- Not active.

When the function is set to Active, an AC voltage will be applied to the motor windings. The applied voltage will ensure that sufficient heat is generated to avoid condensation in the motor.

5.5 Typical display settings for constant-pressure E-pumps

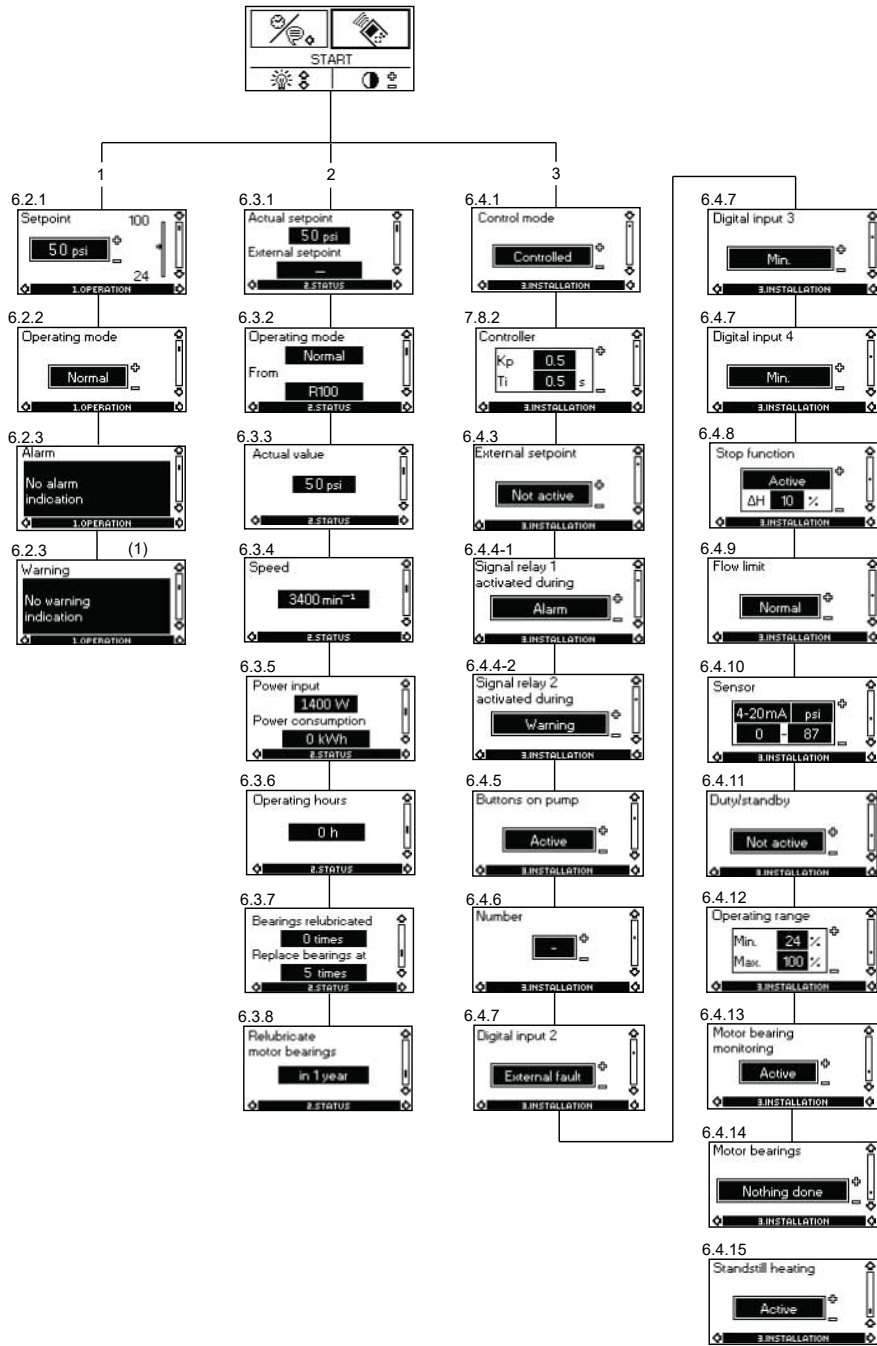

Menu overview

Pos.	Description
1	Operation
2	Status
3	Installation

5.6 Typical display settings for analog-input E-pumps

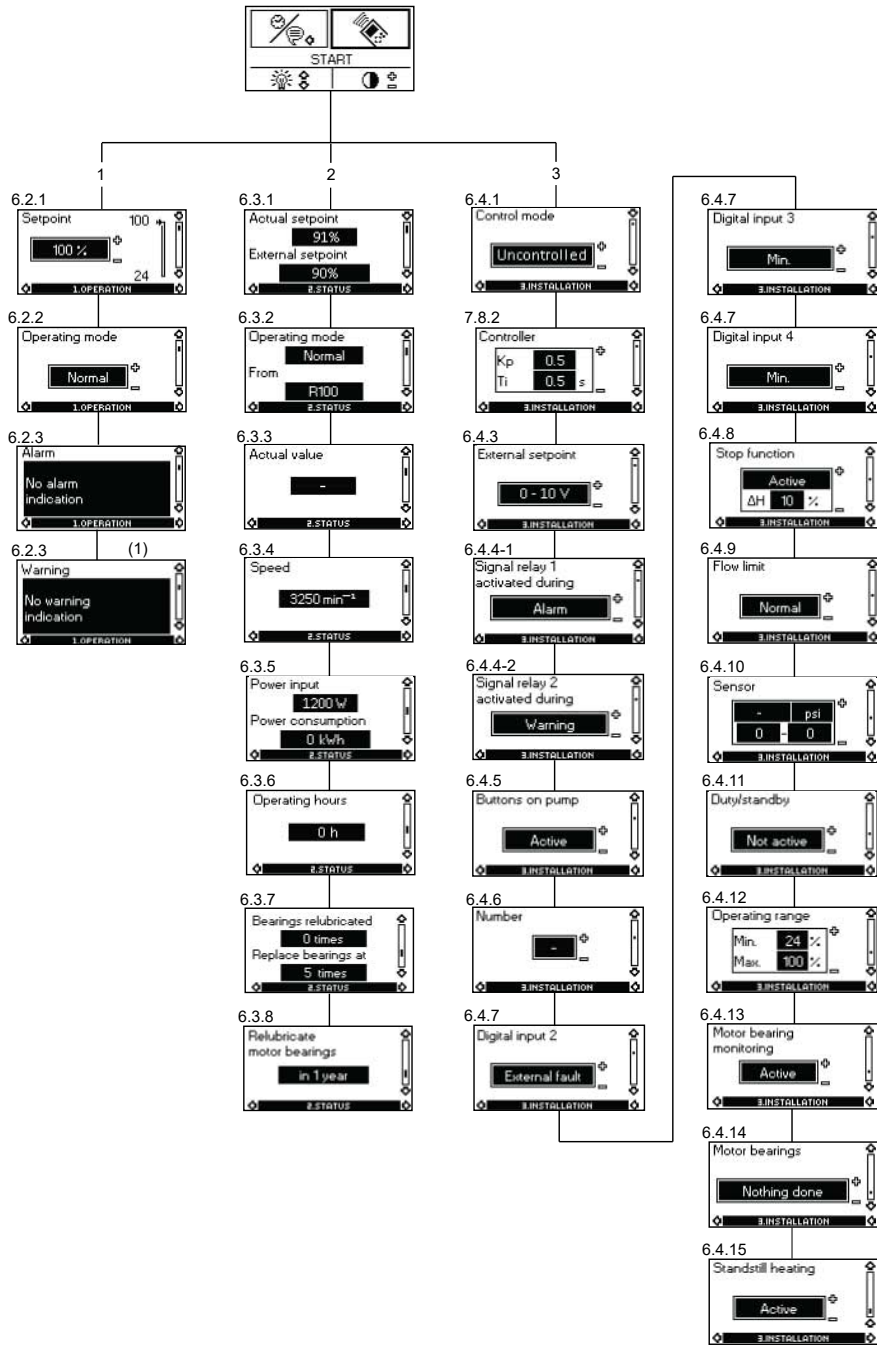

Menu overview

Pos.	Description
1	Operation
2	Status
3	Installation

5.7 Digital input

By means of the R100, one of the following functions can be selected for the digital input:

- Normal duty
- Min. curve
- Max. curve
- External fault
- Flow switch
- Dry running.

Functional diagram: Input for digital function

Digital function		
(terminals 1 and 9)	(terminals 9 and 10)	(terminals 9 and 11)
		Normal duty
		Min. curve
		Max. curve
		External fault
		Flow switch
		Dry running

5.8 External setpoint signal

The setpoint can be remote-set by connecting an analogue signal transmitter to the input for the setpoint signal (terminal 4).

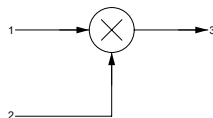

Actual setpoint as a product (multiplied value) of setpoint and external setpoint

Pos.	Description
1	Setpoint
2	External setpoint
3	Actual setpoint

Select the actual external signal, 0-10 V, 0-20 mA, 4-20 mA, via the R100. See the section on external setpoint.

If control mode **uncontrolled** is selected by means of the R100, the pump can be controlled by any controller.

In control mode **controlled**, the setpoint can be set externally within the range from the lower value of the sensor measuring range to the setpoint set on the pump or by means of the R100.

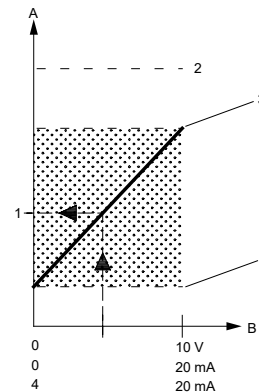

Relation between the actual setpoint and the external setpoint signal in control mode controlled

Pos.	Description
A	Actual setpoint
B	External setpoint signal
1	Actual setpoint
2	Sensor _{max}
3	Setpoint set by means of control panel, R100 or PC Tool E-products
4	Sensor _{min}

Example: At a sensor_{min} value of 0 psi, a setpoint set of 50 psi and an external setpoint of 80 % (an 8 V analog signal to Terminal 4 if using an analog signal of 0-10 V), the actual setpoint will be as follows:

$$\begin{aligned}
 \text{Actual setpoint} &= (\text{setpoint} - \text{sensor}_{\min}) \times \%_{\text{external setpoint}} + \text{sensor}_{\min} \\
 &= (50 - 0) \times 80 \% + 0 \\
 &= 40 \text{ psi}
 \end{aligned}$$

In control mode **uncontrolled**, the setpoint can be set externally within the range from the min. curve to the setpoint set on the pump or by means of the R100. Typically the setpoint is set to 100 % when the control mode is uncontrolled (see the section on typical display settings for analog-input E-pumps).

TMO28988

TMO38601

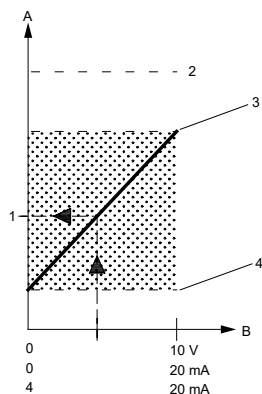

TM028988

Relation between the actual setpoint and the external setpoint signal in control mode uncontrolled

Pos.	Description
A	Actual setpoint
B	External setpoint signal
1	Actual setpoint
2	Max _{curve}
3	Setpoint set by means of control panel, R100 or PC Tool E-products
4	Min _{curve}

Related information

[5.4.3 External setpoint](#)

[5.6 Typical display settings for analog-input E-pumps](#)

5.9 Bus signal

The pump supports serial communication via an RS-485 input. The communication is carried out according to Grundfos bus protocol, GENIbus protocol, and enables connection to a building management system or another external control system.

Operating parameters, such as setpoint, operating mode, etc. can be remote-set via the bus signal. At the same time, the pump can provide status information about important parameters, such as actual value of control parameter, input power, fault indications, etc. Contact Grundfos for further details.



If a bus signal is used, the number of settings available via the R100 will be reduced.

5.10 Other bus standards

Grundfos offers various bus solutions with communication according to other standards.

Contact Grundfos for further details.

5.11 Indicator lights and signal relay

The operating condition of the pump is indicated by the green and red indicator lights fitted on the pump control panel and inside the terminal box. See the figure below.

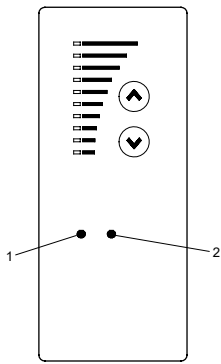

TM028513

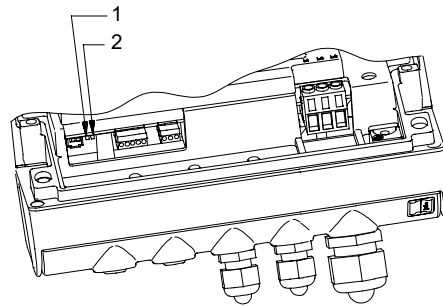

TM029036

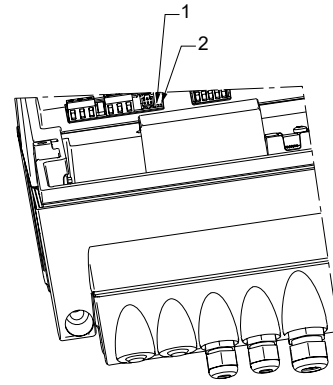



TM039063

Pos.	Description
1	Green
2	Red

Position of indicator lights



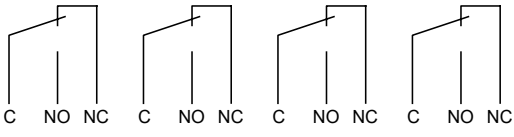
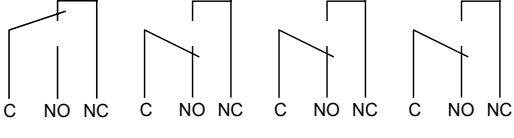
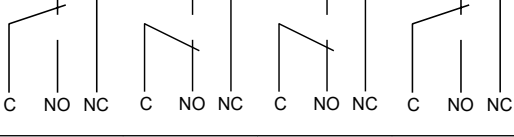

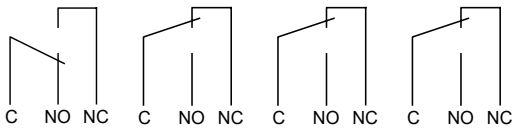
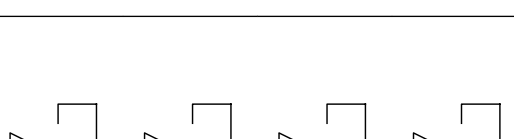
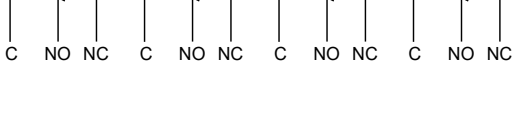
Besides, the pump incorporates an output for a potential-free signal via an internal relay. For signal relay output values, see the section on signal relay.

The functions of the two indicator lights and the signal relay are as shown in the following table:

Indicator lights		Signal relay activated during:				Description
Fault (red)	Operation (green)	Fault/ Alarm, Warning and Relubricate	Operating	Ready	Pump running	
Off	Off					The power supply has been switched off.
Off	Permanently on					The pump is operating.
Off	Permanently on					The pump is stopped by the stop function.
Off	Flashing					The pump has been set to stop.
Permanently on	Off					The pump has stopped because of a Fault/Alarm or is running with a Warning or Relubricate indication. If the pump was stopped, restarting will be attempted (it may be necessary to restart the pump by resetting the Fault indication). If the cause is "external fault", the pump must be restarted manually by resetting the Fault indication.
Permanently on	Permanently on					The pump is operating, but it has or has had a Fault/ Alarm allowing the pump to continue operation or it is operating with a Warning or Relubricate indication. If the cause is "sensor signal outside signal range", the pump will continue operating according to the 70 % curve and the fault indication cannot be reset until the signal is inside the signal range. If the cause is "setpoint signal outside signal range", the pump will continue operating according to the min. curve and the fault indication cannot be reset until the signal is inside the signal range.
Permanently on	Flashing					The pump has been set to stop, but it has been stopped because of a Fault.

Resetting of fault indication

A fault indication can be reset in one of the following ways:

- Briefly press the button  or  on the pump. This will not change the setting of the pump. A fault indication cannot be reset by means of  or  if the buttons have been locked.
- Switch off the power supply until the indicator lights are off.
- Switch the external start/stop input off and then on again.
- Use the R100. See the section on fault indications.

When the R100 communicates with the pump, the red indicator light will flash rapidly.

Related information

[5.2.3 Fault indications](#)

[5.4.4 Signal relay](#)

6. Setting the product

6.1 Factory settings

6.1.1 Pumps without factory-fitted sensor

The pumps have been factory-set to control mode uncontrolled. The setpoint value corresponds to 100 % of the maximum pump performance (see data sheet for the pump).

6.1.2 Pumps with pressure sensor

The pumps have been factory-set to control mode controlled. The setpoint value corresponds to 50 % of the sensor measuring range (see sensor nameplate).

6.2 Setting by means of control panel

The pump control panel, see the figure below, incorporates the following buttons and indicator lights:

- Buttons, Ⓢ and Ⓣ, for setpoint setting.
- Light fields, yellow, for indication of setpoint.
- Indicator lights, green (operation) and red (fault).

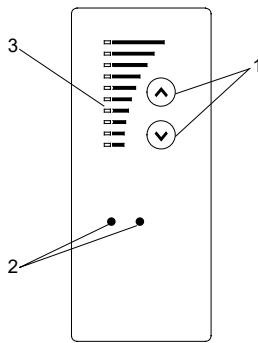

TM028513

Control panel, three-phase pumps, 20-30 hp

Pos.	Description
1	Buttons
2	Indicator lights
3	Light fields

6.3 Setting of operating mode

Settings available:

- Normal
- Stop
- Min.
- Max.

Start/stop of pump

Start the pump by continuously pressing Ⓢ until the desired setpoint is indicated. This is operating mode Normal.

Stop the pump by continuously pressing Ⓣ until none of the light fields are activated and the green indicator light flashes.

Setting to Min.

Press Ⓣ continuously to change to the min. curve of the pump (bottom light field flashes). When the bottom light field is on, press Ⓢ for 3 seconds until the light field starts flashing.

To return to uncontrolled or controlled operation, press Ⓢ continuously until the desired setpoint is indicated.

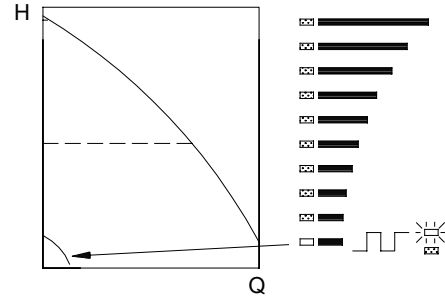

Min. curve duty

TM007346

Setting to Max.

Press Ⓢ continuously to change to the max. curve of the pump (top light field flashes). When the top light field is on, press Ⓢ for 3 seconds until the light field starts flashing.

To return to uncontrolled or controlled operation, press Ⓣ continuously until the desired setpoint is indicated.

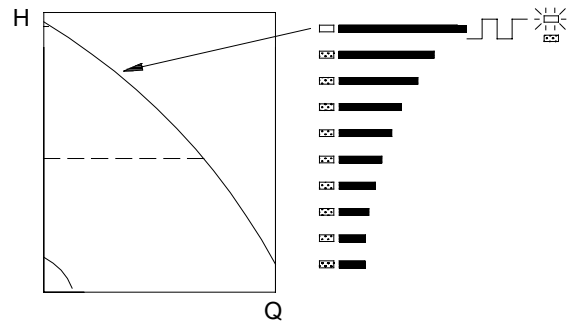

Max. curve duty

TM007345

6.4 Setpoint setting

Set the desired setpoint by pressing the button Ⓢ or Ⓣ.

The light fields on the control panel will indicate the setpoint set. See examples in the sections on pump in control mode controlled (pressure control) and pump in control mode uncontrolled.

Related information

[6.4.1 Pump in control mode controlled \(pressure control\)](#)

[6.4.2 Pump in control mode uncontrolled](#)

6.4.1 Pump in control mode controlled (pressure control)

Example

The figure below shows that the light fields 5 and 6 are activated, indicating a desired setpoint of 3 bar. The setting range is equal to the sensor measuring range (see sensor nameplate).

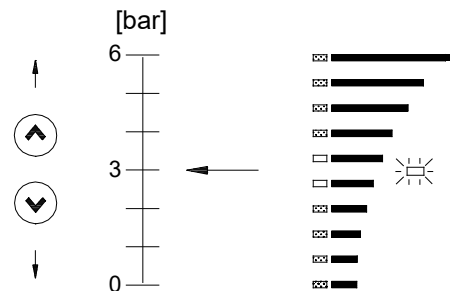

Setpoint set to 3 bar, pressure control

TM007743

6.4.2 Pump in control mode uncontrolled

Example

In control mode uncontrolled, the pump performance is set within the range from min. to max. curve. See the figure below.

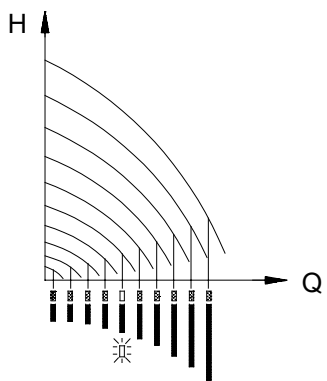

TM007746

Pump performance setting, control mode uncontrolled

6.5 Setting by means of R100

The pump is designed for wireless communication with Grundfos remote control R100.

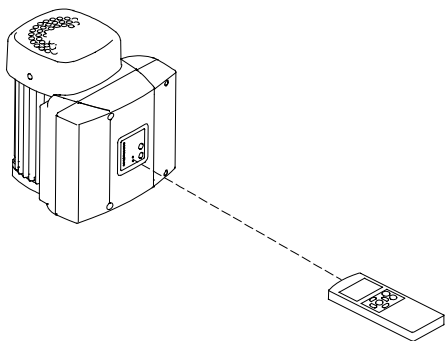

TM020936

R100 communicating with the pump via infra-red light

During communication, the R100 must be pointed at the control panel. When the R100 communicates with the pump, the red indicator light will flash rapidly. Keep pointing the R100 at the control panel until the red LED diode stops flashing.

The R100 offers setting and status displays for the pump.

The displays are divided into four parallel menus (see fig. 'Menu overview'):

0. GENERAL (see operating instructions for the R100)
1. OPERATION
2. STATUS
3. INSTALLATION

The figure above each individual display in fig. 'Menu overview' refers to the section in which the display is described.

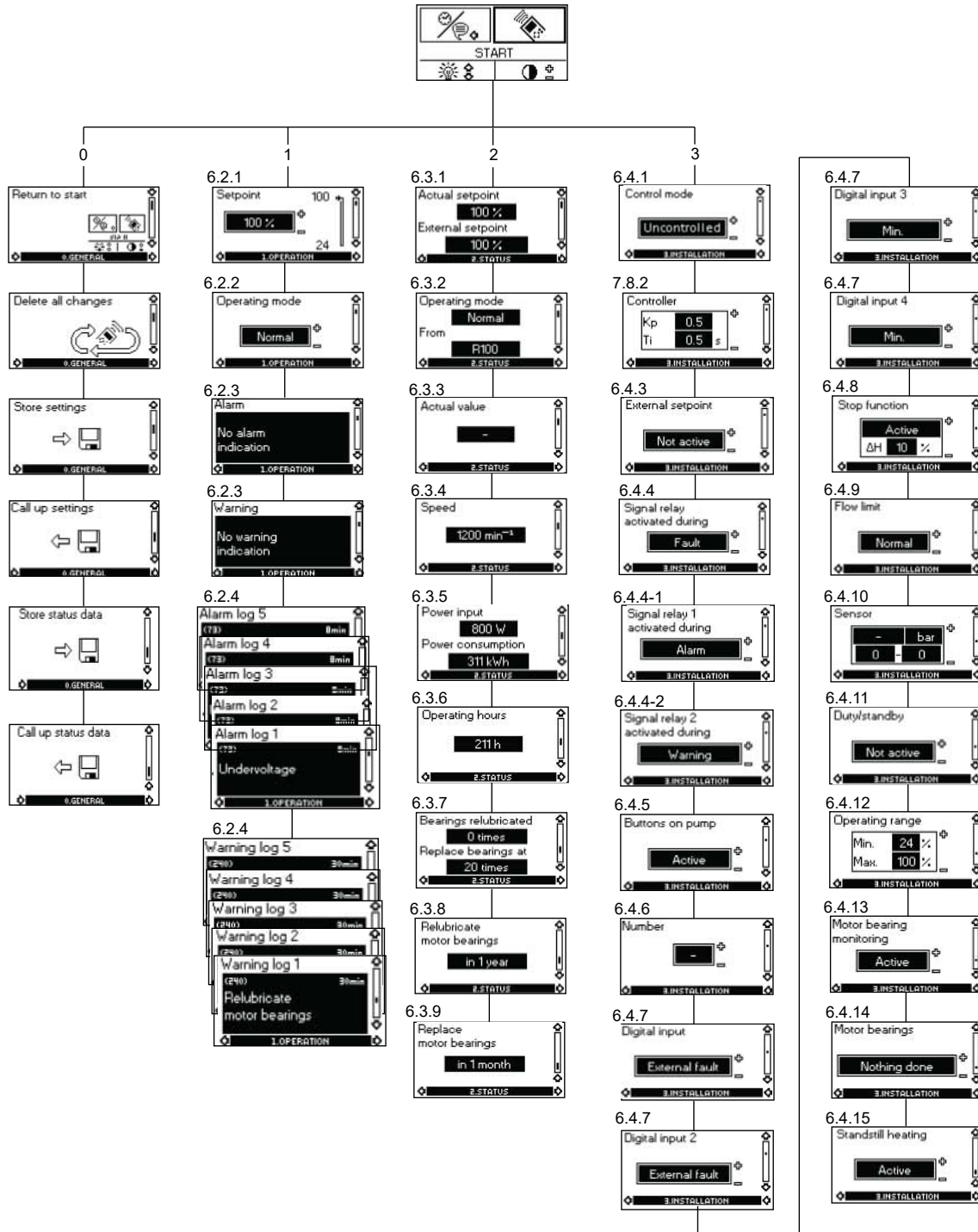

Menu overview

Pos.	Description
0	General
1	Operation
2	Status
3	Installation

Related information

[5.5 Typical display settings for constant-pressure E-pumps](#)

6.6 Grundfos GO

The pump is designed for wireless radio or infrared communication with Grundfos GO.

Grundfos GO enables setting of functions and gives access to status overviews, technical product information and actual operating parameters.

Grundfos GO offers the following mobile interfaces (MI).

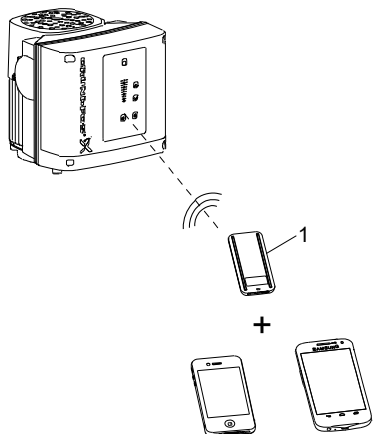

TM066256

Grundfos GO communicating with the pump via radio or infrared connection (IR)

Pos.	Description
1	Grundfos MI 301: Separate module enabling radio or infrared communication. You can use the module in conjunction with an Android or iOS-based smart device with Bluetooth connection.

6.6.1 Communication

When Grundfos GO Remote communicates with the pump, the indicator light in the middle of the Grundfos Eye will flash green.

Communication must be established using one of these communication types:

- radio communication
- infrared communication.

Radio communication

Radio communication can take place at distances up to 30 meters. It is necessary to enable communication by pressing or **OK** on the pump control panel.

Infrared communication

When communicating via infrared light, Grundfos GO Remote must be pointed at the pump control panel.

6.6.2 Navigation

Navigation can be done from the dashboard. See the figure below.

Dashboard

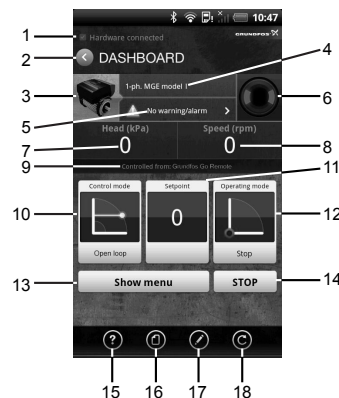

TM055609

Example of dashboard

Pos.	Description	Action
1	Connection indicator	This text appears when Grundfos GO Remote app has connected to an MI 201, MI 202 or MI 301. If the hardware is not connected, it will not be possible to communicate with a Grundfos product.
2	Back button	Returns to the previous display.
3	Product information	Provides technical information about the product.
4	Product name	Name of the product communicating with Grundfos GO Remote.
5	Alarms and warnings	Shows alarms and warnings.
6	Grundfos Eye	Shows the operating condition of the product.
7	Primary status value	Shows the primary status value.
8	Secondary status value	Shows the secondary status value.
9	Control source	Shows by which interface the product is controlled.
10	Control mode	Shows the control mode of the product.
11	Actual setpoint value	Shows the actual setpoint value.
12	Operating mode	Shows the operating mode.
13	Show menu	Gives access to other menus.
14	Stop	Stops the product.
Tool bar		
15	Help	The help function describes the menus making it easy for the user to change settings, etc.
16	Documentation	Gives access to installation and operating instructions and quick guides.
17	Report	Enables the creation of user-defined reports.
18	Update	Enables update of Grundfos GO Remote app.

6.7 Setting by means of PC Tool E-products

Special setup requirements differing from the settings available via the R100 require the use of Grundfos PC Tool E-products. This again requires the assistance of a Grundfos service technician or engineer. Contact your local Grundfos company for more information.

6.8 Priority of settings

The priority of settings depends on two factors:

1. control source
2. settings.

1. Control source

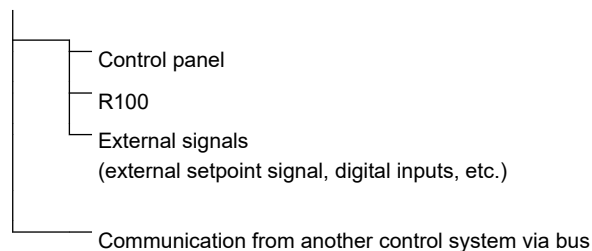

6.8.1 2. Settings

- Operating mode Stop
- Operating mode Max. (Max. curve)
- Operating mode Min. (Min. curve)
- Setpoint setting.

An E-pump can be controlled by different control sources at the same time, and each of these sources can be set differently. Consequently, it is necessary to set an order of priority of the control sources and the settings.



If two or more settings are activated at the same time, the pump will operate according to the function with the highest priority.

6.8.2 Priority of settings without bus communication

Priority	Control panel or R100	External signals
1	Stop	
2	Max.	
3		Stop
4		Max.
5	Min.	Min.
6	Setpoint setting	Setpoint setting

Example: If the E-pump has been set to operating mode Max. (Max. frequency) via an external signal, such as digital input, the control panel or R100 can only set the E-pump to operating mode Stop.

6.8.3 Priority of settings with bus communication

Priority	Control panel or R100	External signals	Bus communication
1	Stop		
2	Max.		
3		Stop	Stop
4			Max.
5			Min.
6			Setpoint setting

Example: If the E-pump is operating according to a setpoint set via bus communication, the control panel or R100 can set the E-pump to operating mode Stop or Max., and the external signal can only set the E-pump to operating mode Stop.

6.9 External forced-control signals

The pump has inputs for external signals for these forced-control functions:

- start/stop of pump
- digital function.

6.9.1 Start/stop input

Functional diagram: Start/stop input:

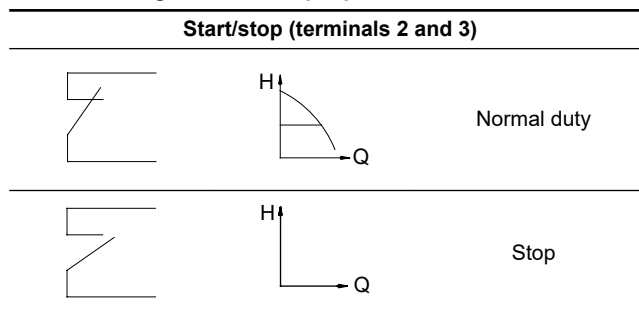

7. Taking the product out of operation

7.1 Emergency operation (only 20-30 hp)

DANGER

Electric Shock

Death or serious personal injury



- Never make any connections in the pump terminal box unless all electric supply circuits have been switched off for at least 5 minutes.
- Note for instance that the signal relay may be connected to an external supply which is still connected when the power supply is disconnected.

If the pump is stopped and you cannot start the pump immediately after normal remedies, the reason could be a faulty frequency converter. If this is the case it is possible to maintain emergency operation of the pump.

Before change over to emergency operation we recommend you to:

- check that the power supply is OK
- check that control signals are working (start/stop signals)
- check that all alarms are reset
- make a resistance test on the motor windings (disconnect the motor leads from the terminal box).

If the pump remains stopped it is possible that the frequency converter is faulty.

To establish emergency operation proceed as follows:

1. Disconnect the three power supply leads, L1, L2, L3, from the terminal box, but leave the protective ground lead(s) in position on the PE terminal(s).

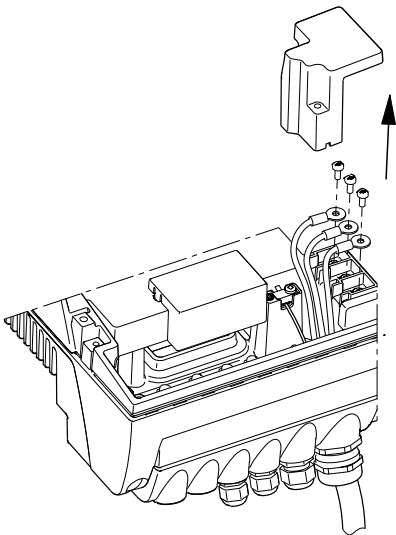

TM038607

2. Disconnect the motor supply leads, U/W1, V/U1, W/V1, from the terminal box.

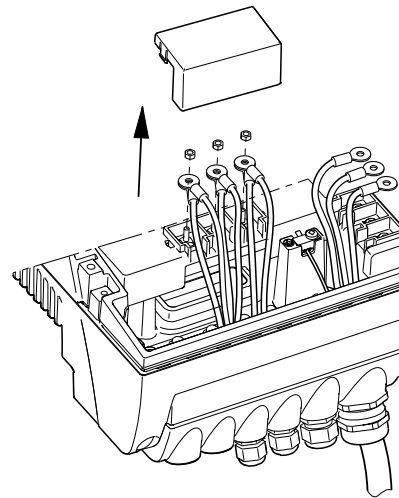

TM039120

3. Connect the leads as shown in the figure below.

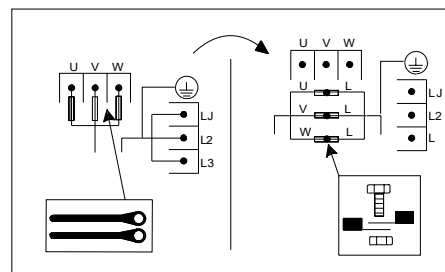

TM040018

How to switch an E-pump from normal operation to emergency operation

Use the screws from the power supply terminals and the nuts from the motor terminals.

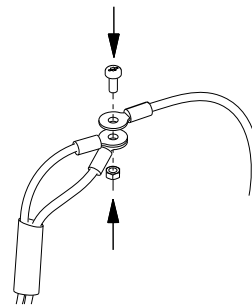

TM039121

4. Insulate the three leads from each other by means of insulating tape or the like.

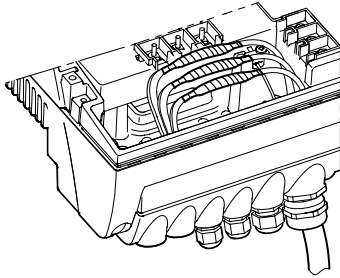
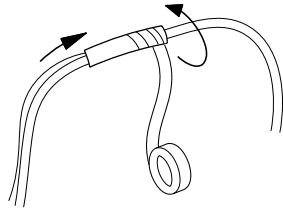

TM039122

TM039123

DANGER

Electric Shock

Death or serious personal injury



- Do not bypass the frequency converter by connecting the power supply leads to the U, V and W terminals.
- This may cause hazardous situations for personnel as the high voltage potential of the power supply may be transferred to touchable components in the terminal box.



Check the direction of rotation when starting up after switching to emergency operation.

5. A motor starter is required.

7.2 Insulation resistance

20-30 hp



- Do not measure the insulation resistance of an installation incorporating E-pumps using high voltage megging equipment, as this may damage the built-in electronics.
- The motor leads can be disconnected separately and the insulation resistance of the motor windings can be tested.

8. Servicing the product

8.1 Cleaning of the motor

Keep the motor cooling fins and fan blades clean to ensure sufficient cooling of the motor and electronics.

8.2 Relubrication of motor bearings

20-30 hp pumps

The motor bearings are of the open type and must be relubricated regularly. The motor bearings are prelubricated on delivery. The built-in bearing monitoring function will give a warning indication on the R100 when the motor bearings are due to be relubricated.

Remove the diaphragm plug in the fan cover to access the grease nipple in the non-drive end (NDE) of the motor.



When the new grease is injected, the old grease will escape into the bearing cover inside the motor.



Do not overgrease the bearings. Overgreasing will cause increased bearing heat and may result in bearing and motor failure.

Frame size	Quantity of grease [ounces]	
	Drive end (DE)	Non-drive end (NDE)
MLE 160	0.44	0.44
MLE 180	0.51	0.51

The recommended grease type is a lithium-based lubricating grease.

8.3 Replacement of motor bearings

20-30 hp motors have built-in bearing monitoring function which will give a warning indication on the R100 when the motor bearings are due to be replaced.

8.4 Replacement of varistor (only 20-30 hp)

The varistor protects the pump against voltage transients. If voltage transients occur, the varistor will be worn over time and need to be replaced. The more transients, the more quickly the varistor will be worn. When it is time to replace the varistor, R100 and PC Tool E-products will indicate this as a warning.

A Grundfos technician is required for replacement of the varistor. Contact your local Grundfos company for assistance.

8.5 Service parts and service kits

For further information on service parts and service kits, visit www.grundfos.com, select country, select Grundfos Product Center.

9. Technical data

9.1 Three-phase pumps, 20-30 hp

9.1.1 Supply voltage

3 x 460-480 V - 10 %/+ 10 %, 50/60 Hz - 3 %/+ 3 %, PE.

Cable: Max. 10 mm² / 8 AWG.

Use min. 158 °F (70 °C) copper conductors only.

Recommended fuse sizes

Motor size [hp]	Max. [A]
20	36
25	43
30	51

Standard as well as quick-blow or slow-blow fuses may be used.

9.1.2 Overload protection

The overload protection of the E-motor has the same characteristic as an ordinary motor protector. As an example, the E-motor can stand an overload of 110 % of I_{nom} for 1 min.

9.1.3 Leakage current

Ground leakage current > 10 mA.

The leakage currents are measured in accordance with EN 61800-5-1.

9.1.4 Inputs/output

Start/stop

External potential-free contact.

Voltage: 5 VDC.

Current: < 5 mA.

Screened cable: 0.5 - 1.5 mm² / 28-16 AWG.

Digital

External potential-free contact.

Voltage: 5 VDC.

Current: < 5 mA.

Screened cable: 0.5 - 1.5 mm² / 28-16 AWG.

Setpoint signals

- Potentiometer
0-10 VDC, 10 k Ω (via internal voltage supply).
Screened cable: 0.5 - 1.5 mm² / 28-16 AWG.
Maximum cable length: 328 ft.
- Voltage signal
0-10 VDC, $R_i > 50$ k Ω .
Tolerance: + 0 %/- 3 % at maximum voltage signal.
Screened cable: 0.5 - 1.5 mm² / 28-16 AWG.
Maximum cable length: 1640 ft.
- Current signal
DC 0-20 mA/4-20 mA, $R_i = 250$ Ω .
Tolerance: + 0 %/- 3 % at maximum current signal.
Screened cable: 0.5 - 1.5 mm² / 28-16 AWG.
Maximum cable length: 1640 ft.

Sensor signals

- Voltage signal
0-10 VDC, $R_i > 50$ k Ω (via internal voltage supply).
Tolerance: + 0 %/- 3 % at maximum voltage signal.
Screened cable: 0.5 - 1.5 mm² / 28-16 AWG.
Maximum cable length: 1640 ft.
- Current signal
DC 0-20 mA/4-20 mA, $R_i = 250$ Ω .
Tolerance: + 0 %/- 3 % at maximum current signal.

Screened cable: 0.5 - 1.5 mm² / 28-16 AWG.
Maximum cable length: 1640 ft.

Internal power supplies

- 10 V power supply for external potentiometer:
Max. load: 2.5 mA.
Short-circuit protected.
- 24 V power supply for sensors:
Max. load: 40 mA.
Short-circuit protected.

Signal relay output

Potential-free changeover contact.

Maximum contact load: 250 VAC, 2 A, $\cos \varphi$ 0.3 - 1.

Minimum contact load: 5 VDC, 10 mA.

Screened cable: 0.5 - 2.5 mm² / 28-12 AWG.

Maximum cable length: 1640 ft.

Bus input

Grundfos bus protocol, GENibus protocol, RS-485.

Screened 3-core cable: 0.2 - 1.5 mm² / 28-16 AWG.

Maximum cable length: 1640 ft.

9.2 Other technical data

EMC (electromagnetic compatibility to EN 61800-3)

Motor [hp]	Emission/immunity
	Emission: The motors are category C3, corresponding to CISPR11, group 2, class A, and may be installed in industrial areas (second environment). If equipped with an external Grundfos EMC filter, the motors are category C2, corresponding to CISPR11, group 1, class A, and may be installed in residential areas (first environment).
20	
25	
30	



When the motors are installed in residential areas, supplementary measures may be required as the motors may cause radio interference.

Motor sizes 25, and 30 hp comply with EN 61000-3-12 provided that the short-circuit power at the interface point between the user's electrical installation and the public power supply network is greater than or equal to the values stated below. It is the responsibility of the installer or user to ensure, by consultation with the power supply network operator, if necessary, that the motor is connected to a power supply with a short-circuit power greater than or equal to these values:

Motor size [hp]	Short-circuit power [kVA]
20	-
25	2700
30	3000



20 hp motors do not comply with EN 61000-3-12.

By installing an appropriate harmonic filter between the motor and the power supply, the harmonic current content will be reduced. In this way, the 20 hp motor will comply with EN 61000-3-12.

Immunity:

The motors fulfill the requirements for both the first and second environment.

Contact Grundfos for further information.

Enclosure class

- Three-phase pumps, 20-30 hp: IP55 (IEC 34-5)

Insulation class

F (IEC 85)

Ambient temperature

During operation:

- Minimum: -4 °F (-20 °C)
- Maximum: +104 °F (40 °C) without derating

During storage/transport:

- -13 °F (-25 °C) to +158 °F (70 °C) (20-30 hp)

Relative air humidity

Maximum 95 %.

Sound pressure level

Motor [hp]	Speed stated on the nameplate [rpm]	Sound pressure level [dB(A)]
20		70
25	3400-3600	74
30		78

10. Disposing of the product

This product or parts of it must be disposed of in an environmentally sound way.

1. Use the public or private waste collection service.
2. If this is not possible, contact the nearest Grundfos company or service workshop.



The crossed-out wheeled bin symbol on a product means that it must be disposed of separately from household waste. When a product marked with this symbol reaches its end of life, take it to a collection point designated by the local waste disposal authorities. The separate collection and recycling of such products will help protect the environment and human health.

See also end-of-life information at www.grundfos.com/product-recycling.

11. Document quality feedback

To provide feedback about this document, scan the QR-code using your phone's camera or a QR code app.



[Click here to submit your feedback](#)

FEEDBACKK98566352

Appendix A

A.1. Installation in the USA and Canada



To maintain the cURus approval, the additional information in this section must be followed.
The UL approval is according to UL 1004-1.

Outdoor installation

According to UL 778/C22.2 No 108-14, pumps intended for outdoor use must be marked enclosure type 3 and the product must be tested at a surface temperature down to -35 °C. The MLE enclosure is approved for type 3 or 4 and is rated at a surface temperature down to 0 °C, thus it is only for indoor use in UL 778/C22.2 No 108-14 pump applications.

For more information about ambient temperature during operation, see the sections on operating conditions and ambient temperature.

Canadian Interference-Causing Equipment Standard

This product complies with the Canadian ICES-003 Class B specifications. This Class B device meets all the requirements of the Canadian interference-causing equipment regulations.

Cet appareil numérique de la Classe B est conforme à la norme NMB-003 du Canada. Cet appareil numérique de la Classe B respecte toutes les exigences du règlement sur le matériel brouilleur du Canada.

A.1.1. Electrical codes

For the USA

This product complies with the Canadian Electrical Code and the US National Electrical Code.

This product has been tested according to the national standards for Electronically Protected Motors:

CSA 22.2 100-14:2014 (applies to Canada only).

UL 1004-1:2015 (applies to USA only).

Pour le Canada

Codes de l'électricité:

Ce produit est conforme au code canadien de l'électricité et au code national de l'électricité américain.

Ce produit a été testé selon les normes nationales s'appliquant aux moteurs protégés électroniquement:

CSA 22.2 100.04: 2009 (s'applique au Canada uniquement).

UL 1004-1: Juin 2011 (s'applique aux États-Unis uniquement).

A.1.2. Radio communication

For the USA

This device complies with Part 15 of the FCC rules and RSS210 of the IC rules. Operation is subject to the following two conditions:

- This device may not cause interference.
- This device must accept any interference, including interference that may cause undesired operation of the device.

Users are cautioned that changes or modifications not expressly approved by Grundfos could void the user's authority to operate the equipment.

Pour le Canada

Ce dispositif est conforme à la partie 15 des règles de la FCC et aux normes RSS210 de l'IC. Son fonctionnement est soumis aux deux conditions suivantes:

- Ce dispositif ne doit pas provoquer de brouillage préjudiciable.
- Il doit accepter tout brouillage reçu, y compris le brouillage pouvant entraîner un mauvais fonctionnement.

A.1.3. Identification numbers

For the USA

Grundfos Holding A/S

Contains FCC ID: OG3-RADIOM01-2G4.

For Canada

Grundfos Holding A/S

Model: RADIOMODULE 2G4

Contains IC: 10447A-RA2G4M01.

Pour le Canada

Numéros d'identification:

Grundfos Holding A/S

Modèle: RADIOMODULE 2G4

Contient IC: 10447A-RA2G4M01.

Location of identification numbers

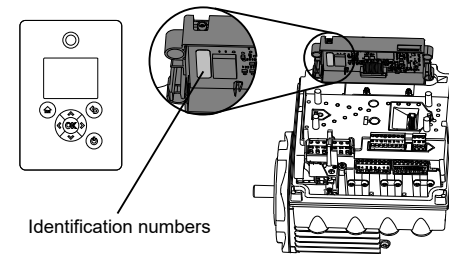
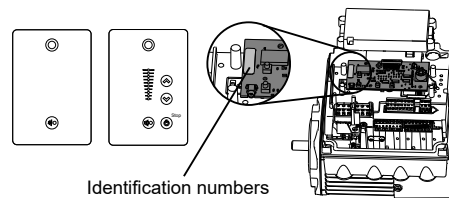

TM069745

TM069746

A.1.4. Electrical connection

Conductors

See the sections on electrical installation and cable requirements.

Torques

See the section on torques.

Line reactors

The maximum line reactor size in front of the drive must not exceed the following values:

P2		Maximum line reactor size [mH]	
[kW]	[HP]	1450-2000 rpm 1450-2200 rpm	2900-4000 rpm 4000-5900 rpm
0.25 - 3	0.5 - 3	1.5	1.5
4	5	0.7	0.7
5.5	7.5	0.9	0.3
7.5	10	0.6	0.6
11	15	0.3	0.3

Exceeding these values creates resonance between the reactor and the drive, which reduces the life of the product.

Short-circuit current

If a short circuit occurs, the pump can be used on a mains supply delivering not more than 5000 RMS symmetrical amperes, 600 V maximum.

Fuses

Fuses used for motor protection must be rated for minimum 500 V. Motors up to and including 10 HP require class K5 UL-listed fuses. Any UL-listed fuse can be used for motors of 15 HP.

Branch-circuit protection

When the pump is protected by a circuit breaker, the circuit breaker must be rated for a maximum voltage of 480 V. The circuit breaker must be of the "inverse time" type.

Overload protection

Degree of overload protection provided internally by the drive, in percent of full-load current: 102 %.

U.S.A.

Global Headquarters for WU
856 Koomey Road
Brookshire, Texas 77423 USA
Phone: +1-630-236-5500

GRUNDFOS CBS Inc.
902 Koomey Road
Brookshire, TX 77423 USA
Phone: 281-994-2700
Toll Free: 1-800-955-5847
Fax: 1-800-945-4777

GRUNDFOS Pumps Corporation
9300 Loiret Boulevard
Lenexa, Kansas 66219 USA
Tel.: +1 913 227 3400
Fax: +1 913 227 3500

Canada

GRUNDFOS Canada inc.
2941 Brighton Road
Oakville, Ontario
L6H 6C9
Tel.: +1-905 829 9533
Fax: +1-905 829 9512

Mexico

Bombas GRUNDFOS de México
S.A. de C.V.
Boulevard TLC No. 15
Parque industrial Stiva Aeropuerto
Apodaca, N.L. 66600
Tel.: +52-81-8144 4000
Fax: +52-81-8144 4010

Revision Info

Last revised on 04-2021

98566352 11.2022
ECM: 1353331