

# CR, CRN 32•45•64•90 Dismantling & Reassembly



### CONTENTS

**Dismantling Procedures**.....Page 2  
 When Should A Part Be Replaced ?.....Page 12

**Reassembly Procedures** .....Page 13  
 Setting The Coupling Height.....Page 21  
 Order of Stage Assembly - CR, CRN 32.....Page 23  
 Order of Stage Assembly - CR, CRN 45.....Page 24  
 Order of Stage Assembly - CR, CRN 64.....Page 25  
 Order of Stage Assembly - CR, CRN 90.....Page 26

### TORQUES

Position Number		
7a	Screw for Guard	6 ft.-lbs./8 Nm
9	Coupling Screws	63 ft.-lbs./85 Nm
26b	Allen Screw for Strap	11 ft.-lbs./15 Nm
28	Allen Screw Motor Stool to Pump Head	46 ft.-lbs./62 Nm
28a	Allen Screw for Motor	
	1/2" x 13 UNC, 3-40 HP	30 ft.-lbs./40 Nm
	5/8" x 11 UNC, 50-60 HP	59 ft.-lbs./80 Nm
31	Allen Screw for Bottom Stationary Bearing	6 ft.-lbs./8 Nm
36	Staybolt Nut	74 ft.-lbs./100 Nm
48	Split Cone Nut	52 ft.-lbs./70 Nm
58a & 58d	Allen Screw Seal Carrier	46 ft.-lbs./62 Nm
67	Allen Screw for Shaft Bearing	23 ft.-lbs./31 Nm
113	Allen Set Screw for Shaft Seal	6 ft.-lbs./8 Nm

## Dismantling Procedures CR, CRN 32•45•64•90

In the instructions below, the numbers in parenthesis (7) indicate the position number of that part as it is shown on the Parts List and Kits diagram.

These instructions cover the repair of the pump after it has been isolated from the system. Before removing the pump from the system, make sure all valves are closed. Relieve any built-up pressure by opening the vent plug screw. The power source should be turned off and locked out before starting any work. Removal of field wiring to the motor may be required. Color coding or numbering the wires will aid in reinstallation.

For shaft seal change only on a Standard unit or a Cool Top®, follow steps 1 to 8.

Pumps built with Back-to-Back seals, follow steps 1 to 11.

Pumps built with Tandem/Quench seals, follow steps 35 to 49.



**1** Loosen, **but do not remove**, Coupling Guard Screws (Pos. 7a). Remove Coupling Guards (Pos. 7) from the Motor Stool (Pos. 1a).

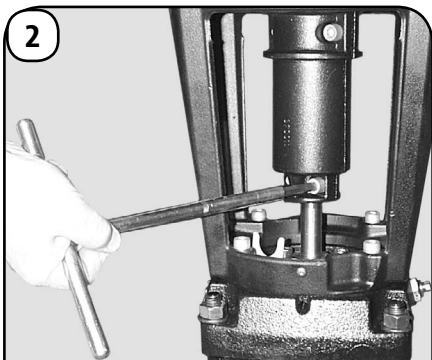

**2** Use an Allen wrench with an 8 mm tip to loosen and remove the Coupling Screws (Pos. 9) from the Coupling Halves (Pos. 10a).

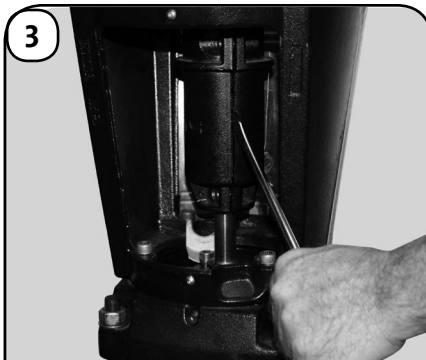

**3** To remove the coupling halves, insert a flat/slot blade screwdriver in the coupling gap and twist to free the first coupling half.

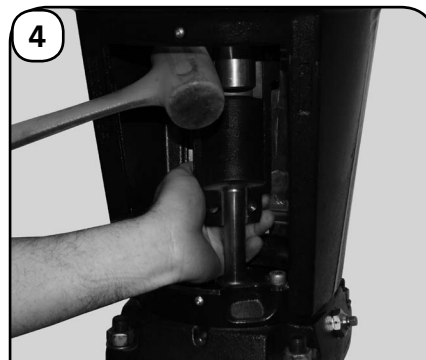

**4** To free/remove the remaining coupling half, strike the upper edge of the coupling half with a rubber mallet.

**Note:** If you have multiple pumps, do not interchange coupling components, they are a matched set.



**5** **3 - 10 HP**  
Remove the Motor-to-Pump Bolts (Pos. 28a). Lift the motor off the pump.

**15 HP and UP**  
Motor removal is not necessary. Skip to step 6.

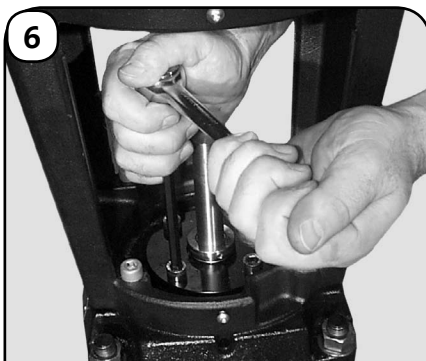

**6** Remove the 8 mm socket Allen Screws (Pos. 58a) from the Seal Retainer (Pos. 58). Remove the retainer.

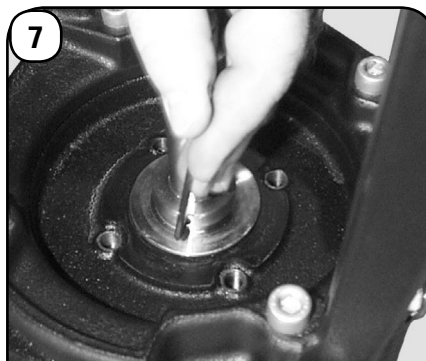

**7** Loosen, **but do not remove**, the 3 mm Set Screws (Pos. 113) from the Shaft Seal (Pos. 105).

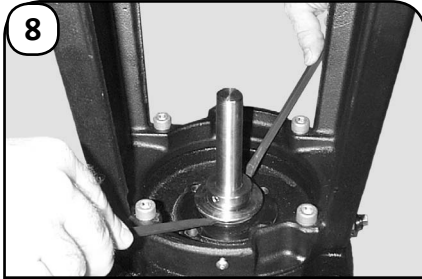

Use two flat/slot blade screwdrivers to pry the seal loose. Lift the seal (Pos. 105) completely off of the shaft (Pos. 51). For seal change only on Standard and Cool Top pumps, go to the Reassembly section step 47. For STACK® (Pos. 80) replacement, Back-to-Back Inboard Seal (Pos. 105b) and Cool Top Connecting Pipe (Pos. 149) removal, continue with step 10.



**Cartridge Seals**

Will lift out as a complete assembly.

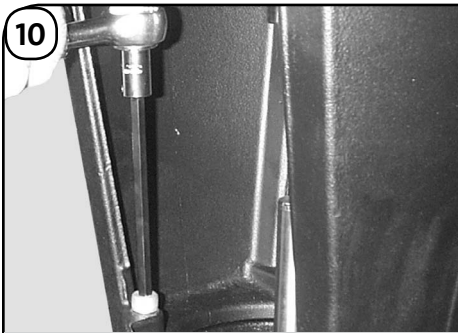

3 - 10 HP

Loosen and remove the 8 mm hex socket Allen Screws (Pos. 28) connecting the motor stool to Pump Head (Pos. 2).



15 HP and UP

**To remove the Motor Stool (Pos. 1a):** Loosen the allen screws connecting the motor stool to the pump head. Leave the motor stool attached to the motor and/or bearing flange to protect the motor shaft and bearing flange shaft.

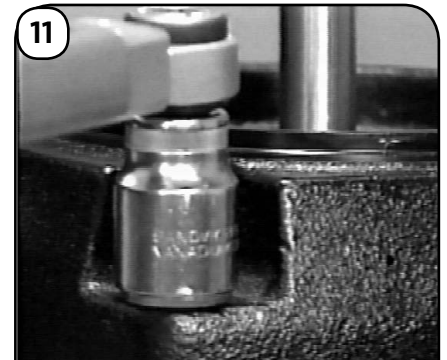

Loosen and remove the 24 mm Staybolt Nuts (Pos.36) and Washers (Pos. 66a). **For Standard pumps**, skip to dismantling step 50. **For Cool Top units**, continue with steps 12 to 20. **For Back-to-Back units**, continue with steps 21 to 34.

Cool-Top®

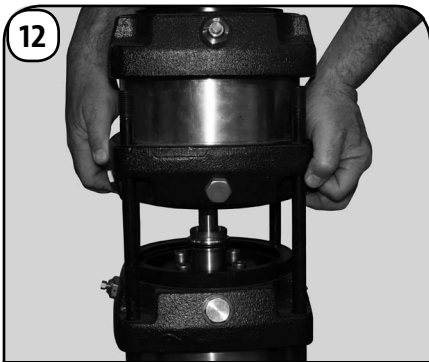

12 Remove the upper most Pump Head (Pos. 2b), Upper Sleeve (Pos. 55a) and middle Pump Head (Pos. 2c) as a complete assembly if it has not leaked, then skip to step 16. If the assembly has leaked follow steps 13 to 15.

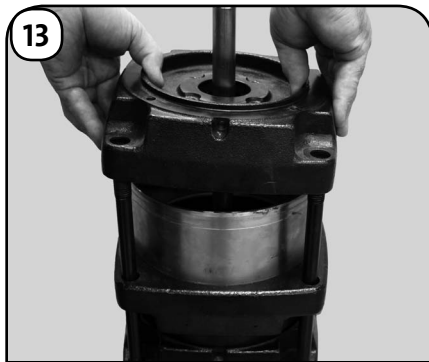

13 Remove the upper most pump head. This may require light upward blows with rubber mallet to the underside of the pump head.



14 To remove the upper sleeve, diagonally grip the Staybolts (Pos. 26). Using your thumbs, press against the sleeve to release the sleeve from the middle pump head. If it does not move freely, light blows with a rubber mallet might be required. Once loose, lift the sleeve off.

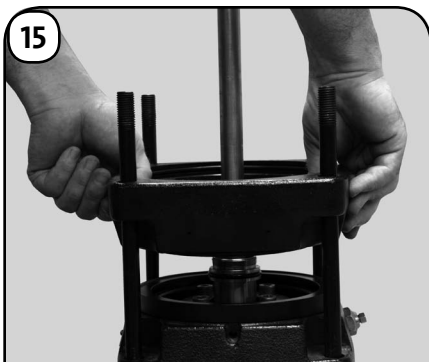

15 Lift off the middle pump head.



16 Lift off the Spacing ring (Pos. 116).

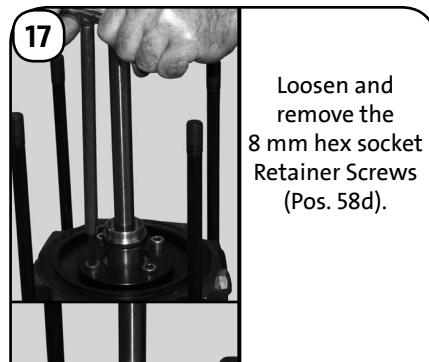

17 Loosen and remove the 8 mm hex socket Retainer Screws (Pos. 58d).  
  
Remove the Connecting Pipe Retainer (Pos. 58c).

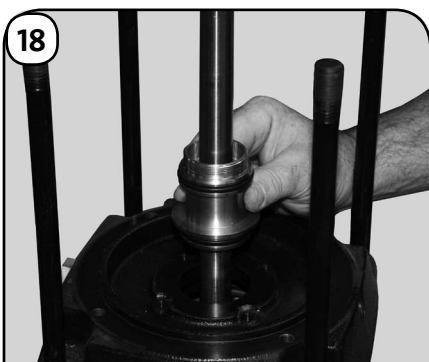

18 Remove the Connecting Pipe (Pos. 149).



19 Place the connecting pipe into one of the pump heads. Use 005V2128 and a rubber mallet to drive out the Retainer Ring (Pos. 47h) and Bushings (Pos. 47g).



20 Remove the O-rings (Pos. 109a and 109b). For reassembly of the connecting pipe go to the Reassembly section step 18. To continue disassembly, proceed to step 50.



## Back-to-Back Seal

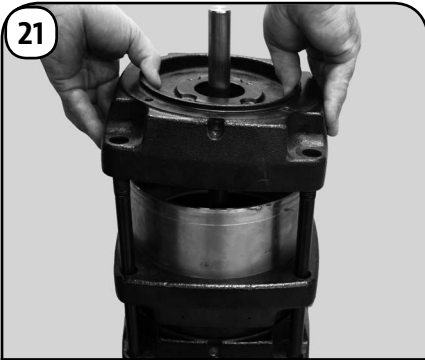

21

Remove the upper most Pump Head (Pos. 2b). This may require light upward blows with rubber mallet to the underside of the pump head.



22

To remove the Upper Sleeve (Pos. 55a), diagonally grip the Staybolts (Pos. 26). Use your thumbs to press against the sleeve to release the sleeve from the middle pump head. If it does not move freely, light blows with a rubber mallet might be required. Once loose, lift the sleeve off.



23

To remove the Inboard Shaft Seal (Pos. 105b) loosen, **but do not remove**, the two 3mm Set screws (Pos. 113a) in the Seal Driver (Pos. 112). Lift the seal driver off of the shaft.



24

Remove the Spring (Pos. 108b), Spring/O-ring Cup (Pos. 106b), O-ring (Pos. 107b), Seal Driver (Pos. 111b), and Rotating Seal Face (Pos. 104b).



25

Remove the lower most Pump Head (Pos. 2), Spacing Ring (Pos. 116) and middle Pump Head (Pos. 2c) with Connecting Pipe (Pos. 149) as an assembly. Light upward blows with rubber mallet to the underside of the lower most pump head might be required.



26

Use specialty tool, 00SV7902, to loosen and remove the threaded Seal Retainer (Pos. 148).

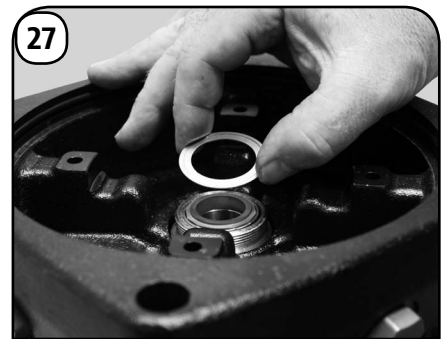

27

Remove the Retaining Washer (Pos. 59a).

### Back-to-Back Seal (continued)



28

Use your finger to reach through the center of the seal, then pull the Stationary Seal from the connecting pipe.



29

Remove the middle pump head and spacing ring.



30

Use an 8 mm Allen wrench to loosen and remove the Retainer Screw (Pos. 58d). Then, remove the Connecting Pipe Retainer (Pos. 58c).

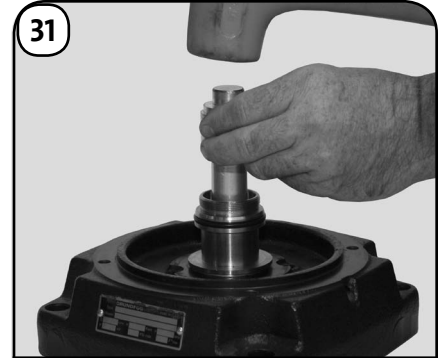

31

Use OOSV2128 and a rubber mallet to drive out the Retainer Ring (Pos. 47h) and Bushings (Pos. 47g).



32

Remove the connecting pipe.

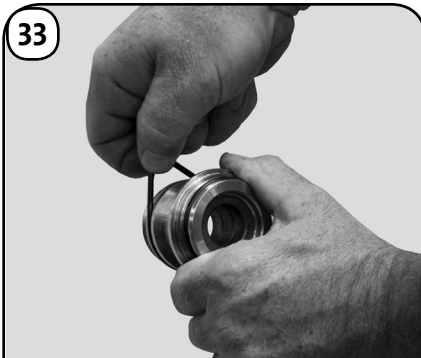

33

Remove the O-rings (Pos. 109a and 109b).

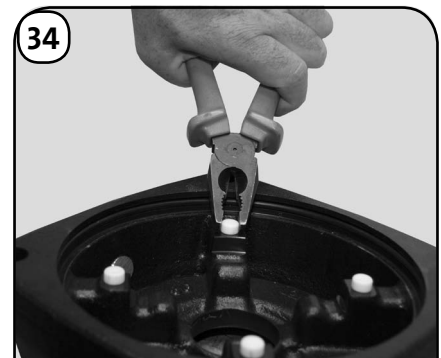

34

Flip the pump head over and remove the four Stack Compression Spacers (Pos. 60). For reassembly of the inboard seal, skip to the Reassembly Section step 25. To continue disassembly, proceed to dismantling step 51.

## Tandem Seal

**35**  Loosen the top Coupling Guard Screw (Pos. 7a), but do not fully remove. Loosen and fully remove the lower screw. Tilt and slide the Coupling Guards (Pos. 7) off of the system flush piping.

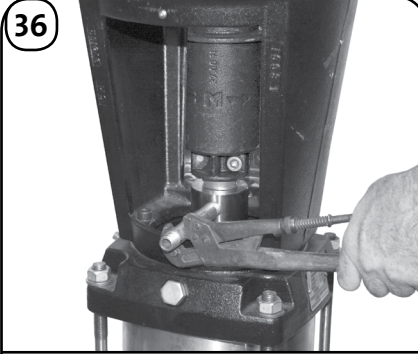
**36**  Remove system flush piping.

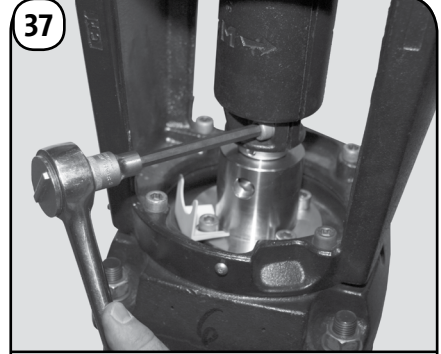
**37**  Use an Allen wrench with an 8 mm tip to loosen and remove the Coupling Screws (Pos. 9) from the Coupling Halves (Pos. 10a).

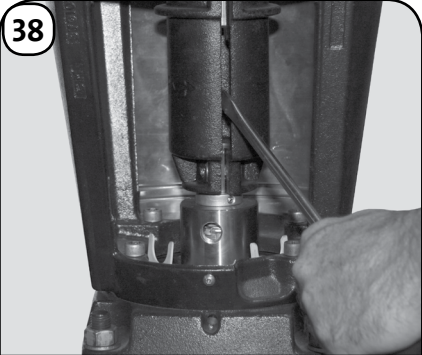
**38**  To remove the coupling halves, insert a flat/slot blade screwdriver in the coupling gap and twist to free the first coupling half.

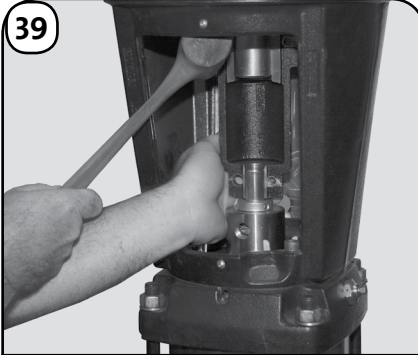
**39**  To free/remove the remaining coupling half, strike the upper edge of the coupling half with a rubber mallet. **Note:** If you have multiple pumps, do not interchange coupling components, they are a matched set.

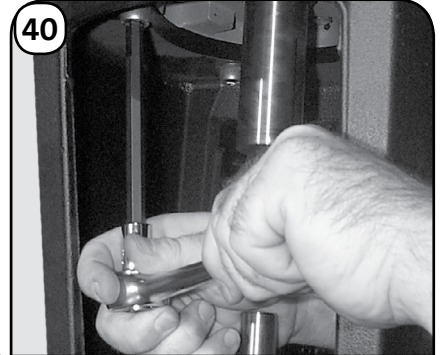
**40**  Regardless of the motor HP size on Tandem Seal equipped pumps, the motor must be removed to change the seals. Remove the motor to pump bolts (Pos. 28a). Lift motor off of motor stool (Pos. 1a).

**41**  Loosen, but do not remove, the 3 mm Set Screws (Pos. 113) from the Tandem Shaft Seal (Pos. 105c).

**42**  Loosen and remove the 8 mm hex socket Allen Screws (Pos. 58b) holding the seal housing.

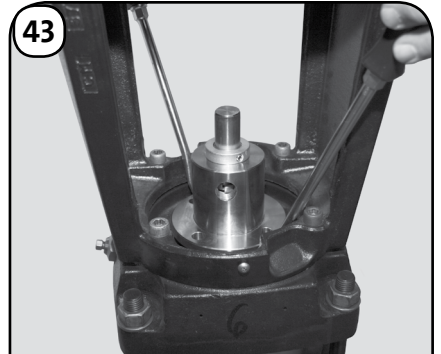
**43**  Use two flat / slot blade screwdrivers to pry the seal loose. Lift the seal (Pos. 105c) completely off of the shaft (Pos. 51).

### Tandem Seal (continued)



44

Remove the Tandem Seal Housing O-ring (Pos. 109c).

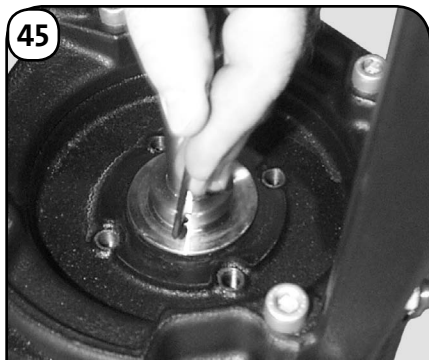

45

Loosen, **but do not remove**, the 3 mm Set Screws (Pos. 113) from the Shaft Seal (Pos. 105).



46

Use two flat/slot blade screwdrivers to pry the seal loose. Lift the seal completely off the shaft. For seal change only, go to the Reassembly section, step 47. To continue disassembly, proceed to step 48.



47

Pos. 105

#### Cartridge Seals

Will lift out as a complete assembly.

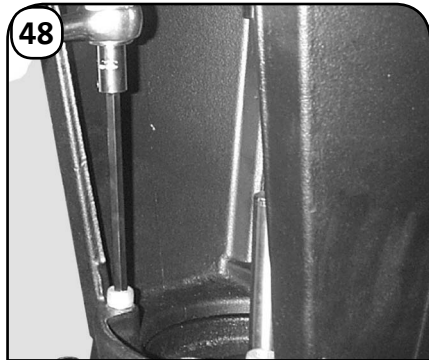

48

Loosen and remove the 8 mm hex socket Allen Screws (Pos. 28) connecting the motor stool to Pump Head (Pos. 2).

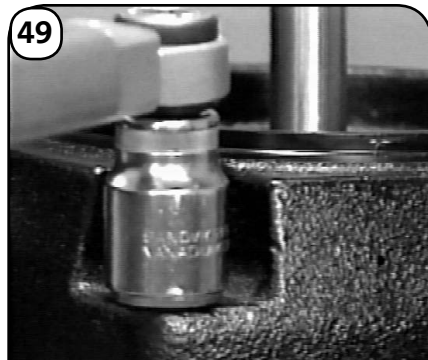

49

Loosen and remove the 24 mm Staybolt Nuts (Pos. 36) and Washers (Pos. 66a).



**50**  
Remove Pump Head (Pos. 2) (this may require light tapping with a rubber mallet to the underside of the pump head to loosen). Once pump head is loose, lift off of pump.



**51**  
To remove Outer Sleeve (Pos. 55), grip staybolts diagonally. Using your thumbs, press against sleeve to release the sleeve from the pump housing. Lift off sleeve.



**52**  
Lift the impeller STACK® (Pos. 80) off the suction/discharge base (Pos. 6). For Stack Replacement instructions, go to Reassembly Section, step 15. To continue disassembly, proceed with steps 54 to 66.

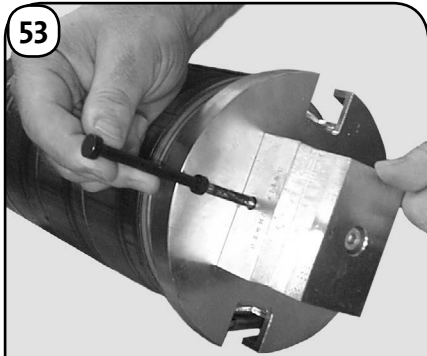

**53**  
Fit assembly/disassembly tool (00SV0003) to Stack. The tool consists of different size spacing plates. Select the plate which fits securely to the Stack Interface (Pos. 44). Place holding pin into the disassembly hole.



**54**  
Loosen the chamber straps, remove 6 mm hex socket Allen Screw (Pos. 26b), Washer (Pos. 26c), and Chamber Straps (Pos. 26a).

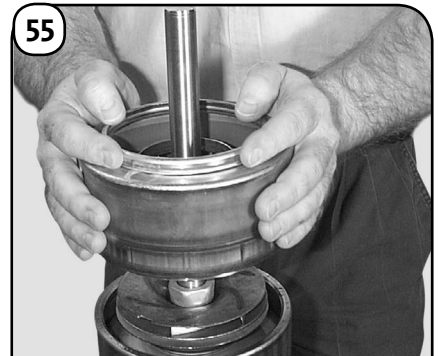

**55**  
Remove the Upper Chamber (Pos. 3).



**56**  
Loosen Split Cone Nut (Pos. 48) approximately two to three full turns with split cone nut wrench (00SV0004). Flip tool over and give a sharp blow directly down against the split cone nut. This will loosen the Split Cone (Pos. 49b) and allow the Impeller (Pos. 49a) to be lifted off the shaft. Lift off Chambers (Pos. 4 & 4a). Repeat this process until all impellers are removed from Shaft (Pos. 51).

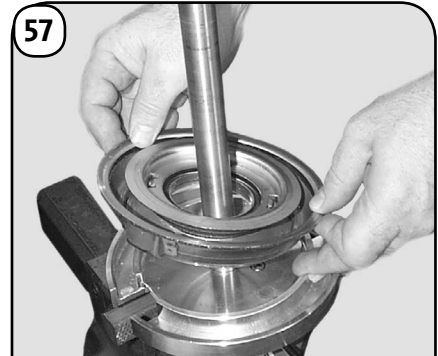

**57**  
Remove Base Interface (Pos. 44).





58 To remove the shaft from the assembly/disassembly tool, remove the holding pin from the shaft and lift shaft out of tool.

After inspecting the parts, if further disassembly is required, proceed to the next steps.

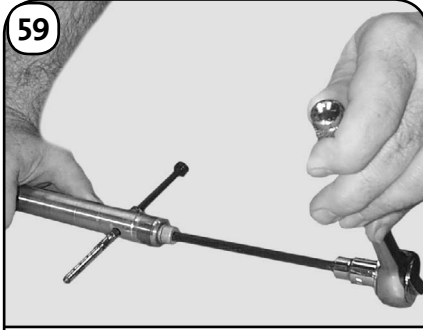

59 Remove bearing from shaft. Remove 6 mm hex socket Allen Screw (Pos. 67), locking washers (Pos. 66b), washer (Pos. 66), and journal bearing (Pos. 47b). Loosening the allen screw may require use of the holding pin as a countering device so the shaft does not spin.



60 Depending on wear, the Neck Ring (Pos. 45), Retainer (Pos. 65), and Holder (Pos. 45a) may need to be removed. Using a flat bar, pry these components out of the chambers and base interface as a complete assembly.



If wear or damage is minor, the neck ring may be replaced using a screwdriver to twist and pry out the retainer.



Lift out the Neck Ring (Pos. 45).

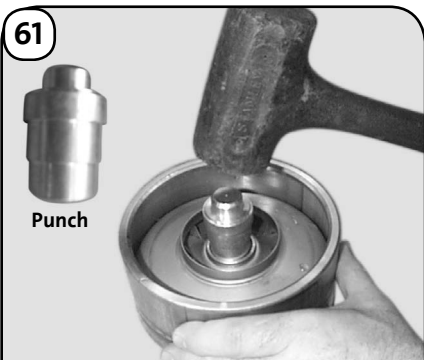

61 To remove the Chamber Bearing (Pos. 47), Bearing Sleeve (Pos. 47c), and Bearing Lock Ring (Pos. 47d), place chamber upward using the punch (00SV0015). Drive the bearing downward.

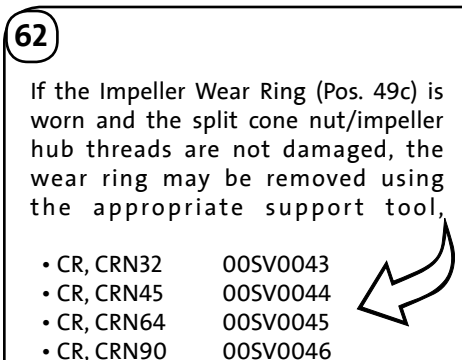

62 If the Impeller Wear Ring (Pos. 49c) is worn and the split cone nut/impeller hub threads are not damaged, the wear ring may be removed using the appropriate support tool,

- CR, CRN32 00SV0043
- CR, CRN45 00SV0044
- CR, CRN64 00SV0045
- CR, CRN90 00SV0046

along with the wear ring puller (00SV0239) used to pry off the wear ring. If the threads of the impeller hub are damaged, a new impeller will be required.



63 To remove the Bottom Bearing (Pos. 6g), loosen and remove the securing 5 mm Allen Screw (Pos. 31) and Washer (Pos. 32) from the Suction/Discharge Base (Pos. 6). Using the bearing puller (00SV0002) and allen screw (00ID6595), insert the bearing puller along with the allen screw at an angle until it passes through the bearing. Once the bearing puller is under the bearing's lower edge, begin turning the allen screw until the bearing has been pryed out of the housing.

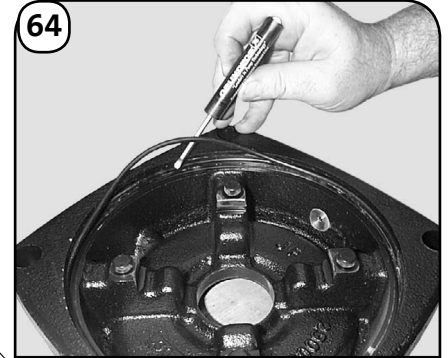









64 Using a small screwdriver, remove Sleeve O-rings (Pos. 37) from the pump head and the suction/discharge base.

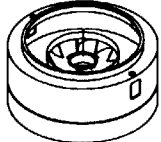

65 Remove the four Stack Compression Spacers (Pos. 60).

— THE PUMP IS —  
**NOW COMPLETELY  
DISASSEMBLED.**

## When Should A Part Be Replaced?

Part	Position(s)	Minimum Operating Condition	
Pump Head	2	Excessive pitting of these castings could cause leaks. Rusted castings should have all seating areas cleaned to ensure proper seating of O-rings.	
Suction/Discharge Base	6		
Chambers	3, 4a, 4	Same as for impellers.	
O-rings	37, 38, 38a, 100	Should be soft and pliable with no visible scars. Since they are easily damaged and fairly inexpensive, it is recommended they be replaced whenever the pump is disassembled.	
Neck Ring	45	Should be free of visible wear on the inside edges. Inside diameter for: CR, CRN 32 = 66.2 mm CR, CRN 45 = 73.9 mm CR, CRN 64 = 86.3 mm CR, CRN 90 = 93.8 mm	
Bearing Ring	47a	The diameter size difference between the Bearing Ring (Pos. 47a) and the Bearing (47-47c) fixed inside the intermediate chambers should be no greater than 0.4 mm.	
Bushing and Bearings	6g, 47, 47b, 47c	The diameter size difference between the Bearing Ring (Pos. 47a) and the Bearing (Pos. 47-47c) fixed inside the intermediate chambers should be no greater than 0.4 mm.	
Impellers	49 (a, d, e & i)	Should be free from physical markings except for the guide vane welds. Any additional indentations may result from:  (1) Cavitation - the implosion of vapor "bubbles" within the impeller stack. Make sure the Net Positive Suction Head Available for the pump meets the minimum Net Positive Suction Head Required for the pump when running at the required flow.  (2) Improper coupling height - If the coupling is not set to the proper height (see step 54 & 57 of the Reassembly procedures) the impellers are not suspended as they should be, but instead they rub against the chambers, either above or below, causing contact wear.  (3) Worn groove to Impeller Wear Ring (Pos. 49c) from system sediments. Wear rings should be replaced, or impeller complete if threaded area for split cone nut is damaged.	
Shaft	51	Should show no signs of gouging or wear throughout its total length. Use emery tool to remove shaft seal set screw marks.	
Stack Compression Spacer	60	Should always be replaced.	
Shaft Seal Cartridge Complete	105 (a, b & c)	Should seal without leakage	

Refer to the Parts List and Kits section for a list of material numbers and spare part kits.

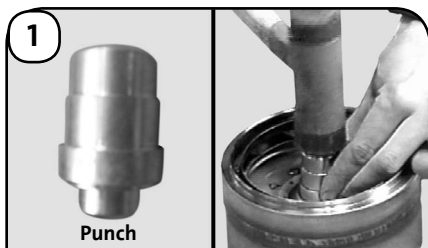

**Punch**

To reinstall the Chamber Bearing Ring (Pos. 47), or Bearing Sleeve (Pos. 47c), and Bearing Lock Ring (Pos. 47d or 47e), place the chamber in a downward position. Depending on the type of Chamber used (Pos. 3, 4a, or 4), place the appropriate components (Pos. 47 or 47c) and (Pos. 47d or 47e) onto the chamber. Position the reduced diameter end of the punch through the components. Use a rubber mallet to drive in place.



**2**

To reinstall the Neck Ring (Pos. 45), the Neck Ring Retainer (Pos. 65), or complete Neck Ring Assembly (Pos. 45a), place these components into the Chamber (Pos. 4 or 4a) or Base Interface (Pos. 44). Position the appropriate neck ring punch

- CR, CRN 32 00SV0025
- CR, CRN 45 00SV0027
- CR, CRN 64 00SV0028
- CR, CRN 90 00SV0029

onto the components to be inserted into the chamber or base interface. Using a rubber mallet, drive these components firmly in place.



Before reusing the Shaft (Pos. 51), use an emery tool to smooth away shaft seal set screw marks and make sure the main shaft area is not worn. If the Journal Bearing (Pos. 47b) was removed, replace the journal bearing. Add the Clamping Washer (Pos. 66), and two Locking Washers (Pos. 66b). Loosely thread the 6mm Allen Screw (Pos. 67) onto the shaft. To ensure journal bearing and clamp washer alignment, slide the Bottom Bearing (Pos. 6g) over these items. Place the holding pin through the shaft to prevent it from spinning while the allen screw is tightened to a torque of 23 ft.-lbs./31Nm. Remove the hold pin and the bottom bearing 6g after torque value is achieved.



**4**

Fit the shaft into the assembly/disassembly fixture (00SV0003). Make sure the holding pin is inserted into the assembly hole. Refer to the diagrams on pages 22-26 for the appropriate staging sequence.



**5**

Fit the Base Interface Assembly (Pos. 44 or 44a) onto the assembly/disassembly fixture. Be sure to use the appropriate spacing plate that fits snugly to the bottom of the base interface. Using the incorrect spacing plate can lead to rotation and end play\* problems.

\* End play is shaft travel (up and down) through the chambers.

**6**

After pressing on a new Wear Ring (Pos. 49c), or if using a new Impeller (Pos. 49d, e, or i), place the complete impeller over the shaft and seat into the interface assembly. Slide the Split Cone (Pos. 49b) down the shaft and into the recessed area of the impeller hub. Use the split cone nut tool (00SV0004) in the inverted direction and firmly drive split cone into the impeller. While performing this function, care must be taken to avoid damaging the threaded hub area of the impeller.



**7**

Place Gardolube (00SV9995) or equivalent FDA approved non-toxic lubricant on the threaded area of the hub. Thread the Split Cone Nut (Pos. 48) onto the impeller. Using the split cone nut tool (00SV0004), Adapter (00SV0403), and Torque Wrench (00SV0269), torque the split cone nut to 52 ft.-lbs./70 Nm.

8

Refer to the diagrams on pages 22-26 for the appropriate staging sequence for your particular model pump. Once the last chamber has been installed, continue with step 9.

9



Hook the Chamber Straps (Pos. 26a) through the Base Interface (Pos. 44). Position top end of straps into relieved area of the Top Chamber (Pos. 3). Place the Washer (Pos. 26c) and Allen Screws (Pos. 26b) loosely threaded into the straps. Allen screws must be pre-lubricated with Gardolube. Torque evenly to 11 ft.-lbs./15 Nm.

10

Remove the holding pin from the assembly/dismantling fixture. Lift the STACK® (Pos. 80) out of the fixture. Lay the stack on a flat surface and check the rotation and end play\*. Movement should be free and without binding.

\* End play is shaft travel (up and down) through the chambers.

11

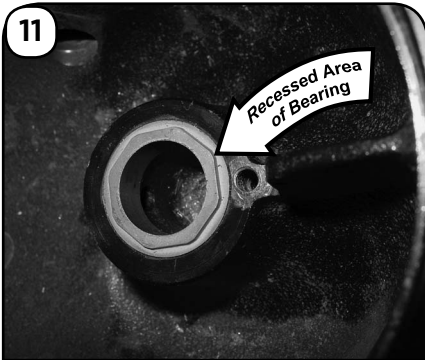

To install the Bottom Bearing (Pos. 6g) into the Suction/Discharge Base (Pos. 6), place the bearing into the hole provided in the base. Ensure the recessed area of the bearing is located where the hole for the allen screw is machined in the base.

12

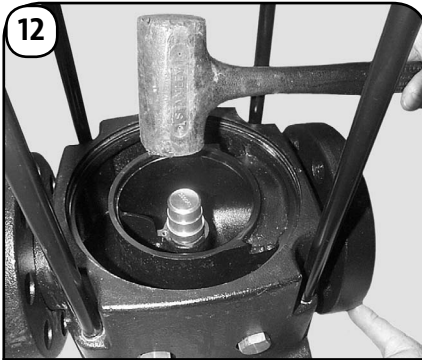

Use the bearing punch (00SV0015 or 00SV0212) and a rubber mallet to drive the bearing into place.

13

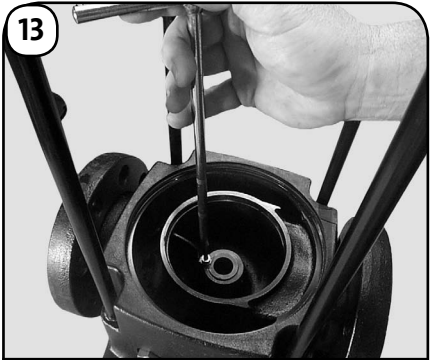

Place the Washer (Pos. 32) and the 5 mm Allen Screw (Pos. 31) into the suction/discharge base. Torque the screw to 6ft.-lbs./8Nm.

14



Place the Sleeve O-ring of EPDM or FKM (Pos. 37) into the recessed groove in the Pump Head (Pos. 2, 2b, & 2c) and the suction/discharge base for standard units. Specialty O-rings in FXM or FFKM (Pos. 37a) are used in the lower hot section of the pump in Cool Top equipped pumps. Lubricate the O-rings with Rocol (00RM2924) or Dow Corning 111. Never use oil or grease as this will attack the O-rings.

15



Place the STACK® into the suction/discharge base. Rotate the straps so they center between the Staybolts (Pos. 26) or line up with the suction and discharge ports of the base. Recheck the shaft end play (shaft travel up and down) and the shaft rotation. Movement should be free without binding. If binding occurs stop, remove the stack and check clearance between the bottom shaft bearing, bearing clamping washer and the bearing in the base.

16



Place Sleeve (Pos. 55) into the suction/discharge base. Press sleeve firmly into the base.



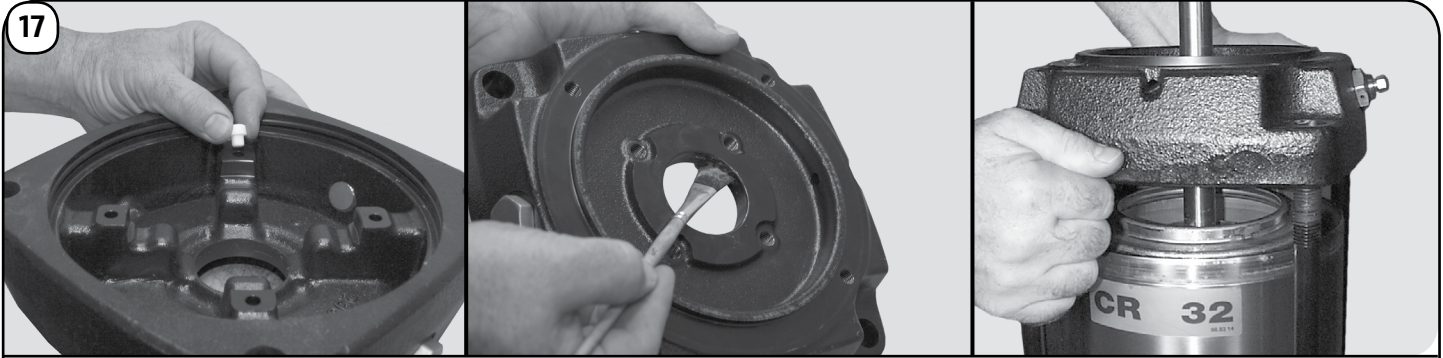

17 Replace the four PTFE Stack Compression Spacers (Pos. 60) in the pump head which will seat against the stack. Lubricate the inner bore of the pump head or all pump heads for Cool Top or Back-to-Back seal equipped pumps. For all models except Back-to-Back units: Lower the pump head over the Staybolts (Pos. 26). Use a rubber mallet to firmly seat the pump head in place. Make sure the Priming Vent Plug (Pos. 18) is inline/over the discharge port of the suction/discharge base.

For Standard and Tandem equipped seal pumps, skip to reassembly step 46.  
 For Cool Top units, continue with Reassembly steps 18 to 25.  
 For Back-to-Back units, skip to Reassembly steps 26 to 46 .

Cool-Top®

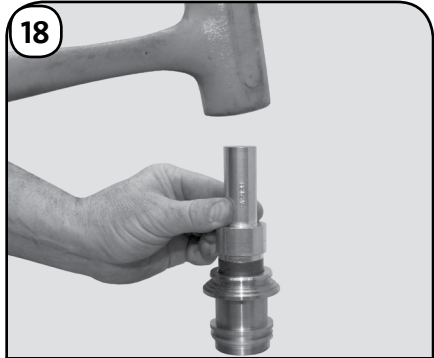

18

Use 00SV2128 and a rubber mallet to drive in three new Bushings (Pos. 47g) and the Retainer Ring (Pos. 47h) into the Connecting Pipe (Pos. 149).

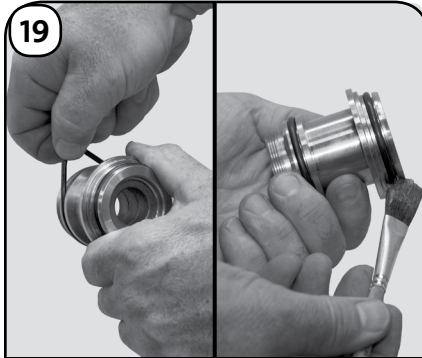

19

Replace the O-rings (Pos. 109a & 109b). Do not roll the O-ring into place; stretch and release them into the grooves. Then lubricate the O-rings with Rocol or Dow Corning 111.

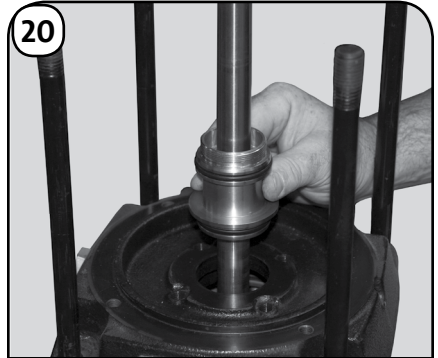

20

Slide the completed connecting pipe assembly down over the shaft and firmly seat it into the lowermost Pump Head (Pos. 2).



21

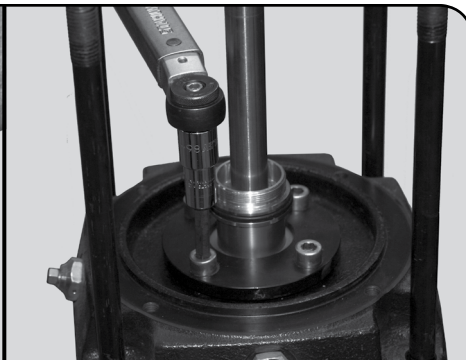

Lower and seat the Retainer (Pos. 58c) for the connecting pipe. Lubricate the threads of the 8 mm hex socket Retaining Screws (Pos. 58d) with Gardolube (00SV9995) or Thread-Eze (96611372). Install and diagonally torque the screws to 46ft.-lbs./62Nm.



22

Place the Spacing Ring (Pos. 116) onto the pump head.

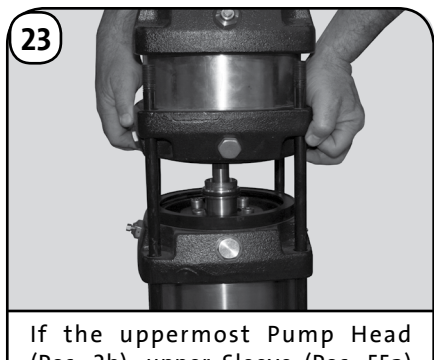

23

If the uppermost Pump Head (Pos. 2b), upper Sleeve (Pos. 55a) and middle Pump Head (Pos. 2c) did not leak and were removed as a complete assembly, then lower it back in place as a complete assembly and skip to reassembly step 46. If the assembly leaked and was fully dismantled, continue with step 24.

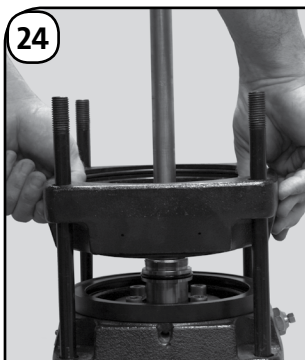

24

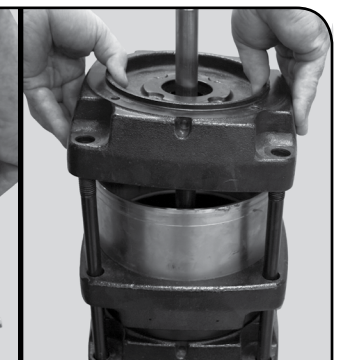
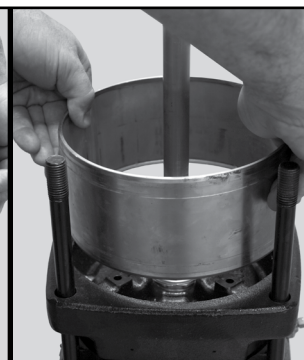

O-rings of EPDM or FKM should have already been installed into the pump heads as noted in Reassembly, step 14. If they were not, install them now. Then, lower the middle pump head and carefully press it over the connecting pipe O-ring and seat it on the spacing ring. Install the upper sleeve, and firmly press it in place. Put the uppermost pump head in place, making sure it is firmly seated. Skip to reassembly step 46.

### Back-to-Back Seal

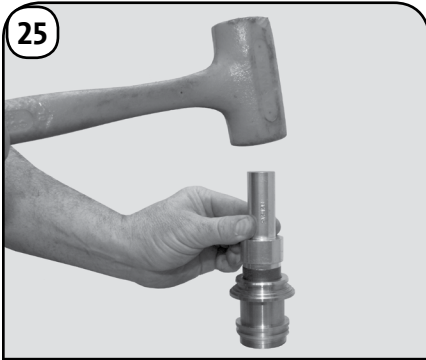

25 Use 00SV2128 and a rubber mallet to drive in three new Bushings (Pos. 47g) and the Retainer Ring (Pos. 47h) into the Connecting Pipe (Pos. 149).

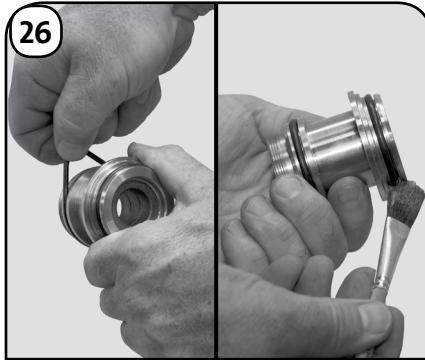

26 Replace the O-rings (Pos. 109a & 109b). Do not roll the O-ring into place; stretch and release them into the grooves. Then lubricate the O-rings with Rocol or Dow Corning 111. Once loose, lift the sleeve off.

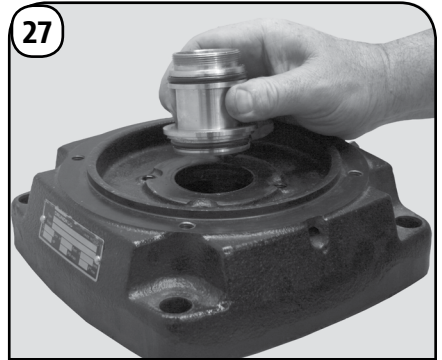

27 Place the complete connecting pipe assembly into the lowermost Pump Head (Pos. 2), making sure it is fully seated.

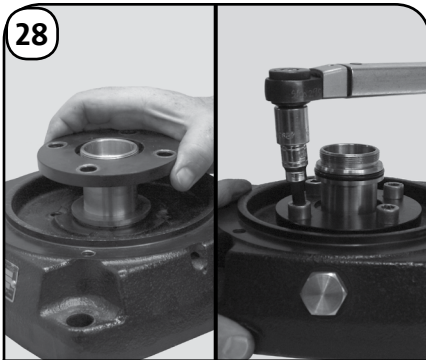

28 Lower the Retainer (Pos. 58c) over the connecting pipe. Lubricate the threads of the 8mm hex socket Retaining Screws (Pos. 58d) with Gardolube (00SV9995) or Thread-Eze (96611372). Install and diagonally torque to 46ft.-lbs./62Nm.

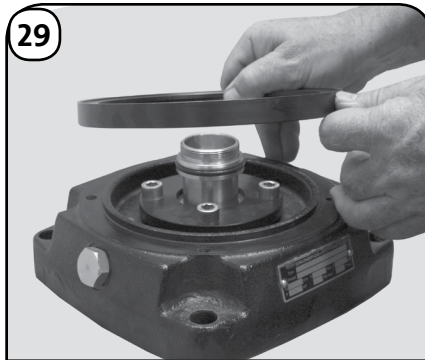

29 Place the Spacing Ring (Pos. 116) onto the pump head.

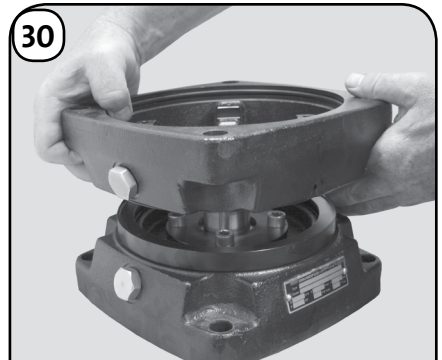

30 Lower the middle Pump Head (Pos. 2c) over and past the connecting pipe threads and upper O-ring. The pump head should rest on top of the spacing ring.

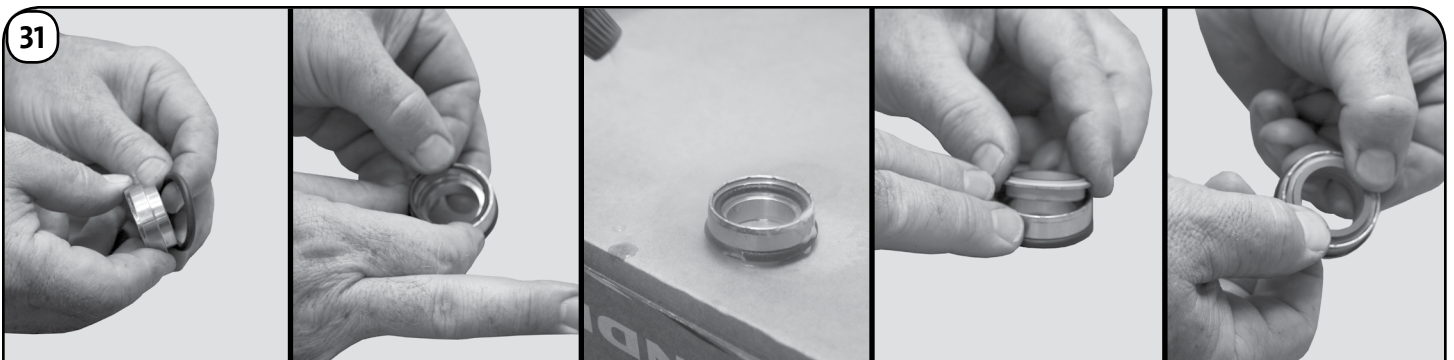

31 Assemble the stationary seal by placing the O-ring (Pos. 102) over the Retainer (Pos. 103a). Place the O-ring (Pos. 102a) into the retainer recess. Lubricate/spray a 5% solution of soapy water onto the O-ring resting in the retainer recess. Align edges of the Stationary Seal (Pos. 103) with the retainer and firmly press the stationary seal into O-ring. Stationary seal components can be seen in the diagram on the next page.



**Back-to-Back Seal** (continued)

**COMPONENTS OF STATIONARY SEAL**

**"N" PUMPS AND MODEL B**

Side View

Pos. 103 Upper Seal Ring

Pos. 102a O-Ring

Pos. 103a Retainer For Upper Seal Ring

Pos. 102 O-Ring

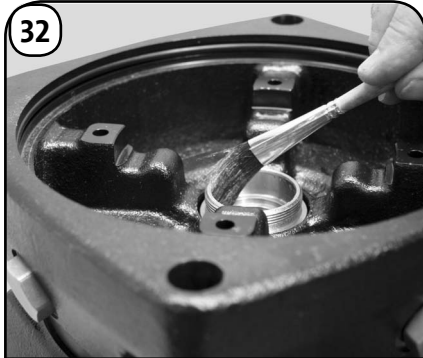

**32**

Lubricate the inner surface of the connecting pipe with Rocol, Dow Corning111, or soapy water. Lubricate the threads with Gardolube or an equivalent FDA approved non-toxic lubricant.

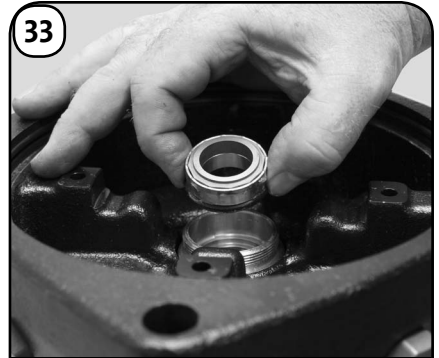

**33**

Lower and press the completed stationary seal assembly into the connecting pipe.

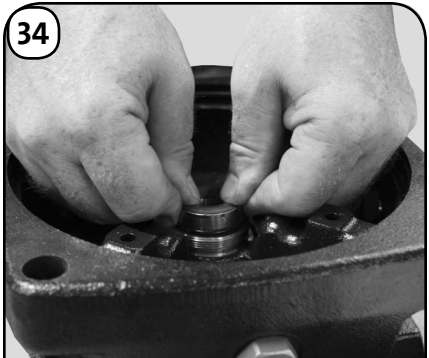

**34**

Press the stationary seal assembly into the connecting pipe. Clean the polished seal face surface with an alcohol wipe.

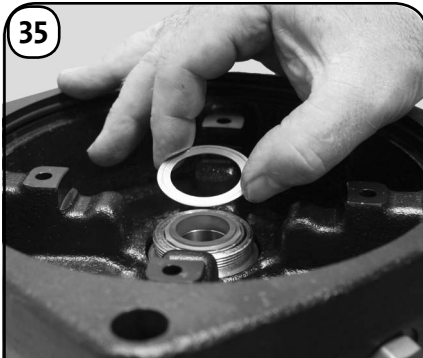

**35**

Place the Retaining Washer (Pos. 59a) onto the seal.

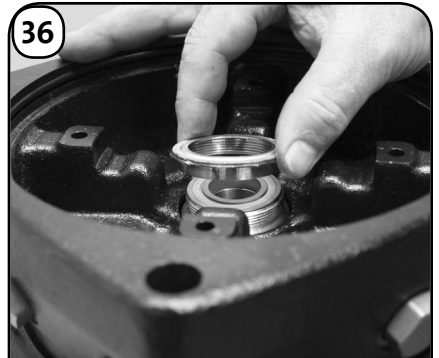

**36**

Loosely thread the Securing Nut (Pos. 148) onto the connecting pipe.



**37**

Use special tool 00SV7902 to tighten the nut.

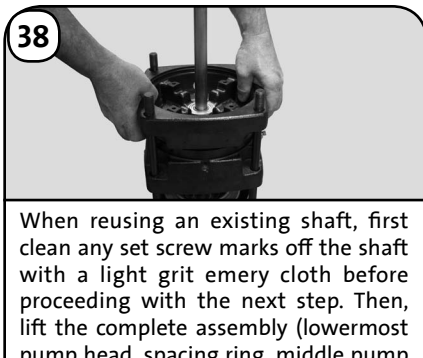

**38**

When reusing an existing shaft, first clean any set screw marks off the shaft with a light grit emery cloth before proceeding with the next step. Then, lift the complete assembly (lowermost pump head, spacing ring, middle pump head, and complete stationary seal) by the lowermost pump head. Make sure the Priming Vent Plug (Pos. 18) on the lowermost pump head is inline/over the discharge port of the suction/discharge base. Carefully lower the assembly down the shaft and staybolts. Firmly seat the assembly in place onto the sleeve.

The order of assembly for the rotating portion of the seal can be seen on the next page.

To prevent leakage, it is critical to position the rotating seal face correctly.

**Back-to-Back Seal** (continued)

**COMPONENTS OF ROTATING SEAL**

**LOWER COMPONENTS OF SEAL ASSEMBLY**

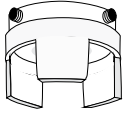

Pos. 112  
Seal Driver with set screws, Pos. 113



Pos. 108  
Spring



Pos. 106  
Cup for O-ring and Spring



Pos. 107  
O-Ring

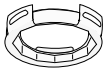

Pos. 111  
Floating Seal Driver



Pos. 104  
Rotating Seal Face  
(The tapered face should point upward through the driver 111 and press against the O-ring 107).

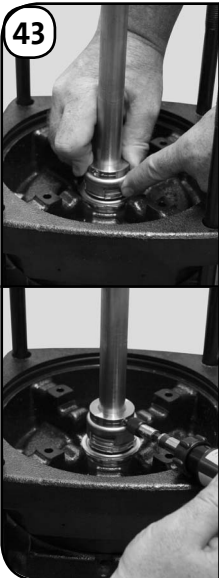

**43** Lower the Driver (Pos. 112) with set screws (Pos. 113). Driving tabs should pass and engage each other. With the shaft and the seal drivers pushed down as far as possible, tighten the 3mm Set Screws (Pos. 113) to 10ft.-lbs./13Nm.

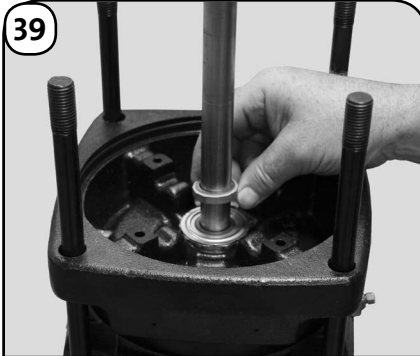

**39** With the tapered edge facing upward, lower the Rotating Seal Face (Pos. 104) down onto the stationary seal face.

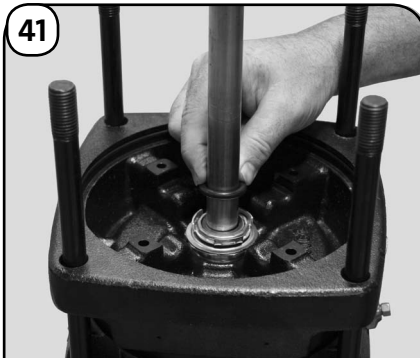

**41** Lubricate the inner surface of the O-ring (Pos. 107) with Rocol, Dow Corning 111, or soapy water. Slide the O-ring down the shaft until it contacts both the driver and the protruding surface of rotating seal face.



**44** Lower and seat the upper Sleeve (Pos. 55a) into the middle pump head.

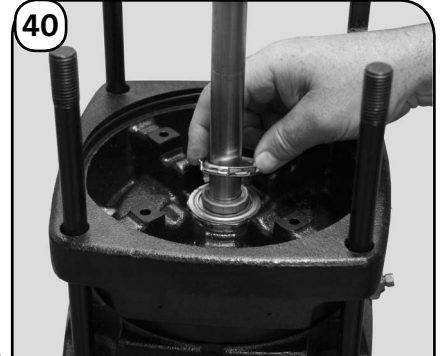

**40** Lower the Floating Seal Driver (Pos. 111) until it fully engages the rotating seal face. Ensure the taper of the rotating seal protrudes through driver.

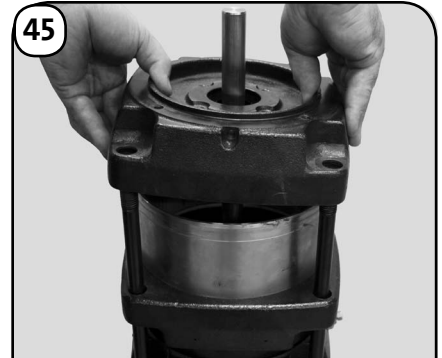
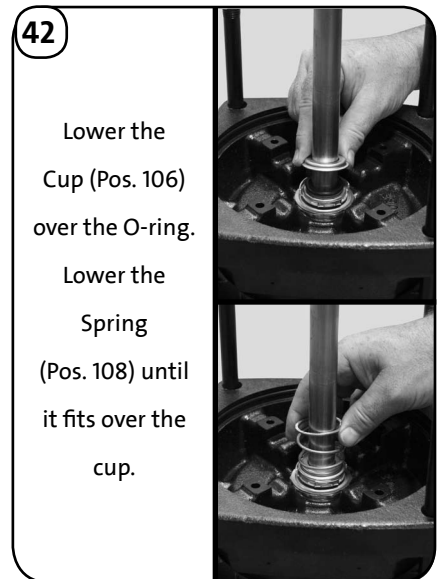

**42** Lower the Cup (Pos. 106) over the O-ring. Lower the Spring (Pos. 108) until it fits over the cup.

**45** Lower and firmly seat the uppermost Pump Head (Pos. 2b) onto the upper sleeve. Proceed to step 46.



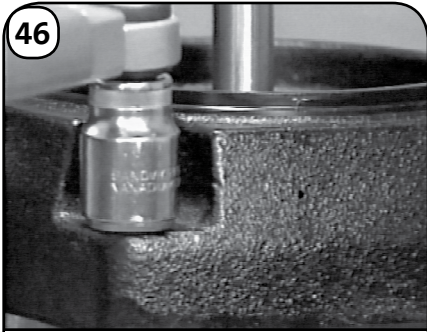

46

Slide the Washers (Pos.66a) over the Staybolts (Pos. 26). Lubricate the threads of the staybolts with Gardolube (00SV9995) or Thread-Eze (96611372). Thread the Staybolt Nuts (Pos. 36) onto the staybolts. Diagonally torque the staybolt nuts to 74ft.-lbs./100Nm.

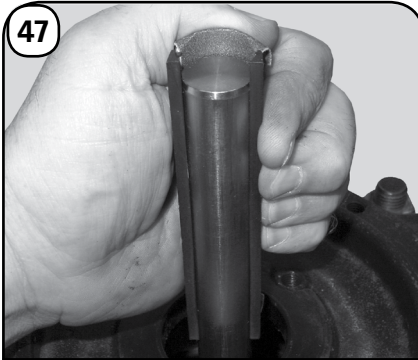

47

When reusing an existing shaft, and if the shaft has not already been cleaned, first clean away any set screw marks off of the shaft with a light grit emery cloth before proceeding with the next step.

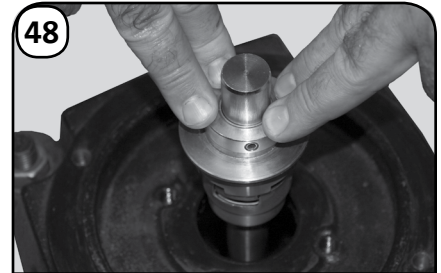

48

Lubricate the inner surface of the lower O-ring of the Shaft Seal (Pos.105) with Rocol, Dow Corning 111, or soapy water. Slide the seal down the shaft by pushing against the the drive collar of the seal. Seat the seal firmly in place. For Tandem Seal equipped pumps only, continue with step 49. All other pump types: Standard, Cool Top, and Back-to- Back units, skip to step 55.

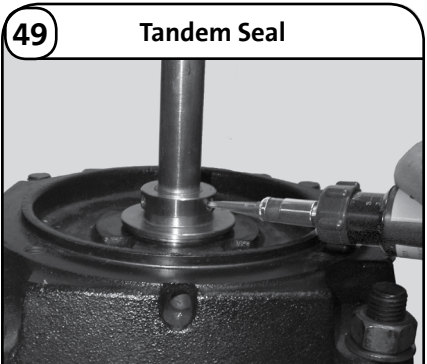

49

**Tandem Seal**

Evenly tighten and then torque the three 3 mm set screws to 6 ft.-lbs./8Nm.

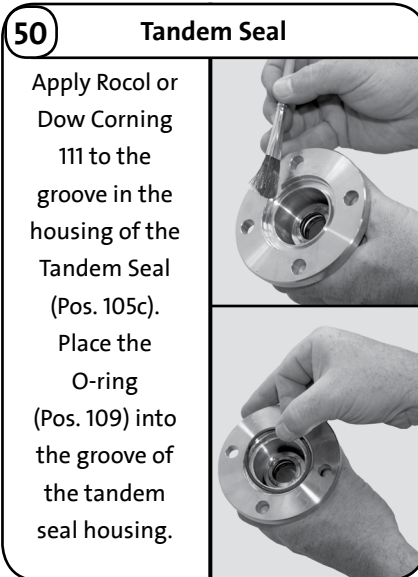

50

**Tandem Seal**

Apply Rocol or Dow Corning 111 to the groove in the housing of the Tandem Seal (Pos. 105c). Place the O-ring (Pos. 109) into the groove of the tandem seal housing.

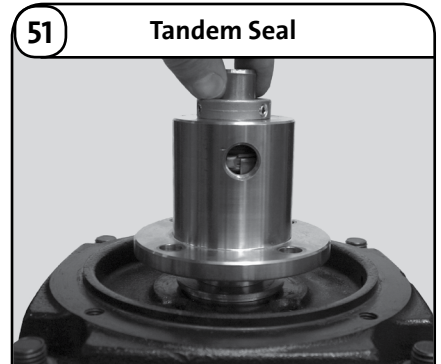

51

**Tandem Seal**

Pushing against the drive collar, slide the tandem seal assembly down the shaft until it stops against the lower shaft seal.

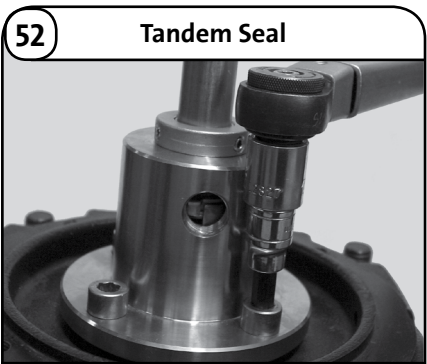

52

**Tandem Seal**

Lubricate the threads of the 8 mm hex socket Retaining Screws (Pos. 58d) with Gardolube or Thread-Eze. Install and diagonally torque to 46ft.-lbs./62Nm.

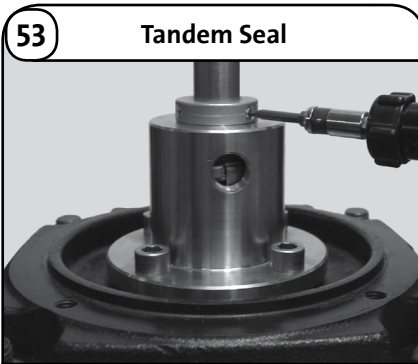

53

**Tandem Seal**

Evenly tighten and then torque the three 3 mm set screws to 6 ft.-lbs./8Nm.

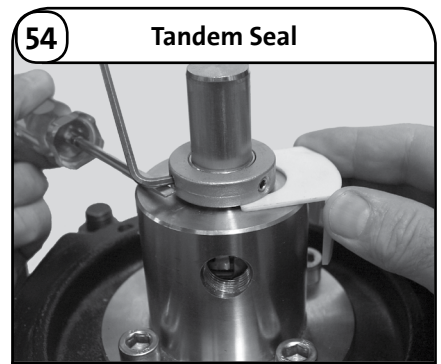

54

**Tandem Seal**

Lift the shaft upward and place the Adjust Fork/Spacing Tool, 985924, between the housing and seal driver ring.

**Tandem Seal continues with step 58.**

Standard, Cool Top®, & Back-to-Back Seal Units

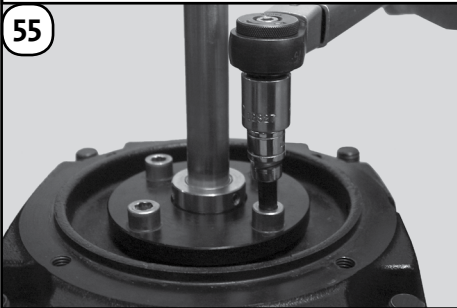

**55**  
Lower and seat the Retainer (Pos. 58). Lubricate the threads of the 8 mm hex socket Retaining Screws (Pos. 58a) with Gardolube or Thread-Eze. Install and diagonally torque the screws to 46ft.-lbs./62Nm.

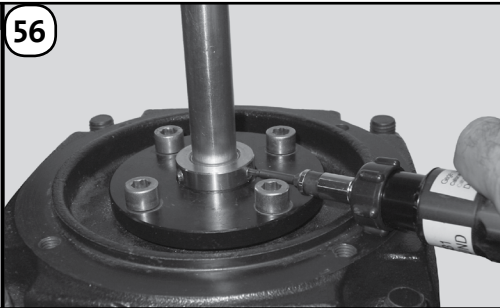

**56**  
Push the shaft downward (for Back-to-Back units, continue downward pressure as the inboard seal spring tension may lift the shaft). Evenly tighten, then torque the three 3 mm set screws to 6 ft.-lbs./8Nm.

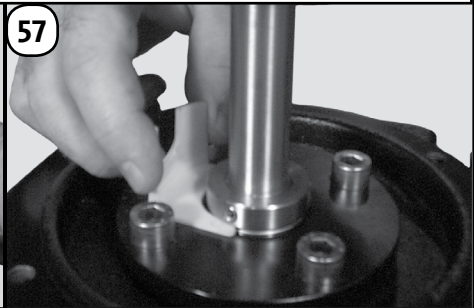

**57**  
Lift the shaft and insert the adjusting fork under the seal collar.

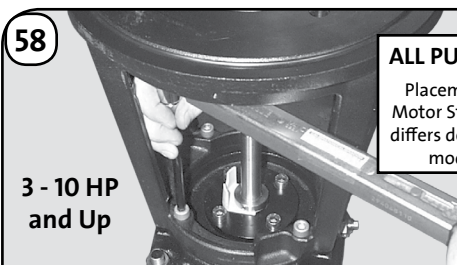

**58**  
**3 - 10 HP and Up**  
Attach the motor and motor stool separately to the pump head. Lubricate the threads on the 8 mm hex socket Retaining Screws (Pos. 28) with Gardolube or Thread-Eze. Install and diagonally torque to 46ft.-lbs./62Nm. Place the motor onto the motor stool, lubricate the threads of the Motor Bolts (Pos. 28a) and tighten the bolts diagonally to 30 ft.-lbs./41Nm.



**ALL PUMP TYPES**  
Placement of the Motor Stool (Pos. 1a) differs depending on model size.  
**15 HP and up**  
The motor, motor stool, and/or bearing flange will be assembled as a complete unit. Place the entire assembly onto the pump head. Lubricate the threads on the 8 mm hex socket Retaining Screws (Pos. 28) with Gardolube or Thread-Eze. Install and diagonally torque to 46ft.-lbs./62Nm. If the motor was removed during disassembly, reattach the motor. Lubricate the threads of the Motor Bolts (Pos. 28a) and then tighten the bolts diagonally to:

30 ft.- lbs./41 Nm for 1/2" x 13 UNC, 3-40 HP  
59 ft.- lbs./80 Nm for 5/8" x 11 UNC, 50-60 HP



**59 Tandem Seal Only**  
Place a second adjusting fork on top of the seal collar. Install the Coupling Halves (Pos. 10a). Lubricate the threads on the 8 mm hex socket Coupling Screws (Pos. 9) with Gardolube or Thread-Eze. Loosely thread the screws in place.



**60 Standard, Cool Top®, & Back-to-Back Seal Units**  
To install the Coupling Halves (Pos. 10a), position the coupling half relief area flushed with the top of the shaft as shown in the diagram. Lubricate the threads on the 8 mm hex socket Coupling Screws (Pos. 9) with Gardolube or Thread-Eze. Loosely thread the screws in place.

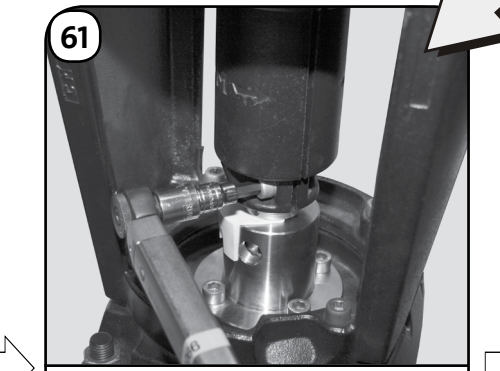

**61**  
Torque the 8 mm hex socket coupling screws to 63 ft.-lbs./85Nm. This step is the same for all pump types (in the photo a tandem seal version is shown).

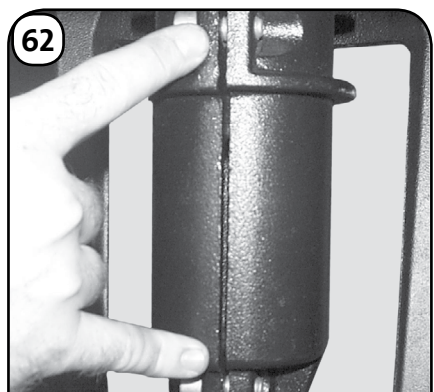



**62**  
Make sure the gaps on both sides of the coupling are even. **Applies to all pump types.**

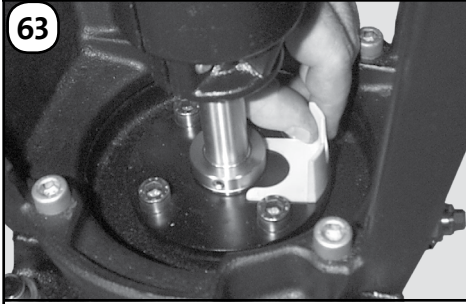
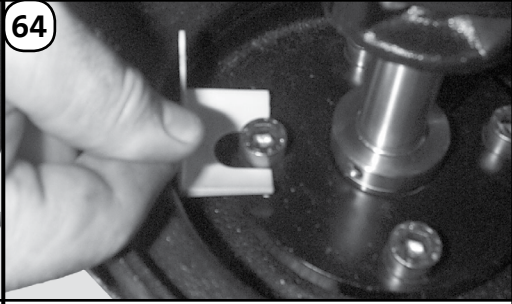
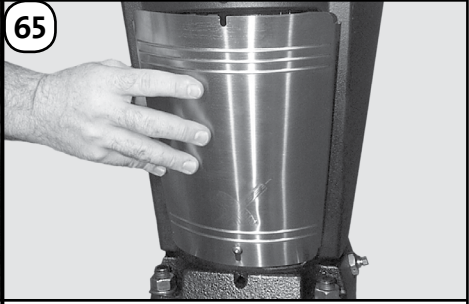

Standard, Cool Top®, & Back-to-Back Seal Units

		
<p>Remove the adjusting fork.</p>	<p>For storage, place the adjusting fork around one of the seal holder allen screws. Check rotation by turning the coupling by hand. If the shaft is tight or will not rotate, disassemble and begin the assembly procedure again.</p>	<p>Fit Coupling Guard (Pos. 7) over screws (Pos. 7a). Torque to 6 ft.-lbs./8Nm.</p>

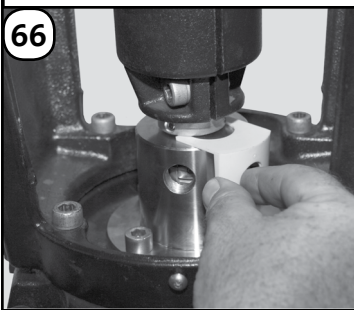
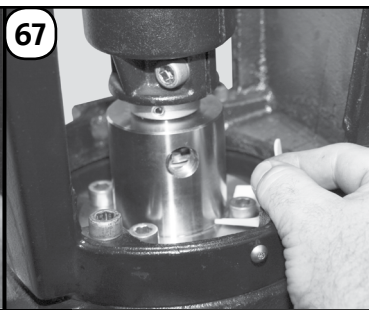
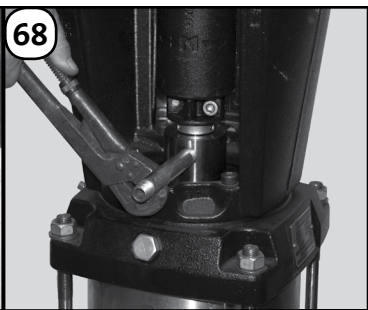
Tandem Seal

			
<p>Remove the adjusting forks</p>	<p>For storage, place the adjusting forks around two of the seal retaining screws. Check rotation by turning the coupling by hand. If the shaft is tight or will not rotate, disassemble and begin the assembly procedure again.</p>	<p>Install system piping to the tandem seal housing.</p>	<p>Fit the coupling guard and screws. Torque screws to 6 ft.-lbs./8Nm.</p>

———— THE PUMP IS ————  
**NOW COMPLETELY  
 REASSEMBLED.**

Return the pump to the system and install it following the Installation and Operation instructions. If the unit was not removed from the system, open the isolation valves in the system piping to fully vent the pump. Confirm proper electrical connections before restoring power supply.

# CR, CRN 32 Order of Stage Assembly

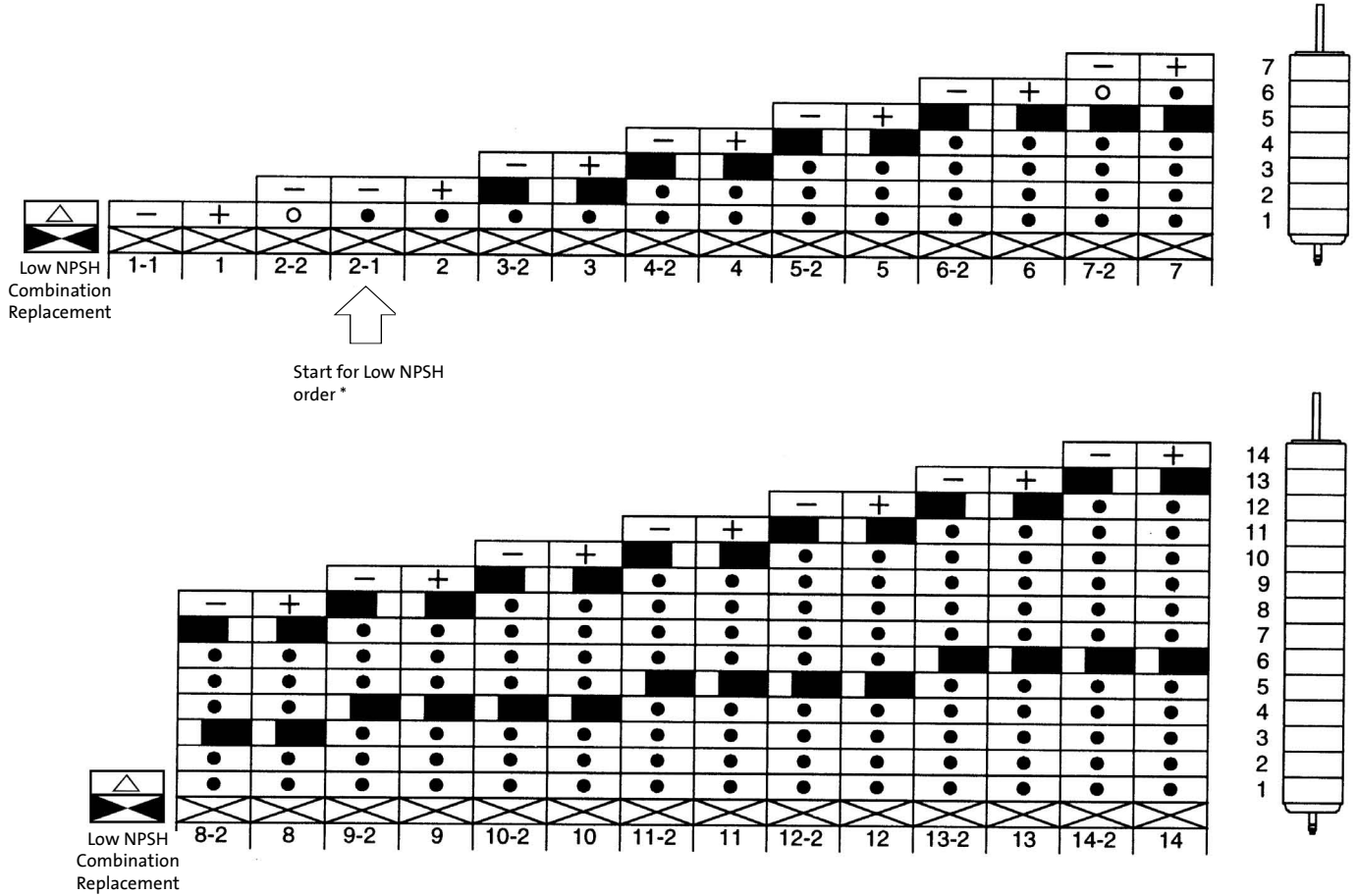

## Legend

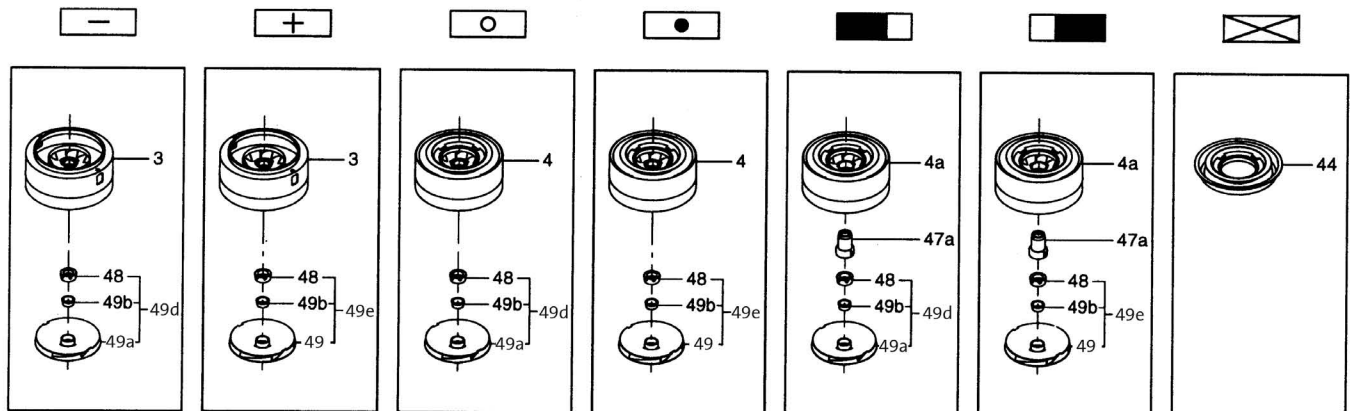

\*Low NPSH units start with 2-1 and continue to the 14 stage.

**NOTE:** Refer to Parts List for ALL position descriptions.

For Low NPSH, replace the first 49e with 49i

For Low NPSH, replace 44 with 44a

# CR, CRN 45

## Order of Stage Assembly

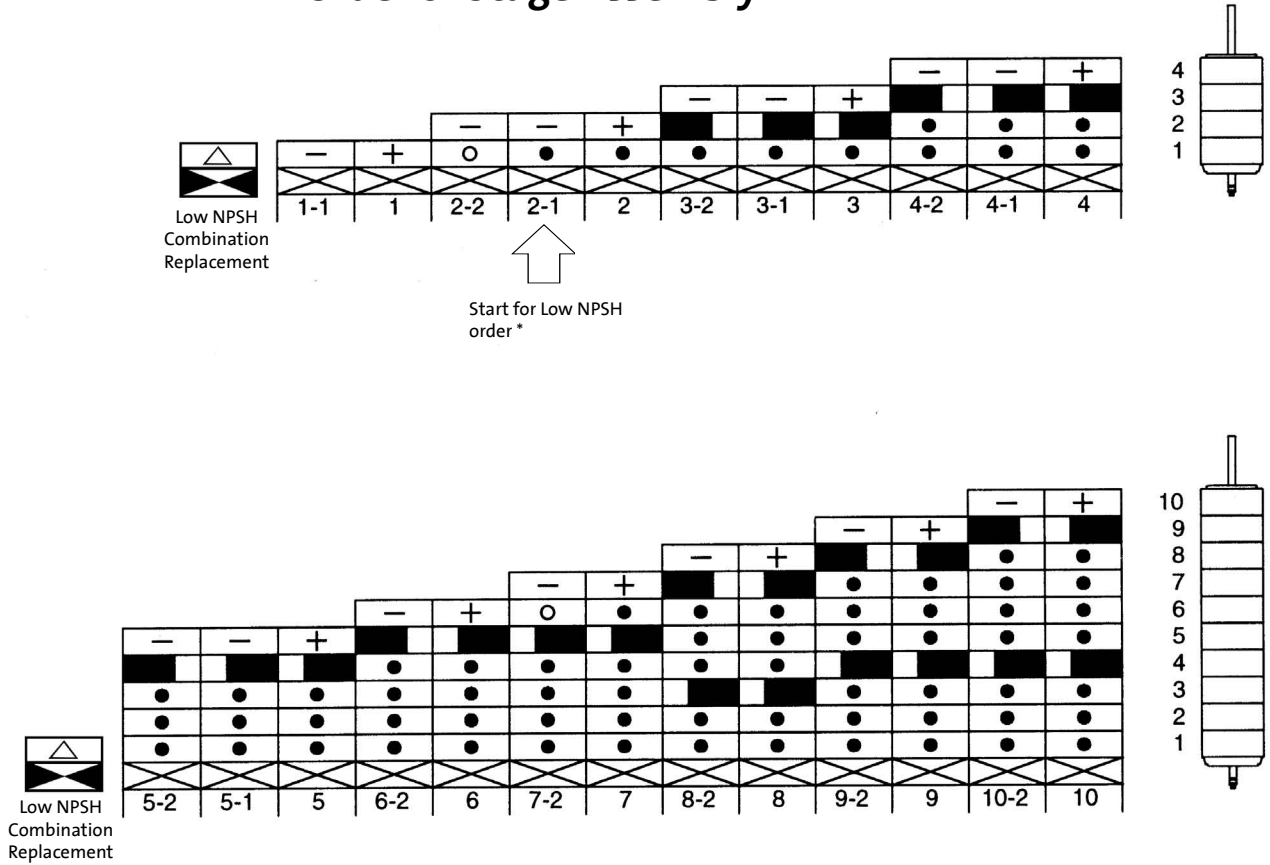

### Legend

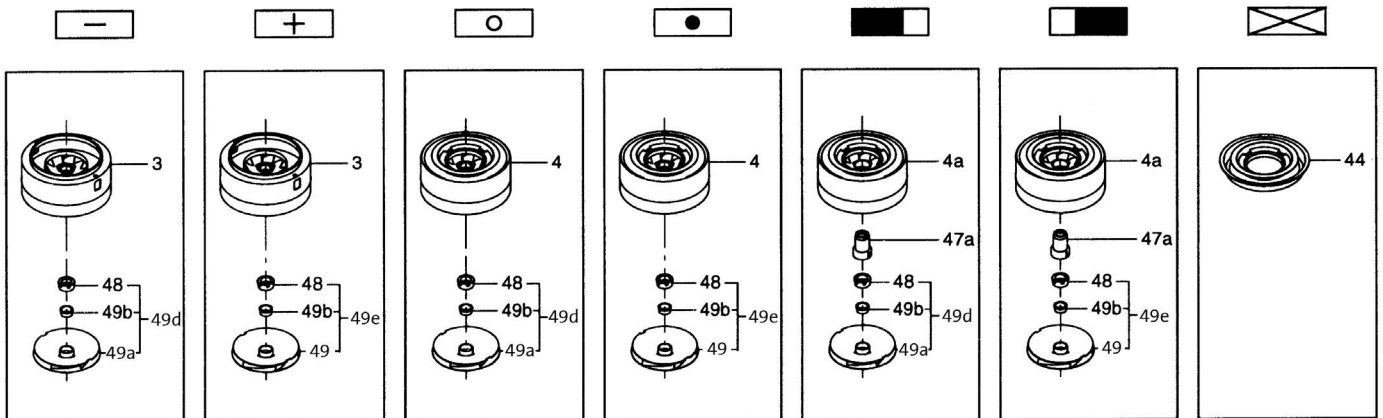

\*Low NPSH units start with 2-1 and continue to the 10 stage.

**NOTE:** Refer to Parts List for ALL position descriptions.

For Low NPSH, replace the first 49e with 49i



For Low NPSH, replace 44 with 44a





# CR, CRN 64

## Order of Stage Assembly

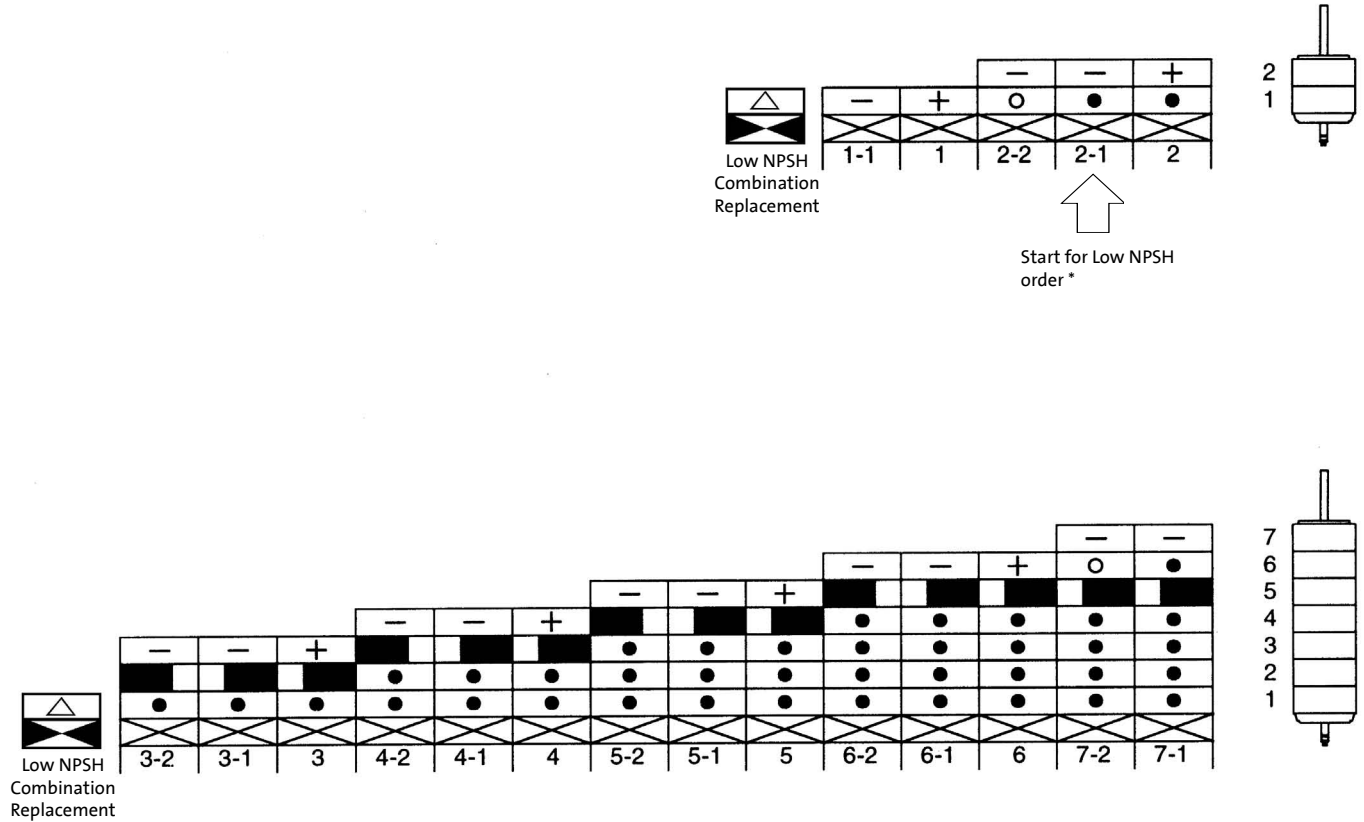

### Legend

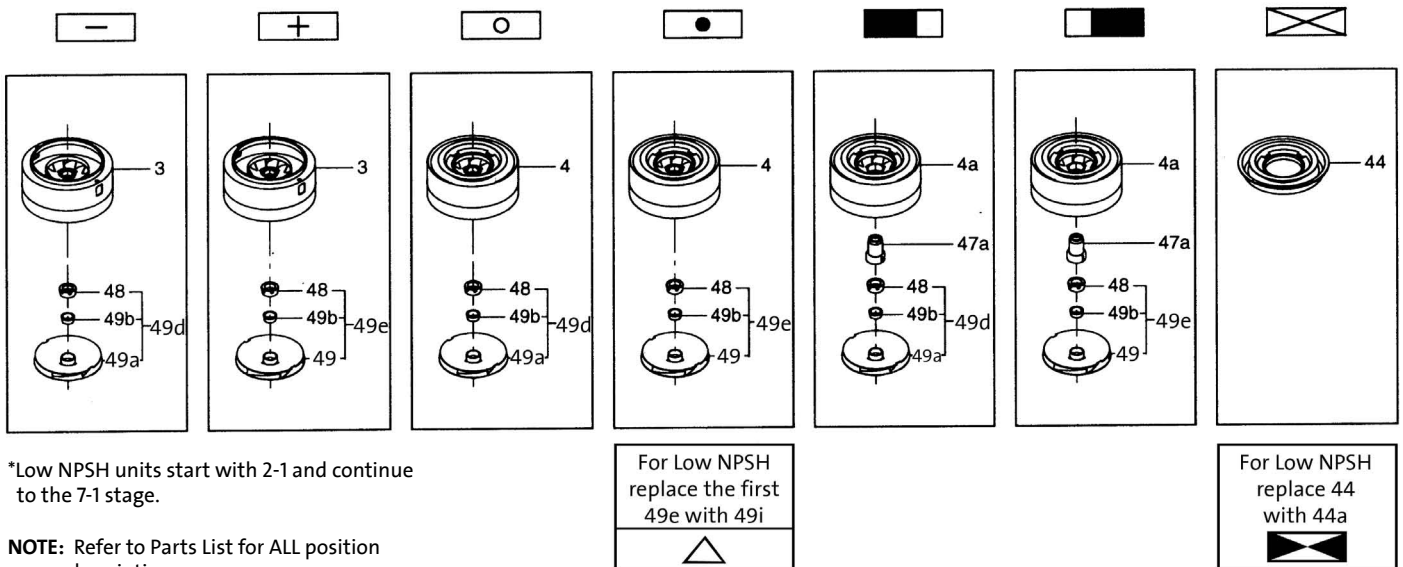

# CR, CRN 90

## Order of Stage Assembly

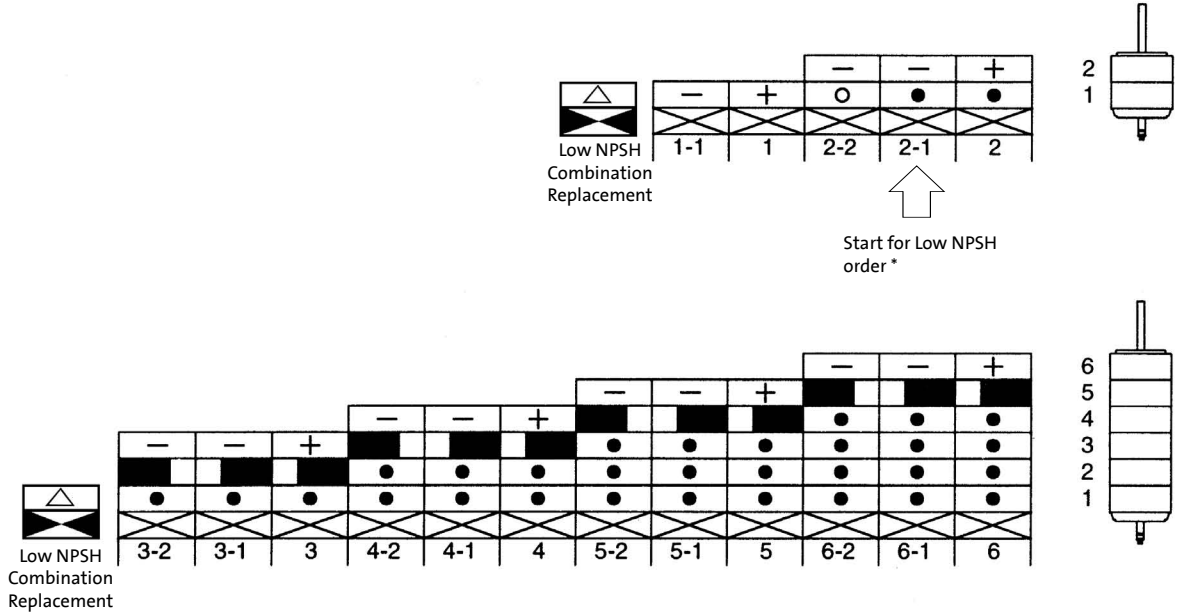

### Legend

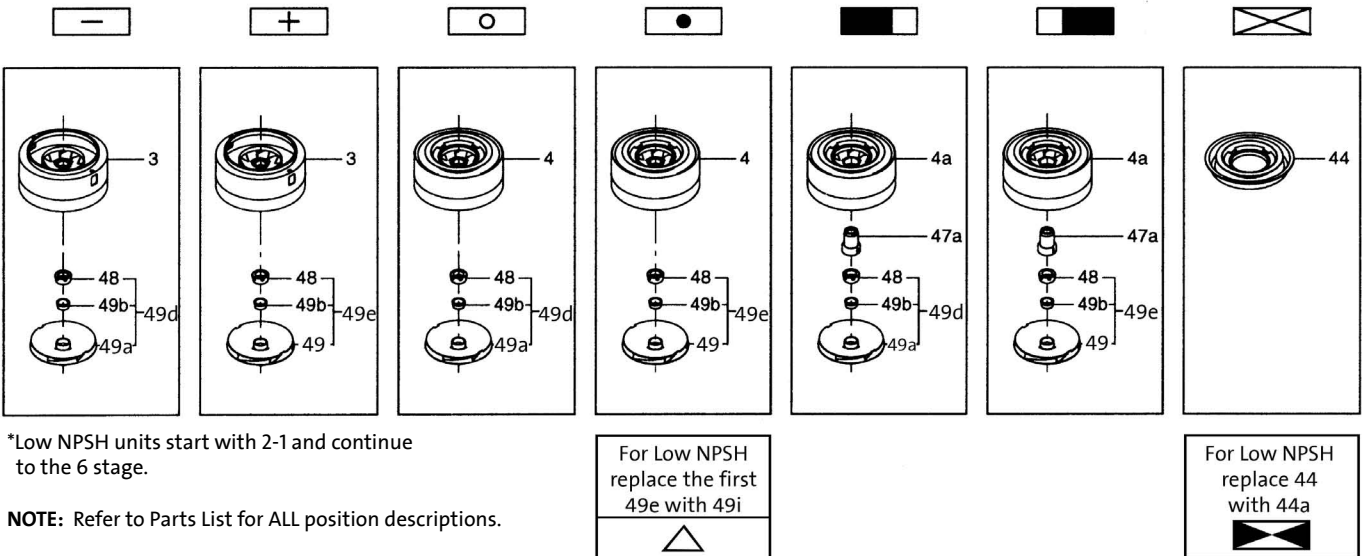

\*Low NPSH units start with 2-1 and continue to the 6 stage.

**NOTE:** Refer to Parts List for ALL position descriptions.

For Low NPSH  
replace the first  
49e with 49i

For Low NPSH  
replace 44  
with 44a

L-CR-SM-010 0410

The name Grundfos, the Grundfos logo, and be think innovate are registered trademarks owned by Grundfos Holding A/S, Denmark. All rights reserved worldwide. © Copyright Grundfos Holding A/S

**GRUNDFOS Pumps Corporation**  
17100 W. 118th Terrace  
Olathe, Kansas 66062  
Phone: 913.227.3400  
Fax: 913.227.3500  
www.grundfos.us

**GRUNDFOS Canada, Inc.**  
2941 Brighton Road  
Oakville, Ontario L6H 6C9 Canada  
Phone: 905.829.9533  
Fax: 905.829.9512

**Bombas GRUNDFOS de Mexico S.A. de C.V.**  
Boulevard TLC No. 15  
Parque Industrial Stiva Aeropuerto  
Apodaca, N.L. Mexico 66600  
Phone: 52.81.8144.4000  
Fax: 52.81.8144.4010

**GRUNDFOS**