

CRE, CRIE, CRNE, CRKE, SPKE, MTRE

E-pumps with MLE Model K frequency-controlled permanent-magnet motor

North America

Installation and operating instructions



CRE, CRIE, CRNE, CRKE, SPKE,
MTRE
Installation and operating instructions
Other languages
<http://net.grundfos.com/qr/i/92898117>

CRE, CRIE, CRNE, CRKE, SPKE, MTRE

English (US)

Installation and operating instructions	4
Limited consumer warranty	74
Appendix A.....	76
Appendix B.....	77
Supplier's Declaration of Conformity.....	80

English (US) Installation and operating instructions

Original installation and operating instructions

Table of contents

1. General information	5	9.10 Built-in Grundfos sensor	43
1.1 Related instructions	5	9.11 Pt100/1000 inputs	43
1.2 Hazard statements	5	9.12 Digital inputs	44
1.3 Notes	5	9.13 Digital inputs/outputs	45
1.4 Abbreviations and definitions	6	9.14 Signal relay (Relay outputs)	46
2. Product introduction	6	9.15 Analog output	46
2.1 Product description	6	9.16 Controller (Controller settings)	47
2.2 Intended use of the product	6	9.17 Operating range	48
2.3 Radio communication	6	9.18 External setpoint function	48
2.4 Identification	7	9.19 Predefined setpoints	49
2.5 Radio module	7	9.20 Temperature influence	50
2.6 Bluetooth	7	9.21 Limit-exceeded function	50
2.7 Battery	8	9.22 LiqTec (LiqTec function)	51
2.8 Safe Torque Off (STO) function	8	9.23 Stop function (Low-flow stop function)	51
3. Receiving the product	8	9.24 Stop at min. speed	53
3.1 Transporting the product	8	9.25 Pipe filling function	53
3.2 Inspecting the product	8	9.26 Pulse flowmeter (Pulse flowmeter setup)	53
3.3 Lifting the product	8	9.27 Ramps	53
4. Installation requirements	9	9.28 Direction of rotation	54
4.1 Installing the product in areas with high humidity	9	9.29 Skip band	54
4.2 Location	9	9.30 Standstill heating	54
4.3 Minimum space	9	9.31 Alarm handling	54
5. Mechanical installation	10	9.32 Motor bearing monitoring	54
5.1 Mounting the product	10	9.33 Service intervals	54
6. Electrical connection	12	9.34 Communication	55
6.1 Connecting an external switch	12	9.35 Language	56
6.2 Power supply	12	9.36 Date and time (Set date and time)	56
6.3 Electrical supply systems	12	9.37 Unit configuration (Units)	56
6.4 Protection against electric shock, indirect contact	13	9.38 Buttons on product (Enable/disable settings)	57
6.5 Cover for the power cables	13	9.39 Delete history	57
6.6 Protection against power supply voltage transients	13	9.40 Define Home display	57
6.7 Motor protection	13	9.41 Display settings	57
6.8 Cable requirements	13	9.42 Store settings (Store actual settings)	57
6.9 Additional protection	15	9.43 Recall settings (Recall stored settings)	57
6.10 Functional modules	15	9.44 Undo	57
6.11 Signal relays	19	9.45 Pump name	57
6.12 Signal cables	21	9.46 Connection code	57
6.13 Bus connection cable	21	9.47 Run start-up guide	57
6.14 Installing a communication interface module	22	9.48 Alarm log	57
7. Starting up the product	24	9.49 Warning log	57
8. Control functions	24	9.50 Assist	57
8.1 User interfaces	24	9.51 Assisted pump setup	57
8.2 Operating panels, HMI 200 and 201	24	9.52 Setup, analog inputs	57
8.3 Operating panels, HMI 300 and 301	27	9.53 Setting of date and time	57
8.4 Grundfos GO	32	9.54 Multipump function	58
8.5 Grundfos GO Link	35	9.55 Description of control mode	60
8.6 Grundfos Eye	36	9.56 Assisted fault advice	60
9. Setting the product	38	9.57 Priority of settings	61
9.1 Setpoint	38	9.58 Factory settings for Grundfos GO	62
9.2 Operating mode	38	10. Servicing the product	63
9.3 Set manual speed	38	10.1 Maintenance	64
9.4 Set user-defined speed	38	11. Taking the product out of operation	64
9.5 Control mode	38	12. Fault finding	65
9.6 Setting the proportional pressure	41	12.1 Fault and warning signals	65
9.7 FLOWLIMIT	41	13. Technical data	67
9.8 Automatic Night Setback	41	13.1 Operating conditions	67
9.9 Analog inputs	42	13.2 Technical data, three-phase motors	68
		13.3 Inputs and outputs	69
		13.4 Other technical data	70
		13.5 Accessories	72
		13.6 Applicable standards	73

14. Disposing of the product	73
15. Document quality feedback	73

1. General information



Read this document before you install the product. Installation and operation must comply with local regulations and accepted codes of good practice.

1.1 Related instructions



These installation and operating instructions are a supplement to the installation and operating instructions for the corresponding standard pumps CR, CRI, CRN, CRK, SPK, MTR, and CM. For instructions not mentioned specifically in this manual, see the installation and operating instructions for the standard pump.

Installation and operating instructions

Title	QR code	Publication number	Link
CR, CRN 95-255 (NEMA)		99347135	http:// net.grundfos.com/ qr/i/99347135
MTR, CRK, SPK (NEMA)		L-MTR-TL-03	http:// net.grundfos.com/ qr/i/L-MTR-TL-03

1.2 Hazard statements

The symbols and hazard statements below may appear in Grundfos installation and operating instructions, safety instructions and service instructions.



DANGER

Indicates a hazardous situation which, if not avoided, will result in death or serious personal injury.



WARNING

Indicates a hazardous situation which, if not avoided, could result in death or serious personal injury.



CAUTION

Indicates a hazardous situation which, if not avoided, could result in minor or moderate personal injury.

The hazard statements are structured in the following way:



SIGNAL WORD

Description of the hazard

Consequence of ignoring the warning

- Action to avoid the hazard.

1.3 Notes

The symbols and notes below may appear in Grundfos installation and operating instructions, safety instructions and service instructions.



Observe these instructions for explosion-proof products.



A blue or gray circle with a white graphical symbol indicates that an action must be taken.



A red or gray circle with a diagonal bar, possibly with a black graphical symbol, indicates that an action must not be taken or must be stopped.



If these instructions are not observed, it may result in malfunction or damage to the equipment.



Tips and advice that make the work easier.

1.4 Abbreviations and definitions

AI	Analog input.
AL	Alarm, out of range at lower limit.
AO	Analog output.
AU	Alarm, out of range at upper limit.
CIM	Communication interface module.
Current sinking	The ability to draw current into the terminal and guide it towards earth in the internal circuitry.
Current sourcing	The ability to push current out of the terminal and into an external load which must return it to earth.
DI	Digital input.
DO	Digital output.
ELCB	Earth leakage circuit breaker.
FM	Functional module.
GDS	Grundfos Digital Sensor, factory-fitted.
GENIbus	Proprietary Grundfos fieldbus standard.
GFCI	Ground fault circuit interrupter.
GND	Protective earth.
Grundfos Eye	Status indicator light.
LIVE	Low voltage with the risk of electric shock if the terminals are touched.
OC	Open collector: Configurable open-collector output.
PE	Protective earth.
RCCB	Residual-current circuit breaker.
RCD	Residual-current device.
SELV	Safety extra-low voltage. A voltage that cannot exceed ELV under normal conditions and under single-fault conditions, including earth faults in other circuits.
STO	Safe Torque Off. A sub safety function, where a drive does not actively generate any torque and coasts freely.

2. Product introduction

2.1 Product description

Grundfos E-pumps are mounted with frequency-controlled permanent-magnet MLE motors for three-phase power supply connection. The motors incorporate a PI controller.

You can connect the motors to a signal from an external sensor and a setpoint signal enabling control in closed loop. You can also use the motors for an open-loop system in which the setpoint signal is used as a speed control signal.

The motors incorporate an operating panel which is available in various versions.

Detailed motor settings are made with Grundfos GO. Furthermore, you can read important operating parameters via Grundfos GO. The motors incorporate a functional module. The functional module is available in various versions with different inputs and outputs.

You can fit the motors with a Grundfos add-on communication interface module (CIM). The module enables data transmission between the motor and an external system, for example a BMS or SCADA system. The module communicates via fieldbus protocols. You can connect several motors together via radio or bus communication to create a multimotor system.

2.1.1 Pumps without a factory-fitted sensor

The pumps have a built-in PI controller and can be set for an external sensor enabling the control of the following parameters:

- constant pressure
- constant differential pressure
- constant temperature
- constant differential temperature
- constant flow rate
- constant level
- constant curve
- constant other value.

The pumps have been factory-set to constant-curve control mode. You can change the control mode with Grundfos GO, HMI 300, HMI 301 or Grundfos GO Link.

2.1.2 Pumps with a factory-fitted pressure sensor

The pumps have a built-in PI controller and are set for a pressure sensor enabling the control of the outlet pressure.

The pumps have been factory-set to constant-pressure control mode. The pumps are typically used to keep a constant pressure in variable-demand systems.

2.2 Intended use of the product

Only use the CR, CRN pumps according to the specifications stated in the installation and operating instructions.

Related information

[1.1 Related instructions](#)

2.3 Radio communication

This product incorporates a radio module for remote control which is a class 1 device and which you can use anywhere in the EU without restrictions.

For use in the USA and Canada, see the appendix on installation in the USA and Canada.

This product can communicate with Grundfos GO and other products of the same type via the built-in radio module.

In some cases, an external antenna may be required. Only Grundfos-approved external antennas may be connected to this product, and only by a Grundfos-approved installer.

2.4 Identification

2.4.1 Identification of the pump model

Identify the pump by the nameplate on the pump. See description of the nameplate and type key in the related installation and operating instructions.

2.4.2 Identification of the motor model

Identify the motor by means of the nameplate on the terminal box.

Model K

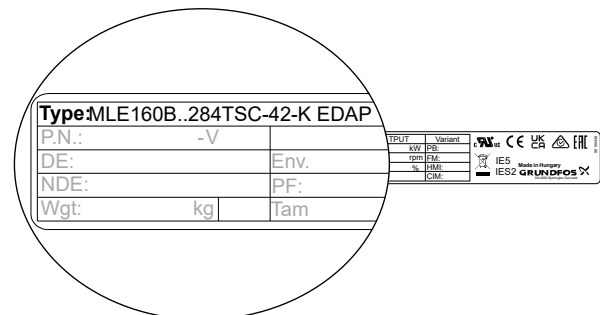

TM084775

Motor	3 × 440-480 V
[HP]	2900-4000 rpm
20	•
25	•
30	•

2.4.3 Identification of the functional module

You can identify the fitted module in one of the following ways:

Grundfos GO

You can identify the functional module in the **Fitted modules** menu under **Status**.

Motor display

For motors fitted with the HMI 300 or 301 operating panel, you can identify the functional module in the **Fitted modules** menu under **Status**.

Motor nameplate

You can identify the fitted module by means of the data on the motor nameplate.

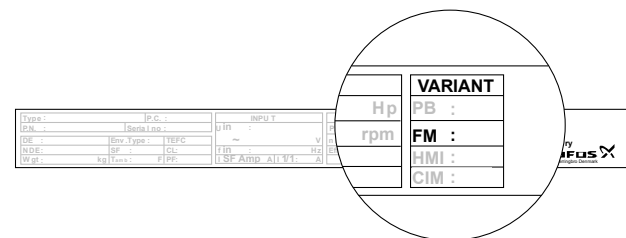

TM061889

Functional module variants:

- FM310
- FM311 ¹⁾

¹⁾ Without Bluetooth (BLE).

2.4.4 Identification of the operating panel

You can identify the operating panel in one of the following ways:

Grundfos GO

You can identify the operating panel in the **Fitted modules** menu under **Status**.

Motor display

For motors fitted with the HMI 300 or 301 operating panel, you can identify the operating panel in the **Fitted modules** menu under **Status**.

Motor nameplate

You can identify the operating panel by means of the data on the motor nameplate.

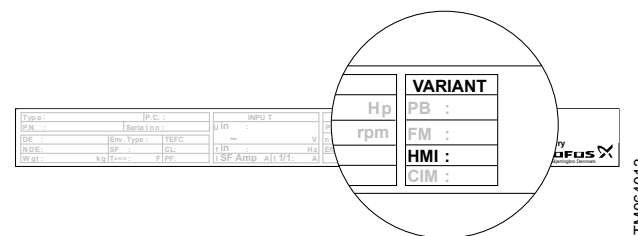

TM064013

Operating panel variants

- HMI 200
 - HMI 201 ²⁾
 - HMI 300
 - HMI 301 ²⁾
- ²⁾ For motors without a radio module.

2.5 Radio module

CAUTION

Radiation

Minor or moderate personal injury



- Locate the product at a minimum distance of 8 inches (20 cm) from any body parts. Human tissue may be heated by RF energy.



Installers and end users must be provided with these installation and operating instructions and operating conditions for satisfying RF exposure compliance.

The product incorporates a class 1 radio module for remote control. You can use the module anywhere in the EU without restrictions.

For installation in the USA and Canada, see the appendix.

Via the built-in radio module, the product can communicate with other MLE motors.



The product contains a class 1 radio. Grundfos will support the product with security updates for at least 2 years from production of the unit.

2.6 Bluetooth

The product incorporates a Bluetooth (BLE) module for remote control. You can use the module anywhere in the EU without restrictions.

For installation in the USA and Canada, see the appendix.

Via the built-in Bluetooth module, the product can communicate with Grundfos GO.



The product contains a Bluetooth (BLE) module. Grundfos will support the product with security updates for at least 2 years from production of the unit.

Bluetooth information

Frequency of operation	2400 - 2483.5 MHz
Modulation type	GFSK
Data rate	2 Mbps
Transmit power	5 dBm EIRP with internal antenna

GLoWpan information

Frequency of operation	2405-2480 MHz
Modulation type	GP O-QPSK
Data rate	1 Mbps
Transmit power	5 dBm EIRP with internal antenna

2.7 Battery

A Li-ion battery is fitted in the FM310 and FM311 functional modules.

The Li-ion battery complies with the Battery Directive (2006/66/EC). The battery does not contain mercury, lead or cadmium.

WARNING**Intoxication or risk of chemical burn**

Death or serious personal injury



- The battery can cause severe or fatal injuries in 2 hours or less if it is swallowed or placed inside any part of the body. In such an event, seek medical attention immediately.



- The replacement or servicing of batteries must be carried out by a qualified person.
- The battery contained within this product, whether new or used, is hazardous and is to be kept away from children.

2.8 Safe Torque Off (STO) function

Safe Torque Off (STO) is a safety function with the purpose to stop the motor from turning, without actively braking it. It follows the definition by EN61800-5-2.

For instructions on how to activate and operate the Safe Torque Off (STO) function, read these installation and operating instructions.



QR92916582

Safe Torque Off**Installation and operating instructions**

<http://net.grundfos.com/qr/li/92916582>

2.8.1 Identification of the Safe Torque Off (STO) function

The version of the Safe Torque Off (STO) function is marked on the nameplate, after the product version number.

The Safe Torque Off (STO) functionality is only available for MGE, MLE motors having an STO version number.

The Safe Torque Off (STO) version number is shown below as **Szz**, where **zz** marks the version. For product without STO the **zz** segment will be blank.

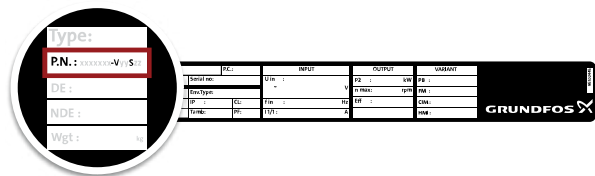

TM084339

The Safe Torque Off (STO) safety function cannot be retrofitted to older motors.

3. Receiving the product**3.1 Transporting the product****WARNING****Falling objects**

Death or serious personal injury



- Secure the product during transport to prevent it from tilting or falling down.

CAUTION**Back injury**

Minor or moderate personal injury



- Use lifting equipment.

CAUTION**Crushing of feet**

Minor or moderate personal injury



- Wear safety shoes when moving the product.

3.2 Inspecting the product

Before installing the product, do the following:

1. Check that the product is as ordered.
If the product is not as ordered, contact the supplier.
2. Check that no visible parts have been damaged.
If any visible parts have been damaged, contact the transport company.

3.3 Lifting the product**WARNING****Falling objects**

Death or serious personal injury



- Use lifting equipment rated for the weight of the product.
- Attach lifting equipment to the motor eyebolts to lift the entire product.
- Wear personal protective equipment.
- Keep a safe distance to the product during lifting operations.
- Follow the lifting instructions for the product.

WARNING**Back injury**

Death or serious personal injury



- Use lifting equipment and follow local regulations when lifting the product.



Observe local regulations concerning limits for manual lifting or handling. Calculate the total weight of the pump with motor by adding the weights stated on the pump and motor nameplates.



Do not lift the product by the terminal box.



Note that typically the center of gravity of the pump is close to the motor.



For lifting instructions, see the related installation and operating instructions for the pump.

Related information**1.1 Related instructions**

4. Installation requirements

4.1 Installing the product in areas with high humidity

WARNING

Fire hazard

Death or serious personal injury



- In high humidity environments where condensation can occur, connect the product permanently to the power supply and activate the standstill heating function.



To maintain the cURus mark, additional requirements apply to the equipment. See the appendix concerning installation in the USA and Canada.



Do not expose the product to UV radiation.



To avoid condensation, the drive must be continuously energized due to the application of heat, with interruptions such that cooling to the point of condensation does not occur.

- Open the drain holes in the product.



When you open the drain hole, the enclosure class of the motor will be lower than standard.

- Connect the product permanently to the power supply. In areas with a high humidity, activate the built-in standstill heating function.

Related information

[5.1.1.2 Drain holes](#)

4.2 Location

Observe the instructions on intended use for your specific product regarding indoor and outdoor location.

Related information

[1.1 Related instructions](#)

4.3 Minimum space

4.3.1 Cooling the motor

- Install the motor allowing a distance of minimum 2 inches (50 mm) (D) between the end of the fan cover and the wall or another fixed object.

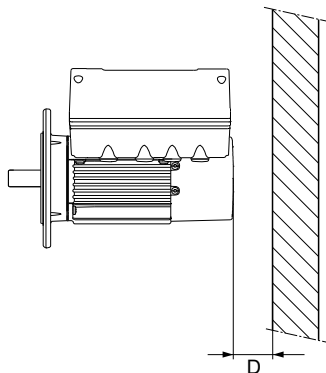

TM071139

- Position the product with sufficient space around.
- Make sure that the temperature of the cooling air does not exceed 122 °F (50 °C).
- Keep cooling fins and fan blades clean.

5. Mechanical installation

5.1 Mounting the product

WARNING

Crushing of feet

Death or serious personal injury



- Fasten the pump securely to a solid and even foundation according to the specifications in the installation and operating instructions for the pump.
- Follow the lifting instructions.

CAUTION

Radiation

Minor or moderate personal injury



- Locate the product at a minimum distance of 8 inches (20 cm) from any body parts. Human tissue may be heated by RF energy.



Installation-related work on the product must only be performed by qualified persons.



For lifting instructions, see the related installation and operating instructions for the pump.



To maintain the cURus mark, additional requirements apply to the equipment.

Related information

[1.1 Related instructions](#)

[3.3 Lifting the product](#)

[4.3.1 Cooling the motor](#)

5.1.1 Positioning the product

5.1.1.1 Product installation

The drive needs to be installed in one of the following two positions:

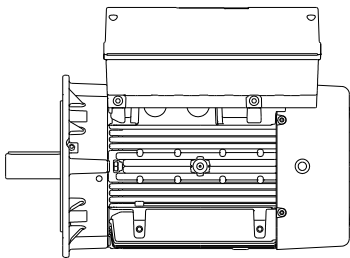

Horizontal orientation

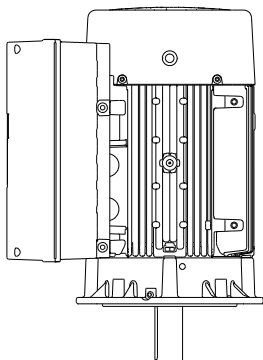

Vertical orientation

5.1.1.2 Drain holes

The motor has a plugged drain hole on the drive side. The drain hole is placed in the flange on the drive side. You can turn the flange 90° to both sides or 180°.

With the drain hole open, the motor becomes self-venting, allowing water and humid air to escape.

When you open the drain hole, the enclosure class of the motor will be lower than standard.

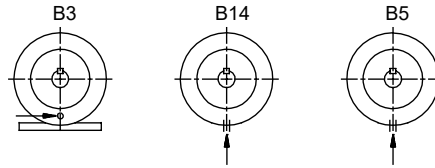

TM029037

5.1.2 Changing the position of the operating panel

WARNING

Electric shock

Death or serious personal injury



- Switch off the power supply to the product including the power supply for the signal relays. Wait at least 5 minutes before you make any connections in the terminal box.

You can turn the operating panel 180°. Follow the instructions.

1. Loosen the four screws on the terminal box cover.
2. Remove the terminal box cover.
3. Press and hold in the two locking tabs (A) while gently lifting the plastic cover (B).

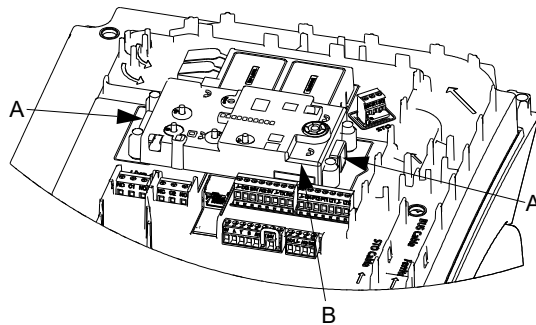

TM084034

Lifting the plastic cover, shown on a Model J motor

4. Turn the plastic cover 180°.



Do not twist the cable more than 90°.

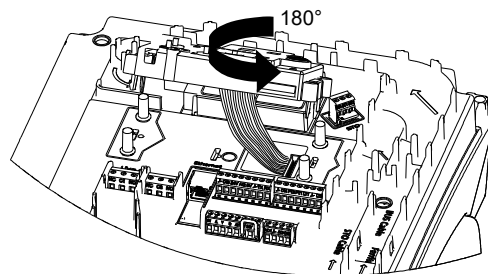

TM084035

Turning the plastic cover, shown on a Model J motor

TM083961

TM083962

5. Position the plastic cover correctly over the four rubber pins (C). Make sure that the locking tabs (A) are placed correctly.

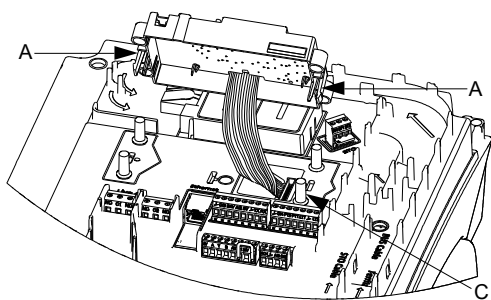

TM084036

Positioning the plastic cover, shown on a Model J motor

6. Fit the terminal box cover and cross-tighten the four screws to 3.7 ft·lb (5 Nm).



Make sure that the terminal box cover is aligned with the orientation of the operating panel.

6. Electrical connection

WARNING

Electric shock

Death or serious personal injury

- Switch off the power supply to the product including the power supply for the signal relays. Wait at least 5 minutes before you make any connections in the terminal box. Make sure that the power supply cannot be switched on accidentally.



- Check that the supply voltage and frequency correspond to the values stated on the nameplate.
- Connect the pump to an external power switch close to the pump and to a motor-protective circuit breaker. Make sure you can lock the power switch in OFF position (isolated). Type and requirements as specified in EN 60204-1, 5.3.2.

CAUTION

Sharp element

Minor or moderate personal injury

- When installing the wiring in the terminal box, wear protective gloves to avoid cutting your hands on sharp edges.



If the power cable is damaged, it must be replaced by the manufacturer, the manufacturer's service partner or a similarly qualified person.



The user or the installer is responsible for correct earthing and protection according to local regulations.



All electrical connections must be carried out by qualified persons.



Make sure to fill the pump with water before the power is switched on. Follow the instructions for the pump.

Related information

1.1 Related instructions

6.1 Connecting an external switch

We recommend that you connect the product to an external switch.

1. Connect the switch via terminals 2 (DI1) and 6 (GND).
A jumper is added from factory.
2. Enable the **External stop** function.
Default setting from factory.

6.2 Power supply

DANGER

Electric shock

Death or serious personal injury

- Use the recommended fuse size.



6.2.1 Three-phase supply voltage

Three-phase motors are available for the voltages below:

- 3 x 440-480 V -10 % / +10 %, 60 Hz, PE

Check that the supply voltage and frequency correspond to the values stated on the nameplate.

The wires in the motor terminal box must be as short as possible. Excepted from this is the separated earth conductor which must be so long that it is the last one to be disconnected in case the cable is inadvertently pulled out of the cable entry.

In order to avoid loose connections, make sure that you have pressed home the terminal block for L1, L2 and L3 in its socket when you connect the power cable.

For maximum backup fuse, see the section on supply voltage.



If you want to supply the motor through an IT network, make sure that you have a suitable motor variant. If you are in doubt, contact Grundfos.

Only the following motors can be supplied through an IT network:

- Motors with a speed of 2900-4000 rpm or 4000-5900 rpm and up to 3 HP (2.2 kW).



Corner earthing is not allowed for supply voltages above 3 x 240 V and 3 x 480 V, 60 Hz.

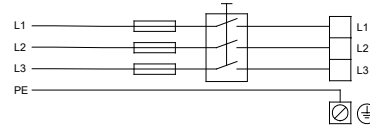

Example of a power supply-connected motor with a power switch, backup fuses

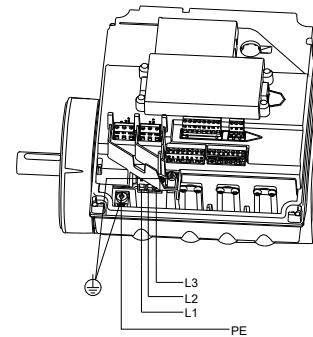

Power supply connection, three-phase motors

6.3 Electrical supply systems

Power supply network and earthing systems



If you want to supply the product through an IT network, make sure that you have a suitable product variant. If you are in doubt, contact Grundfos.

The internal EMC filter remains connected, and subsequently no reduced leakage current variant is available.

Supply line types

Model K:

For applications in accordance with IEC 61800-5-1, the maximum voltage to ground must not exceed 277 V.

The product is not suitable for use for corner earthed grids.

Maximum installation altitude: 11480 ft (3500 m).

- TN-S earthing system
- TN-C earthing system
- TN-C-S earthing system
- TT earthing system

TM078920

TM053495

6.4 Protection against electric shock, indirect contact

WARNING

Electric shock

Death or serious personal injury



- Connect the product to protective earth and provide protection against indirect contact in accordance with local regulations.

Protective-earth conductors must have a yellow and green (PE) or yellow, green and blue (PEN) colour marking.

6.5 Cover for the power cables

Model K is equipped with a cover for the power cables.

The cover is attached to the insulation cover with 2 screws (2) and is equipped with 3 voltage measuring holes (1) for the respective phases (L1, L2, L3).

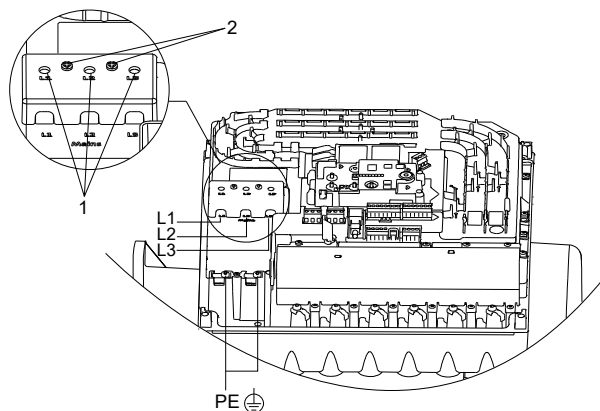

The cover for the power cables must be installed before switching on the product.

6.6 Protection against power supply voltage transients

The product is protected against power supply voltage transients in accordance with EN 61800-3.

6.7 Motor protection

The product incorporates thermal protection against slow overloading and blocking. No external motor protection is required.

Model K: The product includes load and speed sensitive motor overload protection with thermal memory retention.

6.8 Cable requirements

6.8.1 Cable entries

The cable entries are fitted with blanking plugs from the factory. See the cable entry sizes in the section on other technical data.

Related information

[13.4.6 Cable entry sizes](#)

6.8.2 Cable glands

Cable glands are not available in the North American region.

Related information

[13.4.1 Ecodesign Directive](#)

6.8.3 Cable cross-section

WARNING

Electric shock

Death or serious personal injury



- Switch off the power supply to the product including the power supply for the signal relays. Wait at least 5 minutes before you make any connections in the terminal box.
- Follow the wiring diagrams and local regulations.
- Use branch-circuit protection fuses.
- Comply with local regulations as to cable cross-sections.
- Use the recommended fuse size.
- Connect the cables to terminals by applying the recommended tightening torque.

WARNING

Fire hazard

Death or serious personal injury



- Comply with local regulations as to cable cross-sections.
- Use the recommended fuse size.
- Connect the cables to terminals by applying the recommended tightening torque.



Make sure that the cables are secured with cable glands providing strain relief.



Recommended cable type for Model K: H07RN-F.

Related information

[13.4.7 Torques](#)

6.8.3.1 Cable cross-section data for MLE motors**3 × 440-480 V, 60 Hz, Model K**

Speed [rpm]	Power P2 [HP]	Supply voltage [V]	Nominal current [A]	Service factor current [A]	Cable cross-section [AWG]
3500-4000	20	3 × 440-480	23.1 - 21.8	27.3 - 24.8	8
	25	3 × 440-480	28.5 - 26.4	32.9 - 30.2	8
	30	3 × 440-480	34.3 - 31.6	39.4 - 36.2	8

6.8.4 Conductors

Conductor types

Model K: Use stranded copper conductors only.

Conductor temperature ratings

Model K: Use 167 °F copper conductors only. The wire sizes for the mains supply must be sized for a wire size which is suitable for at least 125% of the rated input current of the motor drive units.

6.8.5 Conduit hubs

Conduit hubs must be UL listed according to UL Category Code Number (CCN) DWTT/DWTT7 and be suitable for the relevant enclosure type rating in accordance with UL 514B and CSA C22.2 No. 18.3.

For type 12 enclosures, it is also allowed to use type 12 and 13 conduit hubs.

The relevant type rating can be found on the nameplate of the product.

6.8.6 Three-phase connections

The cables in the terminal box must be as short as possible. However, the separated protective-earth conductor must be so long that it is the last one to be disconnected in case the cable is inadvertently pulled out of the cable entry.



To maintain the cURus mark, additional requirements apply to the equipment. See the appendix concerning installation in the USA and Canada.

Model K: To avoid loose connections, ring terminals must be used. Ensure that ring terminals are short enough to stay within the terminal cover.

Check that the supply voltage and frequency correspond to the values stated on the nameplate.

Power supply connection on a three-phase product

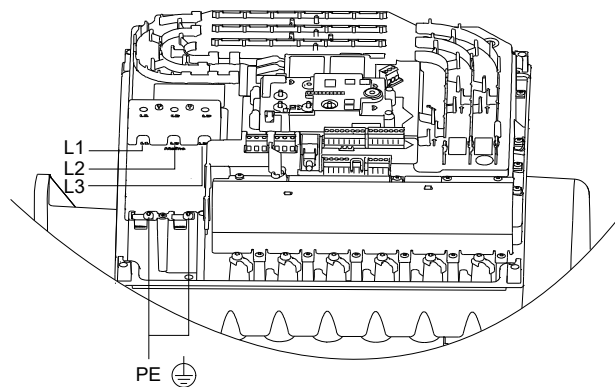

TM082860

Model K

Pos.	Description
L1	Phase 1
L2	Phase 2
L3	Phase 3
PE	Protective earth

6.9 Additional protection

6.9.1 Overvoltage and undervoltage protection

Overvoltage and undervoltage may occur in case of unstable power supply or a faulty installation. The product stops if the voltage falls outside the permissible voltage range. The product restarts automatically when the voltage is within the permissible voltage range. The product requires no additional protection relay.



The product is protected against transients from the power supply according to EN 61800-3. In areas with high lightning intensity, we recommend external lightning protection.

Overvoltage category:

The product is approved for Overvoltage category III rating.

6.9.2 Overload protection

The motor-current protection settings are fixed for each motor variants. The settings ensure that the motor is protected against overtemperature in all operating states with regard to supply voltage and shaft load, including a blocked shaft.

The motors are current controlled and will respond by reducing the speed if the shaft load increases more than 10 % of the nominal load.

If the shaft load forces the speed down to minimum speed, the motor shuts down.

A sudden increase in the motor current caused by a fault where the peak of the motor current is increased 60 % above nominal will cause the motor to shut down within 0.5 ms.

The product requires no additional protection.

6.9.3 Overtemperature protection

The motor is thermally protected by a temperature measurement in the drive. It can handle the lack of airflow over the motor in case the fan cover is blocked. It also means that the protection has a built-in memory retention.

The time from start to shutdown due to overtemperature is therefore always longer when starting at a motor temperature close to the ambient temperature compared with restarting after a shutdown due to overtemperature.

6.9.4 Protection against phase unbalance

Phase unbalance on the power supply must be minimised. The three-phase motor must be connected to a power supply with a quality corresponding to IEC 60146-1-1, class C. This also ensures long life of the components.

6.9.5 Short-circuit current

The product's electronic power output short-circuit protection circuitry meets the requirements of IEC 60364-4-41:2005/AMD1:-, Clause 411.

Model K: Suitable for use on a circuit capable of delivering not more than 5000 rms symmetrical amperes, 480 V maximum when protected by gG fuses. See the section on fuse sizes.

6.10 Functional modules

The functional modules are different types of add-on boards containing various types of input and output terminals for the user to connect different types of sensors, for example switches and relays.

The product can only contain one functional module at the time.

The following functional modules are available:

- FM310
- FM311 ³⁾

³⁾ Without Bluetooth (BLE).

The selection of module depends on the application and the required number of inputs and outputs.

Cable connections

The screen of signal cables and bus connection cables must be connected to ground via one of the earth clamps (H).

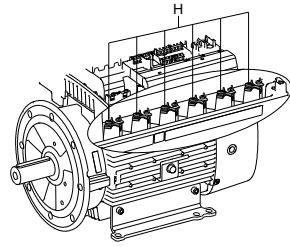

Model K

Related information

2.4.3 Identification of the functional module

6.10.1 Functional module, FM310 and FM311

Inputs and outputs



The FM311 functional module does not include Bluetooth connection.

The module has these connections:

- three analog inputs
- one analog output
- two dedicated digital inputs
- two configurable digital inputs or open-collector outputs
- Grundfos Digital Sensor input and output
- two Pt100/1000 inputs
- two LiqTec sensor inputs
- two signal relay outputs
- GENIbus/Modbus connection
- two Safe Torque Off (STO) inputs
- Ethernet connection

- Bluetooth (BLE) connection. ⁴⁾
- 4) FM311 is without Bluetooth.

Signal relay 1

LIVE: You can connect supply voltages up to 250 VAC to the output.
 SELV: The output is galvanically separated from other circuits. Therefore, you can connect the supply voltage or safety extra-low voltage to the output as desired.

Signal relay 2

SELV: The output is galvanically separated from other circuits. Therefore, you can connect the supply voltage or safety extra-low voltage to the output as desired.

Connection terminals for inputs and outputs

WARNING



Electric shock
 Death or serious personal injury

- Make sure that the wires to be connected to the relays below are separated from each other by reinforced insulation in their entire lengths.

The inputs and outputs are internally separated from the power supply-conducting parts by reinforced insulation and galvanically separated from other circuits. All control terminals are supplied with safety extra-low voltage (SELV), ensuring protection against electric shock.

Cables for the relays must be double insulated or reinforced and rated at least 250V/2A.

The Ethernet cable must be rated at least Cat5e/Cat6 with screening.



The 250V contacts of the alarm relay (NC/C1/NO) on the functional modules FM310 and FM311 must not be connected directly to the mains supply, but energized by an isolated power supply or transformer with galvanic isolation.

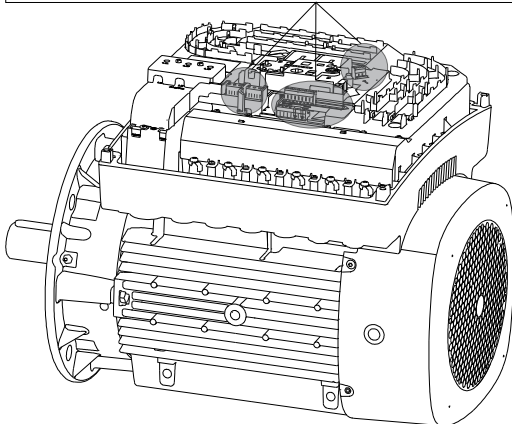
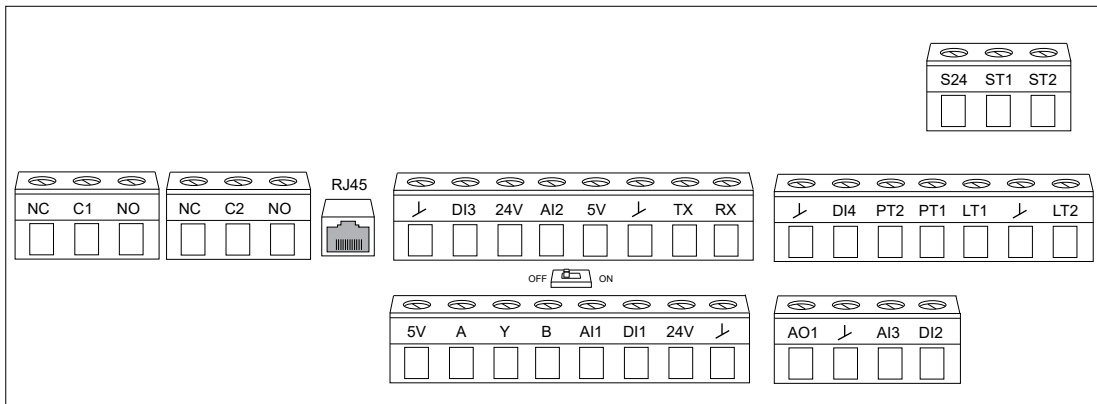

Terminal	Type	Function
NC	Normally closed contact	
C1	Common	Signal relay 1: LIVE or SELV
NO	Normally open contact	
NC	Normally closed contact	
C2	Common	Signal relay 2: SELV only
NO	Normally open contact	
RJ45	Ethernet	Ethernet communication
GND	GND	Signal ground
DI3	DI3/OC1	Digital input/output, configurable Open collector: Maximum 24 V resistive or inductive
24V	+24 V	Power supply
AI2	AI2	Analog input: • 0-20 mA or 4-20 mA • 0.5 - 3.5 V, 0-5 V or 0-10 V.
5V	+5 V	Power supply to a potentiometer or sensor
GND	GND	Signal ground
TX	GDS TX	Grundfos Digital Sensor output
RX	GDS RX	Grundfos Digital Sensor input
GND	GND	Signal ground
DI4	DI4/OC2	Digital input/output, configurable Open collector: Maximum 24 V resistive or inductive
PT2	Pt100/1000 input 2	Pt100/1000 sensor input 2
PT1	Pt100/1000 input 1	Pt100/1000 sensor input 1
LT1	LiqTec sensor input 1	LiqTec sensor input 1 White conductor
GND	GND	Signal ground Brown and black conductors
LT2	LiqTec sensor input 2	LiqTec sensor input 2 Blue conductor
5V	+5 V	Power supply to a potentiometer or sensor
A	GENIbus, A	GENIbus, A (+) / Modbus, D1 (+)
Y	GENIbus, Y	GENIbus, GND / Modbus, GND
B	GENIbus, B	GENIbus, B (-) / Modbus, D0 (-)
AI1	AI1	Analog input: • 0-20 mA or 4-20 mA • 0.5 - 3.5 V, 0-5 V or 0-10 V.
DI1	DI1	Digital input, configurable  Digital input 1 is factory-set to be start or stop input where an open circuit results in stop. A jumper has been factory-fitted between terminals DI1 and GND. Remove the jumper if digital input 1 is to be used as external start or stop or any other external function.
24V	+24 V	Power supply
GND	GND	Signal ground
AO1	AO	Analog output: • 0-20 mA or 4-20 mA • 0-10 V.
GND	GND	Signal ground
AI3	AI3	Analog input: • 0-20 mA or 4-20 mA • 0.5 - 3.5 V, 0-5 V or 0-10 V.

Terminal	Type	Function
DI2	DI2	Digital input, configurable
S24	+24 V (STO)	Power supply to the Safe Torque Off inputs
ST1	STO1	Safe Torque Off - Input 1
ST2	STO2	Safe Torque Off - Input 2





6.11 Signal relays

The functions of the two signal relays appear from the table below:

The motor has two outputs for potential-free signals via two internal relays. You can set the signal outputs to **Operation**, **Pump running**, **Ready**, **Alarm** and **Warning**.

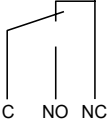

Grundfos Eye is off

The power is off.

Operation	Pump running	Ready	Alarm	Warning	Operating mode
					-



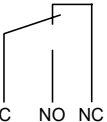
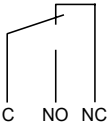

Grundfos Eye is rotating green

The pump runs in **Normal** mode in open or closed loop.

Operation	Pump running	Ready	Alarm	Warning	Operating mode
					Normal Min. or Max.



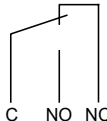
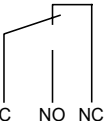

Grundfos Eye is rotating green

The pump runs in **Manual** mode.

Operation	Pump running	Ready	Alarm	Warning	Operating mode
					Manual



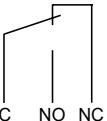

Grundfos Eye is permanently green

The pump is ready for operation but is not running.

Operation	Pump running	Ready	Alarm	Warning	Operating mode
					Stop



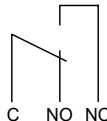

Grundfos Eye is rotating yellow

Warning, but the pump is running.

Operation	Pump running	Ready	Alarm	Warning	Operating mode
					Normal Min. or Max.

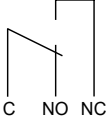
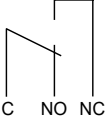



Grundfos Eye is rotating yellow

Warning, but the pump is running.

Operation	Pump running	Ready	Alarm	Warning	Operating mode
					Manual

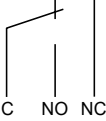

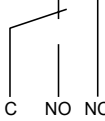

Grundfos Eye is permanently yellow

Warning, but the pump was stopped via a **Stop** command.

Operation	Pump running	Ready	Alarm	Warning	Operating mode
					Stop

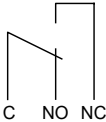

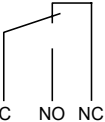

Grundfos Eye is rotating red

Alarm, but the pump is running.

Operation	Pump running	Ready	Alarm	Warning	Operating mode
					Normal Min. or Max.

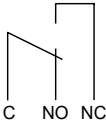

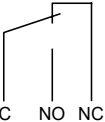

Grundfos Eye is rotating red

Alarm, but the pump is running.

Operation	Pump running	Ready	Alarm	Warning	Operating mode
					Manual

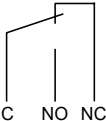
Grundfos Eye is flashing red

The pump has been stopped due to an alarm.

Operation	Pump running	Ready	Alarm	Warning	Operating mode
					Stop

6.12 Signal cables

Use screened cables with a cross-sectional area of minimum 28 AWG (0.5 mm²) and maximum 16 AWG (1.5 mm²) for the external on/off switch, digital inputs, setpoint and sensor signals.

The wires in the motor terminal box must be as short as possible.

6.12.1 Connecting signal cables

1. Connect the screens of the cables to the frame at both ends with good connection. The screens must be as close as possible to the terminals.

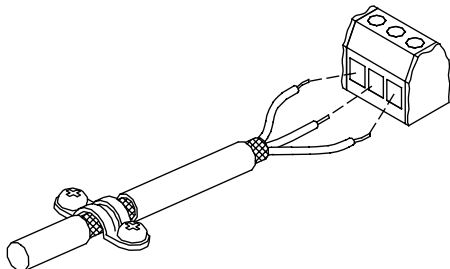

TM021325

2. Connect the signal cables to the terminals.
3. Depending on the model, tighten one or two earth clamp screws.
See the section on functional modules.

6.12.2 Connection of Danfoss pressure sensor MBS3000 to an E-pump



MBS3000 pressure sensor

Use screened cables with a cross-sectional area of minimum 28 AWG and maximum 16 AWG.

The blue wire of the pressure sensor is connected to terminal (A1) of the E-pump. The brown wire of the pressure sensor is connected to terminal 24 V of the E-pump.

6.12.3 Connection of Grundfos pressure sensor ISP44 to an E-pump



ISP44 pressure sensor

Use unscreened cables with a cross-sectional area of minimum 28 AWG and maximum 16 AWG.

The blue wire of the pressure sensor is connected to terminal (A1) of the E-pump. The brown wire of the pressure sensor is connected to terminal 24 V of the E-pump.

TM083396

6.13 Bus connection cable

6.13.1 Connecting a 3-core bus cable, GENibus

For the bus connection, use a screened 3-core cable with a cross-sectional area of minimum 28 AWG (0.5 mm²) and maximum 16 AWG (1.5 mm²).

- If the motor is connected to a unit with a cable clamp which is identical to the one on the product, connect the screen to the cable clamp.
- If the unit has no cable clamp, leave the screen unconnected at this end.

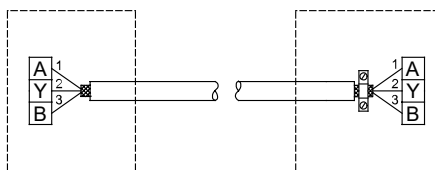

TM070223

6.13.2 Connecting a 3-core bus cable, Modbus

A screened, twisted-pair cable must be used. The cable screen must be connected to protective earth at both ends.

Recommended connection

Terminal	Modbus	Colour code	Data signal
A	D1	Yellow	Positive
B	D0	Brown	Negative
Y	Common/GND	Grey	Common/GND

Fitting the cable

1. Connect the yellow conductor to terminals D1 and A.
2. Connect the brown conductor to terminals D0 and B.
3. Connect the grey conductor to terminals Common/GND and Y.
4. Connect the cable screens to protective earth via the earth clamp.

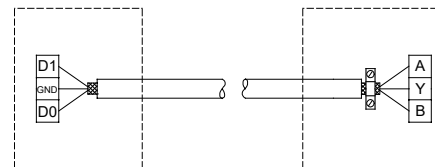

TM083382



It is important to connect the screen to protective earth through the earth clamp and to connect the screen to protective earth in all units connected to the bus line.

6.13.3 Connecting a 2-core bus cable

- Connect a screened 2-core bus cable as follows:

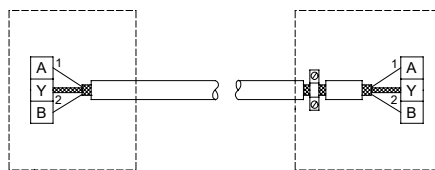

TM070221

6.13.4 Connecting an Ethernet cable

For the USA and Canada, the connection of Ethernet cables must be done by connecting the Ethernet cable screen to an earth clamp on the terminal box, as shown below.

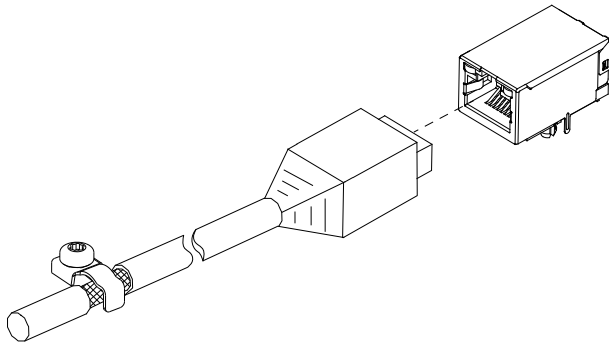

TM085827

Connecting an Ethernet cable

The Ethernet cable must be rated at least Cat5e/Cat6 with screening.

The recommended Ethernet cable types for earth clamp applications are SF/UTP, S/FTP or SF/FTP, where the cable screen consists of both a braided and a foil screen.

6.13.5 Bus signal

The product enables serial communication via an RS-485 input. The communication is carried out according to the Grundfos GENIbus protocol and enables connection to a building management system or another external control system.

Via a bus signal, you can remote-set operating parameters, such as the setpoint and operating mode. At the same time, the product can provide status information about important parameters, such as the actual value of the control parameter, input power and fault indications, via the bus.

Contact Grundfos for further information.



If you use a bus signal, the local settings made via Grundfos GO or the HMI 300 or 301 operating panel will be overruled. In case the bus signal fails, the product will run with the local settings made via Grundfos GO or the HMI 300 or 301 operating panel.

6.14 Installing a communication interface module

WARNING

Electric shock

Death or serious personal injury



- Switch off the power supply to the product including the power supply for the signal relays. Wait at least 5 minutes before you make any connections in the terminal box. Make sure that the power supply cannot be switched on accidentally.



Use an antistatic service kit when handling electronic components. This prevents static electricity from damaging the components.

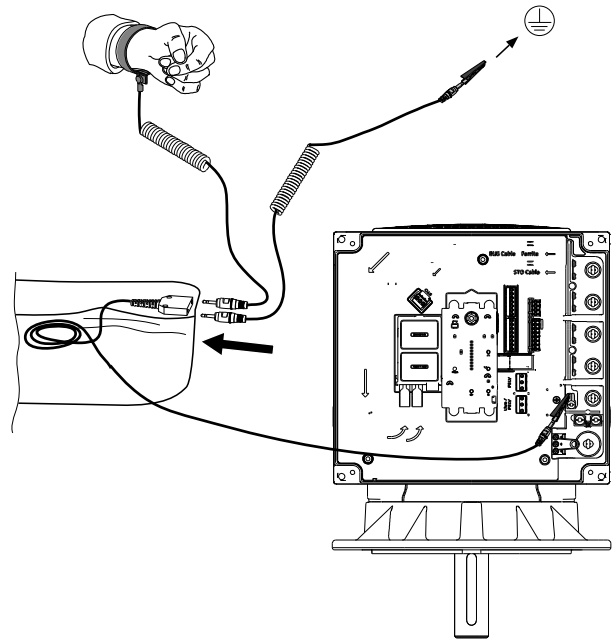

TM084038

Using an antistatic service kit, shown on a Model J motor

1. Loosen the four screws on the terminal box cover.
2. Remove the terminal box cover.
3. Remove the CIM (Communication Interface Module) cover (C1) by pressing the locking tab (D) and lifting the end of the cover (C2). Then lift the cover off the hooks (C3).

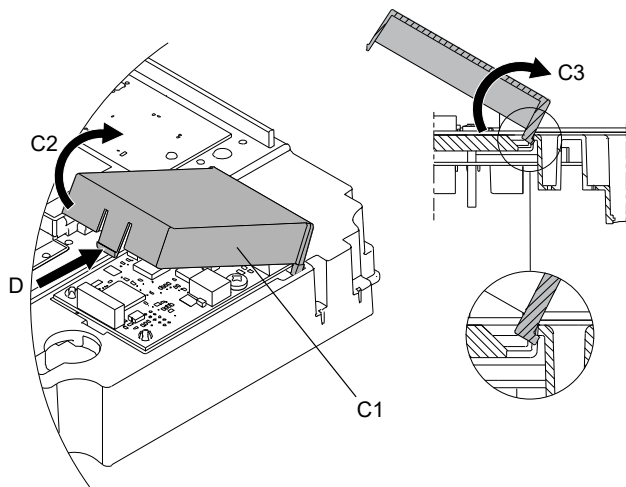

TM069905

Removing the CIM cover, shown on a Model J motor

4. Remove the screw (E).

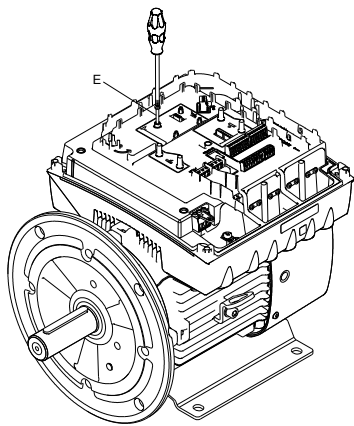

Removing the screw, shown on a Model J motor

5. Fit the module by aligning it with the three plastic holders (F) and the connection plug (G). Press the module home, using your fingers.

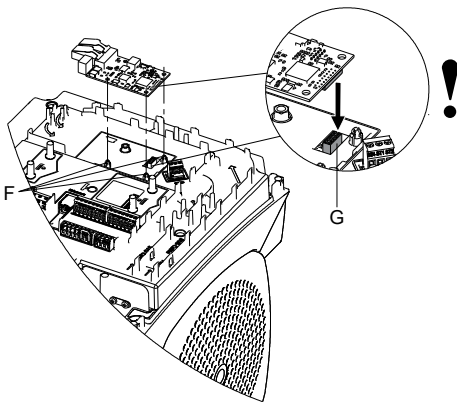

Fitting the module, shown on a Model J motor

6. Fit and tighten the screw (E) to 1 ft-lb (1.3 Nm).
7. Make the electrical connections to the module as described in the instructions supplied with the module.
8. Connect the cable screens of the bus cables to ground via one of the earth clamps (H).

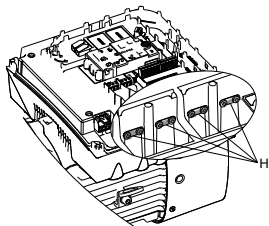

Model J motor

TM084039

TM084040

TM084041

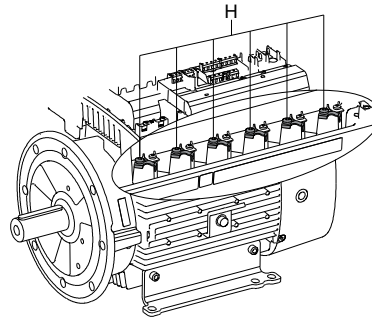

Model K motor

9. Route the wires for the module through one of the cable glands.

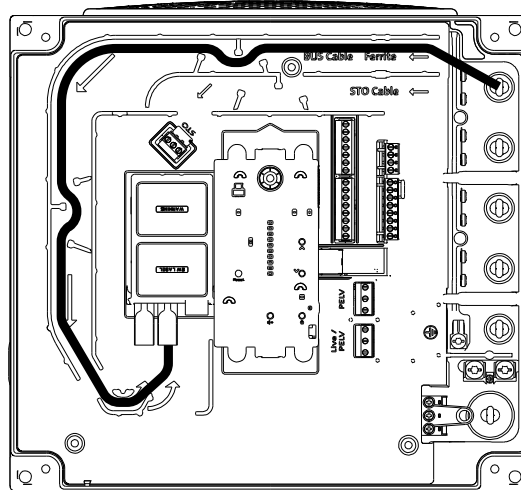

Routing the wires through a cable gland, shown on a Model J motor

10. Fit the CIM cover.
11. If the module is supplied with an FCC label, fix the label on the terminal box.

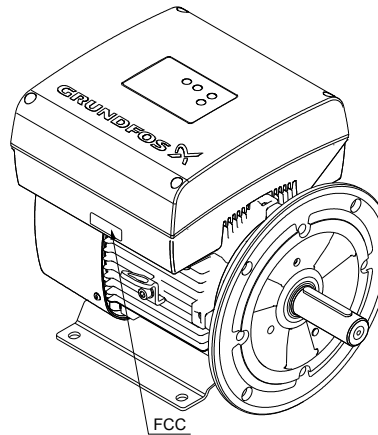

FCC label placement, shown on a Model J motor

12. Fit the terminal box cover and cross-tighten the four screws to 3.7 ft-lb (5 Nm).



Make sure that the terminal box cover is aligned with the orientation of the operating panel.

TM082868

TM084042

TM084101

7. Starting up the product

WARNING



Rotating parts

Death or serious personal injury

- Make sure to install the coupling guards before powering on the product.

WARNING



Corrosive liquids

Death or serious personal injury

- Wear personal protective equipment.

WARNING



Toxic liquids

Death or serious personal injury

- Wear personal protective equipment.

CAUTION



Cold surface

Minor or moderate personal injury

- Make sure that no one can accidentally come into contact with cold surfaces. Wear protective gloves.

CAUTION



Hot surface

Minor or moderate personal injury

- Do not touch the product while it is running.



Follow the startup instructions for the pump. See the related installation and operating instructions for the pump.

Related information

[1.1 Related instructions](#)

8. Control functions

8.1 User interfaces

WARNING



Hot surface

Death or serious personal injury

- Touch only the buttons on the operating panel. The product may be very hot.

WARNING



Electric shock

Death or serious personal injury

- If the operating panel is cracked or perforated, replace it immediately. Contact the nearest Grundfos sales company.

You can change the settings by means of the following user interfaces:

- HMI 200 operating panel
 - HMI 201 operating panel ⁵⁾
 - HMI 300 operating panel
 - HMI 301 operating panel ⁵⁾
 - Grundfos GO application.
- ⁵⁾ HMI without a radio module.





All settings are saved if the power supply is switched off.

Related information

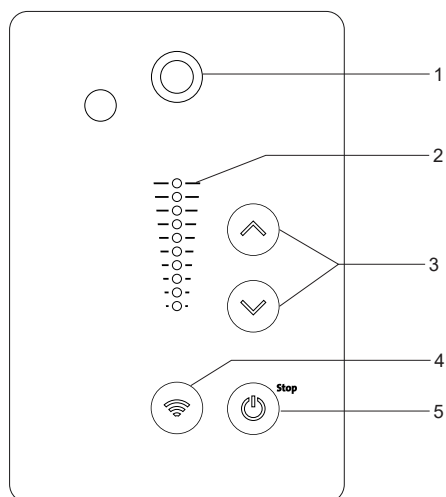
[2.4.4 Identification of the operating panel](#)

8.2 Operating panels, HMI 200 and 201



Pos.	Symbol	Description
1		Grundfos Eye: The indicator light shows the operating status of the product.
2	-	Light fields for indication of the setpoint.
3		Up/Down: The buttons change the setpoint.
4		Communication: The button enables communication with Grundfos GO and other products of the same type.
5		Start/Stop: Press the button to make the product ready for operation or to start and stop the product. Start: If you press the button when the product is stopped, the product starts if no other functions with higher priority have been enabled. Stop: If you press the button when the product is running, the product always stops. When you press the button, the stop icon appears at the bottom of the display.

8.2.1 Setting the setpoint in constant parameter mode

The following applies for motors set to operate in **Const. other val.**

- Set the desired setpoint by pressing the **Up** or **Down** buttons.

The green light fields on the operating panel indicate the setpoint set.

The following example applies to a pump or motor in an application where a pressure sensor gives a feedback to the pump or motor. The sensor has been set manually, and the pump or motor does not automatically register a connected sensor.

Light fields 5 and 6 are activated, indicating a desired setpoint of 116 psi (8 bar) with a sensor measuring range from 0 to 232 psi (16 bar). The setting range is equal to the sensor measuring range.

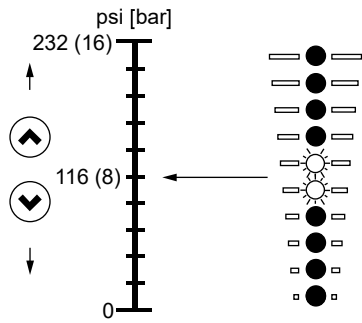

TM068914

8.2.2 Setting the setpoint in constant curve mode

- Set the desired setpoint by pressing the **Up** or **Down** buttons.

The green light fields on the operating panel indicate the setpoint set.

Example: In **Constant curve** mode, the motor output is between minimum and maximum speed defined by **Operating range**.

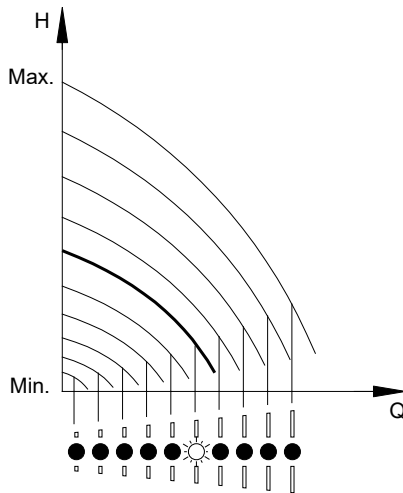

TM054895

8.2.3 Setting to maximum speed

The motor must not be in operating mode **Stop**.

- Press and hold the **Up** button until the top light field is on and starts flashing.

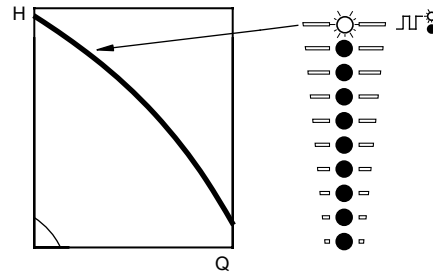

TM054896

8.2.4 Setting to minimum speed

The motor must not be in operating mode **Stop**.

- Press and hold the **Down** button until the bottom light field is on and starts flashing.

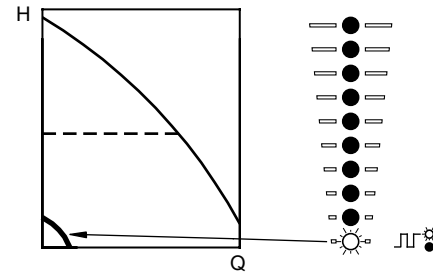

TM054897

8.2.5 Starting the pump

How you start the pump depends on how it was stopped.

- Start the pump in one of the following ways:
 - If the pump was stopped by pressing the **Start/Stop** button: Start the pump by pressing the **Start/Stop** button.
 - If the pump was stopped by pressing and holding the **Down** button: Start the pump by pressing and holding the **Up** button.

8.2.6 Stopping the pump

- Stop the pump in one of the following ways:
 - Press the **Start/Stop** button.
 - Press and hold the **Down** button until all light fields are off.
 - Use Grundfos GO.
 - Use a digital input set to **External stop**.

8.2.7 Resetting alarms and warnings in products with the HMI 200 or 201 operating panel

- You can reset a fault indication in one of the following ways:
 - Briefly press the **Up** or **Down** button. This is not possible if the buttons have been locked. This does not change the setting of the motor.
 - Switch off the power supply until the indicator lights are off.
 - Switch the external start and stop input off, and then on again.
 - Use Grundfos GO.
 - Use the digital input if you have set it to **Alarm resetting**.

8.3 Operating panels, HMI 300 and 301

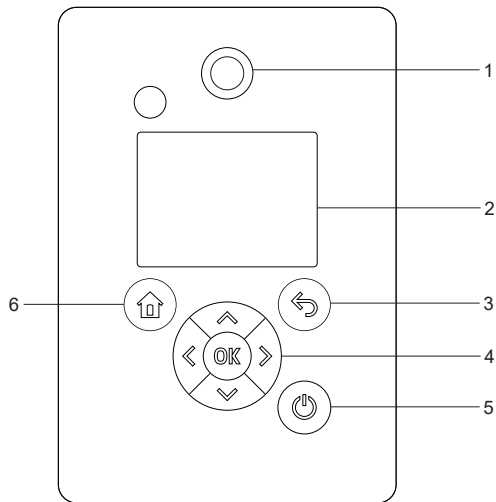

TM082874

Pos.	Symbol	Description
1		Grundfos Eye: The indicator light shows the operating status of the product.
2	-	Graphical colour display.
3		Back: Press the button to go one step back.
		Left/Right: Press the buttons to navigate between main menus, displays and digits. When you change the menu, the display shows the top display of the new menu.
		Up/Down: Press the buttons to navigate between submenus or change the value settings. If you have disabled the possibility to make settings with the Enable/disable settings function, you can enable it again temporarily by pressing these buttons simultaneously for at least 5 seconds.
4		OK: Press the button to do as follows: <ul style="list-style-type: none"> save changed values, reset alarm and expand the value field enable communication with Grundfos GO and other products of the same type. When you try to establish radio communication between the product and Grundfos GO or another product, the green indicator light in Grundfos Eye flashes. In the controller display, a note states that a device wants to connect to the product. Press OK on the product operating panel to allow communication with Grundfos GO or Grundfos GO Link and other products of the same type.
5		Start/Stop: Press the button to make the product ready for operation or to start and stop the product. Start: If you press the button when the product is stopped, the product starts if no other functions with higher priority have been enabled. Stop: If you press the button when the product is running, the product always stops. When you press the button, the stop icon appears at the bottom of the display.
6		Home: Press the button to go to the Home menu.

8.3.1 Home display

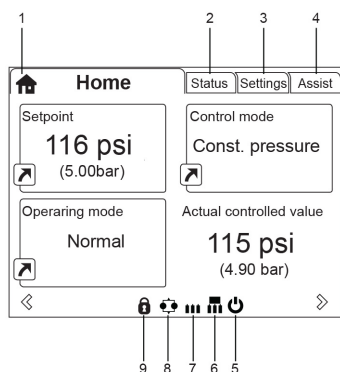

TM068915

Pos.	Symbol	Description
1		Home: This menu shows up to four user-defined parameters. You can access each parameter directly from this menu.
2	-	Status: This menu shows the status of the product and system, warnings and alarms.
3	-	Settings: This menu gives access to all setting parameters. The menu also allows you to make detailed settings.
4	-	Assist: This menu enables assisted setup, provides a short description of the control modes and offers fault-finding advice.
5		Start/Stop: The icon indicates that the product was stopped with the Start/Stop button.
6		Master: The icon indicates that the product is functioning as the master in a multipump system.
7		Slave: The icon indicates that the product is functioning as a slave in a multipump system.
8		Multioperation: The icon indicates that the product is operating in a multipump system.
9		Lock: The icon indicates that the possibility to make settings has been disabled for protective reasons.

8.3.2 Startup guide

You can always run the startup guide at a later time.

The function is only available in the HMI 300 and 301 operating panels.

The startup guide starts at the first startup and guides you through the settings needed for the product to operate in the given application. When the startup guide has been completed, the main menus appear in the display.

8.3.3 Menu overview for the HMI 300 and 301 operating panels

Home	Single pump	Multipump system
	.	.
Status		
Operating status	.	.
	Operating mode, from	.
	Control mode	.
Pump performance	.	.
	Actual control. value	.
	Resulting setpoint	.
	Liquid temp.	.
	Speed	.
	Acc. flow and specific energy	.
Power and energy consumption	.	.
Measured values	.	.

Status		Single pump	Multipump system
	Analog input 1	•	•
	Analog input 2	•	•
	Analog input 3 ⁶⁾	•	•
	Built-in Grundfos sensor	•	•
	Pt100/1000 input 1 ⁶⁾	•	•
	Pt100/1000 input 2 ⁶⁾	•	•
Analog output ⁶⁾		•	•
Warning and alarm		•	•
	Actual warning or alarm	•	•
	Warning log	•	•
	Alarm log	•	•
Operating log		•	•
	Operating hours	•	•
Fitted modules		•	•
Date and time ⁶⁾		•	•
Product identification		•	•
Motor bearing monitoring		•	•
Multi-pump system			•
	System operating status		•
	System performance		•
	System input power and energy		•
	Pump 1, multi-pump system		•
	Pump 2, multi-pump system		•
	Pump 3, multi-pump system		•
	Pump 4, multi-pump system		•

⁶⁾ Only available if an advanced functional module, type FM310 or FM311, is fitted.

Settings		Single pump	Multipump system
Setpoint		•	•
Operating mode		•	•
Set manual speed		•	•
Set user-defined speed		•	•
Control mode		•	•
Setting the proportional pressure		•	
Analog inputs		•	•
	Analog input 1, setup	•	•
	Analog input 2, setup	•	•
	Analog input 3, setup ⁷⁾	•	•
	Built-in Grundfos sensor	•	•
Pt100/1000 inputs ⁷⁾		•	•
	Pt100/1000 input 1, setup ⁷⁾	•	•
	Pt100/1000 input 2, setup ⁷⁾	•	•
Digital inputs		•	•
	Digital input 1, setup	•	•
	Digital input 2, setup ⁷⁾	•	•
Digital inputs/outputs		•	•
	Digital input/output 3, setup	•	•
	Digital input/output 4, setup ⁷⁾	•	•

Settings	Single pump	Multipump system
Relay outputs	•	•
Relay output 1	•	•
Relay output 2	•	•
Analog output ⁷⁾	•	•
Output signal ⁷⁾	•	•
Function of analog output ⁷⁾	•	•
Controller settings	•	•
Operating range	•	•
Setpoint influence	•	•
Ext. setpoint infl.	•	•
Predefined setpoints ⁷⁾	•	•
Monitoring functions	•	•
Motor bearing monitoring	•	•
Alarm handling	•	•
Motor bearing maintenance	•	•
Limit-exceeded function	•	•
LiqTec function	•	•
Special functions	•	•
Low-flow stop function	•	•
Stop at min. speed	•	•
Pipe filling function	•	•
Pulse flowmeter setup	•	•
Ramps	•	•
Standstill heating	•	•
Communication	•	•
Pump number	•	•
Enable/disable radio comm.	•	•
Enable/disable Bluetooth comm.	•	•
Initiate Bluetooth connection	•	•
Setup of AYB terminals	•	•
Setup of Ethernet	•	•
General settings	•	•
Language	•	•
Set date and time	•	•
Units	•	•
Enable/disable settings	•	•
Delete history	•	•
Define Home display	•	•
Display settings	•	•
Store actual settings	•	•
Recall stored settings	•	•
Run start-up guide	•	•

⁷⁾ Only available if an advanced functional module, type FM310 or FM311, is fitted.

Assist	Single pump	Multipump system
Assisted pump setup	•	•
Setup, analog input	•	•
Setting of date and time	•	•

Assist	Single pump	Multipump system
Setup of multi-pump system	•	•
Description of control mode	•	•
Assisted fault advice	•	•

8.4 Grundfos GO

CAUTION



Radiation

Minor or moderate personal injury

- Locate the product at a minimum distance of 8 inches (20 cm) from any body parts. Human tissue may be heated by RF energy.



Installers and end users must be provided with these installation and operating instructions and operating conditions for satisfying RF exposure compliance.

The product is designed for wireless communication with Grundfos GO using Bluetooth (BLE).

Grundfos GO enables you to set functions and gives you access to status overviews, technical product information and current operating parameters.

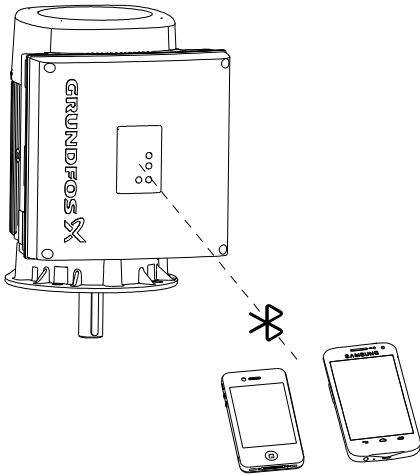

TM082930

8.4.1 Communication

When Grundfos GO initiates communication with the product, the indicator light in the centre of Grundfos Eye flashes green.

On products fitted with the HMI 200 operating panel, you can enable communication by pressing the **Communication** button.

On products fitted with the HMI 300 operating panel, the display indicates that a wireless device is trying to connect to the product. Press **OK** on the operating panel to connect the product with Grundfos GO, or press the **Home** button to reject connection.

Symbol	Description
OK	Press OK on the operating panel to connect the product with Grundfos GO.
	Press the Home button to reject connection.

8.4.1.1 Bluetooth communication

Bluetooth communication can take place at distances up to 32.8 ft (10 m). The first time Grundfos GO communicates with the product, you enable communication by pressing the **Communication** button or **OK** on the operating panel.

Later when communication takes place, the product is recognised by Grundfos GO, and you can select the product from the **List** menu.

8.4.2 Menu overview for Grundfos GO

Dashboard	Single pump	Multipump system
	•	•
View all metrics	Single pump	Multipump system
Pump and application		
Actual controlled value	•	•
Acc. flow, specific energy	•	•
Energy consumption	•	
Energy consumption, system		•
Power consumption	•	
Power consumption, system		•
Motor bearing service	•	
Resulting setpoint	•	
Resulting system setpoint		•
Motor speed	•	
Pump 1		•
Pump 2		•
Pump 3		•
Pump 4		•
Operating Log		
Operating hours	•	
Operating hours, system		•
Motor current	•	
Number of starts	•	
Inputs/outputs		
Analog input 1	•	
Analog input 2	•	
Analog input 3 ⁸⁾	•	
Analog, Output ⁸⁾	•	
Pt100/1000 input 1 ⁸⁾	•	
Pt100/1000 input 2 ⁸⁾	•	
Digital input 1	•	
Digital input 2 ⁸⁾	•	
Digital input/output 3	•	
Digital input/output 4 ⁸⁾	•	
Monitored metrics		
Ambient temperature	•	•
Differential pressure	•	•
Differential pressure, inlet/outlet	•	•
Differential temperature, external	•	•
External pressure 1	•	•
External pressure 2	•	•
Feed tank pressure	•	•
Flow rate	•	•
Pressure : inlet	•	•
Pressure : outlet	•	•
Other parameter	•	•
Tank pressure, external	•	•

View all metrics	Single pump	Multipump system
Temperature 1	•	•
Temperature 2	•	•
Fitted modules		
Functional module	•	
Power board	•	
CIM module	•	
Operating panel	•	

⁸⁾ Only available if an advanced functional module, type FM310 or FM311, is fitted.

Settings	Single pump	Multipump system
Pump and application		
Pump name	•	•
Control mode	•	•
Operating mode	•	•
Setpoint	•	•
Set user-defined speed	•	•
Operating range	•	•
Controller	•	•
External setpoint funct.	•	
Predefined setpoint	•	•
Setting the proportional pressure	•	
Lock panel	•	
Service	•	
Alternating operation, time		•
Sensor to be used		•
Time for pump changeover ⁹⁾		•
Inputs/outputs		
Analog input 1	•	
Analog input 2	•	
Analog input 3 ⁹⁾	•	
Built-in Grundfos sensor	•	
Analog output ⁹⁾	•	
Pt100/1000 input 1 ⁹⁾	•	
Pt100/1000 input 2 ⁹⁾	•	
Digital input 1	•	
Digital input 2 ⁹⁾	•	
Digital input/output 3	•	
Digital input/output 4 ⁹⁾	•	
Relay output 1	•	
Relay output 2	•	
Monitoring functions		
Alarm handling	•	
Limit 1 exceeded	•	•
Limit 2 exceeded	•	•
LiqTec function	•	
Motor bearing monitoring	•	
Special functions		
Low-flow stop	•	

Settings	Single pump	Multipump system
Pipe-filling function	•	•
Pulse flow meter	•	
Ramps	•	
Standstill heating	•	
Stop at min. speed	•	
Communication		
Bluetooth communication	•	
Radio communication	•	
GENibus Number	•	
Connectivity and port settings	•	
General		
Connection code	•	
Date and time ⁹⁾	•	
Firmware	•	
Store settings	•	
Recall settings	•	
Unit configuration	•	

⁹⁾ Only available if an advanced functional module, type FM310 or FM311, is fitted.

Alarms and warnings	Single pump	Multipump system
Alarm log	•	•
Warning log	•	•

Setup	Single pump	Multipump system
Assisted pump setup	•	
Assisted fault advice	•	
Application wizard	•	
Multi-pump setup	•	•

8.5 Grundfos GO Link

The product is designed for wired or wireless communication with Grundfos GO Link.

Grundfos GO Link enables you to set functions and gives you access to status overviews, configuration and current operating parameters.

Use Grundfos GO Link together with these interfaces:

- Ethernet cable (Only FM310 and FM311)
- Grundfos MI 301 - USB - Wired/wireless (Only HMI 200 and HMI 300)
- Grundfos PC Tool Link - USB - Wired

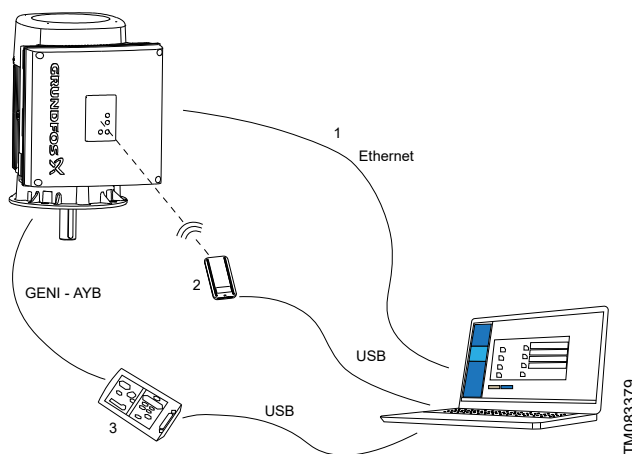

Grundfos GO Link setup

Pos.	Description
1	Ethernet cable: Standard Ethernet cable CAT5/CAT6.

Pos.	Description
2	Grundfos MI 301: Separate module enabling radio communication. Use the module together with a USB cable to connect to a laptop.
3	Grundfos PC Tool Link: Separate module enabling wired connection to the pump. Use the module together with a USB cable to connect to a laptop.

8.5.1 Communication

When Grundfos GO Link initiates communication with the product, it is done using different verification methods.
Select the interface connected to the pump:

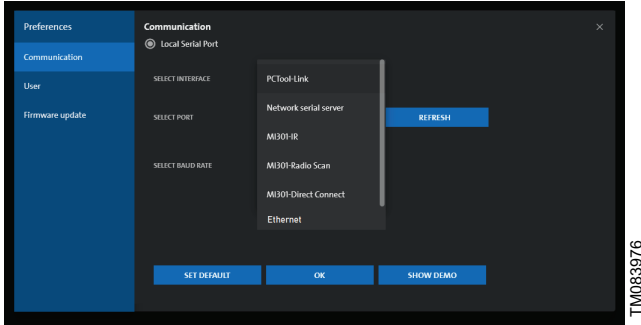

8.5.2 Ethernet

Wired connection can take place using an Ethernet cable connected directly between a laptop and the RJ45 interface in the pump or via a local network having both the pump and the laptop connected to the same network.

To establish a secure connection between the laptop and the pump, the user will have to go through a verification process.

Connecting to a pump can either happen by scanning for a connected product, which can be a direct Ethernet connection, or the pump is connected to a local network or a connection via the pump IP address.

Initiate connection from Grundfos GO Link and follow onscreen instructions.

8.5.3 Grundfos MI 301

Radio communication can take place at distances up to 98 ft (30 m). The first time Grundfos GO Link communicates with the product, you enable communication by pressing the **Radio communication** button or **OK** on the operating panel. Select either MI301-Direct connect or MI301-Radio. When communication takes place, the product is recognized by Grundfos GO Link, and you can connect using Direct connect or Radio scan without having to run a verification.

8.5.4 Grundfos PC Tool Link

Wired connection can take place using Grundfos PC Tool connected to the AYB terminals of the pump. Since Grundfos GO Link is wired to the pump within a short distance, no verification is needed. A direct connection will be established.



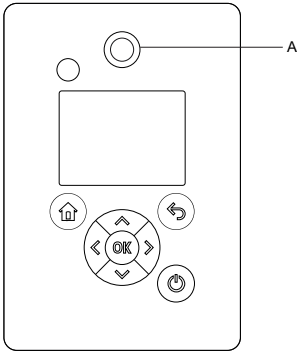

8.6 Grundfos Eye

The operating condition of the motor is indicated by Grundfos Eye on the motor operating panel.

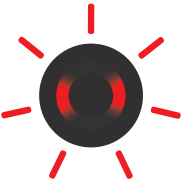
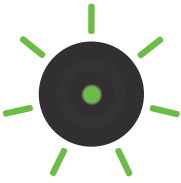
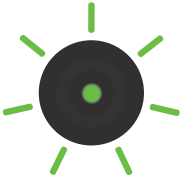
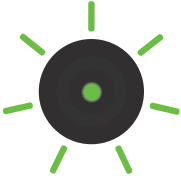

Grundfos Eye indicator light (A)

Indicator light	Indication	Description
	No lights are on.	Power off The motor is not running.
	Two opposite green indicator lights are rotating.	Power on The motor is running. The indicator lights are rotating in the direction of rotation of the motor when seen from the non-drive end.
	Two opposite green indicator lights are permanently on.	Power on The motor is not running.

Indicator light	Indication	Description
	One yellow indicator light is rotating.	Warning The motor is running. The indicator light is rotating in the direction of rotation of the motor when seen from the non-drive end.
	One yellow indicator light is permanently on.	Warning The motor has stopped.
	Two opposite red indicator lights are flashing simultaneously.	Alarm The motor has stopped.
	The green indicator light in the middle flashes quickly four times.	Grundfos Eye flashes four times when you press the Grundfos Eye symbol next to the motor name in Grundfos GO.
	The green indicator light in the middle is flashing continuously.	You have selected the motor in Grundfos GO, and the motor is ready to be connected.
	The green indicator light in the middle flashes quickly for a few seconds.	The motor is controlled by Grundfos GO or exchanging data with Grundfos GO.
	The green indicator light in the middle is permanently on.	The motor is connected to Grundfos GO.

9. Setting the product

You can set control functions via Grundfos GO, Grundfos GO Link or the HMI 300 or 301 operating panel.

- If only one function name is mentioned, it refers to both Grundfos GO and the operating panel.
- If a function name is mentioned in a parenthesis, it refers to a function on the operating panel.

9.1 Setpoint

When you have selected the desired control mode, set the setpoint.

Related information

[9.5 Control mode](#)

9.2 Operating mode

Possible operating modes

Normal	The product runs according to the selected control mode.
Stop	The product stops.
Min.	The product runs at minimum speed. You can use the minimum curve mode in periods in which a minimum flow is required. When operating according to the minimum curve, the pump is operating like an uncontrolled pump.
Max.	The product runs at maximum speed. You can use the maximum curve mode in periods in which a maximum flow is required. When operating according to the maximum curve, the pump is operating like an uncontrolled pump.
Manual	The product is operating at a manually set speed, and the setpoint via bus and setpoint influence function are overruled.
User-defined speed	The product is operating at a speed set by the user.

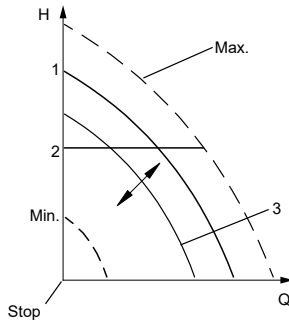

TM064024

Pos.	Description
1	Normal
2	Normal
3	Manual

9.3 Set manual speed

The function is only available in the HMI 300 and 301 operating panels.

Use this function to set the speed in percentage of the maximum speed. When you have set the operating mode to **Manual**, the product starts running at the set speed.

With Grundfos GO, you can set the speed via the **Setpoint** menu.

9.4 Set user-defined speed

Use this function to set the motor speed in percentage of the maximum speed. When you have set the operating mode to **User-defined speed**, the motor starts running at the set speed.

9.5 Control mode

You can choose between the following control modes:

- **Prop. pressure** (proportional pressure)
- **Const. pressure** (constant pressure)
- **Const. temp.** (constant temperature)
- **Con. diff. press.** (constant differential pressure)
- **Con. diff. temp.** (constant differential temperature)
- **Const. flow rate** (constant flow rate)
- **Const. level** (constant level)
- **Const. other val.** (constant other value)
- **Const. curve** (constant curve).

9.5.1 Proportional pressure

The head of the pump is reduced at decreasing water demand and increased at rising water demand. See the figure below.

This control mode is especially suitable in systems with relatively large pressure losses in the distribution pipes. The head of the pump increases proportionally to the flow in the system to compensate for the large pressure losses in the distribution pipes.

The setpoint can be set with an accuracy of 4 inches (10 cm). The head against a closed valve is half the setpoint. The setting range is between 25 % and 90 % of maximum head.

For more information about settings, see section on proportional-pressure setup.

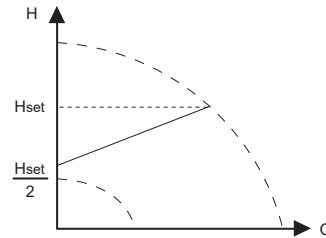

TM057909

Proportional pressure

Example:

- Factory-fitted differential-pressure sensor.

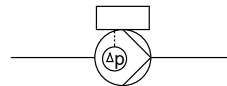

TM057880

Proportional pressure

Controller settings

For the recommended controller settings, see the section on the controller.

Related information

[9.16 Controller \(Controller settings\)](#)

9.5.2 Constant pressure

We recommend this control mode if the pump is to deliver a constant pressure, independently of the flow in the system. The pump maintains a constant pressure independently of the flow rate.

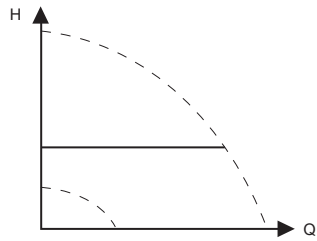

Constant pressure

This control mode requires an external pressure sensor as shown in the examples below. You can set the pressure sensor in the **Assist** menu. See the section on assisted pump setup. The setting range is between 12.5 % and 100 % of maximum head.

Example:

- One external pressure sensor

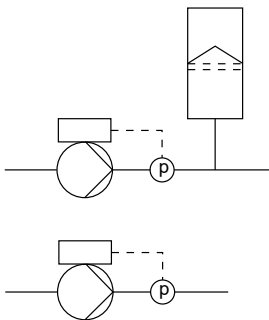

Controller settings

For recommended controller settings, see the section on the controller.

Related information

- [9.16 Controller \(Controller settings\)](#)
- [9.51 Assisted pump setup](#)

9.5.3 Constant temperature

This control mode ensures a constant temperature. Constant temperature is a comfort control mode that you can use in domestic hot-water systems to control the flow to maintain a constant temperature in the system.

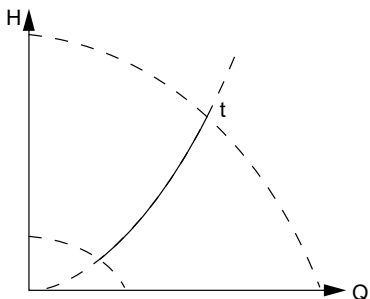

Constant temperature

This control mode requires either an internal or external temperature sensor as shown in the examples below.

Example:

- One external temperature sensor

TM057901

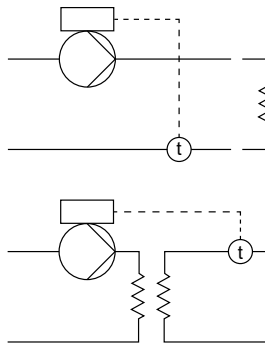

TM057884

TM057885

Controller settings

For the recommended controller settings, see the section on the controller.

Related information

- [9.16 Controller \(Controller settings\)](#)

9.5.4 Constant differential pressure

The pump maintains a constant differential pressure, independently of the flow rate in the system. This control mode is primarily suitable for systems with relatively small pressure losses.

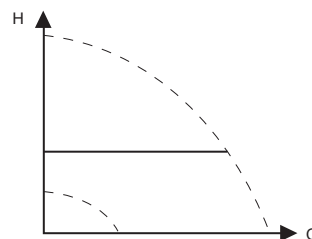

Constant differential pressure

The setting range is between 12.5 % and 100 % of maximum head. This control mode requires either an internal or external differential-pressure sensor or two external pressure sensors as shown in the examples below.

Examples:

- Factory-fitted differential-pressure sensor.

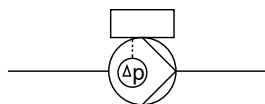

TM057901

TM057860

- One external differential-pressure sensor.

The pump uses the input from the sensor to control the differential pressure.

You can set the sensor manually or by using the **Assist** menu. See the section on assisted pump setup.

TM057900

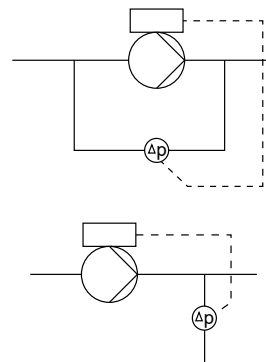

TM057866

TM057867

- Two external pressure sensors.

Constant differential-pressure control is achievable with two individual pressure sensors. The pump uses the inputs from the two sensors and calculates the differential pressure.

The sensors must have the same unit and must be set as feedback sensors. You can set the sensors manually, sensor by sensor, or by using the **Assist** menu. See the section on assisted pump setup.

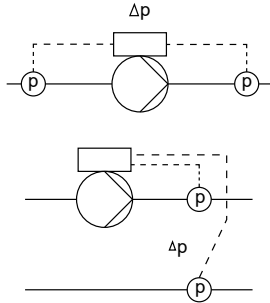

TM057888

TM057889

Controller settings

For recommended controller settings, see the section on the controller.

Related information

- [9.16 Controller \(Controller settings\)](#)
- [9.51 Assisted pump setup](#)

9.5.5 Constant differential temperature

The pump maintains a constant differential temperature in the system and the pump performance is controlled according to this.

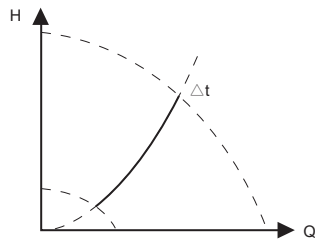

TM057954

Constant differential temperature

This control mode requires either two temperature sensors or one external differential-temperature sensor. See the examples below.

The temperature sensors can either be analog sensors connected to two of the analog inputs or two Pt100/1000 sensors connected to the Pt100/1000 inputs, if these are available on the specific pump.

Set the sensor in the **Assist** menu under **Assisted pump setup**. See the section on assisted pump setup.

Examples:

- Two external temperature sensors.

Constant differential-temperature control is achievable with two temperature sensors. The pump uses the inputs from the two sensors and calculates the differential temperature.

The sensors must have the same unit and must be set as feedback sensors. You can set the sensors manually, sensor by sensor, or by using the **Assist** menu. See the section on assisted pump setup.

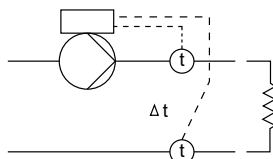

TM057894

- One external differential-temperature sensor.

The pump uses the input from the sensor to control the differential temperature.

You can set the sensor manually or by using the **Assist** menu. See the section on assisted pump setup.

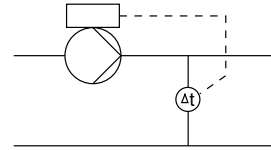

TM057931

Controller settings

For recommended controller settings, see the section on the controller.

Related information

- [9.16 Controller \(Controller settings\)](#)
- [9.51 Assisted pump setup](#)

9.5.6 Constant flow rate

The pump maintains a constant flow in the system, independently of the head.

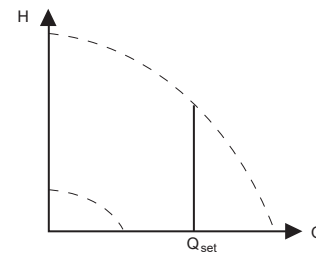

TM057955

Constant flow rate

This control mode requires an external flow sensor. See the example below.

Example:

- One external flow sensor.

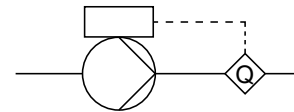

TM057895

Constant flow rate

Controller settings

For recommended controller settings, see the section on the controller.

Related information

- [9.16 Controller \(Controller settings\)](#)

9.5.7 Constant level

The pump maintains a constant level, independently of the flow rate.

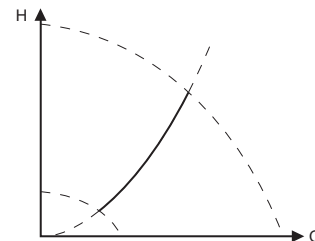

TM057941

Constant level

This control mode requires an external level sensor.

The pump can control the level in a tank in two ways (see the figure above):

- As an emptying function where the pump draws the liquid from the tank.
- As a filling function where the pump pumps the liquid into the tank.

The type of level control function depends on the setting of the built-in controller.

Example:

- One external level sensor with emptying function.

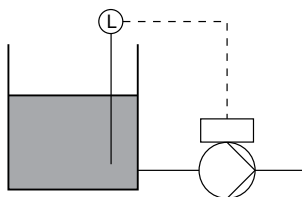

- One external level sensor with filling function.

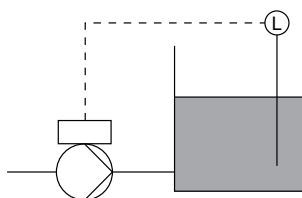

Controller settings

For recommended controller settings, see the section on the controller.

Related information

[9.16 Controller \(Controller settings\)](#)

9.5.8 Constant other value

Use this control mode to control a value which is not available in the **Control mode** menu. To measure the controlled value, connect a sensor to one of the analog inputs. The controlled value is shown in percentage of the sensor range.

9.5.9 Constant curve

Use this control mode to control the motor speed.

You can set the desired speed in percentage of the maximum speed in the range from user-set minimum speed to user-set maximum speed.

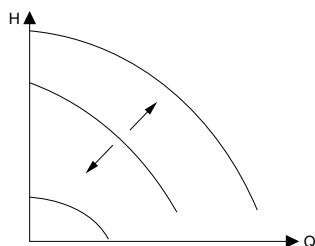

9.6 Setting the proportional pressure

9.6.1 Control curve function

You can set the proportional curve either to quadratic or linear to match the system curve.

9.6.2 Zero flow head

You can set this value in percentage of the setpoint and define how much the setpoint must be reduced at a closed valve. With a setting of 100 %, the control mode is equal to the constant differential pressure.

9.6.3 Fixed inlet pressure

This menu enables the use of a fixed inlet pressure.

9.6.4 Inlet pressure

Enter the fixed inlet pressure that is to be supplied to the pump.

9.6.5 Pump data

To enable the pump to operate in proportional pressure, the controller needs to process the pump curve. Enter the maximum head, rated head and rated flow rate from the pump nameplate.

9.7 FLOWLIMIT

FLOWLIMIT

- Enable the FLOWLIMIT function.
- Set the FLOWLIMIT.

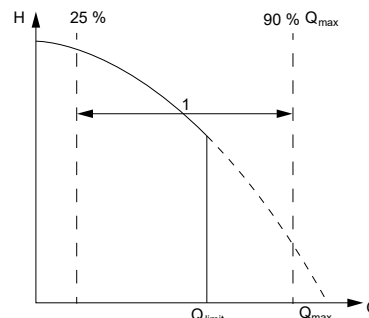

FLOWLIMIT

Pos.	Description
1	Setting range

You can combine the FLOWLIMIT function with the following control modes:

- **Prop. pressure**
- **Con. diff. press.**
- **Con. diff. temp.**
- **Const. temp.**
- **Const. curve.**

A flow-limiting function ensures that the flow never exceeds the entered FLOWLIMIT value.

The setting range for FLOWLIMIT is 25 to 90 % of the Q_{max} of the pump.

Factory setting

See the section on factory settings.

Related information

[9.58 Factory settings for Grundfos GO](#)

9.8 Automatic Night Setback

Once you have enabled automatic night setback, the pump automatically changes between normal duty and night setback, duty at low performance.

Changeover between normal duty and night setback depends on the flow-pipe temperature.

The pump automatically changes over to night setback when the built-in sensor registers a flow-pipe temperature drop of more than 50 to 59 °F (10 to 15 °C) within approximately two hours. The temperature drop must be at least 0.18 °F/min (0.1 °C/min).

Changeover to normal duty takes place without a time lag when the temperature has increased by approximately 50 °F (10 °C).

You cannot enable automatic night setback when the pump is in constant-curve mode.

Factory setting

See the section on factory settings.

Related information

9.58 *Factory settings for Grundfos GO*

9.9 Analog inputs

The inputs and outputs available depend on the functional module fitted in the motor.

Functional module	Analog input 1 (Terminal AI1)	Analog input 2 (Terminal AI2)	Analog input 3 (Terminal AI3)
FM310	•	•	•
FM311	•	•	•

Wiring examples:

These connection scenarios are also valid for connection to analog input 2 and analog input 3.

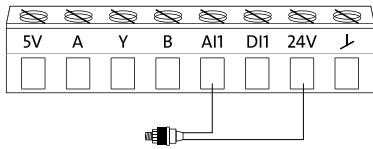

2-wire sensor, 0/4-20 mA

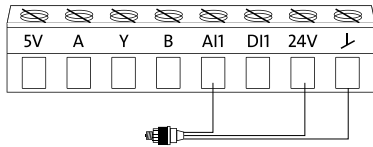

3-wire sensor, 0/4-20 mA

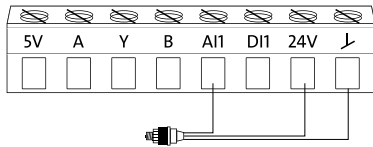

3-wire sensor, 0.5 - 3.5 V, 0-5 V, 0-10 V

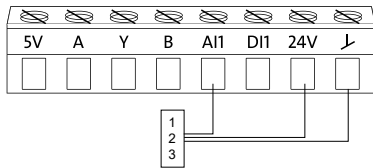

Setpoint influence, 0.5 - 3.5 V, 0-5 V, 0-10 V; 0/4-20 mA

Pos.	Description
1	Potentiometer
2	PLC
3	External controller

To set the input, make the settings below:

Function

You can set the inputs to these functions:

- **Not active**
- **Feedback sensor**
The sensor is used for the selected control mode.

- **Setpoint influence**
The input signal is used for influencing the setpoint.
- **Other function**
The sensor input is used for measurement or monitoring.

Measured parameter

Select one of the below parameters to be measured in the system by the sensor connected to the input.

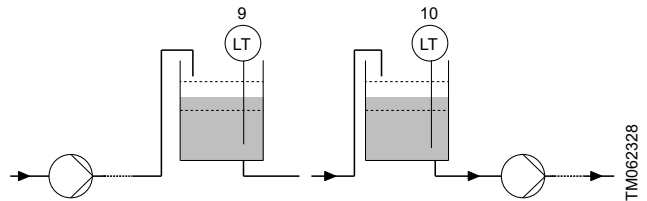
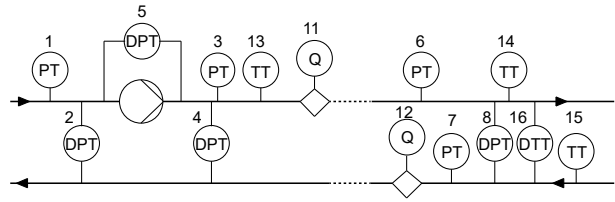

TM083181

TM083182

TM083182

TM083184

TM062328

Pos.	Sensor function/measured parameter
1	Inlet pressure
2	Diff. press., inlet
3	Discharge press.
4	Diff. press., outlet
5	Diff. press., pump
6	Press. 1, external
7	Press. 2, external
8	Diff. press., ext.
9	Storage tank level
10	Feed tank level
11	Pump flow
12	Flow, external
13	Liquid temp.
14	Temperature 1
15	Temperature 2
16	Differential temp.
Not shown	Ambient temp.
Not shown	Other parameter

Unit

Parameter	Available units
Pressure	bar, m, kPa, psi, ft
Level	cm, m, ft, in
Pump flow	m ³ /h, l/s, yd ³ /h, gpm
Liquid temperature	°C, °F
Other parameter	%

Electrical signal

Available signal types:

- 0.5 - 3.5 V
- 0-5 V

- 0-10 V
- 0-20 mA
- 4-20 mA.

Sensor range, minimum value

Set the minimum value of the connected sensor.

Sensor range, maximum value

Set the maximum value of the connected sensor.

9.9.1 Setting two sensors for differential measurement

Two analog sensors must be installed and connected electrically to measure a parameter at two different locations in a system.

The pressure, temperature and flow parameters can be used for differential measurement.

- Set the analog inputs according to the measured parameter:

Parameter	Sensor 1, measured parameter	Sensor 2, measured parameter
Pressure, option 1	Inlet pressure	Discharge press.
Pressure, option 2	Press. 1, external	Press. 2, external
Flow	Pump flow	Flow, external
Temperature	Temperature 1	Temperature 2



If you want to use the **Con. diff. press.**, **Con. diff. temp.** or **Const. flow rate** control modes, you must configure both sensors as **Feedback sensor**.

9.10 Built-in Grundfos sensor

You can select the function of the built-in sensor in the **Built-in Grundfos sensor** menu.

Set the **Built-in Grundfos sensor** via the **Assisted pump setup** menu. See the section on assisted pump setup.

If you perform the setting manually in the advanced operating panel, you must enter the **Analog inputs** menu under the **Settings** menu to access the **Built-in Grundfos sensor** menu.

If you perform the setting manually via Grundfos GO, you need to enter the menu for the **Built-in Grundfos sensor** under the **Settings** menu.

Function

You can set the built-in sensor to the following functions:

- Grundfos diff.-pressure sensor
 - Not active
 - Feedback sensor
 - Setpoint influence
 - Other function.

Factory setting

See the section on factory settings.

9.11 Pt100/1000 inputs

The inputs and outputs available depend on the functional module fitted in the motor.

Functional module	Pt100/1000 input 1 (Terminals PT1, GND)	Pt100/1000 input 2 (Terminals PT2, GND)
FM310	•	•
FM311	•	•

Wiring example:

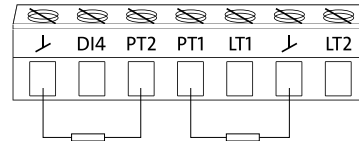

Pt100/1000

To set the input, choose one of the below settings.

Function

You can set the inputs to these functions:

- **Not active**
- **Feedback sensor**
The sensor is used for the selected control mode.
- **Setpoint influence**
The input signal is used for influencing the setpoint.
- **Other function**
The sensor input is used for measurement or monitoring.

Measured parameter

Select one of the below parameters to be measured in the system by the sensor connected to the input.

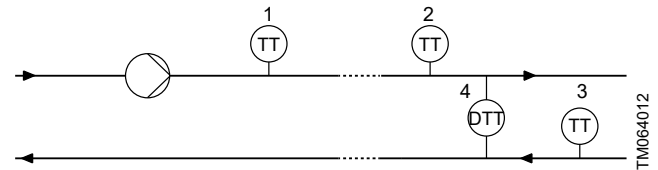

Pos.	Sensor function/measured parameter
1	Liquid temp.
2	Temperature 1
3	Temperature 2
4	Differential temp.
Not shown	Ambient temp.

Measuring range

-58 to 399 °F (-50 to +204 °C).

9.12 Digital inputs

The inputs and outputs available depend on the functional module fitted in the motor.

Functional module	Digital input 1 (Terminals DI1, GND)	Digital input 2 (Terminals DI2, GND)
FM310	•	•
FM311	•	•

Wiring example:

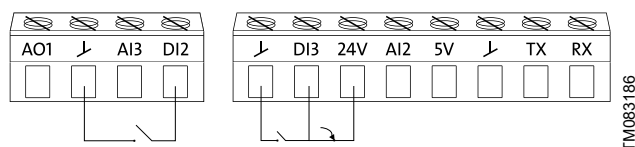

Digital input

To set the input, make the settings below:

Function

You can set the inputs to these functions:

- **Not active**
When set to **Not active**, the input has no function.
- **Ext. stop**
When the input is deactivated, open circuit, the motor stops.
- **Min.** (minimum speed)
When the input is activated, the motor runs at the set minimum speed.
- **Max.** (maximum speed)
When the input is activated, the motor runs at the set maximum speed.
- **User defined speed**
When the input is activated, the motor runs at a speed set by the user.
- **External fault**
When the input is activated, a timer is started. If the input is activated for more than 5 seconds, the motor stops and a fault is indicated. The function depends on input from external equipment.
- **Alarm resetting**
When the input is activated, a fault indication, if any, is reset.
- **Dry running**
When this function is selected, a lack of inlet pressure or water shortage (dry running) can be detected. When this happens, the pump stops. The pump cannot restart as long as the input is activated. This requires the use of an accessory such as these:
 - a pressure switch installed on the inlet side of the pump
 - a float switch installed on the inlet side of the pump.
- **Accumulated flow**
When this function is selected, the accumulated flow can be registered. This requires the use of a flowmeter which can give a feedback signal as a pulse per defined volume of water.
- **Reverse rotation**
This function reverses the direction of rotation of the motor.
- **Predefined setpoint 1**
The function applies only to digital input 2.
When you set digital inputs to a predefined setpoint, the pump operates according to a setpoint based on a combination of the activated digital inputs.
- **Activate output**
When this function is selected, the related digital output is activated. This is done without any changes to pump operation.

- **Local motor stop**

When the function is selected, the given motor in a multimotor system setup stops without affecting the performance of the other motors in the system.

The priority of the selected functions are interdependent.

A stop command always has the highest priority.

Activation of digital inputs

You can set the digital inputs to trigger on either Closed contact or Open contact. Selecting the trigger function can only be set via Grundfos GO Link.

The digital inputs can be activated either as active low or active high.

The digital inputs will react as described in the table below:

Activate/ Closed contact	Deactivate/Open contact
GND/0V	Floating/3-24V

9.12.1 Timer function for a digital input

Activation delay

The activation delay (T1) is the time between the digital signal and the activation of the selected function.

Range: 0-6000 seconds.

Duration time

Available modes:

- **Not active**
- **Active with interrupt**
- **Active without interrupt**
- **Active with after-run.**

The duration time (T2) is the time which, together with the mode, determines how long the selected function is active.

Range: 0 - 15,000 seconds.

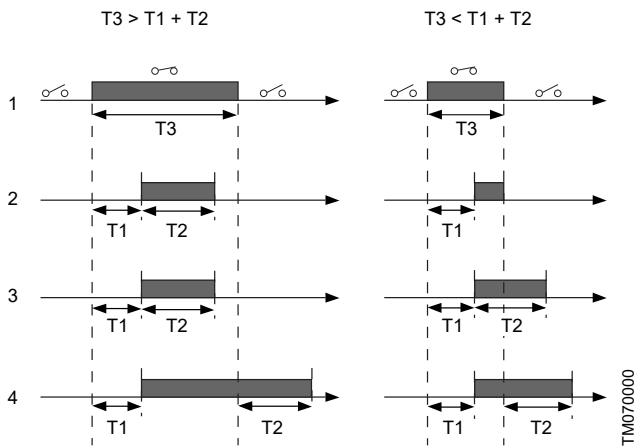

Pos.	Description
1	Digital input.
2	Active with interrupt.
3	Active without interrupt.
4	Active with after-run.
T1	Activation delay.
T2	Duration time.
T3	The period of time when the digital input is activated.

9.13 Digital inputs/outputs

The inputs and outputs available depend on the functional module fitted in the motor.

Functional module	Digital input/output 3 (Terminals DI3, GND)	Digital input/output 4 (Terminals DI4, GND)
FM310	•	•
FM311	•	•

You can select whether the interface is to be used as an input or output. The output is an open collector. You can connect the open collector to, for example, an external relay or a controller such as a PLC.

Wiring example:

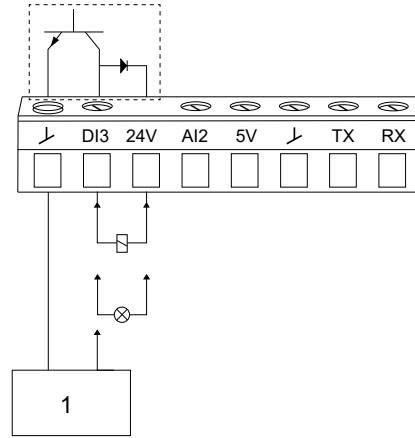

Digital output, open collector

Pos.	Description
1	External controller

Mode

You can set the digital input or output 3 and 4 to act as a digital input or digital output.

Functions if the digital input or output is set to input:

- **Not active**
- **Ext. stop**
- **Min.**
- **Max.**
- **User defined speed**
- **External fault**
- **Alarm resetting**
- **Dry running**
- **Accumulated flow**
- **Reverse rotation**
- **Predefined setpoint 2 (digital input/output 3)**
- **Predefined setpoint 3 (digital input/output 4)**
- **Local motor stop**
- **Activate output**

Functions if the digital input or output is set to output:

- **Not active**
- **Ready**
- **Alarm**
- **Operation**
- **Pump running**
- **Warning**

- **Limit 1 exceeded**
- **Limit 2 exceeded**
- **Digital input 1, state**
- **Digital input 2, state**
- **Digital input 3, state**
- **Digital input 4, state**

9.14 Signal relay (Relay outputs)

The motor has two outputs for potential-free signals via two internal relays.

Functional module	Signal relay 1 (Terminals NC, C1, NO)	Signal relay 2 (Terminals NC, C2, NO)
FM310	•	•
FM311	•	•

Wiring example:

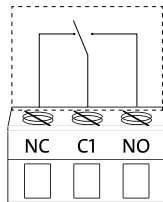

TM083188

Relay output

Functions

You can configure the signal relays to be activated when the product changes to one of the following states:

- **Not active**
The relay has been deactivated.
- **Ready**
The motor may be running or is ready to run, and no alarms are active.
- **Alarm**
There is an active alarm, and the motor is stopped.
- **Operating (Operation)**
Operating equals **Running**, but the motor is still in operation when it is stopped, for example, by the **Stop function** or **Limit exceeded**.
- **Running (Pump running)**
The motor shaft is rotating.
- **Warning**
There is an active warning.
- **Limit 1 exceeded**
When you have set this function and the limit is exceeded, the signal relay is activated.
- **Limit 2 exceeded**
When you have set this function and the limit is exceeded, the signal relay is activated.
- **External fan control (Control of external fan)**
When you select this function, the relay is activated if the internal temperature of the motor electronics reaches a preset limit value. In this way the relay activates external cooling to add additional cooling to the motor.
- **Digital input 1, state**
Follow digital input 1. If digital input 1 is triggered, the digital output is also triggered.
- **Digital input 2, state**
Follow digital input 2. If digital input 2 is triggered, the digital output is also triggered.

- **Digital input 3, state**
Follow digital input 3. If digital input 3 is triggered, the digital output is also triggered.
- **Digital input 4, state**
Follow digital input 4. If digital input 4 is triggered, the digital output is also triggered.

9.15 Analog output

The inputs and outputs available depend on the functional module fitted in the motor.

Functional module	Analog output (Terminals AO, GND)
FM310	•
FM311	•

Wiring example:

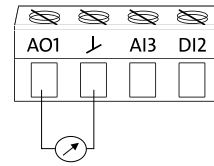

TM083185

Analog output, 0/4-20 mA, 0-10 V

The analog output enables external control systems to read specific operating data.

To set the analog output, make the following settings.

Output signal

Possible signal types:

- 0-10 V
- 0-20 mA
- 4-20 mA.

Function of analog output

Actual speed	
0 %	100 %
0 V	10 V
0 mA	20 mA
4 mA	20 mA

Sensor value	
Minimum	Maximum
0 V	10 V
0 mA	20 mA
4 mA	20 mA

Resulting setpoint	
0 %	100 %
0 V	10 V
0 mA	20 mA
4 mA	20 mA

Motor load	
0 %	100 %
0 V	10 V

Motor load	
0 %	100 %
0 mA	20 mA
4 mA	20 mA

Motor current		
0 %	100 %	200 %
0 V	5 V	10 V
0 mA	10 mA	20 mA
4 mA	12 mA	20 mA

Limit-exceeded function	
Output not active	Output active
0 V	10 V
0 mA	20 mA
4 mA	20 mA

9.16 Controller (Controller settings)

The pumps have a factory default setting of gain (K_p) and integral time (T_i).

However, if the factory setting is not the optimum setting, you can change the gain and the integral time:

- Set the gain within the range from 0.1 to 20.
- Set the integral-action time within the range from 0.1 to 3600 seconds. If you select 3600 seconds, the controller functions as a PI controller.

Furthermore, you can set the controller to inverse control.

This means that if you increase the setpoint, the speed is reduced. In the case of inverse control, you must set the gain within the range from -0.1 to -20.

Guidelines for setting of PI controller

The tables below show the recommended controller settings:

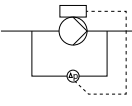
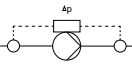
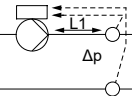
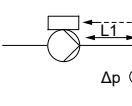
Constant differential pressure	K_p	T_i
	0.5	0.5
		
	0.5	L1 < 16 ft: 0.5 L1 > 16 ft: 3
		L1 > 32 ft: 5

L1: Distance in feet between the pump and the sensor.

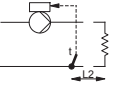
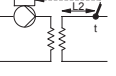
Constant temperature	K_p		T_i
	Heating system	Cooling system	
	0.5	-0.5	10 + 1.524×L2
	0.5	-0.5	30 + 1.524×L2

10) In heating systems, an increase in pump performance results in a rise in temperature at the sensor.

11) In cooling systems, an increase in pump performance results in a drop in temperature at the sensor.

L2: Distance in feet between the heat exchanger and the sensor.

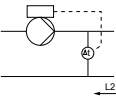
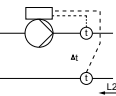
Constant differential temperature	K_p	T_i
	-0.5	10 + 1.524×L2
		

L2: Distance in feet between the heat exchanger and the sensor.

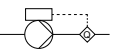
Constant flow rate	K_p	T_i
	0.5	0.5

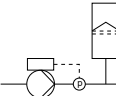
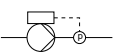
Constant pressure	K_p	T_i
	0.5	0.5
	0.5	0.5

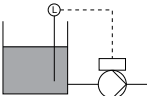
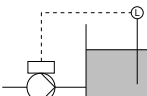
Constant level	K_p	T_i
	-10	0
	10	0

General rules of thumb:

If the controller is too slow-reacting, increase the gain.

If the controller is hunting or unstable, dampen the system by reducing the gain or increasing the integral time.

Factory setting

See the section on factory settings.

Related information

[9.58 Factory settings for Grundfos GO](#)

9.17 Operating range

Set the operating range as follows:

1. Set the minimum speed within the range from fixed minimum speed (5) to user-set maximum speed (2).
 2. Set the maximum speed within the range from user-set minimum speed (4) to fixed maximum speed (1).
- The range between the user-set minimum and maximum speed is the operating range (3).

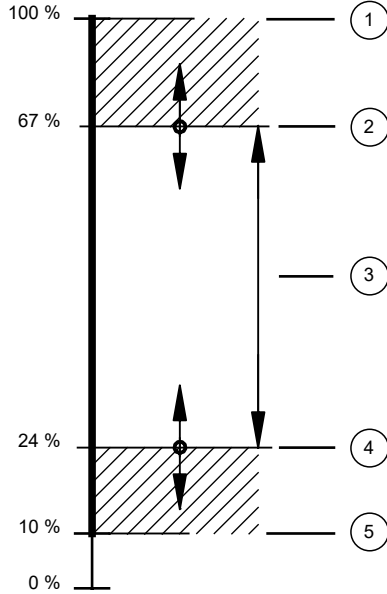

TM069817

Pos.	Description
1	Fixed maximum speed
2	User-set maximum speed
3	Operating range
4	User-set minimum speed
5	Fixed minimum speed

9.18 External setpoint function

Use this function to influence the setpoint by an external signal via one of the analog inputs.

If the FM310 or FM311 functional module is fitted, you can also influence the setpoint via one of the Pt100/1000 inputs.



To enable the function, set one of the analog inputs or Pt100/1000 inputs to **Setpoint influence** with Grundfos GO or to **Ext. setpoint infl.** with the HMI 300 or 301 operating panel.

Example of setpoint influence in control mode Const. pressure

Actual setpoint: actual input signal × setpoint.

At a setpoint of 232 psi and an external setpoint of 60 %, the actual setpoint is $0.60 \times (232 - 0) + 0 = 139$ psi.

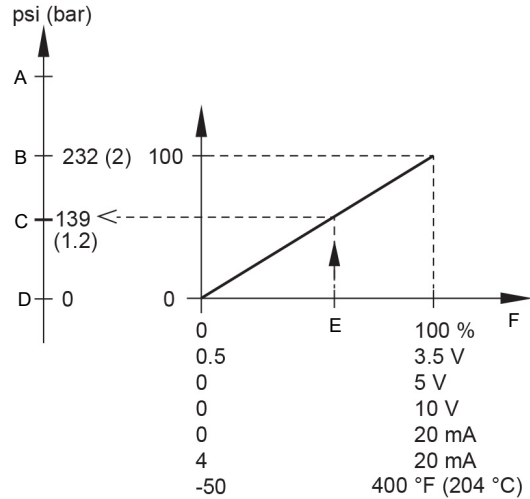

TM080912

Example of setpoint influence with sensor feed back

Pos.	Description
X:	External input signal from 0 to 100 %
Y:	Setpoint influence from 0 to 100 %
X1:	Actual input signal, 60 %
Y1:	Sensor maximum
Y2:	Setpoint
Y3:	Actual setpoint
Y4:	Sensor minimum

Example of a constant curve with linear influence function

Actual setpoint: actual input signal × (setpoint - user-set minimum speed) + user-set minimum speed.

At a user-set minimum speed of 25 %, a setpoint of 85 % and an external setpoint of 60 %, the actual setpoint is $0.60 \times (85 - 25) + 25 = 61$ %.

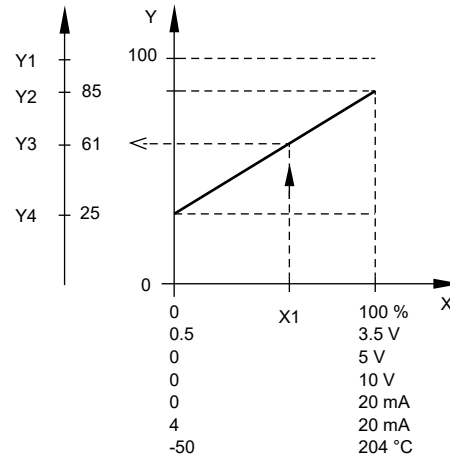

TM070253

Pos.	Description
X:	External input signal from 0 to 100 %
Y:	Setpoint influence from 0 to 100 %
X1:	Actual input signal, 60 %
Y1:	Fixed maximum speed in percentage

Pos.	Description
Y2:	Setpoint speed in percentage
Y3:	Actual setpoint speed in percentage
Y4:	User-set minimum speed in percentage

9.18.1 Setpoint influence functions

9.18.1.1 Linear function

The setpoint is influenced linearly from 0 to 100 %.

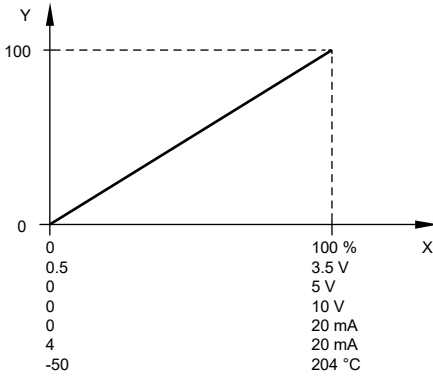

TM070255

Pos.	Description
X:	External input signal from 0 to 100 %
Y:	Setpoint influence from 0 to 100 %

9.18.1.2 Linear with Stop

In the input signal range from 20 to 100 %, the setpoint is influenced linearly. If the input signal is below 10 %, the motor changes to the **Stop** operating mode. If the input signal increases more than 15 %, the operating mode changes back to **Normal**.

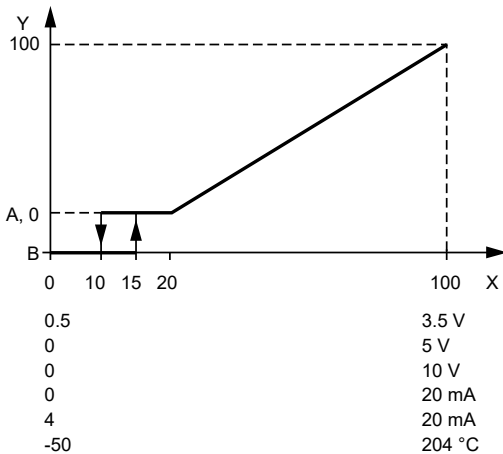

TM070542

Pos.	Description
X:	External input signal from 0 to 100 %
Y:	Setpoint influence from 0 to 100 %
A:	Normal
B:	Stop

9.18.1.3 Influence table

The setpoint is influenced by a curve made of two to eight points. There is a straight line between the points and a horizontal line before the first point and after the last point.

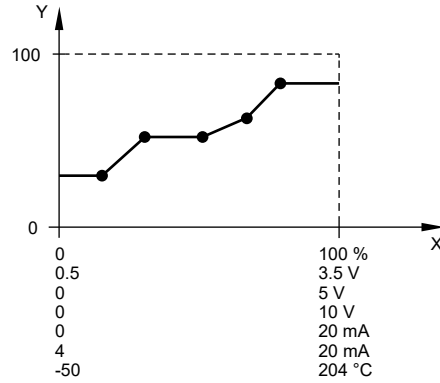

TM070254

Pos.	Description
X:	External input signal from 0 to 100 %
Y:	Setpoint influence from 0 to 100 %

9.19 Predefined setpoints

You can set and activate seven predefined setpoints by combining the input signals with digital inputs 2, 3 and 4 as shown in the table below. Set the digital inputs 2, 3 and 4 to **Predefined setpoints** if all seven predefined setpoints are to be used. You can also set one or two of the digital inputs to **Predefined setpoints**. However, this limits the number of predefined setpoints available.

Digital inputs			Setpoint
2	3	4	
0	0	0	Normal setpoint or Stop
1	0	0	Predefined setpoint 1
0	1	0	Predefined setpoint 2
1	1	0	Predefined setpoint 3
0	0	1	Predefined setpoint 4
1	0	1	Predefined setpoint 5
0	1	1	Predefined setpoint 6
1	1	1	Predefined setpoint 7

0: Open contact
1: Closed contact

Example

The figure shows how you can use the digital inputs to set seven predefined setpoints. Digital input 2 is open, and digital inputs 3 and 4 are closed. If you compare with the table above, you can see that **Predefined setpoint 6** is activated.

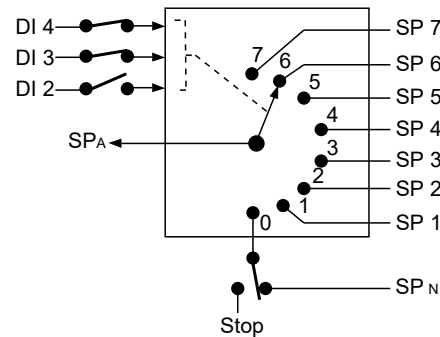

TM070083

Pos.	Description
DI	Digital input
SP	Setpoint
SP _A	Actual setpoint
SP _N	Normal setpoint
Stop	Stop

If all digital inputs are open, the motor stops or runs at the normal setpoint. Set the desired action with Grundfos GO or with the HMI 300 or 301 operating panel.

9.20 Temperature influence

When this function is enabled in proportional- or constant-pressure control mode, the setpoint for head is reduced according to the liquid temperature.

You can set the temperature influence to function at liquid temperatures below 176 °F or 122 °F (80 °C or 50 °C). These temperature limits are called T_{max} . The setpoint is reduced in relation to the head set which is equal to 100 % according to the characteristics below.

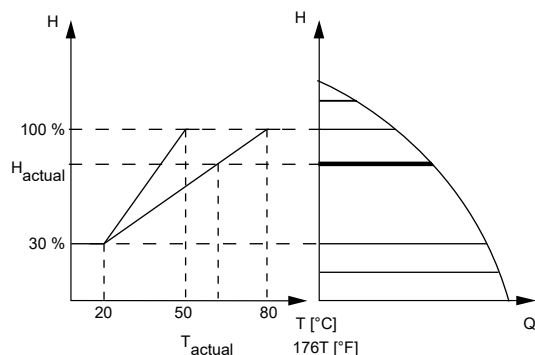

TM057911

Temperature influence

In the above example, T_{max} , which is equal to 176 °F (80 °C), has been selected. The actual liquid temperature, T_{actual} , causes the setpoint for head to be reduced from 100 % to H_{actual} .

The temperature influence function requires the following:

- proportional-pressure or constant-pressure control mode
- pump installed in flow pipe
- system with flow-pipe temperature control.

Temperature influence is suitable for the following systems:

- Systems with variable flow rates, for example two-pipe heating systems, in which the enabling of the temperature influence function ensures a further reduction of the pump performance in periods with small heating demands and consequently a reduced flow-pipe temperature.
- Systems with almost constant flow rates, for example one-pipe heating systems and underfloor heating systems, in which variable heating demands cannot be registered as changes in the head as is the case with two-pipe heating systems. In such systems, you can only adjust the pump performance by enabling the temperature influence function.

Selecting the maximum temperature:

In systems with a dimensioned flow-pipe temperature of up to and including 131 °F (55 °C), select T_{max} , equal to 122 °F (50 °C).

In systems with a dimensioned flow-pipe temperature of above 131 °F (55 °C), select T_{max} , equal to 176 °F (80 °C).

You cannot use the temperature influence function in air-conditioning and cooling systems.

Factory setting

See the section on factory settings.

Related information

[9.58 Factory settings for Grundfos GO](#)

9.21 Limit-exceeded function

Use this function to monitor a measured parameter or one of the internal values such as speed, motor load or motor current. If a set limit is reached, a selected action can take place. You can set two limit-exceeded functions, meaning that you can monitor two parameters or two limits of the same parameter simultaneously.

The function requires setting of the following parameters:

Measured

Set the measured parameter to be monitored.

Limit

Set the limit which activates the function.

Hysteresis band

Set the hysteresis band for when the function must be deactivated again.

Limit exceeded when

Set the function to be activated when the selected parameter exceeds or drops below the set limit.

above limit

The function is activated if the measured parameter exceeds the set limit.

below limit

The function is activated if the measured parameter drops below the set limit.

Action

If the value exceeds a limit, you can set an action. The following actions are available:

Not active

The pump remains in its current state. Use this setting if you only want to activate a signal relay output when the limit is reached.

Stop

The pump stops.

Min.

The pump reduces the speed to minimum speed.

Max.

The pump increases the speed to maximum speed.

User-defined speed

The pump runs at a speed set by the user.

Alarm and Stop

An alarm is given, and the pump stops.

Alarm and Min

An alarm is given, and the pump decreases the speed to a minimum.

Alarm and Max

An alarm is given, and the pump increases the speed to maximum.

Alarm and User-defined speed

An alarm is given, and the pump runs at the speed set by the user.

Detection delay

Setting the detection delay ensures that the monitored parameter stays above or below a set limit in a set time before the function is activated.

Resetting delay

The resetting delay is the time from when the measured parameter differs from the set limit, including the set hysteresis band, and until the function is reset.

Example

The function is to monitor the outlet pressure from the pump. If the pressure is below 5 bar for more than 5 seconds, a warning is indicated. If the pressure is above 7 bar for more than 8 seconds, reset the limitexceeded warning.

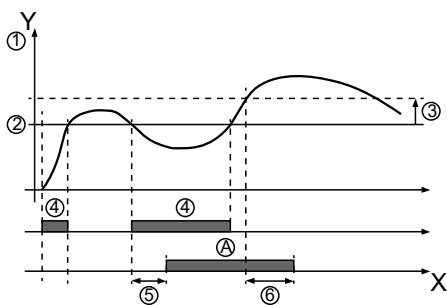

TM070085

X: Time in seconds

Y: Pressure in psi

Pos.	Parameter	Setting
1	Measured	Discharge pressure
2	Limit	72.5 psi (5 bar)
3	Hysteresis band	29 psi (2 bar)
4	Limit exceeded when	below limit
5	Detection delay	5 seconds
6	Resetting delay	8 seconds
A	Limit-exceeded function active	-
-	Action	Warning

9.22 LiqTec (LiqTec function)

Wiring example:

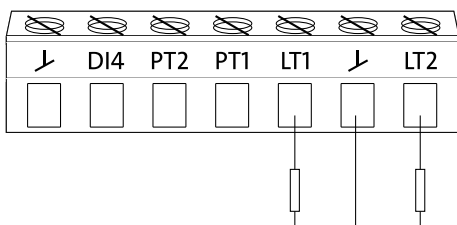

TM083190

LiqTec

LT1	White wire
↘	Brown and black wires
LT2	Blue wire

You can enable the function of the LiqTec sensors in the display. A LiqTec sensor protects the pump against dry running.

The function requires that a LiqTec sensor has been fitted and connected to the pump.

When you have enabled the LiqTec function, it stops the pump if dry running occurs. Restart the pump manually if it has been stopped due to dry running.

Dry-running detection delay

You can set a detection delay to make sure that the pump is given a chance to start up before the LiqTec function stops the pump due to dry running.

Range: 0-254 seconds.

Factory setting

See the section on factory settings.

Related information

[9.58 Factory settings for Grundfos GO](#)

9.23 Stop function (Low-flow stop function)

You can set **Low-flow stop function** to these values:

- **Not active**
- **Energy-optimal mode**
- **High-comfort mode**
- **User-defined mode (Customised operating mode).**

When the low-flow stop function is active, the flow is monitored. If the flow becomes lower than the set minimum flow (Q_{min}), the pump changes from continuous operation at constant pressure to start-stop operation and stops if the flow reaches zero.

The advantages of enabling **Low-flow stop function** are the following:

- no unnecessary heating of the pumped liquid
- reduced wear of the shaft seals
- reduced noise from operation.

The disadvantages of enabling **Low-flow stop function** may be the following:

- The delivered pressure is not completely constant as it fluctuates between the start and stop pressures.
- The frequent starts and stops of the pump may in some applications cause acoustic noise.

The impact of the above disadvantages very much depends on the setting selected for the stop function.

The **High-comfort mode** setting minimises pressure fluctuations and acoustic noise.

Select **Energy-optimal mode** if the main priority is to reduce the energy consumption as much as possible.

Possible settings of the stop function:

- **Energy-optimal mode** The pump automatically adjusts the parameters for the stop function so that the energy consumption during the start-stop operation period is minimised. In this case, the stop function uses the factory-set values of the minimum flow (Q_{min1}) and other internal parameters. See the figure below.
- **High-comfort mode:** The pump automatically adjusts the parameters for the stop function so that the disturbances during the start-stop operation period are minimised. In this case, the stop function uses the factory-set values of the minimum flow (Q_{min2}) and other internal parameters. See the figure below.
- **User-defined mode (Customised operating mode):** The pump uses the parameters set for ΔH and minimum flow (Q_{min3}) respectively for the stop function. See the figure below.

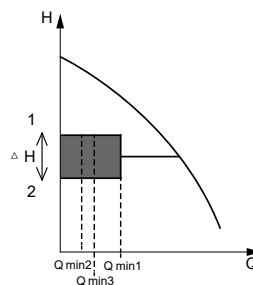

TM064267

Difference between start and stop pressures (ΔH) and minimum flow rate

Pos.	Description
1	Stop pressure
2	Start pressure

In start-stop operation, the pressure varies between the start and stop pressures. See the figure above.

In **User-defined mode (Customised operating mode)**, ΔH has been factory-set to 10 % of the actual setpoint. ΔH can be set within the range from 5 to 30 % of the actual setpoint.

The pump changes to start-stop operation if the flow becomes lower than the minimum flow rate.

The minimum flow rate is set in percentages of the nominal flow rate of the pump. See the pump nameplate.

In **User-defined mode (Customised operating mode)**, the minimum flow rate has been factory-set to 10 % of the nominal flow rate.

Factory setting

See the section on factory settings.

Low-flow stop function

A low flow can be detected in two ways:

1. A built-in low-flow detection function which is active if none of the digital inputs are set for flow switch.
 - Low-flow detection function: The pump checks the flow regularly by reducing the speed for a short time. If there is no or only a small change in pressure, this means that there is low flow. The speed is increased until the stop pressure (actual setpoint + $0.5 \times \Delta H$) is reached and the pump stops. When the pressure has fallen to the start pressure (actual setpoint - $0.5 \times \Delta H$), the pump restarts.
 - If the flow rate is higher than the set minimum flow rate, the pump returns to continuous operation at constant pressure.
 - If the flow rate is still lower than the set minimum flow rate (Q_{min}), the pump continues in start-stop operation until the flow rate is higher than the set minimum flow rate (Q_{min}). When the flow rate is higher than the set minimum flow rate (Q_{min}), the pump returns to continuous operation.
2. A flow switch connected to one of the digital inputs.
 - Flow switch: When the digital input is activated for more than 5 seconds because there is low flow, the speed is increased until the stop pressure (actual setpoint + $0.5 \times \Delta H$) is reached, and the pump stops. When the pressure has fallen to start pressure, the pump restarts. If there is still no flow, the pump quickly reaches the stop pressure and stops. If there is flow, the pump continues operating according to the setpoint.

Operating conditions for the low-flow stop function

You can only use the stop function if the system incorporates a pressure sensor, a non-return valve and a diaphragm tank.

! Always install the non-return valve before the pressure sensor.

See the figures below.

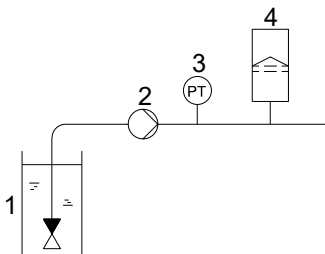

Position of the non-return valve and pressure sensor in system with suction lift operation

TM0385821

Pos.	Description
1	Non-return valve
2	Pump
3	Pressure sensor
4	Diaphragm tank

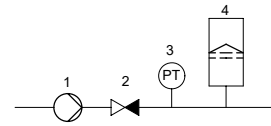

Position of the non-return valve and pressure sensor in a system with a positive inlet pressure

TM038583

Pos.	Description
1	Pump
2	Non-return valve
3	Pressure sensor
4	Diaphragm tank

Set minimum flow

Set the minimum flow rate (Q_{min}) in this display. This setting determines at which flow rate the system is to change from continuous operation at constant pressure to start-stop operation. The setting range is 5 to 30 % of the rated flow rate.

Factory setting

See the section on factory settings.

Related information

[9.58 Factory settings for Grundfos GO](#)

9.23.1 Diaphragm tank volume

Diaphragm tank volume

The stop function requires a diaphragm tank of a certain minimum size. Set the size of the installed tank in this display.

To reduce the number of start-stops per hour or to reduce the ΔH , install a larger tank.

Install the tank immediately after the pump. The precharge pressure must be $0.7 \times$ actual setpoint.

Recommended diaphragm tank size:

CRE pump	Typical diaphragm tank size [gal (liters)]
1s, 1, 3, 5	2 (8)
10	4.4 (17)
15, 20	10.3 (39)
32	14 (53)
45	20 (76)
64	34 (129)
95	44 (167)
125	62 (235)
155	81 (307)

Factory setting

See the section on factory settings.

Related information

[9.58 Factory settings for Grundfos GO](#)

9.24 Stop at min. speed

This stop function can be utilised in for example constant level applications where a boost of pressure is not needed. It is a different type of stop function than low-flow stop but the purpose is the same. The pump stops if there is no or low consumption.

This function monitors the speed of the pump. When the PI-controller has forced the speed of the pump to minimum according to the feedback value, the pump stops after a set period of time. It remains stopped until the feedback value starts to drop and the PI-controller starts the pump again.

- **Enable Stop at min. speed**
Enables the function **Stop at min. speed**.
- **Delay**
The delay time the pump must be running at minimum speed before it stops.
- **Restart speed**
Speed in percentage when the pump must start again, hysteresis. It must be set higher than the minimum speed of the pump.

9.25 Pipe filling function

This function is typically used in pressure-boosting applications and ensures a smooth startup of systems with for instance empty pipes. Startup takes place in two phases. See the figure below.

1. Filling phase. The pipes are slowly filled with water. When the pressure sensor of the system detects that the pipes have been filled, phase two begins.
2. Pressure build-up phase. The system pressure is increased until the setpoint is reached. The pressure build-up takes place over a pressure build-up time. If the setpoint is not reached within a given time, a warning or an alarm can be given, and the pumps can be stopped at the same time.

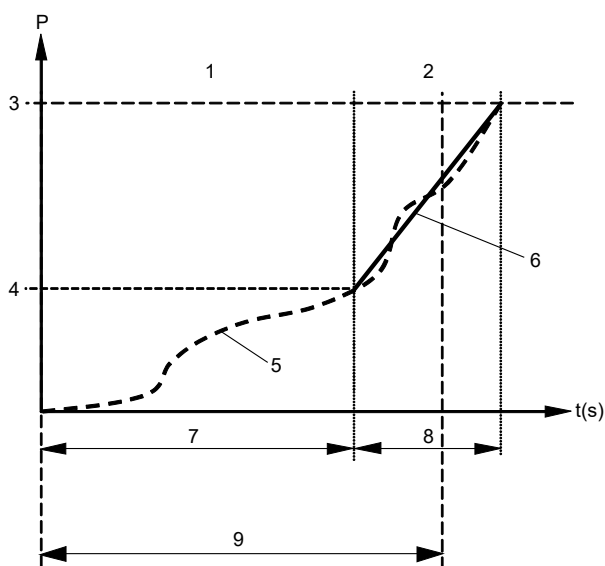

TM039037

Filling and pressure build-up phases

Pos.	Description
1	Filling phase (constant-curve operation)
2	Pressure build-up phase (constant-pressure operation)
3	Setpoint
4	Filling pressure
5	Actual value
6	Setpoint ramp-up
7	Filling time

Pos.	Description
8	Pressure build-up time
9	Maximum filling time
P	Pressure
t(s)	Time (sec)

Setting range

- **Filling speed.** Fixed speed of the pump during the filling phase.
- **Filling pressure.** The pressure that the pump must reach before the maximum filling time.
- **Max. filling time.** The time in which the pump must reach the filling pressure.
- **Max. time reaction.** Reaction of the pump if the maximum filling time is exceeded:
 - warning
 - alarm (pump stops).
- **Pressure build-up time.** Ramp time from when the filling pressure is reached until the setpoint must be reached.



When you activate this function, the function always starts when the pump has been in operating mode **Stop** and is changed to **Normal**.

Factory setting

See the section on factory settings.

Related information

[9.58 Factory settings for Grundfos GO](#)

9.26 Pulse flowmeter (Pulse flowmeter setup)

You can connect an external pulse flowmeter to one of the digital inputs in order to register the actual and accumulated flows. Based on this, you can also calculate the specific energy.

To enable a pulse flowmeter, set one of the digital-input functions to **Accumulated flow** and set the pumped volume per pulse.

Factory setting

See the section on factory settings.

Related information

[9.12 Digital inputs](#)

[9.58 Factory settings for Grundfos GO](#)

9.27 Ramps

The ramps determine how quickly the product can accelerate and decelerate during start and stop or setpoint changes.

You can make the following settings:

- acceleration time, 0.1 to 300 s
- deceleration time, 0.1 to 300 s.

The times apply to the acceleration from 0 rpm to a fixed maximum speed and the deceleration from a fixed maximum speed to 0 rpm, respectively.

At short deceleration times, the deceleration of the product may depend on load and inertia as there is no possibility of actively braking the product.

If the power supply is switched off, the deceleration of the product only depends on the load and inertia.

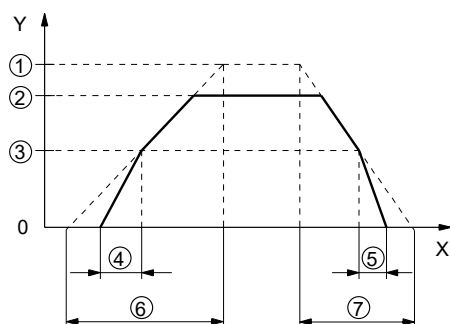

TM069798

Pos.	Description
Y	Speed
X	Time
1	Fixed maximum
2	User-set maximum
3	User-set minimum
4	Fixed initial ramp
5	Fixed final ramp
6	Ramp time up
7	Ramp time down

9.28 Direction of rotation

Use this function to select the desired direction of motor rotation when looking at the motor shaft end from the drive side.

- clockwise
- counterclockwise

The displayed direction of rotation applies when the digital inputs for reversing the rotation are not active.

9.29 Skip band

Use this function to select a skip band within the range from user-set minimum speed to user-set maximum speed if continuous operation is not required. The upper and lower speeds are stated in percentage of rated speed.

The purpose of the skip band is to avoid certain speeds which may cause noise or vibrations. If no skip band is required, select -.

9.30 Standstill heating

Use this function to avoid condensation in humid environments.

When you set the function to **Active** and the product is in operating mode **Stop**, a low AC voltage is applied to the motor windings. The voltage is not high enough to make the motor rotate, but ensures that sufficient heat is generated to avoid condensation in the product, including the electronic parts in the drive.



Remember to remove the drain plugs and fit a cover over the product.

9.31 Alarm handling

This setting determines how the pump must react in case of a sensor failure.

Alarm or warning types:

- **Warning**
A warning. There is no change in the operating mode.
- **Stop**
The pump stops.
- **Min.**
The pump reduces the speed to minimum.
- **Max.**

The pump increases the speed to maximum.

- **User defined speed**

The pump runs at the speed set by the user.

Affected inputs:

- **Analog input 1**
- **Analog input 2**
- **Analog input 3**
- **Built-in Grundfos sensor**
- **Pt100/1000 input 1**
- **Pt100/1000 input 2**
- **Liqtec input.**

9.32 Motor bearing monitoring

Use this function to select whether or not you want to monitor the motor bearings.

You can make the following settings:

- **Active**
- **Not active**

When the function is set to **Active**, a counter in the controller starts counting the running hours of the bearings. The running hours are calculated on the basis of the motor speed. When a predefined limit is reached, a warning indicates that the bearings must be replaced or relubricated.



If you change the function to **Not active**, the counter continues to count. However, no warning is given when it is time to replace the bearings. If you change the function to **Active** again, the accumulated running hours are used to recalculate the replacement time.

9.33 Service intervals



Motor bearing monitoring must be activated in order for the motor to indicate that the bearings must be replaced or relubricated. See the section on motor bearing monitoring.

For motors of 10 HP (7.5 kW) and below, it is not possible to relubricate the bearings.

9.33.1 Time to next service (Motor bearing service)

This display shows when to replace the motor bearings. The controller monitors the operating pattern of the motor and calculates the period between bearing replacements.

Displayable values:

- **in 2 years**
- **in 1 year**
- **in 6 months**
- **in 3 months**
- **in 1 month**
- **in 1 week**
- **Now!**

9.33.2 Bearing replacements

The display shows the number of bearing replacements made during the lifetime of the motor.

9.33.3 Bearings replaced (Motor bearing maintenance)

When the bearing monitoring function is active, a warning is given when the motor bearings must be replaced.

1. When you have replaced the motor bearings, press **Bearings replaced**.

9.33.4 Bearings relubricated

When the bearing monitoring function is active, a warning is given when the motor bearings must be relubricated.



Bearings can be relubricated 5 times before they must be replaced.



The amount of grease can be found on the bearing nameplate on the motor.

- When you have relubricated the bearings, press **Bearings relubricated**.

9.34 Communication

Use this function to set the communication of the product, both wired and wireless communication. The product contains built-in fieldbus protocols on the AYB terminals (RS-485).

9.34.1 Pump number

Use this function to allocate a unique number to the pump. This makes it possible to distinguish between pumps in connection with GENIbus communication.

9.34.2 Enable/disable radio comm.

Use this function to set the radio communication to **Enabled** or **Disabled**. Select **Disabled** in areas where radio communication is not allowed.



Bluetooth communication remains active.

9.34.3 Enable/disable Bluetooth comm.

Use this function to set the Bluetooth communication to **Enabled** or **Disabled**. Select **Disabled** in areas where Bluetooth communication is not allowed.



Radio communication remains active.

9.34.4 Initiate Bluetooth connection

Use this function if Grundfos GO is installed on Huawei smartphones with BLE version 5.0 or older. This function is used to establish a Bluetooth connection to Grundfos GO. Open the Grundfos GO app on your device and select **Initiate Bluetooth connection**. Then select **Yes** and follow the instructions on the device.

9.34.5 Setup of AYB terminals

9.34.5.1 Protocol selection

Use this function to select which fieldbus protocol that must be active on the AYB terminals (RS-485).

Select between the following:

- Modbus RTU
- GENIbus.

9.34.5.2 Modbus RTU settings

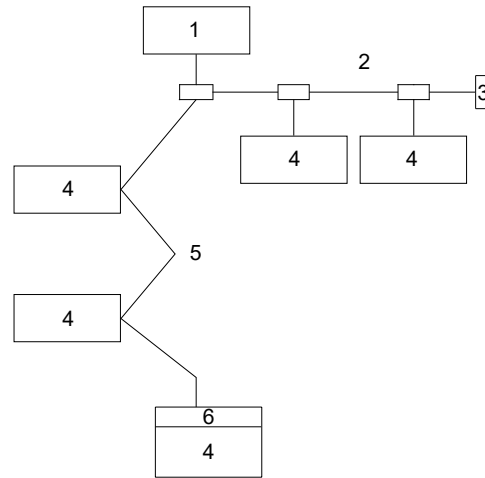

Example of Modbus network with termination

Pos.	Description
1	Master
2	Passive tap
3	Line termination
4	Slave
5	Daisy chain
6	BLT (BLT = Built-in line termination (dip switch))



Remember to set the AYB BUS termination dip switch to ON in case the pump is the first or the last pump on a daisy chain of pumps. The termination resistor has a value of 150 ohm.

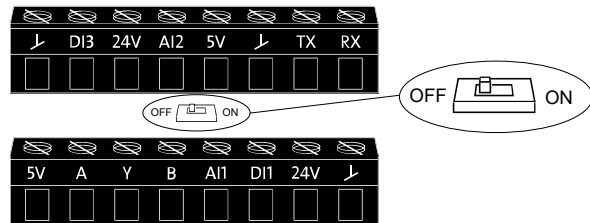

Modbus RTU address

Use this function to allocate a unique number to the pump. This makes it possible to distinguish between pumps in connection with Modbus RTU communication.

Select a number between 1 and 247.

Baud rate

Use this function to select the baud rate at which Modbus RTU is to communicate.

Select between the following baud rates:

- 9600 bps
- 19200 bps
- 38400 bps
- 115200 bps.

Parity

Use this function to set the parity of the Modbus RTU channel.

Select between these values:

- None

TM083380

TM083381

- Odd
- Even.

Stop bits

Use this function to set the number of stop bits on the Modbus RTU channel.

Select between these values:

- 1 bit
- 2 bits.

9.34.6 Setup of Ethernet



The product is equipped with an Ethernet port with a GENI GDP protocol that can be accessed from Grundfos iSOLUTION Cloud and other cloud based solutions.

Grundfos will support the product with security updates for at least 2 years from production of the unit.

9.34.6.1 IP Settings

Use this function to set the Ethernet communication.

9.34.6.2 DHCP

Use this function to select if DHCP should be activated or deactivated.

If activated, the E-pump will receive network configuration from the DHCP server on the network.

If deactivated, IP address, Subnet mask, Gateway and Primary DNS must be configured manually.

9.34.6.3 IP address

Use this function to manually set the IP address. IP address format:

Example: 192.168.0.10

9.34.6.4 Subnet mask

Use this function to manually set the subnet mask. Subnet mask format:

Example: 255.255.255.0

9.34.6.5 Gateway

Use this function to manually set the gateway address. Gateway address format:

Example: 192.168.1.1

9.34.6.6 Primary DNS

Use this function to manually set the primary DNS address.

Example of primary DNS address format: 8.8.8.8

9.34.6.7 Secondary DNS

Use this function to manually set the secondary DNS address.

Example of secondary DNS address format: 4.4.4.4

9.35 Language

The function is only available in the HMI 300 and 301 operating panels.

Use this function to select the desired language from the list.

9.36 Date and time (Set date and time)

The function is only available in the HMI 300 and 301 operating panels.

Use this function to set the date and time as well as how you want them to be viewed in the display.

- **Select date format**
 - YYYY-MM-DD
 - DD-MM-YYYY
 - MM-DD-YYYY
- **Select time format**
 - HH:MM 24-hour clock
 - HH:MM am/pm 12-hour clock
- **Set date**

- **Set time.**

9.37 Unit configuration (Units)

The function is only available in the HMI 300 and 301 operating panels.

Use this function to select SI or US units. You can make the setting for all parameters or customize for each individual parameter.

9.38 Buttons on product (Enable/disable settings)

Use this function to disable the option to make settings for protective reasons.

- If you use Grundfos GO and set the buttons to **Not active**, the buttons on the HMI 200 or 201 operating panel are disabled, except the **Radio communication** button.
- If you disable the buttons on pumps fitted with the HMI 300 or 301 operating panel via **Enable/disable settings**, you can still use the buttons to navigate through the menus but you cannot make changes directly on these operating panels. A lock symbol appears in the display. However, you can unlock the motor temporarily and allow settings by pressing the **Up** and **Down** buttons simultaneously for at least 5 seconds.

9.39 Delete history

The function is only available in the HMI 300 and 301 operating panels.

Use this function to delete the following historical data:

- **Delete operating log**
- **Delete energy consumption.**

9.40 Define Home display

The function is only available in the HMI 300 and 301 operating panels.

Set the **Home** display to show up to four user-defined parameters.

9.41 Display settings

The function is only available in the HMI 300 or 301 operating panels.

Use this function to adjust the display brightness. You can also set whether or not the display is to switch off if no buttons have been activated for a period of time.

9.42 Store settings (Store actual settings)

Use this function to store the current settings to enable the user to go back to a previous set of settings.

9.43 Recall settings (Recall stored settings)

Grundfos GO

In this menu, you can recall stored settings from a number of previously stored settings that the pump then uses.

Advanced operating panel

In this menu, you can recall the last stored settings that the pump will then use.

9.44 Undo

The function is only available in Grundfos GO.

Use this function to undo all settings made with Grundfos GO in the current communication session. Once you have recalled settings, you cannot undo.

9.45 Pump name

The function is only available in Grundfos GO.

Use this function to give the motor a name. The selected name then appears in Grundfos GO.

9.46 Connection code

Use the connection code to enable automatic connection between Grundfos GO and the product. Thus, you do not need to press **OK** or the **Radio communication** button each time.

You can also use the connection code to restrict remote access to the product.

You can only set the connection code with Grundfos GO.

9.46.1 Setting a connection code in the product by using Grundfos GO

1. Connect Grundfos GO to the product.
2. Go to **Settings > General > Connection code**.
3. Enter a connection code and press **OK**.
You can change the code in the **Connection code** menu at any time. The old code is not required.

9.47 Run start-up guide

The function is only available in the HMI 300 and 301 operating panels.

The startup guide automatically starts when you start the product for the first time. You can always run the startup guide later. The startup guide guides you through the general settings of the product.

To run the startup guide, go to **Settings > General settings > Run start-up guide**.

9.48 Alarm log

This function contains a list of logged alarms from the product. The log shows the alarm code, name of the alarm, when the alarm occurred and when the alarm was reset.

9.49 Warning log

This function contains a list of logged warnings from the product. The log shows the warning code, name of the warning, when the warning occurred and when the warning was reset.

9.50 Assist

This menu consists of a number of different assist functions.

Assist functions are small guides that take you through the steps needed to set the product.

9.51 Assisted pump setup

This function guides you through the following:

Setting the motor

- Selection of control mode
- Configuration of feedback sensors
- Adjustment of the setpoint
- Controller settings
- Summary of settings.

With Grundfos GO, access the **Assisted pump setup** menu.

With the HMI 300 or 301 operating panel, access the **Assisted pump setup** menu.

9.52 Setup, analog inputs

This function is only available in the HMI 300 and 301 operating panels.

- **Analog inputs**, follow on-screen instructions.
- **Pt100/1000 inputs**, follow on-screen instructions.

9.53 Setting of date and time

The function is only available in the HMI 300 and 301 operating panels.

The inputs and outputs available depend on the functional module fitted in the motor.

Functional module	Setting of date and time
FM310	•
FM311	•

The function guides you through the following settings:

- **Select date format**

- **Set date**
- **Select time format**
- **Set time.**

9.54 Multipump function

The function **Multi-pump function** enables the control of two motors connected in parallel without the use of external controllers. The pumps or motors in a system communicate with each other via the wireless GENIair connection or the wired GENI connection.

You can set a multipump system via the master motor, which is the first selected motor.

If several pumps or motors in the system have sensors, they can all function as the master and take over the master function if the other fails. This provides additional redundancy in the multimotor system.

You can choose between the following multimotor functions:

Alternating operation

Alternating operation functions as a duty and standby operating mode and is possible with two pumps or two motors of the same size and type connected in parallel. The main purpose of the function is to ensure an even amount of running hours and to ensure that the other pump or motor starts if the duty pump or motor stops due to an alarm.

You can choose between two alternating operating modes:

- **Alternating operation, time**

The change from one pump or motor to the other is based on time.

- **Alternating operation, energy**

The change from one pump or motor to the other is based on energy consumption.

If the duty pump or motor fails, the other pump or motor starts.

Backup operation

Backup operation is possible with two motors of the same size and type connected in parallel. One motor is operating continuously.

The backup motor is operated for a short time each day to prevent seizing up. If the duty motor stops due to a fault, the backup motor starts.

Cascade operation

This function is available with up to 4 motors installed in parallel. The motors must be of the same size and if used with pumps, the pumps must be of the same model.

- The performance is adjusted to the demand through cutting pumps in or out and through parallel control of the pumps in operation.
- The controller maintains a constant process value through continuous adjustment of the speed of the pumps.
- Pump changeover is automatic and depends on load, operating hours and fault detection.
- All pumps in operation run at the same speed.
- The number of pumps in operation also depends on the energy consumption of the pumps. If only one pump is required, two pumps will run at a lower speed if this results in a lower energy consumption.
- If several pumps or motors in the system have a sensor, they can all function as the master and take over the master function if the other fails.

9.54.1 Alternating operation, time

The **Alternating operation, time** menu sets the interval of alternation between two pumps.

This setting is only available in alternating mode.

9.54.2 Time for pump changeover

The **Time for pump changeover** menu sets the time of day for pump changeover to take place.

This setting is only available in alternating operation.

9.54.3 Sensor to be used

This function defines the sensor to be used for controlling the pump system.

Select **Master pump sensor** if the sensor is placed in a way where it can measure the output from all the pumps in the system, for example in the manifold.

Select **Running pump sensor** if the sensor is placed on or across individual pumps. For example if the sensor is installed behind non-return valves, and if it is not able to measure the output from all pumps.

This setting is only available in alternating operation and cascade operation.

9.54.4 Ways to set a multipump system

You can set a multipump system in the following ways:

- Grundfos GO and wireless motor connection.
- Grundfos GO and wired motor connection.
- HMI 300 or 301 operating panel and wireless motor connection.
- HMI 300 or 301 operating panel and wired motor connection.

9.54.4.1 Setting a multipump system with Grundfos GO and a wireless motor connection

1. Power on both motors.
2. Establish contact to one of the motors with Grundfos GO.
3. Set the needed analog and digital inputs via Grundfos GO according to the connected equipment and the required functionality.
4. Assign a name to the motor using Grundfos GO.
5. Disconnect Grundfos GO from the motor.
6. Establish contact to the other motor.
7. Set the needed analog and digital inputs via Grundfos GO according to the connected equipment and the required functionality.
8. Assign a name to the motor using Grundfos GO.
9. Select the **Assist** menu and **Setup of multi-pump system**.
10. Select the desired multimotor function.
11. Press the **Right** button to continue.
12. Set the time at which the alternation between the two motors is to take place.



This step applies only if you have selected **Alternating operation, time** and if the motors are fitted with FM310 or FM311.

13. Press the **Right** button to continue.
14. Select **Radio** as the communication method to be used between the two motors.
15. Press the **Right** button to continue.
16. Select pump 2 (motor 2).
17. Select the pump from the list.



Use **OK** or the **Radio communication** button to identify the pump.

18. Press the **Right** button to continue.
19. Confirm the setting by pressing **Send**.
20. When you have finished the setup and the dialog box disappears, wait for the green indicator light in the middle of **Grundfos Eye** to light up.

9.54.4.2 Setting a multipump system with Grundfos GO and a wired motor connection

1. Connect the two motors with each other with a 3-core screened cable between the GENibus terminals A, Y, B.

2. Power on both motors.
3. Establish contact to one of the motors with Grundfos GO.
4. Set the required analog and digital inputs via Grundfos GO according to the connected equipment and the required functionality.
5. Assign a name to the motor using Grundfos GO.
6. Assign motor number 1 to the motor.
7. Disconnect Grundfos GO from the motor.
8. Establish contact to the other motor.
9. Set the analog and digital inputs according to the connected equipment and the required functionality by means of Grundfos GO.
10. Assign a name to the motor using Grundfos GO.
11. Assign motor number 2 to the motor.
12. Select the **Assist** menu and **Setup of multi-pump system (multimotor setup)**.
13. Select the desired multimotor function.
14. Press the **Right** button to continue.
15. Set the time at which the alternation between the two motors is to take place.



This step applies only if you have selected **Alternating operation, time** and if the motors are fitted with FM310 or FM311.

16. Press the **Right** button to continue.
17. Select **Bus** as the communication method to be used between the two motors.
18. Press the **Right** button to continue.
19. Select pump 2 (motor 2).
20. Select the additional motor from the list.



Use **OK** or the **Radio communication** button to identify the pump.

21. Press the **Right** button to continue.
22. Confirm the setting by pressing **Send**.
23. When you have finished the setup and the dialog box disappears, wait for the green indicator light in the middle of **Grundfos Eye** to light up.

9.54.4.3 Setting a multipump system with the HMI 300 or 301 operating panel and a wireless motor connection

1. Power on both motors.
2. On both motors, set the analog and digital inputs according to the connected equipment and the required functionality.
3. Select the **Assist** menu on one of the motors and **Setup of multi-pump system**.
4. Press the **Right** button to continue.
5. Select **Wireless** as the communication method to be used between the two motors.
6. Press the **Right** button to continue.
7. Select the desired multimotor function.
8. Press the **Right** button three times to continue.
9. Press **OK** to search for other motors.
The green indicator light in the middle of **Grundfos Eye** flashes on the other motors.

10. Press **OK** or the **Radio communication** button on the motor which is to be added to the multimotor system.
11. Press the **Right** button to continue.
12. Set **Time for pump changeover**.
This is the time at which the alternation between the two motors is to take place.



This step applies only if you have selected **Alternating operation, time** and if the motors are fitted with FM310 or FM311.

13. Press the **Right** button to continue.
14. Press **OK** to confirm the setting.
The multipump function icons appear at the bottom of the operating panels.

9.54.4.4 Setting a multipump system with the HMI 300 or 301 operating panel and a wired motor connection

1. Connect the two motors with each other with a 3-core screened cable between the GENIbus terminals A, Y, B.
2. Set the needed analog and digital inputs according to the connected equipment and the required functionality.
3. Assign motor number 1 to the first motor.
4. Assign motor number 2 to the other motor.
5. Select the **Assist** menu on one of the motors and **Setup of multi-pump system**.
6. Press the **Right** button to continue.
7. Select **Wired GENIbus** as the communication method to be used between the two motors.
8. Press the **Right** button twice to continue.
9. Select the desired multimotor function.
10. Press the **Right** button to continue.
11. Press **OK** to search for other motors.
12. Select the additional motor from the list.
13. Press the **Right** button to continue.
14. Set **Time for pump changeover**.
This is the time at which the alternation between the two motors is to take place.



This step applies only if you have selected **Alternating operation, time** and if the motors are fitted with FM310 or FM311.

15. Press the **Right** button to continue.
16. Press **OK** to confirm the setting.
The multipump function icons appear at the bottom of the operating panels.

9.54.5 Disabling a multipump system with Grundfos GO

1. Go to **Assist**.
2. Select **Multi-pump setup** and press **Disable**.
3. Press the **Right** button to continue.
4. Confirm the setting by pressing **Send**.
5. Press **Finish**.

9.54.6 Disabling a multipump system with the HMI 300 or 301 operating panel

1. Go to **Assist**.
2. Select **Setup of multi-pump system**.
3. Press the **Right** button to continue.

4. Press **OK** to confirm **Disable**.
5. Press the **Right** button to continue.
6. Press **OK** to confirm.

9.55 Description of control mode

The function is only available in the HMI 300 and 301 operating panels.

The function describes each of the control modes available for the product.

9.56 Assisted fault advice

This function provides guidance and corrective actions in the event of product failure.

9.57 Priority of settings

With Grundfos GO, you can set the motor to operate at maximum speed or to stop.

If two or more functions are enabled at the same time, the motor operates according to the function with the highest priority.

If you have set the motor to maximum speed via the digital input, the motor operating panel or Grundfos GO can only set the motor to **Manual** or **Stop**.

The priority of the settings appears from the table below:

Priority	Start/stop button	Grundfos GO or operating panel on motor	Digital input	Bus communication
1	Stop			
2		Stop ¹²⁾		
3		Manual		
4		Maximum speed / User defined speed ¹²⁾		
5			Stop	
6			User defined speed	
7				Stop
8				Maximum speed / User defined speed
9				Minimum speed
10				Start
11			Maximum speed	
12		Minimum speed		
13			Minimum speed	
14			Start	
15	Start			

¹²⁾ **Stop** and **Maximum speed** settings made with Grundfos GO or on the motor operating panel can be overruled by another operating-mode command sent from a bus, for example **Start**. If the bus communication is interrupted, the motor resumes its previous operating mode, for example **Stop**, that was selected with Grundfos GO or the motor operating panel.

9.58 Factory settings for Grundfos GO

Settings	With factory-fitted sensor	Without factory-fitted sensor
Setpoint	75 % of sensor range	75 % speed
Operating mode	Normal	Normal
Set user-defined speed	67 %	67 %
Control mode	Constant pressure	Constant curve
Pipe-filling function	Not active	Not active
Buttons on product	Active	Active
Stop function (Low-flow stop function)	Not active	Not active
Controller	Kp: 0.5 Ti: 0.5	Kp: 0.5 Ti: 0.5
Operating range	25-100 %	25-100 %
Ramps	Ramp-up time: 1 s Ramp-down time: 3 s	Ramp-up time: 1 s Ramp-down time: 3 s
Number	1	1
Radio communication	Activated	Activated
Analog input 1	4-20 mA	Not active
Analog input 2	Not active	Not active
Analog input 3	Not active	Not active
Pt100/1000 input 1	Not active	Not active
Pt100/1000 input 2	Not active	Not active
Digital input 1	Ext. stop	Ext. stop
Digital input 2	Not active	Not active
Digital input/output 3	Not active	Not active
Digital input/output 4	Not active	Not active
Pulse flowmeter (Pulse flowmeter setup)	-	-
Predefined setpoint	0 psi (0 bar)	0 %
Analog output	Speed/0-10 V	Speed/0-10 V
External setpoint funct.	Not active	Not active
Signal relay 1	Alarm	Alarm
Signal relay 2	Ready	Ready
Limit 1 exceeded	Not active	Not active
Limit 2 exceeded	Not active	Not active
LiqTec (LiqTec function)	Not active	Not active
Detection delay	10 seconds	10 seconds
Standstill heating	Not active	Not active
Motor bearing monitoring	Not active	Not active
Pump name	-	-
Connection code	-	-
Unit configuration (Units)	SI	SI

10. Servicing the product

WARNING

Electric shock

Death or serious personal injury

- Switch off the power supply to the product including the power supply for the signal relays. Wait at least 5 minutes before you make any connections in the terminal box. Make sure that the power supply cannot be switched on accidentally.
- Tighten the cable glands to the recommended torques.
- For measuring power supply voltage, use the measuring points accessible through the holes on the cover for power cables.
- Follow the instructions in the service instructions for the motor. If parts are damaged, order new service kits.
- Connect the motor to protective earth and provide protection against indirect contact in accordance with local regulations.
- After servicing the motor, a dielectric strength test must be performed. Alternatively, a megger can be used at 500 VDC.



WARNING

Rotating parts

Death or serious personal injury

- Stay clear of the product after switching on power, as the shaft can rotate immediately.
- Do not start up and run the motor if there is no pump connected to it.
- Install the coupling guards securely to the pump with the screws intended for this purpose.
- Tighten the coupling screws to the correct torque.



WARNING

Magnetic field

Death or serious personal injury

- Do not handle the motor or rotor if you have a pacemaker.



WARNING

Crushing of hands

Death or serious personal injury

- Follow the instructions in the service instructions for the motor.
- Wear protective gloves when servicing the product.
- Be careful when handling magnetised parts to avoid personal injury.



WARNING

Falling objects

Death or serious personal injury

- Follow the lifting instructions for the product.
- Use lifting equipment rated for the weight of the product.



WARNING

Back injury

Death or serious personal injury

- Use lifting equipment and follow local regulations when lifting the product.



WARNING

Crushing of feet

Death or serious personal injury

- Wear safety shoes.
- When lifting the motor, attach lifting equipment to the eye bolts fitted to the motor. When lifting the terminal box, attach lifting equipment to the eye bolts or lifting brackets fitted to the terminal box.



WARNING

Hot surface

Death or serious personal injury

- Do not touch the product while it is running. Allow surfaces to cool before servicing.



WARNING

Intoxication or risk of chemical burn

Death or serious personal injury

- The battery can cause severe or fatal injuries in 2 hours or less if it is swallowed or placed inside any part of the body. In such an event, seek medical attention immediately.
- The replacement or servicing of batteries must be carried out by a qualified person.
- The battery contained within this product, whether new or used, is hazardous and is to be kept away from children.



CAUTION

Sharp element

Minor or moderate personal injury

- When servicing the product, wear protective gloves to avoid cutting your hands on sharp edges.



CAUTION

Cold surface

Minor or moderate personal injury

- Make sure that no one can accidentally come into contact with cold surfaces. Wear protective gloves.



Do not remove the rotor from the motor.



Make sure to fill the pump with water before the power is switched on. Follow the instructions for the pump.

Related information

[3.3 Lifting the product](#)

[13.4.7 Torques](#)

10.1 Maintenance

10.1.1 Cleaning the product

WARNING

Electric shock

Death or serious personal injury



- Switch off the power supply to the product including the power supply for the signal relays. Make sure that the power supply cannot be switched on accidentally.
- Check that the terminal box cover is intact before spraying water or chemicals on the product.
- Cleaning must be done with non-aggressive materials to avoid damage to surfaces and labels.
- Make sure that the air inlets are kept clean and free of residuals.



Do not expose the product to high-pressure water jets.

To clean the motor, follow the procedure below:

1. Let the motor cool down first to avoid condensation.
2. Spray it with cold water, and use only non-aggressive cleaning materials.

11. Taking the product out of operation

WARNING

Electric shock

Death or serious personal injury



- Switch off the power supply and make sure that it cannot be accidentally switched on. The power supply must be switched off for at least five minutes before you start working on the product.

WARNING

Back injury

Death or serious personal injury



- Use lifting equipment and follow local regulations when lifting the product.



The lifting eyes on the motor can be used for lifting the pump as well.



For lifting instructions, see the related installation and operating instructions for the pump.

Related information

[1.1 Related instructions](#)

12. Fault finding

WARNING

Electric shock



Death or serious personal injury

- Switch off the power supply before you start any work on the product.
- Make sure that the power supply cannot be switched on accidentally.



For information on fault finding, see the related installation and operating instructions for the pump.

Related information

[1.1 Related instructions](#)

[6.11 Signal relays](#)

[8.6 Grundfos Eye](#)

12.1 Fault and warning signals

The fault indication below can be read by means of the number in brackets, as text or as status indications on the operating panel, depending on the equipment available.

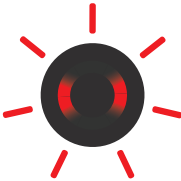
Grundfos Eye	Cause	Remedy
 <p>Two opposite red indicator lights flashing simultaneously. (Alarm indication)</p>	External fault (3) An external signal has reported an external fault to the digital input set for this function.	<ul style="list-style-type: none"> • Check the parameter or the unit reporting the external fault. • Correct the fault.
	Too many restarts (4) The pump has restarted too many times in connection with a fault that forced the pump to stop and restart automatically.	<ul style="list-style-type: none"> • Check the warning and alarm log for faults that caused too many restarts. • Replace the pump if the fault cannot be found.
	Overvoltage (32) The supply voltage to the pump is too high.	<ul style="list-style-type: none"> • Make sure that the power supply is within the specified range.
	Undervoltage (40) The supply voltage to the pump is too low.	<ul style="list-style-type: none"> • Make sure that the power supply is within the specified range.
	Undervoltage transient from mains supply (41) The supply voltage to the pump shows signs of voltage drops.	<ul style="list-style-type: none"> • Make sure that the power supply is within the specified range and check power quality.
	Overload (49) The motor is overloaded and has automatically reduced the speed and thus the pump performance.	<ul style="list-style-type: none"> • Check that the viscosity and temperature of the pump liquid is within the limits for the pump. If not, change the properties of the liquid. • Dismantle the pump, and remove any foreign matter or impurities preventing the pump from rotating. • If none of the above causes are present, replace the pump.
	Blocked pump (51) The pump is blocked.	<ul style="list-style-type: none"> • Dismantle the pump, and remove any foreign matter or impurities preventing the pump from rotating.
	STO Active Indication (62) The Safe Torque Off (STO) function has been activated by an external device.	<ul style="list-style-type: none"> • This might not be an alarm situation, the pump might be stopped on purpose due to STO being activated by external device. • Verify STO functionality according to the STO manual.

TM053839



One yellow indicator light permanently on.
(Warning indication)

TM053835

Grundfos Eye	Cause	Remedy
	Pump communication fault (10)	
	There is a communication fault between this pump and the other pumps of the multipump system.	<ul style="list-style-type: none"> Make sure that all pumps of the multipump system have been correctly set.
	Forced pumping (29)	
	Other pumps or sources force flow through the pump even if the pump is stopped.	<ul style="list-style-type: none"> Check the system for defective non-return valves and replace, if necessary. Check the system for correct position of, for example, non-return valves.
	Dry running (56, 57)	
	There is no water at the pump inlet, or the water contains too much air.	<ul style="list-style-type: none"> Prime and vent the pump before a new startup. Check that the pump is operating correctly. If not, replace the pump.
	Internal fault (72, 83, 85, 155, 157, 163)	
	There is an internal fault in the pump electronics.	<ul style="list-style-type: none"> Replace the functional module, power board or terminal box.
	High motor temperature (65, 66)	
	The motor temperature is too high.	<ul style="list-style-type: none"> Make sure that the ambient temperature is within the specified range. Make sure that the pump is not covered by dust, dirt or other foreign matter which reduces the air cooling of the pump. If none of the above causes are present, replace the motor.
	Internal communication fault (76)	
	There is a communication fault between different parts of the electronics.	<ul style="list-style-type: none"> Replace the terminal box.
	Soft pressure buildup, timeout (215)	
	The system has been in the mode "soft pressure buildup" longer than the set time limit.	<ul style="list-style-type: none"> Check the system for leakages.

Grundfos Eye	Cause	Remedy
	Replace the motor bearings (30)	
	The bearings are worn.	<ul style="list-style-type: none"> The bearings must be replaced. Follow the instructions for the pump. See the relevant section about bearing replacement in the service instructions.
	Internal sensor fault (88)	
	The pump is receiving a signal from the internal sensor which is outside the normal range.	<ul style="list-style-type: none"> Check that the plug and cable are connected correctly to the sensor. The sensor is on the back of the pump housing. Replace the sensor.
	Pt100/1000 sensor 1 (91) and 2 (175)	
	Pt100/1000 input 1 is receiving a signal which is outside the normal range.	<ul style="list-style-type: none"> Check that the sensor resistance corresponds to approximately 100 or 1000 ohm. If not, replace the sensor. Check the sensor cable for damage. Check the cable connection at the pump and at the sensor. Correct the connection, if required. Replace the sensor.
	Supply fault, 5 V (161)	
	Fault in the output voltage to sensor or potentiometer.	<ul style="list-style-type: none"> Check the output voltage and wire to sensor or potentiometer.
	Supply fault, 24 V (162)	
	Fault in the output voltage.	<ul style="list-style-type: none"> Check the output voltage and wire.
	Signal fault, LiqTec-sensor (164)	
	The pump is receiving a signal from the LiqTec sensor which is outside the normal range.	<ul style="list-style-type: none"> Check that the plug and cable are connected correctly to the sensor. Replace the sensor.
	Signal fault, sensor 1 (165), 2 (166) and 3 (167)	
	Analog input 1, 2 or 3 is receiving a signal which is outside the normal range.	<ul style="list-style-type: none"> Check that the setup of the analog input corresponds to the sensor output as regards electrical characteristics (0.5 - 3.5 V, 0-5 V, 0-10 V, 0-20 mA or 4-20 mA). If not, change the setting, or replace the sensor with one that matches the setup. Check the sensor cable for damage. Check the cable connection at the pump and at the sensor. Correct the connection, if required. Check if the sensor has been removed, but the input was not deactivated. Replace the sensor.
	Limit 1 exceeded (190) and limit 2 exceeded (191)	
	Limit 1 or 2 has reached the limit for warning or alarm.	<ul style="list-style-type: none"> Identify and remove the fault cause.



One yellow indicator light rotating in the direction of rotation of the motor when seen from the non-drive end.

(Warning indication)

TM053833

13. Technical data

13.1 Operating conditions

13.1.1 Installation altitude

The installation altitude is the height above sea level of the installation site.

Products installed up to 3280 ft (1000 m) above sea level can be loaded 100 %.

The motors can be installed up to 11480 ft (3500 m) above sea level.

The product is not suitable for corner earthed grids.



Products installed more than 3280 ft (1000 m) above sea level must not be fully loaded due to the low density and consequent low cooling effect of the air.

The motor output power (P2) in relation to the altitude above sea level is shown in the graph.

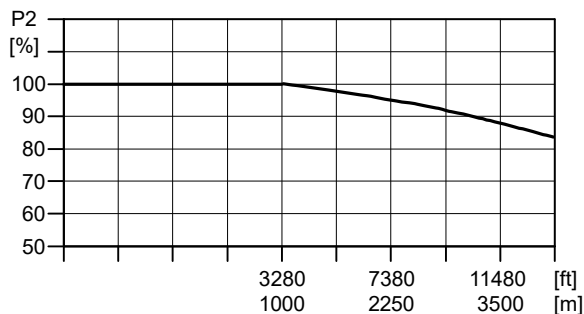

TM059218

Pos.	Description
P2	Motor output power [%]
X	Altitude [ft] and [m]

13.1.2 Maximum number of starts and stops

The number of starts and stops via the power supply must not exceed ten times per hour.



When switched on via the power supply, the product starts after approximately 5 seconds.

If a higher number of start and stops are required, use a digital input for external start and stop when starting and stopping the product or use the Safe Torque Off (STO) function.



When started via an external on and off switch, the product starts immediately.

13.1.3 Ambient temperature

13.1.3.1 Ambient temperature during storage and transportation

Description	Temperature
Minimum	-22 °F (-30 °C)
Maximum	140 °F (60 °C)

13.1.3.2 Ambient temperature during operation

Model K

Description	3 × 440-480 V
Minimum	-4 °F (-20 °C)
Maximum	122 °F (50 °C) ¹³⁾

¹³⁾ 35 HP MLE motors are rated for a maximum value of 104 °F (40 °C).

13.1.4 Humidity

Description	Percentage
Maximum humidity (non-condensing)	95 %

If the humidity is constantly high and above 85 %, open the drain holes in the drive-end flange to vent the motor.



If you install the motor in moist surroundings or areas with high humidity, ensure that the bottom drain hole is open. As a result, the motor becomes self-venting, allowing water and humid air to escape. When you open the drain hole, the enclosure class of the motor will be lower than standard.

13.1.5 Pollution degree

The product is approved for Pollution degree 3 rating.

13.1.6 Turbine operation



Do not force the product to run at a higher speed than the maximum speed stated on the nameplate.

13.2 Technical data, three-phase motors



WARNING

Electric shock

Death or serious personal injury
- Use the recommended fuse size.

Supply voltage

- 3 × 440-480 V -10 % / +10 %, 60 Hz, PE

Check that the supply voltage and frequency correspond to the values stated on the nameplate.

Recommended size of fuse

For recommended size of fuses see the tables below.

3 × 440-480 V, Model K

Motor size [HP]	Recommended [A]	Maximum [A]	Fuse type
20	50	80	gG
25	60	80	gG
30	70	80	gG



For recommended size of fuses see the appendix concerning installation in the USA and Canada.

13.2.1 Leakage current (AC)

The leakage currents are measured without any load on the shaft and in accordance with EN 61800-5-1:2007.

WARNING

Electric shock

Death or serious personal injury



- If the leakage current is greater than 3.5 mA, use a PE cable with a minimum cross-section of at least 8 AWG (10 mm²), or use 2 separate PE cables with the same cross section as the power cable.

3 × 440-480 V, 60 Hz, Model K

Speed [rpm]	Power [HP]	Power supply voltage [V]	Leakage current (I _L) [mA]
2900-4000	20 - 30	≤ 400	3.5 < I _L < 20
		> 400	3.5 < I _L < 30

13.3 Inputs and outputs

Signal reference

All voltages refer to signal ground (GND). All currents return to signal ground.

Absolute maximum voltage and current limits

Exceeding the following electrical limits may result in severely reduced operating reliability and motor life.

Relay 1:

- Maximum contact load: 250 VAC, 2 A or 30 VDC, 2 A.

Relay 2:

- Maximum contact load: 30 VDC, 2 A.

GENI terminals: -5.5 to +9.0 VDC or less than 25 mADC.

Other input and output terminals: -0.5 to +26 VDC or less than 15 mADC.

Digital inputs

Internal pull-up current greater than 10 mA at V_i equal to 0 VDC.

Internal pull-up to 5 VDC. Currentless for V_i greater than 5 VDC.

Input activated level: V_i less than 1.5 VDC.

Input deactivated level: V_i from 3.0 VDC to 24 VDC.

Hysteresis: No.

Screened cable: 0.5 - 1.5 mm² / 28-16 AWG.

Maximum cable length: 1640 ft (500 m).

Safe Torque Off (STO) terminals

S24:

24 V output voltage. Only for use with ST1 and ST2 inputs.

- Output voltage: 24 V -5 % to +5 %
- Maximum current: 50 mADC
- Overload protection: Yes.

ST1 and ST2:

- STO activated: V_{in} lower than 1.25 V
- STO deactivated: V_{in} greater than 21.6 V and lower than 25 V
- Input current greater than 10 mA at V_{in} equal to 24 V.

When the internal voltage source (connection S24) is used, the input voltage for ST1 and ST2 is within accepted limits.

When an external voltage source is used to drive the STO inputs, the following conditions must be met:

In operational state, the input voltage of ST1 and ST2 with reference to GND must be within:

- V_{min}: 21.6 V
- V_{max}: 25.0 V.

In the safe state, the input voltage of ST1 and ST2 with reference to GND must be as follows:

- V_{max}: 1.25 V.

In the operating state, the current flow into ST1 and ST2 must be within:

- Minimum contact current: 10 mA
- Maximum contact current: 25 mA.

Input source rating: SELV

Bus input (Ethernet)

Protocols TC/IP GENI, GDP.

Cable type, Standard CAT5, CAT5e or CAT6.

Open-collector digital outputs (OC)

Current-sinking capability: 75 mADC, no current sourcing.

Load types: Resistive and/or inductive.

Low-state output voltage at 75 mADC: Maximum 1.2 VDC.

Low-state output voltage at 10 mADC: Maximum 0.6 VDC.

Overcurrent protection: Yes.

Screened cable: 0.5 - 1.5 mm² / 28-16 AWG.

Maximum cable length: 1640 ft (500 m).

Analog inputs (AI)

Voltage signal ranges:

- 0.5 - 3.5 VDC, AL AU
- 0-5 VDC, AU
- 0-10 VDC, AU.

Voltage signal:

- R_i greater than 100 kΩ at 77 °F (25 °C).

Leak currents may occur at high operating temperatures. Keep the source impedance low.

Current signal ranges:

- 0-20 mADC, AU
- 4-20 mADC, AL AU.

Current signal: R_i is equal to 292 Ω.

Current overload protection: Yes. Change to voltage signal.

Measurement tolerance: +/- 2 % of full scale.

Screened cable: 0.5 - 1.5 mm² / 28-16 AWG.

Maximum cable length: 1640 ft (500 m), excluding potentiometer.

Potentiometer connected to +5 V, GND, any AI: Use maximum 10 kΩ.

Maximum cable length: 328 ft (100 m).

Analog output (AO)

Current sourcing capability only.

Voltage signal:

- Range: 0-10 VDC
- Minimum load between AO and GND: 1 kΩ
- Short-circuit protection: Yes.

Current signal:

- Ranges: 0-20 and 4-20 mADC
- Maximum load between AO and GND: 500 Ω
- Open-circuit protection: Yes.

Tolerance: +/- 4 % of full scale.

Screened cable: 0.5 - 1.5 mm² / 28-16 AWG.

Maximum cable length: 1640 ft (500 m).

Pt100 or Pt1000 inputs (Pt)

Temperature range:

- Minimum -58 °F (-50 °C) (80 Ω /803 Ω).
- Maximum 399 °F (204 °C) (177 Ω /1773 Ω).

Measurement tolerance: +/- 2.7 °F (1.5 °C).

Measurement resolution: less than 0.54 °F (0.3 °C).

Automatic range detection (Pt100 or Pt1000): Yes.

Sensor fault alarm: Yes.

Screened cable: 0.5 - 1.5 mm² / 28-16 AWG.

Use Pt100 for short wires.

Use Pt1000 for long wires.

LiqTec sensor inputs

Use a Grundfos LiqTec sensor only.

Screened cable: 0.5 - 1.5 mm² / 28-16 AWG.

Grundfos Digital Sensor input and output (GDS)

Use Grundfos Digital Sensor only.

Power supplies, +5 V, +24 V

+5 V

- Output voltage: 5 VDC -5 % to +5 %
- Maximum current: 60 mADC, sourcing only
- Overload protection: Yes.

+24 V

- Output voltage: 24 VDC -5 % to +5 %
- Maximum current: 200 mADC, sourcing only
- Overload protection: Yes.

Digital outputs, relays

Potential-free changeover contacts.

Minimum contact load when in use: 5 VDC, 10 mA.

Screened cable: 0.5 - 2.5 mm² / 28-12 AWG.

Maximum cable length: 1640 ft (500 m).

Bus input

Grundfos GENIbus protocol, RS-485.

Grundfos Modbus protocol, RS-485.

Screened 3-core cable: 0.5 - 1.5 mm² / 28-16 AWG.

Maximum cable length: 1640 ft (500 m).

13.4 Other technical data

13.4.1 Ecodesign Directive

This product is out of scope of Directive 2009/125/EC and Commission Regulation (EU) 2019/1781 due to Article 2 (3a), as the variable speed drive (VSD) is integrated into a product and its energy performance cannot be tested independently from the product.

13.4.2 EMC (electromagnetic compatibility)

Standard used: EN 61800-3.

The table below shows the emission category of the motor.

C1 fulfils the requirements for residential areas.



Model K: This equipment complies with IEC 61000-3-12 provided that the short-circuit power S_{SC} is greater than or equal to the respective value described in the table below at the interface point between the user's supply and the public system. It is the responsibility of the installer or user of the equipment to ensure, by consultation with the distribution network operator if necessary, that the equipment is connected only to a supply with a short-circuit power S_{SC} greater than or equal to the respective value described in the table below.

3 × 440-480 V, 60 Hz, Model K

Speed [rpm]	Power P2 [HP]	Supply voltage [V]	Short-circuit power [mVA]
2900-4000	20	3 × 440-480	4.6
	25	3 × 440-480	5.8
	30	3 × 440-480	6.6

C2 fulfils the requirements for residential areas if the system is operated and installed by qualified persons.

C3 fulfils the requirements for industrial areas.



In a residential environment, this product may cause radio interference in which case supplementary mitigation measures may be required.

Model K

Motor [HP]	Emission category	
	2900-4000 rpm	4000-5900 rpm
20	C2/C3 ¹⁴⁾	-
25	C2/C3 ¹⁴⁾	-
30	C2/C3 ¹⁴⁾	-

¹⁴⁾ Depending on product hardware configuration.

Immunity: The motor fulfils the requirements for industrial areas.

Contact Grundfos for further information.

13.4.3 Enclosure class

Motor

Standard: TEFC

Variable Frequency Drive

The enclosure of 20 - 30 hp MLE motors is approved for NEMA type 12.

The NEMA rating can be found on the product nameplate:

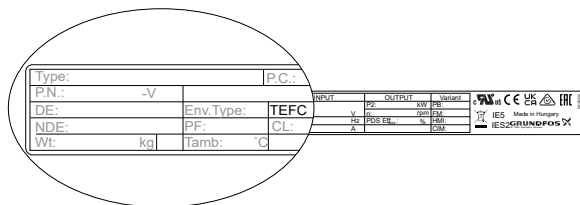

13.4.4 Insulation class

311 °F (155 °C).

13.4.5 Standby power consumption

5-10 W.

13.4.6 Cable entry sizes

Model K

Number and size of cable entries

Motor [hp]	Supply voltage	Number and size of cable entries
20-30	3 x 440-480 V, 60 Hz	1 x NPT 1" 6 x NPT 1/2"

13.4.7 Torques

Torques for terminals

Terminal	Recommended torque [ft-lb]
L1, L2, L3	1.6
PE	4.4
NC, C1, C2, NO	0.4
DI1, DI2, DI3, DI4, AI1, AI2, AI3, AO1, PT1, PT2, LT1, LT2, GND, 24V, 5V, TX, RX, A, Y, B, S24, ST1, ST2	0.4

TM084777

Torques for other parts

Part designation	Recommended torque [ft·lb]
Control box, upper part	4.8 - 5.2
Cover for power supply	0.7 - 1
Blind plugs:	
½" NPT	5.9 - 7.4

13.5 Accessories

Protocol	Communication interface module
LonWorks (Single)	CIM 100
LonWorks (Multi)	CIM 110
PROFIBUS DP	CIM 150
Modbus RTU	CIM 200
US GiC/GRM 3G/4G	CIM 280
BACnet MS/TP	CIM 300
Modbus TCP/IP, BACnet IP, PROFINET, GiC/GRM IP, EtherNet IP	CIM 500

13.6 Applicable standards

Standard

UL 61800-5-1, Adjustable Speed Electrical Power Drive Systems - Part 5-1: Safety Requirements - Electrical, Thermal and Energy, Edition 1, Revision Date 02/11/2021 ¹⁵⁾

CSA C22.2 No. 274, Adjustable Speed Drives, Edition 2, Issue Date 04/2017 ¹⁵⁾

EN/IEC 61800-5-1, Adjustable Speed Electrical Power Drive Systems - Part 5-1: Safety Requirements - Electrical, Thermal and Energy, IEC 61800-5-1:2007+AMD1:2016

UL 60730-1, Automatic Electrical Controls - Part 1: General Requirements, Edition 5, Revision Date 10/18/2021

CAN/CSA E 60730-1, Automatic Electrical Controls - Part 1: General Requirements, Edition 5, AMD 2, Revision Date 10/2021

UL 1004-1, Rotating Electrical Machines - General Requirements, Edition 2, Revision Date 11/05/2020

UL 1004-3, Thermally Protected Motors, Edition 2, Revision Date 01/31/2018

UL 1004-7, Electronically Protected Motors, Edition 3, Issue Date 06/21/2018

CSA C22.2 No. 100, Motors and Generators, Edition 7, Revision Date 04/2017

CSA C22.2 No. 77, Motors with Inherent Overheating Protection, Edition 8, Revision Date 02/2015

EN/IEC 60034-1, Rotating Electrical Machines - Part 1: Rating and Performance, Edition 14, Issue Date 02/2022

¹⁵⁾ Only applicable for Model K.

14. Disposing of the product

This product or parts of it must be disposed of in an environmentally sound way.

1. Use the public or private waste collection service.
2. If this is not possible, contact the nearest Grundfos company or service workshop.
3. Dispose of the waste battery through the national collective schemes. If in doubt, contact your local Grundfos company.



The crossed-out wheellie bin symbol on a product means that it must be disposed of separately from household waste. When a product marked with this symbol reaches its end of life, take it to a collection point designated by the local waste disposal authorities. The separate collection and recycling of such products will help protect the environment and human health.

See also end-of-life information at www.grundfos.com/product-recycling.

15. Document quality feedback

To provide feedback about this document, scan the QR code using your phone's camera or a QR code app.



[Click here to submit your feedback](#)

FEEDBACK_92898117

Limited consumer warranty

1. Limited consumer warranty

This Limited Warranty is provided for Consumer Products sold in the United States only and applies to Consumer Transactions as defined in and applicable under the Magnusson-Moss Warranty Act and any other applicable Federal and/or State laws. In case of non-Consumer Products, please refer to Grundfos' warranty terms defined in clause 10 of Grundfos US Terms and Conditions of Sale of Product and Services available at <https://www.grundfos.com/legal/grundfos-customer-terms/usa-grundfos-general-terms-for-sales-of-products-and-services>

This Limited Warranty gives you specific legal rights, and you may also have other rights which vary from State to State.

New products manufactured by Grundfos are warranted to the original purchaser only and are to be free from defects in design, material and workmanship under normal use and service for no greater than a period of thirty (30) months from the date of manufacture which is set forth on the product's nameplate and on the product's packaging or the minimum period required by the applicable State law. For New Jersey, the applicable period is one year from the date of purchase.

The warranty period for replacement products, parts and components expires thirty (30) months from the original date of manufacture of the product originally purchased, unless a longer period is required under the applicable State law. For New Jersey, the warranty period for replacement products, parts and components expires one year from the original date of purchase of the product, not the date of replacement. Products sold by Grundfos that are manufactured by others are not covered by this warranty.

Note that when purchasing a Grundfos product online, it is important to check the date of manufacture and the duration of the warranty with the seller as the product might no longer be covered under this Limited Warranty.

When a product is subject to this Limited Warranty a purchaser should contact the seller from which it purchased the product to make a claim.

If the seller of a product is no longer in business, the purchaser should contact a Grundfos Authorized Service Partner, which can be found at www.grundfos.com/us under > Support > Contact Service.

As part of making a claim, a purchaser shall return a defective product at the purchaser's cost, to the extent allowed by applicable law, along with proof of purchase and an explanation of the defect, date the defect occurred and circumstances surrounding the defect. For New Jersey there is no prohibition on returning a defective product at a purchaser's cost. If Grundfos is required by applicable State law to pay for the cost of shipment under applicable State law, then a purchaser should contact a Grundfos Authorized Service Partner to arrange for shipment. A purchaser also needs to promptly respond to Grundfos as to any inquiries regarding a warranty claim.

Grundfos' liability under this Limited Warranty to purchaser is limited to the repair or replacement of a product (at Grundfos' decision) that is the sole and exclusive remedy for purchaser to the extent permissible by applicable law. For New Jersey this limitation is permissible.

This warranty does not cover the following: ordinary wear and tear; use of a product for applications for which it is not intended; use of a product in an unsuitable environment; modifications, alterations or repair undertaken by anyone not acting with Grundfos' written authorization; failure to follow Grundfos' instructions, operations manuals, any other guidelines or good industry practice; use of faulty or inadequate ancillary equipment in combination with a product; application of spare or replacement parts not provided or authorized by Grundfos; accidental or intentional damage or misuse of a product.

The time period for making a claim under the implied warranty of merchantability and implied warranty of fitness are limited to the same time period as provided by this warranty to the extent permissible by applicable law. For residents of New Jersey, this limitation is permissible, but note that some states do not allow limitations on how long an implied warranty lasts, so the above limitation may not apply to you.

Grundfos shall not be liable for any incidental and consequential damages in connection with a product to the extent permissible by applicable law. For residents of New Jersey, this limitation is permissible, but note that some states do not allow limitations of incidental or consequential damages, so the above limitation may not apply to you.

2. Garantía limitada del consumidor

Esta garantía limitada se proporciona únicamente para los productos de consumo vendidos en los Estados Unidos y es aplicable a las transacciones de consumo tal y como se define en y resulta aplicable en virtud de la ley de Garantías Magnusson-Moss y cualquier otra legislación federal y/o estatal aplicable. Para el caso de productos que no sean de consumo, consulte los términos de la garantía de Grundfos definidos en la cláusula 10 de los términos y condiciones de venta de productos y servicios de Grundfos para los EE. UU., disponibles en <https://www.grundfos.com/legal/grundfos-customer-terms/usa-grundfos-general-terms-for-sales-of-products-and-services>.

Esta garantía limitada le confiere derechos legales específicos. Puede que también tenga otros derechos en virtud de su jurisdicción estatal.

Se garantiza únicamente al comprador original que los productos fabricados por Grundfos estarán libres de defectos de diseño, materiales y mano de obra en condiciones normales de uso y servicio durante un periodo no mayor a treinta (30) meses a partir de la fecha de fabricación que figura en la placa de datos del producto y en el empaque del mismo o el periodo mínimo exigido por la legislación estatal aplicable. Para Nueva Jersey, el periodo aplicable es de un año a partir de la fecha de compra.

El periodo de garantía para los productos, partes y componentes de repuesto vence a los treinta (30) meses contados a partir de la fecha de fabricación original del producto adquirido en primer lugar, a menos que la legislación estatal aplicable exija un periodo más largo. Para Nueva Jersey, el periodo de garantía de los productos, partes y componentes de repuesto vence un año contado a partir de la fecha original de compra del producto, no de la fecha de sustitución.

Los productos vendidos por Grundfos que sean producidos por otros fabricantes no están cubiertos por esta garantía.

Tenga en cuenta que, al comprar un producto Grundfos en línea, es importante revisar la fecha de fabricación y la duración de la garantía con el vendedor, ya que es posible que el producto ya no esté cubierto por esta garantía limitada.

Cuando un producto esté sujeto a esta garantía limitada, el comprador deberá ponerse en contacto con el vendedor al que haya comprado el producto para presentar una reclamación.

Si el vendedor de un producto ya no está en el negocio, el comprador debe ponerse en contacto con socio de servicio autorizado por Grundfos, que puede encontrar en la dirección www.grundfos.com/us, en la sección "Support" > "Contact Service".

Como parte de la presentación de una reclamación, el comprador deberá devolver el producto descompuesto a su costa, en la medida en la que lo permita la legislación aplicable, junto con el comprobante de compra y una explicación del defecto, la fecha en que este se haya producido y las circunstancias en torno al defecto. En Nueva Jersey no existe ninguna prohibición de devolver un producto descompuesto a costa del comprador. Si la legislación estatal aplicable obliga a Grundfos a hacerse cargo de los gastos de envío, el comprador deberá ponerse en contacto con un servicio técnico autorizado por Grundfos para organizar el envío. El comprador también debe responder con prontitud a Grundfos cualquier consulta relacionada con una reclamación de garantía.

La responsabilidad de Grundfos hacia el comprador en virtud de esta garantía limitada se limita a la reparación o sustitución de un producto (a decisión de Grundfos), que es el único y exclusivo remedio para el comprador en la medida permitida por la legislación aplicable. Para Nueva Jersey, esta limitación resulta permisible.

Esta garantía no cubre lo siguiente: el desgaste ordinario; el uso de un producto para aplicaciones para las que no está diseñado; el uso de un producto en un entorno inadecuado; las modificaciones, alteraciones o reparaciones realizadas por cualquier persona que no actúe con la autorización por escrito de Grundfos; el incumplimiento de las instrucciones, manuales de operación, cualquier otro lineamiento o las buenas prácticas industriales de Grundfos; el uso de equipos auxiliares descompuestos o inadecuados en combinación con un producto; el uso de repuestos o partes de sustitución no proporcionados ni autorizados por Grundfos; el daño accidental o deliberado o el uso indebido de un producto.

El periodo para presentar una reclamación en virtud de la garantía implícita de comerciabilidad y la garantía implícita de idoneidad se limita al mismo periodo previsto por esta garantía en la medida permitida por la legislación aplicable. Para los residentes de Nueva Jersey, esta limitación resulta permisible, si bien se debe tener en cuenta que algunos estados no permiten limitaciones en cuanto a la duración de una garantía implícita, por lo que la limitación anterior puede no resultar aplicable en su caso.

Grundfos no será responsable de ningún daño indirecto o consecuente en relación con un producto en la medida en la que lo permita la legislación aplicable. Para los residentes de Nueva Jersey, esta limitación resulta permisible, si bien debe tenerse en cuenta que algunos estados no permiten limitaciones en cuanto a daños indirectos o consecuentes, por lo que la limitación anterior puede no resultar aplicable en su caso.

Appendix A

A.1. Sound pressure level

ES-MX: Los niveles de presión sonora

FR-CA: Les niveaux de pression acoustique

Motor [hp]	Maximum speed stated on nameplate [min ⁻¹]	Speed [min ⁻¹]	Sound pressure level ISO 3743 [dB(A)]
			3 × 440-480 V
20	2200	1750	63
		2200	67.5
	4000	3500	68.5
		4000	76
25	2200	1750	65.5
		2200	76.5
	4000	3500	68.5
		4000	74
30	2200	1750	66
		2200	79.5
	4000	3500	68.5
		4000	74.5

Appendix B

B.1. Installation in the USA and Canada



To maintain the cURus approval, the additional information in this section must be followed.

Environmental enclosure ratings

The MGE, MLE Model K enclosure is approved for NEMA type 12 and is suitable for indoor use only.

For more information about ambient temperature during operation, see the sections on operating conditions and ambient temperature.

EMC statements for USA

This equipment has been tested and found to comply with the limits for a Class A digital device, pursuant to part 15 of the FCC Rules. These limits are designed to provide reasonable protection against harmful interference when the equipment is operated in a commercial environment. This equipment generates, uses, and can radiate radio frequency energy and, if not installed and used in accordance with the instruction manual, may cause harmful interference to radio communications. Operation of this equipment in a residential area is likely to cause harmful interference in which case the user will be required to correct the interference at his own expense.



MLE motors of the C2 emission category fulfill the limits of Class A.



MLE motors of the C3 emission category can only be used in industrial plants and public utilities in accordance with FCC § 15.103(b) and ICES 003 § 1.5.1(c). In other locations, MLE motors of the C1 or C2 emission category must be used.

Canadian Interference-Causing Equipment Standard

MLE Model K complies with the Canadian ICES-003 Class A specifications. This Class A device meets all the requirements of the Canadian interference-causing equipment regulations.

L'appareil MLE Model K, est conforme à la norme NMB-003 du Canada pour le matériel de classe A. Cet appareil de classe A respecte toutes les exigences du règlement canadien s'appliquant au matériel brouilleur.

Hot surface

The product might reach a surface temperature of 149 °F (65 °C), therefore pay attention when operating the product.

The following marking is found on the product:



TM084167

B.2. Radio communication

For the USA and Canada

CAUTION



Radiation

Minor or moderate personal injury

- This equipment complies with FCC and ISED radiation exposure limits set forth for an uncontrolled environment. This equipment must be installed and operated with a minimum distance of 8 inches (20 cm) between the radiator and your body.



This device complies with Part 15 of the FCC rules and RSS210 of the IC rules.



Changes or modifications made to this equipment not expressly approved by Grundfos may void the FCC authorization to operate this equipment.

Operation is subject to the following two conditions:

- This device may not cause interference.
- This device must accept any interference, including interference that may cause undesired operation of the device.

Pour les États-Unis et le Canada**CAUTION****Radiation**

Blessures corporelles mineures à modérées



- Cet équipement est conforme aux limites d'exposition aux rayonnements définies par la FCC et l'ISDE pour un environnement non contrôlé. Cet équipement doit être installé et utilisé à une distance minimale de 20 cm (0,66 pi) entre le radiateur et votre corps.



Cet appareil est conforme à la section 15 de la réglementation FCC et à RSS210 de la réglementation IC.



Les changements ou modifications apportés à cet équipement qui ne sont pas expressément approuvés par Grundfos peuvent annuler l'autorisation de la FCC à utiliser cet équipement.

Son fonctionnement est soumis aux deux conditions suivantes:

- Ce dispositif ne doit pas provoquer de brouillage préjudiciable.
- Il doit accepter tout brouillage reçu, y compris le brouillage pouvant entraîner un mauvais fonctionnement.

B.3. Identification numbers**For the USA**

Grundfos Holding A/S

Contains FCC ID: OG3-RADIOM01-2G4

Contains FCC ID: OG3-RA2G4MSR.

For Canada

Grundfos Holding A/S

Model: RADIOMODULE 2G4

Contains IC: 10447A-RA2G4M01

Contains IC: 10447A-RA2G4MSR.

Pour le Canada

Numéros d'identification:

Grundfos Holding A/S

Modèle: RADIOMODULE 2G4

Contient IC: 10447A-RA2G4M01

Contient IC: 10447A-RA2G4MSR.

B.4. Electrical connection**Installation altitude**

For 480/277V grid systems: The maximum altitude is between 0 and 11480 ft (3500 m) above sea level.

For 480V (corner earthed) grid systems: The maximum altitude is between 0 and 6560 ft (2000 m) above sea level.

Conductors

See the sections on electrical installation and cable requirements.

Conductor temperature ratings**Model K:** Use 167 °F (75 °C) copper conductors only. The wire sizes for the supply mains must be sized for a wire size which is suitable for at least 125% of the rated input current of the motor drive units.**Recommended ring terminals**

Ensure that the used ring terminals are UL certified.

The 480 V supply terminals are suitable for field wiring when used with stranded wires and specific listed crimp terminals manufactured by Tyco Electronics (E13288).

Cable cross-section		Part number/Designation number	Manufacturer
[mm ²]	[AWG]		
16	6	130552	Tyco Electronics
10	8	160013	Tyco Electronics
6	10	130191	Tyco Electronics

Ethernet cable connection

The connection of Ethernet cables must be done by connecting the Ethernet cable screen to an earth clamp on the terminal box, to be in compliance with FCC and ISED requirements.

The recommended Ethernet cable types for earth clamp applications are SF/UTP, S/FTP or SF/FTP, where the cable screen consists of both a braided and a foil screen.

Torques

See the section on torques.

Line reactors

The maximum line reactor size in front of the drive must not exceed the following values:

Model K

P2		Maximum line reactor size [mH]
[kW]	[HP]	3500-4000 rpm
15	20	0.2
18.5	25	0.2
22	30	0.2



Line reactors are often required for six-pulse variable speed drives. Please observe that the MGE, MLE utilize a small DC capacitor concept for lower harmonics and exceeding the maximum inductance may cause resonance between reactor and the MGE, MLE that will reduce the lifetime of the product.

Short-circuit current

Model K: Suitable for use on a circuit capable of delivering not more than 5000 rms symmetrical amperes, 480 V maximum when protected by RK1, J or T Class fuses, rated 80 A, 600 V.

Fuses

Model K: Fuses used for motor protection must be rated for minimum 600 V.



For fuse sizes, see the section on recommended size of fuses.

3 × 440-480 V, MLE Model K

Motor size [hp]	Recommended [A]	Maximum [A]	Fuse type
20	50	80	RK1, Class J or T UL listed fuse
25	60	80	RK1, Class J or T UL listed fuse
30	70	80	RK1, Class J or T UL listed fuse

Branch circuit short-circuit protection

For the USA

Integral solid state short-circuit protection does not provide branch circuit protection. Branch circuit protection must be provided in accordance with the National Electrical Code and any additional local codes, or the equivalent.

For Canada

INTEGRAL SOLID STATE SHORT-CIRCUIT PROTECTION DOES NOT PROVIDE BRANCH CIRCUIT PROTECTION. BRANCH CIRCUIT PROTECTION MUST BE PROVIDED IN ACCORDANCE WITH THE CANADIAN ELECTRICAL CODE, PART I.

Overload protection

Degree of overload protection provided internally by the drive, in percent of full-load current: 102 %.

Supplier's Declaration of Conformity

FCC Supplier's Declaration of Conformity 47 CFR § 2.1077 Compliance Information

Unique identifier: MGE / MLE Model K

Responsible Party – U.S. Contact Information:

Grundfos Americas Corporation

856 Koomey Rd.

Brookshire, TX 77423

www.grundfos.us

FCC Compliance Statement:

This device complies with Part 15 of the FCC Rules. Operation is subject to the following two conditions: (1) This device may not cause harmful interference, and (2) this device must accept any interference received, including interference that may cause undesired operation.

10000533677

U.S.A.

Global Headquarters for WU
856 Koomey Road
Brookshire, Texas 77423 USA
Phone: +1-630-236-5500

GRUNDFOS CBS Inc.
902 Koomey Road
Brookshire, TX 77423 USA
Phone: 281-994-2700
Toll Free: 1-800-955-5847
Fax: 1-800-945-4777

GRUNDFOS Pumps Corporation
9300 Loiret Boulevard
Lenexa, Kansas 66219 USA
Tel.: +1 913 227 3400
Fax: +1 913 227 3500

Canada

GRUNDFOS Canada inc.
2941 Brighton Road
Oakville, Ontario
L6H 6C9
Tel.: +1-905 829 9533
Fax: +1-905 829 9512

Mexico

Bombas GRUNDFOS de México
S.A. de C.V.
Boulevard TLC No. 15
Parque industrial Stiva Aeropuerto
Apodaca, N.L. 66600
Tel.: +52-81-8144 4000
Fax: +52-81-8144 4010

Revision Info

Last revised on 04-2021

92898117 04.2024
ECM: 1391874