

# CRE-DP

Permanent Magnet MLE motor

Installation and operating instructions





## English (US)

Installation and operating instructions .....	4
Appendix .....	36

## Original installation and operating instructions

## CONTENTS

	Page
<b>1. Limited warranty</b>	<b>4</b>
<b>2. General information</b>	<b>5</b>
2.1 Hazard statements	5
2.2 Abbreviations and definitions	5
<b>3. Receiving the product</b>	<b>6</b>
3.1 Transporting the product	6
3.2 Inspecting the product	6
<b>4. Installing the product</b>	<b>6</b>
4.1 Mechanical installation	6
4.2 Electrical installation	7
4.3 Installing a communication interface module	13
4.4 Changing the position of the control panel	14
<b>5. Product introduction</b>	<b>15</b>
5.1 Product description	15
5.2 Identification	16
5.3 Bus signal	16
5.4 Grundfos Eye	17
5.5 Signal relays	18
<b>6. User interfaces</b>	<b>19</b>
6.1 Advanced control panel	19
<b>7. Setting the product</b>	<b>20</b>
7.1 Grundfos GO Remote	20
7.2 Menu overview for Grundfos GO Remote	21
<b>8. Control functions</b>	<b>23</b>
8.1 Description of selected functions	23
8.2 Assist	27
8.3 Selection of control mode	28
8.4 Changing the position of the control panel	29
8.5 Bus signal	30
8.6 Priority of settings	30
<b>9. Servicing the product</b>	<b>31</b>
9.1 Motor	31
9.2 Pump	31
9.3 Cleaning the product	31
<b>10. Technical data</b>	<b>31</b>
10.1 Operating conditions	31
10.2 Megging	32
10.3 Technical data, single-phase motors	32
10.4 Technical data, three-phase motors	32
10.5 Inputs/outputs	33
10.6 Other technical data	34
<b>11. Disposing of the product</b>	<b>35</b>

**1. Limited warranty**

Products manufactured by Grundfos Pumps Corporation (Grundfos) are warranted to the original user only to be free of defects in material and workmanship for a period of 24 months from date of installation, but not more than 30 months from date of manufacture. Grundfos' liability under this warranty shall be limited to repairing or replacing at Grundfos' option, without charge, F.O.B. Grundfos' factory or authorized service station, any product of Grundfos manufacture. Grundfos will not be liable for any costs of removal, installation, transportation, or any other charges that may arise in connection with a warranty claim.

Products which are sold, but not manufactured by Grundfos, are subject to the warranty provided by the manufacturer of said products and not by Grundfos' warranty.

Grundfos will not be liable for damage or wear to products caused by abnormal operating conditions, accident, abuse, misuse, unauthorized alteration or repair, or if the product was not installed in accordance with Grundfos' printed installation and operating instructions and accepted codes of good practice. The warranty does not cover normal wear and tear.

To obtain service under this warranty, the defective product must be returned to the distributor or dealer of Grundfos' products from which it was purchased together with proof of purchase and installation date, failure date and supporting installation data. Unless otherwise provided, the distributor or dealer will contact Grundfos or an authorized service station for instructions. Any defective product to be returned to Grundfos or a service station must be sent freight prepaid; documentation supporting the warranty claim and/or a Return Material Authorization must be included if so instructed.

Grundfos will not be liable for any incidental or consequential damages, losses, or expenses arising from installation, use, or any other causes. There are no express or implied warranties, including merchantability or fitness for a particular purpose, which extend beyond those warranties described or referred to above. Some jurisdictions do not allow the exclusion or limitation of incidental or consequential damages and some jurisdictions do not allow limitations on how long implied warranties may last. Therefore, the above limitations or exclusions may not apply to you. This warranty gives you specific legal rights and you may also have other rights which vary from jurisdiction to jurisdiction.

Products which are repaired or replaced by Grundfos or authorized service center under the provisions of these limited warranty terms will continue to be covered by Grundfos warranty only through the remainder of the original warranty period set forth by the original purchase date.



Read this document before installing the product. Installation and operation must comply with local regulations and accepted codes of good practice.

## 2. General information

These installation and operating instructions are a supplement to the installation and operating instructions for the corresponding standard pumps CR, CRI, CRN, CRK, SPK, MTR and CM.

For instructions not mentioned specifically in this manual, see the installation and operating instructions for the standard pump.

### 2.1 Hazard statements

The symbols and hazard statements below may appear in Grundfos installation and operating instructions, safety instructions and service instructions.



#### DANGER

Indicates a hazardous situation which, if not avoided, will result in death or serious personal injury.



#### WARNING

Indicates a hazardous situation which, if not avoided, could result in death or serious personal injury.



#### CAUTION

Indicates a hazardous situation which, if not avoided, could result in minor or moderate personal injury.

The hazard statements are structured in the following way:



#### SIGNAL WORD

##### Description of hazard

Consequence of ignoring the warning.  
- Action to avoid the hazard.

The symbols and notes below may appear in Grundfos installation and operating instructions, safety instructions and service instructions.



Observe these instructions for explosion-proof products.



A blue or grey circle with a white graphical symbol indicates that an action must be taken.



A red or grey circle with a diagonal bar, possibly with a black graphical symbol, indicates that an action must not be taken or must be stopped.



If these instructions are not observed, it may result in malfunction or damage to the equipment.



Tips and advice that make the work easier.

### 2.2 Abbreviations and definitions

AI	Analog input.
AL	Alarm, out of range at lower limit.
AO	Analog output.
AU	Alarm, out of range at upper limit.
CIM	Communication interface module.
Current sinking	The ability to draw current into the terminal and guide it towards GND in the internal circuitry.
Current sourcing	The ability to push current out of the terminal and into an external load which must return it to GND.
DI	Digital input.
DO	Digital output.
ELCB	Earth (ground) leakage circuit breaker.
FM	Functional module.
GDS	Grundfos Digital Sensor. Factory-fitted sensor in some Grundfos pumps.
GENIbus	Proprietary Grundfos fieldbus standard.
GFCI	Ground fault circuit interrupter. (USA and Canada).
GND	Ground.
Grundfos Eye	Status indicator light.
LIVE	Low voltage with the risk of electric shock if the terminals are touched.
OC	Open collector: Configurable open-collector output.
PE	Protective earth (ground).
PELV	Protective extra-low voltage. A voltage that cannot exceed ELV under normal conditions and under single-fault conditions, except earth (ground) faults in other circuits.
RCD	Residual-current device
SELV	Safety extra-low voltage. A voltage that cannot exceed ELV under normal conditions and under single-fault conditions, including earth (ground) faults in other circuits.

### 3. Receiving the product

#### 3.1 Transporting the product

##### WARNING



##### Falling objects

- Death or serious personal injury
- Secure the product during transportation to prevent it from tilting or falling down.

##### CAUTION



##### Crushing of feet

- Minor or moderate personal injury
- Wear safety shoes when moving the product.

- Motors from 3 to 5 Hp (2.2 to 5.5 kW): Do not stack more than two motors in their original packaging.
- Motors from 7 1/2 to 15 Hp (5.5 to 11 kW): Do not stack the motors.

#### 3.2 Inspecting the product

Before you install the product, do the following:

1. Check that the product is as ordered.
2. Check that no visible parts have been damaged.
3. If parts are damaged or missing, contact your local Grundfos sales company.

### 4. Installing the product

#### 4.1 Mechanical installation

##### 4.1.1 Handling the product

Observe local regulations setting limits for manual lifting or handling. The motor weight is stated on the nameplate.

##### CAUTION



##### Back injury

- Minor or moderate personal injury
- Use lifting equipment.

##### CAUTION



##### Crushing of feet

- Minor or moderate personal injury
- Wear safety shoes and attach lifting equipment to the motor eyebolts when handling the product.



Do not lift the product by the terminal box.

#### 4.1.2 Mounting

##### CAUTION



##### Crushing of feet

- Minor or moderate personal injury
- Secure the product to a solid foundation by bolts through the holes in the flange or the base plate.



In order to maintain the UL mark, additional requirements apply to the equipment. See Appendix, page 36.

#### 4.1.3 Cable entries

See the size of the cable entries in section 10.6 *Other technical data*.

#### 4.1.4 Cable glands

The number and size of cable glands delivered with the pump depends on the motor size. See section 10.6 *Other technical data*.

#### 4.1.5 Ensuring motor cooling

Leave at least 2 in. (50 mm) between the end of the fan cover and a wall or other fixed objects. See fig. 1.

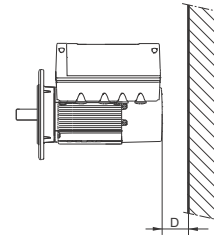

Fig. 1 Minimum distance (D) from the motor to a wall or other fixed objects

#### 4.1.6 Outdoor installation

The enclosure class of MLE motor is a NEMA 3 rating. If you install the motor outdoors, provide the motor with a suitable cover and open the drain holes to avoid condensation on the electronic components. See fig. 2.



When fitting a cover to the motor, observe the guideline in section 4.1.5 *Ensuring motor cooling*.

The cover must be sufficiently large to ensure that the motor is not exposed to direct sunlight, rain or snow. Grundfos does not supply covers. We therefore recommend that you have a cover built for the specific application. In areas with high humidity, we recommend that you enable the built-in standstill heating function.

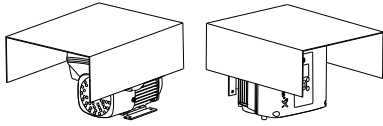

TM05 3496 3512

Fig. 2 Examples of covers (not supplied by Grundfos)



In order to maintain the UL mark, additional requirements apply to the equipment. See Appendix, page 36.

**4.1.7 Drain holes**

When the motor is installed in moist surroundings or areas with high humidity, the bottom drain hole must be open. The enclosure class of the motor will then be lower. This helps prevent condensation in the motor as the motor becomes self-venting, and it allows water and humid air to escape.

The motor has a plugged drain hole on the drive side. You can turn the flange 90 ° to both sides or 180 °.

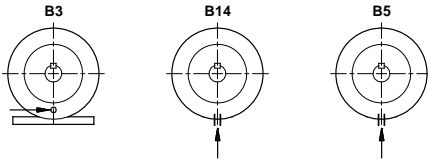

TM02 9037 1604

Fig. 3 Drain holes

**4.2 Electrical installation**

**DANGER**

**Electric shock**



Death or serious personal injury  
 - Switch off the power supply to the motor and to the signal relays. Wait at least 5 minutes before you make any connections in the terminal box. Make sure that the power supply cannot be accidentally switched on.

**DANGER**

**Electric shock**



Death or serious personal injury  
 - Check that the supply voltage and frequency correspond to the values stated on the nameplate.

If the power supply cable is damaged, it must be replaced by the manufacturer, the manufacturer's service partner or a similarly qualified person.

The user or the installer is responsible for the installation of correct grounding and protection according to local regulations. All operations must be carried out by a qualified electrician.

**4.2.1 Protection against electric shock, indirect contact**

**WARNING**

**Electric shock**



- Death or serious personal injury
- Connect the motor to a protective ground and provide protection against indirect contact in accordance with local regulations.

Protective-ground conductors must always have a yellow/green (PE) or yellow/green/blue (PEN) color marking.

**Protection against power supply voltage transients**

The motor is protected against power supply voltage transients in accordance with EN 61800-3.

**Motor protection**

The motor requires no external motor protection. The motor incorporates thermal protection against slow overloading and blocking.

**4.2.2 Cable requirements**

**Cable cross-section**

**DANGER**

**Electric shock**



- Death or serious personal injury
- Always comply with local regulations as to cable cross-sections.

**Single-phase supply**

Conductor type	Conductor material	Cross section	
		[mm <sup>2</sup> ]	[AWG]
Solid	Copper	0.5 - 2.5	28-12
Stranded		0.5 - 2.5	30-12

**Three-phase supply**

Conductor type	Conductor material	Cross section	
		[mm <sup>2</sup> ]	[AWG]
Solid	Copper	0.5 - 10	18-8
Stranded		0.5 - 10	18-8

**Conductors**

**Type**

Stranded or solid copper conductors.

**Temperature rating**

Temperature rating for conductor insulation: 140 °F (60 °C).

Temperature rating for outer cable sheath: 167 °F (75 °C).

4.2.3 Power supply

**DANGER**



**Electric shock**

- Death or serious personal injury
- Use the recommended fuse size, see 10.3.1 Supply voltage

**Single-phase supply voltage**

- 1 x 200-240 V - 10 %/+ 10 %, 50/60 Hz, PE.

Check that the supply voltage and frequency correspond to the values stated on the nameplate.



If you want to supply the motor through an IT network, make sure that you have a suitable motor variant. If you are in doubt, contact Grundfos.

The wires in the motor terminal box must be as short as possible. Excepted from this is the separated ground conductor which must be so long that it is the last one to be disconnected in case the cable is inadvertently pulled out of the cable entry.

For maximum backup fuse, see 10.3.1 Supply voltage.

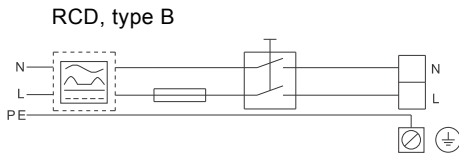

TM05 4034 1912

**Fig. 4** Example of a power supply-connected motor with power supply switch, backup fuse and additional protection

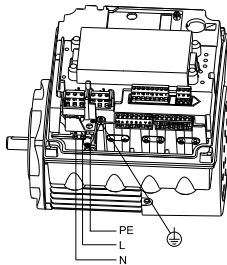

**Fig. 5** Power supply connection, single-phase motors

**Three-phase supply voltage**

- 3 x 440-480 V - 10 %/+ 10 %, 50/60 Hz, PE
- 3 x 200-240 V - 10 %/+ 10 %, 50/60 Hz, PE.

Check that the supply voltage and frequency correspond to the values stated on the nameplate.

The wires in the motor terminal box must be as short as possible. Excepted from this is the separated ground conductor which must be so long that it is the last one to be disconnected in case the cable is inadvertently pulled out of the cable entry.

In order to avoid loose connections, make sure that you have pressed home the terminal block for L1, L2 and L3 in its socket when you connect the supply cable.

For maximum backup fuse, see 10.4.1 Supply voltage.



If you want to supply the motor through an IT network, make sure that you have a suitable motor variant. If you are in doubt, contact Grundfos.



Corner grounding is not allowed for supply voltages above 3 x 480 V, 50/60 Hz.

**RCD, type B**

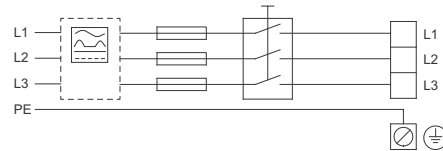

TM05 3942 1812

**Fig. 6** Example of a power supply-connected motor with power supply switch, backup fuses and additional protection

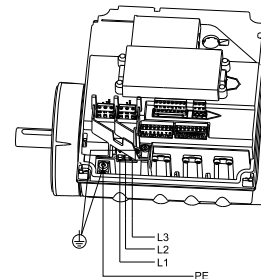

TM05 3495 1512

**Fig. 7** Power supply connection, three-phase motors



#### 4.2.4 Additional protection

### DANGER



#### Electric shock

Death or serious personal injury

- Only use residual-current circuit breakers (ELCB, GFCI, RCD) of type B.

The residual-current circuit breaker must be marked with the following symbol:



The total leakage current of all the electrical equipment in the installation must be taken into account. You find the leakage current of the motor in sections *10.3.2 Leakage current* and *10.4.2 Leakage current (AC)*.

This product can cause a direct current in the protective ground conductor.

#### Overvoltage and undervoltage protection

Overvoltage and undervoltage may occur in case of unstable power supply or a faulty installation. The motor is stopped if the voltage falls outside the permissible voltage range. The motor restarts automatically when the voltage is again within the permissible voltage range. Therefore, no additional protection relay is required.



The motor is protected against transients from the power supply according to EN 61800-3. In areas with high lightning intensity, we recommend external lightning protection.

#### Overload protection

If the upper load limit is exceeded, the motor automatically compensates for this by reducing the speed and stops if the overload condition persists.

The motor remains stopped for a set period. After this period, the motor automatically attempts to restart. The overload protection prevents damage to the motor. Consequently, no additional motor protection is required.

#### Overtemperature protection

The electronic unit has a built-in temperature sensor as an additional protection. When the temperature rises above a certain level, the motor automatically compensates for this by reducing the speed and stops if the temperature keeps rising. The motor remains stopped for a set period. After this period, the motor automatically attempts to restart.

#### Protection against phase unbalance

Three-phase motors must be connected to a power supply with a quality corresponding to IEC 60146-1-1, class C, to ensure correct motor operation at phase unbalance. This also ensures long life of the components.

#### 4.2.5 Connection terminals

The descriptions and terminal overviews in this section apply to both single- and three-phase motors.

For maximum torques, see section, *Torques*, page 34.

#### Connection terminals, CREDP pumps

CREDP pumps have a number of inputs and outputs enabling the pumps to be used in advanced applications where many inputs and outputs are required.

The pumps have these connections:

- three analog inputs
- one analog output
- two dedicated digital inputs
- two configurable digital inputs or open-collector outputs
- Grundfos Digital Sensor input and output
- two Pt100/1000 inputs
- two LiqTec sensor inputs
- two signal relay outputs
- GENIbus connection.

See fig. 8.



Digital input 1 is factory-set to be start-stop input where open circuit results in stop. A jumper has been factory-fitted between terminals 2 and 6. Remove the jumper if digital input 1 is to be used as external start-stop or any other external function.

### DANGER

#### Electric shock



Death or serious personal injury

- Make sure that the wires to be connected to the connection groups below are separated from each other by reinforced insulation in their entire lengths.

- Inputs and outputs

All inputs and outputs are internally separated from the power supply-conducting parts by reinforced insulation and galvanically separated from other circuits. All control terminals are supplied by protective extra-low voltage (PELV), thus ensuring protection against electric shock.

- Start-stop: (Digital input 1) = Terminals 2 and 6
- Pressure sensor: (Analog input 1) = Terminals 4 and 8
- Pressure switch: (Digital input 3) = Terminals 6 and 10
- External analog signal input: (Analog input 2) = Terminals 7 and 23
- GENIbus Terminals A, Y and B
- Signal relay outputs
  - Signal relay 1:
    - LIVE:
      - You can connect supply voltages up to 250 VAC.
    - PELV:
      - The output is galvanically separated from other circuits. Therefore, you can connect the supply voltage or protective extra-low voltage to the output as desired.
  - Signal relay 2:
    - PELV:
      - The output is galvanically separated from other circuits. Therefore, you can connect the supply voltage or protective extra-low voltage to the output as desired.

Power supply (terminals N, PE, L or L1, L2, L3, PE).

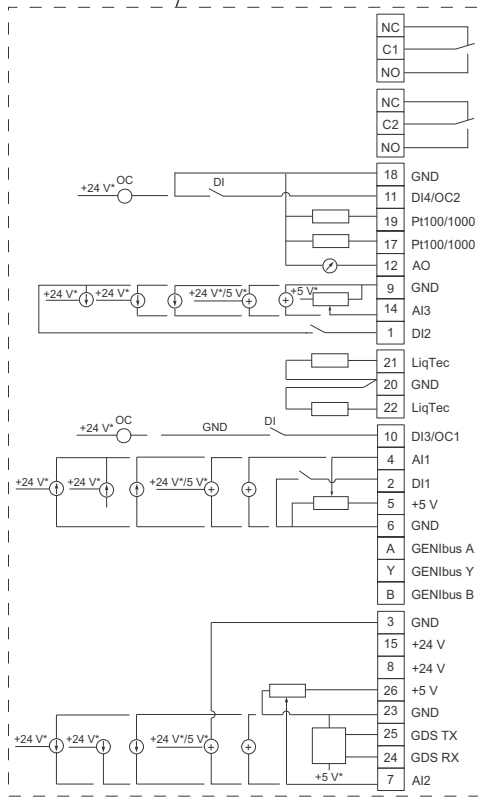
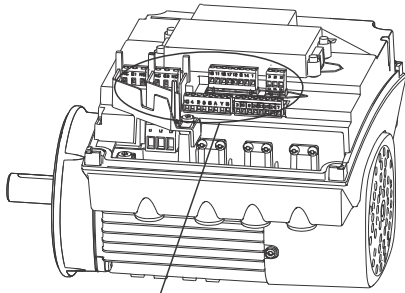

TM05 3509 3512

\* If you use an external supply source, there must be a connection to GND.

**Fig. 8** Connection terminals, CRE, CRIE, CRNE, CRKE, SPKE, MTRE and CME pumps

Terminal	Type	Function
NC	Normally closed contact	
C1	Common	Signal relay 1 (LIVE or PELV)
NO	Normally open contact	
NC	Normally closed contact	
C2	Common	Signal relay 2 (PELV only)
NO	Normally open contact	
18	GND	Ground
11	DI4/OC2	Digital input/output, configurable. Open collector: Max. 24 V resistive or inductive.

Terminal	Type	Function
19	Pt100/1000 input 2	Pt100/1000 sensor input
17	Pt100/1000 input 1	Pt100/1000 sensor input
12	AO	Analog output: 0-20 mA / 4-20 mA 0-10 V
9	GND	Ground
14	AI3	Analog input: 0-20 mA / 4-20 mA 0-10 V
1	DI2	Digital input, configurable
21	LiqTec sensor input 1	LiqTec sensor input (white conductor)
20	GND	Ground (brown and black conductors)
22	LiqTec sensor input 2	LiqTec sensor input (blue conductor)
10	DI3/OC1	Digital input/output, configurable. Open collector: Max. 24 V resistive or inductive.
4	AI1	Analog input: 0-20 mA / 4-20 mA 0.5 - 3.5 V / 0-5 V / 0-10 V
2	DI1	Digital input, configurable
5	+5 V	Supply to potentiometer and sensor
6	GND	Ground
A	GENIbus, A	GENIbus, A (+)
Y	GENIbus, Y	GENIbus, GND
B	GENIbus, B	GENIbus, B (-)
3	GND	Ground
15	+24 V	Supply
8	+24 V	Supply
26	+5 V	Supply to potentiometer and sensor
23	GND	Ground
25	GDS TX	Grundfos Digital Sensor output
24	GDS RX	Grundfos Digital Sensor input
7	AI2	Analog input: 0-20 mA / 4-20 mA 0.5 - 3.5 V / 0-5 V / 0-10 V

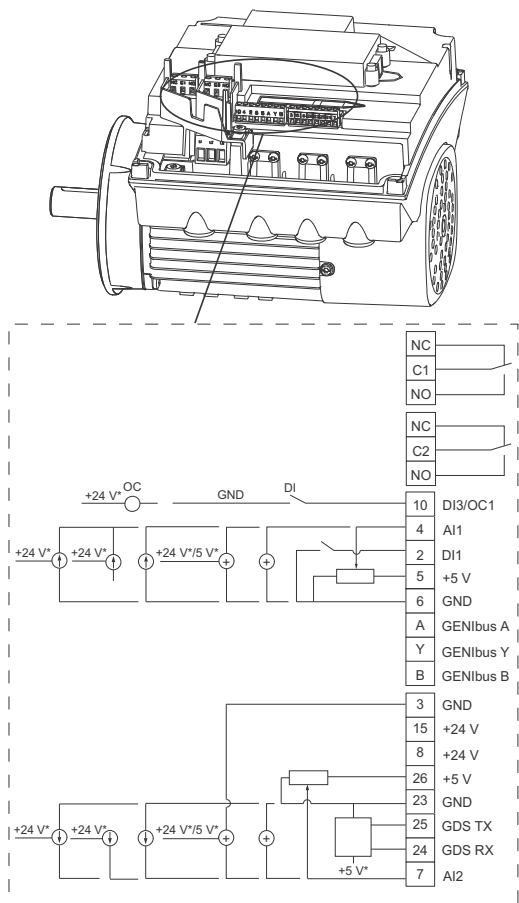

TM05 3510 3512

\* If you use an external supply source, there must be a connection to GND.

**Fig. 9** Connection terminals, optional for CREDP pumps.

Terminal	Type	Function
NC	Normally closed contact	Signal relay 1 (LIVE or PELV)
C1	Common	
NO	Normally open contact	
NC	Normally closed contact	Signal relay 2 (PELV only)
C2	Common	
NO	Normally open contact	
10	DI3/OC1	Digital input/output, configurable. Open collector: Max. 24 V resistive or inductive.
4	AI1	Analog input: 0-20 mA / 4-20 mA 0.5 - 3.5 V / 0-5 V / 0-10 V
2	DI1	Digital input, configurable
5	+5 V	Supply to potentiometer and sensor
6	GND	Ground
A	GENIbus, A	GENIbus, A (+)
Y	GENIbus, Y	GENIbus, GND
B	GENIbus, B	GENIbus, B (-)
3	GND	Ground
15	+24 V	Supply
8	+24 V	Supply
26	+5 V	Supply to potentiometer and sensor
23	GND	Ground
25	GDS TX	Grundfos Digital Sensor output
24	GDS RX	Grundfos Digital Sensor input
7	AI2	Analog input: 0-20 mA / 4-20 mA 0.5 - 3.5 V / 0-5 V / 0-10 V

#### 4.2.6 Signal cables

- Use screened cables with a cross-sectional area of minimum 28 AWG and maximum 16 AWG for the external on/off switch, digital inputs, setpoint and sensor signals.
- Connect the screens of the cables to the frame at both ends with good connection. The screens must be as close as possible to the terminals. See fig. 10.

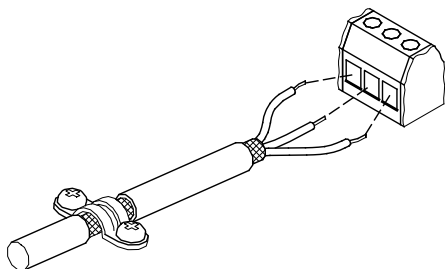

**Fig. 10** Stripped cable with screen and wire connections

- Always tighten screws for frame connections whether a cable is fitted or not.
- The wires in the motor terminal box must be as short as possible.

TM02 1325 4402

#### 4.2.7 Bus connection cable

##### New installations

For the bus connection, use a screened 3-core cable with a cross-sectional area of minimum 28 AWG and maximum 16 AWG.

If the motor is connected to a unit with a cable clamp which is identical to the one on the motor, connect the screen to this cable clamp.

If the unit has no cable clamp leave the screen unconnected at this end. See fig. 11.

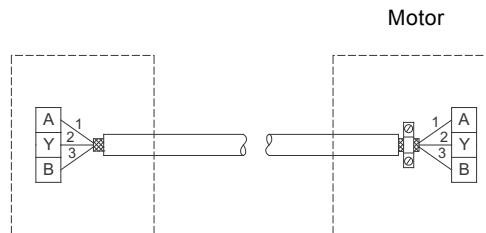
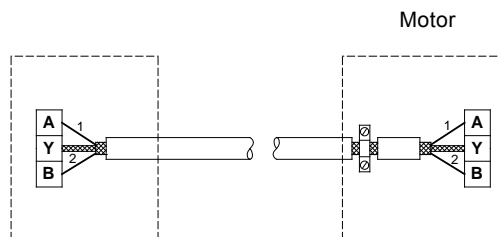

**Fig. 11** Connection with screened 3-core cable

TM05 3973 1812

##### Replacing a motor

- If a 2-core cable is used in the installation, connect it as shown in fig. 12.



**Fig. 12** Connection with screened 2-core cable

TM02 8842 0904

If a screened 3-core cable is used in the installation, follow the instructions in section, *New installations* above.

### 4.3 Installing a communication interface module

#### DANGER

##### Electric shock



Death or serious personal injury  
 - Switch off the power supply to the motor and to the signal relays. Wait at least 5 minutes before starting any work on the motor. Make sure that the power supply cannot be accidentally switched on.



Always use an antistatic service kit when handling electronic components. This prevents static electricity from damaging the components.

When unprotected, place the component on the antistatic cloth.

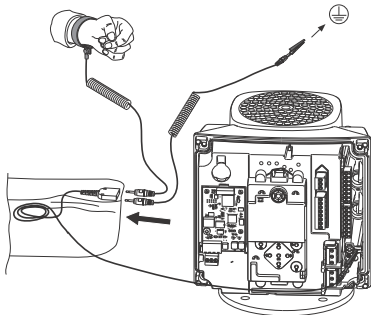

Fig. 13 Antistatic service kit

1. Loosen the four screws (fig. 14, A) and remove the terminal box cover (fig. 14, B).

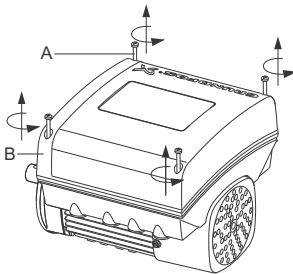

Fig. 14 Removing the terminal box cover

2. Remove the CIM cover (fig. 15, A) by pressing the locking tab (fig. 15, B) and lifting the end of the cover (fig. 15, C). Then lift the cover off the hooks (fig. 15, D).

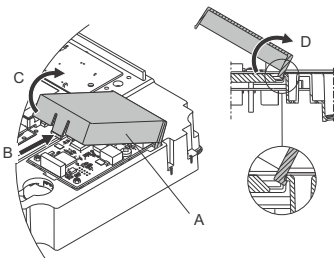

Fig. 15 Removing the CIM cover

3. Remove the securing screw (fig. 16, A).

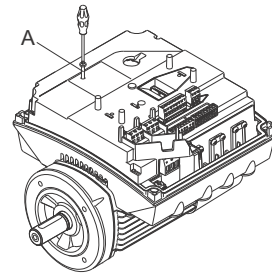

Fig. 16 Removing the securing screw

4. Fit the CIM module by aligning it with the three plastic holders (fig. 17, A) and the connecting plug (fig. 17, B). Press home the module using your fingers.

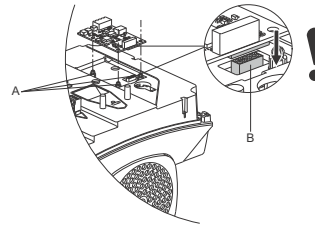

Fig. 17 Fitting the CIM module

5. Fit and tighten securing screw (fig. 16, A) to 1.3 Nm.
6. Make the electrical connections to the CIM module as described in the instructions delivered with the module.
7. Connect the cable screens of the bus cables to ground via one of the ground clamps (fig. 18, A).

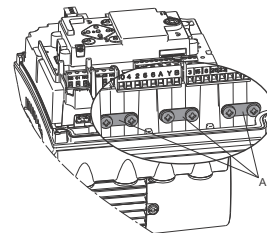

Fig. 18 Connecting the cable screens to ground

TM06 4082 1515

TM06 4462 2315

TM06 4083 1515

TM06 4081 1515

TM06 4195 1615

TM06 4084 1515

- Route the wires for the CIM module. See the example in fig. 19.

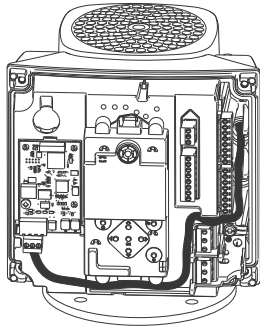

**Fig. 19** Example of wire routing

- Fit the CIM cover.
- If the CIM module is supplied with an FCC label, then place this on the terminal box. See fig. 20.

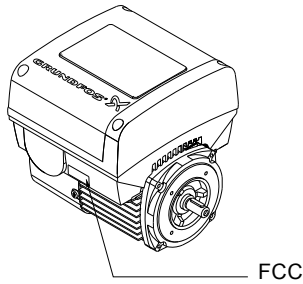

**Fig. 20** FCC label

- Fit the terminal box cover (fig. 14, B) and cross-tighten the four mounting screws (fig. 14, A) to 6 Nm.



Make sure that the terminal box cover is aligned with the control panel. See section 4.4 *Changing the position of the control panel*.

#### 4.4 Changing the position of the control panel

### DANGER

#### Electric shock



Death or serious personal injury

- Switch off the power supply to the motor and to the signal relays. Wait at least 5 minutes before starting any work on the motor. Make sure that the power supply cannot be accidentally switched on.

You can turn the control panel 180°. Follow the instructions below.

- Loosen the four screws (TX25) of the terminal box cover.

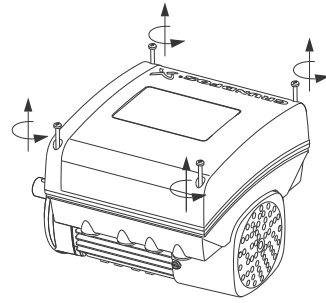

**Fig. 21** Loosening the screws

- Remove the terminal box cover.

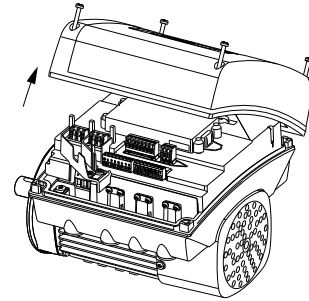

**Fig. 22** Removing the terminal box cover

- Press and hold in the two locking tabs (A) while gently lifting the plastic cover (B).

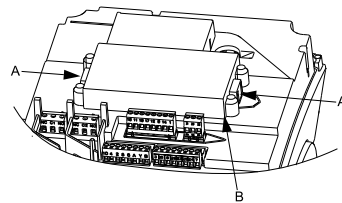

**Fig. 23** Lifting the plastic cover

- Turn the plastic cover 180°.



Do not twist the cable more than 90°.

TM06 4085 1515

TM05 7028 0413

TM05 5351 3612

TM05 5352 3612

TM05 5353 3612

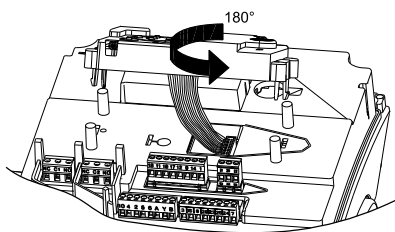

**Fig. 24** Turning the plastic cover

5. Position the plastic cover correctly on the four rubber pins (C). Make sure that the locking tabs (A) are placed correctly.

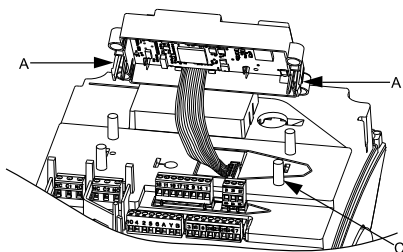

**Fig. 25** Positioning the plastic cover

6. Fit the terminal box cover, and make sure that it is also turned 180 ° so that the buttons on the control panel are aligned with the buttons on the plastic cover.
7. Tighten the four screws (TX25) with 5 Nm.

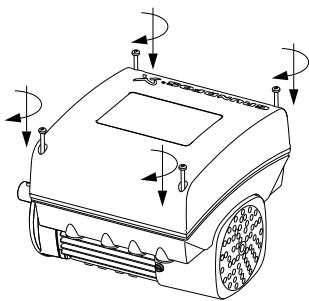

**Fig. 26** Fitting the terminal box cover

## 5. Product introduction

### 5.1 Product description

Grundfos E-pumps are fitted with frequency-controlled permanent-magnet motors for single-phase or three-phase power supply connection.

#### 5.1.1 Pumps without factory-fitted sensor

The pumps have a built-in PI controller and can be set for an external sensor enabling the control of the following parameters:

- constant pressure
- constant differential pressure
- constant temperature
- constant differential temperature
- constant flow rate
- constant level
- constant curve
- constant other value.

The pumps have been factory-set to constant-curve control mode. You can change the control mode with R100 or Grundfos GO.

#### 5.1.2 Pumps with factory-fitted pressure sensor

The pumps have a built-in PI controller and are set for a pressure sensor enabling the control of the outlet pressure.

The pumps have been factory-set to constant-pressure control mode. The pumps are typically used to keep a constant pressure in variable-demand systems.

#### 5.1.3 Settings

The description of settings applies both to pumps without factory-fitted sensor and to pumps with a factory-fitted pressure sensor.

##### Setpoint

You can set the desired setpoint in three ways:

- on the pump control panel
- via an input for external setpoint signal
- with the Grundfos wireless R100 remote control or Grundfos GO.

##### Other settings

Make all other settings with R100 or Grundfos GO.

You can read important parameters, such as the actual value of the control parameter and power consumption, via R100 or Grundfos GO.

If special or customized settings are required, use Grundfos PC Tool. Contact your local Grundfos company for more information.

TM05 5354 3612

TM05 5355 3612

TM05 5356 3612

**5.1.4 Radio communication**

This product incorporates a radio module for remote control which is a class 1 device and which you can use anywhere in the EU without restrictions.

For use in USA and Canada, see page 36.

Some variants of the product and products sold in China and Korea have no radio module.

This product can communicate with Grundfos GO and other products of the same type via the built-in radio module.

In some cases, an external antenna may be required. Only Grundfos-approved external antennas may be connected to this product, and only by a Grundfos-approved installer.

**5.1.5 Battery**

A Li-ion battery is fitted in CRE, CRIE, CRNE, CRKE, SPKE, MTRE and CME pumps. The Li-ion battery complies with the Battery Directive (2006/66/EC). The battery does not contain mercury, lead and cadmium.

**5.2 Identification**

**5.2.1 Identification of functional module**

You can identify the fitted module in one of the following ways:

**Grundfos GO**

You can identify the functional module in the "Fitted modules" menu under "Status".

**Pump display**

For pumps fitted with the advanced control panel, you can identify the functional module in the Fitted modules menu under Status.

**Motor nameplate**

You can identify the fitted module on the motor nameplate. See fig. 27.

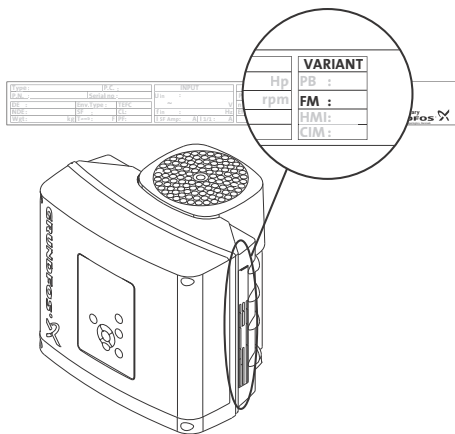

**Fig. 27** Identification of functional module

Variant	Description
FM 300	Advanced functional module

TM06 1889 3314

**5.2.2 Identification of control panel**

You can identify the fitted module in one of the following ways:

**Grundfos GO**

You can identify the control panel in the "Fitted modules" menu under "Status".

**Pump display**

For pumps fitted with the advanced control panel, you can identify the control panel in the "Module type" menu under "Status".

**Motor nameplate**

You can identify the fitted control panel on the motor nameplate. See fig. 28.

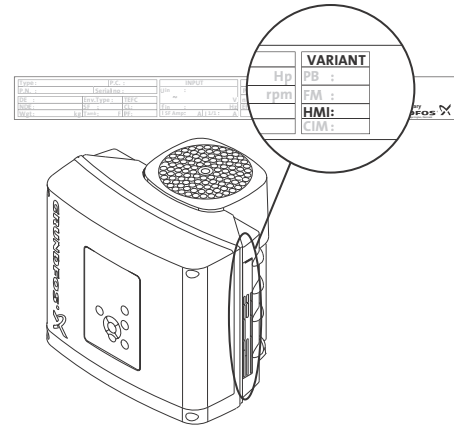

**Fig. 28** Identification of control panel

Variant	Description
HMI 300	Advanced control panel

**5.3 Bus signal**

The pump supports serial communication via an RS-485 input. The communication is carried out according to the Grundfos GENIbus protocol and enables connection to other pumps as well as a building management system or another external control system.

Via a bus signal, you can remote-set pump operating parameters, such as setpoint and operating mode. At the same time, the pump can, via the bus, provide status information about important parameters, such as actual value of control parameter, input power and fault indications.

Contact Grundfos for further information.



If you use a bus signal, the number of settings available via R100 or Grundfos GO are reduced.

TM06 4013 1415



### 5.4 Grundfos Eye

The operating condition of the pump is indicated by the Grundfos Eye on the control panel. See fig. 29, pos. A.

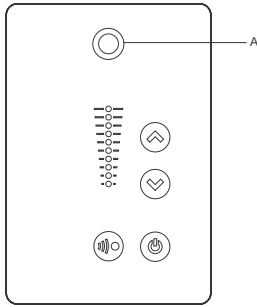

TM05 5993 4312

Fig. 29 Grundfos Eye



































































Grundfos Eye	Indication	Description
	No lights are on.	The power is off. The pump is not running.
	The two opposite green indicator lights are rotating in the direction of rotation of the pump when seen from the non-drive end.	The power is on. The pump is running.
	The two opposite green indicator lights are permanently on.	The power is on. The pump is running.
	One yellow indicator light is rotating in the direction of rotation of the pump when seen from the non-drive end.	Warning. The pump is running.
	One yellow indicator light is permanently on.	Warning. The pump is stopped.
	The two opposite red indicator lights flash simultaneously.	Alarm. The pump is stopped.
	The green indicator light in the middle flashes quickly four times.	This is a feedback signal which the pump gives in order to ensure identification of itself.
	The green indicator light in the middle flashes continuously.	Grundfos GO or another pump is trying to communicate with the pump. Press  on the pump control panel to allow communication.
	The green indicator light in the middle is permanently on.	Remote control with Grundfos GO via radio. The pump is communicating with Grundfos GO via radio connection.
	The green indicator light in the middle flashes quickly while Grundfos Go is exchanging data with the pump. It takes a few seconds.	Remote control with Grundfos GO via infrared light. The pump is receiving data from Grundfos GO via infrared communication.

### 5.5 Signal relays

The motor has two outputs for potential-free signals via two internal relays.

The signal outputs can be set to "Operation", "Pump running", "Ready", "Alarm" and "Warning".

The functions of the two signal relays appear from the table below:

Description	Grundfos Eye	Contact position for signal relays when activated					Operating mode
		Operation	Pump running	Ready	Alarm	Warning	
The power is off.	 Off						-
The pump runs in "Normal" mode.	 Green, rotating						"Normal", "Min." or "Max."
The pump runs in "Manual" mode.	 Green, rotating						"Manual"
The pump is in operating mode "Stop".	 Green, steady						"Stop"
Warning, but the pump is running.	 Yellow, rotating						"Normal", "Min." or "Max."
Warning, but the pump runs in "Manual" mode.	 Yellow, rotating						"Manual"
Warning, but the pump was stopped via a "Stop" command.	 Yellow, steady						"Stop"
Alarm, but the pump is running.	 Red, rotating						"Normal", "Min." or "Max."
Alarm, but the pump runs in "Manual" mode.	 Red, rotating						"Manual"
The pump is stopped due to an alarm.	 Red, flashing						"Stop"
The pump is stopped due to "Low-flow stop function".	 Green, steady						"Normal"

## 6. User interfaces



### WARNING

#### Hot surface

- Death or serious personal injury
- Only touch the buttons on the display as the product may be very hot.

You can make the pump settings by means of the following user interfaces:

#### Control panels

- Advanced control panel.  
See section 6.1 *Advanced control panel*.

#### Remote controls

- Grundfos GO.  
See section 7.1 *Grundfos GO Remote*.
- Grundfos R100 remote control.

If the power supply to the pump is switched off, the settings are stored.

### 6.1 Advanced control panel

The pumps are fitted with the advanced control panel as standard.

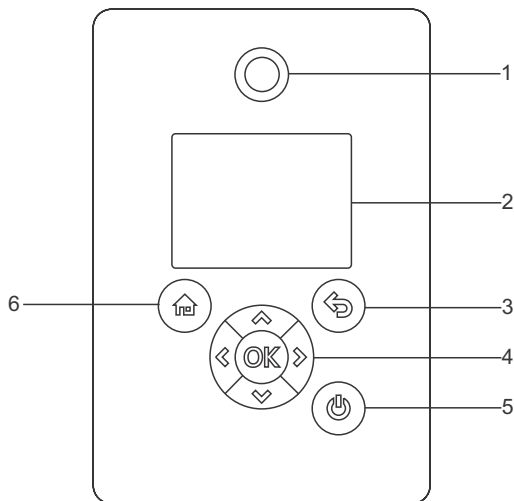

Fig. 30 Advanced control panel

TM05 4849 1013

Pos.	Symbol	Description
1		Grundfos Eye This shows the operating status of the pump. For further information, see section 4.4 <i>Changing the position of the control panel</i> .
2	-	Graphical color display.
3		It goes one step back.
		With these buttons you can navigate between main menus, displays and digits. When you change the menu, the display always shows the top display of the new menu.
		With these buttons you can navigate between submenus. They change value settings. Note: If you have disabled the possibility to make settings with the "Enable/disable settings" function, then you can enable it again temporarily by pressing these buttons simultaneously for at least 5 seconds. See section 7.29 "Buttons on product" ("Enable/disable settings").
4		It saves changed values, resets alarms and expands the value field. It enables radio communication with Grundfos GO and other products of the same type. When you try to establish radio communication between the pump and Grundfos GO or another pump, the green indicator light in Grundfos Eye flashes. A note also appears in the pump display stating that a wireless device wants to connect to the pump. Press  on the pump control panel to allow radio communication with Grundfos GO and other products of the same type.
5		This makes the pump ready for operation/starts and stops the pump. Start: If you press the button when the pump is stopped, the pump only starts if no other functions with higher priority have been enabled. See section 8. Description of settings. Stop: If you press the button when the pump is running, the pump is always stopped. When you stop the pump via this button, the  icon appears in the bottom of the display.
6		This button goes to the "Home" menu.

6.1.1 Home display



Fig. 31 Example of "Home" display

Pos.	Symbol	Description
1		"Home" This menu shows up to four user-defined parameters. You can select parameters shown as shortcut icon , and when pressing <b>OK</b> you go directly to the "Settings" display for the selected parameter.
2	-	"Status" This menu shows the status of the pump and system as well as warnings and alarms.
3	-	"Settings" This menu gives access to all setting parameters. You can make detailed settings of the pump in this menu. See section 7, Description of functions.
4	-	"Assist" This menu enables assisted pump setup, provides a short description of the control modes and offers fault advice. See section 8.2 <i>Assist</i> .
5		This symbol indicates that the pump has been stopped via the  button.
6		This symbol indicates that the pump is functioning as master pump in a multipump system.
7		This symbol indicates that the pump is functioning as a slave pump in a multipump system.
8		This symbol indicates that the pump is operating in a multipump system. See section 7.44 "Multi-pump setup" ("Setup of multi-pump system").
9		This symbol indicates that the possibility to make settings has been disabled for protective reasons.

6.1.2 Startup guide

The pump incorporates a startup guide which is started at the first startup. After the startup guide, the main menus appear in the display.

7. Setting the product

7.1 Grundfos GO Remote

The pump is designed for wireless radio or infrared communication with the Grundfos GO Remote.

The Grundfos GO Remote enables setting of functions and gives access to status overviews, technical product information and actual operating parameters.

The Grundfos GO Remote offers three different mobile interfaces (MI). See fig. 32.

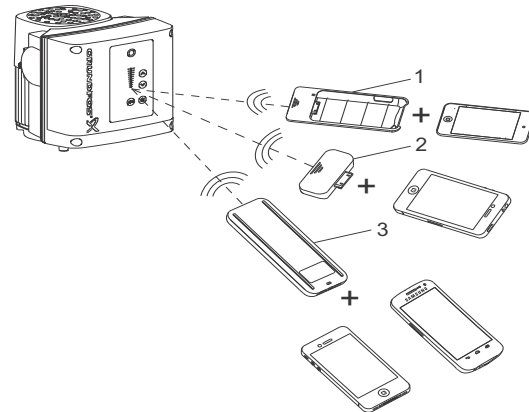

Fig. 32 Grundfos GO Remote communicating with the pump via radio or infrared light

Pos.	Description
1	Grundfos MI 201: Consists of an Apple iPod touch 4G and a Grundfos cover.
2	Grundfos MI 202: Add-on module which can be used in conjunction with Apple iPod touch 4G, iPhone 4G or 4GS. Grundfos MI 204: Add-on module which can be used in conjunction with Apple iPod touch 5G or iPhone 5.
3	Grundfos MI 301: Separate module enabling radio or infrared communication. The module can be used in conjunction with an Android or iOS-based Smartphone with Bluetooth connection.

7.1.1 Communication

When the Grundfos GO Remote communicates with the pump, the indicator light in the middle of the Grundfos Eye will flash green. See section .

Communication must be established using one of these communication types:

- radio communication
- infrared communication.

7.1.2 Radio communication

Radio communication can take place at distances up to 30 meters. It is necessary to enable communication by pressing or **OK** on the pump control panel.

7.1.3 Infrared communication

When communicating via infrared light, the Grundfos GO Remote must be pointed at the pump control panel.

## 7.2 Menu overview for Grundfos GO Remote

### 7.2.1 Main menus

Dashboard		
<b>Status</b>		
Resulting setpoint		
Actual controlled value		
Motor speed (rpm, %)		
Power consumption		
Energy consumption		
Operating hours		
Pt100/1000 input 1		
Pt100/1000 input 2		
Analog output		
Analog input 1		
Analog input 2		
Analog input 3		
Digital input 1		
Digital input 2		
Digital input 3		
Digital input 4		
Fitted modules		
Settings	Section	Page
Setpoint	8.1.1 <i>Setpoint</i>	23
Operating mode	8.1.2 <i>Operating mode</i>	23
Control mode	8.1.4 <i>Control mode</i>	23
Operating range	8.1.12 <i>Operating range</i>	26
Pump number	8.1.14 <i>Pump number</i>	27
Radio communication		
Analog input 1		
Analog input 2	8.1.6 <i>Analog inputs</i>	24
Analog input 3		
Pt100/1000 input 1		
Pt100/1000 input 2	8.1.7 <i>Pt100/1000 inputs</i>	24
Digital input 1		
Digital input 2	8.1.8 <i>Digital inputs</i>	25
Digital in/output 3		
Digital in/output 4	8.1.9 <i>Digital inputs/outputs</i>	25
Analog output	8.1.11 <i>Analog output</i>	26
External setpoint funct.	<i>External setpoint influence</i>	26
Signal relay 1		
Signal relay 2	8.1.10 <i>Relay outputs</i>	26
Standstill heating		
Motor bearing monitoring		
Service		
Reset to factory settings		
Store settings		
Recall settings		
Undo		
Pump name		
Unit configuration		

---

**Alarms and warnings**

---

Alarm log

---

Warning log

---

"Reset alarm" button

---

---

**Assist**

---

Assisted pump setup

---

Assisted fault advice

---

Multi-pump setup

---

---

**Product information**

---

Product information

---

## 8. Control functions

### 8.1 Description of selected functions

#### 8.1.1 Setpoint

The setpoint for all control modes can be set in this submenu when the desired control mode has been selected. See section 8.1.4 *Control mode*.

#### 8.1.2 Operating mode

Possible operating modes:

- Normal  
The pump runs according to the selected control mode.
- Stop  
The pump stops.
- Min.  
The min. curve mode can be used in periods in which a minimum flow is required.
- Max.  
The max. curve mode can be used in periods in which a maximum flow is required.  
This operating mode is for instance suitable for systems with hot-water priority.
- Manual  
The pump is operating at a manually set speed.  
See section 8.1.3 *Set manual speed*.

The pump can be set to operate according to the max. or min. curve, like an uncontrolled pump. See fig. 33.

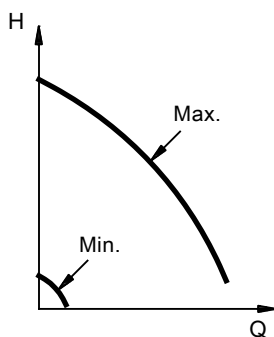

Fig. 33 Max. and min. curves

#### 8.1.3 Set manual speed

The pump speed can be set in %. When the operating mode has been set to "Manual", the pump will run at the set speed.

#### 8.1.4 Control mode

Possible control modes:

- Prop. pressure (proportional differential pressure)
- Con. diff. press. (constant differential pressure)
- Const. curve (constant curve).



The operating mode must be set to "Normal" before a control mode can be enabled.

The setpoint for all control modes can be changed in the "Setpoint" submenu under "Settings" when the desired control mode has been selected.

### Proportional pressure

The pump head is reduced at decreasing water demand and increased at rising water demand. See fig. 34.

This control mode is especially suitable in systems with relatively large pressure losses in the distribution pipes. The head of the pump will increase proportionally to the flow in the system to compensate for the large pressure losses in the distribution pipes.

The setpoint can be set with an accuracy of 0.14 psi. The head against a closed valve is half the setpoint,  $H_{set}/2$ .

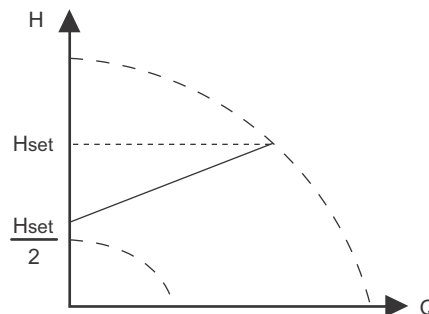

Fig. 34 Proportional pressure

This control mode requires a factory-fitted differential-pressure sensor as shown in the example below:

#### Example

- Factory-fitted differential-pressure sensor.



Fig. 35 Proportional pressure

### Constant differential pressure

The pump maintains a constant differential pressure, independently of the flow in the system. See fig. 36. This control mode is primarily suitable for systems with relatively small pressure losses.

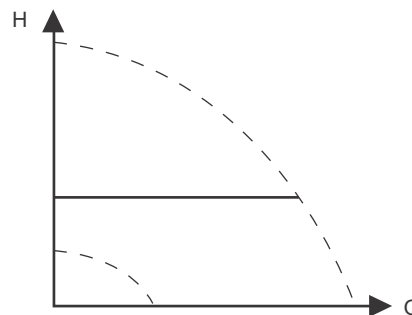

Fig. 36 Constant differential pressure

TM05 7909 1613

TM00 5547 0995

TM05 7901 1613

This control mode requires either a factory-fitted or external differential-pressure sensor or two external pressure sensors as shown in the examples below:

**Examples**

- Factory-fitted differential-pressure sensor.

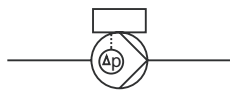

- One external differential-pressure sensor.

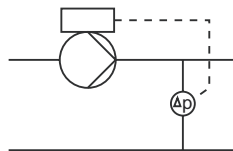

- Two external pressure sensors.

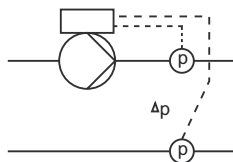
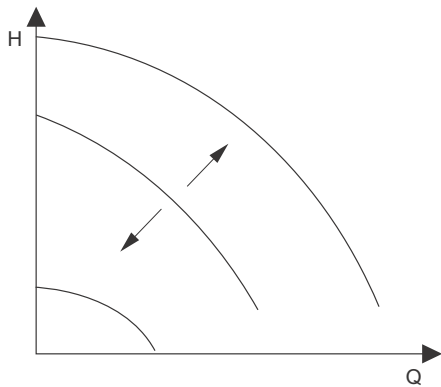

**Fig. 37** Constant differential pressure

**8.1.5 Constant curve**

The pump can be set to operate according to a constant curve, like an uncontrolled pump. See fig. 38.

The desired speed can be set in % of maximum speed in the range from 25 to 100 % (110 %).



**Fig. 38** Constant curve

**8.1.6 Analog inputs**

Available inputs depending on the functional module fitted in the pump:

Function (terminal)	FM 300 (advanced)
Analog input 1, setup (4)	•
Analog input 2, setup (7)	•
Analog input 3, setup (14)	•

To set up an analog input, make the settings below.

**Function**

The analog inputs can be set to these functions:

- Not active
- Feedback sensor
- Ext. setpoint infl.  
See section 8.1.13 *Setpoint influence*.
- Other function.

**Measured parameter**

Select one of the parameters, i.e. the parameter to be measured in the system by the sensor connected to the actual analog input.

**Unit**

Available measuring units:

Parameter	Possible units
Pressure	bar, m, kPa, psi, ft
Pump flow	m <sup>3</sup> /h, l/s, yd <sup>3</sup> /h, gpm
Liquid temp.	°C, °F
Other parameter	%

**Electrical signal**

Select signal type (0.5 - 3.5 V, 0-5 V, 0-10 V, 0-20 mA or 4-20 mA).

**Sensor range, min. value**

Set the min. value of the connected sensor.

**Sensor range, max. value**

Set the max. value of the connected sensor.

**8.1.7 Pt100/1000 inputs**

Available inputs depending on the functional module fitted in the pump:

Function (terminal)	FM 300 (advanced)
Pt100/1000 input 1, setup (17 and 18)	•
Pt100/1000 input 2, setup (18 and 19)	•

**Function**

The Pt100/1000 inputs can be set to these functions:

- Not active
- Feedback sensor
- Ext. setpoint infl.  
See section 8.1.13 *Setpoint influence*.
- Other function.

**Measured parameter**

Select one of the parameters, i.e. the parameter to be measured in the system.

TM05 7957 1713



### 8.1.8 Digital inputs

Available inputs depending on the functional module fitted in the pump:

Function (terminal)	FM 300 (advanced)
Digital input 1, setup (2 and 6)	•
Digital input 2, setup (1 and 9)	•

To set up a digital input, make the settings below.

#### Function

Select one of these functions:

- Not active  
When set to "Not active", the input has no function.
- External stop  
When the input is deactivated (open circuit), the pump will stop.
- Min. (min. speed)  
When the input is activated, the pump will run at the set min. speed.
- Max. (max. speed)  
When the input is activated, the pump will run at the set max. speed.
- External fault  
When the input is activated, a timer will be started. If the input is activated for more than 5 seconds, the pump will be stopped and a fault will be indicated.
- Alarm resetting  
When the input is activated, a possible fault indication will be reset.

The priority of the selected functions in relation to each other appears from section .

A stop command will always have the highest priority.

### 8.1.9 Digital inputs/outputs

Available inputs/outputs depending on the functional module fitted in the pump:

Function (terminal)	FM 300 (advanced)
Digital input/output 3, setup (10 and 16)	•
Digital input/output 4, setup (11 and 18)	•

To set up a digital input/output, make the settings below.

#### Mode

The digital input/output 3 and 4 can be set to act as digital input or digital output:

- Digital input
- Digital output.

#### Function

The digital input/output 3 and 4 can be set to these functions:

#### Possible functions, digital input/output 3

Function if input	Function if output
• Not active	• Not active
• External stop	• Ready
• Min.	• Alarm
• Max.	• Operation
• External fault	• Pump running
• Alarm resetting	• Warning

#### Possible functions, digital input/output 4

Function if input	Function if output
• Not active	• Not active
• External stop	• Ready
• Min.	• Alarm
• Max.	• Operation
• External fault	• Pump running
• Alarm resetting	• Warning

### 8.1.10 Relay outputs

Function (terminal)	FM 300 (advanced)
Relay output 1 (NC, C1, NO)	•
Relay output 2 (NC, C2, NO)	•

The pump incorporates two signal relays for potential-free signalling.

The signal relays can be configured to be activated by one of the following incidents:

- Ready
- Operation
- Alarm
- Warning
- Pump running
- Control of external fan
- Not active.

### 8.1.11 Analog output

Whether the analog output is available or not, depends on the functional module fitted in the pump:

Function (terminal)	FM 300 (advanced)
Analog output	•

To set up the analog output, make the settings below.

#### Output signal

- 0-10 V
- 0-20 mA
- 4-20 mA.

#### Function of analog output

- Actual speed
- Actual value
- Resulting setpoint
- Motor load
- Motor current.

### 8.1.12 Operating range

Set the operating range as follows:

- Set the min. speed within the range from fixed min. speed to user-set max. speed.
- Set the max. speed within the range from user-set min. speed to fixed max. speed.

The range between the user-set min. and max. speeds is the operating range. See fig. 39.



Speeds below 25 % may result in noise from the shaft seal.

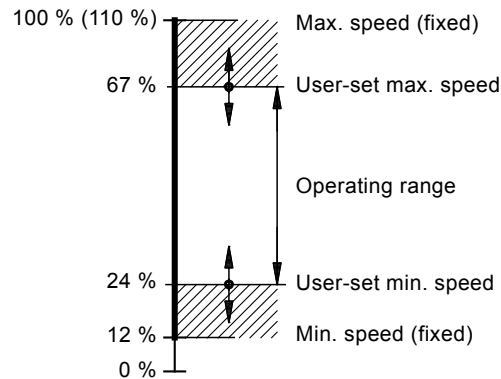

Fig. 39 Example of min. and max. settings

TM00 6785 5095

### 8.1.13 Setpoint influence

#### External setpoint influence

It is possible to influence the setpoint by an external signal, either via one of the analog inputs or, if an advanced functional module is fitted, via one of the Pt100/1000 inputs.



Before the "Digital inputs" can be enabled, one of the analog inputs or Pt100/1000 inputs must be set to "External setpoint function".

See sections 8.1.6 *Analog inputs* and 8.1.7 *Pt100/1000 inputs*.

If more than one input has been set up for setpoint influence, the function will select the analog input with the lowest number, for example "Analog input 2", and ignore the other inputs, for example "Analog input 3" or "Pt100/1000 input 1".

#### Example

See fig. 40.

At a lower sensor value of 0 bar, a set setpoint of 30 psi and an external setpoint of 60 %, the actual setpoint is  $0.60 \times (30 - 0) + 0 = 18$  psi.

Actual setpoint = actual input signal x (setpoint - lower value) + lower value.

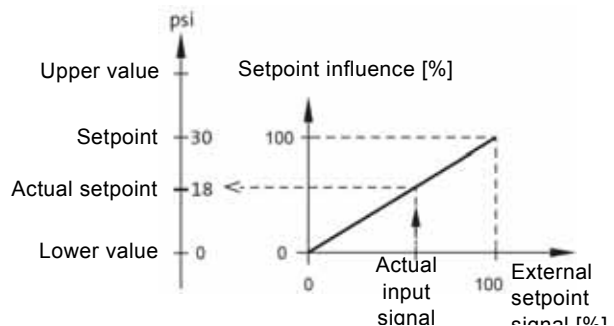

Fig. 40 Example of setpoint influence

TM06 3636 0215

### Types of setpoint influence

- Not active
- Linear function
- Linear with Min.

These functions can be selected:

- Not active  
When set to "Not active", the setpoint will not be influenced from any external function.
- Linear function  
The setpoint is influenced linearly from 0 to 100 %. See fig. 41.

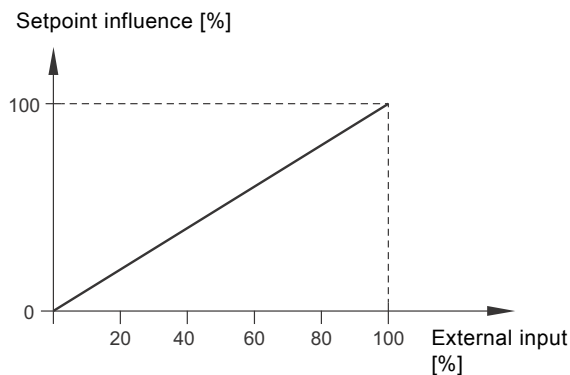

Fig. 41 Linear function

– Linear with Min.

In the input signal range from 20 to 100 %, the setpoint is influenced linearly.

If the input signal is below 10 %, the pump will change to operating mode "Min.".

If the input signal is increased above 15 %, the operating mode will be changed back to "Normal".

See fig. 42.

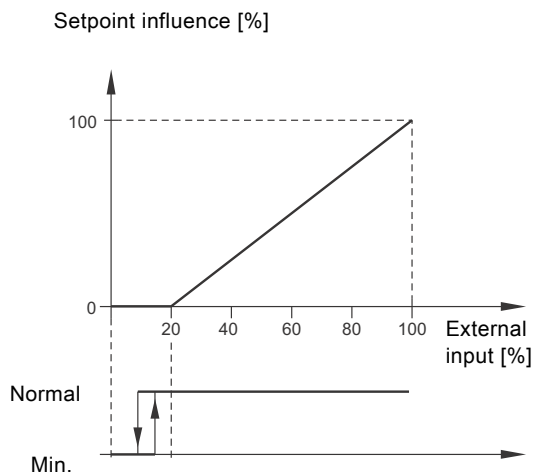

Fig. 42 Linear with Min.

Digital inputs			Setpoint
2	3	4	
0	0	0	Normal setpoint
1	0	0	Predefined setpoint 1
0	1	0	Predefined setpoint 2
1	1	0	Predefined setpoint 3
0	0	1	Predefined setpoint 4
1	0	1	Predefined setpoint 5
0	1	1	Predefined setpoint 6
1	1	1	Predefined setpoint 7

#### 8.1.14 Pump number

A unique number can be allocated to the pump. This makes it possible to distinguish between pumps in connection with bus communication.

#### 8.1.15 General settings

##### Language

A number of languages is available.

Measuring units are automatically changed according to selected language.

#### 8.2 Assist

##### 8.2.1 Alternating operation

Only one pump is operating at a time. The change from one pump to the other depends on time or energy. If a pump fails, the other pump will take over automatically.

Pump system:

- Two pumps connected in parallel.

The pumps must be of the same type and size. Each pump requires a non-return valve in series with the pump.

##### 8.2.2 Back-up operation

One pump is operating continuously. The back-up pump is operated at intervals to prevent seizing up. If the duty pump stops due to a fault, the back-up pump will start automatically.

Pump system:

- Twin-head pump.
- Two single-head pumps connected in parallel.

The pumps must be of the same type and size. Each pump requires a non-return valve in series with the pump.

TM05 6280 4612

TM05 6281 4612

### 8.3 Selection of control mode

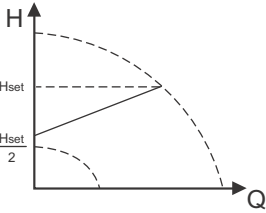
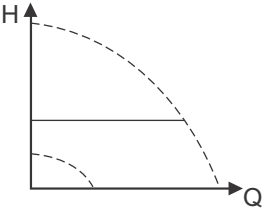
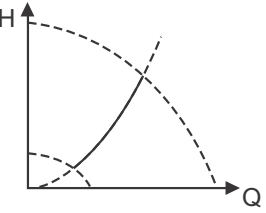
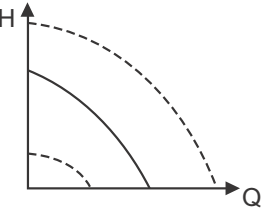
System application	Select this control mode
<p>In systems with relatively large pressure losses in the distribution pipes and in air-conditioning and cooling systems.</p> <ul style="list-style-type: none"> <li>Two-pipe heating systems with thermostatic valves and               <ul style="list-style-type: none"> <li>very long distribution pipes</li> <li>strongly throttled pipe balancing valves</li> <li>differential-pressure regulators</li> <li>large pressure losses in those parts of the system through which the total quantity of water flows (for example boiler, heat exchanger and distribution pipe up to the first branching).</li> </ul> </li> <li>Primary circuit pumps in systems with large pressure losses in the primary circuit.</li> <li>Air-conditioning systems with               <ul style="list-style-type: none"> <li>heat exchangers (fan coils)</li> <li>cooling ceilings</li> <li>cooling surfaces.</li> </ul> </li> </ul>	<p>Proportional pressure</p> 
<p>In systems with relatively small pressure losses in the distribution pipes.</p> <ul style="list-style-type: none"> <li>Two-pipe heating systems with thermostatic valves and               <ul style="list-style-type: none"> <li>dimensioned for natural circulation</li> <li>small pressure losses in those parts of the system through which the total quantity of water flows (for example boiler, heat exchanger and distribution pipe up to the first branching) or</li> <li>modified to a high differential temperature between flow pipe and return pipe (for example district heating).</li> </ul> </li> <li>Underfloor heating systems with thermostatic valves.</li> <li>One-pipe heating systems with thermostatic valves or pipe balancing valves.</li> <li>Primary circuit pumps in systems with small pressure losses in the primary circuit.</li> </ul>	<p>Constant differential pressure</p> 
<p>In systems with a fixed system characteristic.</p> <p>Examples:</p> <ul style="list-style-type: none"> <li>one-pipe heating systems</li> <li>boiler shunts</li> <li>systems with three-way valves</li> <li>domestic hot-water circulation.</li> </ul>	<p>Constant temperature and constant differential temperature</p> 
<p>If an external controller is installed, the pump is able to change from one constant curve to another, depending on the value of the external signal.</p> <p>The pump can also be set to operate according to the max. or min. curve, like an uncontrolled pump:</p> <ul style="list-style-type: none"> <li>The max. curve mode can be used in periods in which a maximum flow is required. This operating mode is for instance suitable for systems with hot-water priority.</li> <li>The min. curve mode can be used in periods in which a minimum flow is required.</li> </ul>	<p>Constant curve</p> 

### 8.4 Changing the position of the control panel

It is possible to turn the control panel 180°. Follow the instructions below.

1. Loosen the four screws (TX25) holding the terminal box cover.

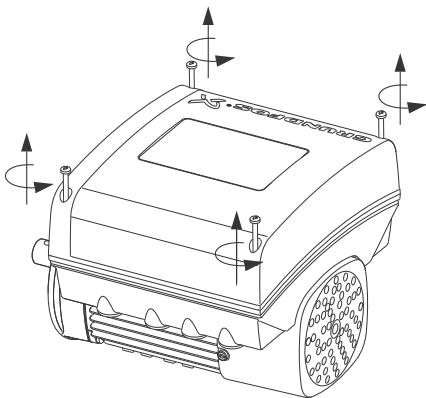

Fig. 43 Loosening the screws

2. Remove the terminal box cover.

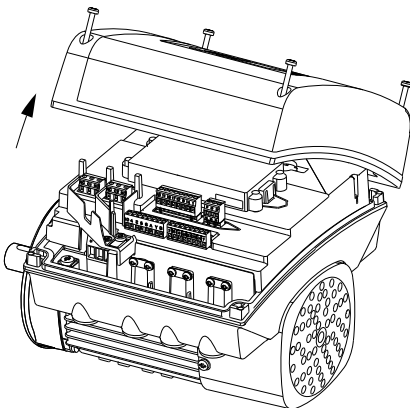

Fig. 44 Removing the terminal box cover

3. Press and hold in the two locking tabs (pos. A) while gently lifting the plastic cover (pos. B).

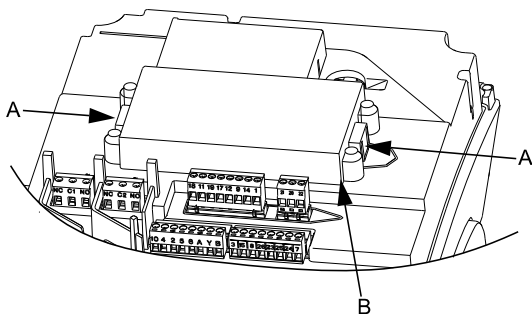

Fig. 45 Lifting the plastic cover

4. Turn the plastic cover 180°.

**Note** Do not twist the cable more than 90°.

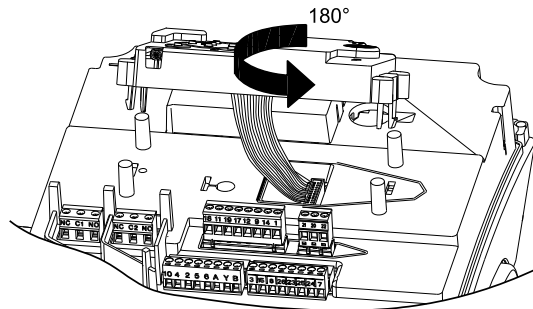

Fig. 46 Turning the plastic cover

5. Re-position the plastic cover correctly on the four rubber pins (pos. C). Make sure that the locking tabs (pos. A) are placed correctly.

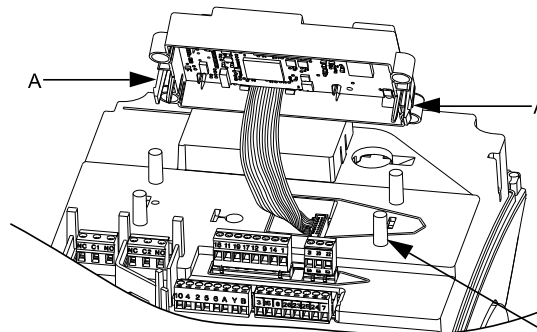

Fig. 47 Re-positioning the plastic cover

6. Fit the terminal box cover, and make sure that it is also turned 180° so that the buttons on the control panel are aligned with the buttons on the plastic cover. Tighten the four screws (TX25) with 3.68 ft.-lbs. (5 Nm).

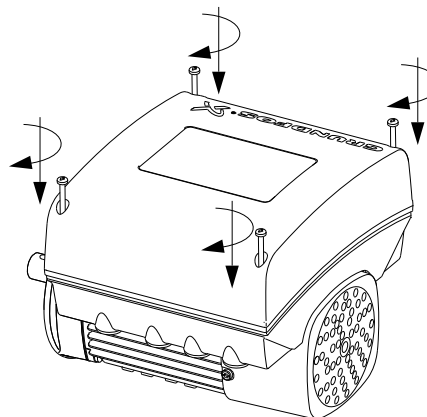

Fig. 48 Fitting the terminal box cover

TM05 5354 3612

TM05 5351 3612

TM05 5355 3612

TM05 5352 3612

TM05 5353 3612

TM05 5356 3612

## 8.5 Bus signal

The motor enables serial communication via an RS-485 input. The communication is carried out according to the Grundfos GENIbus protocol and enables connection to a building management system or another external control system.

Via a bus signal, it is possible to remote-set motor operating parameters, such as setpoint and operating mode. At the same time, the motor can, via the bus, provide status information about important parameters, such as actual value of control parameter, input power and fault indications.

Contact Grundfos for further information.



If a bus signal is used, the number of settings available via the Grundfos GO Remote will be reduced.

## 8.6 Priority of settings

The motor can always be set to operation at max. speed or to stop with the Grundfos GO Remote.

If two or more functions are enabled at the same time, the motor will operate according to the function with the highest priority.

**Example:** If, via the digital input, the motor has been set to max. speed, the motor control panel or the Grundfos GO Remote can only set the motor to "Manual" or "Stop".

The priority of the settings appears from the table below:

Priority	Start/stop button	Control panel on motor or Grundfos GO Remote	Digital input	Bus communication
1	Stop			
2		Stop*		
3		Manual		
4		Max. speed*		
5			Stop	
6				Stop
7				Max. speed
8				Min. speed
9				Start
10			Max. speed	
11		Min. speed		
12			Min. speed	
13			Start	
14		Start		

\* If the bus communication is interrupted, the motor will resume its previous operating mode, for example "Stop", selected on the motor control panel or with the Grundfos GO Remote.

## 9. Servicing the product

### DANGER

#### Electric shock



- Death or serious personal injury
- Switch off the power supply to the motor and to the signal relays. Wait at least 5 minutes before starting any work on the motor. Make sure that the power supply cannot be accidentally switched on.

### DANGER

#### Magnetic field



- Death or serious personal injury
- Do not handle the motor or rotor if you have a pacemaker.

### 9.1 Motor

For servicing the product, download the service instructions for the motor by using the following link or QR code.



<http://net.grundfos.com/qr/i/98413121>

QR98413121

### 9.2 Pump

Service documentation is available in Grundfos Product Center (<http://product-selection.grundfos.com/>).

If you have any questions, please contact the nearest Grundfos company or service workshop.

### 9.3 Cleaning the product

### WARNING

#### Electric shock



- Death or serious personal injury
- Switch off the power supply to the motor and to the signal relays. Check that the terminal box cover is intact before spraying water on the product.

In order to avoid condensation in the motor, let the motor cool down before spraying it with cold water.

## 10. Technical data

### 10.1 Operating conditions

#### 10.1.1 Maximum number of starts and stops

The number of starts and stops via the power supply must not exceed four times per hour.

When switched on via the power supply, the pump starts after approximately 5 seconds.

If a higher number of starts and stops is desired, use the input for external start-stop when starting and stopping the pump.

When started via an external on/off switch, the pump starts immediately.

### 10.1.2 Ambient temperature

#### Ambient temperature during storage and transportation

Minimum: -22 °F (-30 °C)

Maximum: 140 °F (60 °C).

#### Ambient temperature during operation

1 x 200 - 240 and 3 x 440 - 480

Minimum: -4 °F (-20 °C)

Maximum: 122 °F (50 °C).

3 x 200 - 240

Minimum: -4 °F (-20 °C)

Maximum: 104 °F (40 °C).

The motor can operate with the rated power output (P2) at 122 °F (50 °C), but continuous operation at higher temperatures reduces the expected product life. If the motor is to operate at ambient temperatures between 122 °F (50 °C) and 140 °F (60 °C), select an oversized motor. Contact Grundfos for further information.

### 10.1.3 Installation altitude



If the motor is installed above 6560 ft (2000 m), it does not comply with SELV/PELV classification.

Installation altitude is the height above sea level of the installation site.

Motors installed up to 3280 ft (1000 m) above sea level can be loaded 100 %.

- Motors installed more than 3280 ft (1000 m) above sea level must not be fully loaded due to the low density and consequent low cooling effect of the air. See fig. 49.

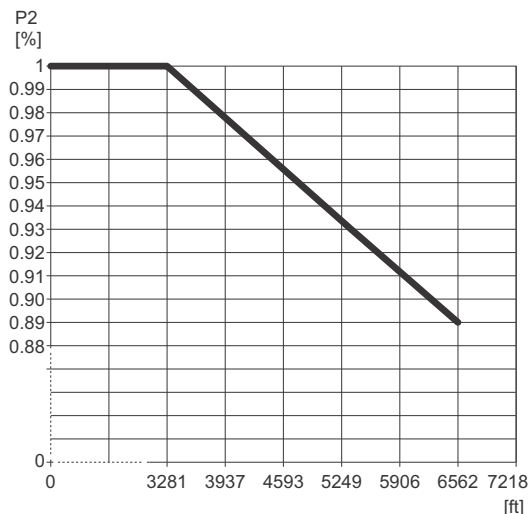

Fig. 49 Derating of motor output power (P2) in relation to altitude above sea level

TM06 9374 2117

### 10.1.4 Humidity

Maximum humidity: 95 %.

If the humidity is constantly high and above 85 %, open the drain holes in the drive-end flange. See Fig. 2 Examples of covers (not supplied by Grundfos).

### 10.1.5 Motor cooling

To ensure cooling of motor and electronics, observe the following:

- Position the motor in such a way that adequate cooling is ensured. See section 4.1.5 *Ensuring motor cooling*.
- The temperature of the cooling air must not exceed 122 °F (50 °C).

Keep cooling fins and fan blades clean.

### 10.2 Megging

Do not meg an installation incorporating MLE motors, as the built-in electronics may be damaged.

### 10.3 Technical data, single-phase motors

#### 10.3.1 Supply voltage

- 1 x 200-240 V - 10 %/+ 10 %, 50/60 Hz, PE.

Check that the supply voltage and frequency correspond to the values stated on the nameplate.

#### Recommended fuse size

Motor size Hp [kW]	Minimum [A]	Maximum [A]
0.33 - 1 (0.25 - 0.75)	6	10
1 1/2 - 2 (1.1 - 1.5)	10	16

You can use standard as well as quick-blow or slow-blow fuses.

#### 10.3.2 Leakage current

Ground leakage current less than 3.5 mA, AC.

Ground leakage current less than 10 mA, DC.

The leakage currents are measured in accordance with EN 61800-5-1:2007.

### 10.4 Technical data, three-phase motors

#### 10.4.1 Supply voltage

- 3 x 440-480 V - 10 %/+ 10 %, 50/60 Hz, PE.

Check that the supply voltage and frequency correspond to the values stated on the nameplate.

#### Recommended fuse size

Motor size [Hp (kW)]	Minimum [A]	Maximum [A]
0.33 - 1 1/2 (0.25 - 1.1)	6	6
2 (1.5)	6	10
3 (2.2)	6	16
5 (4)	13	16
7 1/2 (5.5)	16	32
10 (7.5)	20	32
15 (11)	32	32

Standard as well as quick-blow or slow-blow fuses may be used.

- 3 x 200-240 V, 60 Hz (supply voltage V)

#### Recommended fuse size

Motor size [Hp (kW)]	Minimum [A]	Maximum [A]
1 1/2 (1.1)	10	20
2 (1.5)	10	20
3 (2.2)	13	35
5 (4)	25	35
7 1/2 (5.5)	32	35

#### 10.4.2 Leakage current (AC)

Speed [min <sup>-1</sup> ]	Power [Hp (kW)]	Power supply voltage [V]	Leakage current [mA]
2900-4000	0.33 - 3 (0.25 - 2.2)	≤ 400	< 3.5
		> 400	< 5
	5 - 7 1/2 (4 - 5 1/2)	≤ 400	< 3.5
		> 400	< 3.5
	10 - 15 (7 1/2 - 11)	≤ 400	< 3.5
		> 400	< 5
4000-5900	0.33 - 3 (0.25 - 2.2)	≤ 400	< 3.5
		> 400	< 5
	5 - 7 1/2 (4 - 5.5)	≤ 400	< 3.5
		> 400	< 3.5
	10-15 (7.5 - 11)	≤ 400	< 3.5
		> 400	< 5

The leakage currents are measured in accordance with EN 61800-5-1:2007.



## 10.5 Inputs/outputs

### Ground reference

All voltages refer to ground. All currents return to ground.

### Absolute maximum voltage and current limits

Exceeding the following electrical limits may result in severely reduced operating reliability and motor life:

Relay 1:

Maximum contact load: 250 VAC, 2 A or 30 VDC, 2 A.

Relay 2:

Maximum contact load: 30 VDC, 2 A.

GENI terminals: -5.5 to 9.0 VDC or less than 25 mADC.

Other input/output terminals: -0.5 to 26 VDC or less than 15 mADC.

### Digital inputs, DI

Internal pull-up current greater than 10 mA at  $V_i$  equal 0 VDC.

Internal pull-up to 5 VDC (currentless for  $V_i$  greater than 5 VDC).

Certain low logic level:  $V_i$  less than 1.5 VDC.

Certain high logic level:  $V_i$  greater than 3.0 VDC.

Hysteresis: No.

Screened cable: 0.5 - 1.5 mm<sup>2</sup>, 28-16 AWG.

Maximum cable length: 1640 ft (500 m).

### Open-collector digital outputs, OC

Current sinking capability: 75 mADC, no current sourcing.

Load types: Resistive or/and inductive.

Low-state output voltage at 75 mADC: Maximum 1.2 VDC.

Low-state output voltage at 10 mADC: Maximum 0.6 VDC.

Overcurrent protection: Yes.

Screened cable: 0.5 - 1.5 mm<sup>2</sup>, 28-16 AWG.

Maximum cable length: 1640 ft (500 m).

### Analog inputs, AI

Voltage signal ranges:

- 0.5 - 3.5 VDC, AL AU.
- 0-5 VDC, AU.
- 0-10 VDC, AU.

Voltage signal:  $R_i$  greater than 100 k $\Omega$  at 25 °C.

Leak currents may occur at high operating temperatures. Keep the source impedance low.

Current signal ranges:

- 0-20 mADC, AU.
- 4-20 mADC, AL AU.

Current signal:  $R_i$  is equal 292  $\Omega$ .

Current overload protection: Yes. Change to voltage signal.

Measurement tolerance: - 0/+ 3 % of full scale (maximum-point coverage).

Screened cable: 0.5 - 1.5 mm<sup>2</sup>, 28-16 AWG.

Maximum cable length: 500 m excluding potentiometer.

Potentiometer connected to +5 V, GND, any AI:

Use maximum 10 k $\Omega$ .

Maximum cable length: 100 m.

### Analog output, AO

Current sourcing capability only.

Voltage signal:

- Range: 0-10 VDC.
- Minimum load between AO and GND: 1 k $\Omega$ .
- Short-circuit protection: Yes.

Current signal:

- Ranges: 0-20 and 4-20 mADC.
- Maximum load between AO and GND: 500  $\Omega$ .
- Open-circuit protection: Yes.

Tolerance: - 0/+ 4 % of full scale (maximum-point coverage).

Screened cable: 0.5 - 1.5 mm<sup>2</sup>, 28-16 AWG.

Maximum cable length: 1640 ft (500 m).

### Pt100/1000 inputs, Pt

Temperature range:

- Minimum: -22 °F (-30 °C). 88  $\Omega$  / 882  $\Omega$ .
- Maximum: 356 °F (180 °C). 168  $\Omega$  / 1685  $\Omega$ .

Measurement tolerance:  $\pm$  2.5 °F ( $\pm$  1.5 °C).

Measurement resolution: < 0.5 °F (0.3 °C).

Automatic range detection, Pt100 or Pt1000: Yes.

Sensor fault alarm: Yes.

Screened cable: 0.5 - 1.5 mm<sup>2</sup>, 28-16 AWG.

Use Pt100 for short wires.

Use Pt1000 for long wires.

### LiqTec sensor inputs

Use Grundfos LiqTec sensor only.

Screened cable: 0.5 - 1.5 mm<sup>2</sup>, 28-16 AWG.

### Grundfos Digital Sensor input and output, GDS

Use Grundfos Digital Sensor only.

### Power supplies

#### +5 V:

- Output voltage: 5 VDC - 5 %/+ 5 %.
- Maximum current: 50 mADC (sourcing only).
- Overload protection: Yes.

#### +24 V:

- Output voltage: 24 VDC - 5 %/+ 5 %.
- Maximum current: 60 mADC (sourcing only).
- Overload protection: Yes.

### Digital outputs, relays

Potential-free changeover contacts.

Minimum contact load when in use: 5 VDC, 10 mA.

Screened cable: 0.5 - 2.5 mm<sup>2</sup>, 28-12 AWG.

Maximum cable length: 1640 ft (500 m).

### Bus input

Grundfos GENIbus protocol, RS-485.

Screened 3-core cable: 0.5 - 1.5 mm<sup>2</sup>, 28-16 AWG.

Maximum cable length: 1640 ft (500 m).

## 10.6 Other technical data

### EMC (electromagnetic compatibility)

Standard used: EN 61800-3.

The table below indicates the emission category of the motor.

C1: Fulfills the requirements for residential areas.

C3: Fulfills the requirements for industrial areas.

Motor Hp (kW)	Emission category	
	1450-2000 min <sup>-1</sup>	2900-4000 min <sup>-1</sup> 4000-5900 min <sup>-1</sup>
0.33 (0.25)	C1	C1
1/2 (0.37)	C1	C1
3/4 (0.55)	C1	C1
1 (0.75)	C1	C1
1 1/2 (1.1)	C1	C1
2 (1.5)	C1	C1
3 (2.2)	C1	C1
5 (4)	C1	C1
7 1/2 (5.5)	C3/C1*	C1
10 (7.5)	C3/C1*	C3/C1*
15 (11)	-	C3/C1*

\* C1, if equipped with an external Grundfos EMC filter.

Immunity: Fulfills the requirements for industrial areas.

Contact Grundfos for further information.

### Enclosure class

Standard: IP55 (IEC 34-5).

Optional: IP66 (IEC 34-5).

### Insulation class

F (IEC 85).

### Standby power consumption

5-10 W.

### Cable entries

Motor Hp (kW)	Supply voltage	Number and size of cable entries
1/2 - 2 (0.37 - 1.5)	1 x 200-240 V, 50/60 Hz	4 x NPT 1/2"
	3 x 200-240 V, 60 Hz	4 x NPT 1/2"
	3 x 440-480 V, 50/60 Hz	4 x NPT 1/2"
3 (2.2)	3 x 200-240 V, 60 Hz	5 x NPT 1/2"
	3 x 440-480 V, 50/60 Hz	4 x NPT 1/2"
5 (4)	3 x 200-240 V, 60 Hz	5 x NPT 1/2"
	3 x 440-480 V, 50/60 Hz	5 x NPT 1/2"
7 1/2 (5.5)	3 x 200-240 V, 60 Hz	1 x NPT3/4" + 5 x NPT1/2"
	3 x 440-480 V, 50/60 Hz	5 x NPT 1/2"
10 - 15 (7.5 -11)	3 x 440-480 V, 50/60 Hz	1 x NPT3/4" + 5 x NPT1/2"

The cable entries are fitted with blind plugs from the factory.

Cable glands are not provided.

### Torques

Terminal	Thread size	Maximum torque [ft lb (Nm)]
L1, L2, L3, L, N	M4	1.3 (1.8)
NC, C1, C2, NO	M2.5	0.4 (0.5)
1-26 and A, Y, B	M2	0.4 (0.5)

## 10.6.1 Sound pressure level

Motor [Hp (kW)]	Maximum speed stated on nameplate [min <sup>-1</sup> ]	Speed [min <sup>-1</sup> ]	Sound pressure level ISO 3743 [dB(A)]	
			1-phase motors	3-phase motors
0.33 - 1 (0.25 - 0.75)	2000	1500	37	37
		2000	43	43
	4000	3000	50	50
		4000	60	60
	5900	4000	58	58
		5900	68	68
1 1/2 (1.1)	2000	1500		37
		2000		43
	4000	3000	50	50
		4000	60	60
	5900	4000	58	58
		5900	68	68
2 (1.5)	2000	1500		42
		2000		47
	4000	3000	57	57
		4000	64	64
	5900	4000	58	58
		5900	68	68
3 (2.2)	2000	1500		48
		2000		55
	4000	3000		57
		4000		64
	5900	4000		58
		5900		68
5 (4)	2000	1500		48
		2000		55
	4000	3000		61
		4000		69
	5900	4000		64
		5900		74
7 1/2 (5.5)	2000	1500		58
		2000		61
	4000	3000		61
		4000		69
	5900	4000		64
		5900		74
10 (7.5)	2000	1500		58
		2000		61
	4000	3000		66
		4000		73
	5900	4000		69
		5900		79
15 (11)	4000	3000		66
		4000		73
	5900	4000		69
		5900		79

The grey fields indicate that the motor is not available in this MLE motor range.

## 11. Disposing of the product

This product or parts of it must be disposed of in an environmentally sound way:

1. Use the public or private waste collection service.
2. If this is not possible, contact the nearest Grundfos company or service workshop.

Dispose of the waste battery through the national collective schemes. If in doubt, contact your local Grundfos company.

## Appendix

## 1. Installation in the USA and Canada

In order to maintain the cURus approval, follow these additional installation instructions. The UL approval is according to UL 1004-1.

### For Canada

This product complies with the Canadian ICES-003 Class B specifications. This Class B device meets all the requirements of the Canadian interference-causing equipment regulations.

Cet appareil numérique de la Classe B est conforme à la norme NMB-003 du Canada. Cet appareil numérique de la Classe B respecte toutes les exigences du Règlement sur le matériel brouilleur du Canada.

### 1.1 Electrical codes

#### For USA

This product complies with the Canadian Electrical Code and the US National Electrical Code.

This product has been tested according to the national standards for Electronically Protected Motors:

CSA 22.2 100-14:2014 (applies to Canada only).

UL 1004-1:2015 (applies to USA only).

#### Pour le Canada

#### Codes de l'électricité

Ce produit est conforme au Code canadien de l'électricité et au Code national de l'électricité américain.

Ce produit a été testé selon les normes nationales s'appliquant aux moteurs protégés électroniquement:

CSA 22.2 100.04: 2009 (s'applique au Canada uniquement).

UL 1004-1: Juin 2011 (s'applique aux États-Unis uniquement).

### 1.2 Radio communication

#### For USA

This device complies with part 15 of the FCC rules and RSS210 of IC rules.

Operation is subject to the following two conditions:

- This device may not cause interference.
- This device must accept any interference, including interference that may cause undesired operation of the device.

Users are cautioned that changes or modifications not expressly approved by Grundfos could void the user's authority to operate the equipment.

#### Pour le Canada

#### Communication radio

Ce dispositif est conforme à la partie 15 des règles de la FCC et aux normes RSS210 de l'IC.

Son fonctionnement est soumis aux deux conditions suivantes:

- Ce dispositif ne doit pas provoquer de brouillage préjudiciable.
- Il doit accepter tout brouillage reçu, y compris le brouillage pouvant entraîner un mauvais fonctionnement.

## 1.3 Identification numbers

### For USA

Grundfos Holding A/S

Contains FCC ID: OG3-RADIOM01-2G4.

### For Canada

Grundfos Holding A/S

Model: RADIOMODULE 2G4

Contains IC: 10447A-RA2G4M01.

### Pour le Canada

#### Numéros d'identification

Grundfos Holding A/S

Modèle: RADIOMODULE 2G4

Contient IC: 10447A-RA2G4M01.

#### Location of identification numbers

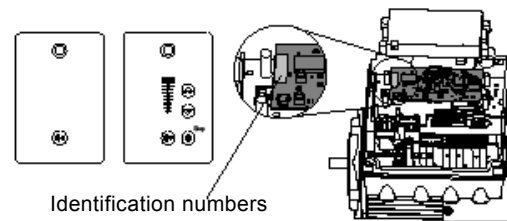

Fig. 1 Identification numbers

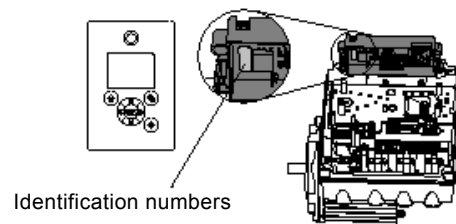

Fig. 2 Identification numbers

TM05 7572 1213

TM05 7573 1213

## 1.4 Electrical connection

### 1.4.1 Conductors

See section 7.2 *Cable requirements*, page 11.

### 1.4.2 Torques

Maximum tightening torques for the terminals can be found in section *Torques*, page 65.

### 1.4.3 Line reactors

The maximum line reactor sizes are listed below.

Motor [Hp]	Maximum line reactor size [mH]
.50	1.5
.75	1.5
1	1.5
1.5	1.5
2	1.5
3	2
5	0.7
7.5	0.3
10	0.6
15	0.3

#### Short circuit current

If a short circuit occurs, the pump can be used on a mains supply delivering not more than 5000 RMS symmetrical amperes, 600 V maximum.

#### Fuses

Fuses used for motor protection must be rated for minimum 500 V.

Motors up to and including 10 Hp require class K5 UL-listed fuses.

Any UL-listed fuse can be used for motors of 15 Hp.

#### Branch circuit protection

When the pump is protected by a circuit breaker, this must be rated for a maximum voltage of 480 V. The circuit breaker must be of the "inverse time" type.

#### Overload protection

Degree of overload protection provided internally by the drive, in percent of full-load current: 102 %.

## 1.5 Outdoor installation

According to UL 778/C22.2 No 108-14 pumps that are intended for outdoor use shall be marked enclosure type 3 and the product shall be tested with rated surface temperature down to -31 °F (-35 °C). The MLE enclosure is approved for type 3 or 4 and rated surface temperature down to 32 °F (0 °C), thus only for indoor use in UL 778/C22.2 No 108-14 pump applications. For ambient temperature during operation, see section 10.1.2 Ambient temperature.



**GRUNDFOS Kansas City**

9300 Loiret Blvd.  
Lenexa, Kansas 66219  
Phone: (913) 227-3400  
Fax: (913) 227-3500

[www.grundfos.us](http://www.grundfos.us)

**GRUNDFOS Canada**

2941 Brighton Road  
Oakville, Ontario L6H 6C9 Canada  
Phone: +1-905 829 9533  
Telefax: +1-905 829 9512

[www.grundfos.ca](http://www.grundfos.ca)

**GRUNDFOS México**

Boulevard TLC No. 15  
Parque Industrial Stiva Aeropuerto  
C.P. 66600 Apodaca, N.L. México  
Phone: 011-52-81-8144 4000  
Fax: 011-52-81-8144 4010

[www.grundfos.mx](http://www.grundfos.mx)

<b>98864411</b> 1018
ECM: 1240291

The name Grundfos, the Grundfos logo, and be think innovate are registered trademarks owned by Grundfos Holding A/S or Grundfos A/S, Denmark. All rights reserved worldwide. © Copyright Grundfos Holding A/S