

CUE, 150-350 hp

Installation and operating instructions

US F E



CUE, 150-350 hp

Installation and operating instructions 4

US

Notice d'installation et d'entretien 42

F

Instrucciones de instalación y funcionamiento 81

E

LIMITED WARRANTY

US

Products manufactured by GRUNDFOS PUMPS CORPORATION (Grundfos) are warranted to the original user only to be free of defects in material and workmanship for a period of 24 months from date of installation, but not more than 30 months from date of manufacture. Grundfos' liability under this warranty shall be limited to repairing or replacing at Grundfos' option, without charge, F.O.B. Grundfos' factory or authorized service station, any product of Grundfos' manufacture. Grundfos will not be liable for any costs of removal, installation, transportation, or any other charges which may arise in connection with a warranty claim. Products which are sold but not manufactured by Grundfos are subject to the warranty provided by the manufacturer of said products and not by Grundfos' warranty. Grundfos will not be liable for damage or wear to products caused by abnormal operating conditions, accident, abuse, misuse, unauthorized alteration or repair, or if the product was not installed in accordance with Grundfos' printed installation and operating instructions.

To obtain service under this warranty, the defective product must be returned to the distributor or dealer of Grundfos' products from which it was purchased together with proof of purchase and installation date, failure date, and supporting installation data. Unless otherwise provided, the distributor or dealer will contact Grundfos or an authorized service station for instructions. Any defective product to be returned to Grundfos or a service station must be sent freight prepaid; documentation supporting the warranty claim and/or a Return Material Authorization must be included if so instructed.

GRUNDFOS WILL NOT BE LIABLE FOR ANY INCIDENTAL OR CONSEQUENTIAL DAMAGES, LOSSES, OR EXPENSES ARISING FROM INSTALLATION, USE, OR ANY OTHER CAUSES. THERE ARE NO EXPRESS OR IMPLIED WARRANTIES, INCLUDING MERCHANTABILITY OR FITNESS FOR A PARTICULAR PURPOSE, WHICH EXTEND BEYOND THOSE WARRANTIES DESCRIBED OR REFERRED TO ABOVE.

Some jurisdictions do not allow the exclusion or limitation of incidental or consequential damages and some jurisdictions do not allow limit actions on how long implied warranties may last. Therefore, the above limitations or exclusions may not apply to you. This warranty gives you specific legal rights and you may also have other rights which vary from jurisdiction to jurisdiction.

CONTENTS

	Page		Page
1. Symbols used in this document	5	16. Technical data	39
2. Introduction	5	16.1 Enclosure	39
2.1 General description	5	16.2 Main dimensions and weight	39
2.2 Applications	5	16.3 Surroundings	40
2.3 References	6	16.4 Terminal tightening torques	40
3. Safety and warnings	6	16.5 Cable length	40
3.1 Warning	6	16.6 Fuses and cable gauge size	40
3.2 Safety regulations	6	16.7 Inputs and outputs	41
3.3 Installation requirements	6	16.8 Sound pressure level	41
3.4 Reduced performance under certain conditions	6	17. Disposal	41
4. Identification	7		
4.1 Nameplate	7		
4.2 Packaging label	7		
5. Mechanical installation	7		
5.1 Reception and storage	7		
5.2 Transportation and unpacking	7		
5.3 Space requirements and air circulation	8		
5.4 Mounting	8		
6. Electrical connection	9		
6.1 Electrical protection	9		
6.2 Mains and motor connection	10		
6.3 Connecting the signal terminals	11		
6.4 Connecting the signal relays	13		
6.5 Connecting the MCB 114 sensor input module	13		
6.6 EMC-correct installation	14		
6.7 RFI filters	14		
6.8 Output filters	15		
7. Operating modes	15		
8. Control modes	15		
8.1 Uncontrolled operation (open loop)	15		
8.2 Controlled operation (closed loop)	16		
9. Menu overview	17		
10. Setting by means of the control panel	20		
10.1 Control panel	20		
10.2 Back to factory setting	20		
10.3 Start-up guide	21		
10.4 Menu GENERAL	25		
10.5 Menu OPERATION	26		
10.6 Menu STATUS	27		
10.7 Menu INSTALLATION	29		
11. Setting by means of PC Tool E-products	35		
12. Priority of settings	36		
12.1 Control without bus signal, local operating mode	36		
12.2 Control with bus signal, remote-controlled operating mode	36		
13. External control signals	36		
13.1 Digital inputs	36		
13.2 External setpoint	36		
13.3 GENIbus signal	37		
13.4 Other bus standards	37		
14. Maintenance and service	37		
14.1 Cleaning the CUE	37		
14.2 Service parts and service kits	37		
15. Troubleshooting	38		
15.1 Warning and alarm list	38		
15.2 Resetting of alarms	38		
15.3 Indicator lights	38		
15.4 Signal relays	38		



Warning

Prior to installation, read these installation and operating instructions. Installation and operation must comply with local regulations and accepted codes of good practice.

1. Symbols used in this document



Warning

If these safety instructions are not observed, it may result in personal injury!

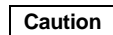

Caution

If these safety instructions are not observed, it may result in malfunction or damage to the equipment!

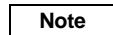

Note

Notes or instructions that make the job easier and ensure safe operation.

2. Introduction

This manual introduces all aspects of your Grundfos CUE variable frequency drive in the output current range of 212-480 A. in the power range of 150 to 350 hp. Always keep this manual close to the CUE.

2.1 General description

The CUE is a series of external variable frequency drives especially designed for pumps.

Thanks to the start-up guide in the CUE, the installer can quickly set central parameters and put the CUE into operation.

Connected to a sensor or an external control signal, the CUE will quickly adapt the pump speed to the actual demand.

2.2 Applications

The CUE series and Grundfos standard pumps are a supplement to the Grundfos E-pumps range with integrated variable frequency drive.

A CUE solution offers the same E-pump functionality

- in the supply voltage or power ranges not covered by the E-pump range.
- in applications where an integrated variable frequency drive is not desirable or permissible.

2.3 References

Technical documentation for Grundfos CUE:

- The manual contains all information required for putting the CUE into operation.
- The data booklet contains all technical information about the construction and applications of the CUE.
- Service instructions contain all required instructions for dismantling and repairing the variable frequency drive.

Technical documentation is available on www.grundfos.com > International website > WebCAPS.

If you have any questions, please contact the nearest Grundfos company or service workshop.

3. Safety and warnings

3.1 Warning



Warning

Any installation, maintenance and inspection must be carried out by trained personnel.



Warning

Touching the electrical parts may be fatal, even after the CUE has been switched off.

Before making any work on the CUE, the mains supply and other input voltages must be switched off at least for as long as stated below.

Voltage	Min. waiting time	
	15 minutes	20 minutes
380-500 V	150-350 hp	
525-690 V		150-350 hp

Wait only for shorter time if stated so on the nameplate of the CUE in question.

3.2 Safety regulations

- The On/Off button of the control panel does not disconnect the CUE from the power supply and must therefore not be used as a safety switch.
- The CUE must be grounded correctly and protected against indirect contact according to national regulations.
- The leakage current to ground exceeds 3.5 mA.
- Enclosure class NEMA 1 must not be installed freely accessible, but only in a panel.
- Enclosure class NEMA 12 must not be installed outdoors without additional protection against water and the sun.
- Always observe national and local regulations as to cable gauge size, short-circuit protection and overcurrent protection.

3.3 Installation requirements

The general safety necessitates special considerations as to these aspects:

- fuses and switches for overcurrent and short-circuit protection
- selection of cables (mains current, motor, load distribution and relay)
- net configuration (IT, TN, grounding)
- safety on connecting inputs and outputs (PELV).

3.3.1 IT mains



Warning

Do not connect 380-500 V CUE variable frequency drives to mains supplies with a voltage between phase and ground of more than 440 V.

In connection with IT mains and grounded delta mains, the supply voltage may exceed 440 V between phase and ground.

3.3.2 Aggressive environment

Caution

The CUE should not be installed in an environment where the air contains liquids, particles or gases which may affect and damage the electronic components.

The CUE contains a large number of mechanical and electronic components. They are all vulnerable to environmental effects.

3.4 Reduced performance under certain conditions

The CUE will reduce its performance under these conditions:

- low air pressure (at high altitude)
- long motor cables.

The required measures are described in the next two sections.

3.4.1 Reduction at low air pressure



Warning

At altitudes above 6600 ft, PELV cannot be met.

PELV = Protective Extra Low Voltage.

At low air pressure, the cooling capacity of air is reduced, and the CUE automatically reduces the performance to prevent overload. It may be necessary to select a CUE with a higher performance.

3.4.2 Reduction in connection with long motor cables

The maximum cable length for the CUE is 1000 ft for unscreened and 500 ft for screened cables. In case of longer cables, contact Grundfos.

The CUE is designed for a motor cable with a maximum gauge size as stated in section 16.6 *Fuses and cable gauge size*.

4. Identification

4.1 Nameplate

The CUE can be identified by means of the nameplate. An example is shown below.



TM04 3272 4808

Fig. 1 Example of nameplate

Text	Description
T/C:	CUE (product name) 202P1M2... (internal code)
Prod. no:	Product number: 12345678
S/N:	Serial number: 123456G234 The last three digits indicate the production date: 23 is the week, and 4 is the year 2004.
1.5 kW	Typical shaft power on the motor
IN:	Supply voltage, frequency and maximum input current
OUT:	Motor voltage, frequency and maximum output current. The maximum output frequency usually depends on the pump type.
CHASSIS/ IP20	Enclosure class
Tamb.	Maximum ambient temperature

4.2 Packaging label

The CUE can also be identified by means of the label on the packaging.

5. Mechanical installation

The individual CUE cabinet sizes are characterised by their enclosures. The table in section 16.1 shows the relationship of enclosure class and enclosure type.

5.1 Reception and storage

Check on receipt that the packaging is intact, and the unit is complete. In case of damage during transport, contact the transport company to complain.

Note that the CUE is delivered in a packaging which is not suitable for outdoor storage.

5.2 Transportation and unpacking

The CUE must only be unpacked at the installation site to prevent damage during the transport to the site.

Remove the cardboard box, and keep the CUE on the pallet as long as possible.

The packaging contains accessory bag(s), documentation and the unit itself.

Note The cardboard box has a drilling template for the mounting holes. See fig. 2.



TM03 9893 4607

Fig. 2 CUE packaging with drilling template

5.2.1 Lifting the CUE

Always lift the CUE using the lifting holes. Use a bar to avoid bending the lifting holes. See fig. 3.

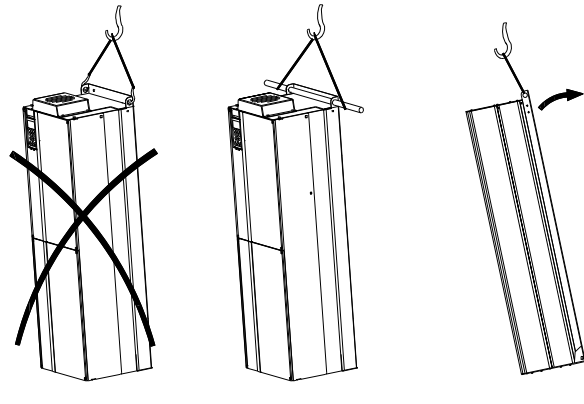

TM03 9896 4607

Fig. 3 Recommended lifting method

5.3 Space requirements and air circulation

CUE units can be mounted side by side, but as a sufficient air circulation is required for cooling these requirements must be met:

- Sufficient free space above and below the CUE to allow airflow and cable connection. See fig. 4.
- Ambient temperature up to 113 °F.

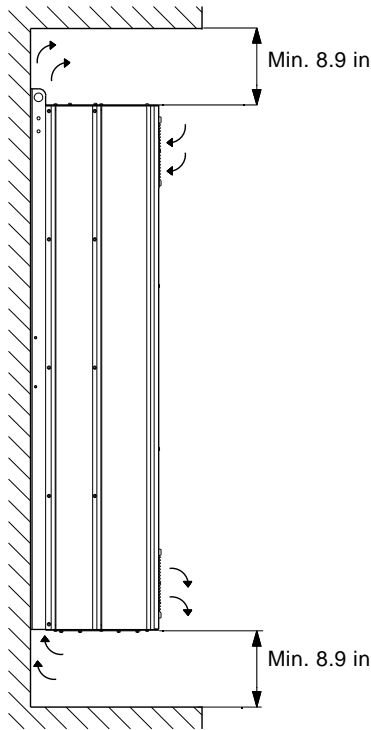

Fig. 4 Airflow direction and required space for cooling

Furthermore, there must be sufficient space in front of the CUE for opening the door of the CUE. See fig. 5.

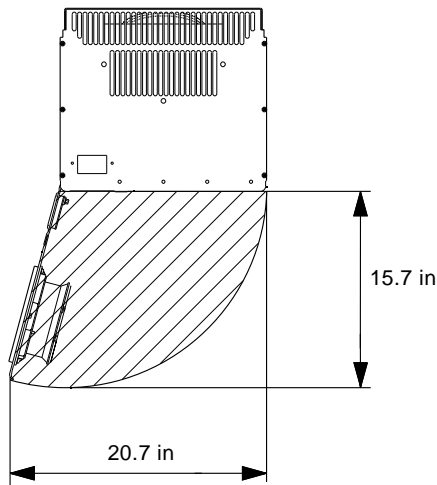

Fig. 5 Free space in front of the CUE

5.4 Mounting

5.4.1 Mounting the drip shield

To comply with the IP21/NEMA 1 rating, a separate drip shield is to be fitted:

1. Remove the two screws. See fig. 6.
2. Fit the drip shield.
3. Fit and tighten the screws to 4.1 lb-ft.

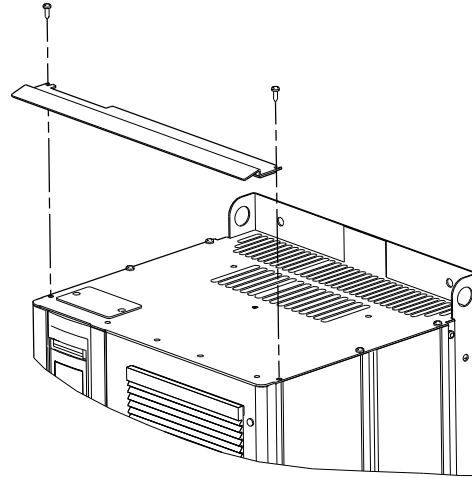

Fig. 6 Fitting the drip shield

5.4.2 Mounting on the wall

Caution *The user is responsible for mounting the CUE securely on a firm surface.*

Note *See the main dimensions and weights in section 16.2.*

1. Mark the mounting holes on the wall using the drilling template. See fig. 2.
2. Drill the holes. See fig. 7.
3. Fit the screws at the bottom, but leave loose. Lift the CUE up on the screws. Move the CUE against the wall, and fit the screws at the top. Tighten all four screws. See fig. 3.

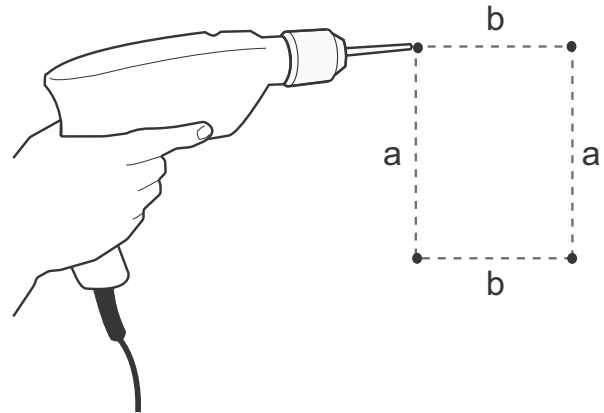

Fig. 7 Drilling of holes in the wall

5.4.3 Mounting on the floor



Warning
The CUE is top-heavy and may fall over if the pedestal is not anchored to the floor.

Caution The user is responsible for mounting the CUE securely on a firm surface.

Note See the pedestal kit instructions for further information.

By means of a pedestal (option), the CUE can also be mounted on the floor.

1. Mark the mounting holes on the floor. See fig. 8.
2. Drill the holes.
3. Mount the pedestal on the floor.
4. Mount the CUE on the pedestal using the enclosed screws. See fig. 9.

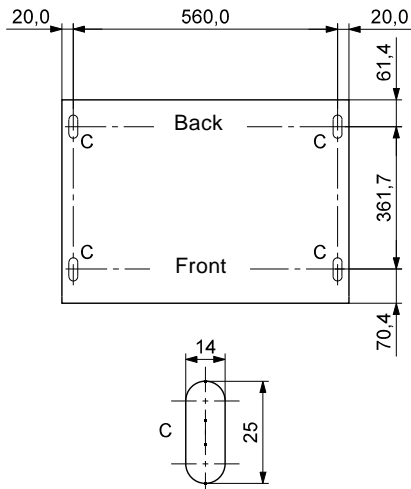

Fig. 8 Drilling template for pedestal [mm]



Fig. 9 CUE on a pedestal

6. Electrical connection



Warning
The owner or installer is responsible for ensuring correct grounding and protection according to national and local standards.



Warning
Before making any work on the CUE, the mains supply and other voltage inputs must be switched off for at least as long as stated in section 3. Safety and warnings.

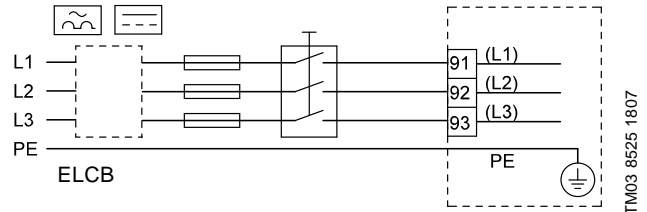

Fig. 10 Example of three-phase mains connection of the CUE with mains switch, back-up fuses and additional protection

6.1 Electrical protection

6.1.1 Protection against electric shock, indirect contact



Warning
The CUE must be grounded correctly and protected against indirect contact according to national regulations.

Caution The leakage current to ground exceeds 3.5 mA, and a reinforced ground connection is required.

Protective conductors must always have a yellow/green (PE) or yellow/green/blue (PEN) color marking.

Instructions according to EN IEC 61800-5-1:

- The CUE must be stationary, installed permanently and connected permanently to the mains supply.
- The ground connection must be carried out with duplicate protective conductors.

6.1.2 Protection against short-circuit, fuses

The CUE and the supply system must be protected against short-circuit.

Grundfos demands that the back-up fuses mentioned in section 16.6 are used for protection against short-circuit.

The CUE offers complete short-circuit protection in case of a short-circuit on the motor output.

6.1.3 Additional protection

Caution The leakage current to ground exceeds 3.5 mA.

If the CUE is connected to an electrical installation where an earth leakage circuit breaker (ELCB) is used as additional protection, the circuit breaker must be of a type marked with the following symbols:

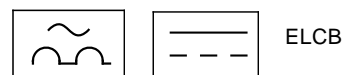

The circuit breaker is **type B**.

The total leakage current of all the electrical equipment in the installation must be taken into account.

The leakage current from the CUE in normal operation can be seen in section 16.7.1 *Mains supply (L1, L2, L3)*. During start and in asymmetrical supply systems, the leakage current can be higher than normal and may cause the ELCB to trip.

6.1.4 Motor protection

The motor requires no external motor protection. The CUE protects the motor against thermal overloading and blocking.

6.1.5 Protection against overcurrent

The CUE has an internal overcurrent protection for overload protection on the motor output.

6.1.6 Protection against supply voltage transients

The CUE is protected against supply voltage transients according to EN 61800-3, second environment.

6.2 Mains and motor connection

The supply voltage and frequency are marked on the CUE nameplate. Make sure that the CUE is suitable for the power supply of the installation site.

Note *The maximum output voltage of the CUE is equal to the input voltage. Example: If the supply voltage is 208 V, choose a 208 V rated motor.*

6.2.1 Mains switch

A mains switch can be installed before the CUE according to local regulations. See fig. 10.

6.2.2 Wiring diagram

The wires in the terminal box must be as short as possible. Excepted from this is the ground conductor which must be so long that it is the last one to be disconnected in case the cable is inadvertently pulled out of the cable entry.

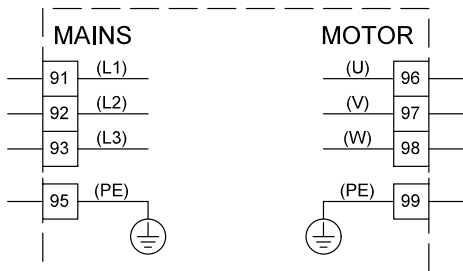

Fig. 11 Wiring diagram, three-phase mains connection

Terminal	Function
91 (L1)	Three-phase supply
92 (L2)	
93 (L3)	
95/99 (PE)	Ground connection
96 (U)	Three-phase motor connection, 0-100 % of supply voltage
97 (V)	
98 (W)	

6.2.3 Gland plate

Cables are connected through the gland plate from the bottom. The gland plate must be fitted to the CUE to ensure the specified protection degree as well as to ensure sufficient cooling. Drill holes in the marked areas. See fig. 12.

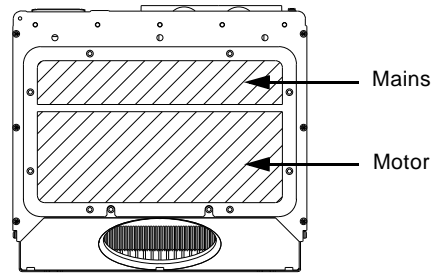

Fig. 12 CUE viewed from the bottom

6.2.4 Motor connection

For information about enclosure, see table in section 16.1.

Caution *The motor cable must be screened for the CUE to meet EMC requirements.*

1. Connect the ground conductor to terminal 99 (PE). See fig. 14.
2. Connect the motor conductors to the terminals 96 (U), 97 (V), 98 (W). See fig. 15.
3. Fix the screened cable with a cable clamp.
4. Fit the EMC metal cover to ensure best EMC performance before connecting the mains cable. See fig. 13.

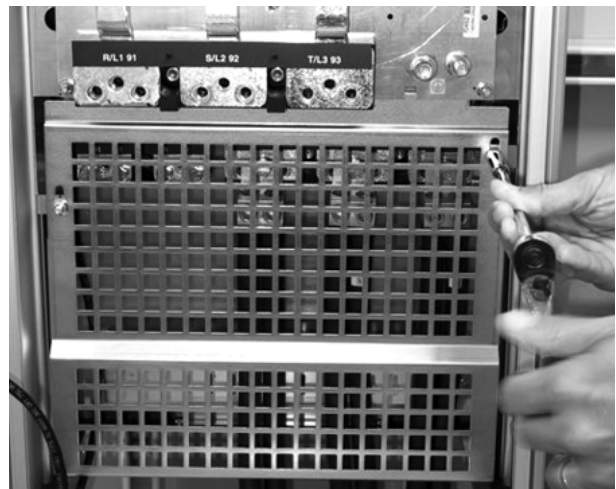

Fig. 13 Fitting the EMC metal cover

Note *The cable screen must be exposed and in physical contact with the mounting plate and clamp.*

6.2.5 Mains connection

Caution *Check that mains voltage and frequency correspond to the values on the nameplate of the CUE and the motor.*

1. Connect the ground conductor to terminal 95 (PE). See fig. 14.
2. Connect the mains conductors to the terminals 91 (L1), 92 (L2), 93 (L3). See fig. 15.
3. Fix the mains cable with a cable clamp.

6.2.6 Terminal location

Take the following terminal positions into consideration when you design the cable connection. See figs 14 to 16.

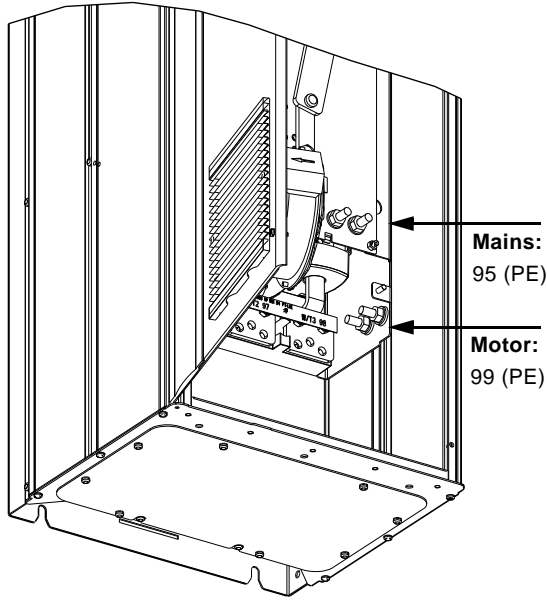

Fig. 14 Ground connection

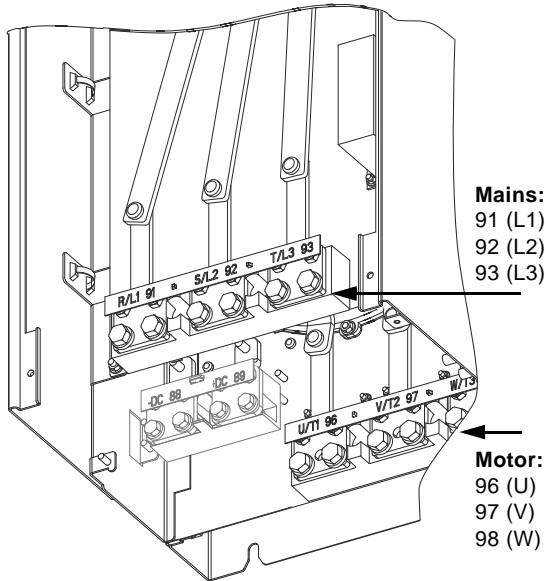

Fig. 15 Mains and motor connection

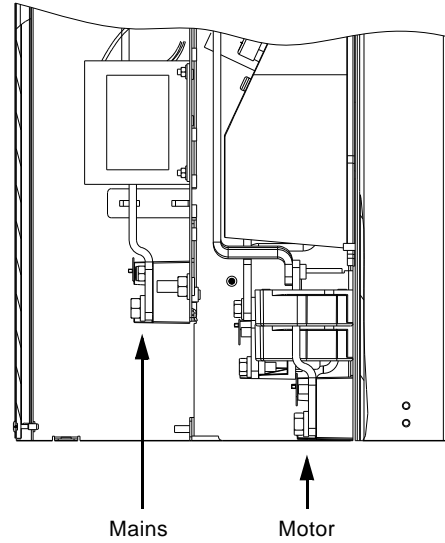

Fig. 16 Position of mains and motor terminals, side view

TM03 9905 4607

TM03 9899 4607

6.3 Connecting the signal terminals

Caution

As a precaution, signal cables must be separated from other groups by reinforced insulation in their entire lengths.

Note

If no external on/off switch is connected, short-circuit terminals 18 and 20 using a short wire.

Connect the signal cables according to the guidelines for good practice to ensure EMC-correct installation. See section 6.6 EMC-correct installation.

- Use screened signal cables with a conductor gauge size of min. 22 AWG and max. 16 AWG.
- Use a 3-conductor screened bus cable in new systems.

TM03 9967 4707

6.3.1 Wiring diagram, signal terminals

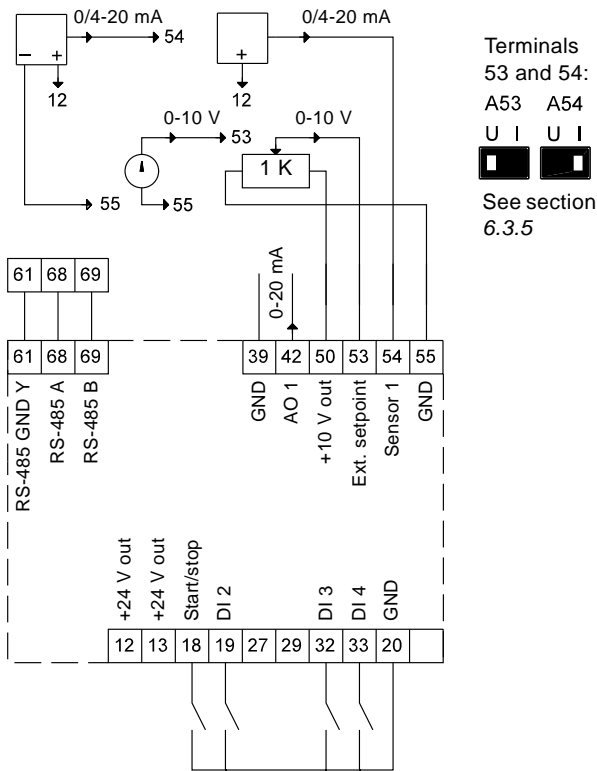

Fig. 17 Wiring diagram, signal terminals

Terminal	Type	Function
12	+24 V out	Supply to sensor
13	+24 V out	Additional supply
18	DI 1	Digital input, start/stop
19	DI 2	Digital input, programmable
20	GND	Ground for digital inputs
32	DI 3	Digital input, programmable
33	DI 4	Digital input, programmable
39	GND	Ground for analog output
42	AO 1	Analog output, 0-20 mA
50	+10 V out	Supply to potentiometer
53	AI 1	External setpoint, 0-10 V/4-20 mA
54	AI 2	Sensor input, sensor 1, 0/4-20 mA
55	GND	Ground for analog inputs
61	RS-485 GND Y	GENIbus, GND
68	RS-485 A	GENIbus, signal A (+)
69	RS-485 B	GENIbus, signal B (-)

Terminals 27, 29 and 37 are not used.

Note The RS-485 screen must be connected to ground.

6.3.2 Minimum connection, signal terminals

Operation is only possible when the terminals 18 and 20 are connected, for instance by means of an external on/off switch or a short wire.

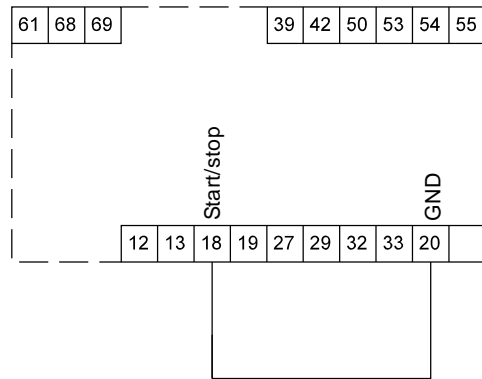

Fig. 18 Required minimum connection, signal terminals

6.3.3 Access to signal terminals

All terminals for signal cables are located beneath the control panel and can be accessed by opening the door of the CUE. See fig. 19.

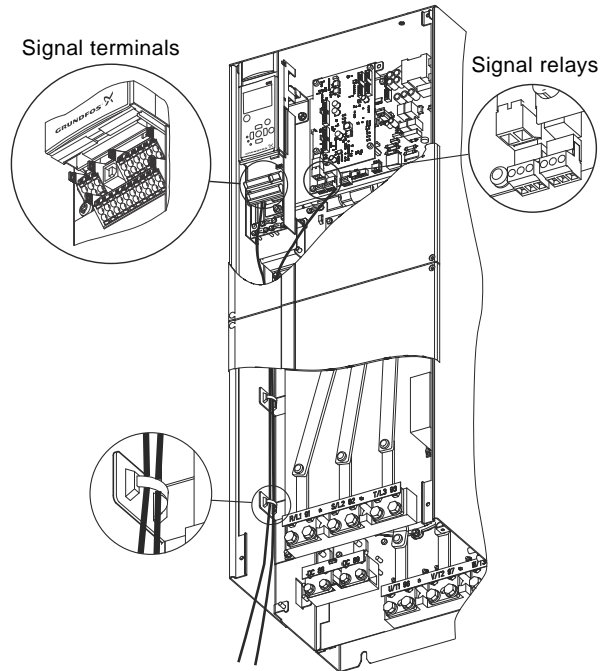

Fig. 19 Signal cable routing

6.3.4 Fitting the conductor

1. Remove the insulation at a length of 0.34 - 0.39 in (9-10 mm).
2. Insert a screwdriver with a tip of maximum 0.015 x 0.1 in (0.4 x 2.5 mm) into the square hole.
3. Insert the conductor into the corresponding round hole. Remove the screwdriver. The conductor is now fixed in the terminal.

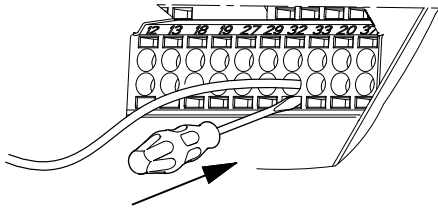

Fig. 20 Fitting the conductor into the signal terminal

6.3.5 Setting the analog inputs, terminals 53 and 54

The contacts A53 and A54 are positioned behind the control panel and used for setting the signal type of the two analog inputs.

The factory setting of the inputs is voltage signal "U".

If a 0/4-20 mA sensor is connected to terminal 54, the input must be set to current signal "I".

Note

Switch off the power supply before setting the A54.

Remove the control panel to set the contact. See fig. 21.

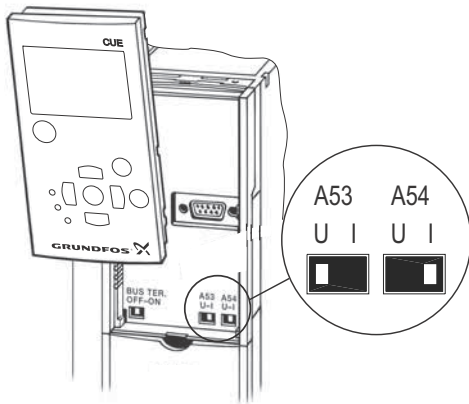

Fig. 21 Setting contact A54 to current signal "I"

6.3.6 RS-485 GENIbus network connection

One or more CUE units can be connected to a control unit via GENIbus. See the example in fig. 22.

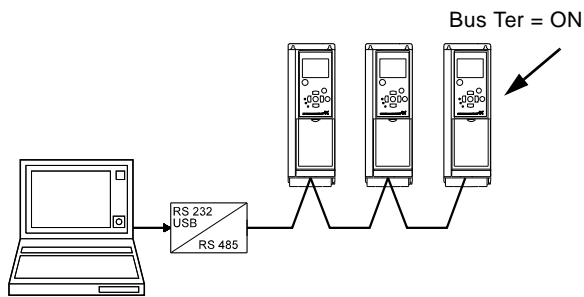

Fig. 22 Example of an RS-485 GENIbus network

The reference potential, GND, for RS-485 (Y) communication must be connected to terminal 61.

If more than one CUE unit is connected to a GENIbus network, the termination contact of the last CUE must be set to "ON" (termination of the RS-485 port).

The factory setting of the termination contact is "OFF" (not terminated).

Remove the control panel to set the contact. See fig. 23.

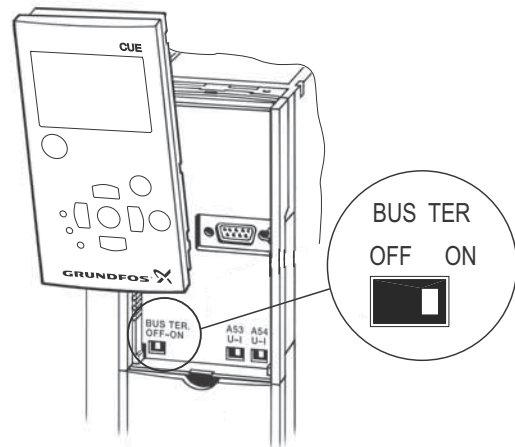

Fig. 23 Setting the termination contact to "ON"

6.4 Connecting the signal relays

Caution

As a precaution, signal cables must be separated from other groups by reinforced insulation in their entire lengths.

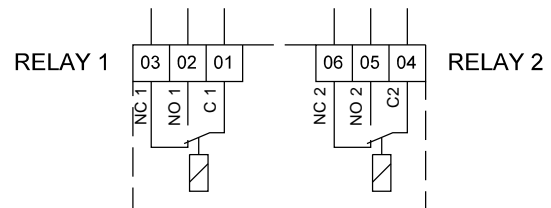

Fig. 24 Terminals for signal relays in normal state (not activated)

Terminal	Function	
C 1	C 2	Common
NO 1	NO 2	Normally open contact
NC 1	NC 2	Normally closed contact

6.5 Connecting the MCB 114 sensor input module

The MCB 114 is an option offering additional analog inputs for the CUE.

6.5.1 Configuration of the MCB 114

The MCB 114 is equipped with three analog inputs for these sensors:

- One additional sensor 0/4-20 mA. See section 10.7.13 *Sensor 2* (3.16).
- Two Pt100/Pt1000 temperature sensors for measurement of motor bearing temperature or an alternative temperature, such as liquid temperature. See sections 10.7.18 *Temperature sensor 1* (3.21) and 10.7.19 *Temperature sensor 2* (3.22).

When the MCB 114 has been installed, the CUE will automatically detect if the sensor is Pt100 or Pt1000 when it is switched on.

TM03 9026 2807

TM03 9006 2807

TM03 9104 3407

TM03 8801 2507

TM03 9005 2807

6.5.2 Wiring diagram, MCB 114

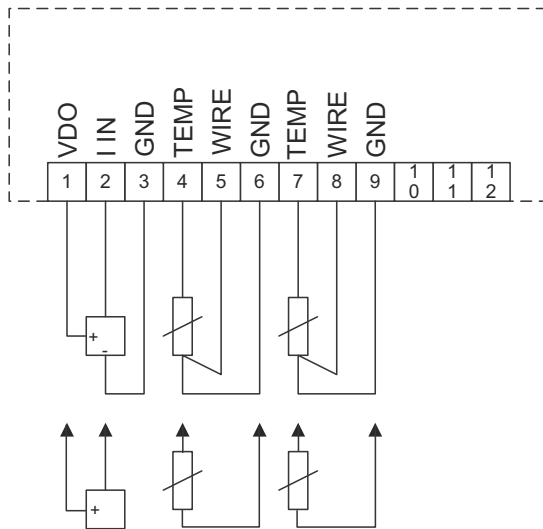

Fig. 25 Wiring diagram, MCB 114

Terminal	Type	Function
1 (VDO)	+24 V out	Supply to sensor
2 (I IN)	AI 3	Sensor 2, 0/4-20 mA
3 (GND)	GND	Ground for analog input
4 (TEMP)	AI 4	Temperature sensor 1, Pt100/Pt1000
5 (WIRE)		
6 (GND)	GND	Ground for temperature sensor 1
7 (TEMP)	AI 5	Temperature sensor 2, Pt100/Pt1000
8 (WIRE)		
9 (GND)	GND	Ground for temperature sensor 2

Terminals 10, 11 and 12 are not used.

6.6 EMC-correct installation

This section gives guidelines for good practice when installing the CUE. Follow these guidelines to meet EN 61800-3, first environment.

- Use only motor and signal cables with a braided metal screen in applications without output filter.
- There are no special requirements to supply cables, apart from local requirements.
- Leave the screen as close to the connecting terminals as possible. See fig. 26.
- Avoid terminating the screen by twisting the ends. See fig. 27. Use cable clamps or EMC screwed cable entries instead.
- Connect the screen to ground at both ends for both motor and signal cables. See fig. 28. If the controller has no cable clamps, connect only the screen to the CUE. See fig. 29.
- Avoid unscreened motor and signal cables in electrical cabinets with variable frequency drives.
- Make the motor cable as short as possible in applications without output filter to limit the noise level and minimise leakage currents.
- Screws for ground connections must always be tightened whether a cable is connected or not.
- Keep main cables, motor cables and signal cables separated in the installation, if possible.

Other installation methods may give similar EMC results if the above guidelines for good practice are followed.

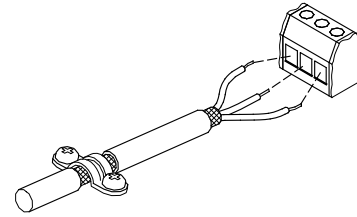

Fig. 26 Example of stripped cable with screen

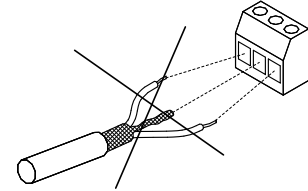

Fig. 27 Do not twist the screen ends

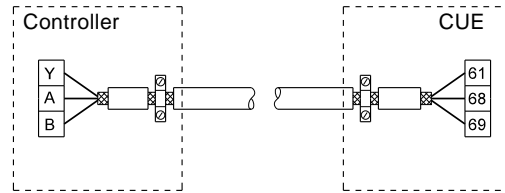

Fig. 28 Example of connection of a 3-conductor bus cable with screen connected at both ends

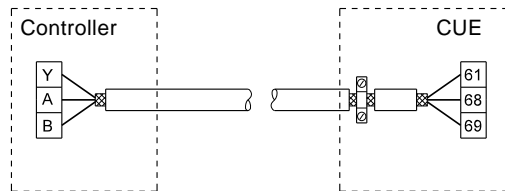

Fig. 29 Example of connection of a 3-conductor bus cable with screen connected at the CUE (controller with no cable clamps)

6.7 RFI filters

To meet the EMC requirements, the CUE comes with the following types of built-in radio frequency interference filter (RFI):

Voltage	Typical shaft power P2	RFI filter type
3 x 380-500 V	150-350 hp	C3
3 x 525-690 V	150-350 hp	C3

Description of RFI filter types

C3: For use in industrial areas with own low-voltage transformer

RFI filter types are according to EN 61800-3.

6.7.1 Equipment of category C3

- This type of power drive system (PDS) is not intended to be used on a low-voltage public network which supplies domestic premises.
- Radio frequency interference is expected if used on such a network.

6.8 Output filters

Output filters are used for reducing the voltage stress on the motor windings and the stress on the motor insulation system as well as for decreasing acoustic noise from the variable-frequency-driven motor.

Two types of output filter are available as accessories for the CUE:

- dU/dt filters
- sine-wave filters.

Use of output filters

Pump type	Typical shaft power P2	dU/dt filter [ft]	Sine-wave filter [ft]
SP, BM, BMB with 380 V motor and up	150 hp and up	0-500	500-1000
Other pumps, noise reduction	150 hp and up	0-500	500-1000
Other pumps, higher noise reduction	150 hp and up	–	1000
Pumps with 690 V motor	All	–	1000

The lengths stated apply to the motor cable.

Figures 30 and 31 show installations with and without filter and where to use screened and unshielded cable.

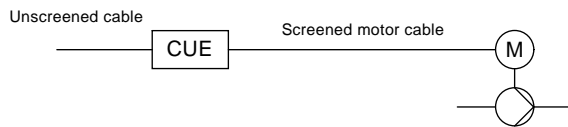

TM03 8802 2507

Fig. 30 Example of installation without filter

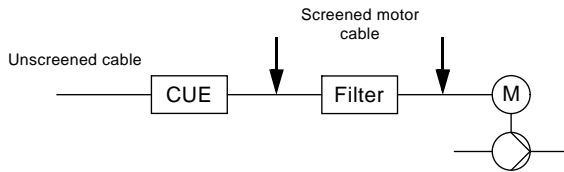

TM03 8803 2507

Fig. 31 Example of installation with filter. The cable between the CUE and filter must be short.

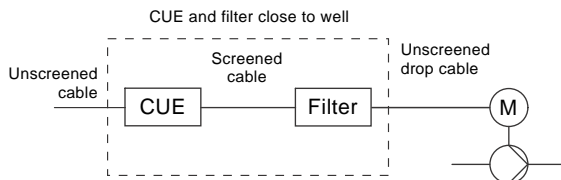

TM04 3579 4608

Fig. 32 Submersible pump without connection box. Variable frequency drive and filter installed close to the well.

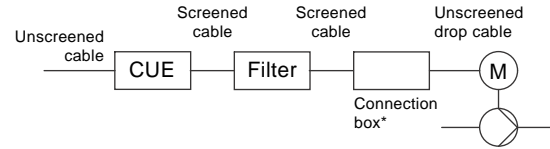

TM04 3580 4608

* Both ends of the screened cable between filter and connection box must be connected to ground.

Fig. 33 Submersible pump with connection box and screened cable. Variable frequency drive and filter installed close to the well.

7. Operating modes

The following operating modes are set on the control panel in menu OPERATION, display 1.2. See section 10.5.2.

Operating mode	Description
<i>Normal</i>	The pump is running in the control mode selected.
<i>Stop</i>	The pump has been stopped (green indicator light is flashing).
<i>Min.</i>	The pump is running at minimum speed.
<i>Max.</i>	The pump is running at maximum speed.

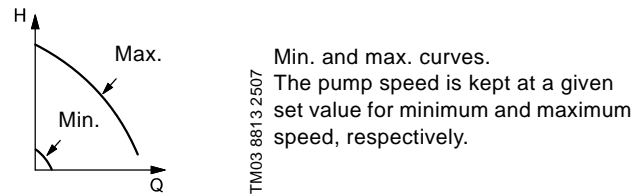

TM03 8813 2507

Example: Max. curve operation can for instance be used in connection with venting the pump during installation.

Example: Min. curve operation can for instance be used in periods with a very small flow requirement.

8. Control modes

The control mode is set on the control panel in menu INSTALLATION, display 3.1. See section 10.7.1.

There are two basic control modes:

- Uncontrolled operation (open loop)
 - Controlled operation (closed loop) with a sensor connected.
- See sections 8.1 and 8.2.

8.1 Uncontrolled operation (open loop)

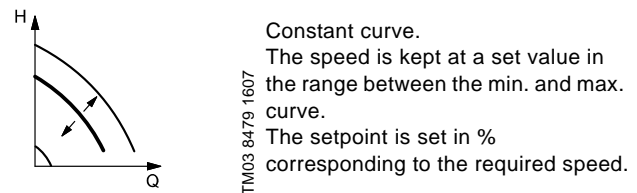

TM03 8479 1607

Example: Operation on constant curve can for instance be used for pumps with no sensor connected.

Example: Typically used in connection with an overall control system such as the MPC or another external controller.

8.2 Controlled operation (closed loop)

US

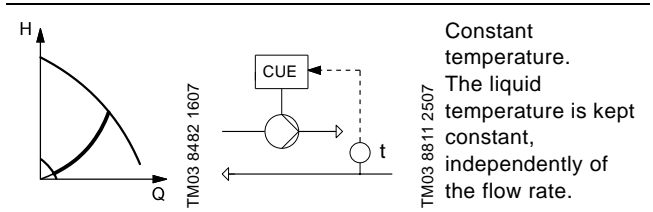
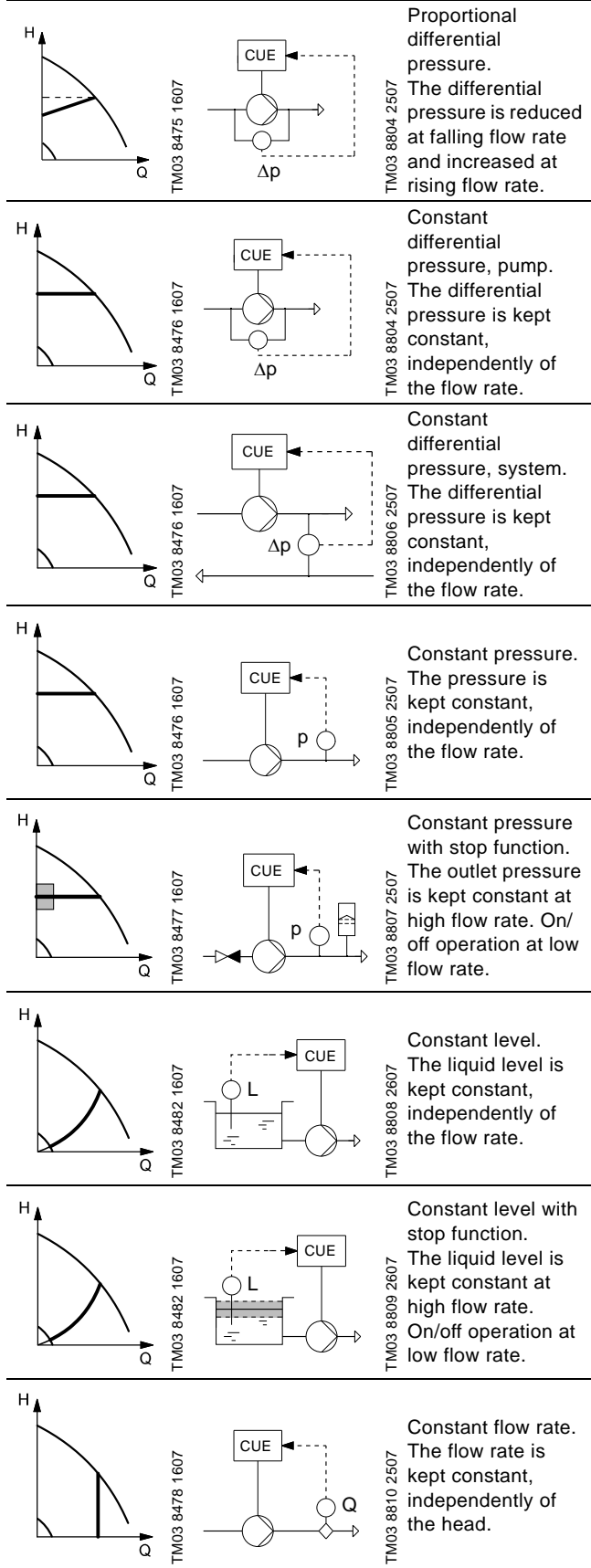

9. Menu overview

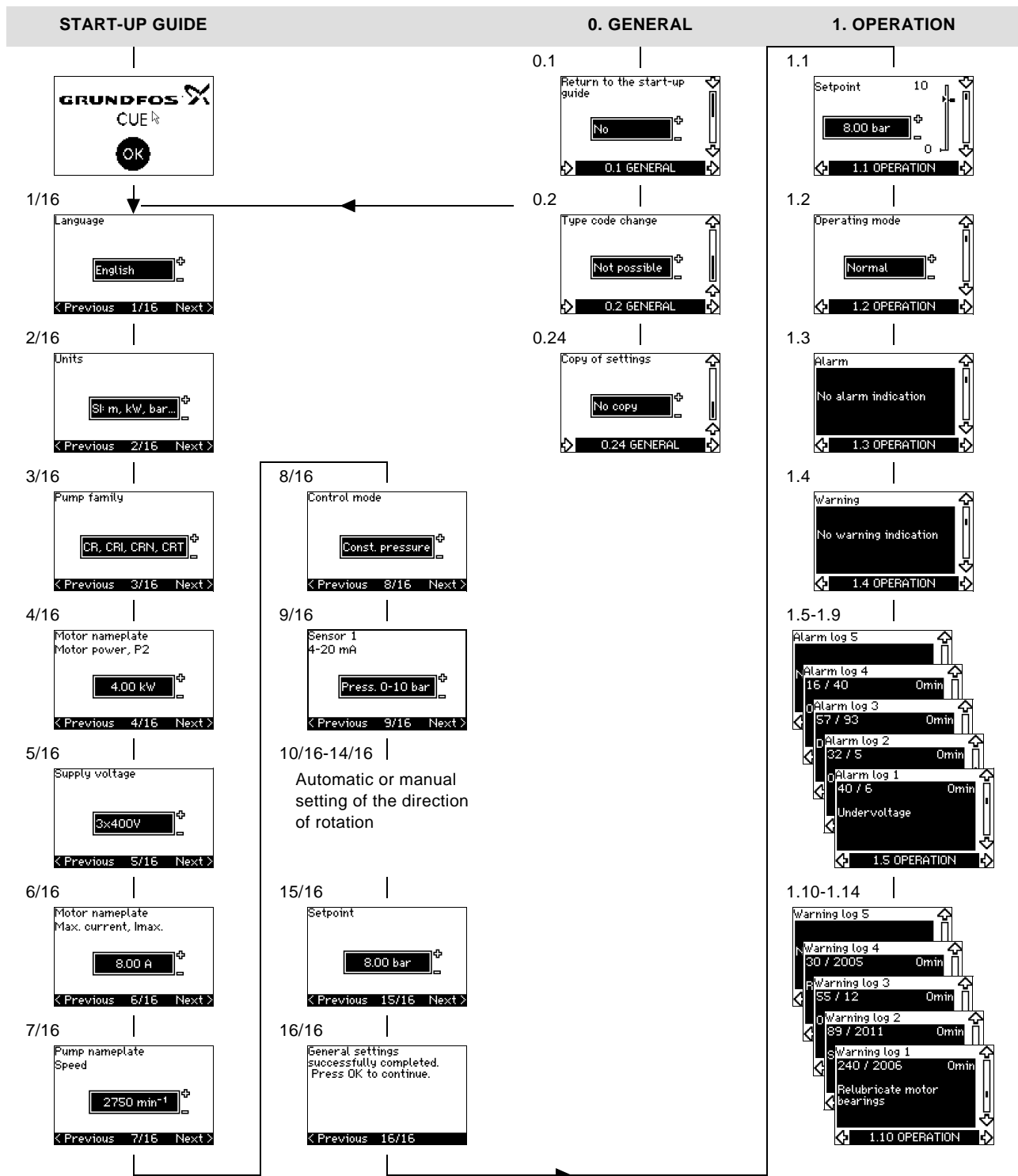

Fig. 34 Menu overview

Menu structure

The CUE has a start-up guide, which is started at the first start-up. After the start-up guide, the CUE has a menu structure divided into four main menus:

- GENERAL** gives access to the start-up guide for the general setting of the CUE.
- OPERATION** enables the setting of setpoint, selection of operating mode and resetting of alarms. It is also possible to see the latest five warnings and alarms.
- STATUS** shows the status of the CUE and the pump. It is not possible to change or set values.
- INSTALLATION** gives access to all parameters. Here a detailed setting of the CUE can be made.

2. STATUS

2.1 Actual setpoint
8.00 bar
External setpoint
100 %
2.1 STATUS

2.2 Operating mode
Normal
From
CUE menu
2.2 STATUS

2.3 Actual value
7.90 bar
2.3 STATUS

2.4 Measured value sensor 1
7.90 bar
2.4 STATUS

2.5 Measured value sensor 2
0.20 bar
2.5 STATUS

2.6 Speed
2750 min⁻¹
2.6 STATUS

2.7 Input power
21.7 kW
Motor current
0.00 A
2.7 STATUS

2.8 Operating hours
0 h
Power consumption
2605 kWh
2.8 STATUS

2.9 Bearings relubricated
0 times
Replace bearings at
5 times
2.9 STATUS

2.10 Relubricate motor bearings
Do it now!
2.10 STATUS

2.11 Replace motor bearings
Do it now!
2.11 STATUS

2.12 Temperature sensor 1
Not active
0 °C
2.12 STATUS

2.13 Temperature sensor 2
Not active
0 °C
2.13 STATUS

2.14 Flow rate
90 m³/h
2.14 STATUS

2.15 Accumulated flow
12000 m³
Energy per m³
0.22 kWh/m³
2.15 STATUS

2.16 Firmware version
99.56
2.16 STATUS

2.17 Factory configuration file
id
40
2.17 STATUS

3. INSTALLATION

3.1 Control mode
Const. pressure
3.1 INSTALLATION

3.2 Controller
Kp 0.50
Ti 0.50 s
3.2 INSTALLATION

3.3 External setpoint 0-10 V
Not active
3.3 INSTALLATION

3.3A External setpoint
Min. 0.00 V
Max. 10.0 V
3.3A INSTALLATION

3.4 Signal relay 1 activated during
Alarm
3.4 INSTALLATION

3.5 Signal relay 2 activated during
Warning
3.5 INSTALLATION

3.6 +/-, OK, On/Off buttons
Active
3.6 INSTALLATION

3.7 Protocol
GENibus
3.7 INSTALLATION

3.8 Pump number
1
3.8 INSTALLATION

3.9 Digital input 2
Ext. fault
3.9 INSTALLATION

3.12 Digital flow input
100 l/pulse
3.12 INSTALLATION

3.13 Stop function
Not active
ΔH 10 %
3.13 INSTALLATION

3.15 Sensor 1
4-20mA bar
0.00 - 10.0
3.15 INSTALLATION

3.16 Sensor 2
4-20mA %
0.00 - 100
3.16 INSTALLATION

3.17 Duty/standby
Not active
3.17 INSTALLATION

3.18 Operating range
Min. 25 %
Max. 100 %
3.18 INSTALLATION

3.19 Motor bearing monitoring
Active
3.19 INSTALLATION

3.20 Motor bearings
Relubricated
3.20 INSTALLATION

3.21 Temperature sensor 1
Not active
3.21 INSTALLATION

3.22 Temperature sensor 2
Not active
3.22 INSTALLATION

3.10



3.11

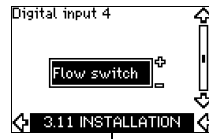

3.23



3.24

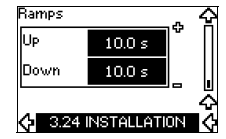

US

10. Setting by means of the control panel

10.1 Control panel



Warning

The On/Off button on the control panel does not disconnect the CUE from the power supply and must therefore not be used as a safety switch.



The On/Off button has the highest priority. In "off" condition, pump operation is not possible.

The control panel is used for local setting of the CUE. The functions available depend on the pump family connected to the CUE.

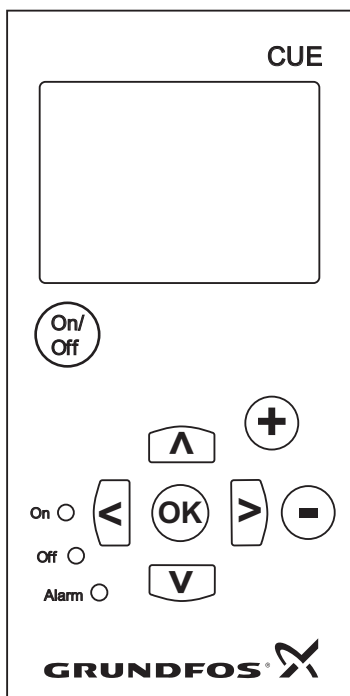

Fig. 35 Control panel of the CUE

Editing buttons

Button	Function
	Makes the pump ready for operation/starts and stops the pump.
	Saves changed values, resets alarms and expands the value field.
	Changes values in the value field.

Navigating buttons

Button	Function
	Navigates from one menu to another. When the menu is changed, the display shown will always be the top display of the new menu.
	Navigates up and down in the individual menu.

The editing buttons of the control panel can be set to these values:

- **Active**
- *Not active.*

When set to *Not active* (locked), the editing buttons do not function. It is only possible to navigate in the menus and read values.

Activate or deactivate the buttons by pressing the arrow up and arrow down buttons simultaneously for 3 seconds.

Adjusting the display contrast

Press OK and + for darker display.

Press OK and - for brighter display.

Indicator lights

The operating condition of the pump is indicated by the indicator lights on the front of the control panel. See fig. 35.

The table show the function of the indicator lights.

Indicator light	Function
On (green)	The pump is running or has been stopped by a stop function. If flashing, the pump has been stopped by the user (CUE menu), external start/stop or bus.
Off (orange)	The pump has been stopped with the On/Off button.
Alarm (red)	Indicates an alarm or a warning.

Displays, general terms

Figures 36 and 37 shows the general terms of the display.

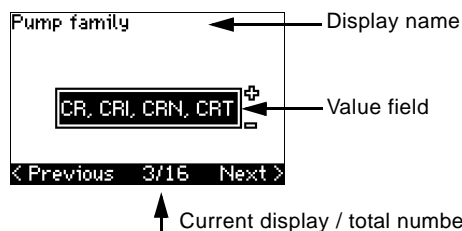

Fig. 36 Example of display in the start-up guide

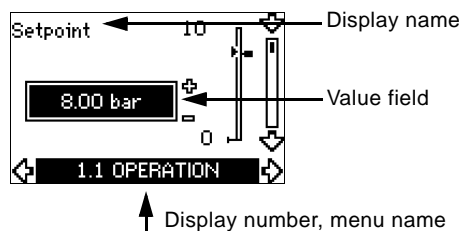

Fig. 37 Example of display in the user menu

10.2 Back to factory setting

Follow this procedure to get back to the factory setting:

1. Switch off the power supply to the CUE.
2. Press On/Off, OK and + while switching on the power supply. The CUE will reset all parameters to factory settings. The display will turn on when the reset is completed.

10.3 Start-up guide

Check that equipment connected is ready for start-up, and that the CUE has been connected to power supply.

Note

Have nameplate data for motor, pump and CUE at hand.

Use the start-up guide for the general setting of the CUE including the setting of the correct direction of rotation.

The start-up guide is started the first time when the CUE is connected to supply voltage. It can be restarted in menu GENERAL. Please note that in this case all previous settings will be erased.

Bulleted lists show possible settings. Factory settings are shown in bold.

10.3.1 Welcoming display



- Press OK. You will now be guided through the start-up guide.

10.3.2 Language (1/16)



Select the language to be used in the display:

- **English UK**
- **English US**
- German
- French
- Italian
- Spanish
- Portuguese
- Greek
- Dutch
- Swedish
- Finnish
- Danish
- Polish
- Russian
- Hungarian
- Czech
- Chinese
- Japanese
- Korean.

10.3.3 Units (2/16)



Select the units to be used in the display:

- **SI: m, kW, bar...**
- US: ft, HP, psi...

10.3.4 Pump family (3/16)



Select pump family according to the pump nameplate:

- **CR, CRI, CRN, CRT**
- SP, SP-G, SP-NE
- ...

Select "Other" if the pump family is not on the list.

10.3.5 Rated motor power (4/16)

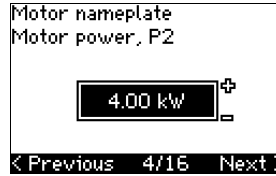

Set the rated motor power, P2, according to the motor nameplate:

- 150-350 HP (110-250 kW).

The setting range is size-related, and the factory setting corresponds to the rated power of the CUE.

10.3.6 Supply voltage (5/16)

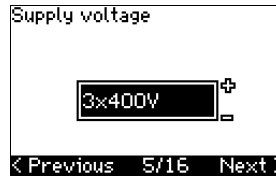

Select supply voltage according to the rated supply voltage of the installation site.

Unit 1 x 200-240 V:*	Unit 3 x 200-240 V:	Unit 3 x 380-500 V:
• 1 x 200 V	• 3 x 200 V	• 3 x 380 V
• 1 x 208 V	• 3 x 208 V	• 3 x 400 V
• 1 x 220 V	• 3 x 220 V	• 3 x 415 V
• 1 x 230 V	• 3 x 230 V	• 3 x 440 V
• 1 x 240 V.	• 3 x 240 V.	• 3 x 460 V
		• 3 x 500 V.
Unit 3 x 525-600 V:		Unit 3 x 525-690 V:
• 3 x 575 V.		• 3 x 575 V
		• 3 x 690 V.

* Single-phase input - three-phase output.

The setting range depends on the CUE type, and the factory setting corresponds to the rated supply voltage of the CUE.

10.3.7 Max. motor current (6/16)



Set the maximum motor current according to the motor nameplate:

- 0-999 A.

The setting range depends on the CUE type, and the factory setting corresponds to a typical motor current at the motor power selected.

10.3.8 Speed (7/16)



Set the rated speed according to the pump nameplate:

- 0-9999 rpm.

The factory setting depends on previous selections. Based on the set rated speed, the CUE will automatically set the motor frequency to 50 or 60 Hz.

10.3.9 Frequency (7A/16)

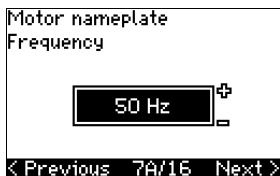

This display appears only if manual entering of the frequency is required.

Set the frequency according to the motor nameplate:

- 40-200 Hz.

The factory setting depends on previous selections.

10.3.10 Control mode (8/16)

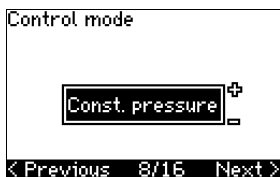

Select the desired control mode. See section 10.7.1.

- *Open loop*
- *Const. pressure*
- *Const. diff. pressure*
- *Prop. diff. pressure*
- *Const. flow rate*
- *Const. temperature*
- *Constant level*
- *Const. other value.*

The possible settings and the factory setting depend on the pump family.

The CUE will give an alarm if the control mode selected requires a sensor and no sensor has been installed. To continue the setting without a sensor, select "Open loop", and proceed. When a sensor has been connected, set the sensor and control mode in menu INSTALLATION.

10.3.11 Rated flow rate (8A/16)

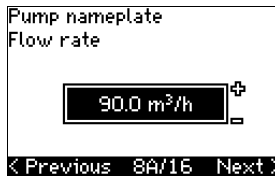

This display appears only if the control mode selected is proportional differential pressure.

Set the rated flow rate according to the pump nameplate:

- 1-28840 gpm (1-6550 m³/h).

10.3.12 Rated head (8B/16)

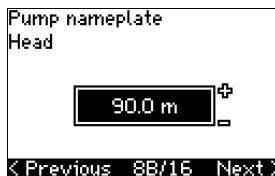

This display only appears if the control mode selected is proportional differential pressure.

Set the rated head according to the pump nameplate:

- 1-3277 ft (1-950 m).

10.3.13 Sensor connected to terminal 54 (9/16)



Set the measuring range of the connected sensor with a signal range of 4-20 mA. The measuring range depends on the control mode selected:

Proportional differential pressure:	Constant differential pressure:
<ul style="list-style-type: none"> • 0-20 ft • 0-33 ft • 0-54 ft • 0-84 ft • 0-200 ft • 0-334 ft • <i>Other.</i> 	<ul style="list-style-type: none"> • 0-20 ft • 0-33 ft • 0-54 ft • 0-84 ft • 0-200 ft • 0-334 ft • <i>Other.</i>
Constant pressure:	Constant flow rate:
<ul style="list-style-type: none"> • 0-58 psi • 0-87 psi • 0-120 psi • 0-145 psi • 0-232 psi • 0-362 psi • 0-580 psi • 0-870 psi • <i>Other.</i> 	<ul style="list-style-type: none"> • <i>Other.</i>
Constant temperature:	Constant level:
<ul style="list-style-type: none"> • <i>Other.</i> 	<ul style="list-style-type: none"> • <i>Other.</i>

If the control mode selected is "Const. other value", or if the measuring range selected is "Other", the sensor must be set according to the next section, display 9A/16.

10.3.14 Another sensor connected to terminal 54 (9A/16)

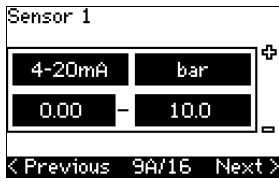

This display only appears when the control mode "Const. other value" or the measuring range "Other" has been selected in display 9/16.

- Sensor output signal:
0-20 mA
4-20 mA.
- Unit of measurement of sensor:
bar, mbar, m, kPa, psi, ft, m³/h, m³/min, m³/s, l/h, l/min, l/s, gal/h, gal/m, gal/s, ft³/h, ft³/min, ft³/s, °C, °F, %.
- Sensor measuring range.

The measuring range depends on the sensor connected and the measuring unit selected.

10.3.15 Priming and venting (10/16)

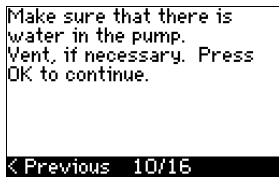

See the installation and operating instructions of the pump.

The general setting of the CUE is now completed, and the start-up guide is ready for setting the direction of rotation:

- Press OK to go on to automatic or manual setting of the direction of rotation.

10.3.16 Automatic setting of the direction of rotation (11/16)



Warning

During the test, the pump will run for a short time. Ensure no personnel or equipment is in danger!

Note

Before setting the direction of rotation, the CUE will make an automatic motor adaptation of certain pump types. This will take a few minutes. The adaptation is carried out during standstill.

The CUE automatically tests and sets the correct direction of rotation without changing the cable connections.

This test is not suitable for certain pump types and will in certain cases not be able to determine for certainty the correct direction of rotation. In these cases, the CUE changes over to manual setting where the direction of rotation is determined on the basis of the installer's observations.

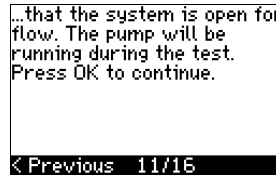
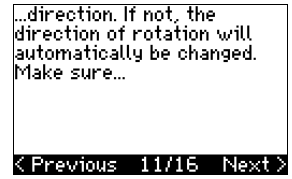
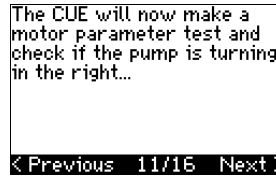

Information displays.

- Press OK to continue.

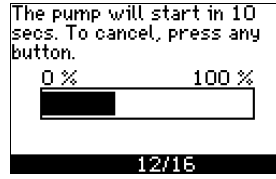

The pump starts after 10 seconds.

It is possible to interrupt the test and return to the previous display.

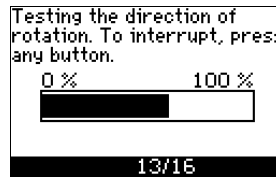

The pump runs with both directions of rotation and stops automatically.

It is possible to interrupt the test, stop the pump and go to manual setting of the direction of rotation.

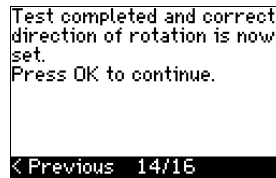

The correct direction of rotation has now been set.

- Press OK to set the setpoint.
See *Setpoint (15/16)* on page 23.

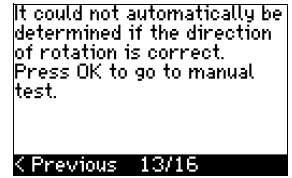

The automatic setting of the direction of rotation has failed.

- Press OK to go to manual setting of the direction of rotation.

10.3.17 Setpoint (15/16)



Set the setpoint according to the control mode and sensor selected.

10.3.18 General settings are completed (16/16)

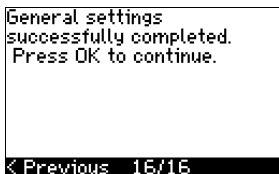

- Press OK to make the pump ready for operation or start the pump in the operating mode *Normal*. Then display 1.1 of menu OPERATION will appear.

10.3.19 Manual setting when the direction of rotation is visible (13/16)

It must be possible to observe the motor fan or shaft.

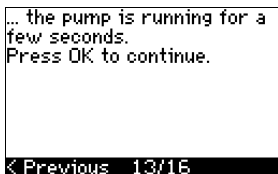
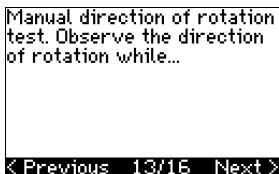

Information displays.

- Press OK to continue.

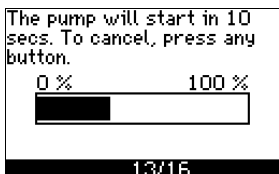

The pump starts after 10 seconds.

It is possible to interrupt the test and return to the previous display.



The pressure will be shown during the test if a pressure sensor is connected. The motor current is always shown during the test.

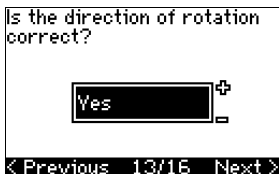

State if the direction of rotation is correct.

- **Yes**

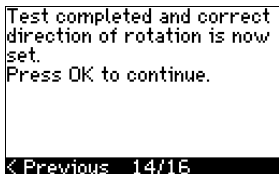

The correct direction of rotation has now been set.

- Press OK to set the setpoint.
See *Setpoint (15/16)* on page 23.

- **No**

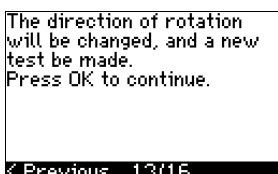

The direction of rotation is not correct.

- Press OK to repeat the test with the opposite direction of rotation.

10.3.20 Manual setting when the direction of rotation is not visible (13/16)

It must be possible to observe the head or flow rate.

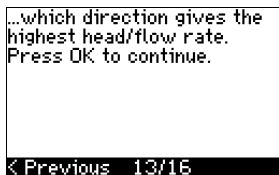
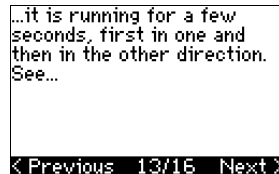
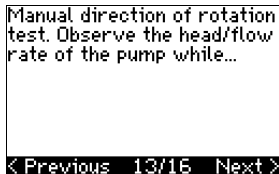

Information displays.

- Press OK to continue.

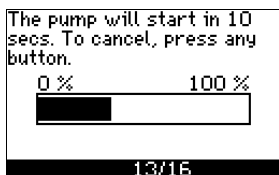

The pump starts after 10 seconds.

It is possible to interrupt the test and return to the previous display.

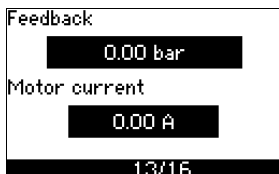

The pressure will be shown during the test if a pressure sensor is connected. The motor current is always shown during the test.

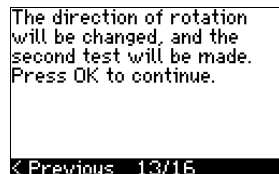
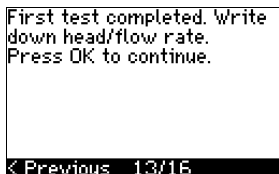

The first test is completed.

- Write down the pressure and/or flow rate, and press OK to continue the manual test with the opposite direction of rotation.

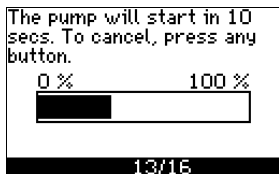

The pump starts after 10 seconds.

It is possible to interrupt the test and return to the previous display.



The pressure will be shown during the test if a pressure sensor is connected. The motor current is always shown during the test.

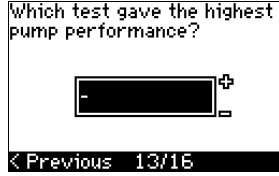
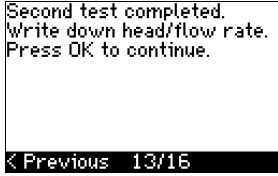

The second test is completed.

Write down the pressure and/or flow rate, and state which test gave the highest pump performance:

- First test
- Second test
- Make new test.

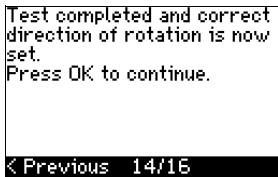

The correct direction of rotation has now been set.

- Press OK to set the setpoint. See *Setpoint (15/16)* on page 23.

10.4 Menu GENERAL

Note *If the start-up guide is started, all previous settings will be erased!*

Note *The start-up guide must be carried out on a cold motor!*

Note *Repeating the start-up guide may lead to a heating of the motor.*

The menu makes it possible to return to the start-up guide, which is usually only used during the first start-up of the CUE.

10.4.1 Return to start-up guide (0.1)

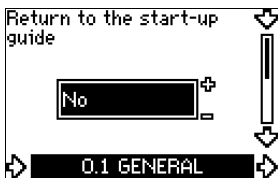

State your choice:

- Yes
- No.

If Yes is selected, all settings will be erased, and the entire start-up guide must be completed.

10.4.2 Type code change (0.2)

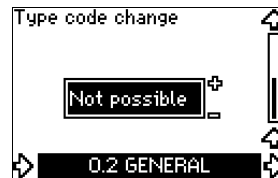

This display is for service use only.

10.4.3 Copy of settings

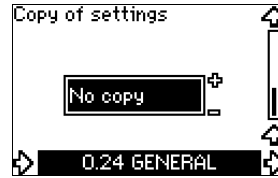

It is possible to copy the settings of a CUE and reuse them in another one.

Options:

- No copy.
- to CUE (copies the settings of the CUE).
- to control panel (copies the settings to another CUE).

The CUE units must have the same firmware version. See section *10.6.16 Firmware version (2.16)*.

10.5 Menu OPERATION

10.5.1 Setpoint (1.1)

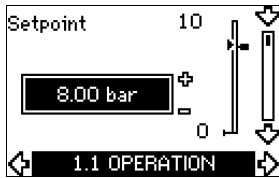

- ▶ Setpoint set
- ▶ Actual setpoint
- Actual value

Set the setpoint in units of the feedback sensor.

In control mode **Open loop**, the setpoint is set in % of the maximum performance. The setting range will lie between the min. and max. curves. See fig. 44.

In **all other** control modes except proportional differential pressure, the setting range is equal to the sensor measuring range. See fig. 45.

In control mode **Proportional differential pressure**, the setting range is equal to 25 % to 90 % of max. head. See fig. 46.

If the pump is connected to an external setpoint signal, the value in this display will be the maximum value of the external setpoint signal. See section 13.2 *External setpoint*.

10.5.2 Operating mode (1.2)

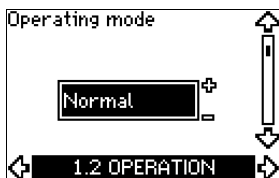

Set one of the following operating modes:

- **Normal** (duty)
- *Stop*
- *Min.*
- *Max.*

The operating modes can be set without changing the setpoint setting.

10.5.3 Fault indications

Faults may result in two types of indication: Alarm or warning.

An **"alarm"** will activate an alarm indication in CUE and cause the pump to change operating mode, typically to stop. However, for some faults resulting in alarm, the pump is set to continue operating even if there is an alarm.

A **"warning"** will activate a warning indication in CUE, but the pump will not change operating or control mode.

Alarm (1.3)

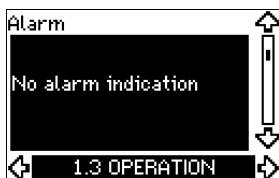

In case of an alarm, the cause will appear in the display. See section 15.1 *Warning and alarm list*.

Warning (1.4)

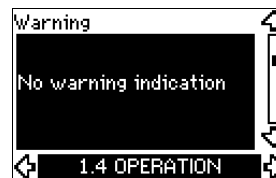

In case of warning, the cause will appear in the display. See section 15.1 *Warning and alarm list*.

10.5.4 Fault log

For both fault types, alarm and warning, the CUE has a log function.

Alarm log (1.5-1.9)

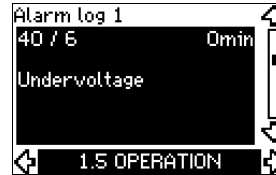

In case of an "alarm", the last five alarm indications will appear in the alarm log. "Alarm log 1" shows the latest alarm, "Alarm log 2" shows the latest alarm but one, etc.

The display shows three pieces of information:

- the alarm indication
- the alarm code
- the number of minutes the pump has been connected to the power supply after the alarm occurred.

Warning log (1.10-1.14)

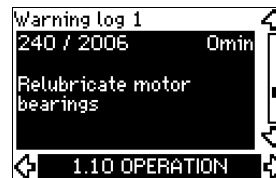

In case of a "warning", the last five warning indications will appear in the warning log. "Warning log 1" shows the latest fault, "Warning log 2" shows the latest fault but one, etc.

The display shows three pieces of information:

- the warning indication
- the warning code
- the number of minutes the pump has been connected to the power supply after the warning occurred.

10.6 Menu STATUS

The displays appearing in this menu are status displays only. It is not possible to change or set values.

The tolerance of the displayed value is stated under each display. The tolerances are stated as a guide in % of the maximum values of the parameters.

10.6.1 Actual setpoint (2.1)

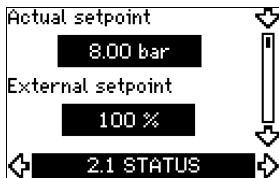

This display shows the actual setpoint and the external setpoint.

The **actual setpoint** is shown in units of feedback sensor.

The **external setpoint** is shown in a range of 0-100 %. If the external setpoint influence is deactivated, the value 100 % is shown. See section 13.2 *External setpoint*.

10.6.2 Operating mode (2.2)

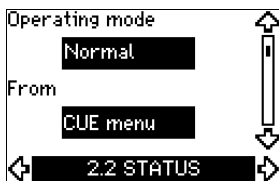

This display shows the actual operating mode (*Normal, Stop, Min.* or *Max.*). Furthermore, it shows where this operating mode was selected (*CUE menu, Bus, External* or *On/off button*).

10.6.3 Actual value (2.3)



This display shows the actual value controlled.

If no sensor is connected to the CUE, "-" will appear in the display.

10.6.4 Measured value, sensor 1 (2.4)



This display shows the actual value measured by sensor 1 connected to terminal 54.

If no sensor is connected to the CUE, "-" will appear in the display.

10.6.5 Measured value, sensor 2 (2.5)



This display is only shown if an MCB 114 sensor input module has been installed.

This display shows the actual value measured by sensor 2 connected to an MCB 114.

If no sensor is connected to the CUE, "-" will appear in the display.

10.6.6 Speed (2.6)



Tolerance: $\pm 5\%$

This display shows the actual pump speed.

10.6.7 Input power and motor current (2.7)

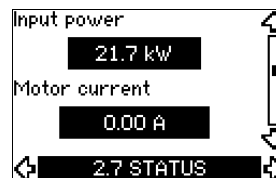

Tolerance: $\pm 10\%$

This display shows the actual pump input power in W or kW and the actual motor current in Ampere [A].

10.6.8 Operating hours and power consumption (2.8)

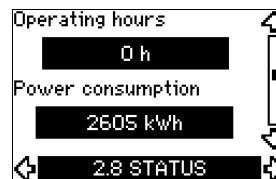

Tolerance: $\pm 2\%$

This display shows the number of operating hours and the power consumption. The value of operating hours is an accumulated value and cannot be reset. The value of power consumption is an accumulated value calculated from the unit's birth, and it cannot be reset.

10.6.9 Lubrication status of motor bearings (2.9)



This display shows how many times the user has given the lubricated information and when to replace the motor bearings. When the motor bearings have been relubricated, confirm this action in the INSTALLATION menu. See section 10.7.17 *Confirming relubrication/replacement of motor bearings (3.20)*. When relubrication is confirmed, the figure in the above display will be increased by one.

10.6.10 Time until relubrication of motor bearings (2.10)



This display is only shown if display 2.11 is not shown. This display shows when to relubricate the motor bearings. The controller monitors the operating pattern of the pump and calculates the period between bearing relubrications. If the operating pattern changes, the calculated time till relubrication may change as well. The estimated time until relubrication takes into account if the pump has been running with reduced speed. See section 10.7.17 *Confirming relubrication/replacement of motor bearings (3.20)*.

10.6.11 Time until replacement of motor bearings (2.11)



This display is only shown if display 2.10 is not shown. This display shows when to replace the motor bearings. The controller monitors the operating pattern of the pump and calculates the period between bearing replacements. The estimated time until replacement of motor bearings takes into account if the pump has been running with reduced speed. See section 10.7.17 *Confirming relubrication/replacement of motor bearings (3.20)*.

10.6.12 Temperature sensor 1 (2.12)

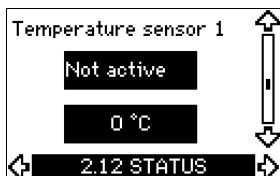

This display is only shown if an MCB 114 sensor input module has been installed. This display shows the measuring point and the actual value measured by Pt100/Pt1000 temperature sensor 1 connected to the MCB 114. The measuring point is selected in display 3.21.

If no sensor is connected to the CUE, "-" will appear in the display.

10.6.13 Temperature sensor 2 (2.13)

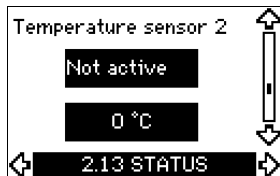

This display is only shown if an MCB 114 sensor input module has been installed. This display shows the measuring point and the actual value measured by Pt100/Pt1000 temperature sensor 2 connected to the MCB 114. The measuring point is selected in display 3.22. If no sensor is connected to the CUE, "-" will appear in the display.

10.6.14 Flow rate (2.14)



This display is only shown if a flowmeter has been configured. This display shows the actual value measured by a flowmeter connected to the digital pulse input (terminal 33) or the analog input (terminal 54).

10.6.15 Accumulated flow (2.15)

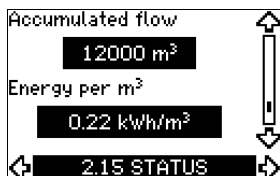

This display is only shown if a flowmeter has been configured. This display shows the value of the accumulated flow and the specific energy for the transfer of the pumped liquid. The flow measurement can be connected to the digital pulse input (terminal 33) or the analog input (terminal 54).

10.6.16 Firmware version (2.16)



This display shows the version of the software.

10.6.17 Configuration file (2.17)



This display shows the configuration file.

10.7 Menu INSTALLATION

10.7.1 Control mode (3.1)

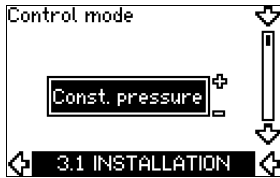

Select one of the following control modes:

- Open loop
- Const. pressure
- Const. diff. pressure
- Prop. diff. pressure
- Const. flow rate
- Const. temperature
- Constant level
- Const. other value.

Note

If the pump is connected to a bus, the control mode cannot be selected via the CUE. See section 13.3 GENibus signal.

10.7.2 Controller (3.2)

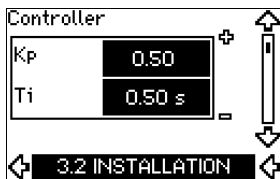

The CUE has a factory setting of gain (K_p) and integral time (T_i). However, if the factory setting is not the optimum setting, the gain and the integral time can be changed in the display.

- The gain (K_p) can be set within the range from 0.1 to 20.
- The integral time (T_i) can be set within the range from 0.1 to 3600 s. If 3600 s is selected, the controller will function as a P controller.
- Furthermore, it is possible to set the controller to inverse control, meaning that if the setpoint is increased, the speed will be reduced. In the case of inverse control, the gain (K_p) must be set within the range from -0.1 to -20.

The table below shows the suggested controller settings:

System/application	K_p		T_i
	Heating system ¹⁾	Cooling system ²⁾	
	0.2		0.5
	SP, SP-G, SP-NE: 0.5		0.5
	0.2		0.5
	SP, SP-G, SP-NE: 0.5		0.5
	0.2		0.5
	-2.5		100
	0.5	-0.5	$10 + 5L_2$
	0.5		$10 + 5L_2$
	0.5	-0.5	$30 + 5L_2^*$
	0.5		0.5^*
	0.5		$L_1 < 5 \text{ m: } 0.5^*$ $L_1 > 5 \text{ m: } 3^*$ $L_1 > 10 \text{ m: } 5^*$

* $T_i = 100$ seconds (factory setting).

1. Heating systems are systems in which an increase in pump performance will result in a **rise** in temperature at the sensor.
 2. Cooling systems are systems in which an increase in pump performance will result in a **drop** in temperature at the sensor.
- L_1 = Distance in [m] between pump and sensor.
 L_2 = Distance in [m] between heat exchanger and sensor.

How to set the PI controller

For most applications, the factory setting of the controller constants K_p and T_i will ensure optimum pump operation. However, in some applications an adjustment of the controller may be needed.

Proceed as follows:

1. Increase the gain (K_p) until the motor becomes unstable. Instability can be seen by observing if the measured value starts to fluctuate. Furthermore, instability is audible as the motor starts hunting up and down. As some systems, such as temperature controls, are slow-reacting, it may be difficult to observe that the motor is unstable.
2. Set the gain (K_p) to half the value of the value which made the motor unstable. This is the correct setting of the gain.
3. Reduce the integral time (T_i) until the motor becomes unstable.
4. Set the integral time (T_i) to twice the value which made the motor unstable. This is the correct setting of the integral time.

General rules of thumb:

- If the controller is too slow-reacting, increase K_p .
- If the controller is hunting or unstable, dampen the system by reducing K_p or increasing T_i .

10.7.3 External setpoint (3.3)

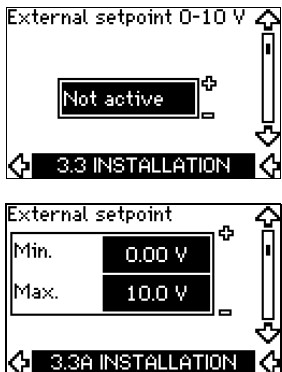

The input for external setpoint signal (terminal 53) can be set to the following types:

- *Active*
- **Not active.**

If *Active* is selected, the actual setpoint is influenced by the signal connected to the external setpoint input. See section 13.2 *External setpoint*.

10.7.4 Signal relays 1 and 2 (3.4 and 3.5)

The CUE has two signal relays. In the display below, select in which operating situations the signal relay should be activated.

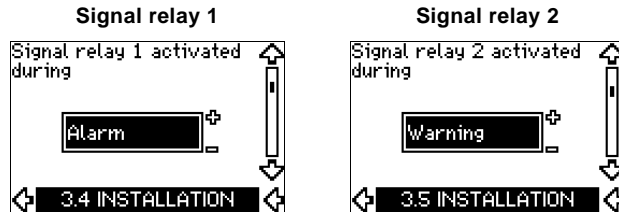

- | | |
|---|---|
| <ul style="list-style-type: none"> • <i>Ready</i> • Alarm • <i>Operation</i> • <i>Pump running</i> • <i>Not active</i> • <i>Warning</i> • <i>Relubricate.</i> | <ul style="list-style-type: none"> • <i>Ready</i> • <i>Alarm</i> • <i>Operation</i> • <i>Pump running</i> • <i>Not active</i> • Warning • <i>Relubricate.</i> |
|---|---|

Note For distinction between alarm and warning, see section 10.5.3 *Fault indications*.

10.7.5 Buttons on the CUE (3.6)



The editing buttons (+, -, On/Off, OK) on the control panel can be set to these values:

- **Active**
- *Not active.*

When set to *Not active* (locked), the editing buttons do not function. Set the buttons to *Not active* if the pump should be controlled via an external control system.

Activate the buttons by pressing the arrow up and arrow down buttons simultaneously for 3 seconds.

10.7.6 Protocol (3.7)

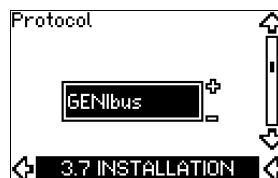

This display shows the protocol selection for the RS-485 port of the CUE. The protocol can be set to these values:

- **GENibus**
- *FC*
- *FC MC.*

If *GENibus* is selected, the communication is set according to the Grundfos GENibus standard. *FC* and *FC MC* is for service purpose only.

10.7.7 Pump number (3.8)



This display shows the GENIbus number. A number between 1 and 199 can be allocated to the pump. In the case of bus communication, a number must be allocated to each pump. The factory setting is "-".

10.7.8 Digital inputs 2, 3 and 4 (3.9 to 3.11)

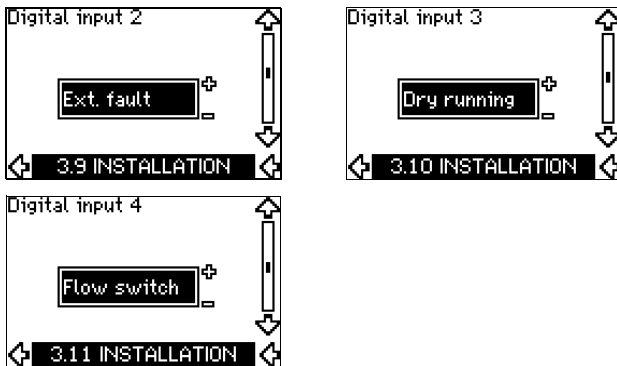

The digital inputs of the CUE (terminal 19, 32 and 33) can individually be set to different functions.

Select one of the following functions:

- *Min.* (min. curve)
- *Max.* (max. curve)
- *Ext. fault* (external fault)
- *Flow switch*
- *Alarm reset*
- *Dry running* (from external sensor)
- *Accumulated flow* (pulse flow, only terminal 33)
- *Not active.*

The selected function is active when the digital input is activated (closed contact). See also section 13.1 *Digital inputs*.

Min.

When the input is activated, the pump will operate according to the min. curve.

Max.

When the input is activated, the pump will operate according to the max. curve.

Ext. fault

When the input is activated, a timer will be started. If the input is activated for more than 5 seconds, an external fault will be indicated. If the input is deactivated, the fault condition will cease and the pump can only be restarted manually by resetting the fault indication.

Flow switch

When this function is selected, the pump will be stopped when a connected flow switch detects low flow.

It is only possible to use this function if the pump is connected to a pressure sensor or a level sensor, and the stop function is activated. See sections 10.7.10 and 10.7.11.

Alarm reset

When the input has been activated, the alarm is reset if the cause of the alarm no longer exists.

Dry running

When this function is selected, lack of inlet pressure or water shortage can be detected. This requires the use of an accessory, such as:

- a Grundfos Liqtec® dry-running switch
- a pressure switch installed on the suction side of a pump
- a float switch installed on the suction side of a pump.

When lack of inlet pressure or water shortage (*Dry running*) is detected, the pump will be stopped. The pump cannot restart as long as the input is activated.

Restarts may be delayed by up to 30 minutes, depending on the pump family.

Accumulated flow

When this function is set for digital input 4 and a pulse sensor is connected to terminal 33, the accumulated flow can be measured.

10.7.9 Digital flow input (3.12)

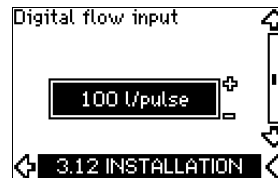

This display appears only if a flowmeter has been configured in display 3.11.

The display is used for setting the volume for every pulse for the function *accumulated flow* with a pulse sensor connected to terminal 33.

Setting range:

- 0-265 gal/pulse (0-1000 litre/pulse).

The volume can be set in the unit selected in the start-up guide.

10.7.10 Constant pressure with stop function (3.13)



Settings

The stop function can be set to these values:

- *Active*
- ***Not active.***

The on/off band can be set to these values:

- ΔH is factory-set to **10 % of actual setpoint.**
- ΔH can be set within the range from 5 % to 30 % of the actual setpoint.

Operating conditions for the stop function

It is only possible to use the stop function if the system incorporates a pressure sensor, a check valve and a diaphragm tank.

Descriptions

The stop function is used for changing between on/off operation at low flow and continuous operation at high flow.

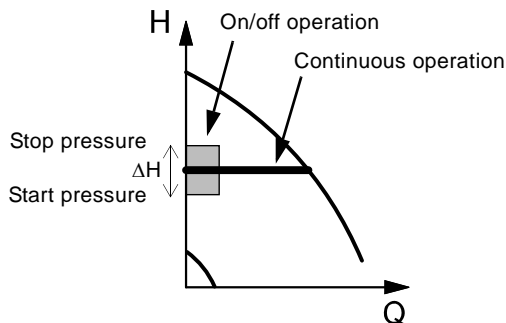

Fig. 38 Constant pressure with stop function. Difference between start and stop pressures (ΔH)

Low flow can be detected in two different ways:

1. A built-in "low-flow detection function" which functions if the digital input is not set up for flow switch.
2. A flow switch connected to the digital input.

1. Low-flow detection function

The pump will check the flow regularly by reducing the speed for a short time. If there is no or only a small change in pressure, this means that there is low flow.

The speed will be increased until the stop pressure (actual setpoint + 0.5 x ΔH) is reached and the pump will stop after a few seconds. The pump will restart at the latest when the pressure has fallen to the start pressure (actual setpoint - 0.5 x ΔH).

If the flow in the off period is higher than the low-flow limit, the pump will restart before the pressure has fallen to the start pressure.

When restarting, the pump will react in the following way:

1. If the flow is higher than the low-flow limit, the pump will return to continuous operation at constant pressure.
2. If the flow is lower than the low-flow limit, the pump will continue in start/stop operation. It will continue in start/stop operation until the flow is higher than the low-flow limit. When the flow is higher than the low-flow limit, the pump will return to continuous operation.

2. Low-flow detection with flow switch

When the digital input is activated because there is low-flow, the speed will be increased until the stop pressure (actual setpoint + 0.5 x ΔH) is reached, and the pump will stop. When the pressure has fallen to start pressure, the pump will start again. If there is still no flow, the pump will reach the stop pressure and stop. If there is flow, the pump will continue operating according to the setpoint.

The check valve must always be installed before the pressure sensor. See figs 39 and 40.

Caution

If a flow switch is used to detect low flow, the switch must be installed on the system side after the diaphragm tank.

TM03 8477 1607

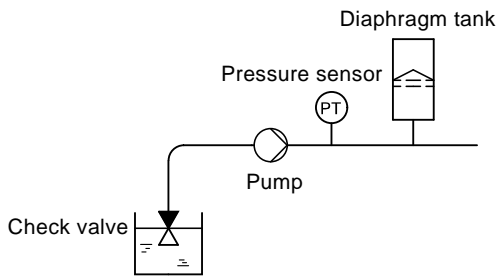

Fig. 39 Position of the check valve and pressure sensor in system with suction lift operation

TM03 8582 1907

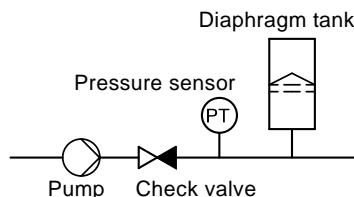

Fig. 40 Position of the check valve and pressure sensor in system with positive inlet pressure

TM03 8582 1907

Diaphragm tank

The stop function requires a diaphragm tank of a certain minimum size. The tank must be installed as close as possible after the pump and the precharge pressure must be 0.7 x actual setpoint. Recommended diaphragm tank size:

Rated flow rate of pump [gpm]	Typical diaphragm tank size [gallons]
0-26	2
27-105	4.4
106-176	14
177-308	34
309-440	62

If a diaphragm tank of the above size is installed in the system, the factory setting of ΔH is the correct setting. If the tank installed is too small, the pump will start and stop too often. This can be remedied by increasing ΔH .

10.7.11 Constant level with stop function (3.13)



Settings

The stop function can be set to these values:

- Active
- **Not active.**

The on/off band can be set to these values:

- ΔH is factory-set to **10 % of actual setpoint.**
- ΔH can be set within the range from 5 % to 30 % of actual setpoint.

A built-in low-flow detection function will automatically measure and store the power consumption at approx. 50 % and 85 % of the rated speed.

If *Active* is selected, proceed as follows:

1. Close the isolating valve to create a no-flow condition.
2. Press OK to start the auto-tuning.

Operating conditions for the stop function

It is only possible to use the constant level stop function if the system incorporates a level sensor, and all valves can be closed.

Description

The stop function is used for changing between on/off operation at low flow and continuous operation at high flow.

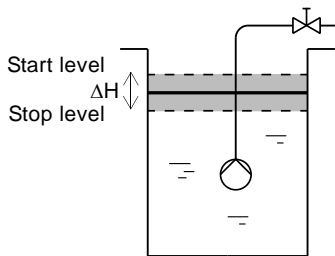

Fig. 41 Constant level with stop function. Difference between start and stop levels (ΔH)

Low flow can be detected in two different ways:

1. With the built-in low-flow detection function.
2. With a flow switch connected to a digital input.

1. Low-flow detection function

The built-in low-flow detection is based on the measurement of speed and power.

When low flow is detected, the pump will stop. When the level has reached the start level, the pump will start again. If there is still no flow, the pump will reach the stop level and stop. If there is flow, the pump will continue operating according to the setpoint.

2. Low-flow detection with flow switch

When the digital input is activated because of low flow, the speed will be increased until the stop level (actual setpoint – 0.5 x ΔH) is reached, and the pump will stop. When the level has reached the start level, the pump will start again. If there is still no flow, the pump will reach the stop level and stop. If there is flow, the pump will continue operating according to the setpoint.

10.7.12 Sensor 1 (3.15)

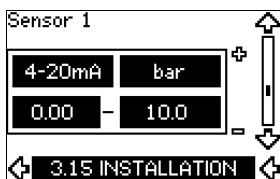

Setting of sensor 1 connected to terminal 54. This is the feedback sensor.

Select among the following values:

- Sensor output signal:
0-20 mA
4-20 mA.
- Unit of measurement of sensor:
bar, mbar, m, kPa, psi, ft, m³/h, m³/s, l/s, gpm, °C, °F, %.
- Sensor measuring range.

10.7.13 Sensor 2 (3.16)

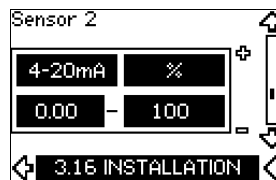

Setting of sensor 2 connected to an MCB 114 sensor input module.

Select among the following values:

- Sensor output signal:
0-20 mA
4-20 mA.
- Unit of measurement of sensor:
bar, mbar, m, kPa, psi, ft, m³/h, m³/s, l/s, gpm, °C, °F, %.
- Sensor measuring range:
0-100 %.

10.7.14 Duty/standby (3.17)



Settings

The duty/standby function can be set to these values:

- *Active*
- **Not active.**

Activate the duty/standby function as follows:

1. Connect one of the pumps to the mains supply. Set the duty/standby function to *Not active*. Make the necessary settings in menu OPERATION and INSTALLATION.
2. Set the operating mode to *Stop* in menu OPERATION.
3. Connect the other pump to the mains supply. Make the necessary settings in menu OPERATION and INSTALLATION. Set the duty/standby function to *Active*.

The running pump will search for the other pump and automatically set the duty/standby function of this pump to *Active*. If it cannot find the other pump, a fault will be indicated.

Note *The two pumps must be connected electrically via the GENibus, and nothing else must be connected on the GENibus.*

The duty/standby function applies to two pumps connected in parallel and controlled via GENibus. Each pump must be connected to its own CUE and sensor.

The primary targets of the function is the following:

- To start the standby pump if the duty pump is stopped due to an alarm.
- To alternate the pumps at least every 24 hours.

TM03 9099 3307

10.7.15 Operating range (3.18)

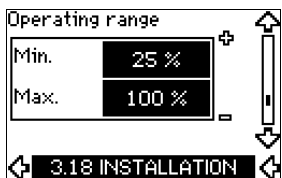

How to set the operating range:

- Set the min. speed within the range from a pump-dependent min. speed to the adjusted max. speed. The factory setting depends on the pump family.
- Set the max. speed within the range from adjusted min. speed to the pump-dependent maximum speed. The factory setting will be equal to 100 %, i.e. the speed stated on the pump nameplate.

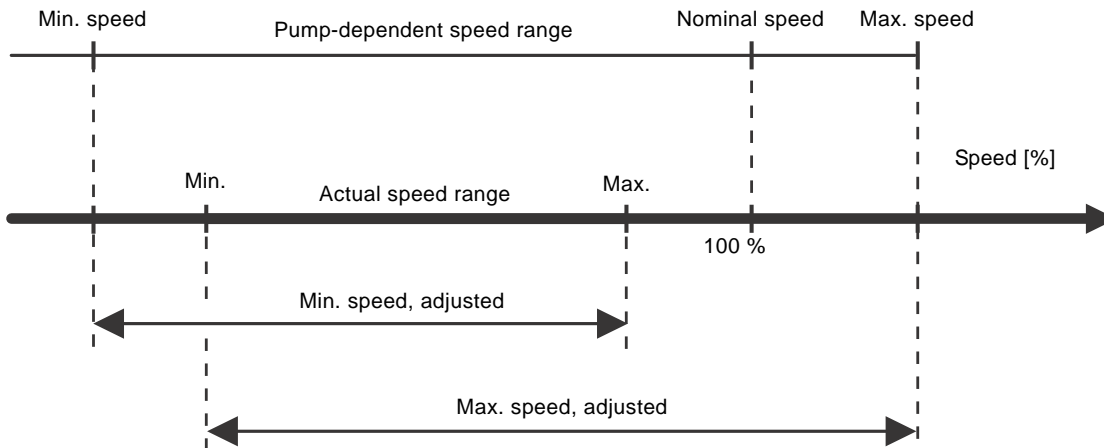

TM04 3581 4608

Fig. 42 Setting of the min. and max. curves in % of maximum performance

10.7.16 Motor bearing monitoring (3.19)



The motor bearing monitoring function can be set to these values:

- **Active**
- *Not active.*

When the function is set to *Active*, the CUE will give a warning when the motor bearings are due to be relubricated or replaced.

Description

The motor bearing monitoring function is used to give an indication when it is time to relubricate or replace the motor bearings. See display 2.10 and 2.11.

The warning indication and the estimated time take into account if the pump has been running with reduced speed. The bearing temperature is included in the calculation if temperature sensors are installed and connected to an MCB 114 sensor input module.

Note

The counter will continue counting even if the function is switched to Not active, but a warning will not be given when it is time for relubrication.

10.7.17 Confirming relubrication/replacement of motor bearings (3.20)



This function can be set to these values:

- *Relubricated*
- *Replaced*
- **Nothing done.**

When the motor bearings have been relubricated or replaced, confirm this action in the above display by pressing "OK".

Note

Relubricated cannot be selected for a period of time after confirming relubrication.

Relubricated

When the warning *Relubricate motor bearings* has been confirmed,

- the counter is set to 0.
- the number of relubrications is increased by 1.

When the number of relubrications has reached the permissible number, the warning *Replace motor bearings* appears in the display.

Replaced

When the warning *Replace motor bearings* has been confirmed,

- the counter is set to 0.
- the number of relubrications is set to 0.
- the number of bearing changes is increased by 1.

10.7.18 Temperature sensor 1 (3.21)



This display is only shown if an MCB 114 sensor input module has been installed.

Select the function of a Pt100/Pt1000 temperature sensor 1 connected to an MCB 114:

- *D-end bearing*
- *ND-end bearing*
- *Other liq. temp. 1*
- *Other liq. temp. 2*
- *Motor winding*
- *Pumped liq. temp.*
- *Ambient temp.*
- *Not active.*

10.7.19 Temperature sensor 2 (3.22)



This display is only shown if an MCB 114 sensor input module has been installed.

Select the function of a Pt100/Pt1000 temperature sensor 2 connected to an MCB 114:

- *D-end bearing*
- *ND-end bearing*
- *Other liq. temp. 1*
- *Other liq. temp. 2*
- *Motor winding*
- *Pumped liq. temp.*
- *Ambient temp.*
- *Not active.*

10.7.20 Standstill heating (3.23)



The standstill heating function can be set to these values:

- *Active*
- ***Not active.***

When the function is set to *Active* and the pump is stopped by a stop command, a current will be applied to the motor windings.

The standstill heating function pre-heats the motor to avoid condensation.

10.7.21 Ramps (3.24)

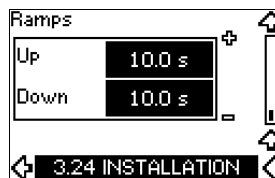

Set the time for each of the two ramps, ramp-up and ramp-down:

- Factory setting:
Depending on power size.
- The range of the ramp parameter:
1-3600 s.

The ramp-up time is the acceleration time from 0 rpm to the rated motor speed. Choose a ramp-up time such that the output current does not exceed the maximum current limit for the CUE.

The ramp-down time is the deceleration time from rated motor speed to 0 rpm. Choose a ramp-down time such that no overvoltage arises and such that the generated current does not exceed the maximum current limit for the CUE.

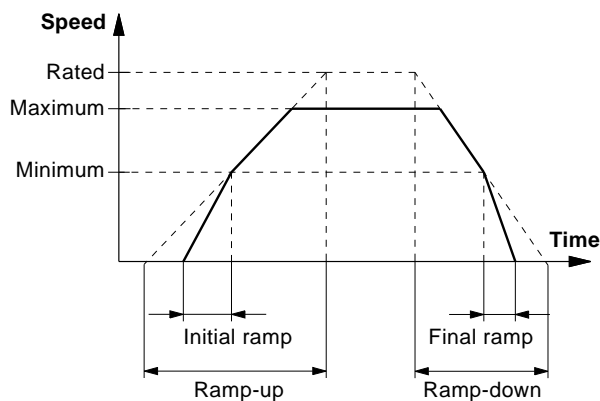

Fig. 43 Ramp-up and ramp-down, display 3.24

11. Setting by means of PC Tool E-products

Special setup requirements differing from the settings available via the CUE require the use of Grundfos PC Tool E-products. This again requires the assistance of a Grundfos service technician or engineer. Contact your local Grundfos company for more information.

12. Priority of settings



The On/Off button has the highest priority. In "off" condition, pump operation is not possible.

The CUE can be controlled in various ways at the same time. If two or more operating modes are active at the same time, the operating mode with the highest priority will be in force.

12.1 Control without bus signal, local operating mode

Priority	CUE menu	External signal
1	Stop	
2	Max.	
3		Stop
4		Max.
5	Min.	Min.
6	Normal	Normal

Example: If an external signal has activated the operating mode *Max.*, it will only be possible to stop the pump.

12.2 Control with bus signal, remote-controlled operating mode

Priority	CUE menu	External signal	Bus signal
1	Stop		
2	Max.		
3		Stop	Stop
4			Max.
5			Min.
6			Normal

Example: If the bus signal has activated the operating mode *Max.*, it will only be possible to stop the pump.

13. External control signals

13.1 Digital inputs

The overview shows functions in connection with closed contact.

Terminal	Type	Function
18	DI 1	<ul style="list-style-type: none"> Start/stop of pump Min. (min. curve) Max. (max. curve) Ext. fault (external fault)
19	DI 2	<ul style="list-style-type: none"> Flow switch Alarm reset Dry running (from external sensor) Not active.
32	DI 3	<ul style="list-style-type: none"> Min. (min. curve) Max. (max. curve) Ext. fault (external fault) Flow switch Alarm reset Dry running (from external sensor) Not active.

Terminal	Type	Function
33	DI 4	<ul style="list-style-type: none"> Min. (min. curve) Max. (max. curve) Ext. fault (external fault) Flow switch Alarm reset Dry running (from external sensor) Accumulated flow (pulse flow) Not active.

The same function must not be selected for more than one input. See fig. 17.

13.2 External setpoint

Terminal	Type	Function
53	AI 1	External setpoint (0-10 V)

The setpoint can be remote-set by connecting an analog signal transmitter to the setpoint input (terminal 53).

Open loop

In control mode *Open loop* (constant curve), the actual setpoint can be set externally within the range from the min. curve to the setpoint set via the CUE menu. See fig. 44.

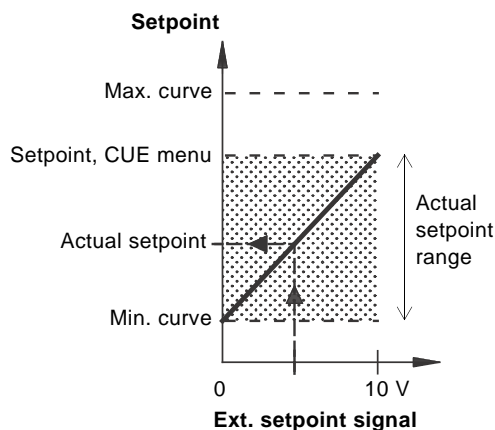
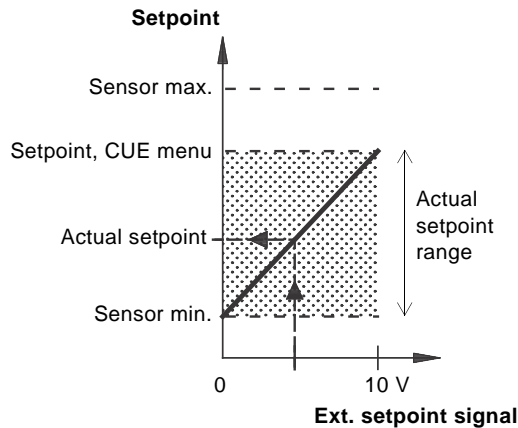

Fig. 44 Relation between the actual setpoint and the external setpoint signal in control mode *Open loop*

TM03 8856 2607

Closed loop

In all other control modes, except proportional differential pressure, the actual setpoint can be set externally within the range from the lower value of the sensor measuring range (sensor min.) to the setpoint set via the CUE menu. See fig. 45.



TM03 8856 2607

Fig. 45 Relation between the actual setpoint and the external setpoint signal in control mode Controlled

Example: At a sensor min. value of 0 bar, a setpoint set via the CUE menu of 3 bar and an external setpoint of 80 %, the actual setpoint will be as follows:

$$\begin{aligned} \text{Actual setpoint} &= (\text{setpoint set via the CUE menu} - \text{sensor min.}) \\ &\quad \times \% \text{ external setpoint signal} + \text{sensor min.} \\ &= (3 - 0) \times 80 \% + 0 \\ &= 2.4 \text{ bar.} \end{aligned}$$

Proportional differential pressure

In control mode *Proportional differential pressure*, the actual setpoint can be set externally within the range from 25 % of maximum head to the setpoint set via the CUE menu. See fig. 46.

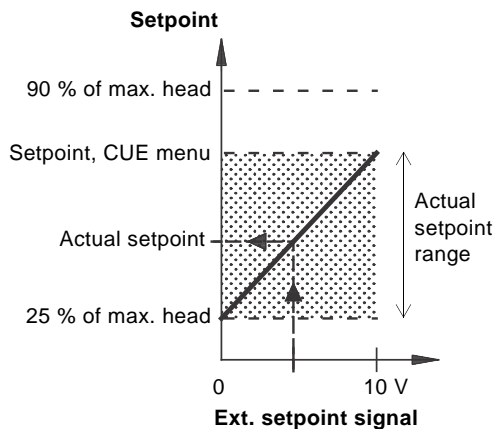

TM03 8856 2607

Fig. 46 Relation between the actual setpoint and the external setpoint signal in control mode Proportional differential pressure

Example: At a maximum head of 12 metres, a setpoint of 6 metres set via the CUE menu and an external setpoint of 40 %, the actual setpoint will be as follows:

$$\begin{aligned} &(\text{setpoint, CUE menu} - 25 \% \text{ of maximum head}) \\ \text{Actual setpoint} &= \text{head) } \times \% \text{ external setpoint signal} + 25 \% \text{ of} \\ &\quad \text{maximum head} \\ &= (6 - 12 \times 25 \%) \times 40 \% + 12/4 \\ &= 4.2 \text{ m.} \end{aligned}$$

13.3 GENibus signal

The CUE supports serial communication via an RS-485 input. The communication is carried out according to the Grundfos GENibus protocol and enables connection to a building management system or another external control system.

Operating parameters, such as setpoint and operating mode can be remote-set via the bus signal. At the same time, the pump can provide status information about important parameters, such as actual value of control parameter, input power and fault indications.

Contact Grundfos for further details.

Note *If a bus signal is used, the number of settings available via the CUE will be reduced.*

13.4 Other bus standards

Grundfos offers various bus solutions with communication according to other standards.

Contact Grundfos for further details.

14. Maintenance and service

14.1 Cleaning the CUE

Keep the cooling fins and fan blades clean to ensure sufficient cooling of the CUE.

14.2 Service parts and service kits

For further information on service parts and service kits, visit www.grundfos.com > International website > WebCAPS.

15. Troubleshooting

15.1 Warning and alarm list

Code and display text	Status			Operat- ing mode	Reset- ting
	Warning	Alarm	Locked alarm		
1 Too high leakage current			●	Stop	Man.
2 Mains phase failure		●		Stop	Aut.
3 External fault		●		Stop	Man.
16 Other fault		●		Stop	Aut.
30 Replace motor bearings	●			–	Man. ³⁾
32 Overvoltage	●	●		Stop	Aut.
40 Undervoltage	●			–	Aut.
48 Overload		●		Stop	Aut.
49 Overload		●	●	Stop	Man.
55 Overload	●			–	Aut.
57 Dry running		●		Stop	Aut.
64 Too high CUE temperature		●		Stop	Aut.
70 Too high motor temperature		●		Stop	Aut.
77 Communication fault, duty/standby	●			–	Aut.
89 Sensor 1 outside range		●		1)	Aut.
91 Temperature sensor 1 outside range	●			–	Aut.
93 Sensor 2 outside range	●			–	Aut.
96 Setpoint signal outside range		●		1)	Aut.
148 Too high bearing temperature	●			–	Aut.
149 Too high bearing temperature	●	●		Stop	Aut.
155 Inrush fault		●		Stop	Aut.
175 Temperature sensor 2 outside range	●			–	Aut.
240 Relubricate motor bearings	●			–	Man. ³⁾
241 Motor phase failure	●	●		Stop	Aut.
242 AMA ²⁾ did not succeed	●			–	Man.

¹⁾ In case of an alarm, the CUE will change the operating mode depending on the pump type.

²⁾ AMA, Automatic Motor Adaptation. Not active in the present software.

³⁾ Warning is reset in display 3.20.

15.2 Resetting of alarms

In case of fault or malfunction of the CUE, check the alarm list in menu OPERATION. The latest five alarms and latest five warnings can be found in the log menus.

Contact a Grundfos technician if an alarm occurs repeatedly.

15.2.1 Warning

The CUE will continue the operation as long as the warning is active. The warning remains active until the cause no longer exists. Some warnings may switch to alarm condition.

15.2.2 Alarm

In case of an alarm, the CUE will stop the pump or change the operating mode depending on the alarm type and pump type. See section 15.1 *Warning and alarm list*.

Pump operation will be resumed when the cause of the alarm has been remedied and the alarm has been reset.

Resetting an alarm manually

- Press OK in the alarm display.
- Press On/Off twice.
- Activate a digital input DI 2-DI 4 set to *Alarm reset* or the digital input DI 1 (*Start/stop*).

If it is not possible to reset an alarm, the reason may be that the fault has not been remedied, or that the alarm has been locked.

15.2.3 Locked alarm

In case of a locked alarm, the CUE will stop the pump and become locked. Pump operation cannot be resumed until the cause of the locked alarm has been remedied and the alarm has been reset.

Resetting a locked alarm

- Switch off the power supply to the CUE for approx. 30 seconds. Switch on the power supply, and press OK in the alarm display to reset the alarm.

15.3 Indicator lights

The table show the function of the indicator lights.

Indicator light	Function
On (green)	The pump is running or has been stopped by a stop function. If flashing, the pump has been stopped by the user (CUE menu), external start/stop or bus.
Off (orange)	The pump has been stopped with the On/Off button.
Alarm (red)	Indicates an alarm or a warning.

15.4 Signal relays

The table show the function of the signal relays.

Type	Function
Relay 1	<ul style="list-style-type: none"> • Ready • Alarm • Operation <ul style="list-style-type: none"> • Pump running • Warning • Relubricate.
Relay 2	<ul style="list-style-type: none"> • Ready • Alarm • Operation <ul style="list-style-type: none"> • Pump running • Warning • Relubricate.

See also fig. 24.

16. Technical data

16.1 Enclosure

The individual CUE cabinet sizes are characterised by their enclosures. The table shows the relationship of enclosure class and enclosure type.

Example:

Read from the nameplate:

- Supply voltage = 3 x 380-500 V.
- Typical shaft power = 110 kW.
- Enclosure class = IP21.

The table shows that the CUE enclosure is D1.

Typical shaft power P2		Enclosure class and type			
		3 x 380-500 V		3 x 525-690 V	
[kW]	[HP]	IP21 NEMA1	IP54 NEMA12	IP21 NEMA1	IP54 NEMA12
110	150	D1	D1	D1	D1
132	200				
160	250	D2	D2	D2	D2
200	300				
250	350				

16.2 Main dimensions and weight

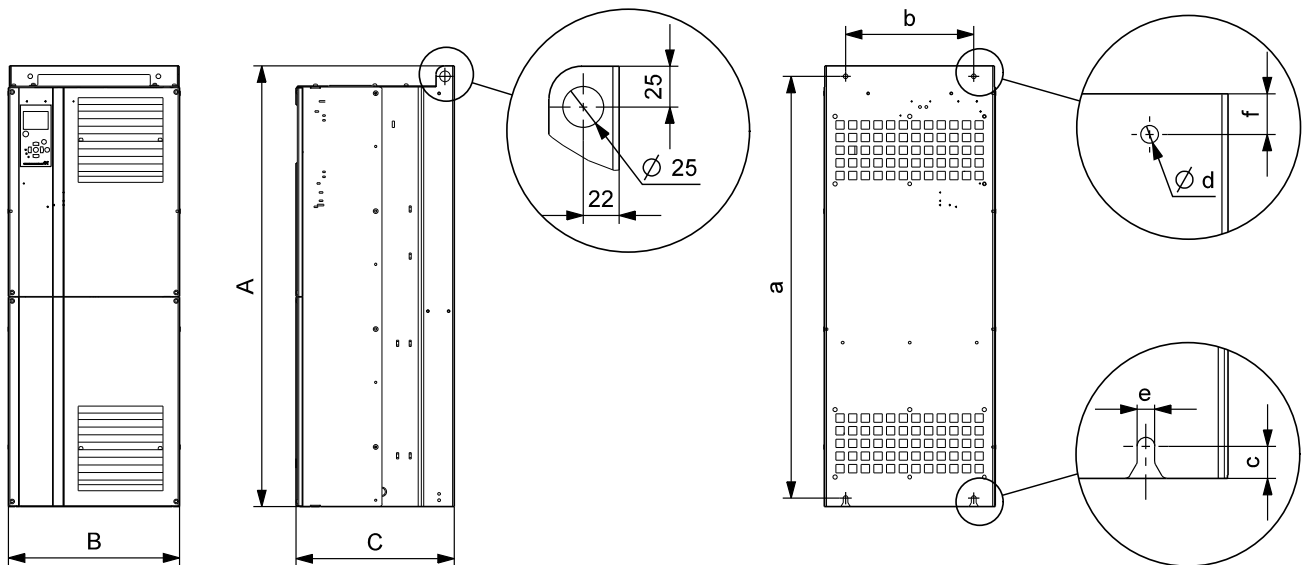

Fig. 47 Enclosures D1 and D2

Enclosure	Height [in] ¹⁾		Width [in] ¹⁾		Depth [in] ¹⁾	Screw holes [in]				Weight [lb]
	A	a	B	b	C	c	Ød	Øe	f	
D1	47.6	45.4	16.5	12.0	15.0	0.79	0.43	0.43	0.98	229
D2	62.6	60.4	16.5	12.0	15.0	0.79	0.43	0.43	0.98	333
Shipping dimensions										
D1	25.6	–	68.1	–	22.4	–	–	–	–	–
D2	25.6	–	68.1	–	22.4	–	–	–	–	–

¹⁾ The dimensions are maximum height, width and depth. Dimensions are without options.

TM03 9922 4607

16.3 Surroundings

Relative humidity	5-95 % RH
Ambient temperature	Max. 113 °F
Average ambient temperature over 24 hours	Max. 104 °F
Minimum ambient temperature at full operation	32 °F
Minimum ambient temperature at reduced operation	14 °F
Temperature during storage and transportation	-13 to 149 °F
Storage duration	Max. 6 months
Maximum altitude above sea level without performance reduction	3280 ft
Maximum altitude above sea level with performance reduction	9840 ft

Note The CUE comes in a packaging which is not suitable for outdoor storage.

16.4 Terminal tightening torques

Screws M10	14 lb-ft
Screws M8	7 lb-ft

16.5 Cable length

Maximum length, screened motor cable	500 ft
Maximum length, unscreened motor cable	1000 ft
Maximum length, signal cable	1000 ft

16.6 Fuses and cable gauge size



Warning
Always comply with national and local regulations as to cable gauge sizes.

16.6.1 Cable gauge size to signal terminals

Maximum cable gauge size to signal terminals, rigid conductor	14 AWG
Maximum cable gauge size to signal terminals, flexible conductor	18 AWG
Minimum cable gauge size to signal terminals	20 AWG

16.6.2 Non-UL fuses and conductor cross-section (gauge size) to mains and motor

Typical shaft power P2	Maximum fuse size	Fuse type	Maximum conductor cross-section ¹⁾
[kW]	[A]		[mm ²]
3 x 380-500 V			
110	300	gG	2 x 70
132	350	gG	2 x 70
160	400	gG	2 x 185
200	500	gG	2 x 185
250	600	gR	2 x 185
3 x 525-690 V			
110	225	-	2 x 70
132	250	-	2 x 70
160	350	-	2 x 185
200	400	-	2 x 185
250	500	-	2 x 185

¹⁾ Screened motor cable, unscreened supply cable. AWG, see section 16.6.3.

16.6.3 UL fuses and conductor cross-section (gauge size) to mains and motor

Typical shaft power P2	Fuse type							Maximum conductor cross-section ¹⁾
	Bussmann E1958 JFHR2	Bussmann E4273 T/JDDZ	Bussmann E4274 H/JDDZ	Bussmann E125085 JFHR2	SIBA E180276 RKI/JDDZ	Littel Fuse E71611 JFHR2	Ferraz-Shawmut E60314 JFHR2	
[kW]								[AWG] ²⁾
3 x 380-500 V								
110	FWH-300	JJS-300	NOS-300	170M3017	2028220-315	L50S-300	A50-P300	2 x 2/0
132	FWH-350	JJS-350	NOS-350	170M3018	2028220-315	L50S-350	A50-P350	2 x 2/0
160	FWH-400	JJS-400	NOS-400	170M4012	206xx32-400	L50S-400	A50-P400	2 x 350 MCM
200	FWH-500	JJS-500	NOS-500	170M4014	206xx32-500	L50S-500	A50-P500	2 x 350 MCM
250	FWH-600	JJS-600	NOS-600	170M4016	206xx32-600	L50S-600	A50-P600	2 x 350 MCM
-	-	-	-	Bussmann E125085 JFHR2	SIBA E180276 JFHR2	-	Ferraz-Shawmut E76491 JFHR2	-
3 x 525-690 V								
110	-	-	-	170M3017	2061032.315	-	6.6URD30D08A0315	2 x 2/0
132	-	-	-	170M3018	2061032.350	-	6.6URD30D08A0350	2 x 2/0
160	-	-	-	170M4011	2061032.350	-	6.6URD30D08A0350	2 x 2/0
200	-	-	-	170M4012	2061032.400	-	6.6URD30D08A0400	2 x 350 MCM
250	-	-	-	170M4014	2061032.500	-	6.6URD30D08A0500	2 x 350 MCM

¹⁾ Screened motor cable, unscreened supply cable.

²⁾ American Wire Gauge.

16.7 Inputs and outputs

16.7.1 Mains supply (L1, L2, L3)

Supply voltage	380-500 V \pm 10 %
Supply voltage	525-690 V \pm 10 %
Supply frequency	50/60 Hz
Maximum temporary imbalance between phases	3 % of rated value
Leakage current to ground	> 3.5 mA
Number of cut-ins, enclosure D	Max. 1 time/2 min.

Note Do not use the power supply for switching the CUE on and off.

16.7.2 Motor output (U, V, W)

Output voltage	0-100 % ¹⁾
Output frequency	0-100 Hz ²⁾
Switching on output	Not recommended

¹⁾ Output voltage in % of supply voltage.

²⁾ Depending on the pump family selected.

16.7.3 RS-485 GENiBus connection

Terminal number	68 (A), 69 (B), 61 GND (Y)
-----------------	----------------------------

The RS-485 circuit is functionally separated from other central circuits and galvanically separated from the supply voltage (PELV).

16.7.4 Digital inputs

Terminal number	18, 19, 32, 33
Voltage level	0-24 VDC
Voltage level, open contact	> 19 VDC
Voltage level, closed contact	< 14 VDC
Maximum voltage on input	28 VDC
Input resistance, R _i	Approx. 4 k Ω

All digital inputs are galvanically separated from the supply voltage (PELV) and other high-voltage terminals.

16.7.5 Signal relays

Relay 01 , terminal number	1 (C), 2 (NO), 3 (NC)
Relay 02 , terminal number	4 (C), 5 (NO), 6 (NC)
Maximum terminal load (AC-1) ¹⁾	240 VAC, 2 A
Maximum terminal load (AC-15) ¹⁾	240 VAC, 0.2 A
Maximum terminal load (DC-1) ¹⁾	50 VDC, 1 A
Minimum terminal load	24 V DC 10 mA 24 V AC 20 mA

¹⁾ IEC 60947, parts 4 and 5.

C = Common

NO = Normally open

NC = Normally closed

The relay contacts are galvanically separated from other circuits by reinforced insulation (PELV).

16.7.6 Analog inputs

Analog input 1 , terminal number	53
Voltage signal	A53 = "U" ¹⁾
Voltage range	0-10 V
Input resistance, R _i	Approx. 10 k Ω
Maximum voltage	\pm 20 V
Current signal	A53 = "I" ¹⁾
Current range	0-20, 4-20 mA
Input resistance, R _i	Approx. 200 Ω
Maximum current	30 mA
Maximum fault, terminals 53, 54	0.5 % of full scale
Analog input 2 , terminal number	54
Current signal	A54 = "I" ¹⁾
Current range	0-20, 4-20 mA
Input resistance, R _i	Approx. 200 Ω
Maximum current	30 mA
Maximum fault, terminals 53, 54	0.5 % of full scale

¹⁾ The factory setting is voltage signal "U".

All analog inputs are galvanically separated from the supply voltage (PELV) and other high-voltage terminals.

16.7.7 Analog output

Analog output 1 , terminal number	42
Current range	0-20 mA
Maximum load to ground	500 Ω
Maximum fault	0.8 % of full scale

The analog output is galvanically separated from the supply voltage (PELV) and other high-voltage terminals.

16.7.8 MCB 114 sensor input module

Analog input 3 , terminal number	2
Current range	0/4-20 mA
Input resistance	< 200 Ω
Analog inputs 4 and 5 , terminal number	4, 5 and 7, 8
Signal type, 2- or 3-wire	Pt100/Pt1000

Note When using Pt100 with 3-wire cable, the resistance must not exceed 30 Ω .

16.8 Sound pressure level

Enclosure D1	Maximum 76 dB(A)
Enclosure D2	Maximum 74 dB(A)

The sound pressure of the CUE is measured at a distance of 1 m from the unit.

The sound pressure level of a motor controlled by a variable frequency drive may be higher than that of a corresponding motor which is not controlled by a variable frequency drive. See section 6.7 RFI filters.

17. Disposal

This product or parts of it must be disposed of in an environmentally sound way:

1. Use the public or private waste collection service.
2. If this is not possible, contact the nearest Grundfos company or service workshop.

Subject to alterations.

U.S.A.

GRUNDFOS Pumps Corporation
17100 West 118th Terrace
Olathe, Kansas 66061
Phone: +1-913-227-3400
Telefax: +1-913-227-3500

Canada

GRUNDFOS Canada Inc.
2941 Brighton Road
Oakville, Ontario
L6H 6C9
Phone: +1-905 829 9533
Telefax: +1-905 829 9512

México

Bombas GRUNDFOS de México S.A. de C.V.
Boulevard TLC No. 15
Parque Industrial Stiva
Aeropuerto
Apodaca, N.L.C.P. 66600
Phone: +52-81-8144 4000
Telefax: +52-81-8144 4010

96806767 1009	172
Repl. 96806767 1008	