



SMART Digital S DDA/DDC

DDA ≤ 30 l/h (8 gph)

DDC ≤ 15 l/h (4 gph)

Installation and
operating instructions DDA



net.grundfos.com/qr/i/95724708

Installation and
operating instructions DDC



net.grundfos.com/qr/i/95726994

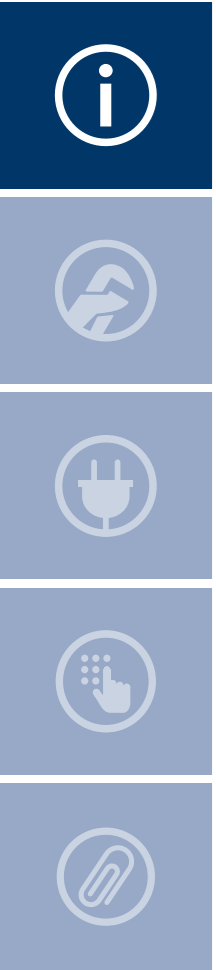

i

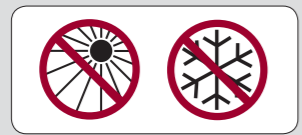
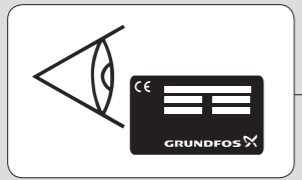
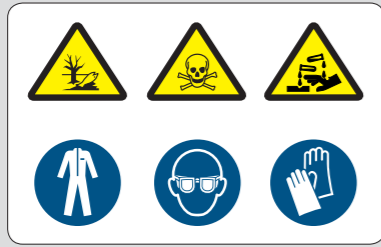

Min./Max.
-10 °C / +45 °C
14 °F / 113 °F

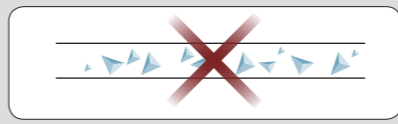

Min./Max.
0 °C / +45 °C
32 °F / 113 °F

≤ 60 dB(A)

IP 65
(Nema 4x)



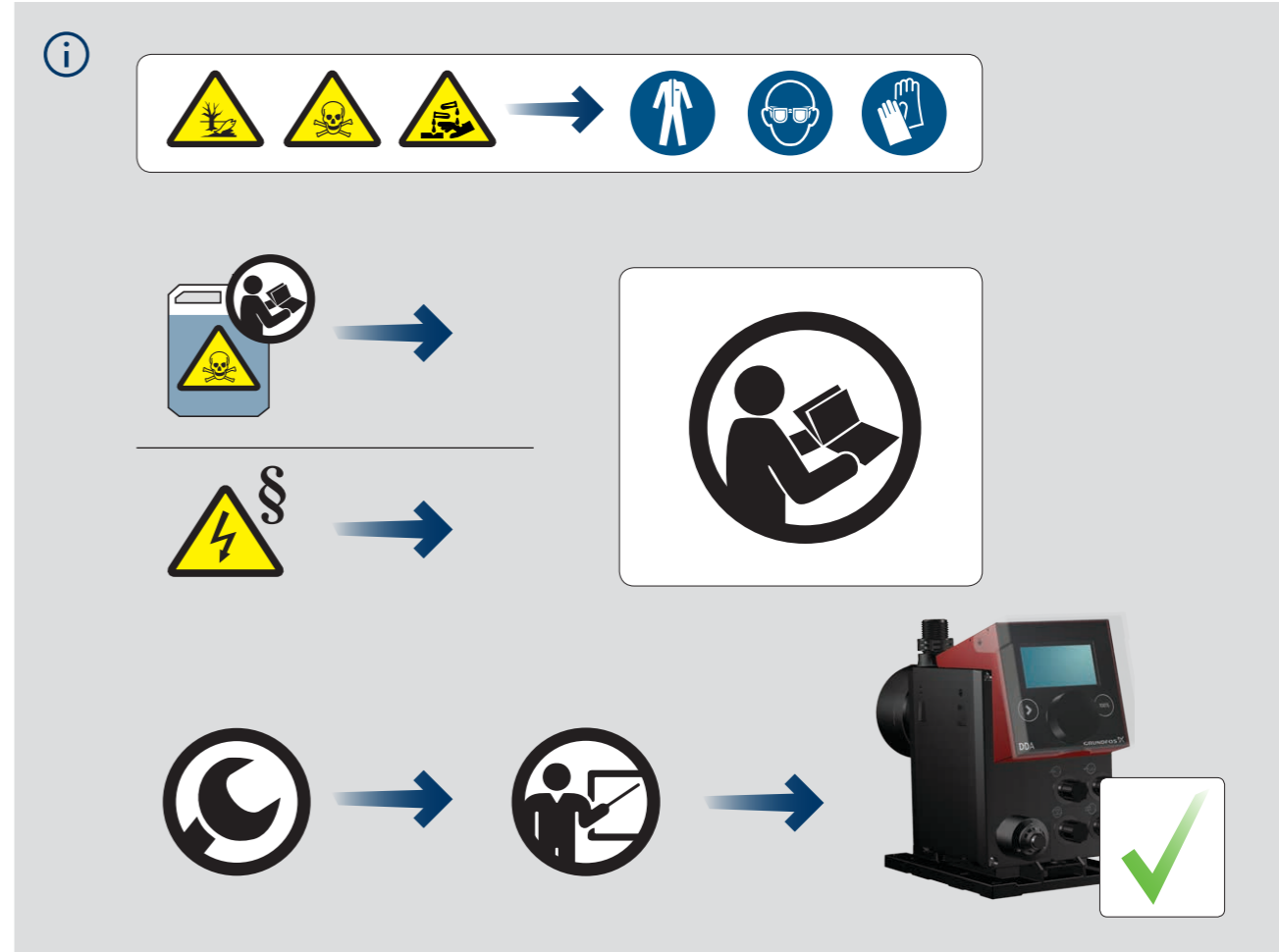
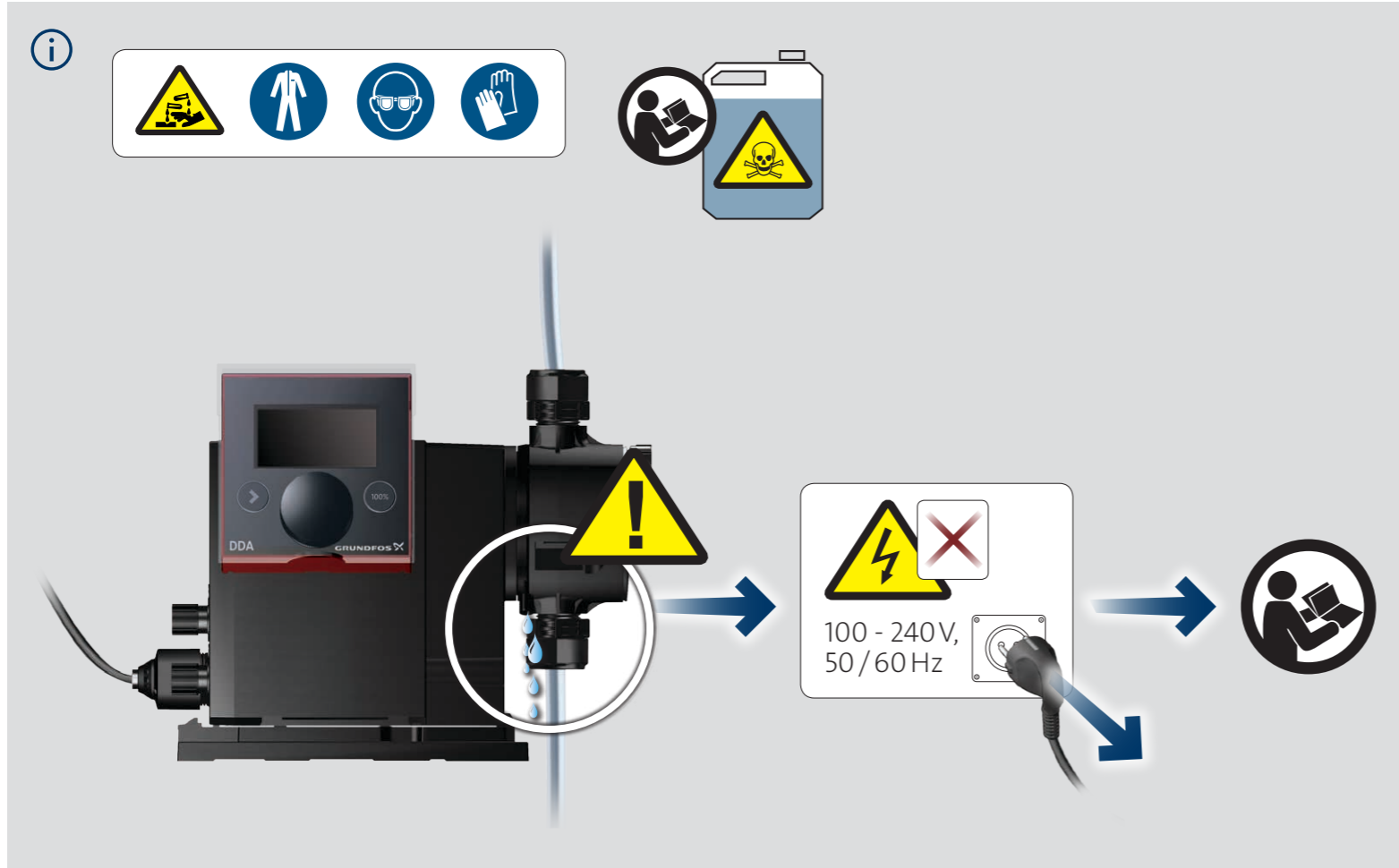
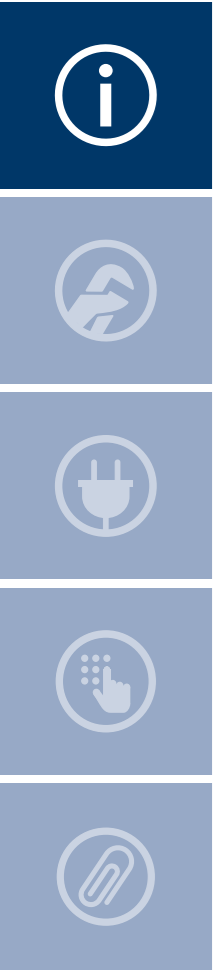

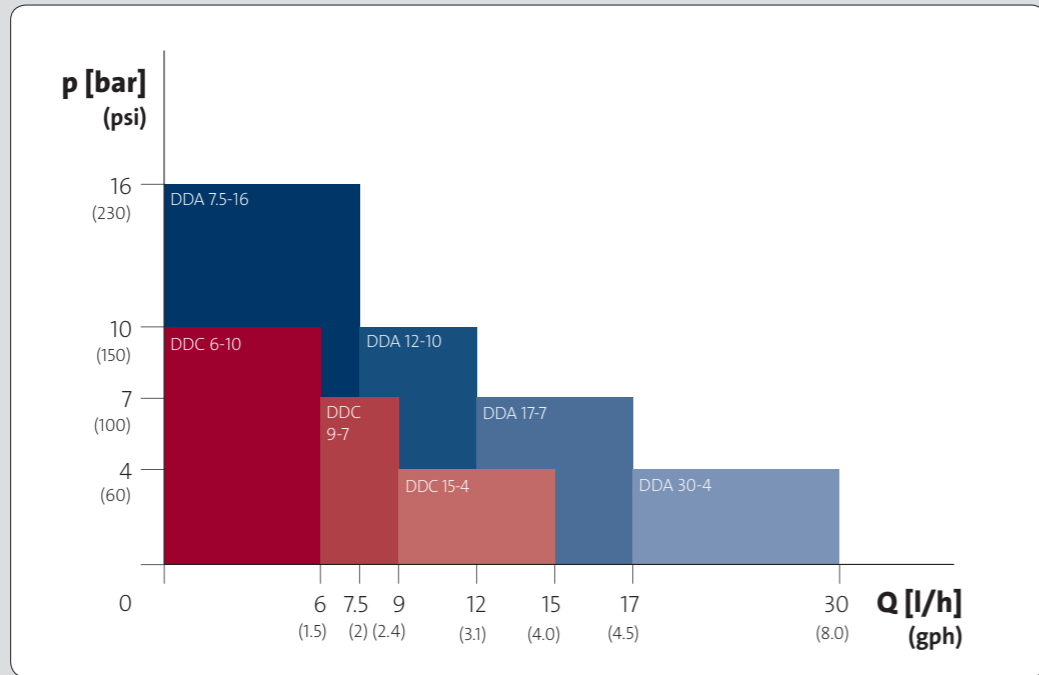



$p_2 - p_1 \geq 1 \text{ bar (15 psi)}$

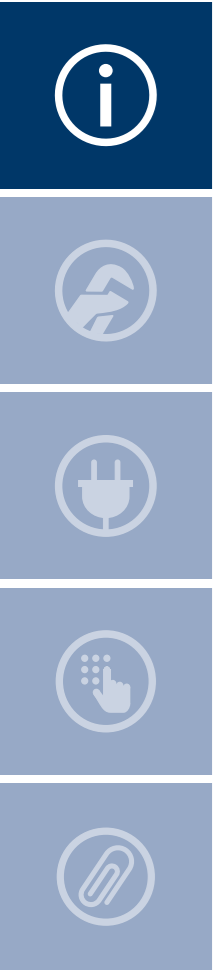



i

100 - 240V,
50/60 Hz





Max.
1.5 m/59"

Min.
100 mm/4"



Min.
100 mm/4"

Max.
4 kg/8.8 lb



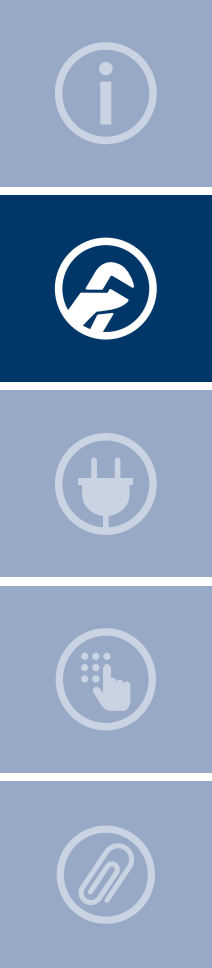

1

TORX PLUS (15 IP)



2

STOP

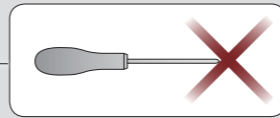

3



4

TORX PLUS (15 IP)

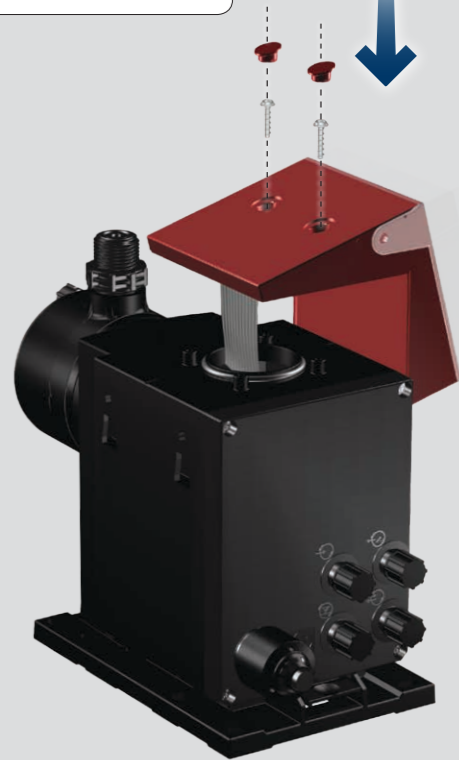

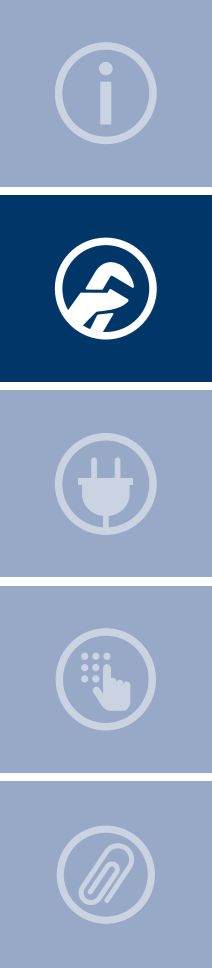

5



6a

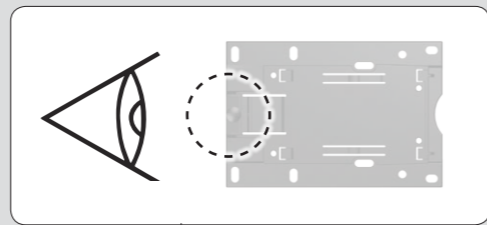

7a



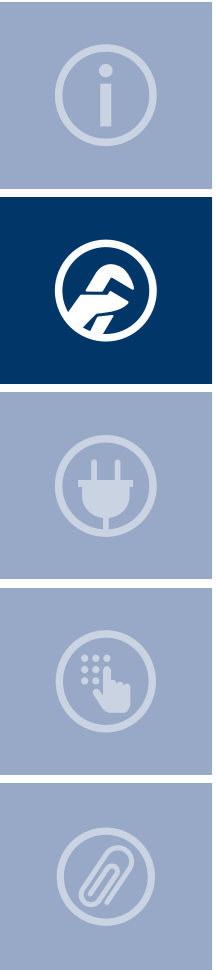

6b

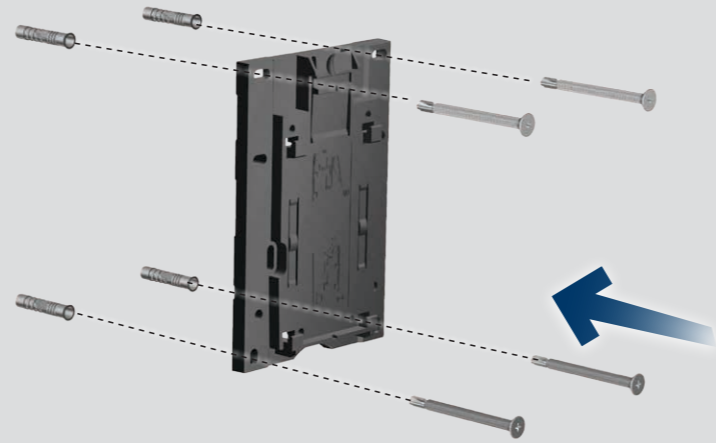
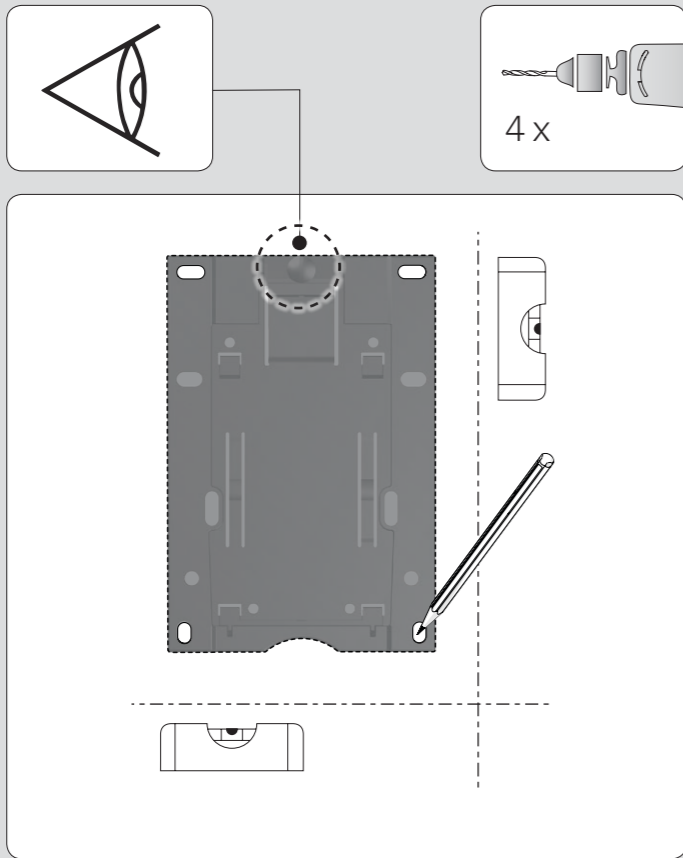

Ø 5 mm (0.2")

7b

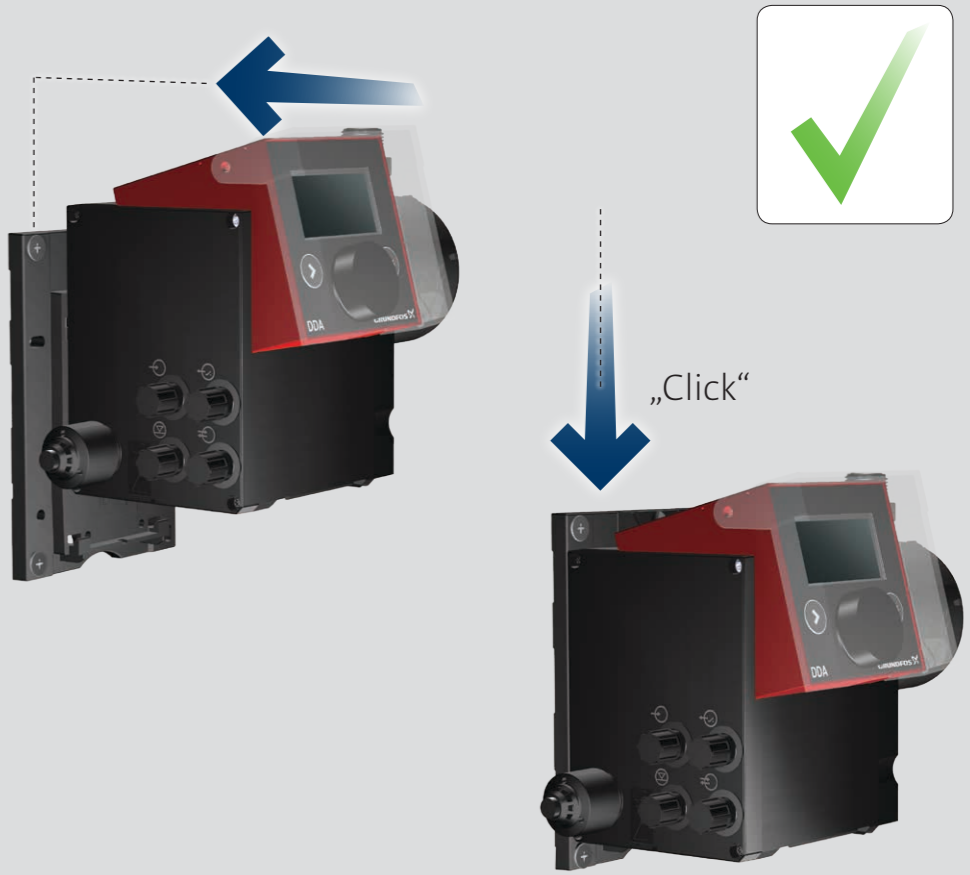



8

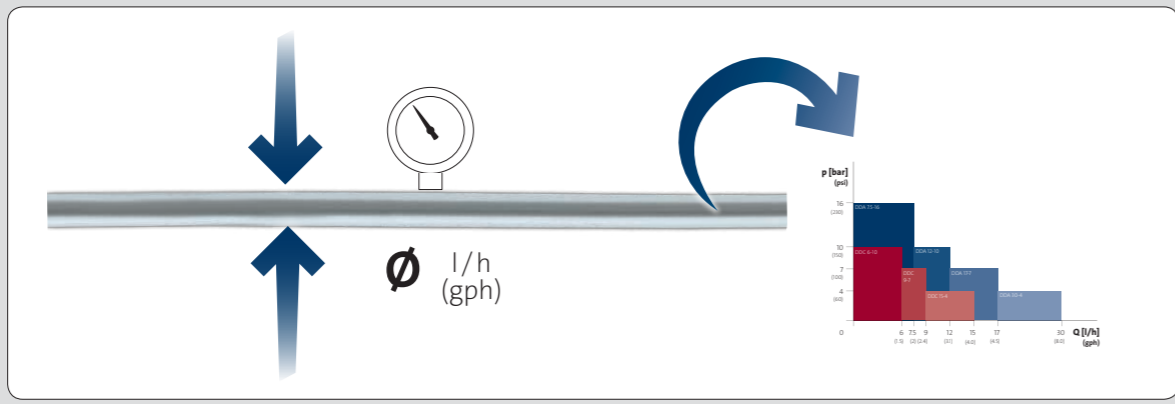
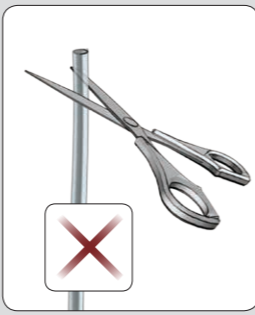

9

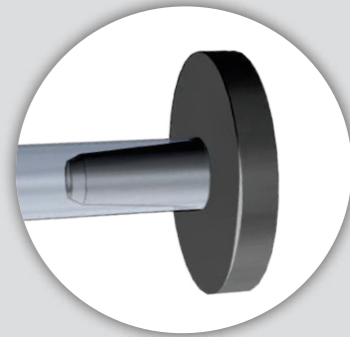
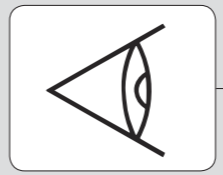

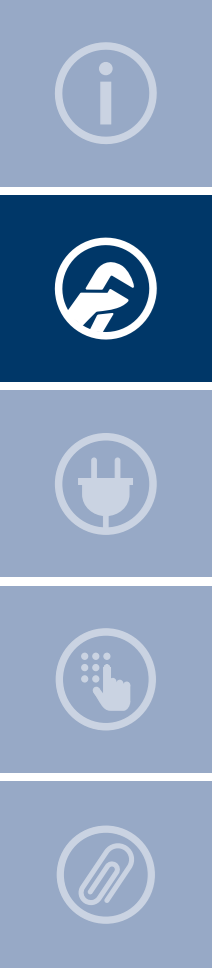

10

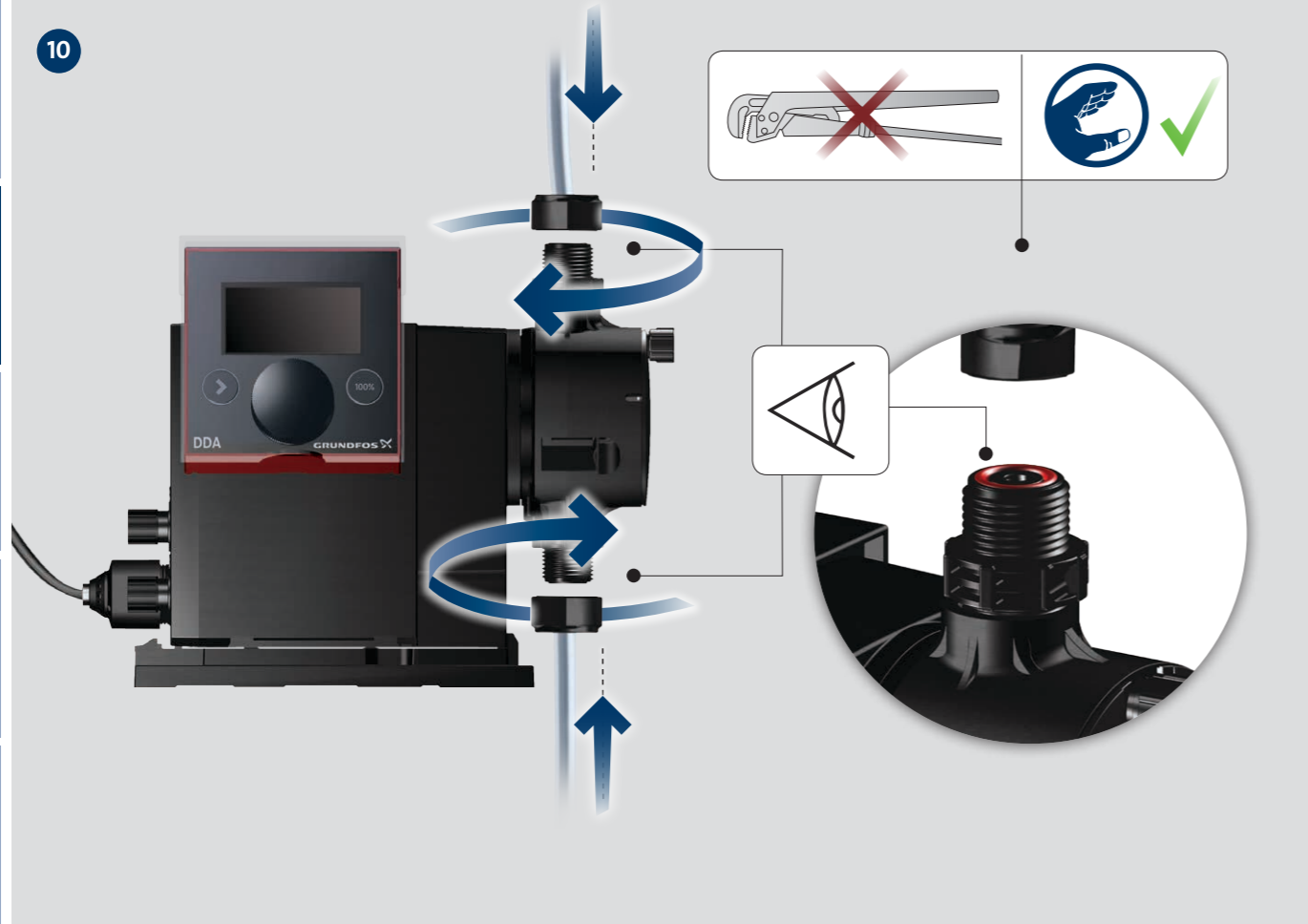

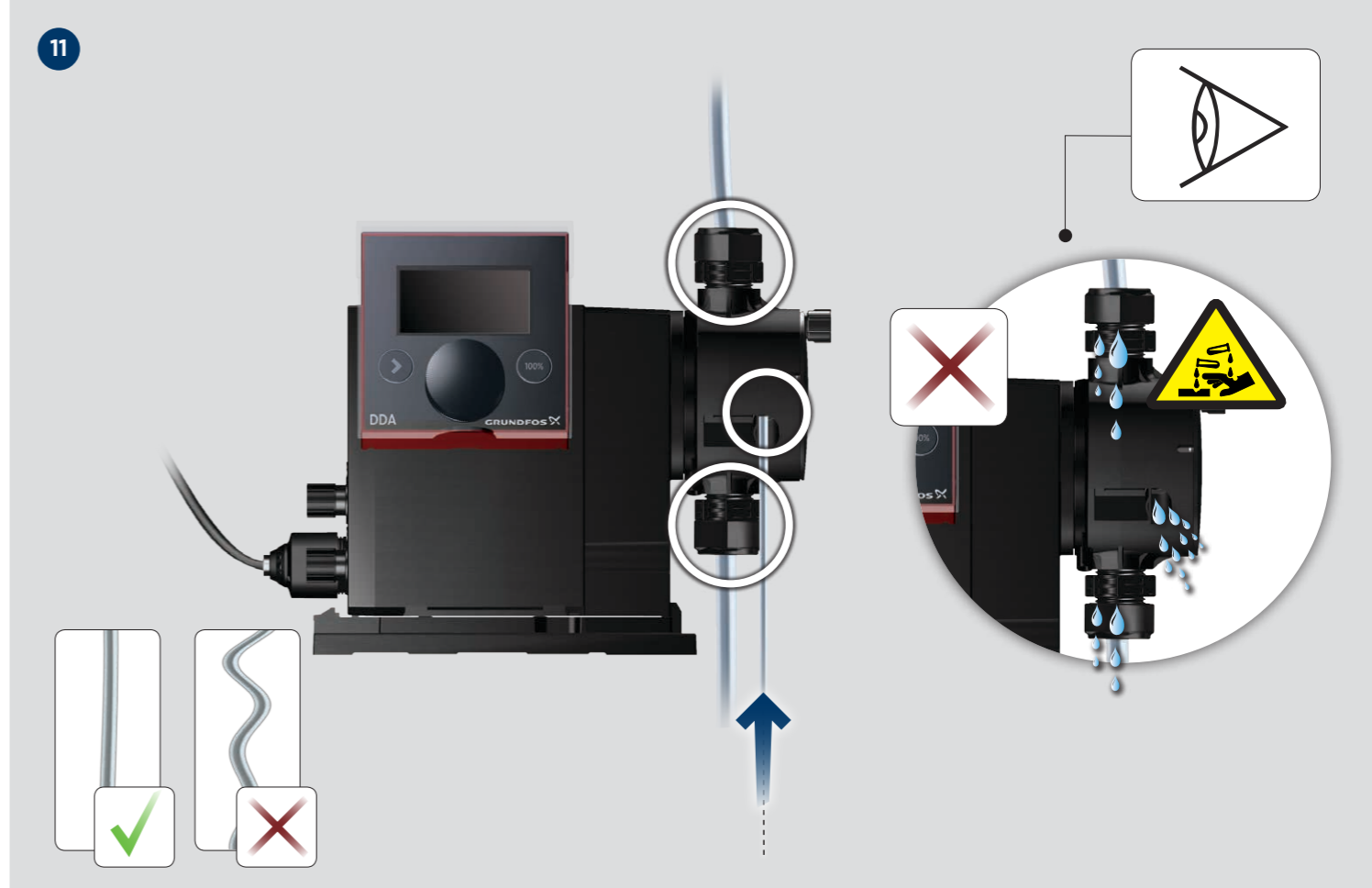

11





12

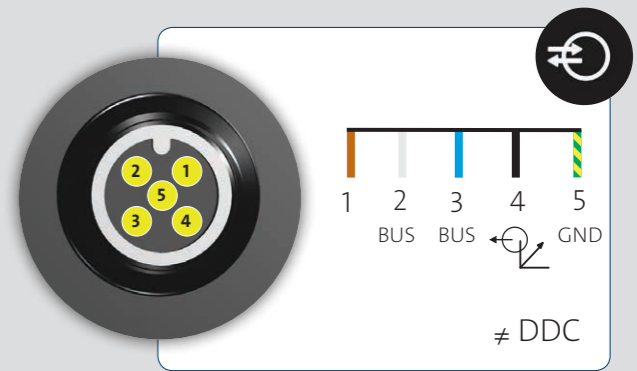
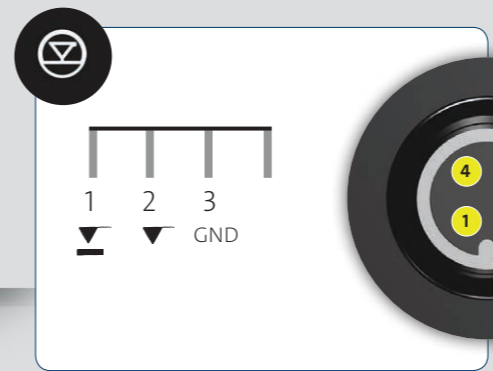
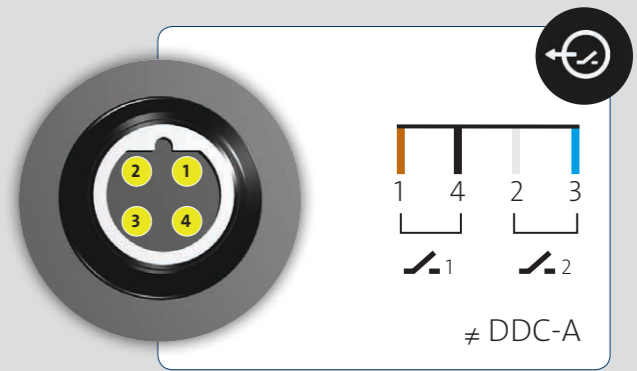

100 - 240V,
50/60Hz



13

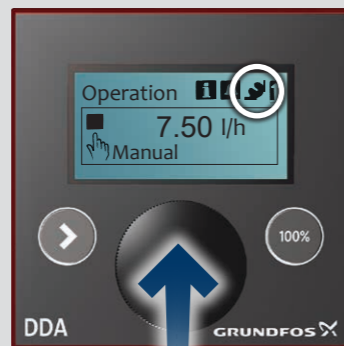
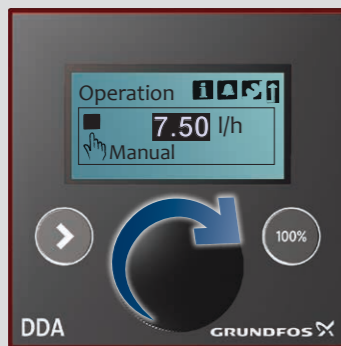

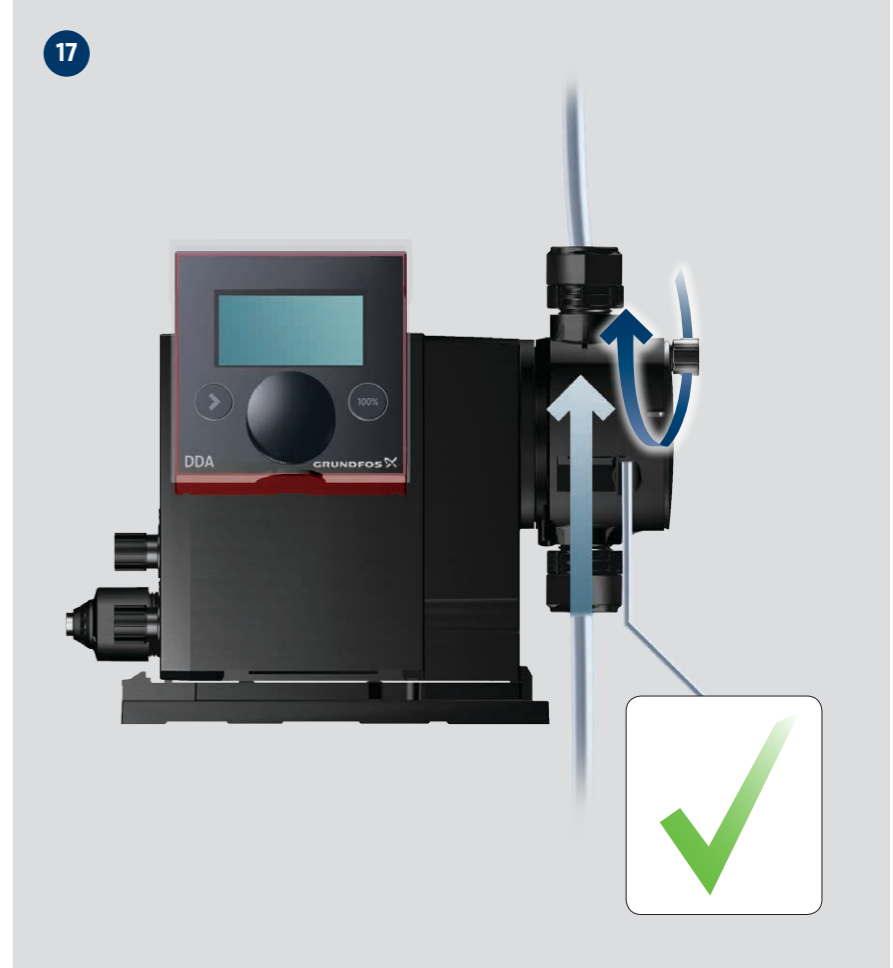
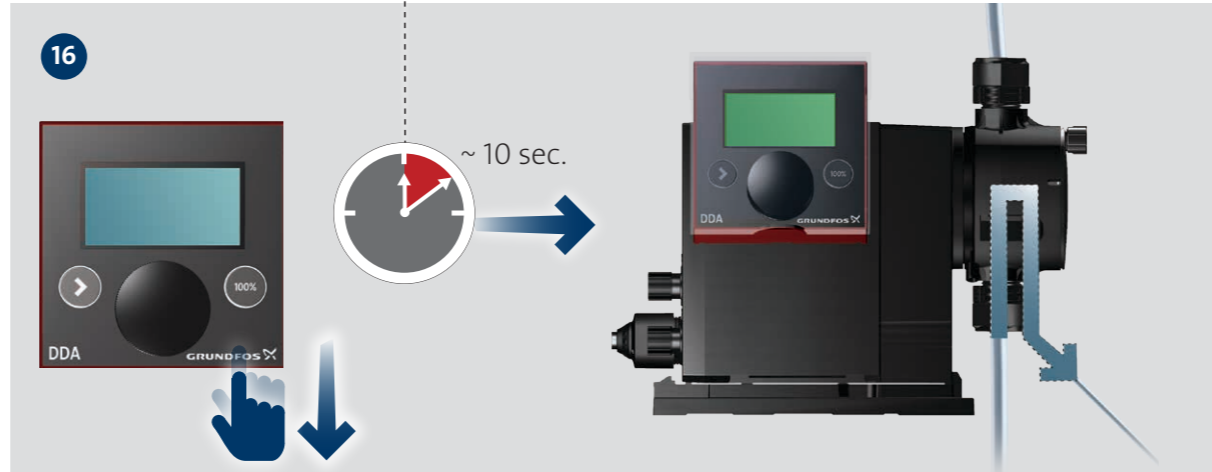
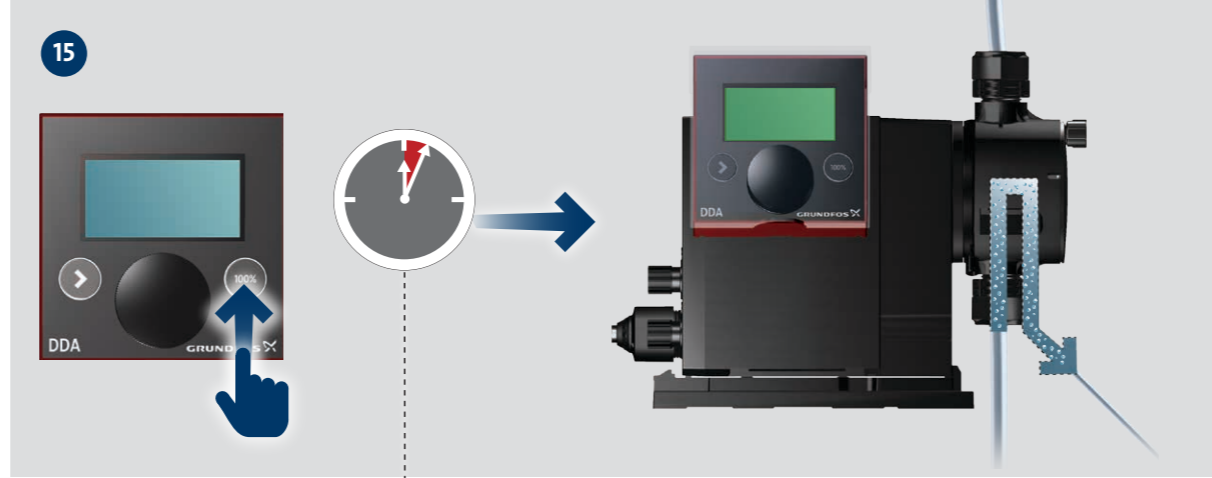
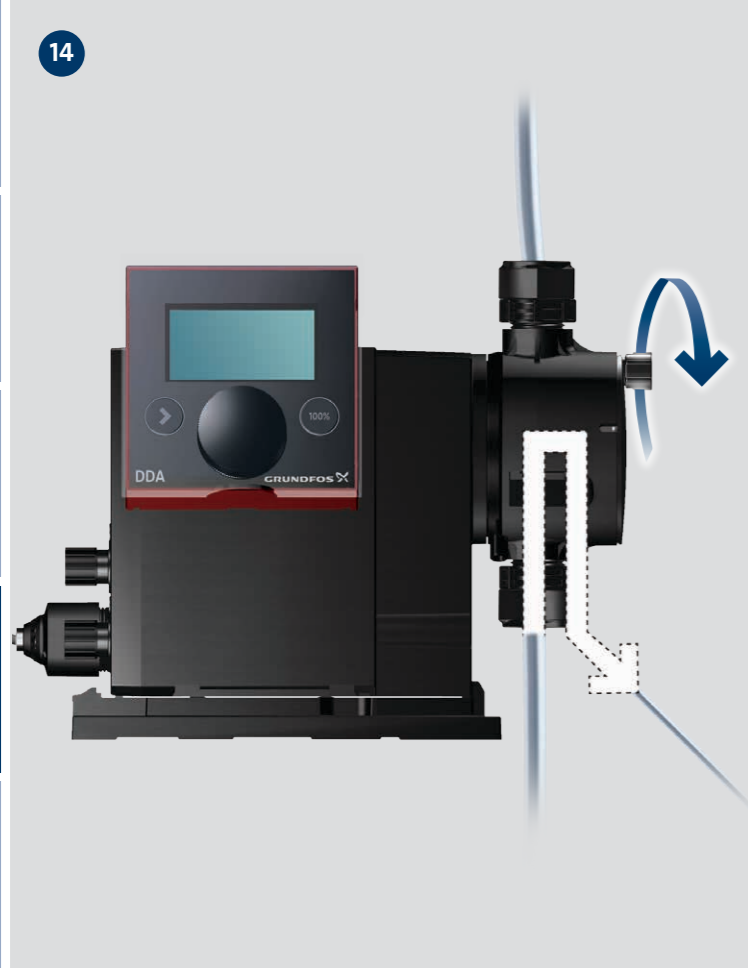
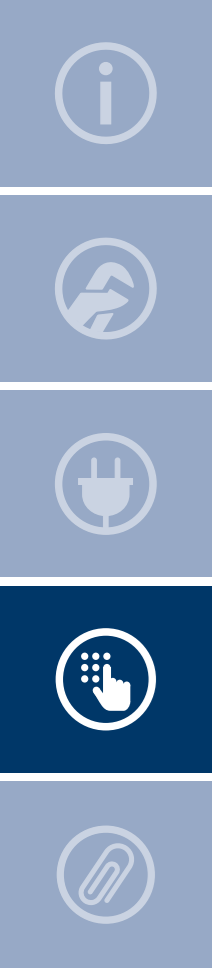



V1 e.g. 300 ml



V2 e.g. 190 ml



V1 - V2
 e.g. 300 - 190 ml = 110 ml

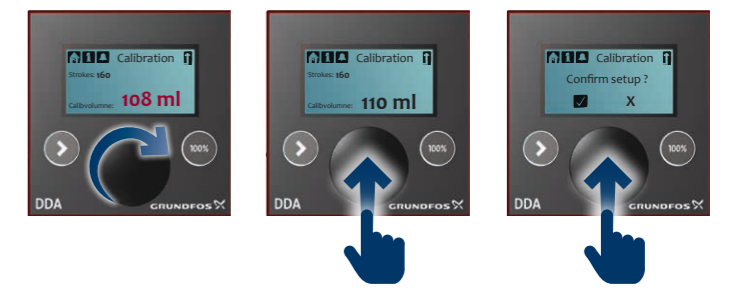

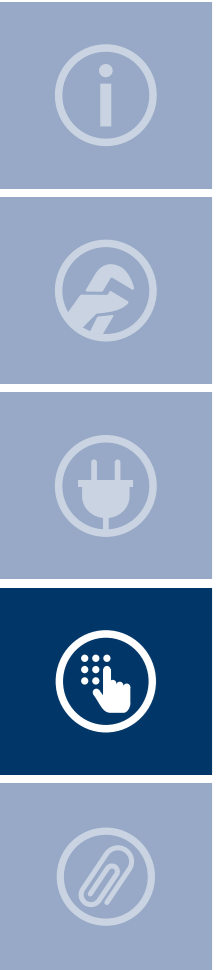

19

Ok



Ok



Warning

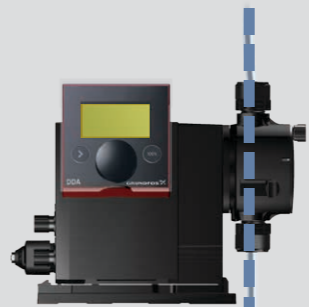

Alarm



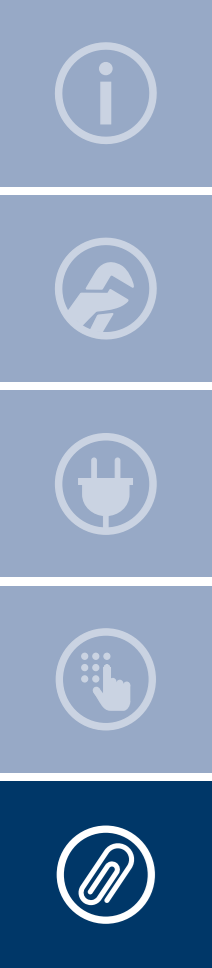

1



2

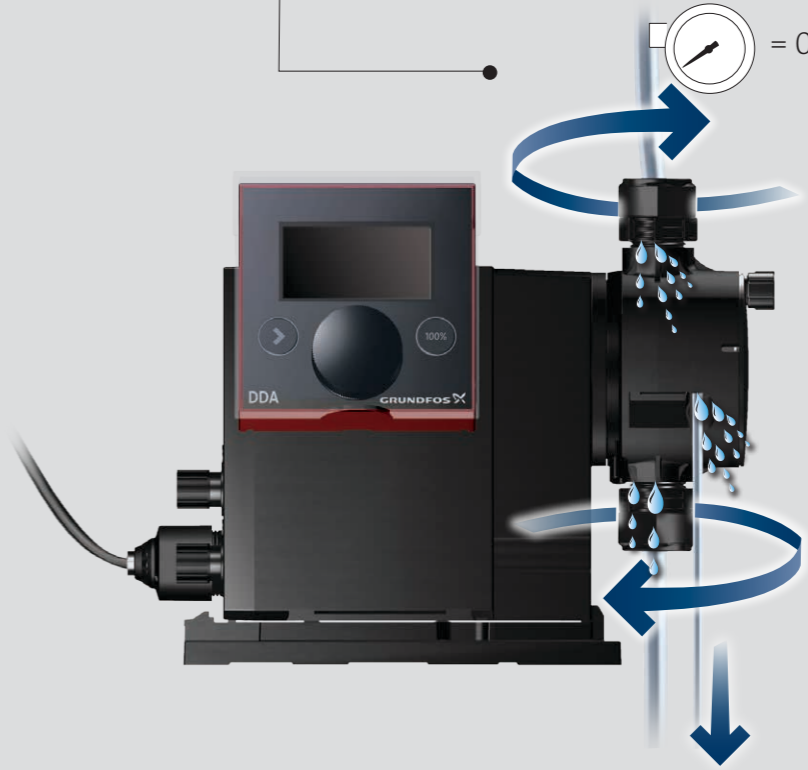
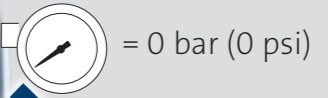

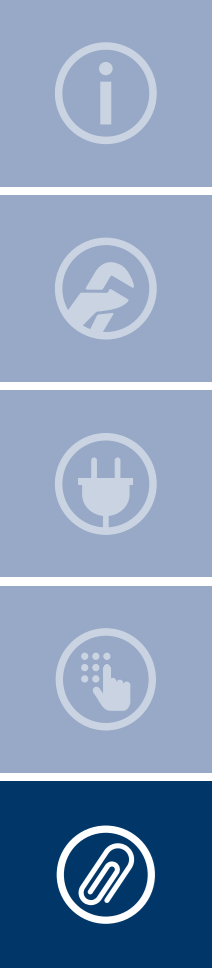

3



4

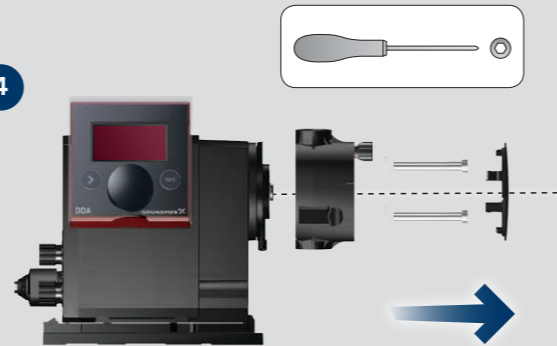

5

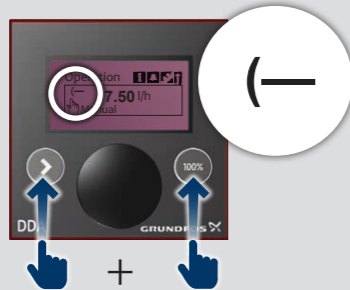

6



7

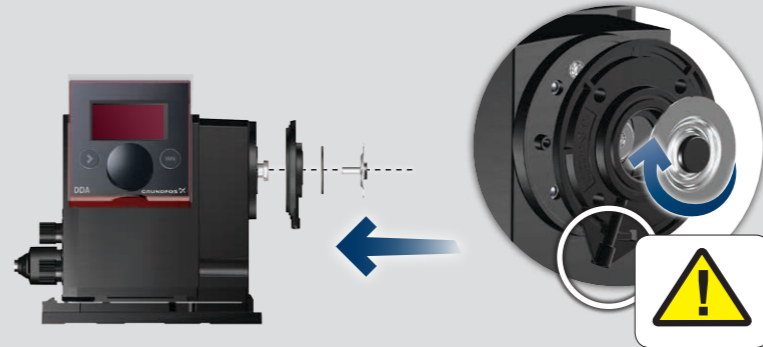

8

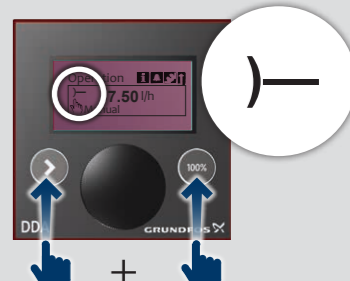

9

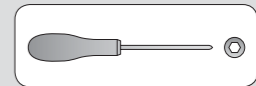

4 Nm (2.95 lb/ft)



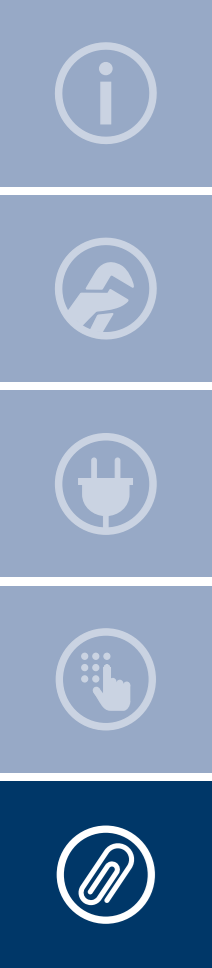

10



11

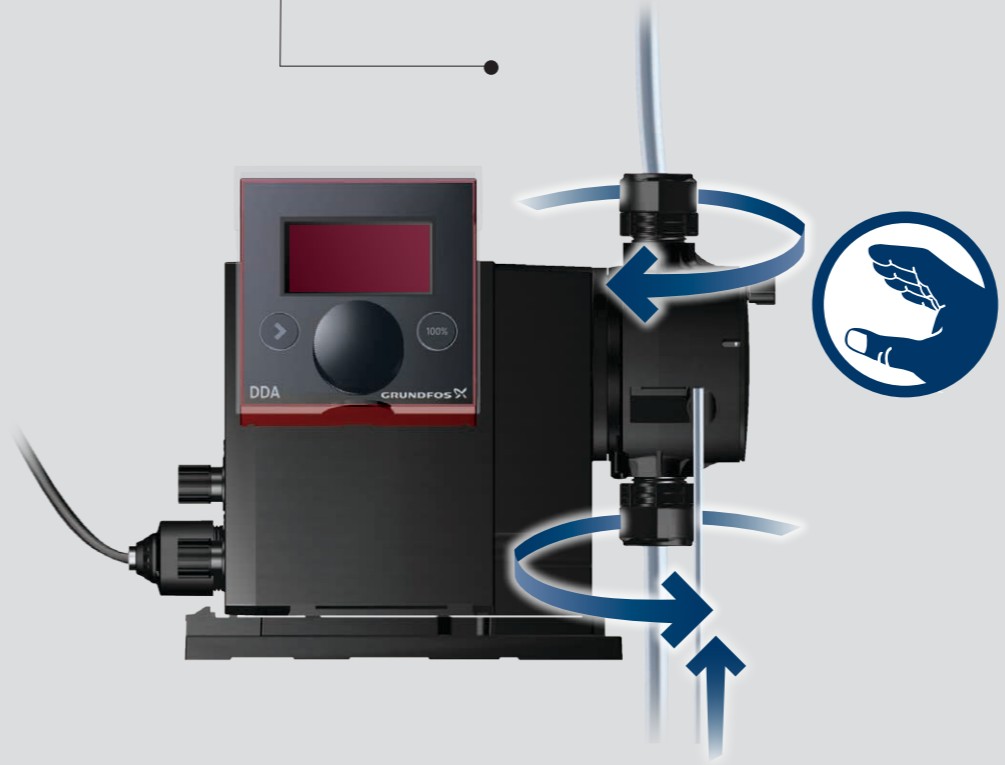
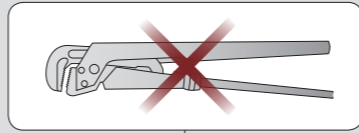

12

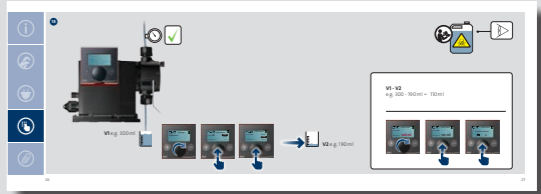
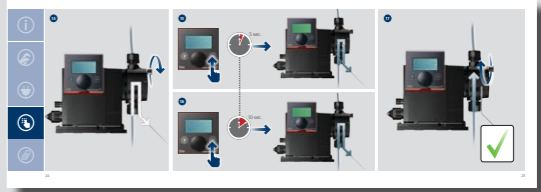
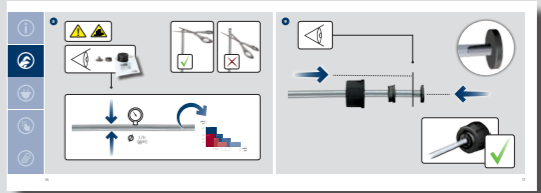

be think innovate

95725552 0617

ECM: 1210890

GRUNDFOS Holding A/S
Poul Due Jensens Vej 7
DK-8850 Bjerringbro
Tel: +45 87 50 14 00
www.grundfos.com

GRUNDFOS 

The name Grundfos, the Grundfos logo, and be think innovate are registered trademarks owned by Grundfos Holding A/S or Grundfos A/S, Denmark. All rights reserved worldwide.