

Hydro MPC

Installation and operating instructions



WATER QUALITY
Drinking water system component
NSF/ANSI 61
MH26400
NSF/ANSI 372

Hydro MPC

English (US)

Installation and operating instructions	4
Limited consumer warranty	84
Limited manufacturer's warranty	86

Original installation and operating instructions

Table of contents

1. General information	4
1.1 Hazard statements	4
1.2 Notes	4
2. System introduction	5
2.1 System description	5
2.2 Control variant	6
2.3 Identification	6
2.4 Type key	7
3. Receiving the system	8
3.1 Transporting the system	8
3.2 Inspecting the system	8
3.3 Scope of delivery	8
3.4 Handling and lifting the system	8
4. Installing the system	9
4.1 Mechanical installation	9
4.2 Electrical installation	11
5. Startup	12
5.1 Hygiene	12
5.2 Starting up the system	12
6. Control variants	13
7. CU 352 operating panel	14
7.1 Buttons and indicator lights	14
7.2 Display	15
8. Control functions	15
8.1 Overview of functions	15
8.2 Description of functions	17
8.3 Status (1)	17
8.4 Operation (2)	23
8.5 Alarm (3)	28
8.6 Settings (4)	30
8.7 Data communication	78
9. Servicing the system	80
9.1 Maintaining the system	80
9.2 Protecting the system against frost	80
9.3 Taking the system out of operation	80
10. Fault finding	80
10.1 Pumps not running	80
10.2 Pumps starting but stopping immediately	80
10.3 System stopping without restarting	80
10.4 Unstable water supply from system	81
10.5 Pumps running but delivering no water	81
10.6 System not reaching the setpoint	81
10.7 Leakage from the shaft seal	81
10.8 Noise	81
10.9 Very frequent starts and stops	81
11. Technical data	81
11.1 Pressure	81
11.2 Temperatures	82
11.3 Relative humidity	82
11.4 Sound pressure level	82
11.5 Electrical data	82
12. Product manuals	83
13. Disposal	83
13.1 Precautions for disposal	83
13.2 Disposing of the system	83

14. Document quality feedback 83

1. General information



Read this document before you install the system. Installation and operation must comply with local regulations and accepted codes of good practice.

1.1 Hazard statements

The symbols and hazard statements below may appear in Grundfos installation and operating instructions, safety instructions and service instructions.

**DANGER**

Indicates a hazardous situation which, if not avoided, will result in death or serious personal injury.

**WARNING**

Indicates a hazardous situation which, if not avoided, could result in death or serious personal injury.

**CAUTION**

Indicates a hazardous situation which, if not avoided, could result in minor or moderate personal injury.

The hazard statements are structured in the following way:

**SIGNAL WORD****Description of the hazard**

Consequence of ignoring the warning

- Action to avoid the hazard.

1.2 Notes

The symbols and notes below may appear in Grundfos installation and operating instructions, safety instructions and service instructions.



Observe these instructions for explosion-proof products.



A blue or gray circle with a white graphical symbol indicates that an action must be taken.



A red or gray circle with a diagonal bar, possibly with a black graphical symbol, indicates that an action must not be taken or must be stopped.



If these instructions are not observed, it may result in malfunction or damage to the equipment.



Tips and advice that make the work easier.

2. System introduction

2.1 System description

System description for CR, CRE

As standard, the systems consist of two to six CR, CRE pumps connected in parallel and mounted on a common base frame with a control cabinet and all necessary fittings.



A diaphragm tank must be included in some installations.

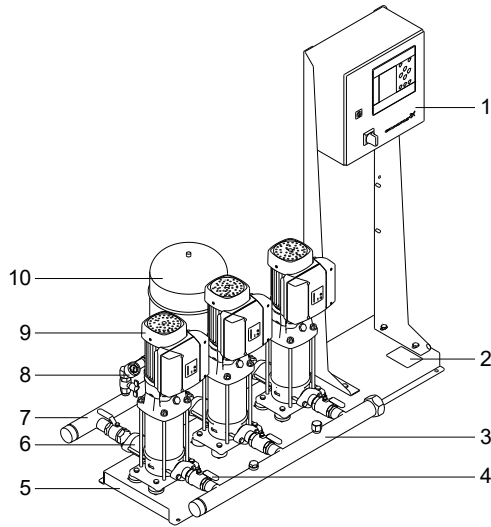

TM044110

System components

Pos.	Description	Quantity
1	Control cabinet	1
2	Nameplate	1
3	Inlet manifold, stainless steel	1
4	Isolating valve	2 per pump
5	Base frame, stainless steel	1
6	Check valve	1 per pump
7	Outlet manifold, stainless steel	1
8	Pressure transmitter and pressure gauge	1
9	Pump	2-6
10	Diaphragm tank	1

System description for Hydro MPC CME

Hydro MPC CME is a range of factory-assembled systems, ready for installation and operation.

As standard, the systems consist of two to three pumps connected in parallel and mounted on a common base frame with a control cabinet and all necessary fittings.

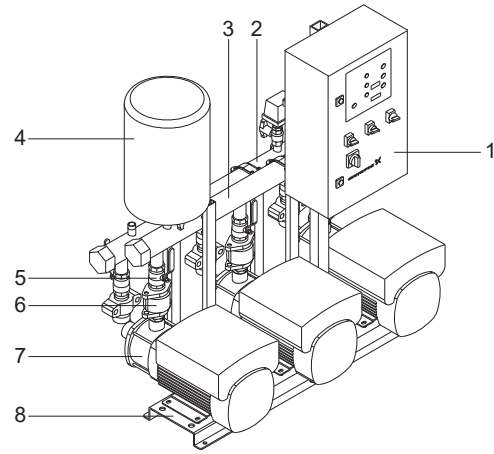

TM049898

System components, front view

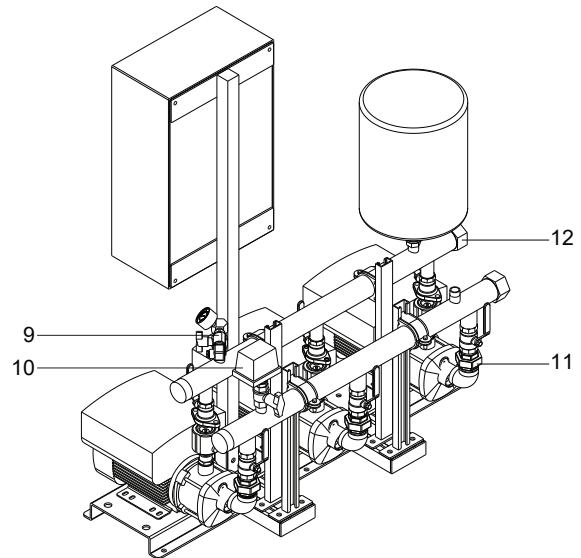

TM049899

System components, rear view

Pos.	Description	Quantity
1	Control cabinet	1
2	Inlet manifold	1
3	Outlet manifold	1
4	Diaphragm tank (not included)	1
5	Isolating valve	2 per pump
6	Check valve	1 per pump
7	Pump	2-4
8	Base frame	1
9	Pressure transmitter and pressure gauge	1
10	Pressure switch or inlet pressure sensor	1
11	Oval flange (CME 3-10)	2 per pump
	Intermediate adapter (CME 15-25)	1 per pump
12	Screw cap or blanking flange	2

2.2 Control variant

The systems are divided into groups based on the control variant:

Control variant	Description
-E/EC	Two to six electronically speed-controlled pumps. E systems are from 0.5 to 30 hp (0.37 to 22 kW), equipped with CRE pumps with integrated frequency converter. EC systems are from 40 hp (30 kW), equipped with CR pumps connected to Grundfos CUE frequency converters; one per pump. ¹⁾

1) EC systems smaller than 40 hp are available upon request.

Design code E-I only uses CR pumps connected to Grundfos CUE frequency converters; one per pump.

See also section Control variants.

The system always includes application-optimized software for setting the system to the application in question.

Related information

6. Control variants

2.3 Identification

2.3.1 Nameplate

The nameplate of the system is fitted on the base frame.



Nameplate

Pos.	Description
1	Company logo
2	Company address
3	Type designation
4	Product number - Serial number
5	Model
6	Supply voltage
7	Maximum operating pressure in PSI
8	Liquid temperature
9	Panel part number
10	Net weight in lb
11	Country of origin
12	Production code (year and week)
13	Nominal flow rate and maximum flow rate in GPM

Pos.	Description
14	Nominal head and maximum head in ft
15	Marks of approval
16	QR code

2.3.2 Software label

The software label is placed on the back of the CU 352.

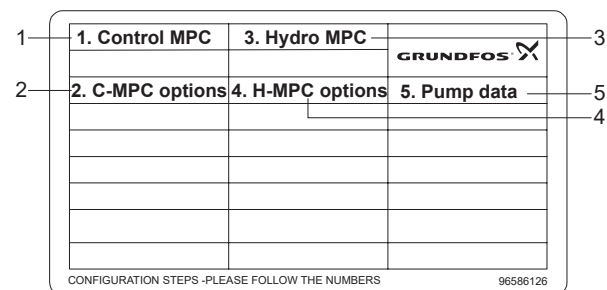

Software label

Pos.	Description
1	Control MPC - GSC file number
2	Control MPC options - GSC file numbers
3	Hydro MPC - GSC file number ²⁾
4	Hydro MPC options - GSC file numbers ²⁾
5	Pump data - GSC file number ³⁾

2) Applies only to systems.

3) Applies only to CR, CRI, CRN, CRE and CRIE pumps.



A GSC (Grundfos Standard Configuration) file is a configuration data file.

2.4 Type key

Example: Hydro MPC-E 6 CRNE155-1-1 U1 A-A-A-ABCD

Code	Explanation	Designation
Hydro MPC		System name
E	E: All pumps E Motor or CUE F: Fixed speed pumps, 1 CUE	S: Fixed speed pumps X: Customised system type System type
6		Number of main pumps
CRNE155-1-1		Pump type
U1	U1: 3 x 380-415 V, N, PE, 50/60 Hz U2: 3 x 380-415 V, PE, 50/60 Hz U3: 3 x 380-415 V, N, PE, 50 Hz U4: 3 x 380-415 V, PE, 50 Hz U5: 3 x 380-415V, N, PE, 60 Hz U6: 3 x 380-415 V, PE, 60 Hz U7: 1 x 200-240 V, PE, 50/60 Hz U8: 1 x 200-240 V, N, PE, 50/60 Hz U9: 3 x 220-240 V, PE, 60 Hz	UA: 3 x 440-480 V, PE, 60 Hz UB: 1 x 220-240 V, N, PE, 50/60 Hz UC: 1 x 220-240 V, N, PE, 50 Hz UD: 3 x 440-480 V, N, PE, 60 Hz UJ: 1 x 208-230 V, PE, 60 Hz UK: 3 x 208-230 V, PE, 60 Hz UL: 3 x 460-480 V, PE, 60 Hz UX: CSU variant (special voltage rating) Voltage code
A	A: Systems with the control cabinet mounted on the same base frame as the pumps. B: Systems with the control cabinet centered on the base frame. C: Systems with the control cabinet mounted on its own base for floor mounting. The control cabinet can be placed up to 50 ft from the pumps. D: Systems with the control cabinet mounted on its own base frame. The control cabinet can be placed up to 50 ft from the pumps. W: Systems with the control cabinet prepared for wall mounting. The control cabinet can be placed up to 50 ft from the pumps.	Design
A	A: E B: DOL C: SD	Starting method
A	A: Stainless steel manifold and base frame, and standard valves B: Stainless steel manifold, base frame and valves C: Galvanised steel manifold and base frame, and standard valves D: Stainless steel manifold, galvanised steel base frame, and standard valves H: Galvanised steel manifold and base frame painted black, and standard valves I: Stainless steel manifold and base frame painted black, and standard valves X: Customized material combination	Material combination
ABCD	A: Standard hydraulic, PN 16 B: Pilot pump C: Bypass D: Check valve on inlet E: Elbow manifold F: No inlet manifold G: Diaphragm tank H: Dry-running protection I: Repair switch J: Redundant sensor or switch K: 1 free pump position L: 2 free pump position M: 3 free pump position	N: PN 10 pressure rating O: PN 25 pressure rating P: Low prepressure Q: PN 40 pressure rating R: RPM = 50 Hz S: Customised variant T: Certificate U: Undersized motor V: Standard controls with options W: Customized controls 3W: Hydro DDD panel X: More than 4 options Y: Control cabinet with double door Option

3. Receiving the system

3.1 Transporting the system

Depending on the size, the system is supplied in an open wooden box or wooden or cardboard box designed for transport by forklift truck or a similar vehicle.

The forks of the forklift truck must be at least 6.6 ft (2 m) long.



If the system is secured with transport straps, do not remove the straps until the system is installed.

3.2 Inspecting the system

Upon receipt of the system, do the following:

1. Make sure that the system and accessories correspond to the order and there are no missing parts.
2. Make sure that the packaging is intact.

3.3 Scope of delivery

All supplied systems are factory-tested. The box contains:

- 1 Hydro MPC system
- installation and operating instructions
 - for the system
 - for the pump
 - for E-pumps (when applicable)

3.4 Handling and lifting the system

DANGER

Overhead load

Death or serious personal injury

- When lifting the system, do not use the eyebolts of the motors.
- Do not lift the system by the manifolds.
- Do not stand on the manifolds.



WARNING

Overhead load

Death or serious personal injury

- Do not stand under or close to the load that is lifted. Comply with local regulations.



WARNING

Crushing of feet

Death or serious personal injury

- Before you lift, make sure that the lifting equipment is capable of lifting this load, which is listed on the nameplate and on the packaging label.



CAUTION

Overhead load

Minor or moderate personal injury

- Use appropriate lifting equipment when placing the system.



When lifting the system, the lifting point must always be above the center of gravity to ensure stability.

Handling systems with CR pumps

Systems have holes in the base frame for lifting. For these systems, each lifting strap must be at least 10 ft (3 m) long.

- Use certified lifting gear applicable for the load. Straps must be placed to ensure vertical pull to the system.
- Use a safety strap around one of the pump motors to prevent the system from tilting.

- Wind the safety strap around the pump head more than one time if there are no eyebolts or brackets on the pump.
- Keep the safety strap tight.
- Use shackles mounted in the holes for lifting when lifting the systems with CR 1 to CR 95.



If the system is secured with transport straps, do not remove the straps until the system is installed.



Do not use chains for lifting systems with CR 125 or larger pumps, as this may damage the motors.

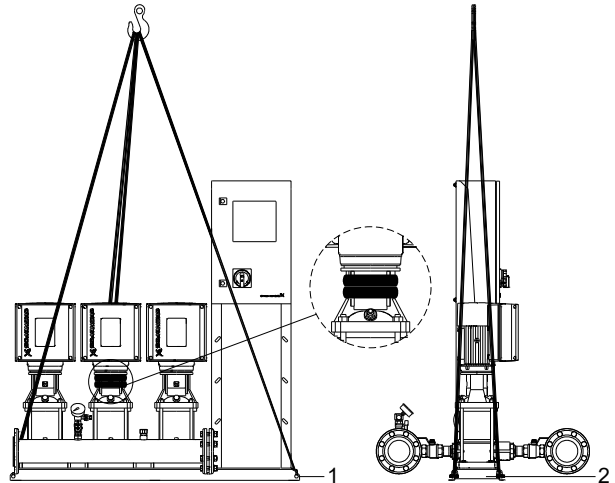

Using lifting gear to lift a system, with a safety strap around the pump head

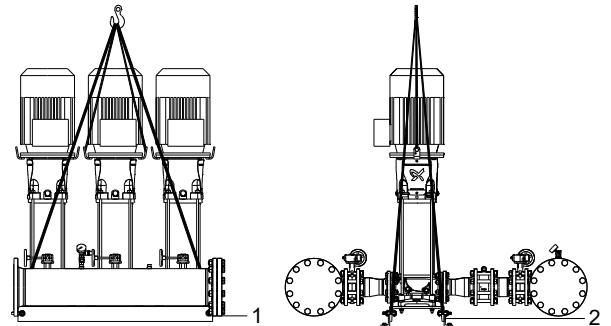

Using lifting gear to lift a pump assembly

TM086987

TM044188

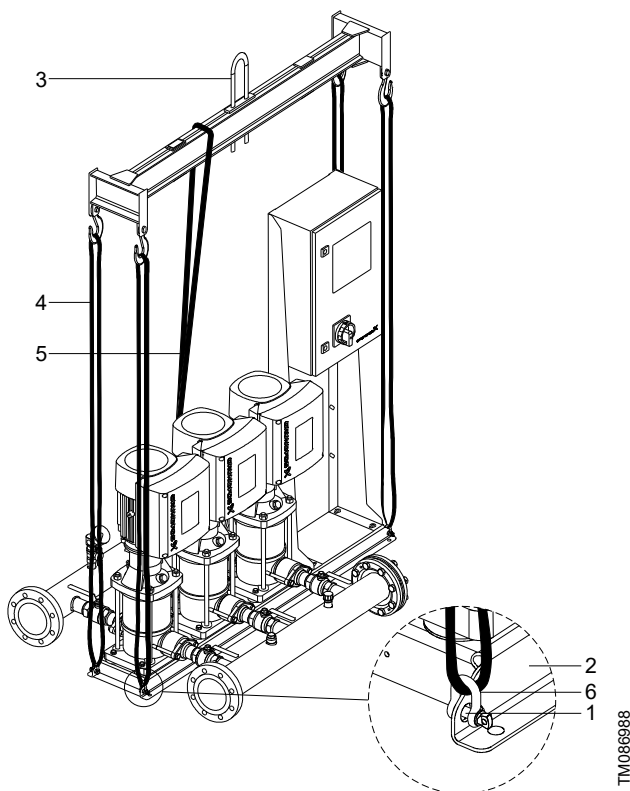

Using lifting gear to lift a system

Pos.	Description
1	Lifting hole (included)
2	Base frame made of bent steel plate
3	Lifting gear
4	Lifting strap
5	Safety strap
6	Shackles

Handling systems with CME pumps

Lift the systems with CME pumps as shown in the figure below.

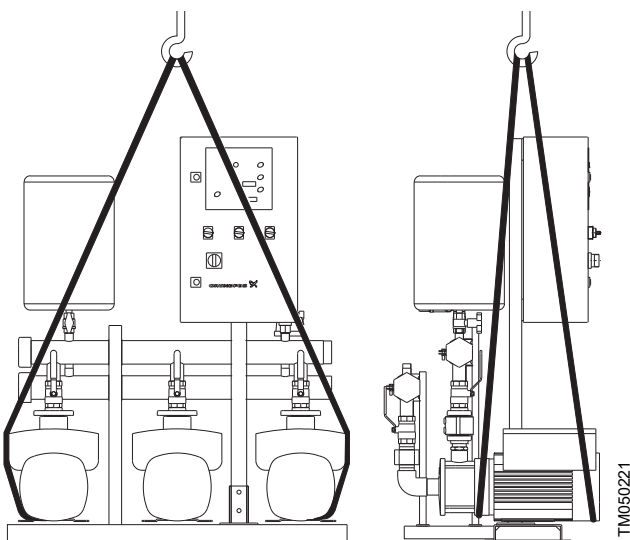

Using lifting gear to lift a system with CME pumps

4. Installing the system

WARNING

Crushing

Death or serious personal injury



- Use professional installation tools when moving or lifting the system or the components.
- Use safety equipment when mounting the base frame.
- Use the supplied wooden beams delivered to support the system when mounting the vibration dampers.
- Only trained persons can carry out the installation.

CAUTION

Overhead load

Minor or moderate personal injury



- Use appropriate lifting equipment when placing the system.

CAUTION

Crushing of feet

Minor or moderate personal injury



- Use safety equipment when installing the pipes and the tank.

CAUTION

Sharp element

Minor or moderate personal injury



- Wear safety gloves.

4.1 Mechanical installation

4.1.1 Location

The system is only designed for indoor installation and must not be exposed to direct sunlight.

- Install the system in a well-ventilated room to ensure sufficient cooling of the control cabinet and pumps.
- Install the system with a one-meter (3 ft) clearance on all sides for inspection and removal.

4.1.2 Pipes

Arrows on the pump base show the direction of flow of water through the pump.

The pipes connected to the system must be of adequate size.

Connect the pipes to the manifolds of the system. Either end can be used. Apply sealing compound to the unused end of the manifold, and fit the screw cap. For manifolds with flanges, fit a blanking flange with gasket.

To optimize operation and minimize noise and vibration, it may be necessary to consider vibration dampening of the system.

Noise and vibration are generated by the rotations in the motor and pump and by the flow in pipes and fittings. The effect on the environment is subjective and depends on correct installation and the state of the other parts of the system.

If systems are installed in blocks of flats or the first consumer on the line is close to the system, we recommend that you fit expansion joints on the inlet and outlet pipes to prevent vibration from being transmitted through the pipes.

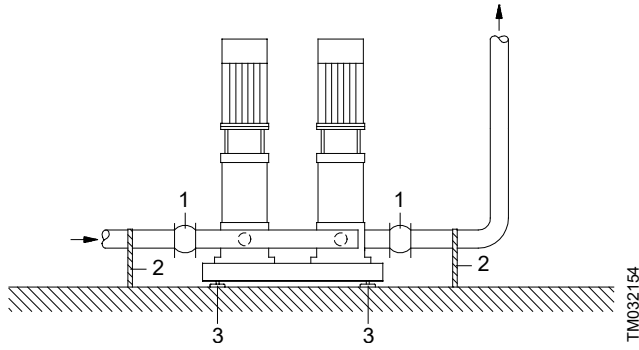

Example showing the position of expansion joints, pipe supports and machine shoes

Pos.	Description
1	Expansion joint (and good location for isolating valves)
2	Pipe support
3	Vibration damper (machine shoe)

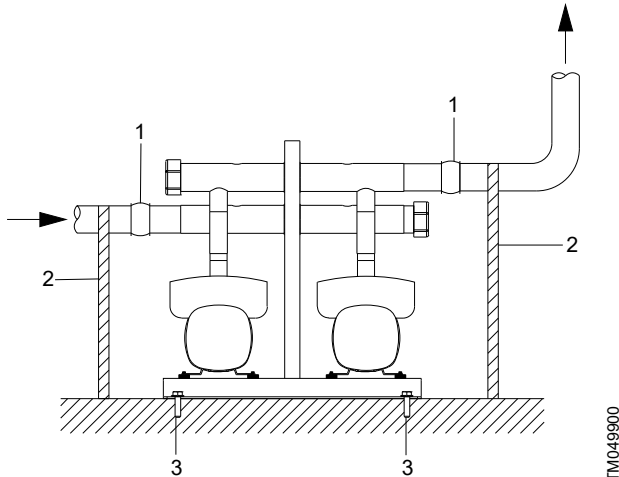

Example showing the position of expansion joints, pipe supports and mounting bolts

Pos.	Description
1	Expansion joint (and good location for isolating valves)
2	Pipe support
3	Mounting bolt



Expansion joints, pipe supports and vibration dampers are not included in a standard system.

Tighten all nuts before startup.

Fasten the pipes to parts of the building to ensure that they cannot move or be twisted.

4.1.3 Foundation

We recommend that you install the system on a plane and rigid concrete foundation which is heavy enough to provide permanent support for the entire system. The foundation must be capable of absorbing any vibration, normal strain or shock.



The weight of a concrete foundation must be 1.5 times the weight of the system.

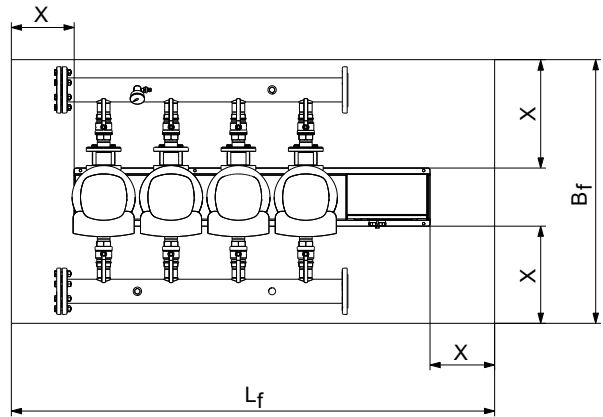
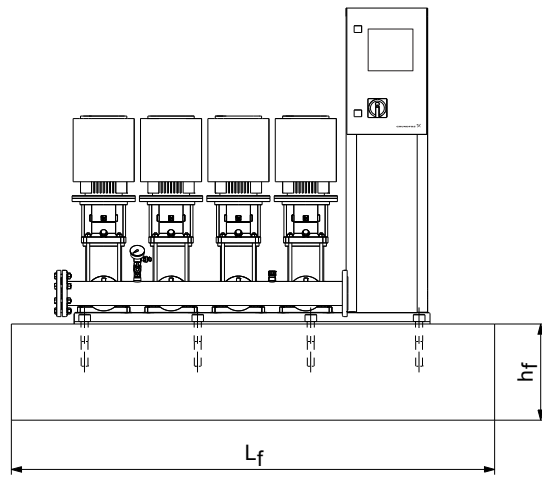

Foundation

The minimum height of the foundation, h_f , is calculated as follows:

$$h_f = \frac{m_{\text{pump}} \times 1.5}{L_f \times B_f \times \delta_{\text{concrete}}}$$

The density δ of concrete is usually taken as 137 lb/ft³ (2200 kg/m³).

Variable	Unit
h_f	ft
m_{pump}	lb
L_f	ft
B_f	ft
δ_{concrete}	lb/ft ³

4.1.4 Vibration dampers

To prevent the transmission of vibration to buildings, we recommend that you isolate the system foundation from the building parts by vibration dampers.

A proper damper varies in different installation situations, and a wrong damper may increase the vibration level. Vibration dampers must therefore be sized by the supplier. If the system is installed on a base frame with vibration dampers, always install expansion joints on the manifolds. This is important to prevent the system from "hanging" on the pipes.

4.1.5 Expansion joints

Fit expansion joints for these reasons:

- to absorb expansions or contractions in the pipes caused by changing liquid temperature
- to reduce mechanical strains in connection with pressure surges in the pipes
- to isolate mechanical structure-borne noise in the pipes (only rubber bellows expansion joints).



Do not install expansion joints to compensate for inaccuracies in the pipes such as center displacement of flanges.

Fit expansion joints at a distance of minimum 1 to 1 1/2 times the nominal flange diameter from the manifold on the inlet as well as on the outlet side. This prevents the development of turbulence in the expansion joints, resulting in better inlet conditions and a minimum pressure loss on the pressure side.



Examples of rubber bellows expansion joints without limiting rods



Examples of rubber bellows expansion joints with limiting rods

Expansion joints with limiting rods can be used to minimize the forces caused by the expansion joints. We always recommend that you use expansion joints with limiting rods for flanges larger than ANSI 4" (DN 100).

Anchor the pipes so that they do not stress the expansion joints and the pump. Follow the supplier's instructions and pass them on to advisers or pipe installers.

4.1.6 Prefilling of diaphragm tank, if applicable

If a diaphragm tank is connected to the system, prefill the tank with nitrogen to this pressure: $0.7 \times$ the setpoint



Use nitrogen to avoid corrosion.

4.2 Electrical installation

DANGER

Electric shock

Death or serious personal injury



- Switch off the power supply and make sure that the power supply cannot be accidentally switched on.
- Make sure that the wires to be connected to the connection groups are separated from each other by reinforced insulation in their entire lengths.

WARNING

Electric shock

Death or serious personal injury



- Installation must be carried out by qualified personnel, and according to local regulations.

- The electrical installation of the system must comply with enclosure class:
 - UL Type 3R, for control cabinet without VFD in it
 - UL Type 12, for control cabinet with VFD in it.
- Check that the power supply and frequency correspond to the values stated on the nameplate.
- Make sure that the conductor cross-section meets the specifications in the wiring diagram.



The connection of the electrical supply, transmitters and external monitoring equipment must be carried out by an authorized electrician in accordance with the NEC, local regulations and the Hydro MPC wiring diagram.



Ensure that the system controls and the pumps are suitable for the electricity supply on which they will be used. See section Technical data. Read the wiring diagram carefully. According to the NEC, if the motors cannot be seen from the operating panel, they must be fitted with a disconnect switch.



Any system that utilizes a variable frequency drive (E, ED, ES, EF, EDF, F) must be connected to an electrical supply with all phase lines electrically symmetrical with respect to ground. Grundfos recommend a four-wire wye electrical supply with line impedance between 0.5 - 3 %. If a variable frequency drive is connected to a delta transformer or if line impedance is not within the recommended 0.5 - 3 %, the drive may not operate correctly and may not provide optimum performance (excessive faults, erratic behavior, or complete failure). Grundfos does not recommend open delta power. Ask your power company or electrician to determine what type of electrical supply is present. Generator supplied power must meet public utility power quality standards.

5. Startup

DANGER

Electric shock

Death or serious personal injury



- Switch off the power supply and wait at least five minutes before you make any connections in the breaker cabinet or control cabinet.
- Before the system is started up, make sure that the power supply is disconnected and cannot be accidentally switched on.
- Tighten the wire connections.

DANGER

Electric shock

Death or serious personal injury



- Connect the motor to protective earth and provide protection against indirect contact according to local regulations.
- Before the system is started up, make sure that there is no short-circuit.

WARNING

Contaminated drinking water

Death or serious personal injury



- Flush the system before starting it in compliance with local legislation.

WARNING

High temperature

Death or serious personal injury



- Before you operate, make sure that the system can handle the load specified on the nameplate.



CAUTION

Hot or cold surface

Minor or moderate personal injury



- Make sure that the escaping hot or cold liquid does not cause injury to persons or damage to the equipment.



CAUTION

High noise level

Minor or moderate personal injury

- Use ear protection.



CAUTION

Sharp element

Minor or moderate personal injury

- Wear safety gloves.

5.1 Hygiene

Grundfos systems are functionally tested and may therefore contain small amounts of residual water. Contaminated drinking water can endanger health, so before using the system, it must be rinsed or flushed thoroughly. This also applies if the system is not used for a longer period.

Rinsing and flushing must always be done in accordance with local regulations and practices.

5.2 Starting up the system

After having carried out the mechanical and electrical installation, proceed as follows:

1. Have a qualified person check for proper power supply and plumbing connections. Make sure the main power is off.
2. Check that the precharge pressure in the diaphragm tank is 0.7 times the required outlet pressure (setpoint). System pressure must not be applied to the tank connection during the tank precharge process. If water is supplied to the tank from the system, close the tank valve and bleed off the pressure in the tank before the pressurizing process.
3. Prime the system as follows:
 - "Flooded inlet system" (pumps are flooded at least as high as the highest part of the pumps)
 - a. Close all outlet manifold pump isolation valves.
 - b. Open all inlet manifold pump isolation valves.
 - c. Open the vent plug on all pumps.
 - d. Leave the vents open until all air is removed from the pumps and only water is flowing from the vents.
 - e. Close the vent plug on all pumps
 - "Suction lift system" (the water source is below the pumps or does not flood the pumps to the highest point on the pumps).



A foot valve must be placed on the inlet piping at the water source (tank, etc).



Check valves must be installed on inlet manifolds and a priming line installed from outlet to inlet manifold for proper installation.

- a. Close all outlet manifold pump isolation valves.
 - b. Open all inlet manifold pump isolation valves.
 - c. If there is a fill point above the highest point of the pumps, you may fill the system from this point.
 - d. If there is no fill point above the highest point of the pumps, remove the large vent plug on each pump. Fill each pump until the water is up to the vent plug.
 - e. Replace the vent plugs.
4. Ensure that all circuit breakers are in the on position.
 5. Ensure that the outlet manifold pump isolation valves are closed.
 6. Switch on the main power.



When the power is switched on, the pumps may start automatically.

7. If this is the first time the system has been powered on, the **Start-up wizard** may appear. Complete the **Start-up wizard** and proceed to step 9. If the wizard does not appear, proceed to step 8.
8. Run the **Start-up wizard** and perform the following:
 - a. Move top line display to **Settings**. If prompted for password, enter **1234**.
 - b. Move down to **Functions, CU 352** and press **OK**.
 - c. Move down to **Run wizard again** and press **OK**.
9. Vent the system by opening the vent plug on each pump (as in step 4, while the pump is running starting in step 18 of the **Start-up wizard**). Venting with the pumps running ensures all air is removed from the inlet piping. Do not run the system with the outlet manifold pump isolation valves closed more than five minutes to prevent over-heating of the pump liquid.
10. As the pumps stop, check the pump rotation. Repeat as necessary.



For better visibility remove a coupling guard. If the area is dark, a flashlight may be required.

CAUTION

Crushing of hands

Minor or moderate personal injury



- Do not touch the couplings while the pumps are turning. Replace all coupling guards after the rotation check.
- Disconnect the mains power when removing and replacing the coupling guards.



If the rotation is incorrect on any three-phase pumps, switch any 2 of the 3 power cables supplied to the control cabinet (L1, L2, L3). If this does not correct the rotation, contact Grundfos.

11. When you have vented the pumps and checked for correct rotation, the system is now ready for operation. With the outlet manifold isolation valves still closed, partially open each pump outlet isolation valve to allow water to enter into the outlet piping. Continue the process of filling the outlet piping until the outlet piping pressure is approximately at the desired setpoint pressure of the system.
12. Open pump outlet isolation valves completely. The system is now ready for operation.



It may be necessary to clear alarms in the fault log.

6. Control variants

Systems with speed-controlled pumps	
Hydro MPC-E (CRE or CME)	Hydro MPC-EC (CUE)

Hydro MPC system with three CRE, CME pumps.

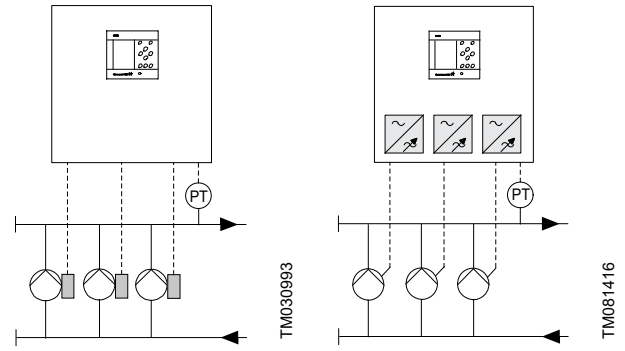

One CRE, CME pump in operation.

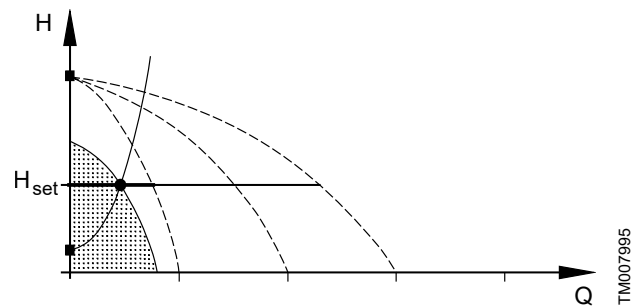

Three CRE, CME pumps in operation.

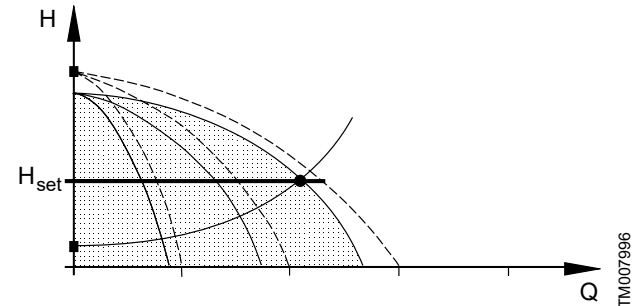

- Hydro MPC-E maintains constant pressure through continuously variable adjustment of the speed of the CRE, CME pumps connected.
- The performance is adjusted to the demand through cutting in/out the required number of CRE, CME pumps and through parallel control of the pumps in operation.
- Pump changeover is automatic and depends on load, operating hours and fault.
- All pumps in operation run at the same speed.

7. CU 352 operating panel

The operating panel in the front cover of the control cabinet features a display, a number of buttons and two indicator lights. The operating panel enables manual setting and monitoring of the performance of the system.

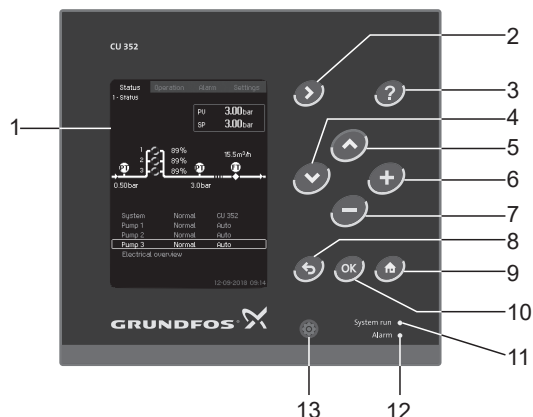

CU 352 operating panel

Pos.	Description
1	Display
2	Arrow to the right
3	Help
4	Down
5	Up
6	Plus
7	Minus
8	Esc.
9	Home
10	OK
11	Indicator light, operation (green)
12	Indicator light, fault (red)
13	Display brightness

7.1 Buttons and indicator lights

The buttons on CU 352 operating panel are active when they are on.

Related information

[7. CU 352 operating panel](#)

7.1.1 Arrow to the right (2)

Press [>] to go to the next menu in the menu structure. If you press [>] when the menu **Settings** is highlighted, you will go to the menu **Status**.

7.1.2 Help (3)

When this symbol is on, a help text applying to the display will appear if you press the button.

Close the text with ↵.

7.1.3 Up and down (4 and 5)

Move up and down in lists with [v] and [^].

You can select a text with [OK] when it is in a box.

If a text is marked and you press [^], the text above will be marked.

If you press [v], the text below will be marked.

If you press [v] in the last line in the list, the first line will be marked.

If you press [^] in the first line in the list, the last line will be marked.

7.1.4 Plus and minus (6 and 7)

Increase and reduce a value with [+] and [-]. Save with [OK].

7.1.5 Back (8)

Press ↵ to go one display back in the menu.

If you have changed a value and press ↵, the new value will not be saved. See also section OK (10).

If you press [OK] before pressing ↵, the new value will be saved.

See also section OK (10).

Related information

[7.1.7 OK \(10\)](#)

7.1.6 Home (9)

Press 🏠 to return to the menu **Status**.

7.1.7 OK (10)

Use the button as an enter button.

The button is also used to start the setting of a value. If you have changed a value, press [OK] to save the change.

7.1.8 Indicator lights (11 and 12)

The operating panel incorporates a green and red indicator light.

The green indicator light will be on when the system is in operation and flash when the system has been set to stop.

The red indicator light will be on if there is an alarm or a warning.

The fault can be identified from the alarm list.

7.1.9 Display brightness (13)

You can change the brightness in the display with this button:

1. Press ☼.
2. Adjust the brightness with [+] and [-].

7.1.10 Back light

If no button is touched for 15 minutes, the back light of the display will be dimmed.

Press the HOME button to re-activate the back light.

TM054258

7.2 Display

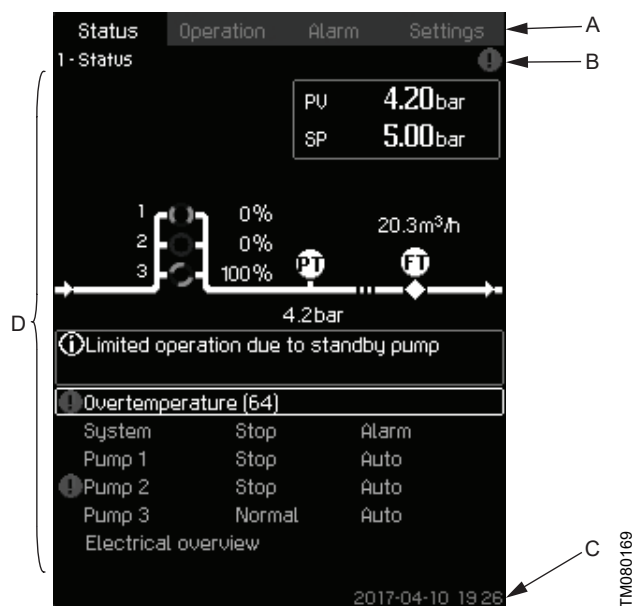

Display

Pos.	Description
A	Menu line
B	Top line
C	Bottom line
D	Graphical illustration

7.2.1 Menu line

The menu line (A) is illustrated on the display.
The display has four main menus:

Status	Indication of system status
Operation	Change of operating parameters such as setpoint
Alarm	Alarm log for fault finding
Settings	Change of settings (password option)

7.2.2 Top line

The top line (B) shows the following:

- the display number and title (left side)
- the selected menu (left side)
- the symbol \otimes in case of alarm (right side)
- the symbol \triangle in case of warning (right side)
- the symbol \nearrow if the service language has been selected (right side)
- the symbol \oplus if there is an active ethernet connection.

7.2.3 Graphical illustration

The graphical illustration (D) may show a status, an indication or other elements, depending on the position in the menu structure.
The illustration may show the entire system or part of it as well as various settings.

7.2.4 Scroll bar

If the list of illustration elements exceeds the display, the symbols \boxplus and \boxminus appear in the scroll bar to the right. Move up and down in lists with these symbols.

7.2.5 Bottom line

The bottom line (C) shows the date and time.

8. Control functions

8.1 Overview of functions

Display and display number

Status (1)

This menu shows alarms, status of the system and a graph of logged data.

Note: No settings can be made in this menu.

Actual alarms (3.1)

System (1.2)

Operating mode (1.2.1)

Setpoint (1.2.2)

Setpoint influence (1.2.3)

Measured values (1.2.4)

Analog inputs (1.2.5)

Log graph (1.2.6)

Battery status (1.2.7)

Pump 1-6, Pilot pump (1.3 - 1.10)

Operation (2)

In this menu, you can set the basic parameters, such as setpoint, operating mode, and individual pump control.

Operation (2)

System operating mode (2.1.1)

Control mode (2.1.2)

Alternative setpoints (2.1.3)

Individual pump control (2.1.4)

- Pump 1-6 (2.1.4.1 - 2.1.4.6)
- Operation, pilot pump (2.1.4.7)

Alarm (3)

This menu gives an overview of alarms and warnings.
You can reset alarms and warnings in this menu.

Alarm status (3)

Actual alarms (3.1)

Alarm log (3.2)

Service contact information (3.3)

Display and display number

Settings (4)

In this menu, you can set various functions:

- **Primary controller**
PI controller, Alternative setpoints, External setpoint influence, Primary sensor, Clock program, Proportional pressure, S-system configuration, Setpoint ramp.
- **Pump cascade control**
Min. time between start/stop, Max. number of starts/hour, Number of standby pumps, Forced pump changeover, Pump test run, Pump stop attempt, Pump start and stop speed, Min. performance, Compensation for pump start-up time.
- **Secondary functions**
Stop function, Soft pressure build-up, Digital inputs, Analog inputs, Analog outputs, Emergency run, Min., max. and user-defined duty, Pump curve data, Control source, Fixed inlet pressure, Flow estimation, Reduced operation.
- **Monitoring functions**
Dry-running protection, Min. pressure, Max. pressure, External fault, Limit 1 exceeded, Limit 2 exceeded, Pumps outside duty range, Pressure relief, Log values, Fault, feedback sensor.
- **Functions, CU 352**
Display language, Units, Date and time, Password, Ethernet, GENibus number, Software status.

*Primary controller (4.1)**PI controller (4.1.1)**Alternative setpoints (4.1.2)*

- *Alternative setpoints 2-7 (4.1.2.1 - 4.1.2.7)*

External setpoint influence (4.1.3)

- *Setting of influence function (4.1.3.2)*

*Primary sensor (4.1.4)**Secondary sensor (4.1.5)**Clock program (4.1.6)**Proportional pressure (4.1.7)**Setpoint ramp (4.1.9)**Pump cascade control (4.2)**Min. time between start/stop (4.2.1)**Max. number of starts/hour (4.2.1)**Standby pumps (4.2.3)**Forced pump changeover (4.2.4)**Pump test run (4.2.5)**Pump stop attempt (4.2.7)**Pump start and stop speed (4.2.8)**Min. performance (4.2.9)**Secondary functions (4.3)**Stop function (4.3.1)**Pilot pump (4.3.2) ⁴⁾**Soft pressure build-up (4.3.3)**Emergency run (4.3.5)**Digital inputs (4.3.7)*

- *Functions of digital inputs (4.3.7.1)*

Analog inputs (4.3.8)

- *Analog inputs (4.3.8.1 - 4.3.8.7)*
 - *Analog inputs and measured value (4.3.8.1.1 - 4.3.8.7.1)*
-

Display and display number

Digital outputs (4.3.9)

- *Function of digital outputs (4.3.9.1 - 4.3.9.16)*
-

Analog outputs (4.3.10)

- *Output signal (4.3.10.1 - 4.3.10.3)*
-

Min., max. and user-defined duty (4.3.14)

- *Min. duty (4.3.14.1)*
 - *Max. duty (4.3.14.2)*
 - *User-defined duty (4.3.14.3)*
-

*Pilot pump curve data (4.3.18)**Pump curve data (4.3.19)**Control source (4.3.20)**Fixed inlet pressure (4.3.22)**Flow estimation (4.3.23)**Reduced operation (4.3.24)**Multisensor settings (4.3.25)**Differential sensor (4.3.27)**Customisable measured value type (4.3.28)**Monitoring functions (4.4)**Dry-running protection (4.4.1)*

- *Pressure/level switch (4.4.1.1)*
- *Measurement, inlet pressure (4.4.1.2)*
- *Measurement, tank level (4.4.1.3)*

*Min. pressure (4.4.2)**Max. pressure (4.4.3)**External fault (4.4.4)**Limit 1 exceeded (4.4.5 - 4.4.6)**Pumps outside duty range (4.4.7)**Pressure relief (4.4.8)**Log values (4.4.9)**Fault, feedback sensor (4.4.10)**Non-return valve (4.4.11)**Controlled output 1-2 (4.4.13-4.4.14)**Functions, CU 352 (4.5)**Display language (4.5.1)**Units (4.5.2)**Date and time (4.5.3)**Password (4.5.4)**Ethernet (4.5.5)**GENibus number (4.5.6)**Software status (4.5.9)**Status display menu (4.6)*

- 4) **Pilot pump** needs to be activated via PC Tool.

8.2 Description of functions

The description of functions is based on the four main menus of the CU 352 control unit:

- **Status**
- **Operation**
- **Alarm**
- **Settings**.

The functions apply to all control variants unless otherwise stated.

8.3 Status (1)

This display is shown when the power is switched on, and it appears if the buttons of the control panel remain untouched for 15 minutes.

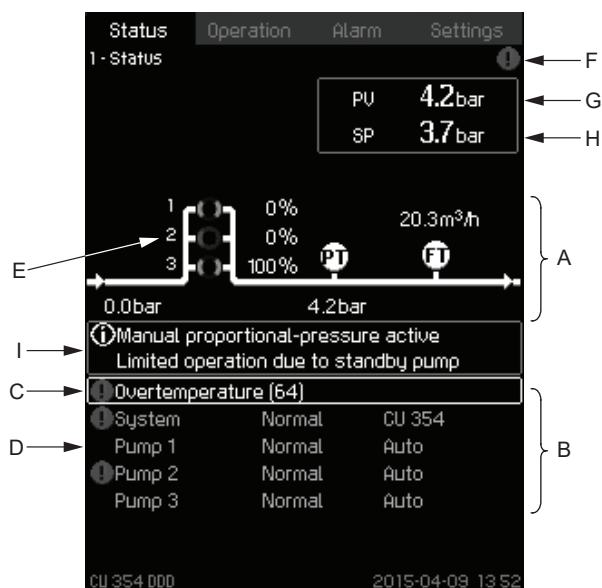

Status

Description

No settings can be made in this menu.

The actual value (process value, PV) of the control parameter, usually the outlet pressure, is shown in the upper right corner (G) together with the selected setpoint (SP) (H).

The upper half of the display (A) shows a graphic illustration of the system. The selected measuring parameters are shown with sensor symbol and actual value.

In MPC-E systems where the differential pressure across the pumps and pump curve data are known, the display shows the estimated flow rate when the flow rate and speed of the pumps are within a range where it is possible to estimate the flow rate.

≈ : This indicates that the flow rate is an estimated value.



The estimated flow rate may differ from a measured value.

In the middle of the display, an information field (I) is shown if any of the following events occurs:

- **Limited operation due to standby pump**
- **Proportional-pressure influence active**
- **External setpoint influence active**
- **Alternative setpoint active**
- **Low flow boost active**
- **Pressure relief active**
- **Clock program active**

- **Remote-controlled via GENI (RS-485)**
- **Limited due to reduced operation**
- **Stopped due to low flow.**

The lower display half (B) shows the following:

- the most recent active alarm, if any, and the fault cause with the fault code in brackets
- system status with actual operating mode and control source
- pump status with actual operating mode.



If a fault has occurred, the warning symbol \triangle or alarm symbol \otimes is shown in the line (C) together with the cause and fault code, for instance "Overtemperature (64)".

If the fault is related to one of the pumps, one of the symbols \triangle or \otimes is also shown in front of the status line (D) of the pump in question. At the same time, the pump status indicator (E) changes colour to either yellow or red as described in the table below. The symbol \triangle or \otimes is shown to the right in the top line of the display (F). As long as a fault is present, this symbol is shown in the top line of all displays.

To open a menu line, select the line with [V] or [Λ] and press [OK].

The display allows you to open status displays showing the following:

- actual alarms
- system status
- status of each pump.

Description of pump status

Pump status indicator	Description
Rotating, green	The pump is running.
Permanently green	The pump is ready (not running).
Rotating, yellow	Warning. The pump is running.
Permanently yellow	Warning. The pump is ready (not running).
Permanently red	Alarm. The pump is stopped.

2_TMO38947_002

8.3.1 Actual alarms (3.1)

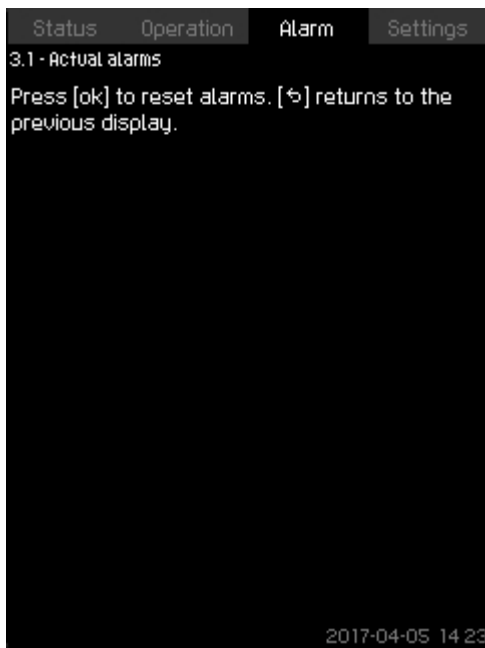

3-1_TM032293_011

Actual alarms**Description**

The display shows active unset alarms and warnings. For further information, see sections Actual alarms (3.1) and Alarm log (3.2).

Related information

- [8.5.2 Actual alarms \(3.1\)](#)
- [8.5.3 Alarm log \(3.2\)](#)

8.3.2 System (1.2)

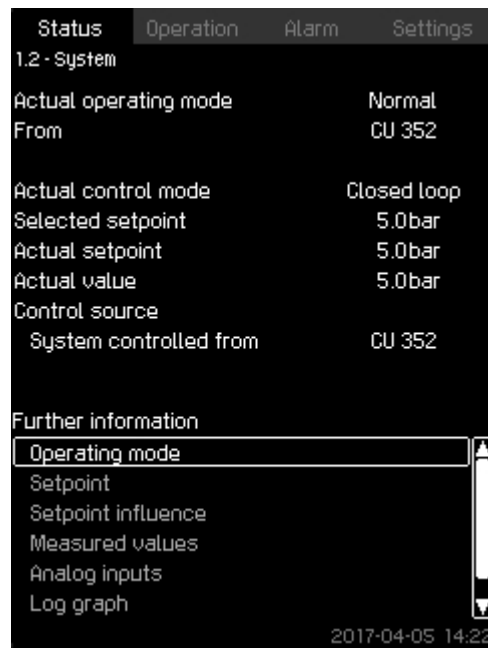

1-2_TM038946_085

System**Description**

The display shows the operational state of the system. Go to subdisplays for further details.

The display allows you to open the displays below:

- **Operating mode**
- **Setpoint**
- **Setpoint influence**
- **Measured values**
- **Analog inputs**
- **Log graph**
- **Battery status.**

8.3.3 Operating mode (1.2.1)

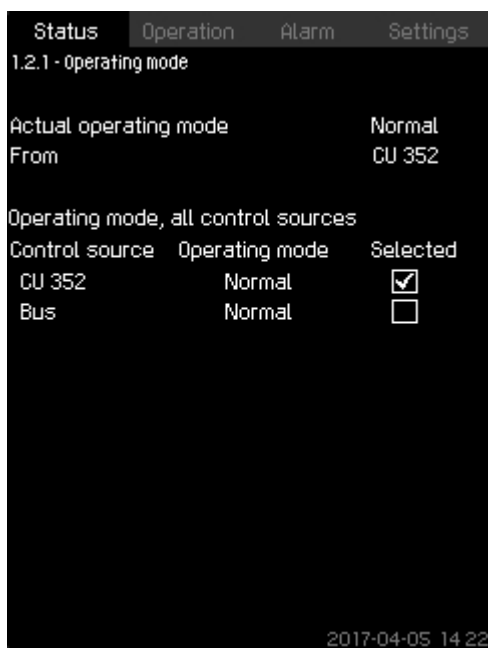

1-2-1_TM032273_086

Operating mode

Description

The display shows the operating mode of the system and from where it is controlled.

Operating modes

The system has six operating modes:

1. **Normal**
 - The pumps adapt their performance to the requirement.
2. **Max.**
 - The pumps run at a constant high speed. Normally, all pumps run at maximum speed.
3. **User-defined**
 - The pumps run at a constant speed set by the user. It is usually a performance between **Max.** and **Min.**.
4. **Min.**
 - The pumps run at a constant low speed. Normally, one pump is running at a speed of 70 %.
5. **Stop**
 - All pumps have been stopped.
6. **Emergency run**
 - The pumps run according to the setting made in display **Emergency run** (4.3.5).

The performance required in these operating modes can be set in the menu **Settings**:

- **Max.**
- **Min.**
- **User-defined**
- **Emergency run.**

See sections **Min., max. and user-defined duty** (4.3.14) and **Emergency run** (4.3.5).

The actual operating mode can be controlled from four different sources:

- Fault
- External signal
- **CU 352**
- **Bus.**

Control source

You can set the system to remote control via an external bus (option). In this case, you must set a setpoint and an operating mode via the bus.

In the menu **Settings**, you can select whether CU 352 or the external bus is to be the control source.

The status of this setting is shown in the display **Operating mode**.

Related information

[8.6.25 Emergency run \(4.3.5\)](#)

[8.6.36 Min., max. and user-defined duty \(4.3.14\)](#)

8.3.4 Setpoint (1.2.2)



1-2-2_TM032272_087

Setpoint

Description

The display shows the selected setpoint and whether it comes from CU 352 or an external bus.

The display also shows all seven possible setpoints from CU 352 (for closed- and open-loop control). At the same time, the selected setpoint is shown.

As it is a status display, no settings can be made.

You can change the setpoints in the menus **Operation** or **Settings**. See section **Alternative setpoints** (4.1.2).

Related information

[8.6.3 Alternative setpoints \(4.1.2\)](#)

8.3.5 Setpoint influence (1.2.3)

Status	Operation	Alarm	Settings
1.2.3 - Setpoint influence			
Control mode	Closed loop		
Selected setpoint	5.0bar		
Influenced by			
External setpoint influence	-- %		
Low flow boost	0.0bar		
Proportional pressure	-- %		
Actual setpoint	5.0bar		
2017-04-05 14:22			

1-2-3_TM038948_088

Setpoint influence

Description

The selected setpoint can be influenced by parameters. The parameters are shown as percentage from 0 to 100 % or as a pressure measured in psi. They can only reduce the setpoint, as the influence in percentage divided with 100 is multiplied with the selected setpoint:

Actual setpoint (SP) = selected setpoint x influence (1) × influence (2) × etc.

The display shows the parameters influencing the selected setpoint and the percentage or value of influence.

You can set some of the possible parameters in the display **External setpoint influence** (4.1.3). The parameter **Low flow boost** is set as a start/stop band as a percentage of the setpoint set in the display **Stop function** (4.3.1). The parameter is set as a percentage in the display **Proportional pressure** (4.1.7).

Finally, the resulting actual setpoint (SP) is shown.

Related information

[8.6.5 External setpoint influence \(4.1.3\)](#)

[8.6.10 Proportional pressure \(4.1.7\)](#)

[8.6.22 Stop function \(4.3.1\)](#)

8.3.6 Measured values (1.2.4)

Status	Operation	Alarm	Settings
1.2.4 - Measured values			
Actual control parameter (PV)			
			5.0bar
Other measured or calculated values			
Outlet pressure		5.0bar	
Flow rate	20.30m ³ /h		
Power consumption	--kW		
Energy consumption	702kWh		
Specific energy, actual	0.000kWh/m ³		
Specific energy, average	0.585kWh/m ³		
Total volume	1200m ³		
Press [ok] to reset accumulated values.			
2017-04-05 14:22			

1-2-4_TM032270_089

Measured values

Description

The display gives a general status of all measured and calculated parameters. In MPC-E systems with a flowmeter, the specific energy is shown as an average value and actual value (mean value over the last minute). The average value is based on the accumulated flow shown as total volume. The total volume and specific energy average can be reset in this display.



The lines **Power consumption** and **Energy consumption** are only shown in MPC-E systems.

8.3.7 Analog inputs (1.2.5)

Status	Operation	Alarm	Settings
1.2.5 - Analog inputs			
Analog inputs and measured value			
AI1 (CU 352), [51] (Outlet pressure)			5.0bar
AI2 (CU 352), [54] (Flow rate 1)			20.3m ³ /h
AI3 (CU 352), [57] (Not used)			--
AI1 (IO 351-41), [57] (Not used)			--
AI2 (IO 351-41), [60] (Not used)			--

2017-04-05 14:22

1-2-5_TM038949_145

Analog inputs

Description

The display shows an overview of the analog inputs and the measured values of each input. See sections Analog inputs (4.3.8), Analog inputs (4.3.8.1 - 4.3.8.7) and Analog inputs and measured value (4.3.8.1.1 - 4.3.8.7.1).

Related information

[8.6.28 Analog inputs \(4.3.8\)](#)

[8.6.29 Analog inputs \(4.3.8.1 - 4.3.8.7\)](#)

[8.6.30 Analog inputs and measured value \(4.3.8.1.1 - 4.3.8.7.1\)](#)

8.3.8 Log graph (1.2.6)

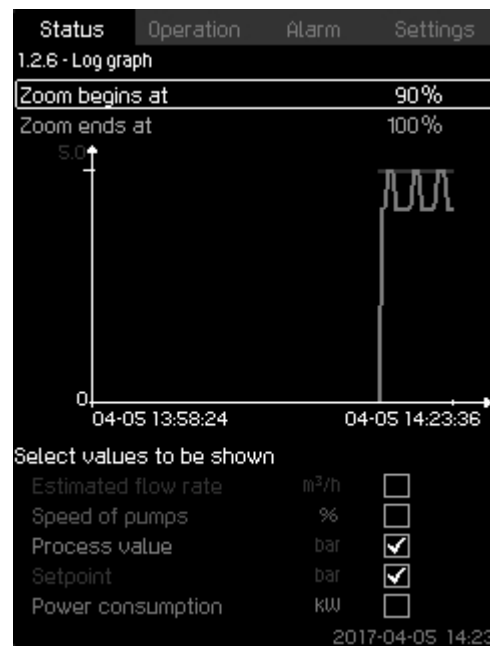

1-2-6_TM052975_182

Log graph

Description

The display shows logged data stored in the controller. Select log values in the display **Log values** (4.4.9). Various values can be shown, and the time scale can be changed.

Setting via the operating panel

Status > System > Log graph

- Set as a percentage:
 - Zoom begins at**
 - Zoom ends at.**
- Select values to be shown.**

Related information

[8.6.64 Log values \(4.4.9\)](#)

8.3.9 Battery status (1.2.7)

Status	Operation	Alarm	Settings
1.2.7 - Battery status			
Battery status			OK
Power source			Battery
Battery voltage		24.00V	
2017-04-05 14:23			

1-2-7_TM052976_188

Battery status**Description**

The display shows the status of the backup battery, if installed.

8.3.10 Pump 1-6, Pilot pump (1.3 - 1.10)

Status	Operation	Alarm	Settings
1.3 - Pump 1			
Operating mode			Auto
Actual operating mode			Normal
From			CU 352
Speed			89%
Power			--kW
Energy consumption			22kWh
Hours counter			0h
Temperature			0°C
2017-04-05 14:22			

1-3_TM032268_005

Pump 1**Description**

The display shows the operational state of the individual pumps.



The displays for the pilot pump are only shown if such pumps are installed.

The pumps can have different operating modes:

- **Auto**

Together with the other pumps in automatic operation, the pump is controlled by the PI controller which ensures that the system delivers the required performance.

- **Manual**

The pump is not controlled by the PI controller. In manual operation, the pump has one of the following operating modes:

- **Max.:** The pump runs at a set maximum speed. This operating mode can only be selected for variable-speed pumps.
- **Normal:** The pump runs at a set speed.
- **Min.:** The pump runs at a set minimum speed. This operating mode can only be selected for variable-speed pumps.
- **Stop:** The pump has been forced to stop.

Besides information about the operating mode, you can read various parameters in the status display, such as these:

- **Actual operating mode**
- **Control source**
- **Speed** (only 0 or 100 % are shown for mains-operated pumps)
- **Power** (only MPC-E/-EC)
- **Energy consumption** (only MPC-E/-EC)
- **Hours** (Operating hours)
- **Temperature.**

8.4 Operation (2)

In this menu, you can set the basic parameters, such as setpoint, operating mode, control mode and individual pump control.

8.4.1 Operation (2)

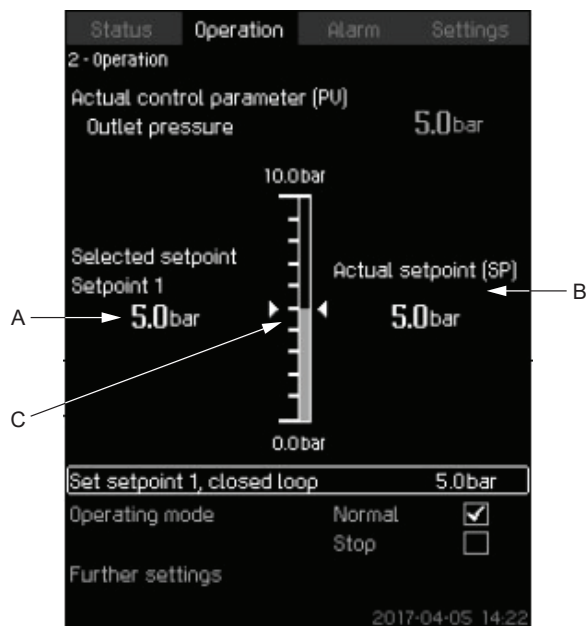

Operation

Description

The column shows the setting range. In closed-loop control, it corresponds to the range of the primary sensor, here 0-145 psi (0-10 bar). In open-loop control, the setting range is 0-100 %.

At the left hand of the column, you can see the selected setpoint 1 (A), that is the value set in the display. At the right hand of the column, you can see the actual setpoint (B), that is the setpoint acting as reference for the PI controller. If no kind of external setpoint influence has been selected, the two values will be identical. The measured value (outlet pressure) is shown as the grey part of the column (C). See sections External setpoint influence (4.1.3) and Setting of influence function (4.1.3.2).

Below the display is a menu line for setting of setpoint 1 and selection of operating mode, including the operating modes **Normal** and **Stop**. You can select further settings: **System operating mode**, **Control mode**, **Alternative setpoints** and **Individual pump control**.

Setting range

Setpoint:

Closed-loop control:	Measuring range of the primary sensor
Open-loop control:	0-100 %

Setting via the operating panel

Setpoint

- **Operation > Set setpoint 1, open loop / Set setpoint 1, closed loop.**

Set the value.

Operating mode

- **Operation**

Select: **Normal** or **Stop**.

Further settings

- **Operation > Further settings.**

Select one of the settings below:

- **System operating mode**, see section System operating mode (2.1.1).
- **Control mode**, see section Control mode (2.1.2).
- **Alternative setpoints**, see section Alternative setpoints (2.1.3).
- **Individual pump control**, see section Pump 1-6 (2.1.4.1 - 2.1.4.6).

Factory settings

The setpoint is a value suitable for the system in question. The factory setting may have been changed in the startup menu.

Related information

- [8.4.2 System operating mode \(2.1.1\)](#)
- [8.4.3 Control mode \(2.1.2\)](#)
- [8.4.4 Alternative setpoints \(2.1.3\)](#)
- [8.4.6 Pump 1-6 \(2.1.4.1 - 2.1.4.6\)](#)
- [8.6.5 External setpoint influence \(4.1.3\)](#)
- [8.6.6 Setting of influence function \(4.1.3.2\)](#)

8.4.2 System operating mode (2.1.1)

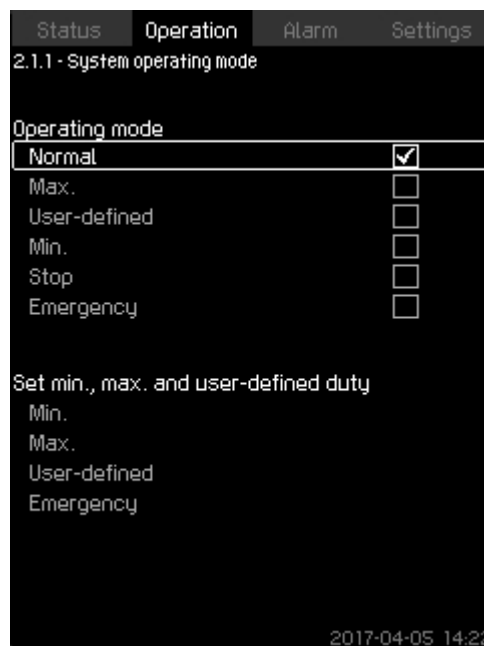

System operating mode

Description

The system can be set to six different operating modes. **Normal** is the typical setting. See section Operating mode (1.2.1).

You can set the performance of the operating modes in this menu:

- **Min.**
- **Max.**
- **User-defined**
- **Emergency.**

Setting range

- **Normal**
- **Max.**
- **Min.**
- **User-defined**
- **Stop**
- **Emergency.**

Setting via the operating panel

- **Operation > Further settings > System operating mode > Operating mode.**

Select the desired line at the bottom of the display to set the performance for **Max.**, **Min.**, **User-defined** and **Emergency**. See sections Emergency run (4.3.5) and Min., max. and user-defined duty (4.3.14).

Factory settings

Normal.

Related information

- 8.3.3 Operating mode (1.2.1)
- 8.6.25 Emergency run (4.3.5)
- 8.6.36 Min., max. and user-defined duty (4.3.14)

8.4.3 Control mode (2.1.2)

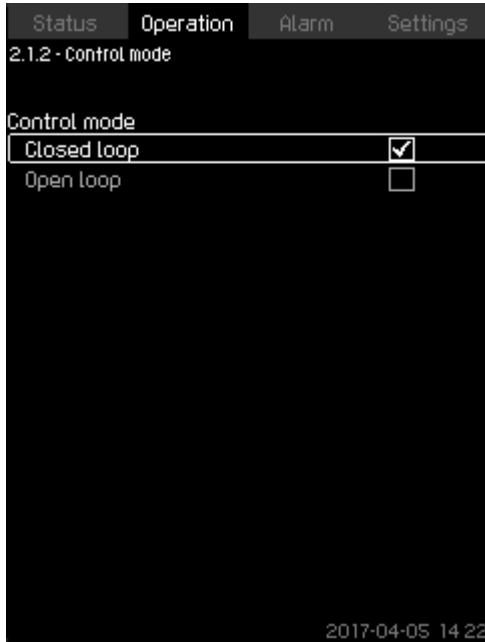

Control mode

Description

There are two control modes, namely closed and open loop.

Closed loop

The typical control mode is **Closed loop** where the built-in PI controller ensures that the system reaches and maintains the selected setpoint. The performance is based on the setpoint set for closed loop. See figures below.

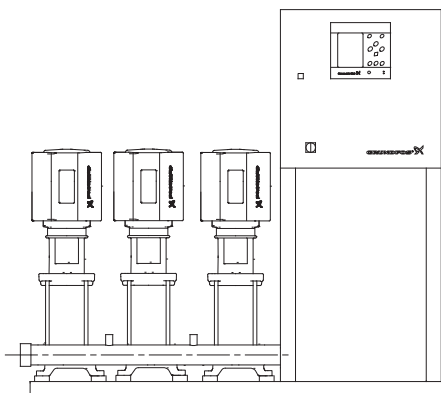

System controlled by built-in PI controller (closed loop)

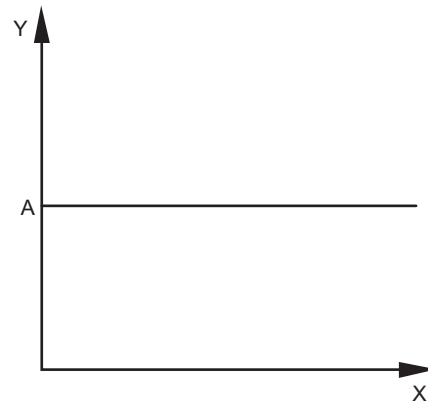

Regulation curve for closed loop

Pos.	Description
X	Time [sec]
Y	P [psi]
A	Setpoint

Setting via the operating panel

- **Operation > Further settings > Control mode > Closed loop.**

Set the setpoint. See sections Operation (2) and Alternative setpoints (2.1.3).

Open loop

In open-loop control mode, the pumps run at a fixed speed. The pump speed is calculated from the performance set by the user (0-100 %). The pump performance in percentage is proportional with the flow rate.

Open-loop control mode is usually used when the system is controlled by an external controller which controls the performance via an external signal. The external controller could for instance be a building management system connected to the MPC system. In such cases MPC is like an actuator.

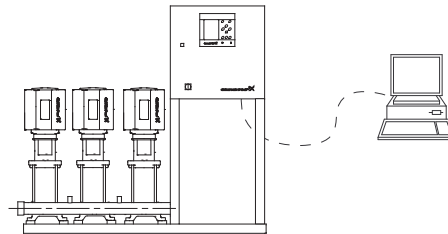

System with external controller (open loop)

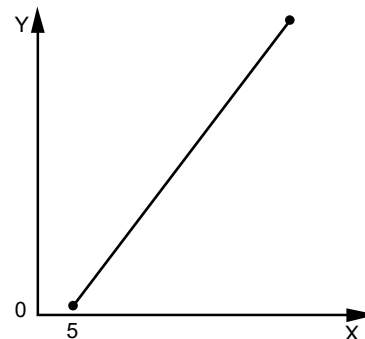

Regulation curve for open loop

2-1-2_TM032283_083

TM032231

TM078140

TM032232

TM032391

Pos.	Description
X	Input [%] from external controller
Y	Flow rate [m ³ /h]

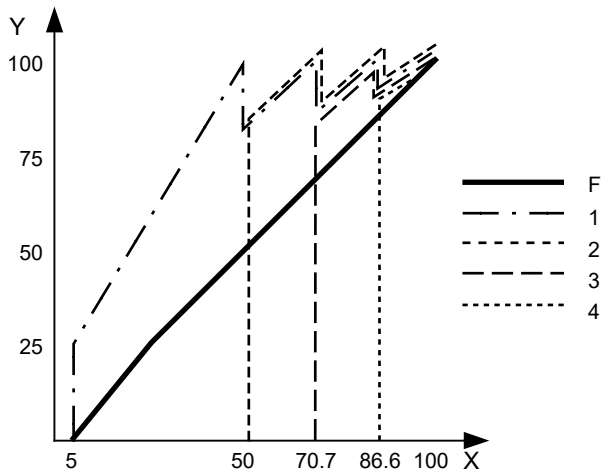

Regulation curve for MPC-E system in open loop

Pos.	Description
X	Flow rate [m ³ /h]
Y	Input [%] from external controller
F	Flow rate
1-4	Pump 1-4

Setting range

These settings must be made in connection with open loop:

- **Open loop**
- **Set setpoint 1, open loop**
- **External setpoint influence**
- **Normal.**

Setting via the operating panel

Proceed as follows to set an external control source to control the system:

- **Operation > Further settings > Control mode.**
 - Select: **Open loop.**
1. Press **↵** × 2.
 2. Select: **Stop**
 3. Set to 100 %: **Set setpoint 1, open loop.**
 4. **Settings > Primary controller > External setpoint influence > Go to setting of analog input.**
 5. Select **Settings** analog input and range.
 6. Select:
 - **Measured input value.** Display 4.3.8.1.1 appears.
 - Select: **0-100 % signal.**
 7. Press **↵** .
 8. Set the minimum and maximum sensor value.
 9. Press **↵** × 2
 10. Select:
 - **Input value to be influenced by**
 - **0-100 % signal.**
 11. Press **↵** .
 12. Select: **Set the influence function.** See also section Setting of influence function (4.1.3.2).
 13. Set the number of points.

14. Set for Point 1:

- **External input value**
- **Reduce setpoint to**

15. Repeat step 14 for all selected points.

16. Press **↵** .

17. Set as seconds: **Filter time.**

18. Select: **Enabled.**

19. Press **↵** × 2.

20. Select:

- **Operation**
- **Normal.**

The system can now be controlled by an external controller.

Factory settings

Closed loop.

Related information

[8.4 Operation \(2\)](#)

[8.4.4 Alternative setpoints \(2.1.3\)](#)

[8.6.6 Setting of influence function \(4.1.3.2\)](#)

8.4.4 Alternative setpoints (2.1.3)

Status	Operation	Alarm	Settings
2.1.3 - Alternative setpoints			
Set the setpoints.			
Closed loop			
Setpoint 1			5.0bar
Setpoint 2			3.3bar
Setpoint 3			3.5bar
Setpoint 4			3.8bar
Setpoint 5			4.0bar
Setpoint 6			4.3bar
Setpoint 7			4.5bar
Open loop			
Setpoint 1			10%
Setpoint 2			20%
Setpoint 3			30%
Setpoint 4			40%
Setpoint 5			50%
Setpoint 6			60%
Setpoint 7			70%
2017-04-05 14:22			

2-1-3_TM038952_084

Alternative setpoints

Description

In addition to the primary setpoint 1, shown in display 2 in menu **Operation**, you can set six alternative setpoints for closed-loop control mode. Furthermore, you can set seven setpoints for open-loop control mode.

You can activate one of the alternative setpoints by means of external contacts. See sections Alternative setpoints (4.1.2) and Alternative setpoints 2-7 (4.1.2.1 - 4.1.2.7).

Setting range

The setting range of setpoints for closed-loop control mode depends on the range of the primary sensor. See section Primary sensor (4.1.4).

In open-loop control mode, the setting range is 0-100 %.

Setting via the operating panel

- **Operation > Further settings > Alternative setpoints.**

Set the setpoint.

Factory settings

Setpoint 1 for closed-loop control mode is a value suitable for the system in question.

The alternative setpoints for closed-loop control mode are 44 psi (3 bar).

All setpoints for open-loop control mode are 70 %.

Related information

- [8.6.3 Alternative setpoints \(4.1.2\)](#)
- [8.6.4 Alternative setpoints 2-7 \(4.1.2.1 - 4.1.2.7\)](#)
- [8.6.7 Primary sensor \(4.1.4\)](#)

8.4.5 Individual pump control (2.1.4)

Status	Operation	Alarm	Settings
2.1.4 - Individual pump control			
Select the pump			
Pump 1	Auto	Normal	
Pump 2	Auto	Normal	
Pump 3	Auto	Normal	
Backup pump	Auto	Stop	
2017-04-05 14:22			

2-1-4_TM038953_081

Individual pump control

Description

You can change the operating mode from automatic operation to one of the manual operating modes.

Auto

The pumps are controlled by the PI controller, ensuring that the system delivers the required performance.

Manual

The pump is not controlled by the PI controller, but set to one of the following manual operating modes:

- **Max.**
 - The pump runs at a set maximum speed. This operating mode can only be selected for variable-speed pumps.
- **Normal**
 - The pump runs at a set speed.
- **Min.**
 - The pump runs at a set minimum speed. This operating mode can only be selected for variable-speed pumps.
- **Stop**
 - The pump has been forced to stop.

Pumps in manual operation are not part of the normal pump cascade and speed control. The manual pumps are a 'disturbance' of the normal operation of the system.

If one or more pumps are in manual operation, the system may not be able to deliver the set performance.

There are two displays for the function. In the first display, select the pump to be set, and in the next display, select the operating mode.

Setting range

All pumps can be selected.

Setting via the operating panel

Operation > Further settings > Individual pump control.

8.4.6 Pump 1-6 (2.1.4.1 - 2.1.4.6)

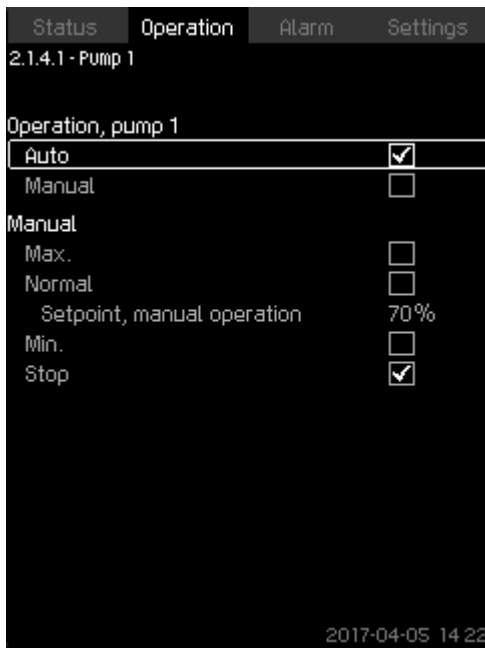

2-1-4-1_TM038954_013

Pump 1 -6**Description**

The display is shown for the individual pumps and it allows you to set an operating mode.

Setting range

You can select **Auto** or **Manual** as well as the operating mode of the pump for manual operation - **Max.**, **Normal**, **Min.** or **Stop**. For mains-operated pumps, you can only select **Normal** or **Stop**.

Setting via the operating panel

- **Operation > Further settings > Individual pump control.**

1. Select pump.
2. Select resetting: **Auto** or **Manual**.
3. **Manual:** Select operating mode.
 - **Normal:** Set the setpoint.

Factory settings

Auto.

8.4.7 Operation, pilot pump (2.1.4.7)

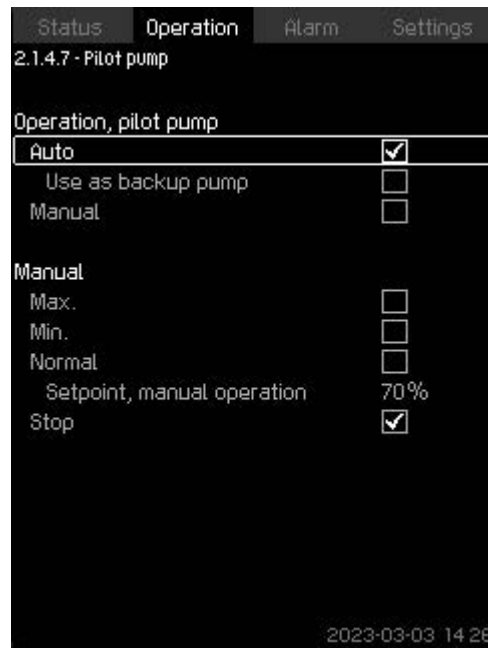

TM083481

Operation, pilot pump**Description**

The display is only shown in systems that have been configured with a pilot pump.

You can set the operating mode to **Auto** or **Manual**.

Setting range• **Auto**

In auto mode, the pump will be allowed to run and controlled by the CU 352 and will start and stop according to the settings in menu (4.3.2).

If **Use as back-up pump** is selected, the pilot pump will start when all the main pumps are running 100 % and cannot be able to maintain the setpoint.

• **Manual**

If manual operation is selected, it can be in the following modes:

- **Max.:** The pilot pump is running maximum speed.
- **Min.:** The pilot pump is running minimum speed.
- **Normal:** The pilot pump will run with the speed set in **Setpoint, manual operation**.
- **Stop:** The pilot pump will be stopped.

Setting via the operating panel

- **Operation > Further settings > Individual pump control > Pilot pump.**

8.5 Alarm (3)

This menu gives an overview of alarms and warnings.

You can reset alarms.

8.5.1 Alarm status (3)



3_TM032291_003

Alarm status

Description

A fault in the system or one of the components monitored can cause an alarm (⊗) or a warning (△). Besides the fault signal via the alarm and warning signal relay and the red indicator light on CU 352, an alarm can also cause a change of operating mode, for instance from **Normal** to **Stop**. A warning only causes a fault indication.

The table shows the possible causes of fault together with an alarm code, and whether they result in an alarm or a warning. It also shows to what operating mode the system will change in case of alarm, and whether restarting of the system and resetting of the alarm is manual or automatic.

The table also shows that the reaction to some of the fault causes mentioned can be set in the menu **Settings**. See sections Soft pressure build-up (4.3.3) and Monitoring functions (4.4) to Pressure relief (4.4.8).

Fault	Warning (△) Alarm (⊗)	Change of operating mode to	Resetting of alarm, restarting	Set in the menu Settings	Alarm code
Water shortage	△		Manual/ automatic	X	206
Water shortage	⊗	Stop	Manual/ automatic	X	214
Pressure high	⊗	Stop	Manual/ automatic	X	210
Pressure low	△		Manual/ automatic	X	211
	⊗	Stop	Manual/ automatic		

Fault	Warning (△) Alarm (⊗)	Change of operating mode to	Resetting of alarm, restarting	Set in the menu Settings	Alarm code
Pressure relief	△		Manual/ automatic	X	219
Alarm, all pumps	⊗	Stop	Automatic		203
External fault	△		Manual/ automatic	X	3
	⊗	Stop	Manual/ automatic		
Dissimilar sensor signals	△		Automatic		204
Fault, primary sensor	⊗	Stop	Automatic		89
Fault, sensor	△		Automatic		88
Communication fault	△		Automatic		10
Phase failure	△		Automatic		2
Undervoltage, pump	△		Automatic		7, 40, 42, 73
Overvoltage, pump	△		Automatic		32
Overload, pump	△		Automatic		48, 50, 51, 54
Motor temperature too high	△		Automatic		64, 65, 67, 70
Other fault, pump	△		Automatic		76, 83
Internal fault, CU 352	△		Automatic		83, 157
Internal fault, IO 351	⊗	Stop	Automatic		72, 83, 157
VFD not ready	△		Automatic		213
Fault, ethernet	△		Automatic		231, 232
Limit 1 exceeded	△⊗		Manual/ automatic	X	190
Limit 2 exceeded	△⊗		Manual/ automatic	X	191
Pressure buildup fault	△⊗		Manual/ automatic	X	215
Pumps outside duty range	△		Manual/ automatic	X	208
Fault, pilot pump	△		Automatic		216
Multisensor fault	⊗		Automatic		143
Multisensor value exceeds limits	△		Automatic	X	87
Signal fault, secondary sensor	△		Automatic	X	93
Non-return valve fault	△		Manual/ automatic	X	209
Non-return valve fault	⊗		Manual/ automatic	X	209

Related information

[8.6.24 Soft pressure build-up \(4.3.3\)](#)

[8.6.53 Monitoring functions \(4.4\)](#)

[8.6.63 Pressure relief \(4.4.8\)](#)

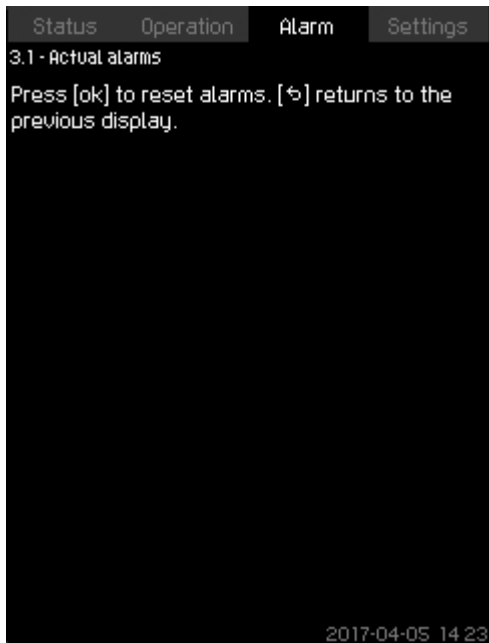
8.5.2 Actual alarms (3.1)

3-1_TM032293_011

Actual alarms**Description**

The submenu in the display **Alarm** shows the following:

- Warnings \triangle caused by faults that still exist.
- Warnings \triangle caused by faults that have disappeared, but the warning requires manual resetting.
- Alarms \otimes caused by faults that still exist.
- Alarms \otimes caused by faults that have disappeared, but the alarm requires manual resetting.

All warnings and alarms with automatic resetting are automatically removed from the menu when the fault has disappeared.

Alarms requiring manual resetting can be reset in this display by pressing [OK]. An alarm cannot be reset until the fault has disappeared.

For every warning or alarm, the following is shown:

- Whether it is a warning \triangle or an alarm \otimes .
- Where the fault occurred: **System, Pump 1, Pump 2**, etc.
- In case of input-related faults, the input is shown.
- The cause of the fault and the alarm code in brackets, such as "Water shortage (214)".
- When the fault occurred: **Date and time**.
- When the fault disappeared: **Date and time**. If the fault still exists, date and time are shown as "--...--".

The most recent warning or alarm is shown at the top of the display.

8.5.3 Alarm log (3.2)

The alarm log can store up to 24 warnings and alarms.

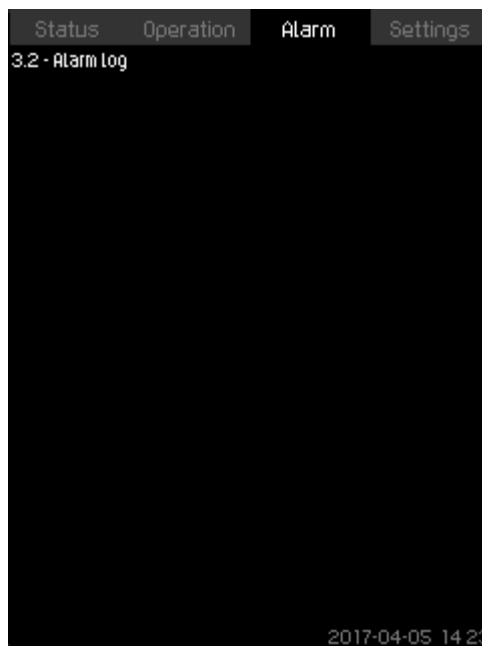

3-2_TM032292_060

Alarm log**Description**

The display shows warnings and alarms.

For every warning or alarm, the following is shown:

- Whether it is a warning \triangle or an alarm \otimes .
- Where the fault occurred: **System, Pump 1, Pump 2**, etc.
- In case of input-related faults, the input is shown.
- The cause of the fault and the alarm code in brackets, such as "Water shortage (214)".
- When the fault occurred: **Date and time**.
- When the fault disappeared: **Date and time**. If the fault still exists, date and time are shown as "--...--".

The most recent warning or alarm is shown at the top of the display.

8.5.4 Service contact information (3.3)

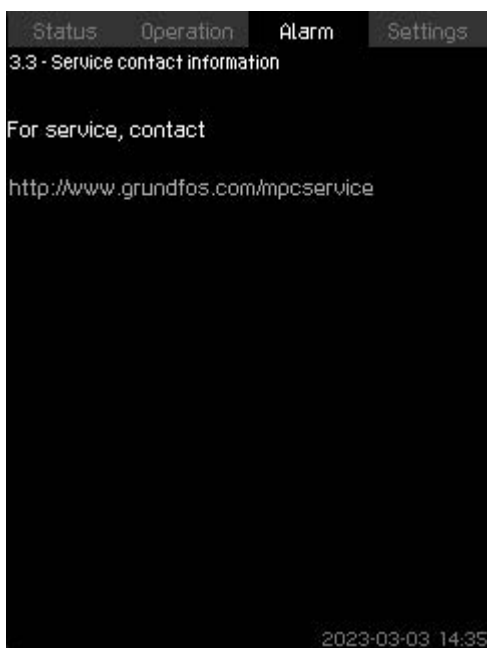

3-3_TM052968_173

Service contact information

Description

The display shows the contact information of the installer if entered during commissioning.

8.6 Settings (4)

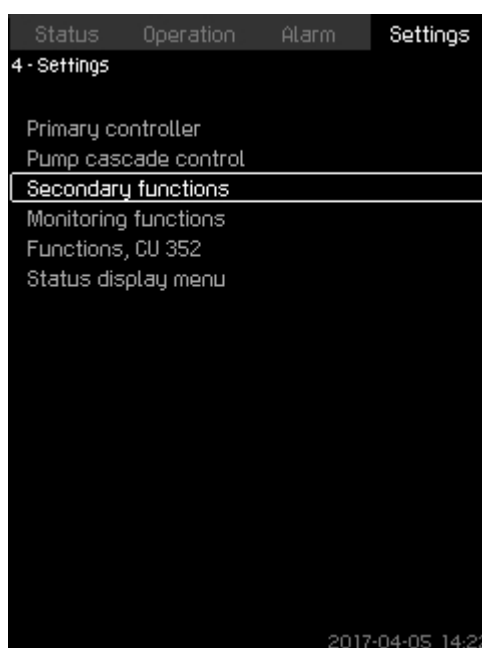

4_TM032294_004

Settings

In the **Settings** menu, you can set the following functions:

- **Primary controller**
PI controller, Alternative setpoints, External setpoint influence, Primary sensor, Secondary sensor, Clock program, Proportional pressure, S-system configuration, Setpoint ramp.
- **Pump cascade control**
Min. time between start/stop, Max. number of starts/hour, Number of standby pumps, Forced pump changeover, Pump test run, Pump stop attempt, Pump start and stop speed, Min. performance, Compensation for pump start-up time.
- **Secondary functions**
Stop function, Pilot pump, Soft pressure build-up, Digital inputs, Analog inputs, Digital outputs, Analog outputs, Counter inputs, Emergency run, Min., max. and user-defined duty, Pump curve data, Control source, Fixed inlet pressure, Flow estimation, Reduced operation, Multisensor settings.
- **Monitoring functions**
Dry-running protection, Min. pressure, Max. pressure, External fault, Limit 1 exceeded, Limit 2 exceeded, Pumps outside duty range, Pressure relief, Log values, Fault, feedback sensor, Non-return valve.
- **Functions, CU 352**
Display language, Units, Date and time, Password, Ethernet, GENbus number, Software status, Display 1, Display 2, Display 3.
- The service language, English, can be selected for service purposes. All these functions are usually set correctly when the system is switched on.

8.6.1 Primary controller (4.1)

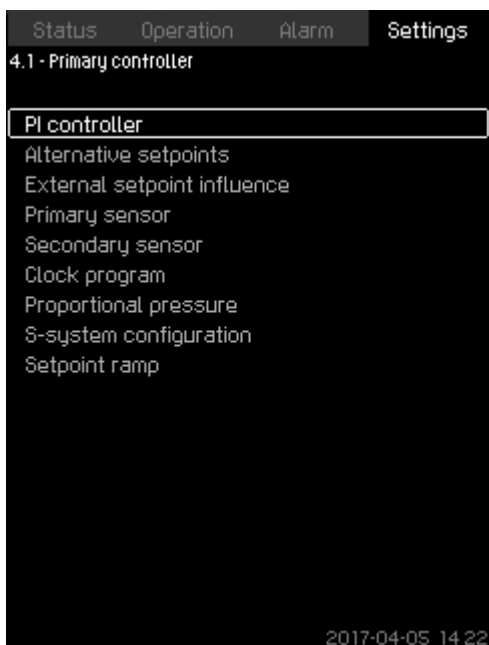

4-1_TM038955_066

Primary controller

Description

In the menu, you can set the functions related to the primary controller. It is only necessary to make settings in this menu if the functionality is to be expanded with one of the functions below:

- **PI controller**
- **Alternative setpoints**
- **External setpoint influence**
- **Primary sensor**
- **Secondary sensor**
- **Clock program**
- **Proportional pressure**
- **S-system configuration.**

8.6.2 PI controller (4.1.1)

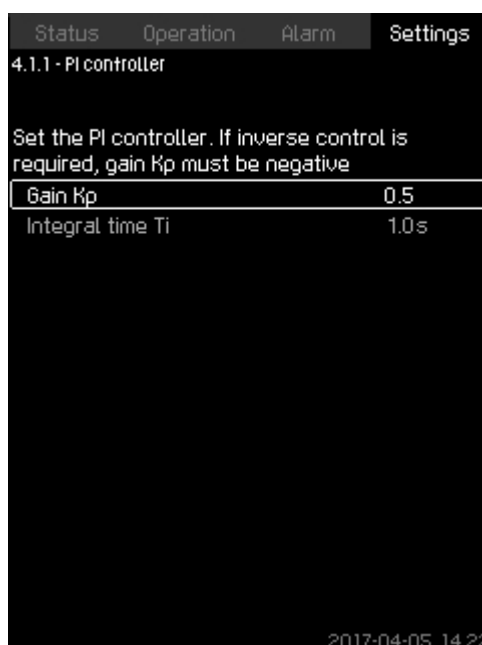

4-1-1_TM032387_060

PI controller

Description

The system includes a standard PI controller which ensures that the pressure is stable and corresponds to the setpoint.

You can adjust the PI controller if a faster or slower reaction to changes of consumption is required.

To obtain a faster reaction, increase Kp and reduce Ti.

To obtain a slower reaction, reduce Kp and increase Ti.

Setting range

- **Gain Kp:** -30 to 30. **Note:** For inverse control, set Kp to a negative value.
- **Integral time Ti:** 0.1 to 3600 seconds.

Setting via the operating panel

- **Settings**
- **Primary controller**
- **PI controller.**

1. Set **Gain Kp** and **Integral time Ti**.

Usually it is not necessary to adjust Kp.

Factory settings

The setting of Kp and Ti depends on the system and application.

PI controller settings for pressure boosting

If the application has been set to pressure boosting in the startup wizard, the following values of Kp and Ti are set automatically:

- Kp: 0.5
- Ti: 1 second.

PI controller settings for heating and cooling

If another application than pressure boosting has been selected in the startup wizard, the values of Kp and Ti are set automatically according to the table below. As the system does not know the pipe length, the default parameters are set according to the table to a pipe length (L1 or L2) of 16 ft (5 m).

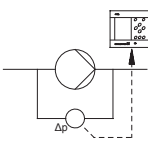
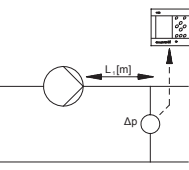
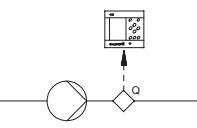
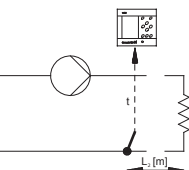
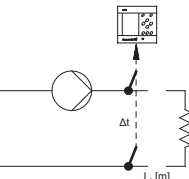
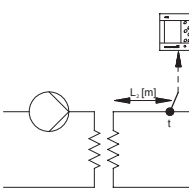
System/application	Kp		Ti [seconds]
	Heating system ⁵⁾	Cooling system ⁶⁾	
	0.5		1
	0.5		L1 < 16 ft (5 m): 1 L1 > 16 ft (5 m): 3 L1 > 33 ft (10 m): 5
	0.5		1
	0.5	-0.5	10 + 5L2
	0.5		10 + 5L2
	0.5	-0.5	30 + 5L2

- 5) Heating systems are systems in which an increase in pump performance will result in a temperature rise at the sensor.
- 6) Cooling systems are systems in which an increase in pump performance will result in a temperature drop at the sensor.

L1: Distance [ft (m)] between pump and sensor.
 L2: Distance [ft (m)] between heat exchanger and sensor.
 ΔP: Measurement of differential pressure.
 Q: Measurement of flow rate.
 t: Measurement of temperature.
 Δt: Measurement of differential temperature.

8.6.3 Alternative setpoints (4.1.2)

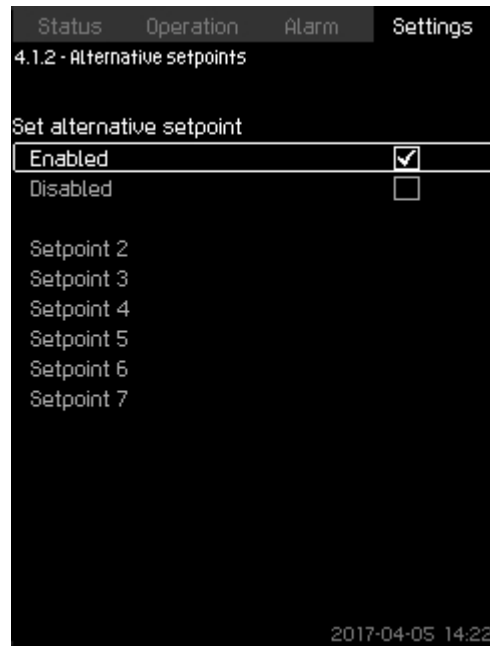

4-1-2_TM032383_067

Alternative setpoints

Description

The function allows you to select up to six setpoints (2 to 7) as alternatives to the primary setpoint (1). The primary setpoint (1) is set in the menu **Operation**.

Every alternative setpoint can be addressed manually to a separate digital input (DI). When the contact of the input is closed, the alternative setpoint applies.

If more than one alternative setpoint has been selected, and they are activated at the same time, CU 352 selects the setpoint with the lowest number.

Setting range



If the multisensor function is enabled, it will have higher priority than the alternative setpoint which will be overruled.

- Six setpoints, numbers 2 to 7.

Factory settings

No alternative setpoints have been selected.

8.6.4 Alternative setpoints 2-7 (4.1.2.1 - 4.1.2.7)

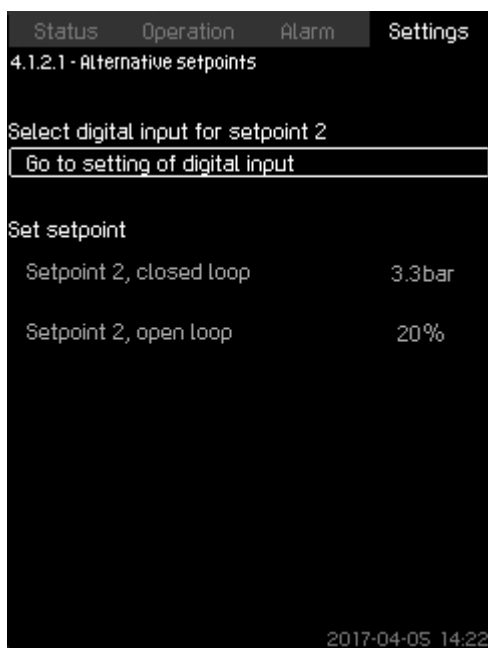

4-1-2-1_TM032384_068

Alternative setpoints 2-7

For each alternative setpoint, select the digital input to activate the setpoint.

You can set a setpoint for closed loop and for open loop.

Setting via the operating panel

- **Settings > Primary controller > Alternative setpoints.**

1. Select alternative setpoint.
2. Select: **Go to setting of digital input**. Display **Digital inputs** (4.3.7) appears.
3. Set the input.
4. Press **↵**.
5. Select the menu line of the setpoint (closed or open loop).
6. Set the setpoint. Set both setpoints if the system is to be controlled both in open and closed loop.

Factory settings

No alternative setpoints have been set.

Related information

[8.6.26 Digital inputs \(4.3.7\)](#)

8.6.5 External setpoint influence (4.1.3)

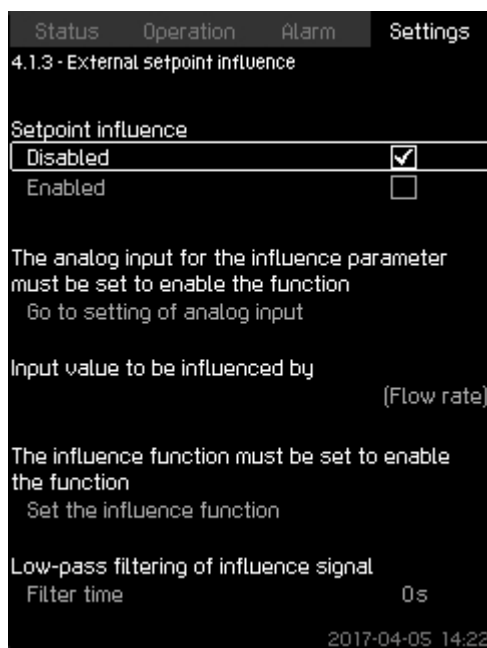

4-1-3_TM038856_100

External setpoint influence

Description

The function allows you to adapt the setpoint by letting measuring parameters influence the setpoint. Typically an analog signal from a flow or temperature transmitter, or a similar transmitter. For an overview of transmitter types and possible positions, see installation and operating instructions for Control MPC.

As an example, the setpoint can be adapted to parameters that can influence the outlet pressure or temperature of the system. The parameters which influence the performance of the system are shown as a percentage from 0 to 100 %. They can only reduce the setpoint, as the influence as a percentage divided with 100 is multiplied with the setpoint:

Actual setpoint (SP) = selected setpoint × influence (1) × influence (2) × etc.

The influence values can be set individually.

A low-pass filter ensures smoothing of the measured value which influences the setpoint. This results in stable setpoint changes.

Setting range

- 0-100 % signal
- Inlet pressure
- Outlet pressure
- External pressure
- Diff. pressure, external
- Diff. pressure, pump
- Flow rate
- Tank level, outlet side
- Tank level, suction side
- Return-pipe temp., external
- Flow-pipe temperature
- Return-pipe temperature
- Differential temperature
- Ambient temperature
- Differential temperature.

Setting via the operating panel

- **Settings > Primary controller > External setpoint influence > Input value to be influenced by.** A list of available parameters appears.
 1. Select the parameter which is to influence the setpoint.
 2. Press \leftarrow .
 3. Set the influence function. See section Setting of influence function (4.1.3.2).
 4. Set the number of points.
 5. Set: **External input value** (Point 1).
 6. Set as a percentage: **Reduce setpoint to** (Point 1).
 7. Repeat steps 4 to 6 for all desired parameters.
 8. Press \leftarrow .
 9. Set as seconds: **Filter time**.
 10. Select: **Enabled**.

Factory settings

The function is disabled.



If the Multisensor function is enabled, it will have a higher priority than the **External setpoint influence** which will be overruled.

Related information

[8.6.6 Setting of influence function \(4.1.3.2\)](#)

8.6.6 Setting of influence function (4.1.3.2)

Point	External input value	Reduce setpoint to
1	10.1m ³ /h	12%
2	20.2m ³ /h	40%
3	30.2m ³ /h	50%
4	40.3m ³ /h	100%

4-1-3-2_TM032389_101

Setting of influence function

Description

You can select the relation between the measuring parameter which is to influence the setpoint and the desired influence as a percentage.

The relation is set by entering values in a table with maximum eight points by means of the operating panel.

Example:

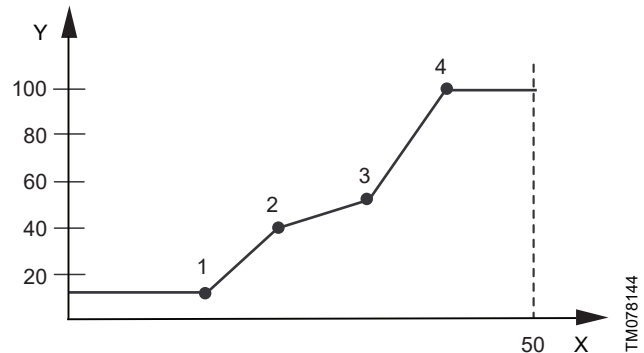

Relation between setpoint influence and flow rate

Pos.	Description
X	Flow rate [gpm]
Y	Setpoint influence [%]

The control unit draws straight lines between the points. A horizontal line is drawn from the minimum value of the relevant sensor (0 gpm in the example) to the first point. This is also the case from the last point to the sensor's maximum value (example 50 gpm).

Setting range

Two to eight points can be selected. Each point contains the relation between the value of the parameter which is to influence the setpoint and the influence of the value.

Setting via the operating panel

- **Settings > Primary controller > External setpoint influence.**
 1. Set the influence function.

- Set the number of points.
- Set: **External input value** (Point 1).
- Set as a percentage: **Reduce setpoint to** (Point 1).
- Repeat steps 2 to 4 for all desired parameters.

Factory settings

The function is disabled.

8.6.7 Primary sensor (4.1.4)

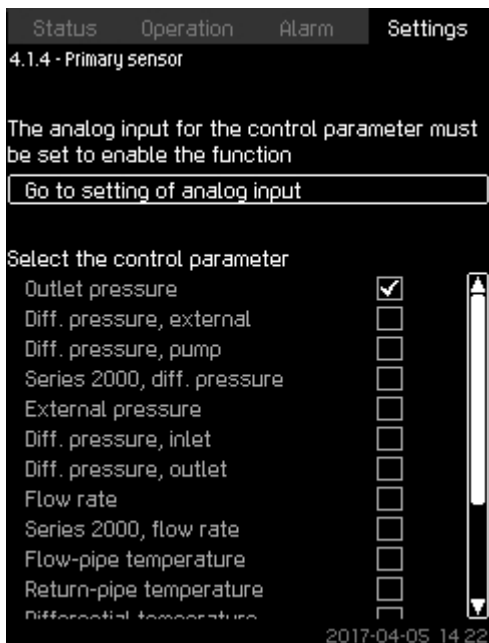

4-1-4_TM038958_073

Primary sensor

Description

You can select the control parameter of the system and set the sensor to measure the value.

Setting range

- **Outlet pressure**
- **Diff. pressure, external**
- **Diff. pressure, pump**
- **Series 2000, diff. pressure**
- **External pressure**
- **Diff. pressure, inlet**
- **Diff. pressure, outlet**
- **Flow rate**
- **Series 2000, flow rate**
- **Flow-pipe temperature**
- **Return-pipe temperature**
- **Differential temperature**
- **Ambient temperature**
- **Return-pipe temp., external**
- **0-100 % signal**
- **Not used.**

Setting via the operating panel

- **Settings > Primary controller > Primary sensor > Go to setting of analog input.** Display **Analog inputs** (4.3.8) appears.
- Select analog input (AI) for the primary sensor and set the parameters.
 - Press ↵.

- Select control parameter for the primary sensor.

Factory settings

The primary parameter is the outlet pressure. The sensor is connected to AI1 (CU 352). Other primary parameters can be selected in the startup wizard.

Related information

[8.6.28 Analog inputs \(4.3.8\)](#)

8.6.8 Secondary sensor (4.1.5)



4-1-5_SECONDARY_SENSOR_091

Secondary sensor

Description

The function is designed for optimizing the constant-pressure control, where there is a high dynamic friction loss. The function enables the possibility of placing a primary sensor on the critical point in the system.

The sensor needs to be hardwired back to the controller, and will act as primary sensor hence utilizing the normal **Setpoint** setting.

The **Secondary sensor** is then the "local" sensor placed on the system manifold close to the control cabinet.

In case of a fault on the **Primary sensor**, the **Secondary sensor** will automatically take over using its specified **Setpoint**. The difference between the setpoint of the **Primary sensor** and the **Secondary sensor** is equal to the total pressure losses between the two sensors at maximum flow.

Setting range

- **Enabled** or **Disabled** function
- Setting of analog input
 - Setting of **Measured value from secondary sensor**
 - Setting of **Setpoint**

Setting via the operating panel

- **Settings > Primary controller > Secondary sensor**
- Enable the function.
 - Define the analog input used for **Secondary sensor**.
 - Define **Measured value from secondary sensor**.
 - Define **Setpoint** for **Secondary sensor** operation.

8.6.9 Clock program (4.1.6)

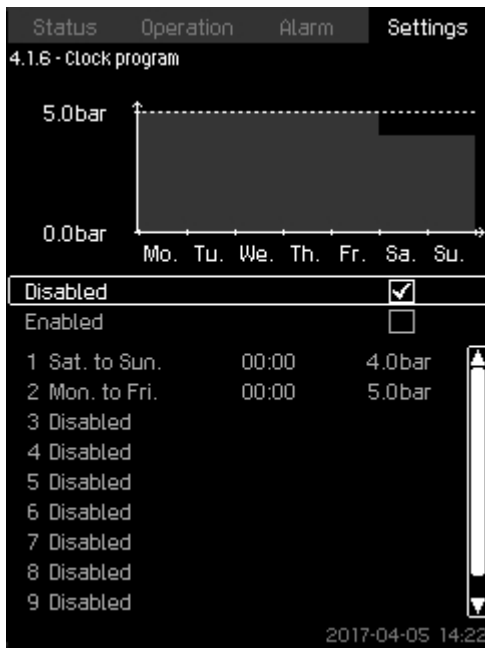

4-1-6_TM038990_129

Clock program

Description

With the function, you can set setpoints and day and time for their activation. You can also set day and time for stop of the system. If the clock program is disabled, the setpoint of the program will remain active.



Minimum two events are required when activating the clock program: one to start the system and one to stop the system.



If the Multisensor function is enabled, it will have a higher priority than the Clock program which will be overruled.

Setting range

- Activation and setting of event.

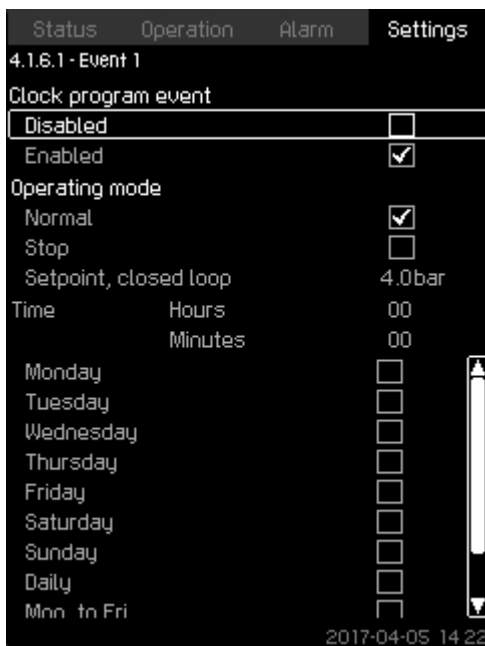

4-1-6-1_TM038959_119

Event 1

Setting via the operating panel

- **Settings > Primary controller > Clock program.**

1. Enable the function.
2. Select and enable one of the ten events.
3. Select: **Normal** or **Stop**. Skip step 4 if you select **Stop**.
4. Set: **Setpoint, closed loop**.
5. Set: **Time, Hours, Minutes**.
6. Select the day of week on which the settings are to be activated.
7. Select: **Enabled**.
8. Repeat steps 2 to 7 if several events are to be enabled. **Note:** Up to ten events can be set.
9. Press ↵.
10. Select: **Enabled**.

Factory settings

The function is disabled.

8.6.10 Proportional pressure (4.1.7)

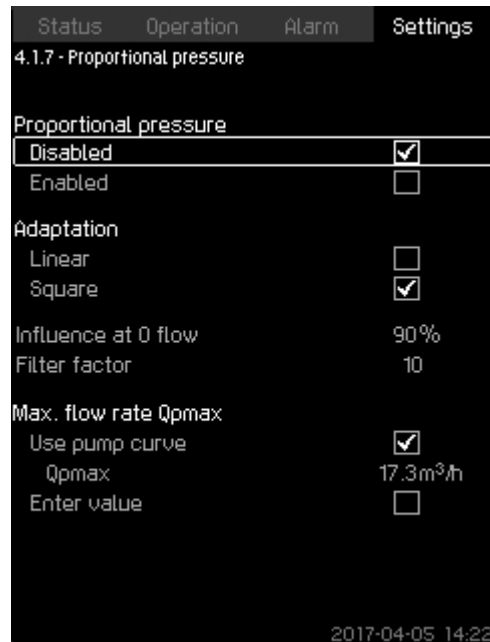

4-1-7_TM038960_130

Proportional pressure

Description

The function can only be enabled in pressure-controlled systems and it automatically adapts the setpoint to the actual flow rate to compensate for flow-dependent dynamic losses. As many systems are designed with extra flow capacity, the estimated maximum flow rate (**Qpmax**) can be entered manually. In systems with CR pumps, the pump curves can be used to calculate the maximum flow rate at the selected setpoint. Set a filter factor to prevent fluctuation.



If the multisensor function is enabled, it will have a higher priority than the proportional pressure which will be overruled.

The adaptation can be linear or square.

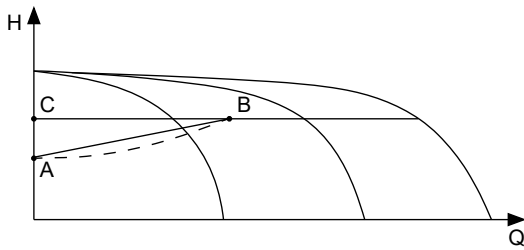

TM053000

Proportional pressure

Pos.	Description
A	Pressure at zero flow. Starting point of proportional-pressure control (influence at zero flow = x % of setpoint)
B	Qpmax
C	Setpoint

The function has these purposes:

- to compensate for pressure losses
- to reduce the energy consumption
- to increase the comfort for the user.

Setting range

- Selection of control mode
- **Influence at 0 flow**
- **Estimated flow rate**
- **Filter factor.**

Setting via the operating panel

- **Settings > Primary controller > Proportional pressure.**
1. Select: **Enabled.**
 2. Select:
 - **Adaptation**
 - **Linear** or **Square.**
 3. Set: **Influence at 0 flow.**
 4. Set: **Filter factor.**
 5. Select: **Use pump curve** or **Enter value.**
 6. Set **Qpmax** if you select **Enter value.**

Factory settings

The function is disabled.

8.6.11 Setpoint ramp (4.1.9)



4-1-9_TM052969_174

Setpoint ramp

Description

When the function is enabled, setpoint changes are affected by the setpoint ramp, and the setpoint changes gradually over a period of time.

Proportional pressure or **Setpoint influence** are not affected by this function.



If the multisensor function is enabled, it will have a higher priority than the setpoint ramp which will be overruled.

Setting range

The function can be enabled and **Change per minute** can be set.

Setting via the operating panel

- **Settings > Primary controller > Setpoint ramp.**
1. Select: **Enabled.**
 2. Set: **Change per minute.**

Factory settings

The function is disabled.

8.6.12 Pump cascade control (4.2)

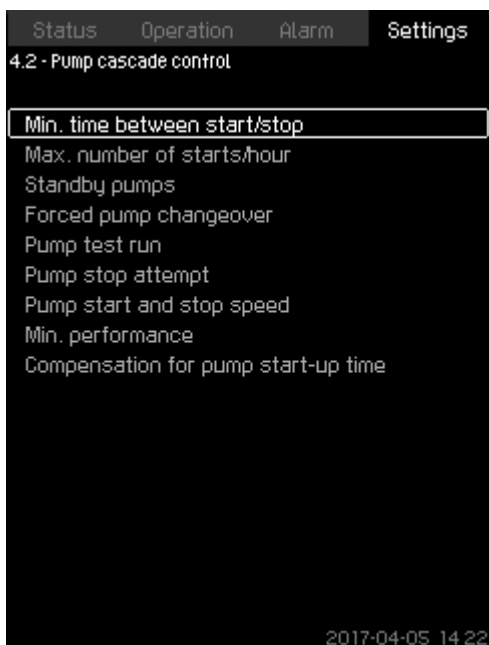

4-2_TM038962_071

Pump cascade control

In the menu, you can set the functions connected to pump cascade control.

The following menus can be selected:

- **Min. time between start/stop**
- **Max. number of starts/hour**
- **Standby pumps**
- **Forced pump changeover**
- **Pump test run**
- **Pilot pump**
- **Pump stop attempt**
- **Pump start and stop speed**
- **Min. performance**
- **Compensation for pump start-up time.**

8.6.13 Min. time between start/stop (4.2.1)

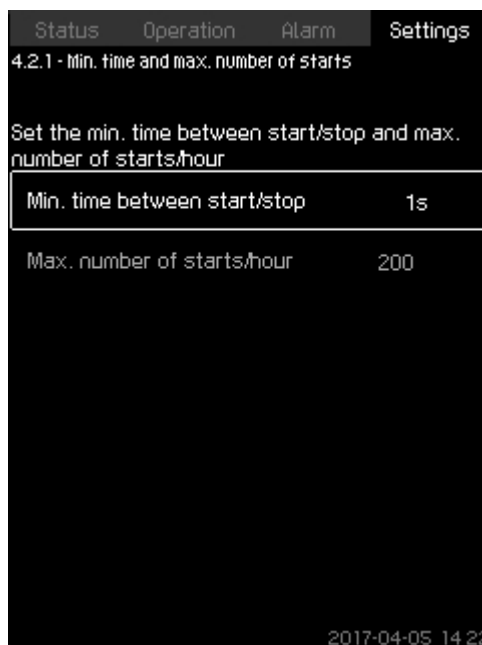

4-2-1_TM032367_074

Min. time between start/stop**Description**

The function ensures a delay between the starting and stopping of one pump and the starting and stopping of another pump.

The purpose is to prevent hunting when pumps start and stop continuously.

Setting range

From 1 to 3600 seconds.

Setting via the operating panel

Settings > Pump cascade control > Min. time between start/stop.

Factory settings

The setting is done in the startup wizard and depends on the application.

8.6.14 Max. number of starts/hour (4.2.1)



4-2-1_TM032367_074

Max. number of starts/hour**Description**

The function limits the number of pump starts and stops per hour for the complete system. It reduces noise emission and improves the comfort of systems with mains-operated pumps.

Each time a pump starts or stops, CU 352 calculates when the next pump is allowed to start/stop in order not to exceed the permissible number of starts per hour.

The function always allows pumps to be started to meet the requirement, but pump stops will be delayed, if needed, in order not to exceed the permissible number of starts per hour.

The time between pump starts must be between the minimum time between start and stop, see section Min. time between start/stop (4.2.1), and $3600/n$, n being the set number of starts per hour.

Setting range

1 to 1000 starts per hour.

Setting via the operating panel

- **Settings > Pump cascade control > Max. number of starts/hour.**

1. Set:

- **Min. time between start/stop.**
- **Max. number of starts/hour.**

Factory settings

MPC-E:	200 starts per hour
Other variants:	100 starts per hour



This function has no influence on **Stop function**.

Related information

[8.6.13 Min. time between start/stop \(4.2.1\)](#)

[8.6.22 Stop function \(4.3.1\)](#)

8.6.15 Standby pumps (4.2.3)

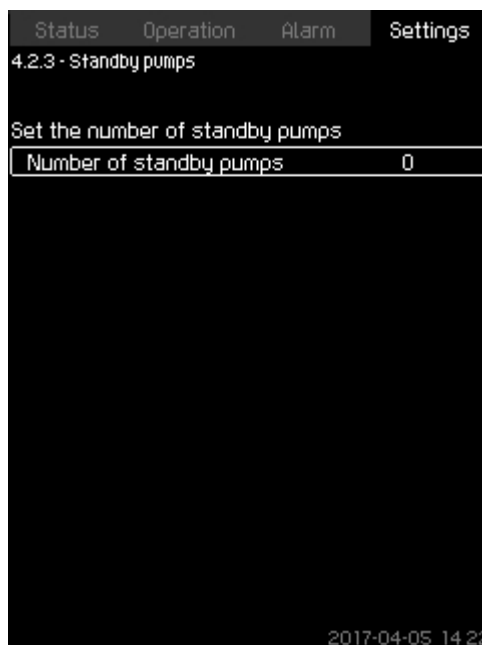

4-2-3_TM032366_075

Standby pumps**Description**

The function allows you to limit the maximum performance of the system, by selecting one or more pumps as standby pumps.

If a three-pump system has one standby pump, maximum two pumps are allowed to be in operation at a time.

If one of the two pumps in operation has a fault and has stopped, the standby pump will be started. The performance of the system is thus not reduced.

The status as standby pump alternates between all pumps.

Setting range

The number of possible standby pumps in a system is equal to the total number of pumps in the system minus 1.

Setting via the operating panel

- **Settings > Pump cascade control > Standby pumps.**
- Set: **Set the number of standby pumps.**

Factory settings

The number of standby pumps is set to zero. The function is disabled.

8.6.16 Forced pump changeover (4.2.4)

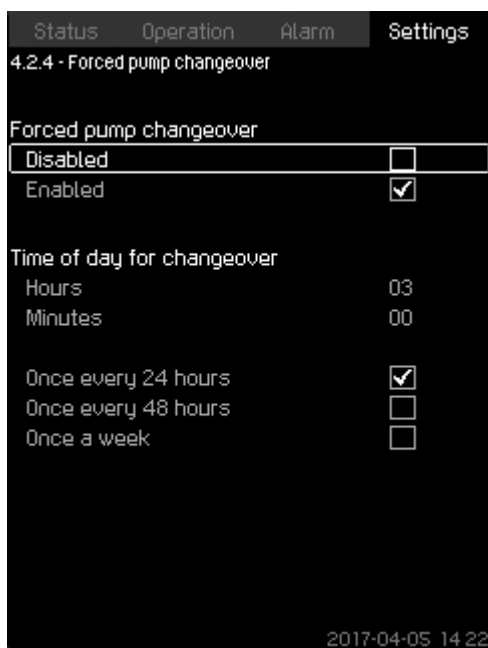

4-2-4_TM032365_058

Forced pump changeover**Description**

The function ensures that the pumps run for the same number of operating hours.

In certain applications, the requirement remains constant for long periods and does not require all pumps to run. In such situations, pump changeover does not take place naturally, and forced pump changeover may thus be required.

Once every 24 hours, CU 352 checks if any pump running has a larger number of operating hours than pumps that are stopped. If this is the case, the pump will be stopped and replaced by a pump with a lower number of operating hours.

Setting range

You can enable and disable the function. You can set the hour of the day at which the changeover is to take place.

Setting via the operating panel

- **Settings > Pump cascade control > Forced pump changeover.**
1. Select: **Enabled**.
 2. Set: **Time of day for changeover**.
 3. Select interval for pump changeover.

Factory settings

The function is enabled. The time is set to 03:00.

8.6.17 Pump test run (4.2.5)

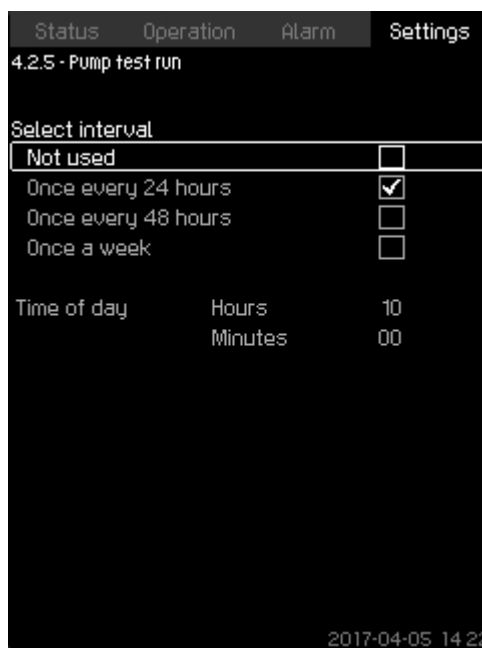

4-2-5_TM032364_057

Pump test run**Description**

The function is primarily used in situations where the forced pump changeover is disabled, and/or if the system is set to operating mode **Stop**, for instance in a period when the system is not needed. In such situations, it is important to test the pumps regularly.

Advantages of this function:

- Pumps do not seize up during a long standstill due to deposits from the pumped liquid.
- The pumped liquid does not decay in the pump.
- Trapped air is removed from the pump.

The pumps start automatically one by one and run for 5 seconds.



Pumps in operating mode **Manual** are not included in the test run. If there is an alarm, the test run will not be carried out.

Setting range

- **Time of day**
- **Day of week**
- **Include pilot pump**

Setting via the operating panel

- **Settings > Pump cascade control > Pump test run.**
1. Select interval.
 2. Set:
 - **Time of day**
 - **Minutes**.
 3. Select the day of week if you select **Once a week**.
 4. If the system is configured with a pilot or a backup pump, select **Include pilot pump**.

Factory settings

The function is disabled.

8.6.18 Pump stop attempt (4.2.7)

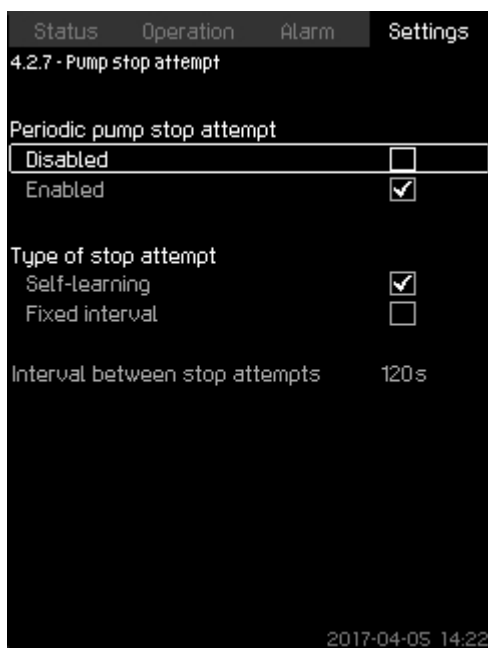

4-2-7_TM038964_146

Pump stop attempt

Description

The function allows you to set automatic stop attempts of a pump when several pumps are running. It ensures that the optimum number of pumps is always running, in terms of energy consumption. See section Pump start and stop speed (4.2.8). At the same time, the purpose is to avoid disturbances in connection with automatic stop of pumps.

Stop attempts can either take place with a fixed interval set under **Interval between stop attempts** or by self-learning. If self-learning is selected, the interval between stop attempts will be increased if repeated attempts to stop the pump fail.

Setting via the operating panel

- **Settings > Pump cascade control > Pump stop attempt.**

1. Select: **Self-learning** or **Fixed interval**.
2. Set **Interval between stop attempts** if you select **Fixed interval**.
3. Select: **Enabled**.

Factory settings

The function is enabled, and **Self-learning** is selected.

Related information

[8.6.19 Pump start and stop speed \(4.2.8\)](#)

8.6.19 Pump start and stop speed (4.2.8)

Description

The function controls the starting and stopping of pumps. There are two options:

1. Use calculated speed

This function ensures that the optimum number of pumps is always running at a desired duty point, in terms of energy consumption. CU 352 calculates the required number of pumps and their speed. This requires that the differential pressure of the pump is measured by a differential-pressure sensor or separate pressure sensors on the inlet and outlet side. If calculated speed has been selected, CU 352 ignores the percentages set.

2. Use fixed speed

The pumps are started and stopped at speeds set by the user.

1. Use calculated speed

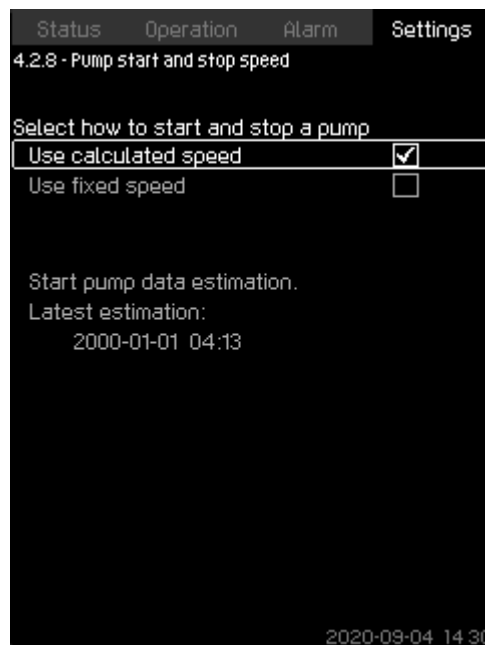

4-2-8_CALCULATED_SPEED_147

Use calculated speed

Setting via the operating panel

- **Settings > Pump cascade control > Pump start and stop speed > Use calculated speed.**

2. Use fixed speed

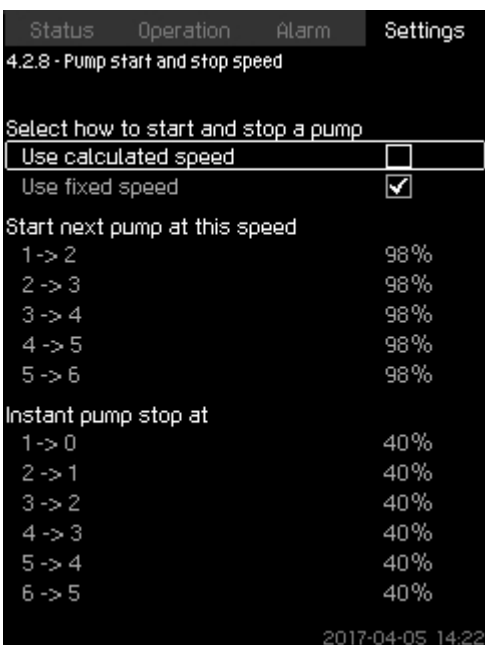

4-2-8_TMO38965_147

Use fixed speed**Setting via the operating panel**

- **Settings > Pump cascade control > Pump start and stop speed.**
- Select: **Use fixed speed.**
- Set: **Start next pump at this speed > 1 -> 2.**
 - a. Set the speed as percentage.
 - b. Set the other pumps in the same way.
- Select: **Instant pump stop at > 1 -> 0.**
 - d. Set the speed as percentage.
 - e. Set the other pumps in the same way.

Factory settings

The function is set to calculated speed.

8.6.20 Min. performance (4.2.9)

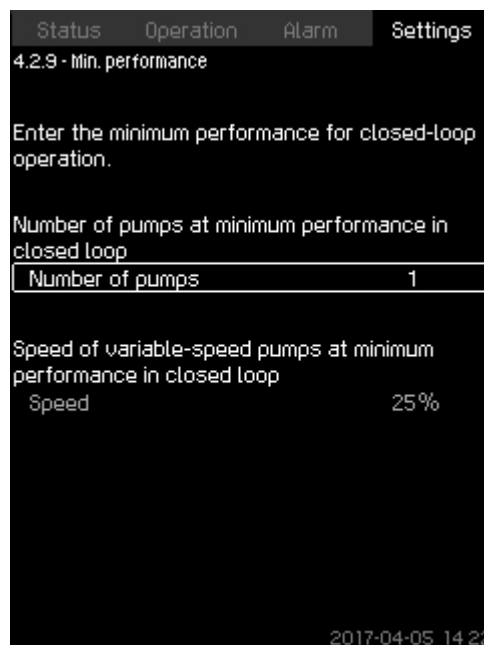

4-2-9_TMO38967_148

Min. performance**Description**

The function ensures circulation in a system. Note that the stop function, if enabled, can influence this function. See section Stop function (4.3.1). Examples:

- If zero pumps have been selected, the stop function can stop the pump if there is no or a very small consumption.
- If pumps have been selected, the stop function will not be active.

Setting via the operating panel

- **Settings > Pump cascade control > Min. performance.**
 1. Set:
 - **Number of pumps**
 - **Speed.**

Factory settings

The number of pumps is set to zero. The speed in closed loop is set to 25 %.

Related information

[8.6.22 Stop function \(4.3.1\)](#)

8.6.21 Secondary functions (4.3)

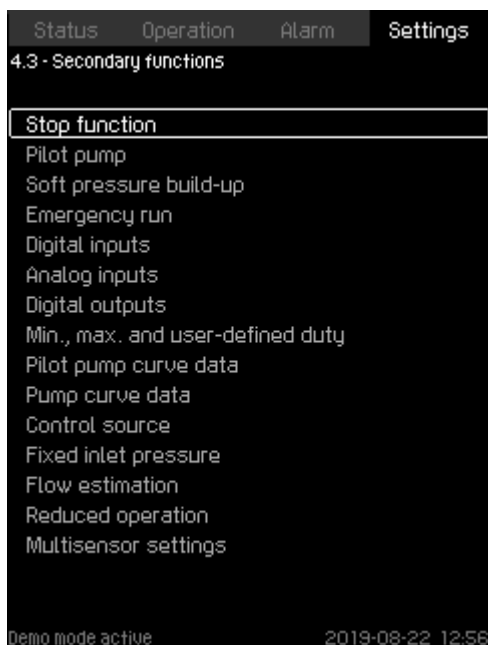

4-3_SECONDARY_FUNCTIONS

Secondary functions

Description

In the display, you can set functions that are secondary in relation to the normal operation of the system. Secondary functions are functions that offer additional functionality.

The display allows you to open these specific displays:

- Stop function (4.3.1)
 - Pilot pump (4.3.2) ⁷⁾
 - Soft pressure build-up (4.3.3)
 - Emergency run (4.3.5)
 - Digital inputs (4.3.7)
 - Analog inputs (4.3.8)
 - Digital outputs (4.3.9)
 - Analog outputs (4.3.10)
 - Counter inputs (4.3.11)
 - Min., max. and user-defined duty (4.3.14)
 - Pilot pump curve data (4.3.18)
 - Pump curve data (4.3.19)
 - Control source (4.3.20)
 - Fixed inlet pressure (4.3.22)
 - Flow estimation (4.3.23)
 - Reduced operation (4.3.24)
 - Multisensor settings (4.3.25)
- ⁷⁾ Pilot pump needs to be activated via PC Tool to be visible in **Secondary functions** display.

Related information

- [8.6.22 Stop function \(4.3.1\)](#)
- [8.6.23 Pilot pump \(4.3.2\)](#)
- [8.6.24 Soft pressure build-up \(4.3.3\)](#)
- [8.6.25 Emergency run \(4.3.5\)](#)
- [8.6.26 Digital inputs \(4.3.7\)](#)
- [8.6.28 Analog inputs \(4.3.8\)](#)
- [8.6.31 Digital outputs \(4.3.9\)](#)
- [8.6.33 Analog outputs \(4.3.10\)](#)
- [8.6.35 Counter inputs \(4.3.11\)](#)
- [8.6.36 Min., max. and user-defined duty \(4.3.14\)](#)
- [8.6.40 Pilot pump curve data \(4.3.18\)](#)
- [8.6.41 Pump curve data \(4.3.19\)](#)
- [8.6.43 Control source \(4.3.20\)](#)
- [8.6.44 Fixed inlet pressure \(4.3.22\)](#)
- [8.6.45 Flow estimation \(4.3.23\)](#)
- [8.6.46 Reduced operation \(4.3.24\)](#)
- [8.6.47 Multisensor settings \(4.3.25\)](#)

8.6.22 Stop function (4.3.1)

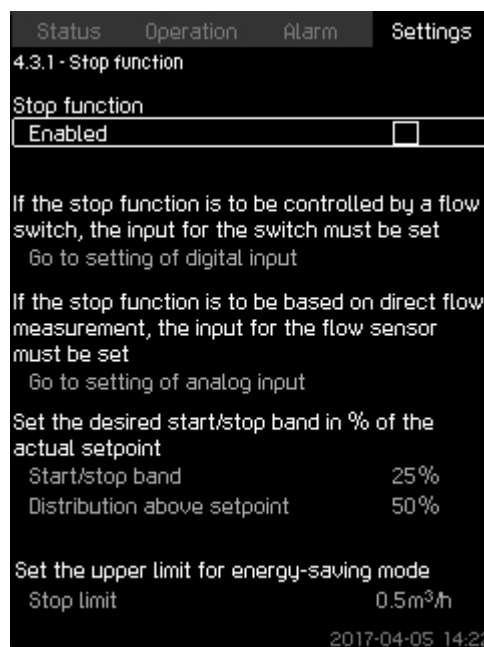

4-3-1_TM032355_102

Stop function

Description

The function is typically used in constant-pressure applications and allows you to stop the last pump if there is no or a very small consumption.

Purpose of the function:

- to save energy
- to prevent heating of shaft seal faces due to increased mechanical friction as a result of reduced cooling by the pumped liquid
- to prevent heating of the pumped liquid.



When a pilot pump is connected to the system, the stop function parameters will be valid for the pilot pump and not the main pump as the pilot pump will be the last pump in operation.

The description of the stop function applies to all systems with variable-speed pumps.

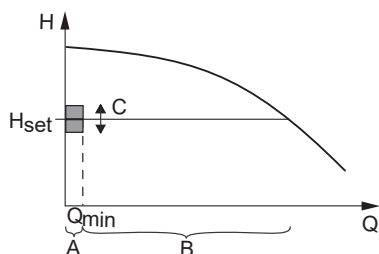

TM078147

Start/stop band

Pos.	Description
A	On/off control
B	Normal operation
C	Start/stop band

When the stop function is enabled, the operation is continuously monitored to detect a low flow rate. When CU 352 detects no or a low flow rate (Q lower than Q_{min}), it changes from constant-pressure operation to on/off control of the last pump in operation. Before stopping, the pump increases the pressure to a value corresponding to H_{set} plus (distribution above setpoint / 100) \times start/stop band. The pump is restarted when the pressure is H_{set} minus (100-distribution above setpoint) / 100 \times start/stop band. The start/stop band can be distributed around the setpoint.

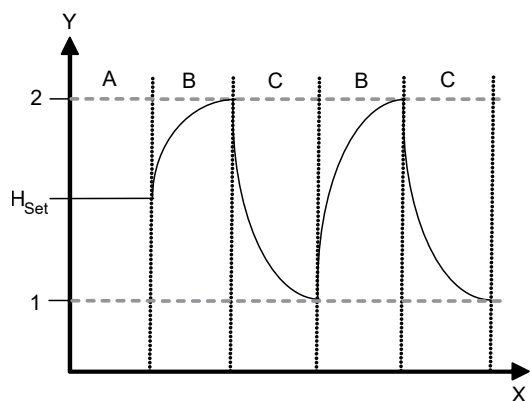

TM078148

On/off operation

Pos.	Description
1	Start: $H_{set} - 0.5 \times$ start/stop band
2	Stop: $H_{set} + 0.5 \times$ start/stop band
A	Normal operation
B	Pressure boosting
C	Stop
X	Time [sec]
Y	H [ft]

The flow rate is estimated by CU 352 when the pump is in the stop period. As long as the flow rate is lower than Q_{min} , the pump runs in on/off operation. If the flow rate is increased to above Q_{min} , the pump returns to normal operation, H_{set} . H_{set} is equal to the actual setpoint. See section Setpoint (1.2.2).

Detection of low flow rate

Low flow rate can be detected in two ways:

- direct flow measurement with a flowmeter or flow switch
- estimation of flow rate by measurement of pressure and speed.

If the system is not connected to a flowmeter or flow switch, the stop function will use the estimating function.

If the detection of low flow rate is based on flow estimation, a diaphragm tank of a certain size and with a certain precharge pressure is required.

For further information, see the document below. The document is also available on Grundfos Product Center.

Title	QR code	Link	Publication number
Tank calculation in E systems		http://net.grundfos.com/qr/i/92845021	92845021

Precharge pressure

Hydro MPC-E and -EC: $0.7 \times$ the setpoint.

During each flow estimation (every 2 minutes), the estimating function will disturb the outlet pressure by $\pm 10\%$ of the setpoint. If this disturbance is not acceptable, the stop function must be based on direct flow measurement with a flowmeter or flow switch.

The minimum flow rate can be set, that is the flow rate at which the system changes to on/off control of the last pump in operation.

If both a flowmeter and a flow switch are connected, the changeover to on/off control will be determined by the unit first indicating low flow rate.

Setting range

Start/stop band:	5-30 %
Minimum flow rate:	2-50 % of the rated flow rate (Q_{nom}) of one of the pumps. (It can only be set if direct flow measurement by means of flowmeter has been selected.)
Distribution above setpoint:	0-100 %.

Setting via the operating panel

System without flow switch or flowmeter

- **Settings > Secondary functions > Stop function.**
- Select: **Enabled.**
- 1. Set: **Start/stop band.**
- 2. Select: **Go to setting of flow stop parameters.**

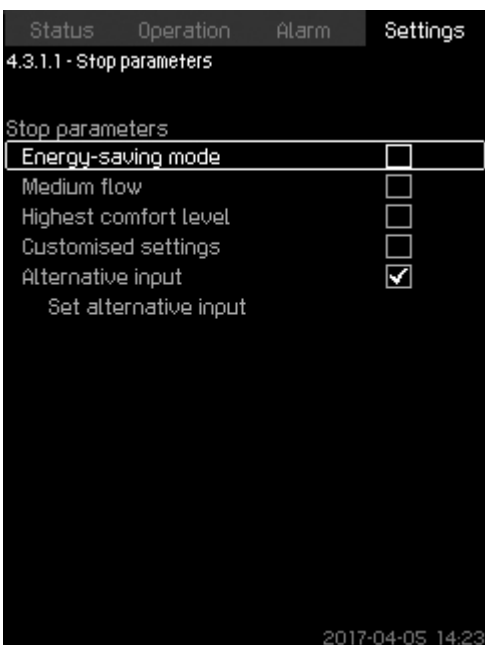

4-3-1-1_STOP_PARAMETERS_171

Stop parameters

3. Select one of the stop parameters. If you select **Customised settings**, you must set the parameters shown as in the examples below.

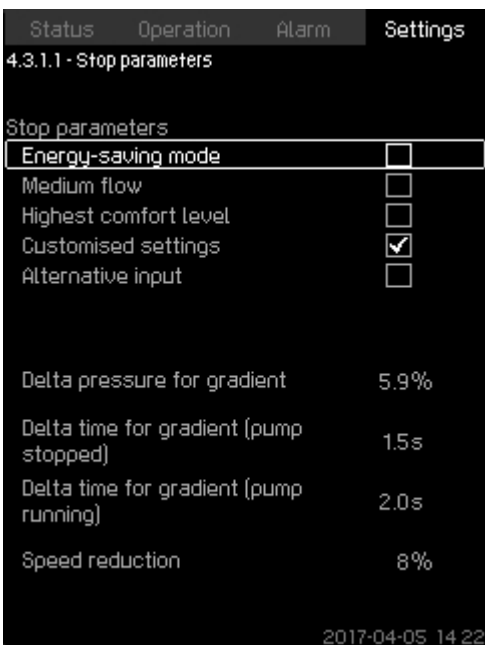

4-3-1-1_TM038957_171

Customised settings



Rule of thumb: Speed reduction = 2 x delta pressure for gradient.

Example 1: Increasing the stop limit, Qmin (high flow limit)

- Increase **Delta pressure for gradient**.
- Reduce **Delta time for gradient (pump stopped)**.
- Reduce **Delta time for gradient (pump running)**.
- Increase **Speed reduction**.

Example of increased stop limit	
Parameter	Value
Delta pressure for gradient	6 %
Delta time for gradient (pump stopped)	1.5 seconds
Delta time for gradient (pump running)	2.0 seconds
Speed reduction	10 %

Example 2: Reducing the stop limit, Qmin (low flow limit)

- Reduce **Delta pressure for gradient**.
- Increase **Delta time for gradient (pump stopped)**.
- Increase **Delta time for gradient (pump running)**.
- Reduce **Speed reduction**.

Example of reduced flow limit	
Parameter	Value
Delta pressure for gradient	3 %
Delta time for gradient (pump stopped)	15.0 seconds
Delta time for gradient (pump running)	25.0 seconds
Speed reduction	6 %



The stop limit depends on the tank size.

Alternative input

If you select **Alternative input**, the controller calculates the stop parameters based on the following inputs:

- system setpoint
- total tank volume
- precharge pressure
- desired stop flow.

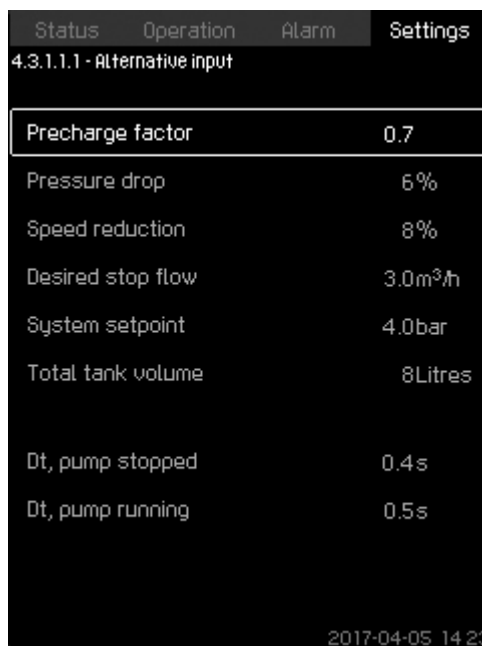

4-3-1-1_ALTERNATIVE_INPUT_201

Alternative input

System with flow switch

Make the following additional settings:

1. Select: **Go to setting of digital input**. Display **Digital inputs** (4.3.7) appears.

2. Select the digital input where the flow switch is connected.
3. Select: **Flow switch**.
4. Press ↵.

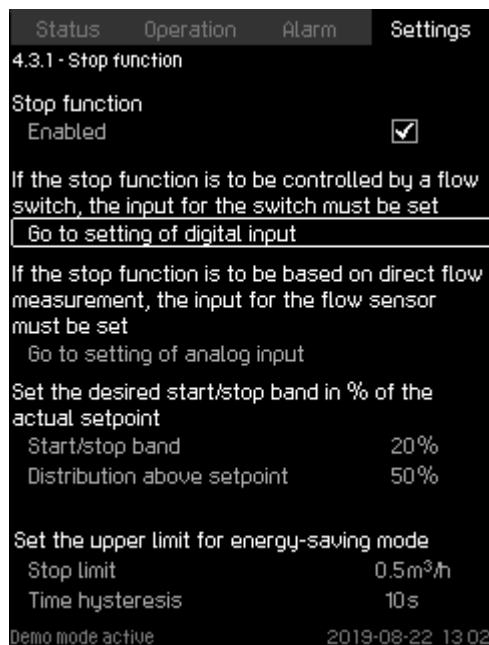

4-3-1_STOP_FUNCTION

System with flow switch



An open contact indicates low flow.

System with flowmeter

Make the following additional settings:

1. Select: **Go to setting of analog input**. The display **Analog inputs** (4.3.8) appears.
2. Select the analog input where the flowmeter is connected.
3. Select: **Flow rate**.
4. Press ↵ × 2.

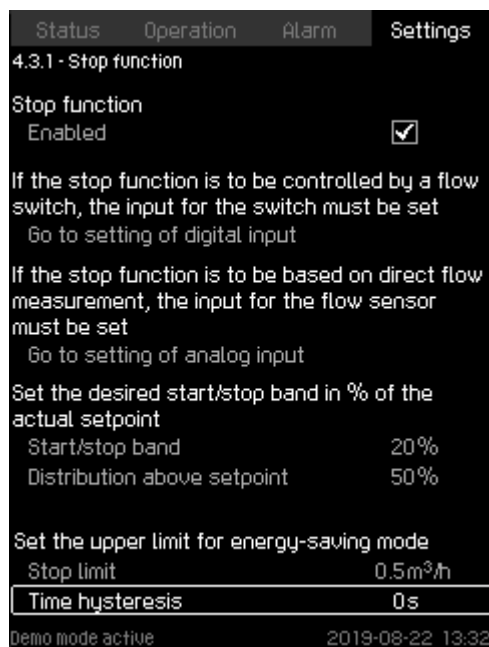

4-3-1_STOP_FUNCTION_TIME_HYSTERESIS

System with flowmeter

5. Set: **Stop limit**.



As standard, there is a 10-seconds detection hysteresis.

Factory settings

The function is enabled in pressure-boosting applications with the settings in the table.

Start/stop band:	25 %
Minimum flow rate:	30 % of the rated flow rate of one pump
Distribution above setpoint:	50 %

The function is disabled in all other applications.

Related information

- 6. [Control variants](#)
- 8.3.4 [Setpoint \(1.2.2\)](#)
- 8.6.26 [Digital inputs \(4.3.7\)](#)
- 8.6.28 [Analog inputs \(4.3.8\)](#)

8.6.23 Pilot pump (4.3.2)

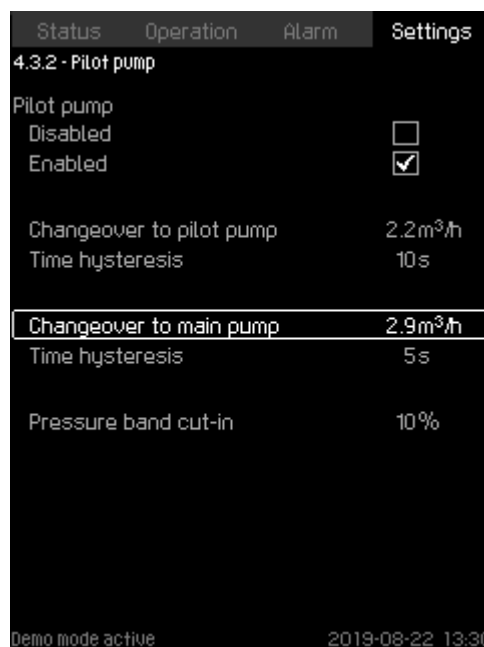

4-3-2_PILOT_PUMP

Pilot pump

Description

In applications with low flow variations, a system with a pilot pump is advised.

To obtain a high efficiency the recommended pilot pump size is 20-25 % of Q_{nom} of the main pump.

Both cut in and cut out speed for pilot pump and main pump is calculated using the pump curve data.



The pilot pump needs to be activated using the PC Tool. We recommend to upload pump data for the pilot pump or go to menu and enter them manually.

1. Enable or disable the pilot pump.
2. **Changeover to pilot pump:** Set the flow for the changeover from main pump to the pilot pump. Factory settings are 75 % of the pilot pump Q_{nom} .
3. **Time hysteresis:** Set the delay time for the changeover to a stable low flow before the changeover.

4. **Changeover to main pump:** Set the flow for the changeover from pilot pump to the main pump. Factory settings are 95 % of the pilot pump Q_{nom} .
5. **Time hysteresis:** Set the delay time for the changeover to a stable low flow before the changeover.
6. **Pressure band cut-in:** Set the pressure band in percentage of the setpoint. The pressure band is used for cut-in or cut-out of pumps.
 - Main pumps cut-out when the pilot pump ramps up to a stable setpoint "+ or and" pressure band outlet pressure
 - Pilot pump cut-out when the main pumps ramps up to a stable setpoint "+ or and" pressure band outlet pressure
 - If the pilot pump is running at 100 % and the pressure band is below the setpoint-pressure band, the main pumps will cut in.

Setting via the operating panel

- **Settings > Secondary functions > Pilot pump.**

1. Enable pilot pump
 - Set: **Changeover to pilot pump**
 - Set: **Time hysteresis**
 - Set: **Changeover to main pump**
 - Set: **Time hysteresis.**
2. Set: **Pressure band cut-in.**

Factory settings

The function is disabled.

8.6.24 Soft pressure build-up (4.3.3)



The soft pressure build-up program will be disabled if the multisensor function is activated.

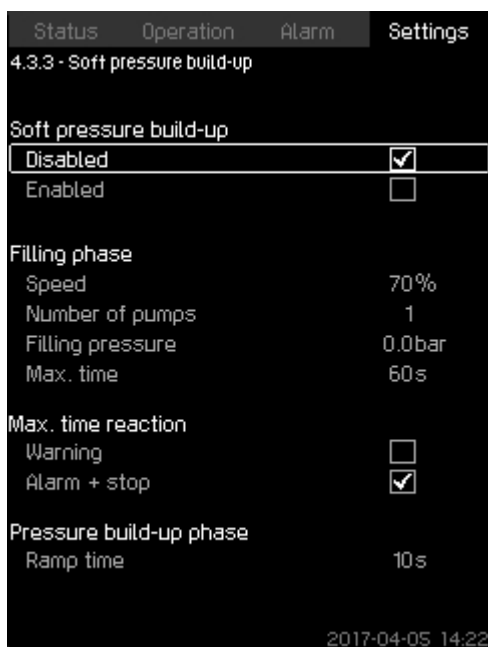

4-3-3_TM038970_133

Soft pressure build-up

Description

The function is typically used in pressure-boosting applications and ensures a smooth startup of systems with for instance empty pipes. Startup takes place in two phases:

- **Filling phase (1):** The pipes are slowly filled with water. When the pressure sensor of the system detects that the pipes have been filled, Phase 2 begins.

- **Pressure build-up phase (2):** The system pressure is increased until the setpoint (SP) is reached. The pressure buildup takes place over a ramp time. If SP is not reached within a given time, a warning or an alarm can be given, and the pumps can be stopped at the same time.

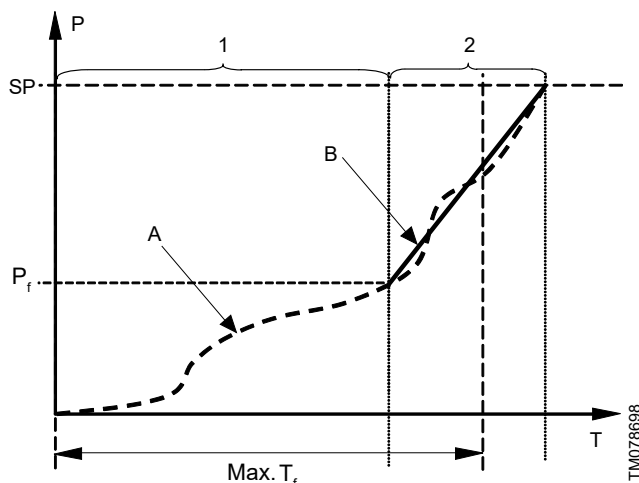

Filling and pressure buildup phases

P: Pressure	T: Time [second]
P_f : Filling pressure	T_f : Filling time

Pos.	Description
1	Filling phase: constant-curve operation
2	Pressure build-up phase: constant-pressure operation
A	Actual value
B	Setpoint ramp-up

Setting range

- **Speed** (pump speed)
- **Number of pumps**
- **Filling pressure**
- **Max. time** (maximum filling time)
- **Warning or Alarm + stop**
- **Ramp time for Pressure build-up phase.**

Setting via the operating panel

- **Settings > Secondary functions > Soft pressure build-up.**

1. Select and set:
 - **Speed**
 - **Number of pumps**
 - **Filling pressure**
 - **Max. time.**
2. Select: **Warning** or **Alarm + stop.**
3. Set: **Ramp time.**
4. Select: **Enabled.**

Factory settings

The function is disabled.

8.6.25 Emergency run (4.3.5)

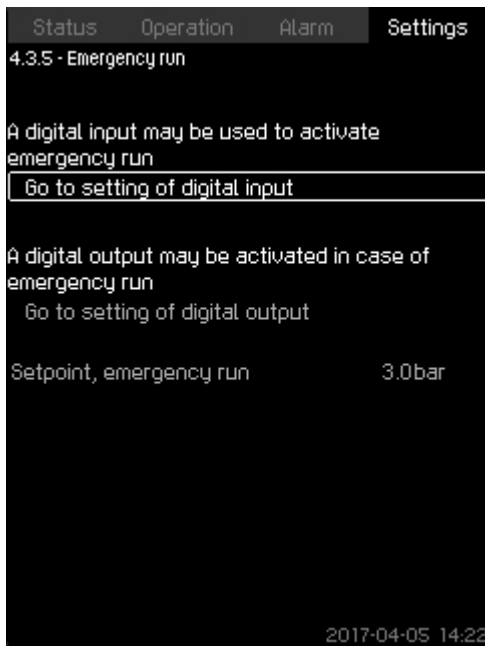

4-3-5_TM038971_132

Emergency run**Description**

The function is used in booster applications. When this function has been enabled, the pumps will keep running regardless of warnings or alarms. The pumps will run according to a setpoint set specifically for this function.



In case of sensor fault, both main and standby pumps will run at 100 % speed.

Setting range

- Setting of digital input, see section Digital inputs (4.3.7).
- Setting of digital output see section Digital outputs (4.3.9).
- Setting of setpoint for emergency run.

Setting via the operating panel

- **Settings > Secondary functions > Emergency run > Go to setting of digital input.**
 1. Select: **Digital inputs.**
 2. Select: **Emergency run.**
 3. Press ↵ x 2.
 4. Select: **Go to setting of digital output.**
 5. Select: **Digital outputs.**
 6. Select: **Emergency run.**
 7. Press ↵ x 2.
 8. Set: **Setpoint, emergency run.**



When you have set this function described above, you can also enable it via the display **System operating mode.**

Related information

- [8.4.2 System operating mode \(2.1.1\)](#)
- [8.6.26 Digital inputs \(4.3.7\)](#)
- [8.6.31 Digital outputs \(4.3.9\)](#)

8.6.26 Digital inputs (4.3.7)

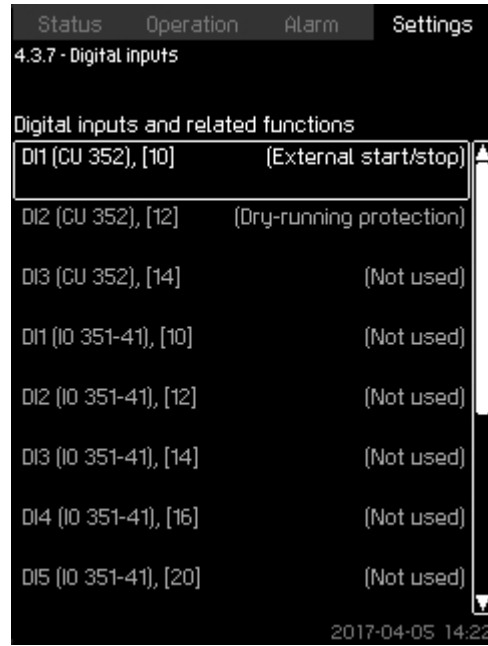

4-3-7_TM032359_061

Digital inputs**Description**

In the menu, you can set the digital inputs of CU 352. Each input, except DI1, can be activated and related to a certain function.

As standard, the system has three digital inputs. If the system incorporates an IO 351B module (option), the number of digital inputs is 12.

All digital inputs are shown so that their physical position in the system can be identified.

Example

DI1 (IO 351-41), [10]:

DI1:	Digital input No. 1
(IO 351-41):	IO 351, GENIbus number 41
[10]:	Terminal No. 10

For further information on the connection of various digital inputs, see the wiring diagram supplied with the control cabinet.

Setting range

DI1 (CU 352) cannot be selected.

Setting via the operating panel

- **Settings > Secondary functions > Digital inputs.**

8.6.27 Functions of digital inputs (4.3.7.1)

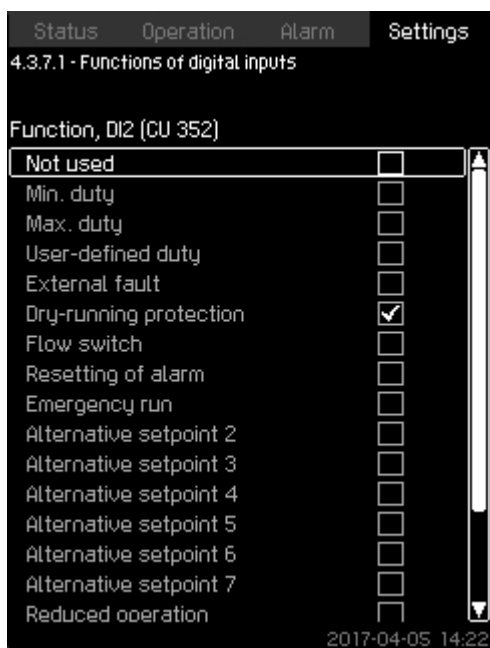

4-3-7-1_TMO38972_063













Functions of digital inputs

Description

A function can be related to the digital inputs.

Setting range

You can select one function in each display:

Function	Contact activated	
Not used		
Min. duty		= Operating mode Min.
Max. duty		= Operating mode Max.
User-defined duty		= Operating mode User-defined
External fault		= External fault
Dry-running protection		= Water shortage
Flow switch		= Flow
Resetting of alarm		= Alarms are reset
Emergency run		= Operating mode Emergency run
Fault, pilot pump		= Fault
Alternative setpoint 2 -7		= The setpoint is selected
Reduced operation		= Activation of Reduced operation
Stop pump 1 -6		= Forces the pump to stop
Stop pilot pump		= Forces the pump to stop



In the display, you can only select pumps defined in the system.

See the relevant sections for further information about the functions. Generally, a closed contact activates the function selected.

Setting via the operating panel

- **Settings > Secondary functions > Stop function > Go to setting of digital input.**

Factory settings

Digital input	Function
DI1 (CU 352) [10]	External start/stop. Open contact = stop. Note: Input No. 1 cannot be changed.
DI2 (CU 352) [12]	Monitoring of water shortage (dry-running protection). Open contact = water shortage (if the system is supplied with this option).



Monitoring of water shortage requires a pressure or level switch connected to the system.

8.6.28 Analog inputs (4.3.8)

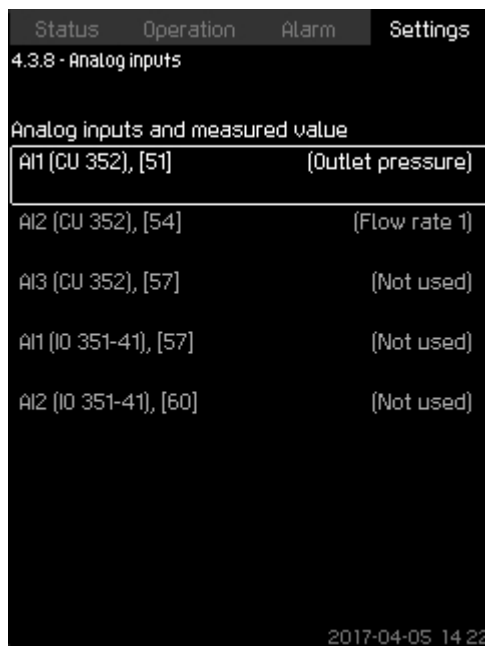

4-3-8_TMO32356_069

Analog inputs

Description

Each analog input can be activated and related to a certain function.

As standard, the system has three analog inputs. If the system incorporates an IO 351B module (option), the number of analog inputs is 5.

All analog inputs are shown so that their physical position in the system can be identified. A redundant primary sensor can be fitted as backup for the primary sensor in order to increase reliability and prevent stop of operation.



If two sensors are to be redundant, each must have a separate analog input.

Example

AI1 (CU 352) [51]:

AI1:	Analog input No. 1
(CU 352):	CU 352
[51]:	Terminal No. 51

Setting via the operating panel

- **Settings > Secondary functions > Stop function > Go to setting of analog input.**

8.6.29 Analog inputs (4.3.8.1 - 4.3.8.7)

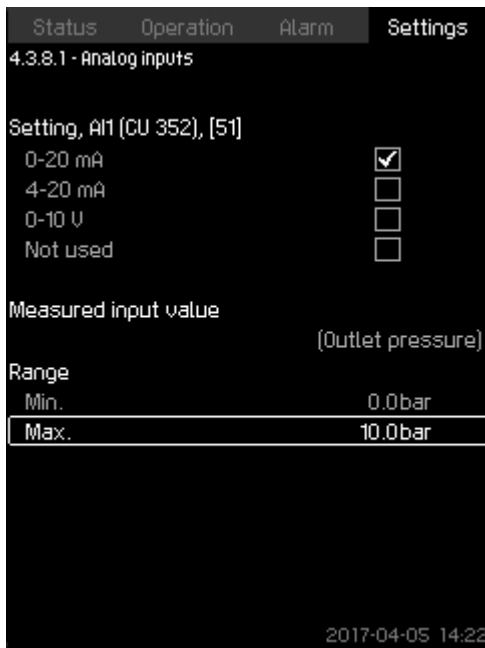

4-3-8-1_TM032357_077

Analog inputs**Description**

In the menu, you can set **Analog inputs**. Each display is divided into three parts:

- Setting of input signal, for instance 4-20 mA
- **Measured input value**, for instance **Outlet pressure**
- Measuring range of the sensor/signal transmitter, for instance 0-232 psi (0-16 bar).

Setting range

You can set the following parameters in each display:

- **Not used**
- Range of input signal, 0-20 mA, 4-20 mA, 0-10 V
- **Measured input value**
- Sensor range.

Setting via the operating panel

- **Settings > Secondary functions > Stop function > Go to setting of analog input.**



If an analog input is deactivated, the display only shows the top part, that is the setting of the analog input.

If the input is activated, the middle part, **Measured input value** is shown. This makes it possible to relate a function to the analog input in another display. When the analog input has been related to a function, CU 352 will return to the display for setting of analog inputs.

Factory settings

Pressure boosting	
Analog input	Function
AI1 (CU 352) [51]	Outlet pressure
Heating and cooling	
Analog input	Function
AI1 (CU 352) [51]	These are selected in the startup wizard.

8.6.30 Analog inputs and measured value (4.3.8.1.1 - 4.3.8.7.1)

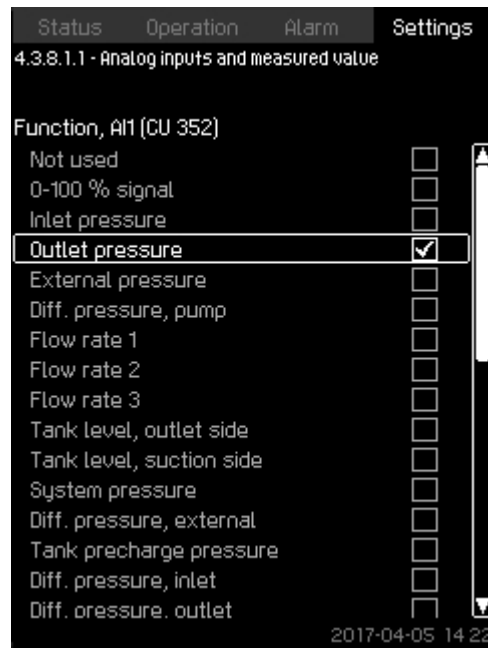

4-3-8-1-1_TM038973_076

Analog inputs and measured value**Description**

A function can be related to the individual analog inputs.

Setting range

You can select one function per analog input. For further details, see the installation and operating instructions for Control MPC.

- **Not used**
- **0-100 % signal**
- **Inlet pressure**
- **Outlet pressure**
- **External pressure**
- **Diff. pressure, pump**
- **Flow rate 1-3**
- **Tank level, outlet side**
- **Tank level, suction side**
- **System pressure**
- **Diff. pressure, external**
- **Tank precharge pressure**
- **Diff. pressure, inlet**
- **Diff. pressure, outlet**
- **Return-pipe temp., external**
- **Flow-pipe temperature**
- **Return-pipe temperature**
- **Differential temperature**
- **Ambient temperature**
- **Power, pump 1 -6**
- **Power, VFD**
- **Multisensor 1-6.**

Setting via the operating panel

If more flow rates are used, the flow rate measured and shown is the sum of defined flow rates.

- **Settings > Secondary functions > Go to setting of analog input.**

1. Select: **Analog inputs**.
2. Select: **Measured input value**. Display 4.3.8.1.1 appears.
3. Select input.
4. Press **↵**.
5. Set the minimum and maximum sensor value.

8.6.31 Digital outputs (4.3.9)

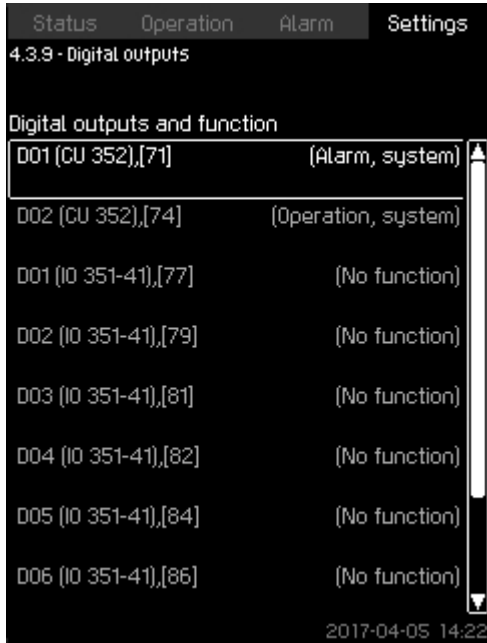

4-3-9_TM032333_078

Digital outputs

Description

Each digital output can be activated and related to a certain function.

As standard, the system has two digital outputs.

If the system incorporates an IO 351B module (option), the number of digital outputs is 9.

All digital outputs are shown so that their physical position in the system can be identified.

Example

DO1 (IO 351-41) [71]:

DO1	Digital output No. 1
(IO 351-41)	IO 351B, GENibus number 41
[71]	Terminal No. 71

For further information on the connection of various digital outputs, see the wiring diagram supplied with CU 352.

8.6.32 Function of digital outputs (4.3.9.1 - 4.3.9.16)

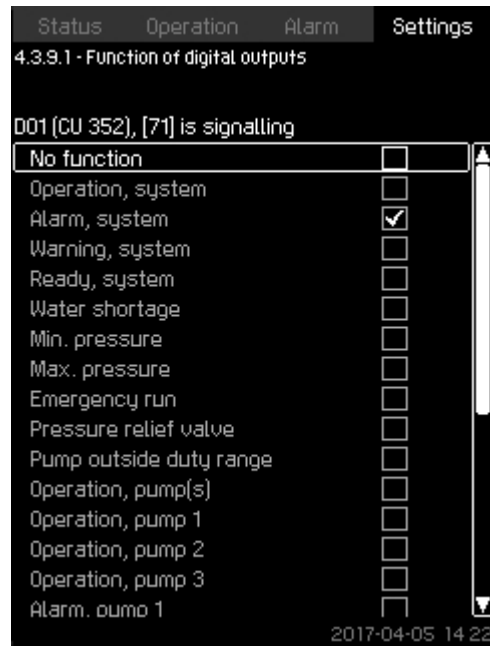

4-3-9-1_TM038974_079

Function of digital outputs

Description

A function can be related to the individual outputs.

Setting range

You can select one function in each display:

- **No function**
- **Operation, system**
- **Alarm, system**
- **Warning, system**
- **Ready, system**
- **Water shortage**
- **Min. pressure**
- **Max. pressure**
- **Emergency run**
- **Operation, pilot pump**
- **Pressure relief valve**
- **Pump outside duty range**
- **Operation, pump(s)**
- **Operation, pump 1 -6**
- **Alarm, pump 1**
- **Alarm, limit 1 exceeded**
- **Warning, limit 1 exceeded**
- **Alarm, limit 2 exceeded**
- **Warning, limit 2 exceeded**
- **Reduced operation.**

Setting via the operating panel

- **Settings > Secondary functions > Stop function > Go to setting of digital input.**

Factory settings

Digital output	Function
DO1 (CU 352) [71]	Alarm, system
DO2 (CU 352) [74]	Operation, system

8.6.33 Analog outputs (4.3.10)

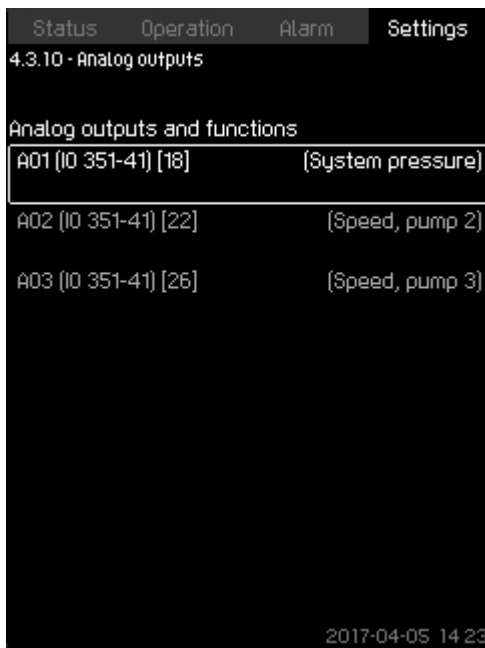

4-3-10_TM052971_183

Analog outputs

This display only appears if an IO 351B module is installed.

Description

CU 352 does not have analog outputs as standard, but the system can be fitted with an IO 351B module with three analog outputs.

Setting via the operating panel

- **Settings > Secondary functions > Analog outputs.**

8.6.34 Output signal (4.3.10.1 - 4.3.10.3)

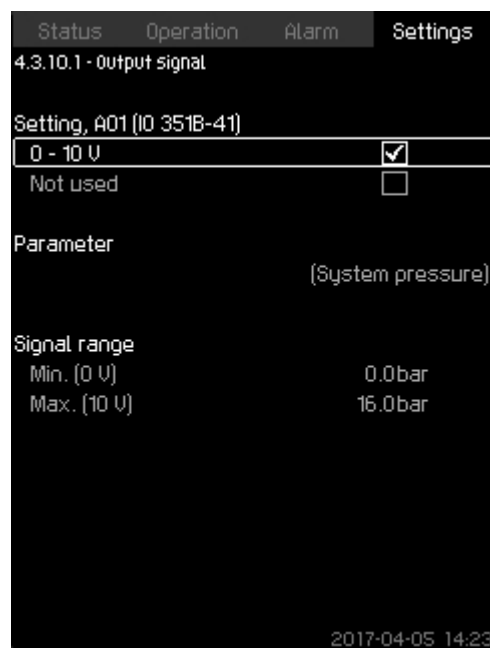

4-3-10-1_TM053220_185

Output signal**Description**

You can select the parameters below.

Setting range

- **0-100 % signal**
- **Flow rate 1 -6**
- **Inlet pressure**
- **Outlet pressure**
- **External pressure**
- **Diff. pressure, pump**
- **Tank level, outlet side**
- **Tank level, suction side**
- **System pressure**
- **Diff. pressure, external**
- **Tank precharge pressure**
- **Diff. pressure, inlet**
- **Diff. pressure, outlet**
- **Return-pipe temp., external**
- **Flow-pipe temperature**
- **Return-pipe temperature**
- **Differential temperature**
- **Ambient temperature**
- **System power**
- **Power, pump 1 -6**
- **Power, pilot pump**
- **Power, VFD**
- **Speed, pump 1 -6**
- **Speed, pilot pump**
- **Current, pump 1 -6**
- **Current, pilot pump**
- **Specific energy**

Setting via the operating panel

- **Settings > Secondary functions > Go to setting of analog input.**

1. Select analog output and range.
2. Select: **Parameter**. Display 4.3.10.2 appears.
3. Select output.
4. Press **↵**.
5. Set: **Signal range**.

8.6.35 Counter inputs (4.3.11)



4-3-11_COUNTER_INPUTS_194

Counter inputs

Description

You can set CU 352 to accumulate a pumped volume from a digital water meter.

Setting via the operating panel

1. **Select digital input for volume counter**
2. Define unit (unit of volume per digital input pulse).
3. Define scaling of pulse counts.



This menu only appears if an IO 351B module is connected to CU 352.

8.6.36 Min., max. and user-defined duty (4.3.14)

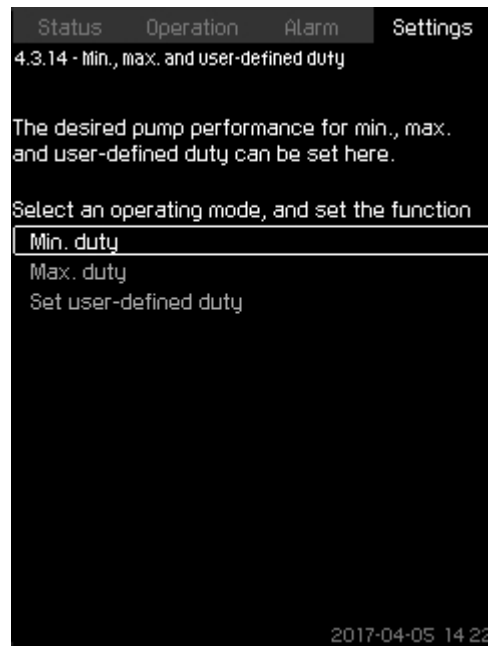

4-3-14_TM032351_092

Min., max. and user-defined duty

Description

The function allows you to let the pumps run in open loop at a set performance.

Setting range

CU 352 allows you to change between three operating modes:

1. **Min. duty** (4.3.14.1).
2. **Max. duty** (4.3.14.2).
3. **User-defined duty** (4.3.14.3).



For each of these operating modes, you can set the number of operating pumps and the pump performance (speed).

Related information

[8.6.37 Min. duty \(4.3.14.1\)](#)

[8.6.38 Max. duty \(4.3.14.2\)](#)

[8.6.39 User-defined duty \(4.3.14.3\)](#)

8.6.37 Min. duty (4.3.14.1)

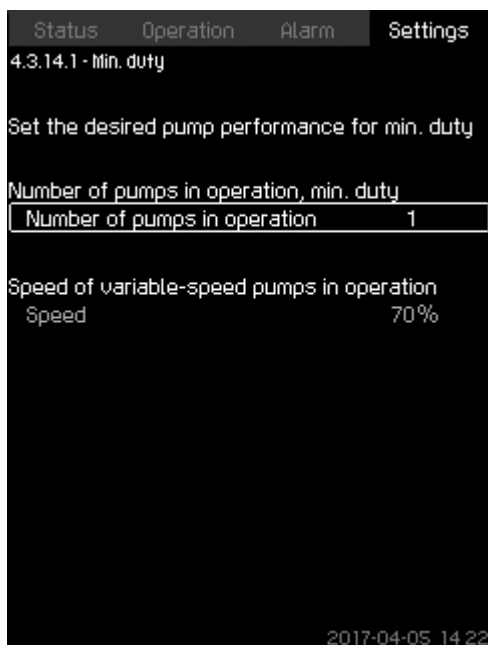

4-3-14-1_TM032354_093

Min. duty**Description**

In all systems, minimum duty is only possible for variable-speed pumps.

Setting range

- Number of pumps in operation.
- Speed as percentage (25 to 100 %) for variable-speed pumps.

Setting via the operating panel

- **Settings > Secondary functions > Min., max. and user-defined duty > Min. duty.**

Select and set:

- **Number of pumps in operation, min. duty.**
- **Speed.**

Factory settings

Number of pumps in operation during min. duty:	1
Speed as percentage for variable-speed pumps:	70

8.6.38 Max. duty (4.3.14.2)

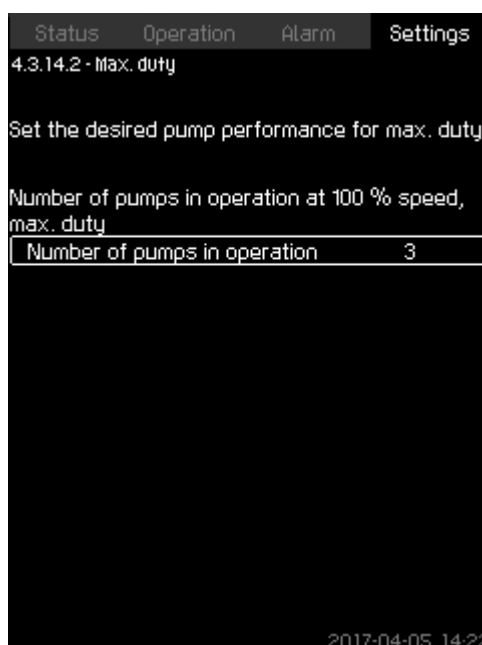

4-3-14-2_TM032353_094

Max. duty**Description**

The function allows you to set a number of pumps to run at maximum performance when the function is enabled.

Setting range

You can set the number of pumps to run in the operating mode **Max.**. All pumps run at 100 % speed.

Setting via the operating panel

- **Settings > Secondary functions > Min., max. and user-defined duty > Max. duty.**

Select and set:

- **Number of pumps in operation at 100 % speed, max. duty.**

Factory settings

Number of pumps in operation during max. duty:
All pumps (except standby pumps).

8.6.39 User-defined duty (4.3.14.3)

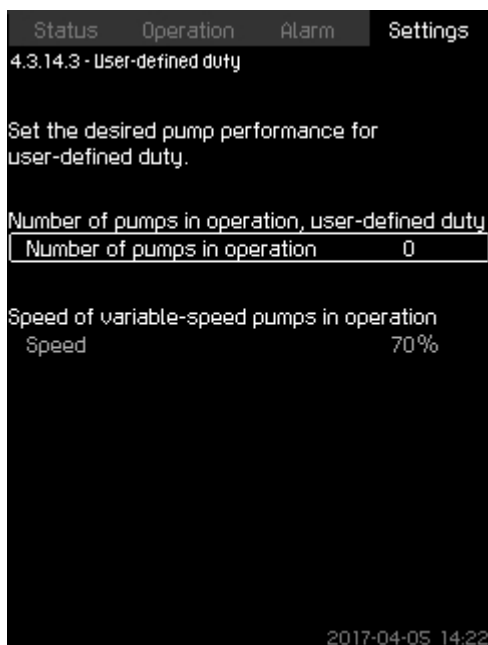

4-3-14-3_TM032352_096

User-defined duty**Description**

You can set a user-defined performance, typically a performance between minimum and maximum duty.

The function allows you to set a pump performance by selecting the number of pumps to run and the speed of variable-speed pumps.

This function primarily selects the variable-speed pumps. If the number of selected pumps exceeds the number of variable-speed pumps, mains-operated pumps are started too.

Setting range

- **Number of pumps in operation.**
- Speed as percentage for variable-speed pumps.



In systems with only variable-speed pumps, the speed can be set between 25 and 100 %; in systems with both variable-speed pumps and mains-operated pumps the speed can be set between 70 and 100 %.

Setting via the operating panel

- **Settings > Secondary functions > Min., max. and user-defined duty > User-defined duty.**

Select and set:

- **Number of pumps in operation, user-defined duty.**
- **Speed.**

Factory settings

The function is disabled as the following has been set:

Number of pumps in operation during user-defined duty:	00
--	----

8.6.40 Pilot pump curve data (4.3.18)

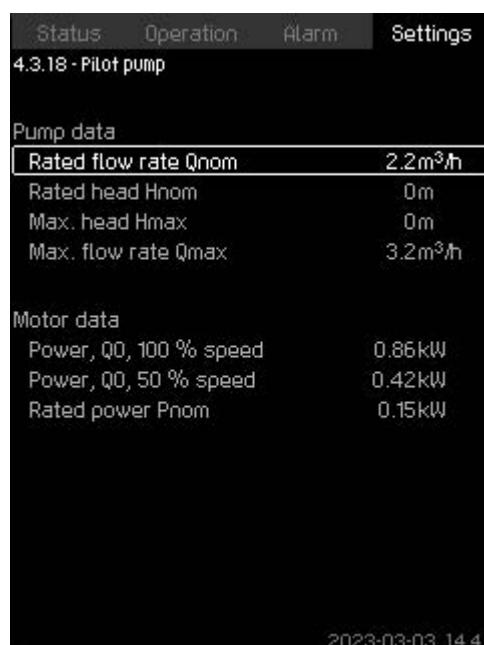

TM068399

Pilot pump curve data**Description**

Pilot pump data is needed for the pilot pump function to work. The function uses the following data:

• Rated flow rate Qnom	[m ³ /h]
• Rated head Hnom	[m]
• Max. head Hmax	[m]
• Max. flow rate Qmax	[m ³ /h]
• Power, Q0, 100 % speed	[kW]
• Power, Q0, 50 % speed	[kW]
• Rated power Pnom	[kW]



Grundfos can supply hydraulic data for CR, CRI, CRE and CRIE pumps where GSC files can be downloaded to CU 352.

All other pump types require manual entering of hydraulic pump data.



Enter the electrical data, **Power, Q0, 100 % speed** and **Power, Q0, 50 % speed** manually for all pump types, including CR, CRI, CRE and CRIE.

For Grundfos E-pumps, enter the data of input power (P1).

Read the data using the pump performance curves which can be found in Grundfos Product Center at www.grundfos.com.

If Grundfos Product Center is not accessible, try to bring a pump into the three duty points:

- **Power, Q0, 100 % speed**
- **Power, Q0, 50 % speed**
- **Rated power Pnom.**

See section How to read pump curve data in Grundfos Product Center.

Setting via the operating panel

- **Settings > Secondary functions > Pump curve data.**
- Select and set:
 - **Rated flow rate Qnom**
 - **Rated head Hnom**
 - **Max. head Hmax**
 - **Max. flow rate Qmax**
 - **Power, Q0, 100 % speed**
 - **Power, Q0, 50 % speed**
 - **Rated power Pnom.**

Related information

[8.6.38 Max. duty \(4.3.14.2\)](#)

[8.6.41 Pump curve data \(4.3.19\)](#)

[8.6.42 How to read pump curve data](#)

8.6.41 Pump curve data (4.3.19)

Status	Operation	Alarm	Settings
4.3.19 - Pump curve data			
Pump data			
Rated flow rate Qnom		10.0m ³ /h	
Rated head Hnom		48m	
Max. head Hmax		61m	
Max. flow rate Qmax		0.0m ³ /h	
Motor data			
Power, Q0, 100 % speed		0.00kW	
Power, Q0, 50 % speed		0.00kW	
Rated power Pnom		0.00kW	
Flow estimation			
2017-04-05 14:22			

4-3-19_TM038975_104

Pump curve data

Description

CU 352 has a number of functions using these pump data:

• Rated flow rate Qnom	[gpm]
• Rated head Hnom	[ft]
• Max. head Hmax	[ft]
• Max. flow rate Qmax	[gpm]
• Power, Q0, 100 % speed	[kW]
• Power, Q0, 50 % speed	[kW]
• Rated power Pnom	[kW]
• VFD minimum speed	[%]
• VFD maximum speed	[%]



Grundfos can supply hydraulic data for CR, CRI, CRE and CRIE pumps where GSC files can be downloaded to CU 352.

All other pump types require manual entering of hydraulic pump data.



Enter the electrical data, **Power, Q0, 100 % speed** and **Power, Q0, 50 % speed** manually for all pump types, including CR, CRI, CRE and CRIE.

For Grundfos E-pumps, enter the data of input power (P1).



The VFD speed range is the range in which the VFD is operating, so if the minimum and maximum speeds are limited on the VFD, the values for the operating range have to be entered in these fields.

Only used for EF systems. It is not used for E and EC systems.

Read the data using the pump performance curves which can be found in Grundfos Product Center at www.grundfos.com. See the examples below.

If you cannot access Grundfos Product Center, try bringing a pump into the three duty points:

- **Power, Q0, 100 % speed**

- Power, Q0, 50 % speed
- Rated power Pnom.

Setting via the operating panel

- Settings > Secondary functions > Pump curve data.
- Select and set:
 - Rated flow rate Qnom
 - Rated head Hnom
 - Max. head Hmax
 - Max. flow rate Qmax
 - Power, Q0, 100 % speed
 - Power, Q0, 50 % speed
 - FD minimum speed
 - VFD maximum speed.

Related information

[8.6.42 How to read pump curve data](#)

8.6.42 How to read pump curve data

Read the power values in displays 1.3 to 1.8, depending on the pump. See section Pump 1-6, Pilot pump (1.3 - 1.10).

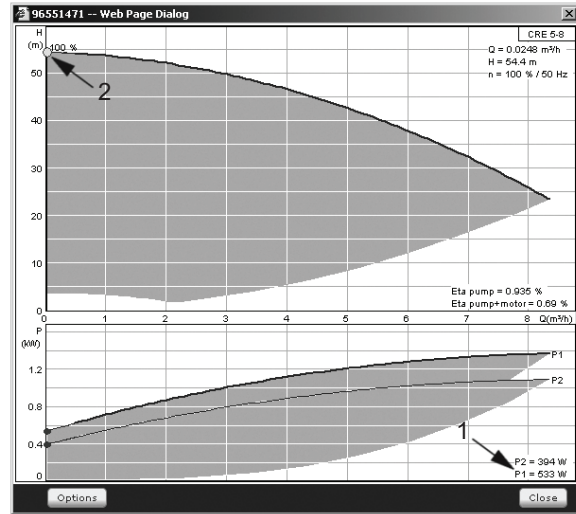

TM039994

Reading of power, Q0, 100 % speed (Grundfos Product Center)

Pos.	Description
1	Power, Q0, 100 % speed
2	Duty point, Q0, 100 % speed

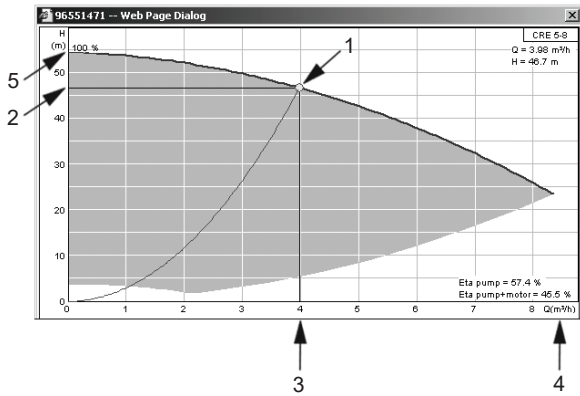

TM039993

Reading of Q_{nom}, H_{nom}, H_{max} and Q_{max} (Grundfos Product Center)

Pos.	Description
1	Rated duty point
2	H _{nom}
3	Q _{nom}
4	Q _{max}
5	H _{max}

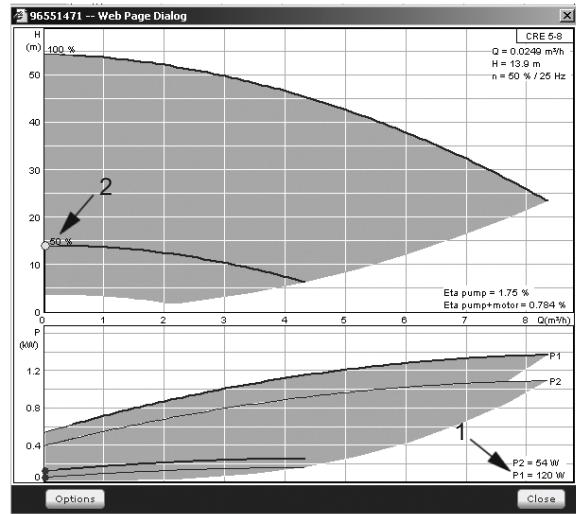

TM039995

Reading of power, Q0, 50 % speed (Grundfos Product Center)

Pos.	Description
1	Power, Q0, 50 % speed
2	Duty point, Q0, 50 % speed

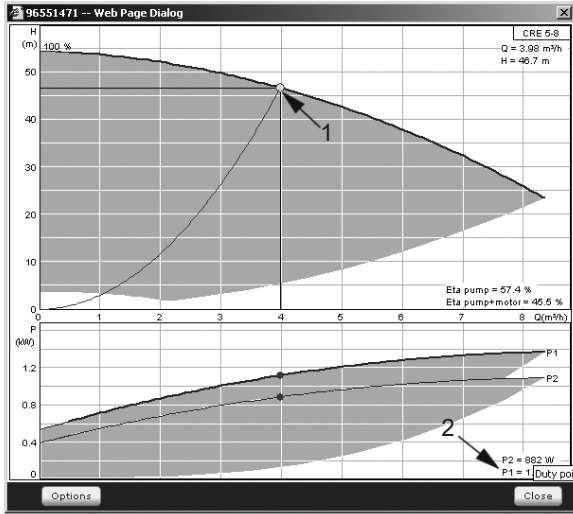

TM039996

Reading of rated power P_{nom} (Grundfos Product Center)

Pos.	Description
1	Duty point, rated power P_{nom}
2	Rated power P_{nom}



Q_{nom} and H_{nom} are the rated duty point of the pumps and usually the duty point with the highest efficiency.

Setting via the operating panel

- **Settings > Secondary functions > Pump curve data.**
- Select and set:
 - **Rated flow rate Q_{nom}**
 - **Rated head H_{nom}**
 - **Max. head H_{max}**
 - **Max. flow rate Q_{max}**
 - **Power, Q0, 100 % speed**
 - **Power, Q0, 50 % speed**
 - **Rated power P_{nom} .**

Related information

[8.3.10 Pump 1-6, Pilot pump \(1.3 - 1.10\)](#)

8.6.43 Control source (4.3.20)

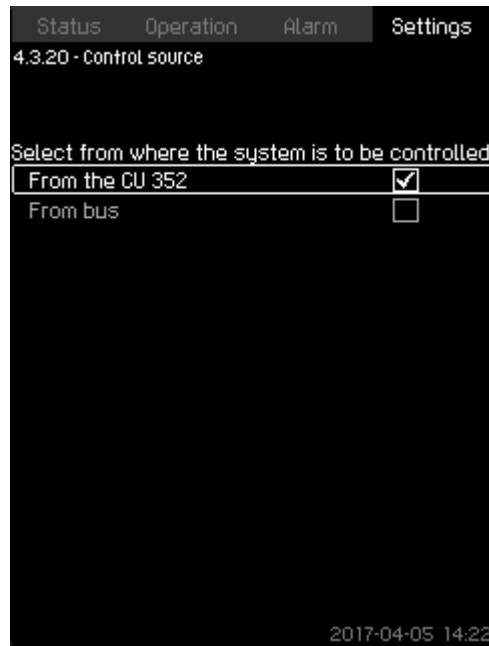

4-3-20_TM032342_107

Control source

Description

The system can be remote-controlled via an external bus connection (option). See section GENIbus. For further information, see section Data communication.

Select the control source, that is either CU 352 or the external bus connection.

Setting via the operating panel

- **Settings > Secondary functions > Control source.**

Factory settings

The control source is CU 352.

8.6.44 Fixed inlet pressure (4.3.22)



4-3-22_TM038976_163

Fixed inlet pressure**Description**

The function is only used when no inlet-pressure sensor is fitted in the system and the inlet pressure is fixed and known.

If the system has a fixed inlet pressure, you can enter it in the display so that CU 352 can optimize the performance and control of the system.

Setting range

A fixed inlet pressure can be set, and the function can be enabled and disabled.

Setting via the operating panel

- **Settings > Secondary functions > Fixed inlet pressure.**
- Select: **Enabled** or **Disabled**.
- Set: **Fixed inlet pressure**.

Factory settings

The function is disabled.

8.6.45 Flow estimation (4.3.23)

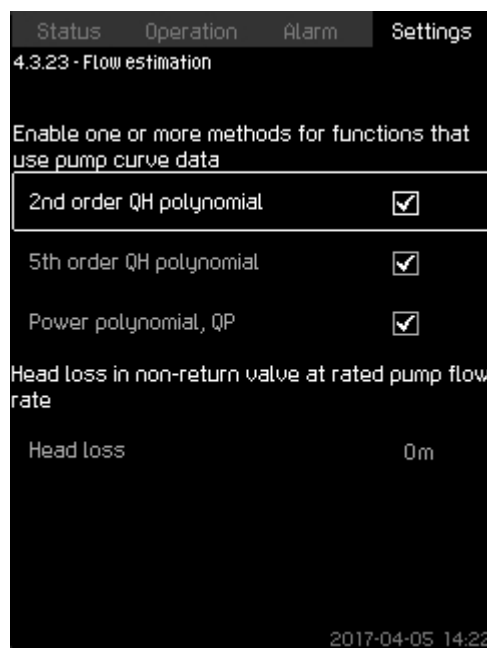

4-3-23_TM038977_170

Flow estimation**Description**

As described in section Pump curve data (4.3.19), CU 352 can optimize operation according to performance curves and motor data. In this display, you can select the curve types which CU 352 uses for the optimization if they are available.

At large flow rates, there may be a considerable head loss between the pump outlet flange and the pressure sensor. The loss is caused by non-return valves and pipe bends. To improve the flow estimation of the system, it is necessary to compensate for the difference between the measured and the actual differential pressure across the pump. This is done by entering the head loss in non-return valves and pipe bends at the rated flow rate of one pump.

Setting range

- **2nd order QH polynomial**
- **5th order QH polynomial**
- **Power polynomial, QP**
- **Head loss.**



It is possible to select several curve types, as CU 352 makes a priority based on the data available.

Setting via the operating panel

- **Settings > Secondary functions > Flow estimation.**

Factory settings

All polynomials are selected.

Related information

[8.6.41 Pump curve data \(4.3.19\)](#)

8.6.46 Reduced operation (4.3.24)

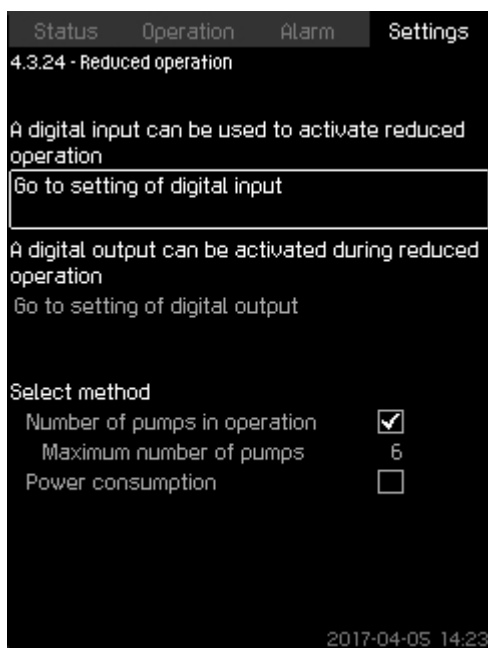

4-3-24_TM052972_175

Reduced operation**Description**

The function allows you to limit the number of pumps in operation, or for MPC-E systems, to limit power consumption. The limit is activated by a digital input.

Setting range

- Setting of digital input, see section Digital inputs (4.3.7).
- Setting of digital output, see section Digital outputs (4.3.9).
- Maximum number of pumps in operation.
- Maximum power consumption.

Setting via the operating panel

- **Settings > Secondary functions > Reduced operation.**
1. Select: **Go to setting of digital input.**
 2. Select digital input.
 3. Select: **Reduced operation.**
 4. Press ↵ x 2.
 5. Select: **Go to setting of digital output.**
 6. Select digital output.
 7. Select: **Reduced operation.**
 8. Press ↵ x 2.
 9. Set: **Number of pumps in operation** or **Power consumption.**

Factory settings

No digital input is selected (disabled).

Related information

[8.6.26 Digital inputs \(4.3.7\)](#)

[8.6.31 Digital outputs \(4.3.9\)](#)

8.6.47 Multisensor settings (4.3.25)

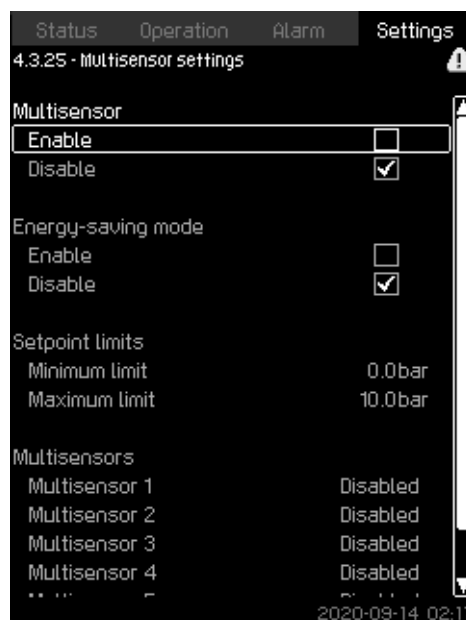

4-3-25_MULTISENSOR_186

Multisensor settings**Description**

The function is designed for controlling up to six different zones in a HVAC system with a defined differential-pressure band. If one of the **Multisensor** signals are outside the specific sensor limits (minimum or maximum), the function will influence the setpoint (SP) up or down to ensure that the specific sensor or zone is kept within its pressure band.

You can adjust the reaction of the setpoint influence by the means of dedicated **Setpoint alternation**, Kp and Ti values.

In case more sensors are either under or above their limits, you can set a priority between the sensors. Furthermore, the system can optimise the actual setpoint if **Energy-saving mode** is activated by reducing the actual setpoint until the minimum limit of one of the multisensors is reached.

If the multisensor function is enabled, it will have higher priority and the following programs will be overruled:



- **Clock program**
- **Proportional pressure**
- **Alternative setpoints**
- **External setpoint influence**
- **Setpoint ramp.**

Setting range

- **Energy-saving mode:** In this mode, the system ramps down the actual setpoint towards the minimum limit for one of the multisensors. If disabled, the function ensures that no sensor is above or below its limits.
- **Setpoint limits:** The range with the function will operate the control setpoint up or down according to the **Multisensor** feedback.
- Multisensor list: Setup for each multisensor.

Setting via the operating panel

- **Settings > Secondary functions > Multisensor settings.**
1. Select: **Enable.**
 2. Set: **Number of sensors.**
 3. Enable **Energy-saving mode** if requested.
 4. Set: **Setpoint limits.** (Select: **Minimum limit** or **Maximum limit**).

- Press **Multisensor settings** to set the individual settings for each multisensor.

8.6.48 Multisensor 1-6 (4.3.25.1.1)

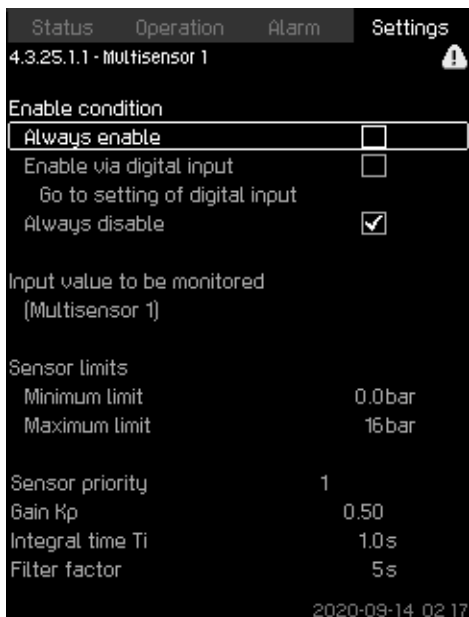

Multisensor 1-6

Description

Each **Multisensor** needs to be defined in order for the function to work correctly.

Setting range

- On-Off.

Always disable: the supervision parameter is disabled.

Always enable: the supervision parameter is enabled.

Enable via digital input: set the digital input to enable the supervision parameter.

- Input value to be monitored:** select the input value to be monitored.
- Maximum limit** for the selected input value.
- Maximum limit** for the selected input value (is not shown in Energy saving mode).
- Gain Kp:** - 30 to 30. Note that for inverse control, Kp must be set to a negative value.
- Integral time Ti:** 0.0 to 3600 seconds.
- Sensor priority** (1-6, High = 1).
- Filter time** [seconds] (time period where the remote sensor feedback signal is averaged over.)

Setting via the operating panel

- Settings > Secondary functions > Multisensor settings > Multisensor 1-6.**

- Set On-Off.

- Always disable**
- Always enable**
- Enable via digital input**
 - Go to settings of digital input, set the digital input.
 - Press \leftarrow x 1.

8.6.49 Differential sensor (4.3.27)

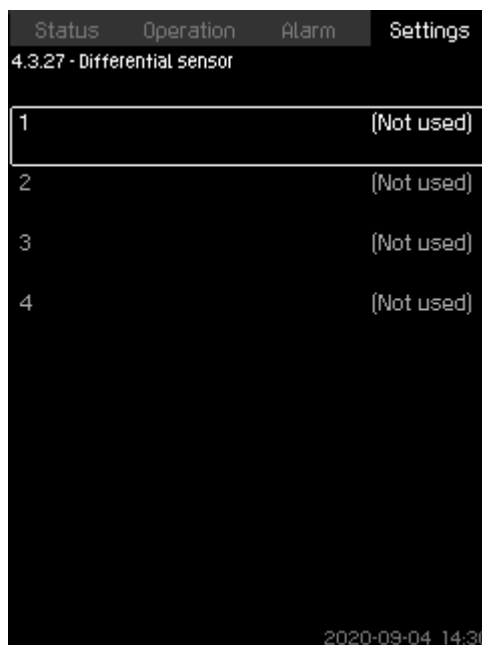

Differential sensor

Description

Up to four differential sensors can be configured for input and output values.

Example

Differential sensor 2

Differential sensor 3.

Setting via the operating panel

- Settings > Secondary functions > Differential sensor.**

8.6.50 Differential sensor (4.3.27.1-4)

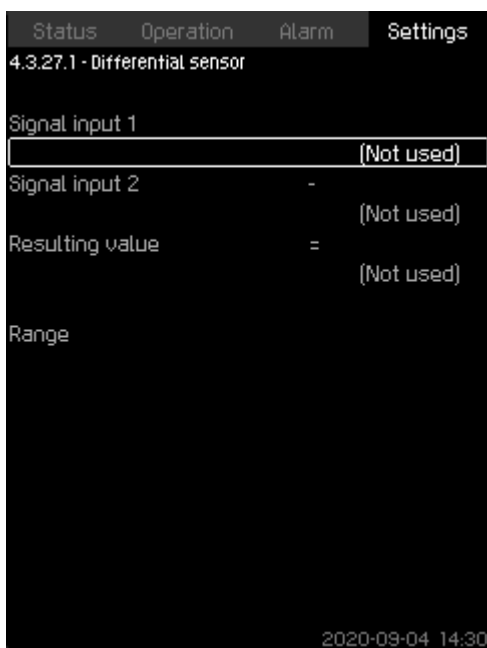

4-3-27_DIFF_SENSOR_209

Differential sensor 1-4

Description

Customizing the differential sensors.

Setting range

- **Signal input 1:** select value for the minuend part of the differential sensor.
- **Signal input 2:** select value for the subtrahend part of the differential sensor.
- **Resulting value:** select value for the resulting differential sensor.
- **Range:** set the range for the resulting differential sensor.

Setting via the operating panel

- **Settings > Secondary functions > Differential sensor > Differential sensor 1-4.**
 1. Select signal input 1 value.
 2. Select signal input 2 value.
 3. Select **Resulting value**.
 4. Set differential sensor range.

8.6.51 Customisable measured value type (4.3.28)

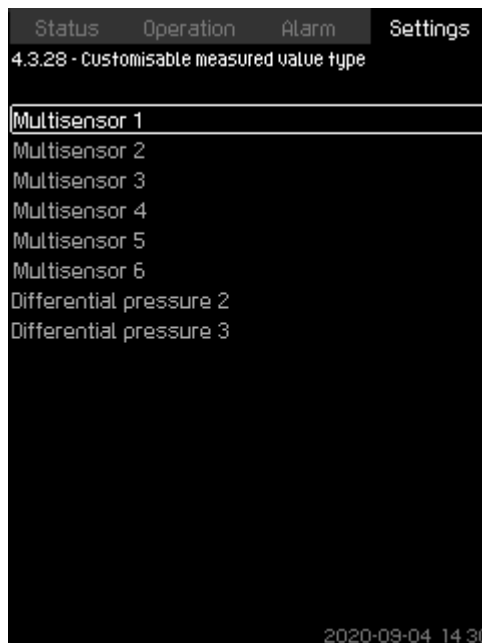

4-3-28_DIFF_SENSOR_206

Customisable measured value type

Description

Up to 8 input value types can be customized in regard to name and physical quantity.

Example

Multisensor 1

Multisensor 2

Multisensor 3.

Setting via the operating panel

- **Settings > Secondary functions > Customisable measured value type.**

8.6.52 Customisable measured value type (4.3.28.1-8)

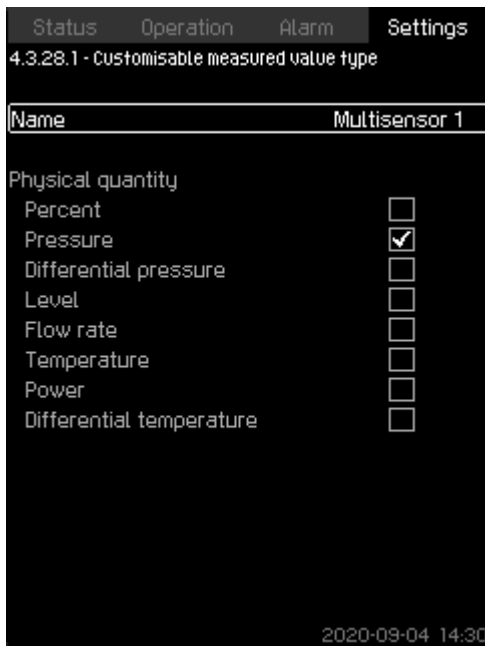

4-3-28_DIFF_SENSOR_207

Customisable measured value type

Description

- **Name:** Configure the name for the measured value.
- **Physical quantity:** Set the type of physical values:
 - Percent
 - Pressure
 - Differential pressure
 - Level
 - Flow rate
 - Temperature
 - Power
 - Differential temperature.

Setting via the operating panel

- **Settings > Secondary functions > Customisable measured value type 1-8.**
1. Set **Name**.
 2. Select **Physical quantity**.

8.6.53 Monitoring functions (4.4)

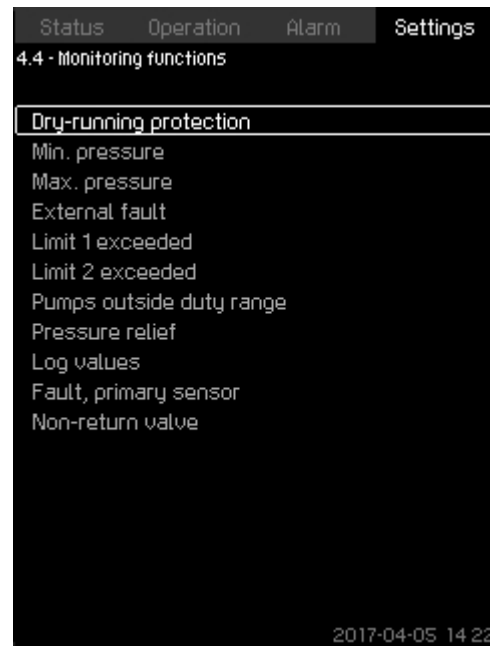

4-4_TM038978_095

Monitoring functions**Description**

The system has a series of functions that constantly monitor the operation of the system.

The primary purpose of the monitoring functions is to ensure that faults do not damage pumps or the system.

Setting range

- Dry-running protection (4.4.1)
- Min. pressure (4.4.2)
- Max. pressure (4.4.3)
- External fault (4.4.4)
- Limit 1 exceeded (4.4.5 - 4.4.6)
- Pumps outside duty range (4.4.7)
- Pressure relief (4.4.8)
- Log values (4.4.9)
- Fault, feedback sensor (4.4.10).

Setting via the operating panel

- **Settings > Monitoring functions.**

Related information

- [8.6.54 Dry-running protection \(4.4.1\)](#)
- [8.6.58 Min. pressure \(4.4.2\)](#)
- [8.6.59 Max. pressure \(4.4.3\)](#)
- [8.6.60 External fault \(4.4.4\)](#)
- [8.6.61 Limit 1 exceeded \(4.4.5 - 4.4.6\)](#)
- [8.6.62 Pumps outside duty range \(4.4.7\)](#)
- [8.6.63 Pressure relief \(4.4.8\)](#)
- [8.6.64 Log values \(4.4.9\)](#)
- [8.6.65 Fault, feedback sensor \(4.4.10\)](#)

8.6.54 Dry-running protection (4.4.1)

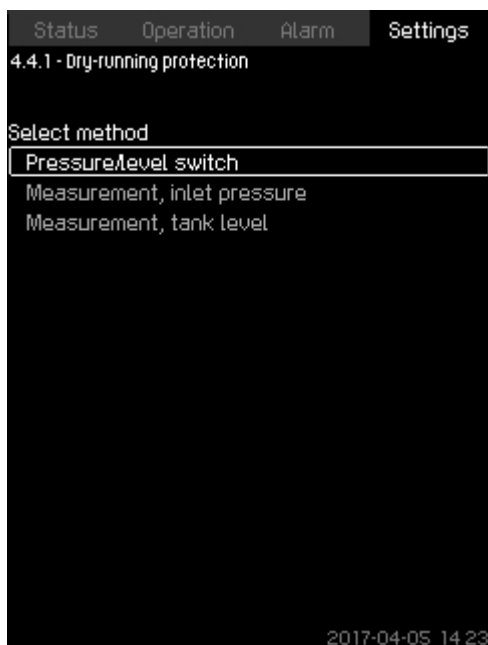

4-4-1_TM032320_050

Dry-running protection**Description**

Dry-running protection is one of the most important monitoring functions, as the bearings and the shaft seal may be damaged if the pumps run dry. We thus always recommend that you use dry-running protection.

The function is based on monitoring of the inlet pressure or the level in a possible tank or pit on the inlet side.

Level switches, pressure switches or analog sensors signalling water shortage at a set level can be used.

There are three different methods for detection of water shortage:

- Pressure switch on inlet manifold or float switch/electrode relay in the supply tank. See section Pressure/level switch (4.4.1.1).
- Measurement of inlet pressure in the inlet manifold by means of an analog pressure transmitter. See section Measurement, inlet pressure (4.4.1.2).
- Measurement of level in the supply tank by means of an analog level transmitter. See section Measurement, tank level (4.4.1.3).

Setting via the operating panel

- **Settings > Monitoring functions > Dry-running protection > Select method.**

Related information

[8.6.55 Pressure/level switch \(4.4.1.1\)](#)

[8.6.56 Measurement, inlet pressure \(4.4.1.2\)](#)

[8.6.57 Measurement, tank level \(4.4.1.3\)](#)

8.6.55 Pressure/level switch (4.4.1.1)

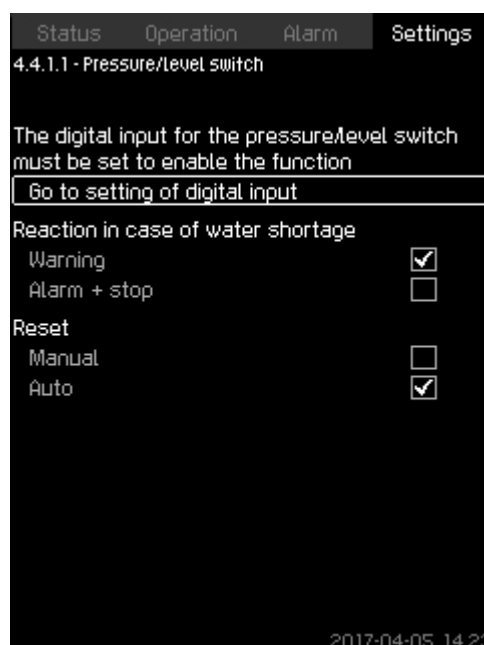

4-4-1-1_TM032329_051

Pressure/level switch**Description**

The function is primarily used in booster applications. Dry-running protection can take place by means of a pressure switch on the inlet manifold or a level switch in a tank on the inlet side.

When the contact is open, CU 352 registers water shortage after a time delay of approximately 5 seconds. You can set whether the indication is to be just a warning or an alarm stopping the pumps.

You can set restarting and resetting of alarms to be automatic or manual.

Setting range

- Selection of digital input for the function.
- Reaction in case of water shortage: **Alarm + stop**.
- Restarting: **Manual** or **Auto**.

Setting via the operating panel

- **Settings > Monitoring functions > Dry-running protection > Pressure/level switch > Go to setting of digital input.** Display **Digital inputs** (4.3.7) appears.

1. Set the input to dry-running protection.
2. Press ↵.
3. Select:
 - **Warning** or **Alarm + stop**.
 - **Manual** or **Auto**.

Factory settings

The setting is done in the startup wizard and depends on the application.

Related information

[8.6.26 Digital inputs \(4.3.7\)](#)

8.6.56 Measurement, inlet pressure (4.4.1.2)

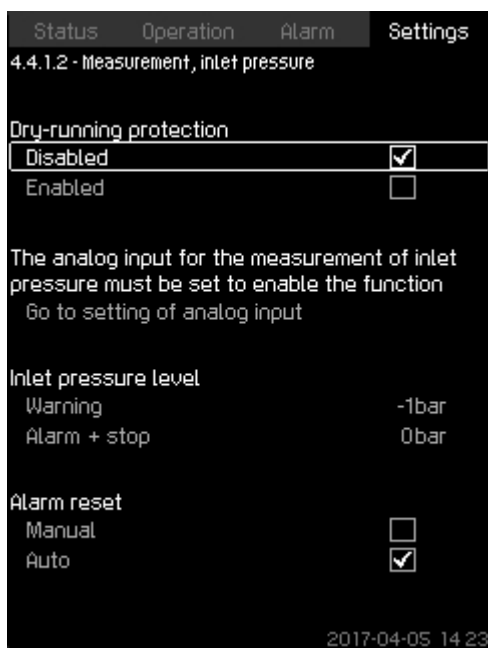

4-4-1-2_TMO38979_055

Measurement, inlet pressure**Description**

Dry-running protection can take place by means of a pressure transmitter measuring the inlet pressure.

You can set two levels:

- **Warning**
- **Alarm + stop.**

You can set restarting and resetting of alarms to be automatic or manual.

Setting range

- Selection of analog input for the function.
- Inlet pressure level for **Warning**.
- Inlet pressure level for **Alarm + stop**.
- Restarting: **Manual** or **Auto**.

Setting via the operating panel

- **Settings > Monitoring functions > Dry-running protection > Measurement, inlet pressure > Go to setting of analog input.** Display **Analog inputs** (4.3.8) appears.

1. Select: **Inlet pressure**.
2. Press ↵.
3. Select: **Enabled**.
4. Select and set the level:
 - **Warning**.
 - **Alarm + stop.**
5. Select resetting: **Auto** or **Manual**.



If one of the levels is not required, the level value must be the minimum value of the inlet-pressure transmitter. This disables the function.

Factory settings

The setting is done in the startup wizard and depends on the application.

Related information

[8.6.28 Analog inputs \(4.3.8\)](#)

8.6.57 Measurement, tank level (4.4.1.3)

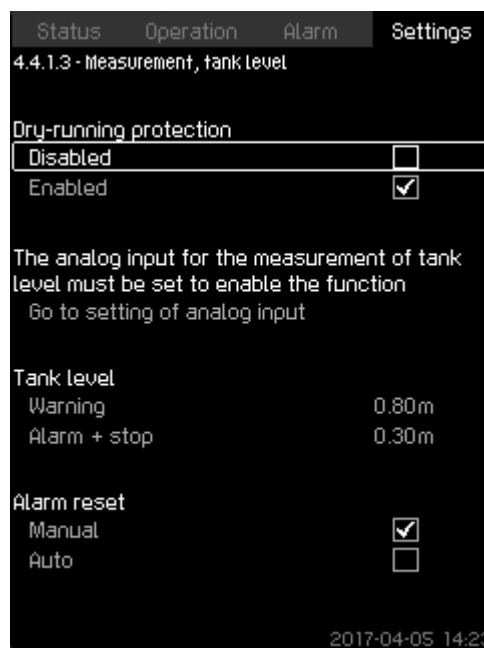

4-4-1-3_TMO38980_108

Measurement, tank level**Description**

Dry-running protection can take place by means of a level transmitter measuring the level in a tank on the inlet side.

You can set two levels:

- **Warning**
- **Alarm + stop.**

You can set restarting and resetting of alarms to be automatic or manual.

Setting range

- Selection of analog input for the function.
- Tank level for **Warning**.
- Tank level for **Alarm + stop**.
- Restarting: **Manual** or **Auto**.

Setting via the operating panel

- **Settings > Monitoring functions > Dry-running protection > Measurement, tank level > Go to setting of analog input.** Display **Analog inputs** (4.3.8) appears.

1. Set the input to **Tank level, suction side**.
2. Press ↵ × 3.
3. Select: **Enabled**.
4. Select and set the level:
 - **Warning**.
 - **Alarm + stop.**
5. Select alarm resetting: **Manual** or **Auto**.

Factory settings

The function is disabled.

Related information

[8.6.28 Analog inputs \(4.3.8\)](#)

8.6.58 Min. pressure (4.4.2)

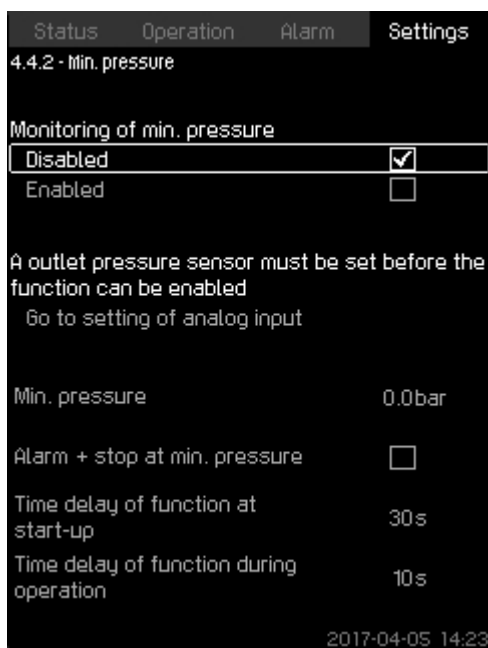

4-4-2_TM038981_109

Min. pressure**Description**

The outlet pressure will be monitored if the application is pressure boosting. In all other applications, the system pressure will be monitored. CU 352 will react if the pressure becomes lower than a set minimum level for an adjustable time.

The minimum pressure can be monitored if a fault indication is required in situations where the outlet pressure becomes lower than the set minimum pressure.

You can set whether the indication is to be just a warning or an alarm stopping the pumps. This may be desirable if the system is used for an irrigation system where a very low outlet pressure may be due to pipe fracture and thus an extraordinarily high consumption and a very low counterpressure. In such situations, it is desirable that the system stops and indicates alarm. This situation requires manual resetting of alarms.

You can set a startup delay ensuring that the system can build up pressure before the function is enabled. You can also set a time delay, that is for how long time the outlet pressure may be lower than the set minimum pressure before the alarm is activated.

Setting range

- Minimum pressure level within the range of the primary sensor.
- Activation of stop when the pressure falls below the minimum pressure.
- **Time delay of function at start-up.**
- **Time delay of function during operation.**

Setting via the operating panel

- **Settings > Monitoring functions > Min. pressure > Enabled.**

1. Select and set: **Min. pressure.**
2. Select: **Alarm + stop at min. pressure.**
3. Set:
 - **Time delay of function at start-up**
 - **Time delay of function during operation.**

Factory settings

The function is disabled.

8.6.59 Max. pressure (4.4.3)

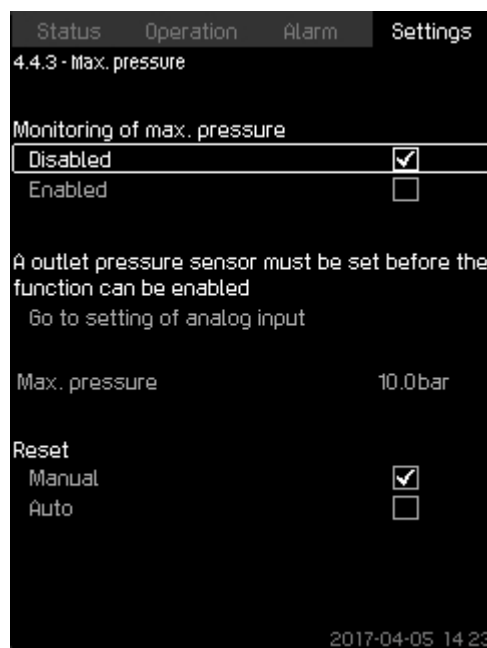

4-4-3_TM038982_118

Max. pressure**Description**

The outlet pressure will be monitored if the application is pressure boosting. In all other applications, the system pressure will be monitored. CU 352 will react if the pressure becomes higher than a set maximum level.

In certain installations, a too high outlet pressure may cause damage. It may therefore be necessary to stop all pumps for a short period if the pressure is too high.

You can set whether the system is to restart automatically after the pressure has dropped below the maximum level, or if the system must be reset manually. Restarting will be delayed by an adjustable time. See section Min. time between start/stop (4.2.1).

Setting range

- Maximum pressure level within the range of the primary sensor.
- Manual or automatic restarting.

Setting via the operating panel

- **Settings > Monitoring functions > Max. pressure > Enabled.**

1. Set: **Max. pressure.**
2. Select resetting: **Manual** or **Auto.**

Factory settings

The function is disabled.

Related information

[8.6.13 Min. time between start/stop \(4.2.1\)](#)

8.6.60 External fault (4.4.4)

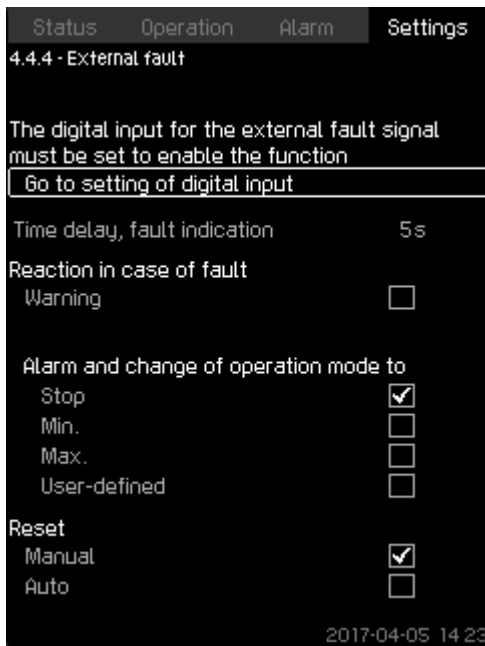

4-4-4_TM032313_110

External fault**Description**

The function is used when CU 352 is to be able to receive a fault signal from an external contact. In case of external fault, CU 352 indicates warning or alarm. In case of alarm, the system changes to another manual operating mode, for instance **Stop**.

Setting range

- Selection of digital input for the function.
- Setting of time delay from closing of the contact until CU 352 reacts.
- Reaction in case of external fault: Warning or alarm and change of operating mode.
- Restarting after alarm: **Manual** or **Auto**.

Setting via the operating panel

- **Settings > Monitoring functions > External fault > Go to setting of digital input.** Display **Digital inputs** (4.3.7) appears.
1. Set the input to **External fault**.
 2. Press ↵.
 3. Set: **Time delay, fault indication**.
 4. If only a warning is required in case of external fault, select **Warning**. If the system is to give alarm and change operating mode in case of external fault, select operating mode **Manual** or **Auto**.

Factory settings

The function is disabled. If the function is enabled, the following values have been set from factory:

- Time delay: 5 seconds.
- Operating mode in case of alarm: **Stop**.
- Restarting: **Manual**.

Related information

[8.6.26 Digital inputs \(4.3.7\)](#)

8.6.61 Limit 1 exceeded (4.4.5 - 4.4.6)

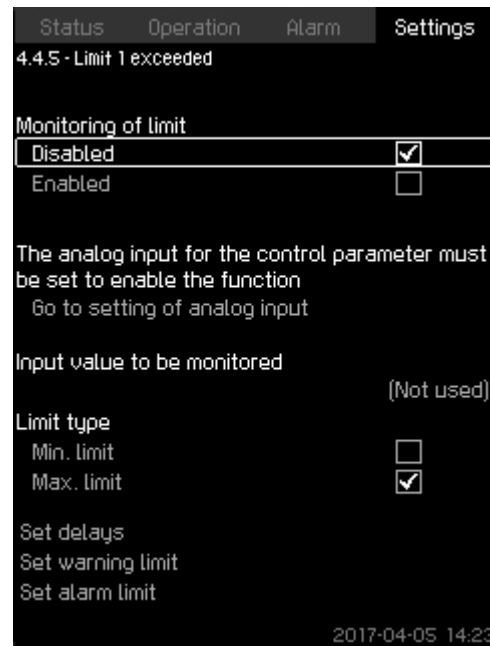

4-4-5_TM038883_135

Limit 1 exceeded**Description**

With the function, CU 352 can monitor set limits of analog values. It will react if the values exceed the limits. Each limit can be set as a maximum or minimum value. For each of the monitored values, a warning limit and an alarm limit must be defined.

The function allows you to monitor two different locations in a pump system at the same time, for instance the pressure at a consumer and the pump's outlet pressure. This ensures that the outlet pressure does not reach a critical value.

If the value exceeds the warning limit, a warning is given. If the value exceeds the alarm limit, the pumps will be stopped.

You can set a delay between the detection of an exceeded limit and the activation of a warning or an alarm. You can also set a delay for resetting a warning or an alarm.

A warning can be reset automatically or manually.

If the **Limit type** is set to **Max. limit**, an alarm can be set to be reset automatically or manually. If the **Limit type** is set to **Min. limit**, an alarm can be set to be reset manually only.

Restarting can be delayed by an adjustable time. You can also set a startup delay ensuring that the system reaches a steady state before the function becomes active.

Setting range

- Selection of analog input for the function
- **Input value to be monitored**
- **Limit type (Min. limit and Max. limit)**
- Warning limit
- Alarm limit.

Setting via the operating panel

Analog inputs must be correctly set before the function is enabled. See section [Analog inputs \(4.3.8\)](#).

- **Settings > Monitoring functions > Limit 1 exceeded / Limit 2 exceeded > Go to setting of analog input.**

1. Select analog input.
2. Select: **Input value to be monitored**. Display 4.3.8.1.1 appears.
3. Select input.
4. Press **↵**.
5. Set the minimum and maximum sensor value.
6. Press **↵** × 2.
7. Select: **Input value to be monitored**.
8. Select input.
9. Press **↵**.
10. Select:
 - **Min. limit** or **Max. limit**.
 - **Set delays**.
11. Press **↵**.
12. Select:
 - **Set warning limit**
 - **Enabled**.
13. Set limit.
14. Select resetting: **Manual** or **Auto**.
15. Press **↵**.
16. Select:
 - **Set alarm limit**
 - **Enabled**.
17. Set limit.
18. Select resetting: **Manual** or **Auto**.
19. Press **↵**.
20. Select: **Enabled**.

Factory settings

The function is disabled.

Related information

[8.6.28 Analog inputs \(4.3.8\)](#)

8.6.62 Pumps outside duty range (4.4.7)



4-4-7_TMO38984_167

Pumps outside duty range

Description

The function gives a warning if the duty point of the pumps moves outside the defined range. For instance, if the inlet pressure becomes lower than a minimum permissible value, thus causing a risk of cavitation for some pump types.

The warning is given with a set time delay. You can set whether the warning is to be reset automatically or manually when the duty point comes within the defined duty range. You can also set a relay output to be activated when the warning is given, and to be deactivated when the warning is reset.

This function requires that the outlet pressure and the inlet pressure (either measured or configured) or the differential pressure of the pumps is monitored, and that CU 352 contains valid pump data from either a GSC file or from manual input. See section Pump curve data (4.3.19).

Setting range

- Setting of manual or automatic resetting.
- Setting of warning delay.

Setting via the operating panel

- **Settings > Monitoring functions > Pumps outside duty range > Manual / Auto > Set warning delay.**

Factory settings

The function is disabled.

Related information

[8.6.41 Pump curve data \(4.3.19\)](#)

8.6.63 Pressure relief (4.4.8)

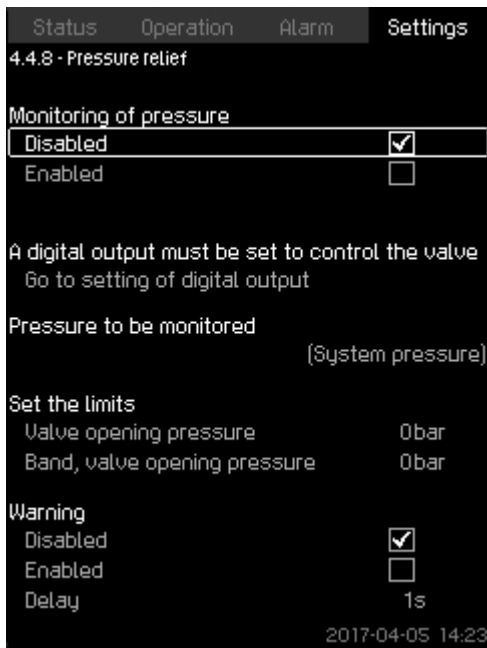

4-4-8_TM038986_164

- Setting of valve opening pressure.
- Setting of band for valve opening pressure.
- Setting of warning or alarm.

Setting via the operating panel

- **Settings > Monitoring functions > Pressure relief > Go to setting of digital output.**

1. Select digital output.
2. Select: **Pressure relief valve.**
3. Press \leftarrow x 2.
4. Select: **Pressure to be monitored**
 - Select: **Outlet pressure, System pressure or External pressure.**
5. Press \leftarrow .
6. Select and set:
 - **Valve opening pressure**
 - **Band, valve opening pressure.**
7. Select: **Warning > Disabled or Enabled.**
8. Set: **Delay.** (Only to be set if warning has been enabled).
9. Select: **Enabled.**

Factory settings

The function is disabled.

Pressure relief

Description

The purpose of the function is to reduce the pressure in the pipes by opening a solenoid valve if it exceeds a set limit. If the pressure is not reduced within a given time, the solenoid valve will be closed, and a warning can be given.

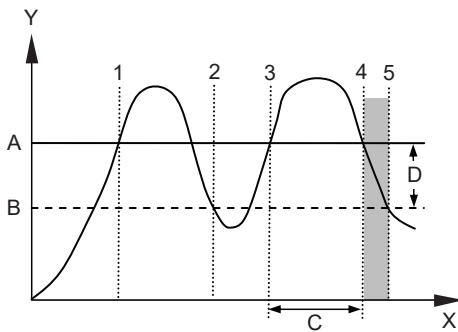

TM078149

Pressure relief

Pos.	Description
A	Valve opening pressure
B	Valve opening pressure minus band
C	Warning delay
D	Band
X	Time [sec]
Y	P [psi]
1	Solenoid valve opens.
2	Solenoid valve closes.
3	Solenoid valve opens.
4	Warning is activated.
5	Solenoid valve closes, and warning is reset.

Setting range

- Setting of digital output.
- Setting of pressure to be monitored.

8.6.64 Log values (4.4.9)

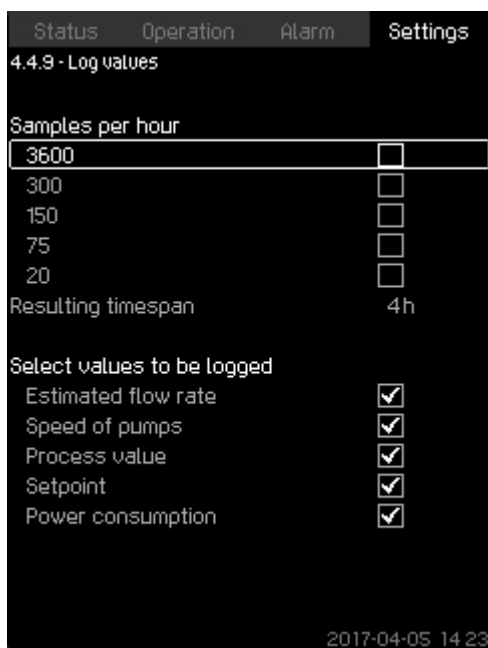

4-4-9_TM052973_181

Log values**Description**

Select the values to be logged and the number of samples per hour. The resulting timespan is shown. When the timespan has elapsed, old logged values will be deleted and overwritten by the new ones.

Log values

- **Estimated flow rate** (only if no flowmeter is installed)
- **Speed of pumps**
- **Process value**
- **Setpoint**
- **Power consumption** (MPC-E systems)
- **Inlet pressure** (if an inlet-pressure sensor is installed).

Setting range

Samples per hour: 1-3600.

Setting via the operating panel

- **Settings > Monitoring functions > Log values.**
1. Set: **Samples per hour.**
 2. Select the values to be logged.

8.6.65 Fault, feedback sensor (4.4.10)

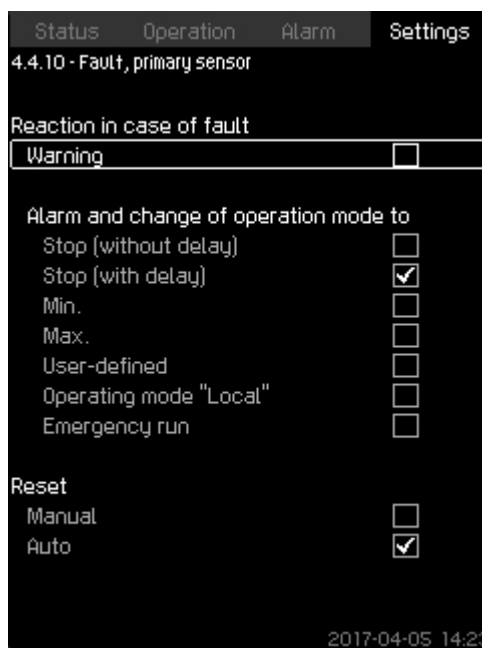

4-4-10_TM052974_187

Fault, feedback sensor**Description**

You can set how the system is to react if the primary sensor fails.

Setting range

- **Stop (without delay)**
- **Stop (with delay)**
- **Min.**
- **Max.**
- **User-defined**
- **Operating mode "Local"**
- **Emergency run**
- **Reset: Manual or Auto.**

Setting via the operating panel

- **Settings > Monitoring functions > Fault, feedback sensor.**
1. Select reaction in case of a fault in the primary sensor.
 2. Select resetting: **Manual or Auto.**

8.6.66 Non-return valve (4.4.11)

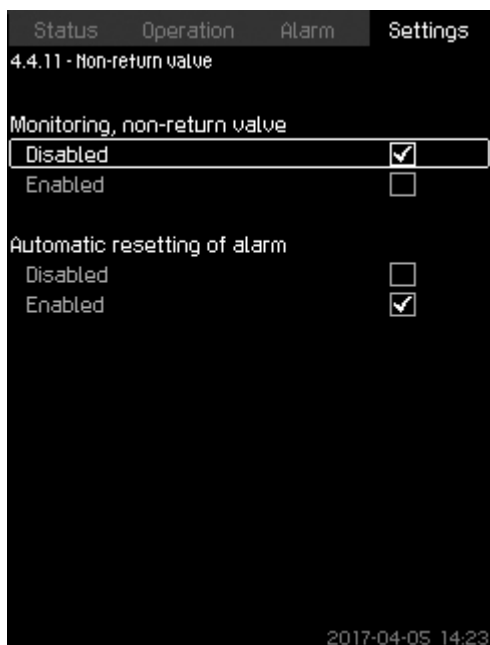

4-4-11_NON-RETURN_VALVE_202

Non-return valve**Description**

The function enables CU 352 to detect if a **Non-return valve** is leaking or faulty. A small leakage will after five accumulated incidents result in a warning. A faulty NRV will instantly result in an alarm and pump stop. In this case the motor is not able to overcome the backflow through the pump with the faulty NRV.



The function is only valid for an MPC-E system with MLE motors model G, H, I or J.

Setting range

- **Monitoring, non-return valve:** Enabled or Disabled.
- **Automatic resetting of alarm:** Enabled or Disabled.

Setting via the operating panel

- **Settings > Monitoring functions > Non-return valve**
1. Enable the function.
 2. Select if **Automatic resetting of alarm** is to be **Disabled**.

Factory settings

The function is **Enabled**.

8.6.67 Controlled output 1-2 (4.4.13-4.4.14)

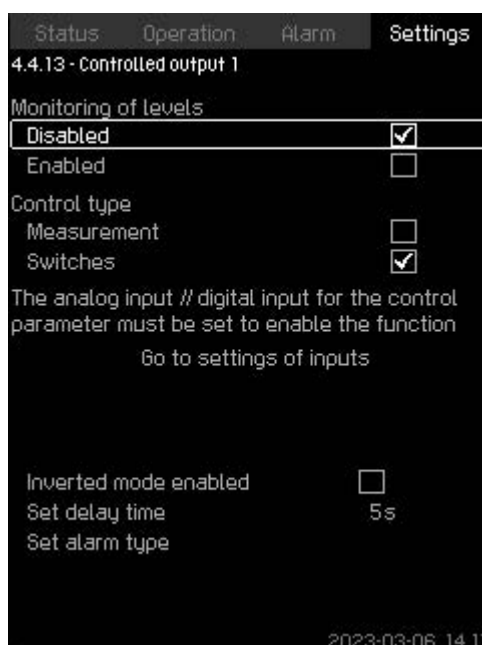

4-4-13_CONTROLLEDOUTPUT_GROUP_219_MEASUREMENT

Controlled output 1-2**Description**

With this function, CU 352 can monitor up to four different limits by a set of indicators (switches and/or analog values) and can activate a digital output. These four limits are Start, Stop, High and Low. The reaction of the digital output depends on the monitoring type, which can be Normal or Inverse. Inverse means that the function of the indicators (switches and/or analog values) works opposite to their function in Normal. For example, when Normal uses the **Tank filling** application, Inverse uses the **Tank emptying** application.

Normal controlled output:

1. Low: If the level drops below the Low limit, a warning occurs and activates the digital output **Controlled output, Low** and simultaneously activates the digital output **Controlled output**, if it is not activated beforehand.
2. Start: If the level drops below the Start limit, the digital output **Controlled output** is activated.
3. Stop: If the level exceeds the Stop limit, the digital output **Controlled output** is deactivated.
4. High: If the level exceeds the High limit, a warning occurs and activates the digital output **Controlled output, High** and simultaneously deactivates the digital output **Controlled output**, if it is not deactivated beforehand.



TM076977

Controlled output

Pos.	Description
H	High
2	Stop
1	Start
L	Low

Inverse controlled output:

1. Low: If the level drops below the Low limit, a warning occurs and activates the digital output **Controlled output, Low** and simultaneously deactivates the digital output **Controlled output**, if it is not deactivated beforehand.
2. Stop: If the level drops below the Stop limit, the digital output **Controlled output** is deactivated.
3. Start: If the level exceeds the Start limit, the digital output **Controlled output** is activated.
4. High: If the level exceeds the High limit, a warning occurs and activates the digital output **Controlled output** and simultaneously activates the digital output **Controlled output, High**, if it is not activated beforehand.



TM080667

Inverse controlled output

Pos.	Description
H	High
1	Start
2	Stop
L	Low

Setting range

1. **Alarm type:** select measurement or switches.
2. Set delay time: A delay can be set between the detection of an exceeded indicator and the activation of the digital output.
3. Set start level: set the start level for activating the output (hidden if **Switches** is selected).
4. Set stop level: set the stop level for deactivating the output (hidden if **Switches** is selected).
5. Set **Alarm type:** configure the alarm.

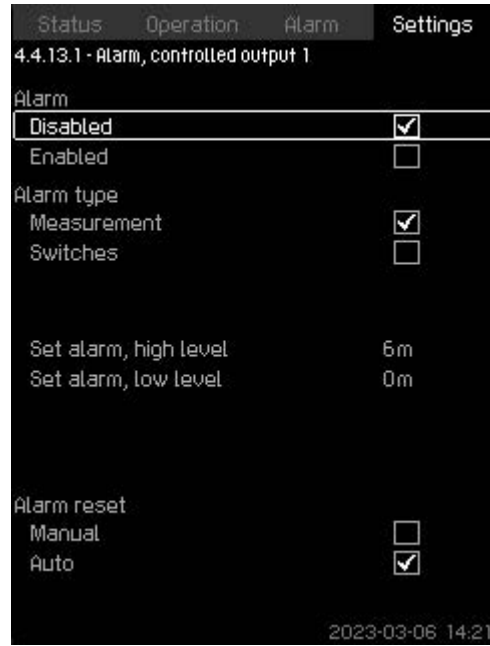

Alarm measurement



Alarm switches

Setting via the operating panel

- **Settings > Monitoring functions > Controlled output 1/ Controlled output 2.**
 1. Select **Alarm type**.
 2. Go to setting of analog / digital input.
 3. Press $\leftarrow \times 2$.
 4. Select: **Input value to be monitored**.
 5. Set delay time.
 6. Set start level.
 7. Set stop level.
 8. Configure alarm type. Display 4.4.13.1-2 appears.

8.6.68 Functions, CU 352 (4.5)



4-5_TM032295_098

Functions, CU 352

Description

Make the basic settings of CU 352 in this submenu. CU 352 comes with most of these settings, or they are made at startup and normally not to be changed. The service language, British English, can be selected for service purposes. If no buttons are touched for 15 minutes, the display returns to the language selected at startup or to the language set in **Display language** (4.5.1).



If the service language is selected, the symbol ✓ is to the right in the top line of all displays.

Setting range

- Activation of service language, British English.
- Re-activation of startup wizard. (After startup, the wizard is inactive.)
- Selection of **Display language**.
- Selection of display units.
- Setting of **Date and time**.
- Selection of password for menu **Operation** and **Settings**.
- Setting of **Ethernet** communication.
- Setting of **GENibus number**.
- Reading of **Software status**.

Related information

[8.6.69 Display language \(4.5.1\)](#)

8.6.69 Display language (4.5.1)



4-5-1_TM038987_116

Display language

Description

Here you select the language for the CU 352 display.

Setting range

- **English**
- **German**
- **Danish**
- **Spanish**
- **Finnish**
- **French**
- **Greek**
- **Italian**
- **Dutch**
- **Polish**
- **Portuguese**
- **Russian**
- **Swedish**
- **Chinese**
- **Korean**
- **Japanese**
- **Czech**
- **Turkish**
- **Hungarian**
- **Bulgarian**
- **Croatian**
- **Latvian**
- **Lithuanian**
- **Romania**
- **Slovak**
- **Slovenian**
- **Serbian Latin**
- **US English**
- **Indonesian**
- **Malay**
- **Estonian**.

Setting via the operating panel

- **Settings > Functions, CU 352 > Display language.**

Factory settings

The display language is British English. It can be changed at startup.

8.6.70 Units (4.5.2)

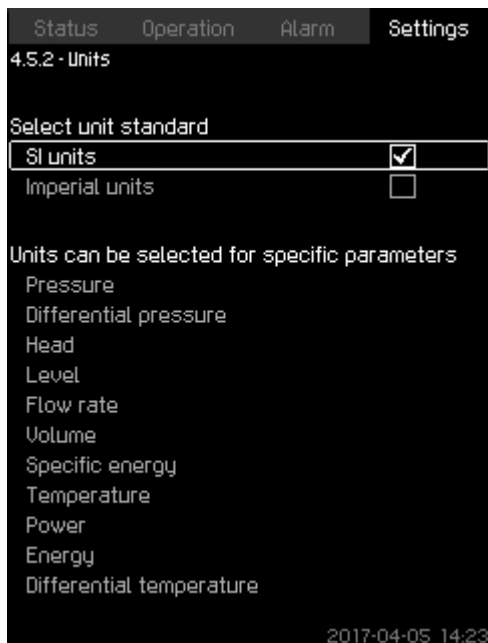

4-5-2_TM038988_023

Units

Description

Here you can select units for the various parameters. Select between SI and imperial units. You can also select other units for the individual parameters.

Setting range

Parameter	Basic setting		Possible units
	SI	Imperial	
Pressure	bar	psi	kPa, MPa, mbar, bar, m, psi
Differential pressure	m	psi	kPa, MPa, mbar, bar, m, psi
Head	m	ft	m, cm, ft, in
Level	m	ft	m, cm, ft, in
Flow rate	m ³ /h	gpm	m ³ /s, m ³ /h, l/s, gpm, yd ³ /s, yd ³ /min, yd ³ /h
Volume	m ³	gal	l, m ³ , gal, yd ³
Specific energy	kWh/m ³	Wh/gal	kWh/m ³ , Wh/gal, Wh/kgal, BTU/gal, HPh/gal
Temperature	°C	°F	K, °C, °F
Differential temperature	K	K	K
Power	kW	HP	W, kW, MW, HP
Energy	kWh	kWh	kWh, MWh, BTU, HPh



If units are changed from SI to imperial or vice versa, all individually set parameters will be changed to the basic setting in question.

Setting via the operating panel

- **Settings > Functions, CU 352 > Units.**

Set unit standard, measuring parameter and specific unit. See the example below.

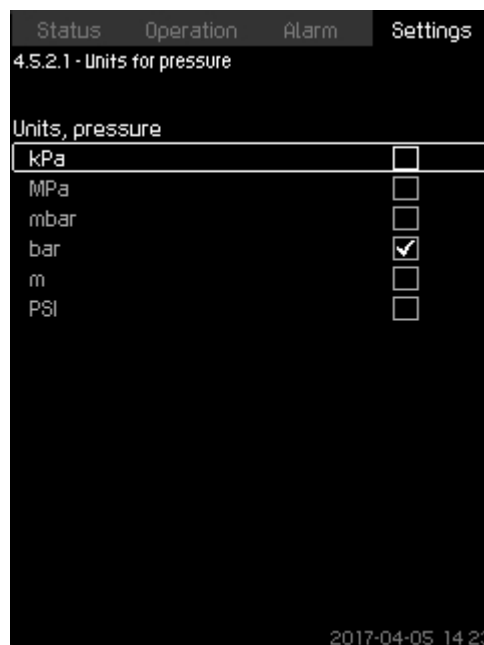

4-5-2-1_TM032310_024

Example of selection of units

Factory settings

The setting is done in the startup wizard and depends on the application.

8.6.71 Date and time (4.5.3)

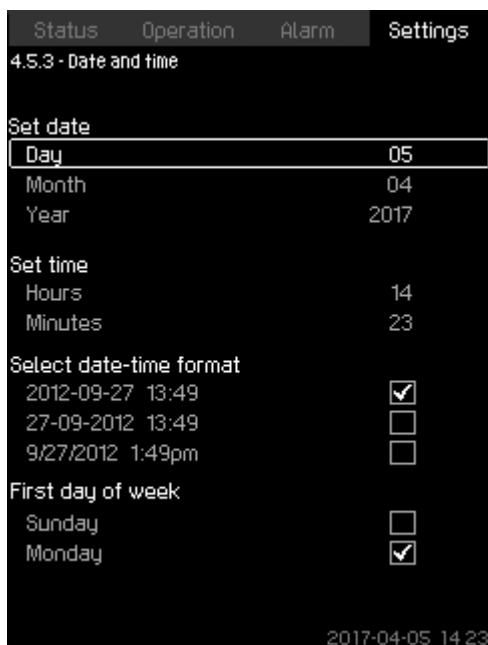

4-5-3_TM038989_114

Date and time**Description**

You can set date and time as well as how they are to be shown in the display.

The clock has a built-in rechargeable voltage supply which can supply the clock for up to 20 days if the voltage supply to the system is interrupted.

If the clock is without voltage for more than 20 days, it must be set again.

Setting range

The date can be set as day, month and year. The time can be set as a 24-hour clock showing hours and minutes.

There are three formats.

Examples of format

2012-09-27 13:49

27-09-2012 13:49

9/27/2012 1:49 pm

You can also select if Sunday or Monday is to be the first day of week.

Setting via the operating panel

- **Settings > Functions, CU 352 > Date and time.**

1. Select and set:
 - **Day, Month, Year, Hours, Minutes.**
2. Select format.
3. Select **Sunday** or **Monday** under **First day of week**.

Factory settings

Local time.



If the system has been without voltage for more than 20 days since it left the factory, the clock may have returned to the original setting: 01-01-2005 0:00.

Date and time may have been changed during the setting of system.

There is no automatic changeover to/from daylight-saving time.

8.6.72 Password (4.5.4)

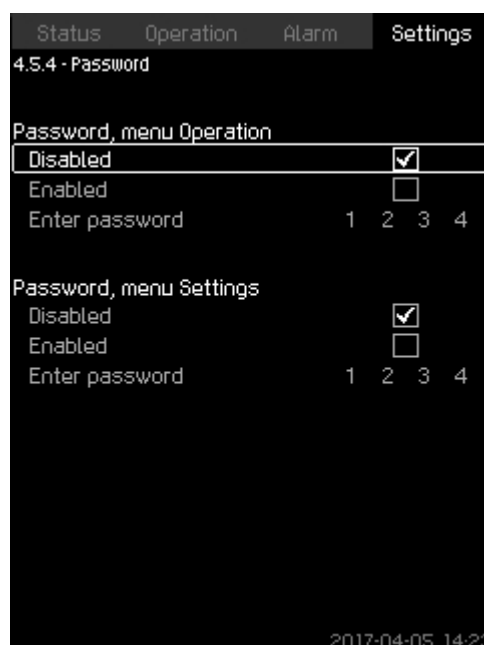

4-5-4_TM032889_115

Password**Description**

You can limit the access to the menus **Operation** and **Settings** by means of a password. If the access is limited, it is not possible to view or set any parameters in the menus.

The password must consist of four digits and may be used for both menus.



If you have forgotten the password(s), contact Grundfos.

Setting via the operating panel

- **Settings > Functions, CU 352 > Password.**

1. Select the password to be enabled.
2. Select: **Enter password**. The first digit of the password is flashing.
3. Select digit. The second digit of the password is flashing.
4. Repeat these steps if it is necessary to enable the other password.

Factory settings

Both passwords are disabled. If a password is enabled, the factory setting will be **1234**.

8.6.73 Ethernet (4.5.5)



4-5-5_ETHERNET_217

Ethernet**Description**

CU 352 is equipped with an Ethernet connection for communication with a computer, either directly or via the Internet. Ethernet is disabled by default, and a unique password needs to be set to enable Ethernet.

The **Ethernet security disclaimer** must be read and acknowledged before Ethernet can be enabled. See also section Ethernet.

Setting via the operating panel

- **Settings > Functions, CU 352 > Ethernet.**

1. Select **Ethernet security disclaimer**. Display 4.4.5.1 appears.

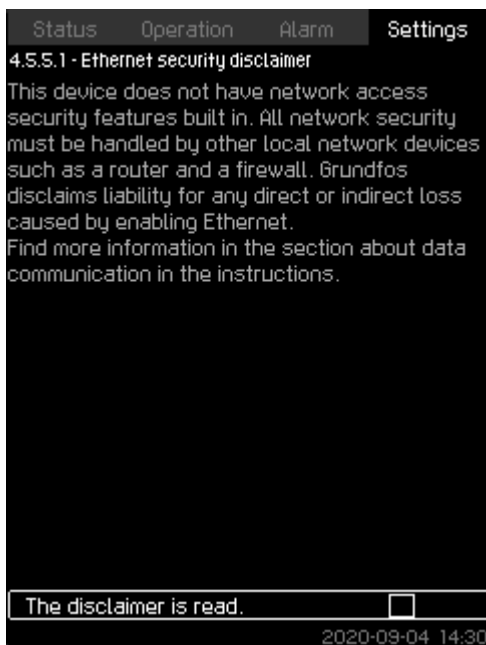

4-5-5-2_ETHERNET_218

Ethernet security disclaimer

- Make sure the disclaimer is read.
- Set password:
 - minimum 8 characters
 - minimum 1 non-alphabetic character
 - minimum 1 upper case alphabetic character
 - minimum 1 lower case alphabetic character.
- Enable Ethernet.
- Configure IP settings.

Related information[8.7.1 Ethernet](#)

8.6.74 GENibus number (4.5.6)

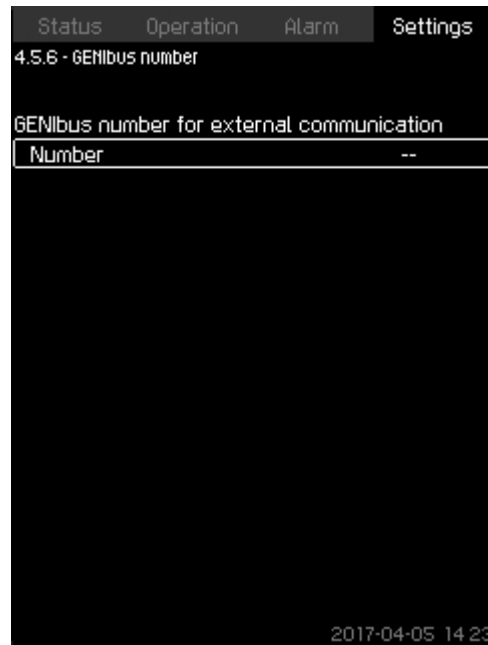

4-5-6_TM032297_117

GENibus number**Description**

CU 352 can communicate with external units via an RS-485 interface (option). For further information, see section Data communication.

Communication is carried out according to the Grundfos bus protocol, GENibus, and enables connection to a building management system or another external control system.

Operating parameters, such as setpoint and operating mode, can be set via the bus signal. Furthermore, status about important parameters, such as actual value and input power, and fault indications can be read from CU 352.

Contact Grundfos for further information.

Setting range

The number can be set between 1 and 64.

Setting via the operating panel

- **Settings > Functions, CU 352 > GENibus number.**

Factory settings

No number has been set.

Related information[8.7 Data communication](#)

8.6.75 Software status (4.5.9)

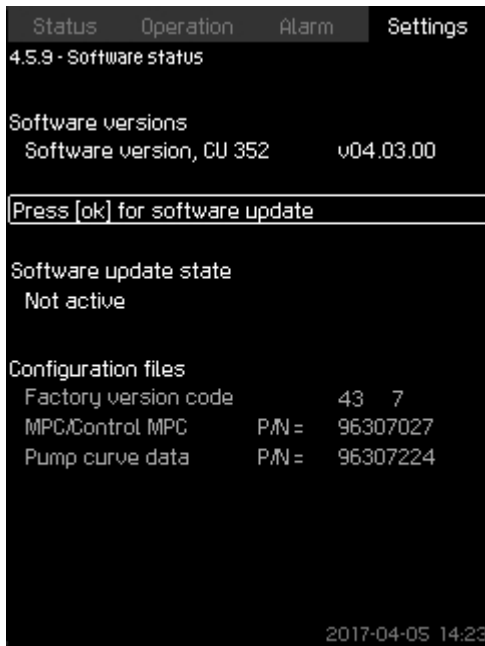

4-5-9_TM032296_099

Software status

Description

The display shows the status of the software installed in CU 352. Furthermore, the version code and the product numbers of configuration files (GSC) read into the unit are shown. You can also upgrade the software version. Contact Grundfos for further information.

8.6.76 Status display menu (4.6)

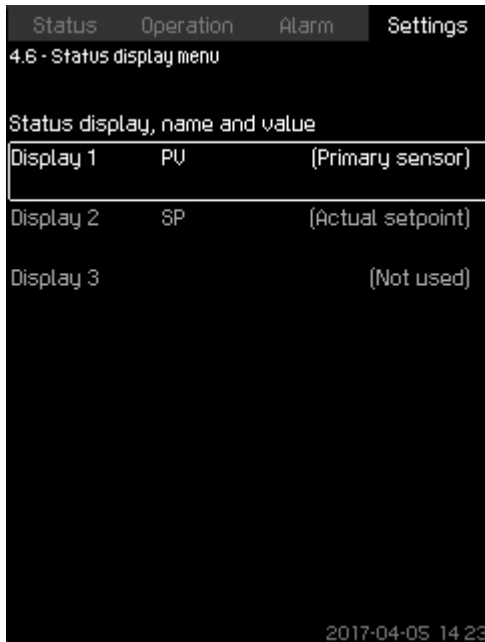

4-6_STATUS_DISPLAY_MENU_196

Status display menu

Description

In the main status menu, you can have up to three status values displayed. In this menu, you can define each status value to be displayed and define a short name for the value.

PV	= Process Value
SP	= Setpoint
Q	= Flow

Setting range

Name of each display value.
Function type for **Display 1 -3**.

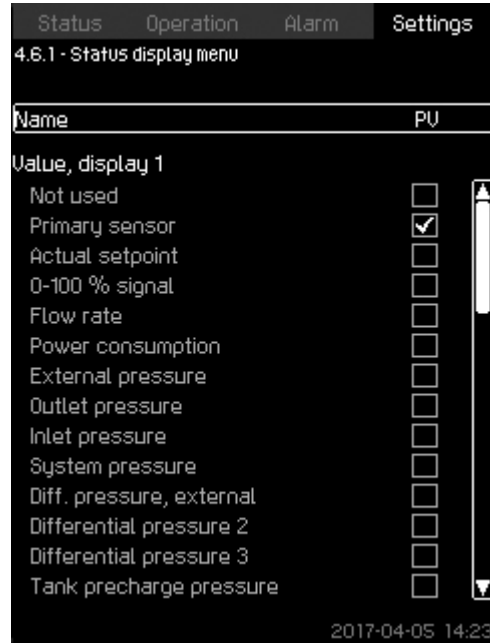

4-6-1_STATUS_DISPLAY_MENU_197

Status display menu (4.6.1)

Setting via the operating panel

- **Settings > Status display menu**
1. Select display 1, 2 or 3, press [OK].
 2. Define a name for display.
 3. Select the value for the display 1, 2 or 3.

Factory settings

Display 1: PV, Primary sensor
Display 2: SP, Actual setpoint

8.7 Data communication

CU 352 is equipped with a hardware enabling communication with external units, such as a computer, via an external GENIbus or ethernet connection.

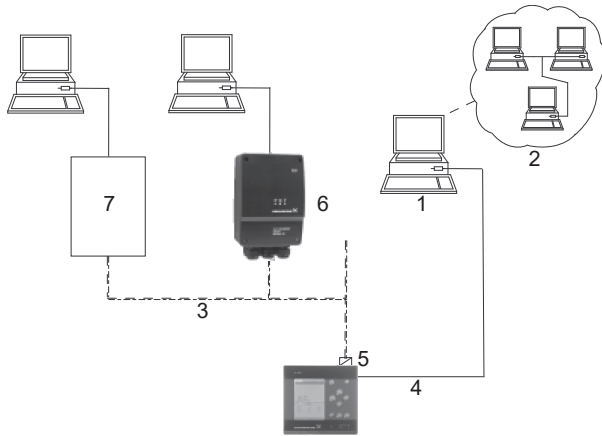

TM053235

Data communication via external GENIbus and ethernet connection

Pos.	Description
1	Intranet
2	Internet
3	External GENIbus connection
4	Ethernet connection
5	External GENIbus module (option)
6	Grundfos CIU communication interface
7	Third-party gateway

8.7.1 Ethernet

Ethernet is the most widely used standard for local networks (LAN). The standardisation of this technology has created some of the easiest and cheapest ways of creating communication between electric units, for instance between computers or between computers and control units.

The webserver of CU 352 makes it possible to connect a computer to CU 352 via an ethernet connection. The user interface can thus be exported from CU 352 to a computer so that CU 352 and consequently the system can be monitored and controlled externally.



We recommend that you protect the connection to CU 352 according to your safety requirements in consultation with the system administrator.

In order to use the webserver, you must know the IP address of CU 352. All network units must have a unique IP address to communicate with each other. The IP address of CU 352 from factory is 192.168.0.102.

Alternatively to the factory-set IP address, it is possible to use a dynamic assignment of IP address. This is possible by activating a DHCP (Dynamic Host Configuration Protocol) in CU 352 or via the webserver. See the example in figure below.

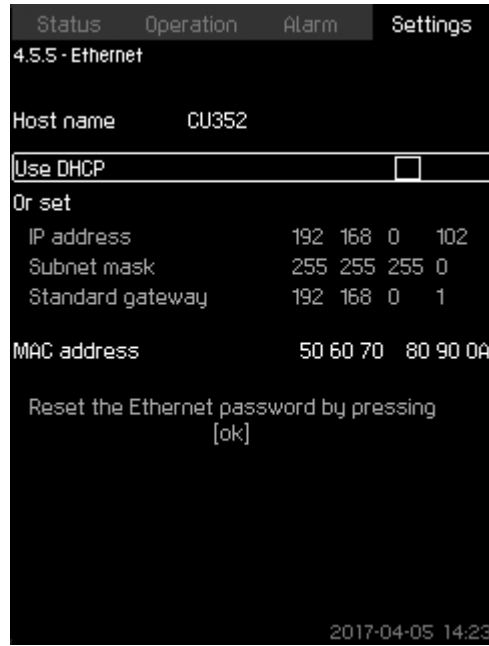

4-5-5_TM032298_097

Example of setting of ethernet

Dynamic assignment of an IP address for CU 352 requires a DHCP server in the network. The DHCP server assigns a number of IP addresses to the electric units and makes sure that two units do not receive the same IP address.

A standard internet browser is used for connection to the webserver of CU 352.

If you want to use the factory-set IP address, no changes are required in the display. Open the internet browser and enter the IP address of CU 352.

If you want to use dynamic assignment, you must enable the function by selecting **Use DHCP** and clicking [ok]. A check mark shows that the function has been enabled.

Open the internet browser and enter the host name of CU 352 instead of the IP address. The internet browser will now try to connect to CU 352. The host name can be read in the display, but can only be changed by either a GSC file (configuration file) or via a webserver. See section *Change of network setting*.



A host name is required to use DHCP.

This is the first display shown when connecting to CU 352.

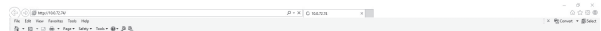

TM032048

Connection to CU 352

Factory settings

User name: admin

Password: admin

When you have entered the user name and password, an application starts up in CU 352, provided that a Java Applet has been installed on the computer. If this is not the case, but the computer is connected to the internet, then use the link on the screen to download and install the Java Applet.

The application on CU 352 exports the Java Applet to your browser and gives you access to user interfaces such as display and operating panel.

The Java Applet installation in the browser must be accepted by the user. You can now monitor and control CU 352 from a computer.



TM053236

1. Click [>Admin config].
2. Enter new user name if applicable.
3. Click [Apply].
4. Enter existing password.
5. Enter new password.
6. Repeat new password.
7. Click [Apply].

8.7.2 GENIbus

By installing a GENIbus module in CU 352, you can connect the system to an external network. The connection can take place via a GENIbus-based network or a network based on another fieldbus protocol via a gateway. See examples in the section Data communication. For further information, contact Grundfos.

The gateway may be a Grundfos CIU communication interface or a third-party gateway. For further information on CIU, see Grundfos Product Center, or contact Grundfos.

Related information

[8.7 Data communication](#)

Network setting

Change of network setting

When connection to the webserver of CU 352 has been established, you can change the network setting.

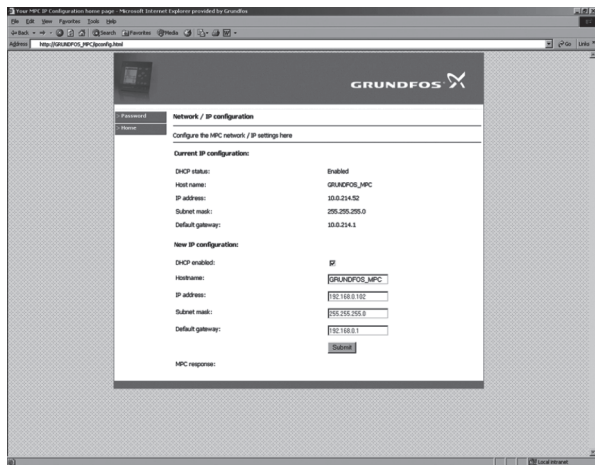

TM032050

Change of network setting

1. Click [>Network admin].
2. Enter the changes.
3. Click [Submit] enable the changes.

Administrator configuration

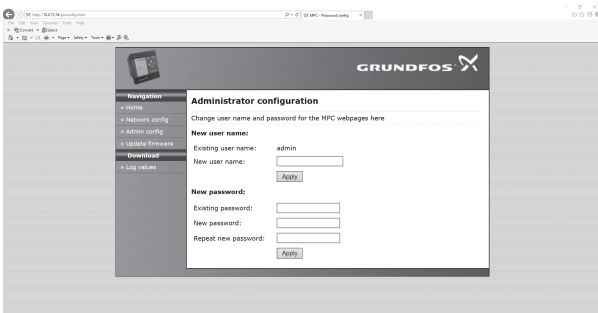

TM032051

Change of user name and password

9. Servicing the system

DANGER

Electric shock

Death or serious personal injury



- Before you maintain the system, make sure that the power supply is disconnected and cannot be accidentally switched on.

WARNING

Contaminated drinking water

Death or serious personal injury



- Flush the system after a standstill period in compliance with local legislation.

WARNING

Overhead load

Death or serious personal injury



- Wear a safety helmet.

CAUTION

Overhead load

Minor or moderate personal injury



- Use appropriate tools and lifting equipment for maintenance.

9.1 Maintaining the system

9.1.1 Pumps

Pump bearings and shaft seal are maintenance-free.

9.1.2 CU 352

CU 352 is maintenance-free. Keep the unit clean and dry, and protect it against direct sunlight. For ambient temperature, see the section on Technical data.

9.1.3 Motor bearings

Motors without lubricating nipples are maintenance-free.

Lubricate motors with lubricating nipples with a high-temperature lithium-based grease. See the instructions on the fan cover of Grundfos motors.

In the case of seasonal operation where the motor is idle for more than six months of the year, we recommend that you grease the motor when you take the pump out of operation.

9.2 Protecting the system against frost

If pumps are not used during periods of frost, they must be drained to avoid damage.

Follow these instructions:

1. Loosen the vent screw in the pump head.
2. Remove the drain plug from the base.
Do not tighten the vent screw and fit the drain plug until the pump is to be used again.

9.3 Taking the system out of operation

DANGER

Electric shock

Death or serious personal injury



- Make sure that the power supply is disconnected and cannot be accidentally switched on.



Drain the system if you are not going to use it for a long time.

1. Switch off the main switch to take the system out of operation.

2. Switch off the corresponding motor protective circuit breaker and the automatic circuit breaker to take the individual pump out of operation.

10. Fault finding

DANGER

Electric shock

Death or serious personal injury



- Switch off the power supply and wait at least five minutes before making any connections in the breaker cabinet or control cabinet.
- Make sure that the power supply is turned off and cannot be accidentally switched on.

10.1 Pumps not running

The pumps are not running.

Cause	Remedy
The actual pressure is higher than or equal to the setpoint.	<ul style="list-style-type: none"> • Wait until the pressure drops, or lower the pressure on the outlet side of the system. Check if the pumps start.
The power supply is switched off.	<ul style="list-style-type: none"> • Connect the power supply.
The main switch cuts out.	<ul style="list-style-type: none"> • Turn on the main switch.
The main switch is defective.	<ul style="list-style-type: none"> • Replace the main switch.
The motor protection is activated.	<ul style="list-style-type: none"> • Contact Grundfos.
The motor is defective.	<ul style="list-style-type: none"> • Repair or replace the motor.
The pressure transmitter is defective.	<ul style="list-style-type: none"> • Replace the pressure transmitter. Transmitters with 0-20 mA or 4-20 mA output signals are monitored by the system.
The cable is broken or short-circuited.	<ul style="list-style-type: none"> • Repair or replace the cable.

10.2 Pumps starting but stopping immediately

The pumps start but stop immediately. The operating pressure is not reached.

Cause	Remedy
Water shortage or no inlet pressure.	<ul style="list-style-type: none"> • Re-establish the supply of water to the system. When the inlet pressure is re-established, the pumps will restart after 15 seconds.

10.3 System stopping without restarting

The system stops and cannot restart.

Cause	Remedy
The pressure transmitter is defective.	<ul style="list-style-type: none"> • Replace the pressure transmitter. Transmitters with 0-20 mA or 4-20 mA output signals are monitored by the system.
The cable is broken or short-circuited.	<ul style="list-style-type: none"> • Repair or replace the cable.
The power supply of CU 352 is switched off.	<ul style="list-style-type: none"> • Connect the power supply.
CU 352 is defective.	<ul style="list-style-type: none"> • Contact Grundfos.

10.4 Unstable water supply from system

The water supply from the system is unstable.

Cause	Remedy
The inlet pressure is too low.	<ul style="list-style-type: none"> Check the inlet pipe and the inlet strainer, if any.
The inlet pipe, strainer or pumps are partly blocked by impurities.	<ul style="list-style-type: none"> Clean the inlet pipe, strainer or pumps.
The pumps suck air.	<ul style="list-style-type: none"> Check the inlet pipe for leakages.
The pressure transmitter is defective.	<ul style="list-style-type: none"> Replace the pressure transmitter.

10.5 Pumps running but delivering no water

The pumps are running but delivering no water.

Cause	Remedy
The valves are closed.	<ul style="list-style-type: none"> Open the valves.
The inlet pipe or the pumps are blocked by impurities.	<ul style="list-style-type: none"> Clean the inlet pipe or the pumps.
The non-return valve is blocked in the closed position.	<ul style="list-style-type: none"> Clean the non-return valve. Check if the non-return valve moves freely.
The inlet pipe is leaky.	<ul style="list-style-type: none"> Check the inlet pipe for leakages.
There is air in the inlet pipe or the pumps.	<ul style="list-style-type: none"> Vent and prime the pumps. Check the inlet pipe for leakages.

10.6 System not reaching the setpoint

The system is unable to reach the setpoint.

Cause	Remedy
The consumption is too high.	<ul style="list-style-type: none"> Reduce the consumption, if possible. Install a bigger system.
Too many standby pumps are selected.	<ul style="list-style-type: none"> Reduce the number of standby pumps.
There is a pipe fracture or a leakage in the system.	<ul style="list-style-type: none"> Check the system and repair the damaged parts, if necessary.

10.7 Leakage from the shaft seal

There is leakage in the shaft seal.

Cause	Remedy
The shaft seal is defective.	<ul style="list-style-type: none"> Replace the shaft seal.
The height adjustment of the pump shaft is inaccurate.	<ul style="list-style-type: none"> Readjust the shaft height.

10.8 Noise

There is considerable noise in the system.

Cause	Remedy
The pumps are cavitating.	<ul style="list-style-type: none"> Clean the inlet pipe or the pumps, and possibly the inlet strainer.
The pumps do not rotate freely (frictional resistance) due to inaccurate height adjustment of the pump shaft.	<ul style="list-style-type: none"> Readjust the shaft height.

10.9 Very frequent starts and stops

There are very frequent starts and stops.

Cause	Remedy
The diaphragm tank precharge pressure is not correct.	<ul style="list-style-type: none"> Set the correct precharge pressure.

11. Technical data

11.1 Pressure

Inlet pressure

The system can operate with a positive inlet pressure (precharged pressure system) or with a negative inlet pressure (vacuum at the inlet manifold).

We recommend that you calculate the inlet pressure in these cases:

- Water is drawn through long pipes.
- Water is drawn from depths.
- Inlet conditions are poor.



In this document, the term "inlet pressure" is defined as the pressure or vacuum which can be measured immediately before the system.

To avoid cavitation, make sure that there is a minimum inlet pressure on the inlet side of the system. The minimum inlet pressure H in metres of head can be calculated as follows:

$$H = p_b \times 10.2 - NPSH - H_f - H_v - H_s$$

p_b	Barometric pressure in bar. Barometric pressure can be set to 1 bar. In closed systems, p_b indicates the system pressure in bar.
NPSH	Net Positive Suction Head in metres of head. NPSH can be read from the NPSH curve at the highest flow which the individual pump will be delivering.
H_f	Friction loss in inlet manifold in metres of head at the highest flow the individual pump will be delivering. Note: If a non-return valve is installed on the inlet side of the pump, the friction loss in the valve must be added. See the manufacturer's data.
H_v	Vapour pressure in metres of head.
H_s	Safety margin of min. 0.5 metres of head.



You need to convert the head in metres to feet.

Maximum inlet pressure

See the CR, CRI, CRN installation and operating instructions supplied with this system.

Operating pressure

As standard, the maximum operating pressure is 232 psi (16 bar) for Hydro MPC CR, CRE and 145 psi (10 bar) for Hydro MPC CME.

On request, Grundfos offers Hydro MPC systems with a maximum operating pressure higher than 232 psi (16 bar).

11.2 Temperatures

Liquid temperature

For systems with CME3, CME5, CR3, CRE3, CR5, CRE5 pump models: 5-60 °C (41-140 °F)

For systems with CR10 and larger: 5-82 °C (41-180 °F)

Ambient temperature

32-104 °F (0-40 °C)

11.3 Relative humidity

Maximum 95 %.

11.4 Sound pressure level

See the installation and operating instructions of the pump.

The sound pressure level for a number of pumps can be calculated as follows:

$$L_{max} = L_{pump} + (n - 1) \times 3$$

L_{max}	Maximum sound pressure level
L_{pump}	Sound pressure level for one pump
n	Number of pumps

11.5 Electrical data

Supply voltage

See the nameplate.

Backup fuse

See the wiring diagram supplied with the system.

Digital inputs

Open-circuit voltage	24 VDC
Closed-circuit current	5 mA, DC
Frequency range	0-4 Hz



All digital inputs are supplied with PELV voltage (Protective Extra-Low Voltage).

Analog inputs

Input current and voltage	0-20 mA 4-20 mA 0-10 V
Tolerance	± 3.3 % of full scale
Repetitive accuracy	± 1 % of full scale
Input resistance, current	< 250 Ω
Input resistance, voltage, CU 352	50 kΩ ± 10 %
Input resistance, voltage, IO 351	> 50 kΩ ± 10 %
Supply to sensor	24 V, maximum 50 mA, short-circuit protected



All analog inputs are supplied with PELV voltage (Protective Extra-Low Voltage).

Digital outputs (relay outputs)

Maximum contact load	240 VAC, 2 A
Minimum contact load	5 VDC, 10 mA

All digital outputs are potential-free relay contacts.



Some outputs have a common C terminal.

For further information, see the wiring diagram supplied with the system.

Inputs for PTC sensor or thermal switch

For PTC sensors to DIN 44082. Thermal switches can also be connected.

Open-circuit voltage	12 VDC ± 15 %
Closed-circuit current	2.6 mA, DC













Inputs for PTC sensors are electrically separated from the other inputs and outputs of the system.

12. Product manuals

You can find further product information about the system in the following documents.

The documents are available in Grundfos Product Center on www.grundfos.com.

Title	Frequency [Hz]	QR code	Publication number
Data booklet			
Hydro MPC	60		99537904
CR, CRI, CRN	60		98446676
CR, CRN 95-255	60		99407996
CM, CME	60		98435269
Installation and operating instructions			
CR, CRI, CRN, CRT	50/60		98419736
CR, CRN 95-255	50/60		99347135
CRE, CRIE, CRNE, CRKE, SPKE, MTRE, CME	60		98566351
CRE, CRIE, CRNE, CRKE, SPKE, MTRE	60		92898117
CM	50/60		97526969
Frequency converter ⁸⁾	50/60	-	-
Quick guide			
Diaphragm tank	-		98817081
Other documentation			
Wiring diagram ⁹⁾	-	-	-

⁸⁾ The instructions are only relevant for systems with external frequency converter.

⁹⁾ A wiring diagram is supplied with the system.

13. Disposal

13.1 Precautions for disposal

DANGER

Electric shock

Death or serious personal injury

- Before you dismantle the system, make sure that the power supply is disconnected and cannot be accidentally switch on.



WARNING

Crushing of feet

Death or serious personal injury

- Before you lift, make sure that the lifting equipment is capable of lifting this load, which is listed on the nameplate and on the packaging label.



WARNING

Hot surface

Death or serious personal injury

- Before you dismantle the system, make sure that the system cools down.



CAUTION

Overhead load

Minor or moderate personal injury

- Use safety equipment when dismantling the system.



CAUTION

Sharp element

Minor or moderate personal injury

- Wear safety gloves.



13.2 Disposing of the system

This system or parts of it must be disposed of in an environmentally sound way:

1. Use the public or private waste collection service.
2. If this is not possible, contact the nearest Grundfos company or service workshop.

14. Document quality feedback

To provide feedback about this document, scan the QR code using your phone's camera or a QR code app.



[Click here to submit your feedback](#)

FEEDBACK99320238

Limited consumer warranty

1. Limited consumer warranty

This Limited Warranty is provided for Consumer Products sold in the United States only and applies to Consumer Transactions as defined in and applicable under the Magnusson-Moss Warranty Act and any other applicable Federal and/or State laws. In case of non-Consumer Products, please refer to Grundfos' warranty terms defined in clause 10 of Grundfos US Terms and Conditions of Sale of Product and Services available at <https://www.grundfos.com/legal/grundfos-customer-terms/usa-grundfos-general-terms-for-sales-of-products-and-services>

This Limited Warranty gives you specific legal rights, and you may also have other rights which vary from State to State.

New products manufactured by Grundfos are warranted to the original purchaser only and are to be free from defects in design, material and workmanship under normal use and service for no greater than a period of thirty (30) months from the date of manufacture which is set forth on the product's nameplate and on the product's packaging or the minimum period required by the applicable State law. For New Jersey, the applicable period is one year from the date of purchase.

The warranty period for replacement products, parts and components expires thirty (30) months from the original date of manufacture of the product originally purchased, unless a longer period is required under the applicable State law. For New Jersey, the warranty period for replacement products, parts and components expires one year from the original date of purchase of the product, not the date of replacement.

Products sold by Grundfos that are manufactured by others are not covered by this warranty.

Note that when purchasing a Grundfos product online, it is important to check the date of manufacture and the duration of the warranty with the seller as the product might no longer be covered under this Limited Warranty.

When a product is subject to this Limited Warranty a purchaser should contact the seller from which it purchased the product to make a claim.

If the seller of a product is no longer in business, the purchaser should contact a Grundfos Authorized Service Partner, which can be found at www.grundfos.com/us under > Support > Contact Service.

As part of making a claim, a purchaser shall return a defective product at the purchaser's cost, to the extent allowed by applicable law, along with proof of purchase and an explanation of the defect, date the defect occurred and circumstances surrounding the defect. For New Jersey there is no prohibition on returning a defective product at a purchaser's cost. If Grundfos is required by applicable State law to pay for the cost of shipment under applicable State law, then a purchaser should contact a Grundfos Authorized Service Partner to arrange for shipment. A purchaser also needs to promptly respond to Grundfos as to any inquiries regarding a warranty claim.

Grundfos' liability under this Limited Warranty to purchaser is limited to the repair or replacement of a product (at Grundfos' decision) that is the sole and exclusive remedy for purchaser to the extent permissible by applicable law. For New Jersey this limitation is permissible.

This warranty does not cover the following: ordinary wear and tear; use of a product for applications for which it is not intended; use of a product in an unsuitable environment; modifications, alterations or repair undertaken by anyone not acting with Grundfos' written authorization; failure to follow Grundfos' instructions, operations manuals, any other guidelines or good industry practice; use of faulty or inadequate ancillary equipment in combination with a product; application of spare or replacement parts not provided or authorized by Grundfos; accidental or intentional damage or misuse of a product.

The time period for making a claim under the implied warranty of merchantability and implied warranty of fitness are limited to the same time period as provided by this warranty to the extent permissible by applicable law. For residents of New Jersey, this limitation is permissible, but note that some states do not allow limitations on how long an implied warranty lasts, so the above limitation may not apply to you.

Grundfos shall not be liable for any incidental and consequential damages in connection with a product to the extent permissible by applicable law. For residents of New Jersey, this limitation is permissible, but note that some states do not allow limitations of incidental or consequential damages, so the above limitation may not apply to you.

2. Garantía limitada del consumidor

Esta garantía limitada se proporciona únicamente para los productos de consumo vendidos en los Estados Unidos y es aplicable a las transacciones de consumo tal y como se define en y resulta aplicable en virtud de la ley de Garantías Magnusson-Moss y cualquier otra legislación federal y/o estatal aplicable. Para el caso de productos que no sean de consumo, consulte los términos de la garantía de Grundfos definidos en la cláusula 10 de los términos y condiciones de venta de productos y servicios de Grundfos para los EE. UU., disponibles en <https://www.grundfos.com/legal/grundfos-customer-terms/usa-grundfos-general-terms-for-sales-of-products-and-services>.

Esta garantía limitada le confiere derechos legales específicos. Puede que también tenga otros derechos en virtud de su jurisdicción estatal.

Se garantiza únicamente al comprador original que los productos fabricados por Grundfos estarán libres de defectos de diseño, materiales y mano de obra en condiciones normales de uso y servicio durante un periodo no mayor a treinta (30) meses a partir de la fecha de fabricación que figura en la placa de datos del producto y en el empaque del mismo o el periodo mínimo exigido por la legislación estatal aplicable. Para Nueva Jersey, el periodo aplicable es de un año a partir de la fecha de compra.

El periodo de garantía para los productos, partes y componentes de repuesto vence a los treinta (30) meses contados a partir de la fecha de fabricación original del producto adquirido en primer lugar, a menos que la legislación estatal aplicable exija un periodo más largo. Para Nueva Jersey, el periodo de garantía de los productos, partes y componentes de repuesto vence un año contado a partir de la fecha original de compra del producto, no de la fecha de sustitución.

Los productos vendidos por Grundfos que sean producidos por otros fabricantes no están cubiertos por esta garantía.

Tenga en cuenta que, al comprar un producto Grundfos en línea, es importante revisar la fecha de fabricación y la duración de la garantía con el vendedor, ya que es posible que el producto ya no esté cubierto por esta garantía limitada.

Cuando un producto esté sujeto a esta garantía limitada, el comprador deberá ponerse en contacto con el vendedor al que haya comprado el producto para presentar una reclamación.

Si el vendedor de un producto ya no está en el negocio, el comprador debe ponerse en contacto con socio de servicio autorizado por Grundfos, que puede encontrar en la dirección www.grundfos.com/us, en la sección "Support" > "Contact Service".

Como parte de la presentación de una reclamación, el comprador deberá devolver el producto descompuesto a su costa, en la medida en la que lo permita la legislación aplicable, junto con el comprobante de compra y una explicación del defecto, la fecha en que este se haya producido y las circunstancias en torno al defecto. En Nueva Jersey no existe ninguna prohibición de devolver un producto descompuesto a costa del comprador. Si la legislación estatal aplicable obliga a Grundfos a hacerse cargo de los gastos de envío, el comprador deberá ponerse en contacto con un servicio técnico autorizado por Grundfos para organizar el envío. El comprador también debe responder con prontitud a Grundfos cualquier consulta relacionada con una reclamación de garantía.

La responsabilidad de Grundfos hacia el comprador en virtud de esta garantía limitada se limita a la reparación o sustitución de un producto (a decisión de Grundfos), que es el único y exclusivo remedio para el comprador en la medida permitida por la legislación aplicable. Para Nueva Jersey, esta limitación resulta permisible.

Esta garantía no cubre lo siguiente: el desgaste ordinario; el uso de un producto para aplicaciones para las que no está diseñado; el uso de un producto en un entorno inadecuado; las modificaciones, alteraciones o reparaciones realizadas por cualquier persona que no actúe con la autorización por escrito de Grundfos; el incumplimiento de las instrucciones, manuales de operación, cualquier otro lineamiento o las buenas prácticas industriales de Grundfos; el uso de equipos auxiliares descompuestos o inadecuados en combinación con un producto; el uso de repuestos o partes de sustitución no proporcionados ni autorizados por Grundfos; el daño accidental o deliberado o el uso indebido de un producto.

El periodo para presentar una reclamación en virtud de la garantía implícita de comerciabilidad y la garantía implícita de idoneidad se limita al mismo periodo previsto por esta garantía en la medida permitida por la legislación aplicable. Para los residentes de Nueva Jersey, esta limitación resulta permisible, si bien se debe tener en cuenta que algunos estados no permiten limitaciones en cuanto a la duración de una garantía implícita, por lo que la limitación anterior puede no resultar aplicable en su caso.

Grundfos no será responsable de ningún daño indirecto o consecuente en relación con un producto en la medida en la que lo permita la legislación aplicable. Para los residentes de Nueva Jersey, esta limitación resulta permisible, si bien debe tenerse en cuenta que algunos estados no permiten limitaciones en cuanto a daños indirectos o consecuentes, por lo que la limitación anterior puede no resultar aplicable en su caso.

Limited manufacturer's warranty

1. Limited manufacturer's warranty

This Limited Manufacturer's Warranty outlines applicable coverage and claims procedures for the pumps manufactured by Grundfos (the "Product").

This Limited Manufacturer's Warranty is provided for consumer products sold and used in Canada only and applies to consumer transactions as defined in the applicable provincial and territorial laws. In case of non-consumer products, please refer to Grundfos' warranty terms defined in clause 10 of Grundfos Canada Terms and Conditions of Sale of Product and Services available at: <https://www.grundfos.com/ca/legal/general-terms-and-conditions-of-sales-and-delivery>

This Limited Manufacturer's Warranty provides specific rights and limitations. Some of the limitations may not apply to you, and you may also have other rights that vary from province to province.

Scope of the Limited Manufacturer's Warranty

Subject to the following warranty terms and conditions, Grundfos Canada Inc. of 2941 Brighton Rd, Oakville, ON L6H 6C9, Canada ("Grundfos"), warrants to the original consumer (the "Purchaser") that the new Product manufactured by Grundfos is free from defects in design, material and workmanship under normal use and service for a period of twenty-four (24) months from the date of retail purchase but no greater than a period of thirty (30) months from the date of manufacture which is set forth on the Product's nameplate and on the Product's packaging (the "Warranty Period").

Note that when purchasing a Grundfos Product online, it is important to check the date of manufacture and the duration of the warranty with the seller as the Product might no longer be covered under this Limited Manufacturer's Warranty.

This Limited Manufacturer's Warranty applies exclusively to a new Grundfos Product sold and used in Canada. This Limited Manufacturer's Warranty does not apply to any Product sold "as is" or "sales final". This Limited Manufacturer's Warranty is not transferrable by the original Purchaser. Products sold by Grundfos that are manufactured by others are not covered by this warranty.

The sole and exclusive remedy under this Limited Manufacturer's Warranty is the repair or, at the discretion of Grundfos, the replacement of the Product, as set out below. Defects or damages are not covered by the Limited Manufacturer's Warranty if they are due to:

- ordinary wear and tear;
- use of the Product for an application for which it is not intended;
- installation of the Product in an environment not suitable for the Product;
- any modification, alteration or repair of the Product undertaken by the Purchaser or a third party (not acting on Grundfos' behalf);
- failure to follow Grundfos' instructions, including in the installation manual, operation manual, maintenance manual or service manual;
- installation, commissioning, operation (including the use of the Product or any Grundfos product outside its specifications) or maintenance of the Product other than in accordance with Grundfos installation manual, operation manual, maintenance manual or service manual or with good industry practice;
- use of faulty or inadequate ancillary equipment in combination with the Product;
- the application of spare parts of poor quality (excluding the application of any Grundfos original spare parts);
- accidental or intentional damage or misuse of the Products or services by the Purchaser or a third party (not acting on Grundfos' behalf); or
- the non-compliance of the Purchaser or of the Purchaser's own products with applicable law and regulation.

How to get service under the Limited Manufacturer's Warranty:

When a Product is subject to this Limited Manufacturer's Warranty, the Purchaser should contact the seller from which it purchased the Product to make a claim within 24 months from the date of retail purchase but no later than thirty (30) months from the date of manufacture which is set forth on the Product's nameplate and on the Product's packaging (the "Warranty Notification Period").

If the seller of a Product is no longer in business, the Purchaser should contact Grundfos Service at www.grundfos.com/us under **Support > Contact Service**.

To exercise the rights under this Limited Manufacturer's Warranty, the Purchaser shall return a defective Product at the Purchaser's cost, to the extent allowed by applicable law, along with proof of purchase and an explanation of the defect, date the defect occurred and circumstances surrounding the defect.

The Purchaser is responsible for any expenses for dismounting and mounting the Product and for any and costs related to removal, reinstallation, transportation, and insurance. If Grundfos is required by applicable provincial or territorial law to pay for the cost of transportation, then the Purchaser should contact Grundfos Service Partner to arrange for shipment. The Purchaser also needs to promptly respond to Grundfos as to any inquiries regarding a warranty claim.

Unless requested by Grundfos, the Product may not be disassembled prior to remedy. Any failure to comply herewith will render this Limited Manufacturer's Warranty void.

Grundfos will either arrange the repair of the defective Product under this Limited Manufacturer's Warranty or, at Grundfos' option, provide the Purchaser with a replacement of the defective Product. The replacement unit can be new or remanufactured.

To the extent permissible by applicable law, Grundfos shall not be liable for any incidental and consequential damages or losses of any kind whatsoever arising under, relating to or in connection with the Product, use of the Product or the inability to use the Product.

2. Garantie limitée du fabricant

Cette garantie limitée du fabricant décrit la couverture applicable et les procédures de réclamation pour les pompes fabriquées par Grundfos (ci-après le « Produit »).

Cette garantie limitée du fabricant est fournie pour les produits de consommation vendus et utilisés au Canada uniquement et s'applique aux transactions de consommateurs telles que définies dans les lois provinciales et territoriales applicables. Dans le cas de produits non destinés aux consommateurs, se référer aux conditions de garantie de Grundfos définies à l'article 10 des Conditions générales de vente des produits et services de Grundfos Canada, qui sont disponibles à l'adresse suivante : <https://www.grundfos.com/ca/fr/legal/general-terms-and-conditions-of-sales-and-delivery>

Cette garantie limitée du fabricant prévoit des droits et des limitations spécifiques. Certaines des limitations peuvent ne pas s'appliquer à vous, et vous pouvez également bénéficier d'autres droits qui varient d'une province à l'autre.

Champ d'application de la garantie limitée du fabricant

Sous réserve des conditions générales de garantie suivantes, Grundfos Canada Inc., dont le siège social est situé au 2941, Brighton Rd, Oakville, ON L6H 6C9, Canada (ci-après « Grundfos »), garantit au consommateur initial (ci-après « l'Acheteur ») que le nouveau Produit fabriqué par Grundfos est exempt de défauts de conception, de matériaux et de fabrication dans des conditions normales d'utilisation et d'entretien pendant une période de vingt-quatre (24) mois à compter de la date d'achat au détail, mais pas plus de trente (30) mois à compter de la date de fabrication indiquée sur la plaque signalétique et sur l'emballage du Produit (« Période de garantie »).

Lors de l'achat d'un Produit Grundfos en ligne, il est important de vérifier la date de fabrication et la durée de la garantie auprès du vendeur, car le Produit pourrait ne plus être couvert par cette garantie limitée du fabricant.

Cette garantie limitée du fabricant s'applique exclusivement à un Produit Grundfos neuf vendu et utilisé au Canada. Cette garantie limitée du fabricant ne s'applique pas aux Produits vendus « en l'état » ou « vente finale ». La présente garantie limitée du fabricant n'est pas transférable par l'Acheteur initial. Les produits vendus par Grundfos qui sont fabriqués par des tiers ne sont pas couverts par cette garantie.

Le seul et unique recours dans le cadre de cette garantie limitée du fabricant est la réparation ou, à la discrétion de Grundfos, le remplacement du Produit, comme indiqué ci-dessous. Les défauts ou dommages ne sont pas couverts par la garantie limitée du fabricant s'ils sont dus à :

- l'usure normale ;
- l'utilisation du Produit pour une application pour laquelle il n'est pas prévu ;
- l'installation du Produit dans un environnement non adapté au Produit ;
- toute modification, altération ou réparation du Produit entreprise par l'Acheteur ou un tiers (n'agissant pas pour le compte de Grundfos) ;
- la non-observation des instructions de Grundfos, y compris dans les notices d'installation, d'utilisation, de maintenance ou d'entretien ;
- l'installation, la mise en service, l'utilisation (y compris l'utilisation du Produit ou de tout produit Grundfos en dehors de ses spécifications) ou l'entretien du Produit autrement que conformément aux notices d'installation, d'utilisation, de maintenance ou d'entretien Grundfos ou aux bonnes pratiques de l'industrie ;
- l'utilisation d'un équipement auxiliaire défectueux ou inadéquat en combinaison avec le Produit ;
- l'utilisation de pièces de rechange de mauvaise qualité (à l'exclusion de l'utilisation de pièces de rechange d'origine Grundfos) ;
- tout dommage accidentel ou intentionnel ou toute mauvaise utilisation des Produits ou des services par l'Acheteur ou un tiers (n'agissant pas pour le compte de Grundfos) ; ou
- la non-conformité de l'Acheteur ou de ses propres produits aux lois et règlements applicables.

Procédure à suivre pour bénéficier d'un service dans le cadre de la garantie limitée du fabricant :

Lorsqu'un Produit est soumis à la présente garantie limitée du fabricant, l'Acheteur doit contacter le vendeur auprès duquel il a acheté le produit pour faire une réclamation dans les 24 mois suivant la date d'achat au détail, mais au plus tard trente (30) mois à compter de la date de fabrication indiquée sur la plaque signalétique du Produit et sur l'emballage du Produit (« Période de notification de garantie »).

Si le vendeur d'un Produit n'est plus en activité, l'Acheteur doit contacter le service Grundfos à l'adresse www.grundfos.com/us sous **Support > Contact Service**.

Pour exercer les droits prévus par la présente garantie limitée du fabricant, l'Acheteur doit renvoyer le Produit défectueux à ses frais, dans la mesure où la loi applicable le permet, accompagné de la preuve d'achat et d'une explication du défaut, de la date à laquelle le défaut s'est produit et des circonstances entourant le défaut.

L'Acheteur est responsable de tous les frais de démontage et de montage du Produit et de tous les frais liés à l'enlèvement, à la réinstallation, au transport et à l'assurance. Si Grundfos est tenu par la loi provinciale ou territoriale applicable de payer les frais de transport, l'Acheteur doit contacter le partenaire de service Grundfos pour organiser l'expédition. L'Acheteur doit également répondre rapidement à Grundfos pour toute demande concernant une réclamation au titre de la garantie.

Sauf demande de Grundfos, le Produit ne doit pas être démonté avant d'être remis en état. Tout manquement à ces dispositions entraînera l'annulation de la présente garantie limitée du fabricant.

Grundfos procédera à la réparation du Produit défectueux dans le cadre de cette garantie limitée du fabricant ou, à la convenance de Grundfos, fournira à l'Acheteur un produit de remplacement du Produit défectueux. L'unité de remplacement peut être neuve ou refabriquée.

Dans la mesure autorisée par la loi applicable, Grundfos ne sera pas responsable des dommages accessoires et indirects ou des pertes de quelque nature que ce soit découlant de, liés à ou en rapport avec le Produit, l'utilisation du Produit ou l'incapacité d'utiliser le Produit.

U.S.A.

Global Headquarters for WU
856 Kooamey Road
Brookshire, Texas 77423 USA
Phone: +1-630-236-5500

GRUNDFOS CBS Inc.
902 Kooamey Road
Brookshire, TX 77423 USA
Phone: 281-994-2700
Toll Free: 1-800-955-5847
Fax: 1-800-945-4777

GRUNDFOS Pumps Corporation
9300 Loiret Boulevard
Lenexa, Kansas 66219 USA
Tel.: +1 913 227 3400
Fax: +1 913 227 3500

Canada

GRUNDFOS Canada inc.
2941 Brighton Road
Oakville, Ontario
L6H 6C9
Tel.: +1-905 829 9533
Fax: +1-905 829 9512

Mexico

Bombas GRUNDFOS de México
S.A. de C.V.
Boulevard TLC No. 15
Parque industrial Stiva Aeropuerto
Apodaca, N.L. 66600
Tel.: +52-81-8144 4000
Fax: +52-81-8144 4010

Revision Info

Last revised on 05-2024

99320238 07.2024
ECM: 1394651