

Hydro MPC

Systems with 2-6 CR, CRE pumps or 2-3 CME pumps
60 Hz North America



1. System introduction	4	Non-return valve	28
System description	4	Multisensor settings	29
Applications	4	Counter inputs	29
Pump Energy Index	4		
Features and benefits	5		
2. System data	7	5. Installation	30
Performance range	7	Mechanical installation	30
Product range	9	Electrical installation	31
Control variants	10	Hygiene	31
Type key	11		
Nameplate	12	6. Sizing	32
Sound pressure level	12	Maximum flow requirement	33
		Required outlet pressure	33
3. Construction	13	System layout	34
System structure	13	Consumption profile and load profile	34
CR pump	13	Inlet pressure	35
CME pump	14	System selection	35
MLE motors	14	Accessories	35
Shaft seal	14	Example: How to select a system	37
Base frame	15		
Manifold	15	7. Curve conditions	38
Flange	15	How to read the performance curve	38
Control cabinet	15		
CU 352	16	8. Curve charts, Hydro MPC-E, 60 Hz	39
IO 351	16	Hydro MPC-E with CR, CRE 3	39
		Hydro MPC-E with CR, CRE 5	40
4. Control functions	17	Hydro MPC-E with CR, CRE 10	41
CU 352 operating panel	17	Hydro MPC-E with CR, CRE 15	42
Overview of functions	19	Hydro MPC-E with CR, CRE 20	43
Constant-pressure control of E-system	19	Hydro MPC-E with CR, CRE 32	44
Display language	19	Hydro MPC-E with CR, CRE 45	45
Pump curve data	20	Hydro MPC-E with CR, CRE 64	47
Redundant primary sensor	20	Hydro MPC-E with CR, CRE 95	49
Automatic cascade control	20	Hydro MPC-E with CR, CRE 125	51
Alternative setpoints	20	Hydro MPC-E with CR, CRE 155	53
Log function	21	Hydro MPC-E with CR 185	55
Specific energy calculation	21	Hydro MPC-E with CR 215	56
Number of starts per hour	21	Hydro MPC-E with CR 255	57
Standby pumps	21		
Forced pump changeover	22	9. Curve charts, Hydro MPC CME, 60 Hz	58
Pump test run	22	Hydro MPC with CME 3	58
Dry-running protection	22	Hydro MPC with CME 5	59
Stop function	23	Hydro MPC with CME 10	60
Setpoint ramp	24	Hydro MPC with CME 15	61
Pilot pump	24	Hydro MPC with CME 25	62
Password	24		
Clock program	25	10. Technical data, Hydro MPC-E, 60 Hz	63
Proportional pressure	25	Dimensional sketches for CR, CRE	63
Soft pressure build-up	26	Hydro MPC-E with CR, CRE 3	64
Emergency run	27	Hydro MPC-E with CR, CRE 5	68
Reduced operation	27	Hydro MPC-E with CR, CRE 10	71
Status display menu	27	Hydro MPC-E with CR, CRE 15	77
		Hydro MPC-E with CR, CRE 20	81

Hydro MPC-E with CR, CRE 32	85
Hydro MPC-E with CR, CRE 45	88
Hydro MPC-E with CR, CRE 64	91
Hydro MPC-E with CR, CRE 95	93
Hydro MPC-E with CR, CRE 125	95
Hydro MPC-E with CR, CRE 155	97
Hydro MPC-E with CR 185.	98
Hydro MPC-E with CR 215.	99
Hydro MPC-E with CR 255.	99
11. Technical data, Hydro MPC CME, 60 Hz	100
Dimensional sketches for CME	100
Hydro MPC CME with CME 3	101
Hydro MPC CME with CME 5	101
Hydro MPC CME with CME 10	102
Hydro MPC CME with CME 15	102
Hydro MPC CME with CME 25	103
Maximum system amps (full load amperage)	104
12. Optional equipment	108
Dry-running protection	110
Redundant primary sensor	110
13. Accessories	111
Dry-running protection	111
Diaphragm tank	111
Grundfos GO	112
14. Product manuals	113
15. Alternative systems	114
16. Grundfos Product Center	115
17. Grundfos GO	116

1. System introduction

System description

As standard, the system consists of two to six identical Grundfos CR or CRE pumps, or two to three CME pumps. The pumps are connected in parallel and mounted on a common base frame with a control cabinet and all necessary fittings.

The pumps in this system can be removed without interfering with the pipes on either side of the manifolds.

The system has three control variants. See sections Product range and Control variants.

Hydro MPC-E/EC

- Systems are fitted with two to six identical electronically speed-controlled pumps.
- Systems (CRE) are fitted with CRE pumps. Each pump has an integrated frequency converter.
- Systems (CUE) are fitted with CR pumps connected to Grundfos CUE frequency converters. Each pump has a frequency converter mounted in the control cabinet.
- Systems (CME) are fitted with CME pumps. Each pump has an integrated frequency converter.

Applications

The system is designed for a wide range of applications, including:

- domestic water pressure boosting
- high-rise building pressure boosting
- municipal water supply and transfer applications
- municipal water transfer and boosting
- hydronic water circulation (HVAC)
- redundant pumping applications.

Related information

[Product range](#)

[Control variants](#)

Pump Energy Index

Pump Energy Index (PEI) was established by the U.S. Department of Energy (DOE) and adopted by Canada as the standard metric used to evaluate pump efficiency. The value is the ratio of the pump efficiency rating (PER) divided by the calculated minimally compliant PER (PER_{STD}) for the pump type. This shows the actual performance of a pump compared to the minimal standard performance required by regulation. The lower the PEI value, the more efficient a pump is at the tested operating points.

PER is determined by defined testing parameters required by the DOE. This includes testing a particular pump model at its best efficiency point (BEP).

For PEI values there are two different versions:

- PEI_{CL} (constant load): Applies to bare-shaft pumps, and pumps sold with a motor.
- PEI_{VL} (variable load): Applies to pumps sold with a motor and controller (such as VFD, VSD).

The DOE sets the maximum PEI value as 1.00. Any pump, pump and motor, or pump, motor and controller that exceeds a PEI value of 1.00 can no longer be manufactured after January 26, 2020.

PEI is a generalized efficiency value. PEI cannot be used to determine the efficiency of a pump in a specific application.

Even though packaged systems with advanced control logic can deliver greater savings, the skid packaged system does not have a PEI value, but the individual pumps in the system have a PEI value.

Product type	Motor power [hp (kW)]	Voltage [V]	PEI_{VL}	Impeller diameter [inch (mm)]		
CRE 10	1 (0.75)	1 x 200-240 3 x 440-480	0.42 0.41	3.66 (92.9)		
	1.5 - 2 (1.1 - 1.5)	1 x 200-240 3 x 200-240 3 x 440-480	0.41 0.43 0.41			
	3-15 (2.2 - 11)	3 x 200-240 3 x 440-480	0.41 0.41			
	CRE 15	2 (1.5)	1 x 200-240 3 x 200-240 3 x 440-480		0.45 0.44 0.46	4.13 (104.8)
		5-25 (3.7 - 18.5)	3 x 200-240 3 x 440-480		0.42 0.40	
		CRE 20	3-25 (2.2 - 18.5)		3 x 200-240 3 x 440-480	
CRE 32	5 - 7.5 (3.7 - 5.5)		3 x 200-240 3 x 440-480	0.41 0.40	4.66 (118.4)	
	10-30 (7.5 - 22)	3 x 440-480	0.40			

Product type	Motor power [hp (kW)]	Voltage [V]	PEI _{VL}	Impeller diameter [inch (mm)]
CRE 45	7.5 (5.5)	3 x 200-240	0.41	5.34 (136)
		3 x 440-480	0.41	
	10-30 (7.5 - 22)	3 x 440-480	0.41	
CRE 64	10-30 (7.5 - 22)	3 x 440-480	0.43	5.59 (142)
CRE 95	15-30 (11-22)	3 x 440-480	0.42	6.07 (154)
CRE 125	20-30 (15-22)	3 x 440-480	0.43	6.38 (162)
CRE 155	25 (18.5)	3 x 440-480	0.43	6.64 (169)

Product type	Poles	PEI _{CL} pump with motor	PEI _{VL} pump with motor plus controller ¹⁾	Impeller diameter [inch (mm)]
CR, CRN, CRI 10	2	0.87	0.48	4.13 (104.8)
CR, CRN, CRI 15	2	0.91	0.48	
CR, CRN, CRI 20	2	0.91	0.47	
CR, CRN, 32	2	0.87	0.45	4.66 (118.4)
	4	0.91	0.50	
CR, CRN, 45	2	0.89	0.46	5.34 (136)
	4	0.91	0.47	
CR, CRN, 64	2	0.93	0.46	5.59 (142)
	4	0.94	0.48	
CR, CRN, 95	2	0.93	0.45	6.07 (154)
	4	0.94	0.47	
CR, CRN, 125	2	0.93	0.59	6.38 (162)
	4	0.94	0.47	
CR, CRN, 155	2	0.93	0.59	6.64 (169)
	4	0.95	0.47	
CR, CRN 185	4	0.95	0.46	7.36 (187)
CR, CRN 215	4	0.96	0.47	7.80 (198)
CR, CRN 255	4	0.97	0.48	7.72 (196)

¹⁾ Grundfos CUE continuous controls

Features and benefits

Perfect constant-pressure control



GR-1014555

CU 352

The pumps of the systems are controlled individually by the CU 352 multi-pump control unit which includes application-optimized software and pump curve data. CU 352 knows the exact hydraulic and electrical data of the pumps to be controlled. A log function monitors the system performance over a period of time.

User-friendliness

The system features a built-in startup wizard in a wide range of languages. The wizard guides the installer through a series of steps until the system is correctly installed and commissioned.

When the installation is complete, the large, user-friendly color display ensures easy day-to-day operations.

Reliability



TM074711

Grundfos CRE and CME pumps

The system is built on the highly renowned Grundfos CR and CRE pump range and the industrial quality CME pump range.

Every vital piece of the system is made by Grundfos. You are guaranteed long-lasting technology that requires minimal maintenance and provides maximum efficiency.

Low energy consumption

The Hydro MPC-E systems with Grundfos MGE motors from 0.5 to 30 Hp (0.37 to 22 kW) have a total efficiency which exceeds the Super Premium Efficiency EuP IE5 level according to IEC 60034-30-1.



TM083139

Grundfos MLE motors

ML motors up to 75 Hp (55 kW) meet the legislative requirements of the EuP IE3 level, and motors from 100 Hp (75 kW) to 270 Hp (200 kW) meet the legislative requirements of the EuP IE4 level.

Furthermore, the system uses pump curve data to calculate and optimize the cut-in and cut-out of pumps.

High-efficient motors, advanced control in combination with optimized hydraulics for both the CRE pumps and the manifolds ensure minimal energy consumption.

Flexibility

The elements of the system can be combined in a number of ways to make the perfect solution for you.

Custom-built solutions

If this data booklet does not provide you with a solution that meets your specific pumping needs, contact Grundfos.

2. System data

Performance range

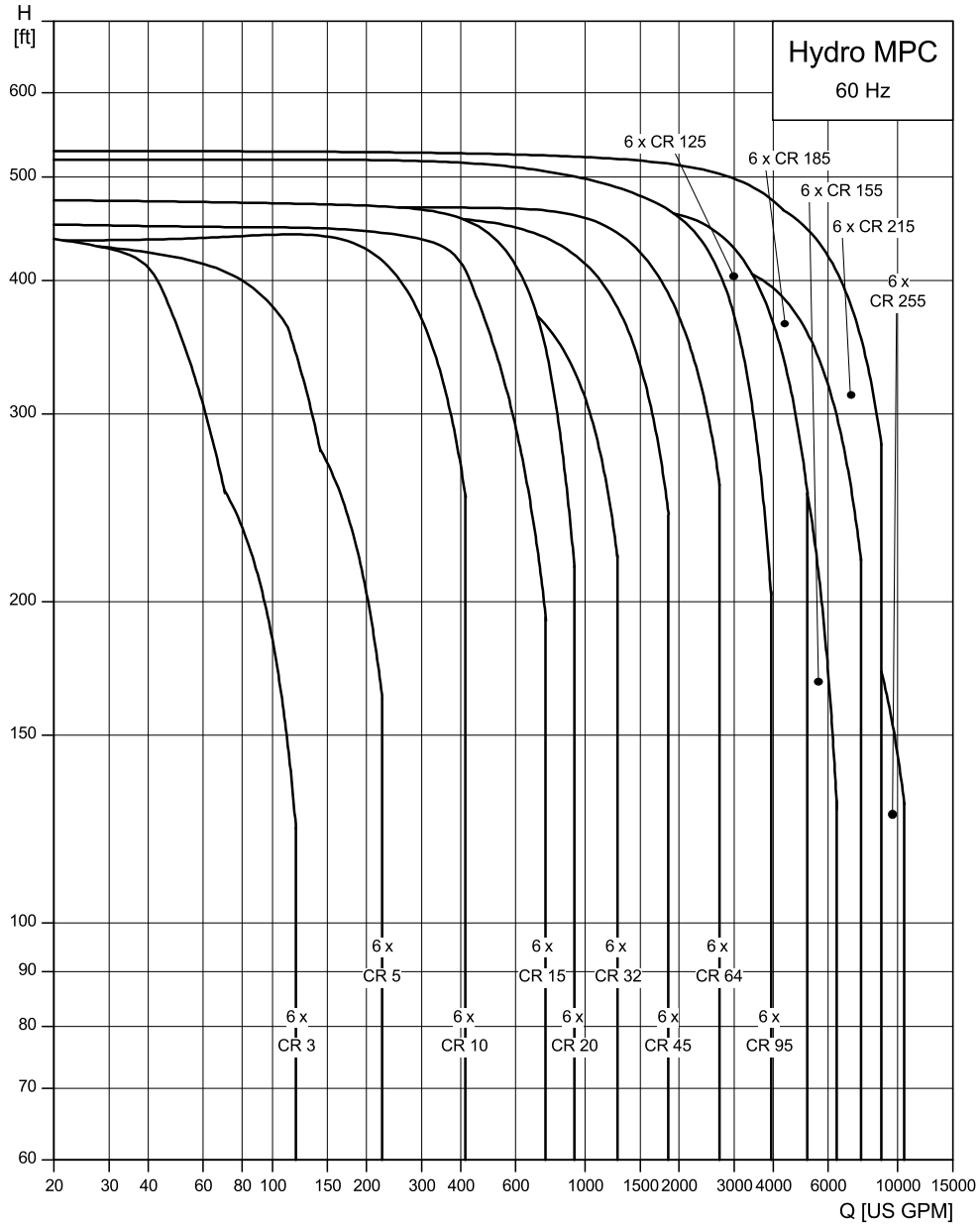

TM085057

Performance range for systems with CR, CRE

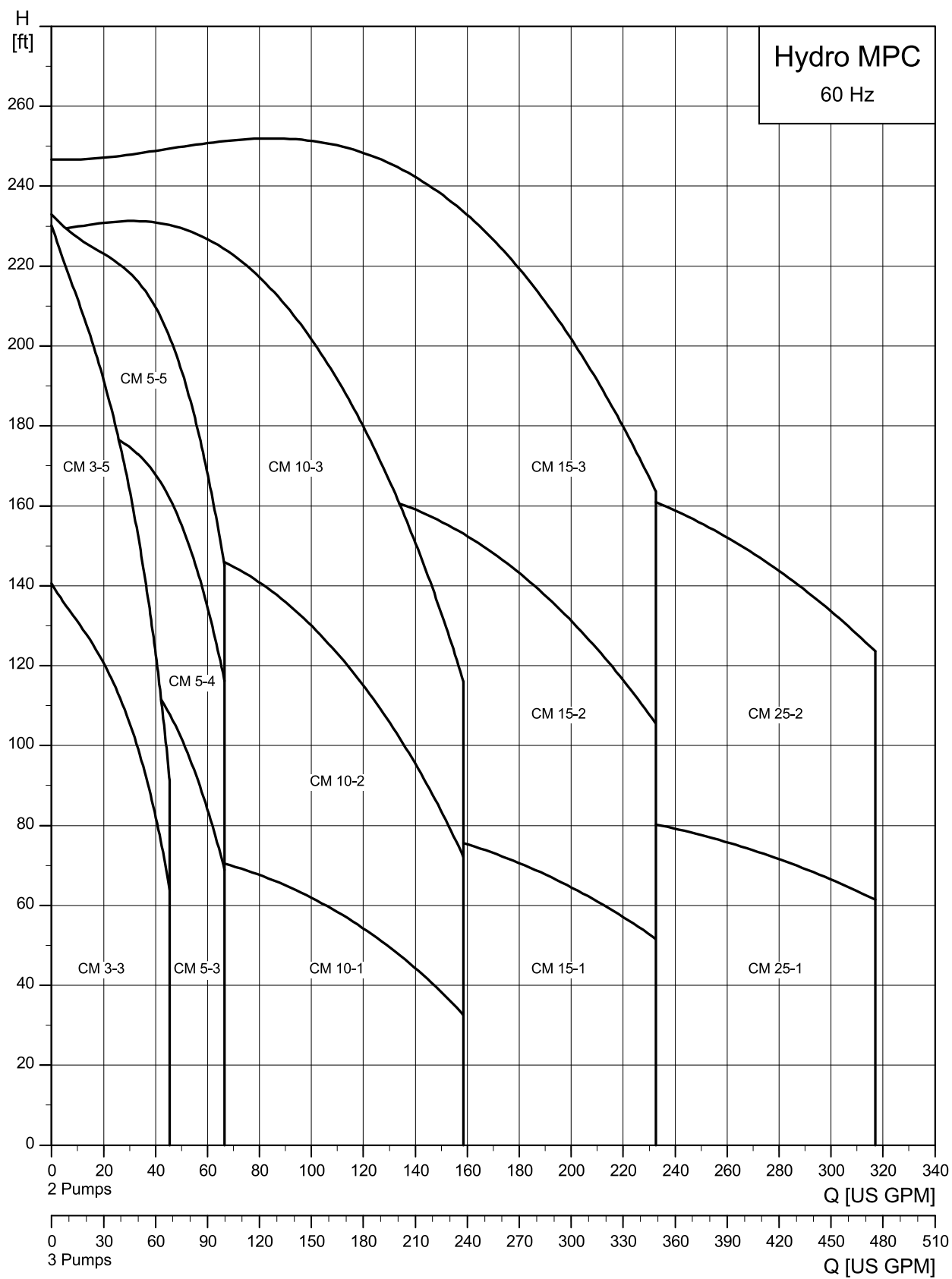

Performance range for systems with CME

TM086152

Product range

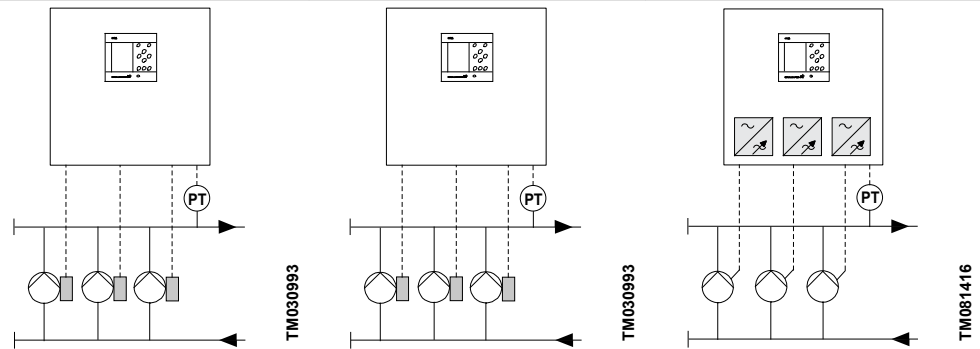

Control variant	Hydro MPC-E (CRE)	Hydro MPC-E (CME)	Hydro MPC-E (CUE)
Frequency	60 Hz	60 Hz	60 Hz
Hydraulic data			
Maximum head [ft. (m)]	479 (146)	231 (70)	479 (146)
Flow rate [gpm (m ³ /h)]	0-4755 (0-1080)	0-476 (0-108)	0-10530 (0-2392)
Liquid temperature [°F (°C)]	41-140, 180 (5-60, 82) ²⁾	41-140 (5-60)	41-140, 180 (5-60, 82) ²⁾
Ambient temperature [°F (°C)]	32-104 (0-40)	32-104 (0-40)	32-104 (0-40)
Relative humidity	95 %	95 %	95 %
Maximum operating pressure [psi (bar)]	232 (16) ³⁾	145 (10)	232 (16) ³⁾
Motor data			
Number of pumps	2-6	2-3	2-6
Motor power [Hp (kW)]	0.50 - 30 (0.37 - 22) ⁴⁾	1.5 - 7.5 (1.11 - 5.5)	0.5 - 75 (0.37 - 55) ⁴⁾
Shaft seal			
HQQE (SiC/SiC/EPDM)	•		•
AQQE (SiC/SiC/EPDM)		•	
Materials			
CR, CRE 3 to CR, CRE 155, CR 185 to CR 255: cast iron and stainless steel EN 1.4301 / AISI 304	•		•
CME 3 to CME 25: A-version CI/304 SS		•	
Manifold: stainless steel ⁵⁾	•	•	•
Pipe connection			
NPT connection	2-3"	1.5 - 2.5"	2-3"
Flange connection	4-16"	3-4"	4-20"

2) Systems with lower and higher temperature are available on request. Max. liquid temperature for systems with CR, CRE 3, CR, CRE 5 and CME pump models is 140 °F (60 °C). For other pump sizes, max. liquid temperature is 180 °F (82 °C).

3) Systems with a maximum operating pressure higher than 232 psi (16 bar) are available on request.

4) The Hydro MPC-E (CRE) systems from 0.50 to 30 Hp (0.37 to 22 kW) are fitted with speed-controlled CRE pumps with integrated frequency converters. The Hydro MPC-E (CUE) systems from 40 to 75 Hp (30 to 55 kW) are fitted with CR pumps connected to Grundfos CUE frequency converters. MPC-E (CUE) systems are available in Hp range of MPC-E (CRE), if requested.

5) In some regions, galvanized manifolds are available as an option. For further information, contact Grundfos.

- Available as standard.

Related information

[Control variants](#)

Control variants

Systems with speed-controlled pumps

Hydro MPC-E (CRE or CME)

Hydro MPC-EC (CUE)

Hydro MPC system with three CRE, CME pumps.

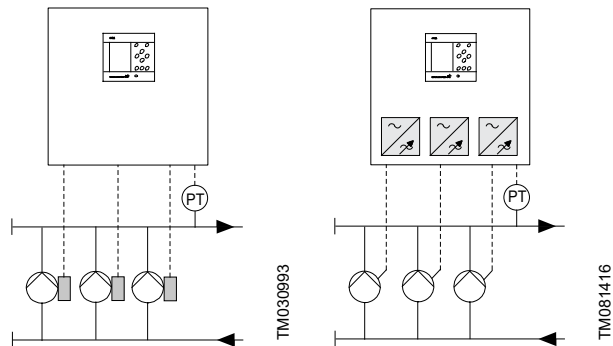

One CRE, CME pump in operation.

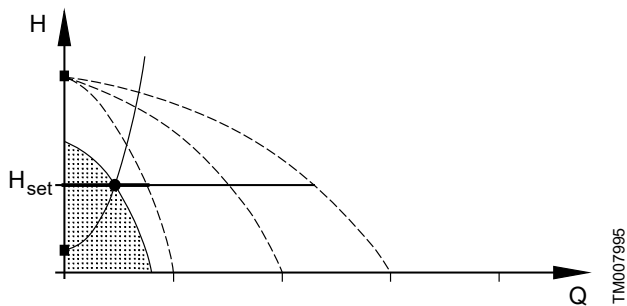

Three CRE, CME pumps in operation.

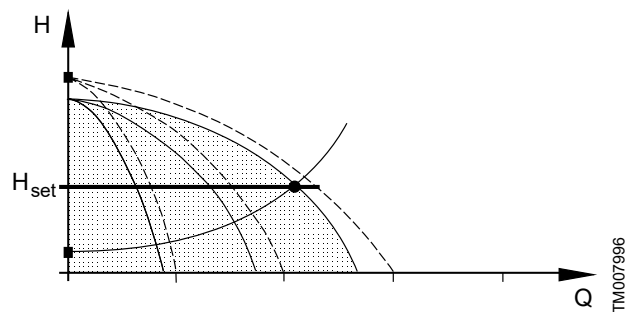

- Hydro MPC-E maintains constant pressure through continuously variable adjustment of the speed of the CRE, CME pumps connected.
- The performance is adjusted to the demand through cutting in/out the required number of CRE, CME pumps and through parallel control of the pumps in operation.
- Pump changeover is automatic and depends on load, operating hours and fault.
- All pumps in operation run at the same speed.

Type key

Example: Hydro MPC-E 6 CRNE155-1-1 U1 A-A-A-ABCD

Code	Explanation	Designation
Hydro MPC		System name
E	E: All pumps E Motor or CUE F: Fixed speed pumps, 1 CUE	S: Fixed speed pumps X: Customised system type System type
6		Number of main pumps
CRNE155-1-1		Pump type
U1	U1: 3 x 380-415 V, N, PE, 50/60 Hz U2: 3 x 380-415 V, PE, 50/60 Hz U3: 3 x 380-415 V, N, PE, 50 Hz U4: 3 x 380-415 V, PE, 50 Hz U5: 3 x 380-415V, N, PE, 60 Hz U6: 3 x 380-415 V, PE, 60 Hz U7: 1 x 200-240 V, PE, 50/60 Hz U8: 1 x 200-240 V, N, PE, 50/60 Hz U9: 3 x 220-240 V, PE, 60 Hz	UA: 3 x 440-480 V, PE, 60 Hz UB: 1 x 220-240 V, N, PE, 50/60 Hz UC: 1 x 220-240 V, N, PE, 50 Hz UD: 3 x 440-480 V, N, PE, 60 Hz UJ: 1 x 208-230 V, PE, 60 Hz UK: 3 x 208-230 V, PE, 60 Hz UL: 3 x 460-480 V, PE, 60 Hz UX: CSU variant (special voltage rating) Voltage code
A	A: Systems with the control cabinet mounted on the same base frame as the pumps. B: Systems with the control cabinet centered on the base frame. C: Systems with the control cabinet mounted on its own base for floor mounting. The control cabinet can be placed up to 50 ft from the pumps. D: Systems with the control cabinet mounted on its own base frame. The control cabinet can be placed up to 50 ft from the pumps. W: Systems with the control cabinet prepared for wall mounting. The control cabinet can be placed up to 50 ft from the pumps.	Design
A	A: E B: DOL C: SD	Starting method
A	A: Stainless steel manifold and base frame, and standard valves B: Stainless steel manifold, base frame and valves C: Galvanised steel manifold and base frame, and standard valves D: Stainless steel manifold, galvanised steel base frame, and standard valves H: Galvanised steel manifold and base frame painted black, and standard valves I: Stainless steel manifold and base frame painted black, and standard valves X: Customized material combination	Material combination
ABCD	A: Standard hydraulic, PN 16 B: Pilot pump C: Bypass D: Check valve on inlet E: Elbow manifold F: No inlet manifold G: Diaphragm tank H: Dry-running protection I: Repair switch J: Redundant sensor or switch K: 1 free pump position L: 2 free pump position M: 3 free pump position	N: PN 10 pressure rating O: PN 25 pressure rating P: Low prepressure Q: PN 40 pressure rating R: RPM = 50 Hz S: Customised variant T: Certificate U: Undersized motor V: Standard controls with options W: Customized controls 3W: Hydro DDD panel X: More than 4 options Y: Control cabinet with double door Option

Nameplate

The nameplate of the system is fitted on the base frame.

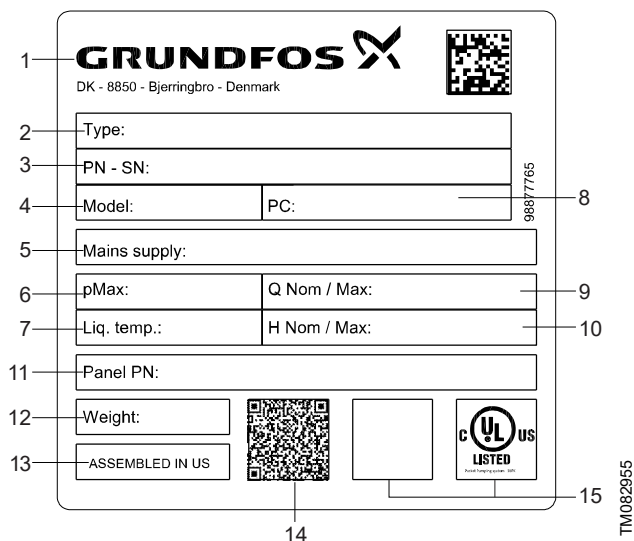

Nameplate example

Pos.	Description
1	Company address
2	Product type
3	Product number, Serial number
4	Model code
5	Mains supply
6	Max. operating pressure
7	Liquid temperature
8	Production code
9	Nominal flow rate and maximum flow rate
10	Nominal head and maximum head
11	Product number for control cabinet
12	Weight
13	Country of origin
14	QR code
15	Marks of approval

Sound pressure level

The sound pressure depends on the specific pump type and motor size. You can find the sound pressure level in the installation and operating instructions of the pump.

In systems with multiple pumps, the maximum total sound pressure $L_{p,tot}$ increases proportionally with the total number of pumps. You can calculate the value using the equation stated below.

Multiple sound sources may generally be added as⁶⁾

$$L_{p,tot} = 10 \log_{10} \sum_i 10^{\frac{L_{p,i}}{10}}$$

This means that for a system with multiple identical pumps N , the total system sound level $L_{p,tot}$ may be calculated by adding the values below to the sound level of the specific pump type.

$$L_{p,tot} = L_p + \Delta L_p$$

Number of pumps N	ΔL_p dB(A)
1	0
2	3
3	5
4	6
5	7
6	8

⁶⁾ Leo Beranek and Istvan L. Ver, *Noise and Vibration Control Engineering*, John Wiley and Sons, 1992

3. Construction

System structure

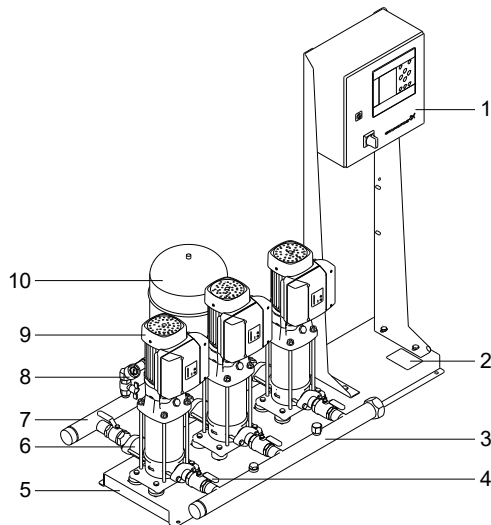

System structure with CRE pumps

Pos.	Description	Quantity
1	Control cabinet	1
2	Nameplate	1
3	Inlet manifold	1
4	Isolating valve	2 per pump
5	Base frame	1-2
6	Check valve	1 per pump
7	Outlet manifold	1
8	Pressure transmitter or pressure gauge	1
9	Pump	2-6
10	Diaphragm tank (optional)	1

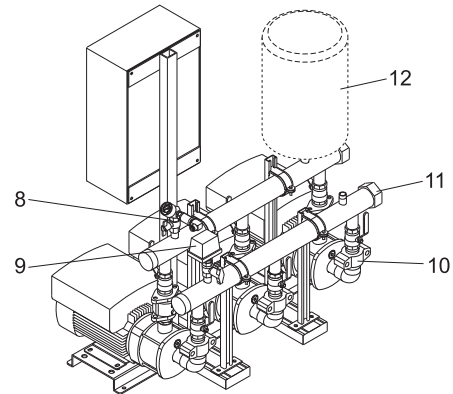

TM058633

System structure with CME pumps

Pos.	Description	Quantity
1	Control cabinet	1
2	Inlet manifold (316 SS)	1
3	Outlet manifold (316 SS)	1
4	Isolating valve (nickel plated brass)	2 per pump
5	Check valve (Polyacetal (POM))	1 per pump
6	Pump (CME A-version CI/304 SS)	2-3
7	Base frame (304 SS)	1
8	Pressure transmitter and pressure gauge	1
9	Inlet pressure switch and pressure gauge	1
10	Oval flange connection (CME 3 - CME 10)	2 per pump
	Intermediate adapter connection (CME 15)	1 per pump
11	Screw cap or blanking flange	2
12	Diaphragm tank, available as an accessory	Optional

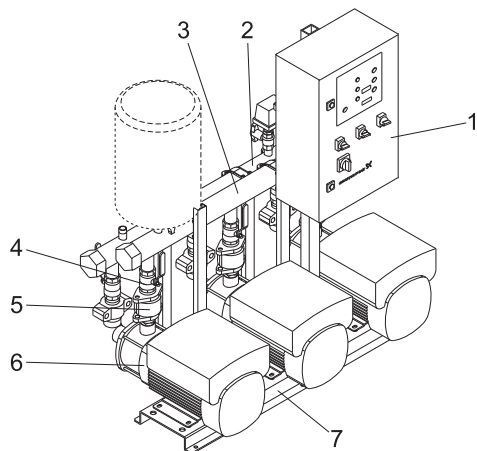

TM058632

CR pump

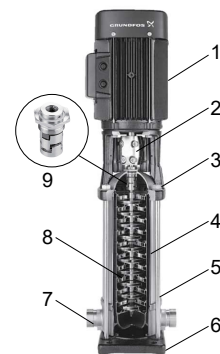

TM078647

CR pump

Pos.	Description
1	Motor
2	Coupling
3	Pump head
4	Sleeve
5	Staybolts
6	Base plate
7	Base
8	Impeller
9	Shaft seal (cartridge type)

CR pumps are non-self-priming, vertical multistage centrifugal pumps.

Each pump consists of a base and a pump head. The chamber stack and outer sleeve are secured between the pump head and the base using staybolts. The base has inlet and outlet ports at the same level (in line) and of the same port size.

CRE pumps are based on CR pumps. The difference between CR and CRE pumps is the motor. CRE pumps are fitted with a motor with an integrated frequency converter.

CR and CRE pumps have pump head and base of cast iron. All hydraulic parts are made of stainless steel.

For further information, see the documents in section Product manuals.

Related information

[14. Product manuals](#)

CME pump



TM074882

Grundfos CME pumps (cast-iron version)

The Grundfos CME pumps are non-self-priming, horizontal, multistage, end-suction centrifugal pumps. The pumps are of the close-coupled type.

CME pumps have an integrated frequency converter and mechanical shaft seals.

The compact design of the Hydro MPC CME is achieved through the unique combination of size and performance offered by the Grundfos CM, CME pumps. Certain dimensions of the CM, CME pumps are 30 % smaller than those of corresponding pumps with identical performance.

For further details on the pumps, see the data booklets of CM, CME in section Product manuals.

Related information

[14. Product manuals](#)

MLE motors

CRE and CME pumps

CRE and CME pumps are fitted with a totally enclosed, fan-cooled, 2-pole motor with an integrated frequency converter. Principal dimensions are in accordance with EN standards. Electrical tolerances to EN 60034.

Motor with an integrated frequency converter				
	P2: ≤ 1.5 Hp (1.1 kW)	P2: 1.5 - 7.5 Hp (1.1 - 5.5 kW)	P2: 1-15 Hp (0.75 - 11 kW)	P2: 20-30 Hp (15-22 kW)
Mounting designation	V18		Up to 5 Hp (4 kW): V18 From 7.5 Hp (5.5 kW): V1	
Insulation class	F			
Efficiency class	Up to 30 Hp (22 kW): exceeding IE5 See Low-energy consumption in section Benefits.			
Enclosure class	IP55			
Supply voltage	1 × 200-240	3 × 200-240	3 × 440-480	3 × 440-480
Tolerance: ± 10 %	V, 60 Hz	V, 60 Hz	V, 60 Hz	V, 60 Hz

Motors with an integrated frequency converter require no external motor protection. The motor incorporates thermal protection against slow overloading and seizure, classified as TP 211 according to IEC 60034-11.

Related information

[Features and benefits](#)

Shaft seal

CR, CRE pumps have a maintenance-free mechanical cartridge type HQQE shaft seal. Seal faces are made of silicon carbide. Rubber parts are made of EPDM.

Other shaft seal variants are available on request.



GR3395H

Cartridge shaft seal

You can replace the shaft seal without dismantling the pump. For pumps with motors above 10 Hp, you can replace the shaft seal without removing the motor.

For further information, see the document in section Product manuals.

Related information

[14. Product manuals](#)

Base frame

The pumps in the system are mounted on a common base frame. The base frame is made of stainless steel AISI 304. For systems with CR, CRE 95 and above, the pumps are mounted on a corrosion protected steel base frame.

An isolating valve and a check valve are fitted between the outlet manifold and the individual pumps. The check valve can be fitted on the inlet side on request.

Manifold

The stainless steel manifolds (AISI 316/EN DIN 1.4571/EN DIN 1.4404) are fitted on the inlet and outlet side of the pumps.

Flange

Class 150 flanges, 4" - 20"

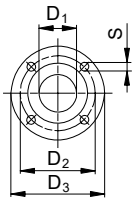

NPS	Nominal diameter (D)								
	4"	6"	8"	10"	12"	14"	16"	18"	20"
D ₁	4.342 (110.3)	6.467 (164.3)	8.467 (215.1)	10.42 (264.7)	12.39 (314.7)	13.62 (346)	15.62 (396.8)	17.62 (447.6)	19.56 (496.9)
D ₂	7.5 (190.5)	9.5 (241.3)	11.75 (298.5)	14.25 (362)	17 (431.8)	18.75 (476.3)	21.25 (539.8)	22.75 (577.9)	25 (635)
D ₃	9 (228.6)	11 (279.4)	13.5 (342.9)	16 (406.4)	19 (482.6)	21 (533.4)	23.5 (596.9)	25 (635)	27.5 (698.5)
S	8 x 0.75 (8 x 19.1)	8 x 0.88 (8 x 22.4)	8 x 0.88 (8 x 22.4)	12 x 1 (12 x 25.4)	12 x 1 (12 x 25.4)	12 x 1.12 (12 x 28.4)	16 x 1.12 (16 x 28.4)	16 x 1.25 (16 x 31.75)	20 x 1.25 (20 x 31.75)

Class 300 flanges, 4" - 20"

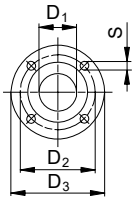

NPS	Nominal diameter (D)								
	4"	6"	8"	10"	12"	14"	16"	18"	20"
D ₁	4.342 (110.3)	6.467 (164.3)	8.467 (215.1)	10.42 (264.7)	12.39 (314.7)	13.62 (346)	15.62 (396.8)	17.62 (447.6)	19.56 (496.9)
D ₂	7.88 (200.1)	10.62 (269.7)	13 (330.2)	15.25 (387.3)	17.75 (450.8)	20.25 (514.3)	22.5 (571.5)	24.75 (628.6)	27 (685.8)
D ₃	10 (254)	12.5 (317.5)	15 (381)	17.5 (444.5)	20.5 (520.7)	23 (584.2)	25.5 (647.7)	28 (711.2)	30.5 (774.7)
S	8 x 0.88 (8 x 22.3)	12 x 0.88 (12 x 22.3)	12 x 1 (12 x 25.4)	16 x 1.12 (16 x 28.4)	16 x 1.25 (16 x 31.7)	20 x 1.25 (20 x 31.7)	20 x 1.38 (20 x 35)	24 x 1.38 (24 x 35)	24 x 1.38 (24 x 35)

Note that the values in brackets are dimensions in mm.

Control cabinet

The control cabinet is fitted with all the necessary components. If necessary, the system is fitted with a fan for dissipating excess heat generated by the frequency converter.

The control cabinet has different designs:

Control cabinet variants

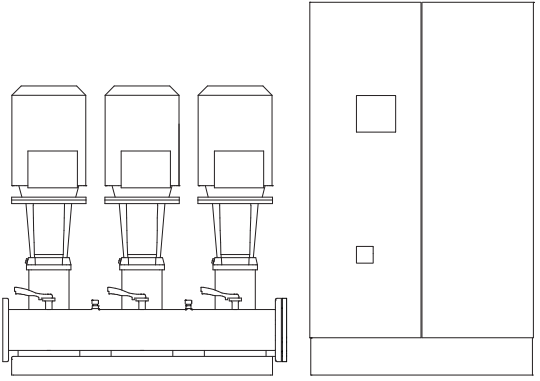
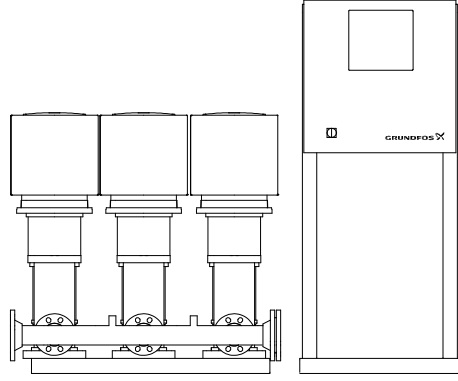
Variants	Description	Examples
Design C	Systems with the control cabinet mounted on its own base for floor mounting. The control cabinet can be placed up to 50 ft from the pumps.	 TM0066209
Design D	Systems with the control cabinet mounted on its own base frame. The control cabinet can be placed up to 50 ft from the pumps.	 TM0066210

CU 352

The CU 352 multi-pump control unit of the system is located on the door of the control cabinet.



CU 352

The CU 352 features a color display, ten buttons and two indicator lights. The operating panel allows manual setting and change of parameters such as setpoint, start/stop of system or individual pumps.

The CU 352 has application-optimized software for adapting the system to the specific application.

IO 351

IO 351 is a module for exchange of digital and analog signals between CU 352 and the remaining electrical system via GENIbus. IO 351 is available in the A and B variants.



IO 351A and IO 351B

IO 351A

IO 351A is used for one to three mains-operated Grundfos pumps.

IO 351B

IO 351B is used for one to six mains-operated Grundfos pumps and/or pumps controlled by external Grundfos CUE frequency converters. The module can also be used as an input-output module for communication with monitoring equipment or other external equipment.

GR-1014555

4. Control functions

CU 352 operating panel

The operating panel on the front cover of the control cabinet features a display, a number of buttons and two indicator lights. The operating panel allows manual setting and monitoring of the system performance.

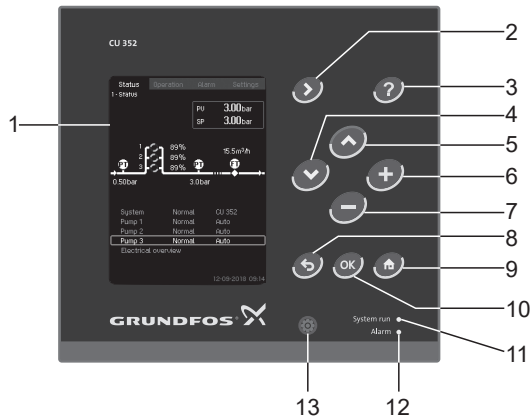

CU 352 operating panel

Pos.	Description
1	Display
2	Arrow to the right
3	Help
4	Down
5	Up
6	Plus
7	Minus
8	Esc.
9	Home
10	OK
11	Indicator light, operation (green)
12	Indicator light, fault (red)
13	Display brightness

Status menu

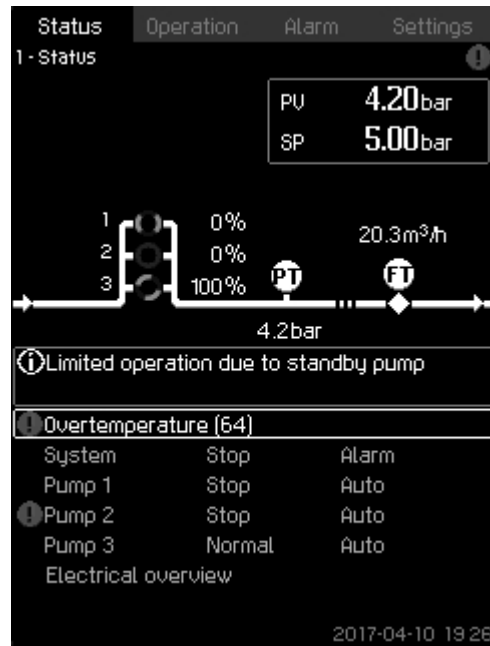

Status menu

- Reading of process value (PV) of control parameter and selected setpoint (SP)
- graphical illustration of system (upper half of the display)
- indication if any incidents occurring during operation (middle of the display)
- reading of performance of system and individual pumps (lower half of the display)
- button for further information
- active buttons are on.

Operation menu

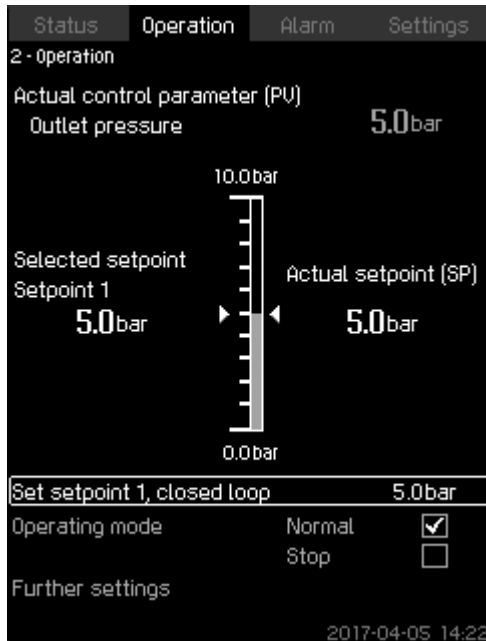

2_TMO38950_002

Operation menu

- Setting of basic parameters, for instance, setpoint or start/stop of system or individual pumps
- reading of selected setpoint and current setpoint
- button ⓘ for further information
- active buttons are on.

Alarm menu

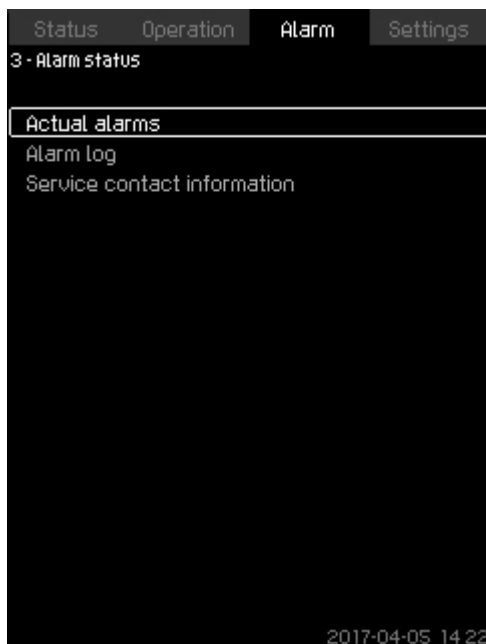

3_TMO32291_003

Alarm menu

- Overview of current warnings and alarms in clear text with detailed information:
 - cause of the fault
 - remedy for the fault
 - where the fault occurred: system, pump no. 1, etc.
 - when the fault occurred (time and date)
 - when the fault disappeared (time and date)
 - whom to contact for service
- alarm log with up to 24 warnings and alarms
- button ⓘ for further information
- active buttons are on.

Settings menu

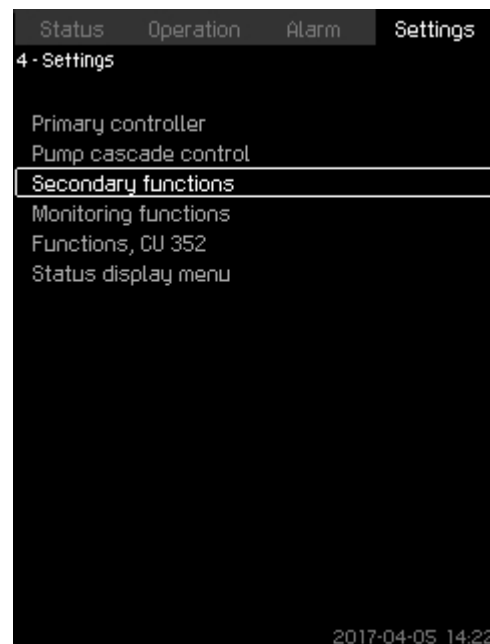

4_TMO32294_004

Settings menu

- Various settings:
 - **External setpoint influence**
 - **Redundant primary sensor**
 - **Standby pumps**
 - **Stop function**
 - **Proportional pressure**
 - **Display language**
 - **Ethernet**, etc.
- button ⓘ for further information
- active buttons are on.

Overview of functions

	Hydro MPC-E/EC
Functions via the CU 352 operating panel	
Alternative setpoints	•
Automatic cascade control	•
Clock program	•
Controlled output	•
Constant-pressure control	•
Dry-running protection ⁷⁾	•
Emergency run	•
Flow estimation	•
Forced pump changeover	•
Limit 1 and 2 exceeded	•
Log function	•
Minimum changeover time	•
Monitoring of non-return valve ⁸⁾	•
Multisensor	•
Number of starts per hour	•
Password	•
Pilot pump ⁷⁾	•
Proportional pressure	•
Pump curve data	•
Pumps outside duty range	•
Pump test run	•
Reduced operation	•
Redundant primary sensor ⁷⁾	•
Secondary sensor	•
Setpoint ramp	•
Specific energy calculation	• ⁹⁾
Soft pressure buildup	•
Standby pumps	•
Stop function	•
Communication	
Ethernet connection	•
External GENibus connection	○
Other bus protocols:	
PROFIBUS, LonWorks, Modbus, GRM, GSM, BACnet MS/TP, Industrial Ethernet via CIM modules.	○
For further information, see section Optional equipment.	

7) Hardware not supplied as standard, but the functionality is available in the control cabinet.

8) Systems with MLE motors, 0.5 - 30 Hp (0.37 - 22 kW).

9) Requires that a flowmeter is installed and connected.

- Standard.
- On request.

Related information

[Control variants](#)

[Stop function](#)

[12. Optional equipment](#)

Constant-pressure control of E-system

Constant-pressure control ensures that the system maintains constant pressure despite a change in consumption.

When taps are opened, water is drawn from the diaphragm tank, if installed. The pressure drops to a set cut-in pressure, and the first speed-controlled pump starts. The speed of the pump in operation continuously increases to meet the demand. As the consumption rises, more pumps are cut in until the performance of the pumps in operation meets the demand. During operation, CU 352 controls the speed of each pump individually based on the pump curve data downloaded into CU 352.

Furthermore, CU 352 regularly estimates whether pumps are to be cut in or out to optimize efficiency.

When the water consumption decreases, pumps are cut out one by one to maintain the set outlet pressure.

Display language



4-5-1_TM038887_116

Display language

You can select the language for the display via CU 352.

Options

- English
- Danish
- German
- French
- Italian
- Spanish
- Portuguese
- Greek
- Dutch
- Swedish
- Finnish
- Polish
- Russian
- Korean
- Chinese
- Japanese
- Czech
- Turkish
- Hungarian
- Bulgarian
- Croatian
- Latvian
- Lithuanian
- Romania
- Slovak
- Slovenian
- Serbian Latin
- US English
- Indonesian
- Malay
- Estonian.

Pump curve data

Status	Operation	Alarm	Settings
4.3.19 - Pump curve data			
Pump data			
Rated flow rate Q _{nom}		10.0m ³ /h	
Rated head H _{nom}		48m	
Max. head H _{max}		61m	
Max. flow rate Q _{max}		0.0m ³ /h	
Motor data			
Power, Q0, 100 % speed		0.00kW	
Power, Q0, 50 % speed		0.00kW	
Rated power P _{nom}		0.00kW	
Flow estimation			
2017-04-05 14:22			

4-3-19_TM038975_104

Pump curve data

Pump curve data is loaded into the CU 352 control unit of the system at the factory.

The control unit uses pump curve data along with inlet and outlet pressure information to analyze and determine the operating point of each pump. This data is used to optimize the performance, minimize energy consumption and protect pumps from running outside their duty range.

Redundant primary sensor

A redundant sensor can be installed as a backup for the primary sensor to increase reliability and prevent stop of operation. The redundant primary sensor can also act as a reference point in the outlet manifold of the system.



The redundant primary sensor is available as a factory-fitted option.

Automatic cascade control

The cascade control ensures that the performance of the system is automatically adapted to consumption by switching pumps on or off. The system thus runs as energy-efficiently as possible with constant pressure and a limited number of pumps.

Alternative setpoints

This function makes it possible to determine up to six setpoints as alternatives to the primary setpoint. The setpoints can be determined for closed loop and open loop. The performance of the system can thereby be adapted to other consumption patterns.

Example

A system is used for irrigation of a hilly golf course.

Constant-pressure irrigation of golf course sections of different sizes and at different altitudes may require more than one setpoint.

For golf course sections at a higher altitude, a higher outlet pressure is required.

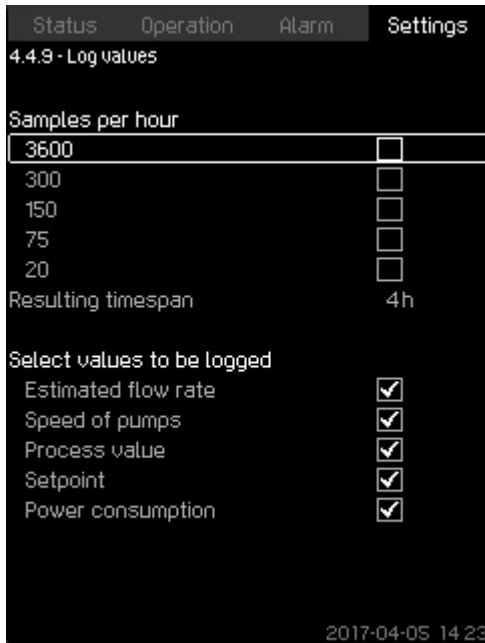
Log function

4-4-9_TM052973_181

Log values

The log function can monitor selected parameters. The data can be presented on the display or exported as a csv file via the built-in Ethernet connection.

Specific energy calculation

For MPC-E systems with a flow meter connected, CU 352 can calculate and show the specific energy used. There are two values displayed: the actual value and the average value.

Number of starts per hour

This function limits the number of pump starts and stops per hour. It reduces noise emission and improves the comfort of systems with mains-operated pumps.

Each time when a pump starts or stops, CU 352 calculates when the next pump is allowed to start or stop in order not to exceed the permissible number of starts per hour.

This function always allows pumps to be started to meet the requirement. However, pump stops can be delayed to avoid exceeding the permissible number of starts/stops per hour.

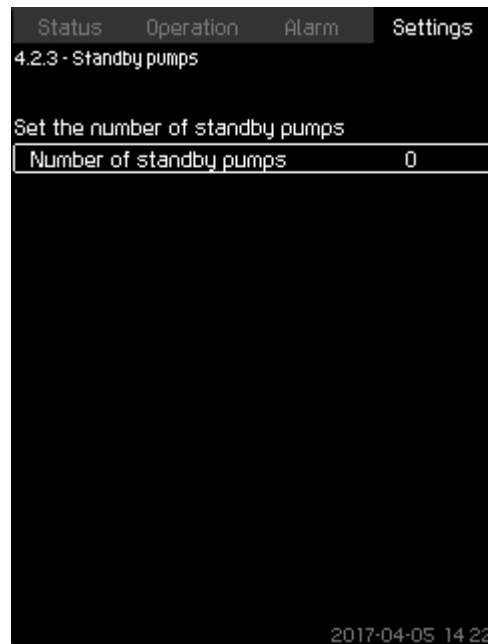
Standby pumps

4-2-3_TM032366_075

Standby pumps

You can let one or more pumps function as standby pumps. For example, a system of four pumps with one designated to be a standby pump runs as a three-pump system.

If a pump stops due to a fault, the standby pump is cut in. This function ensures that the system can maintain the rated performance even if one of the pumps is stopped due to a fault.

The status of the standby pump alternates between all pumps of the same type, for instance, electronically speed-controlled pumps.

Forced pump changeover

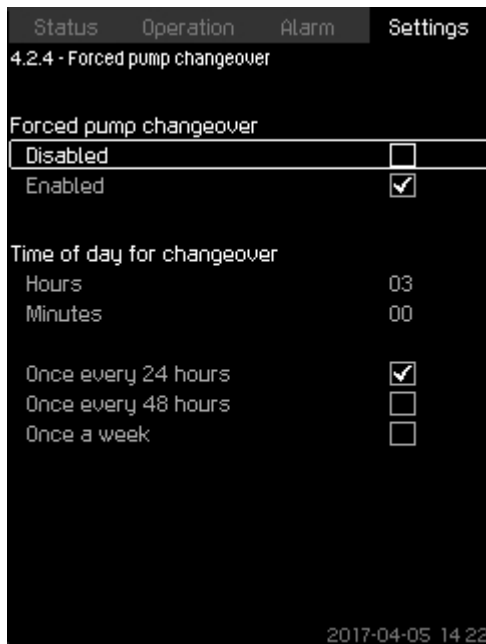

4-2-4_TM032365_058

Forced pump changeover

This function ensures that the pumps run for the same number of operating hours over time.

In certain applications, the required flow remains constant for long periods and does not require all pumps to run. In such situations, pump changeover does not take place automatically, and forced pump changeover may be required.

Once every 24 hours, the control unit checks if any pump in operation has been running continuously for the preceding 24 hours.

If that is the case, the pump with the highest number of operating hours stops and is replaced by the pump with the lowest number of operating hours.

Pump test run

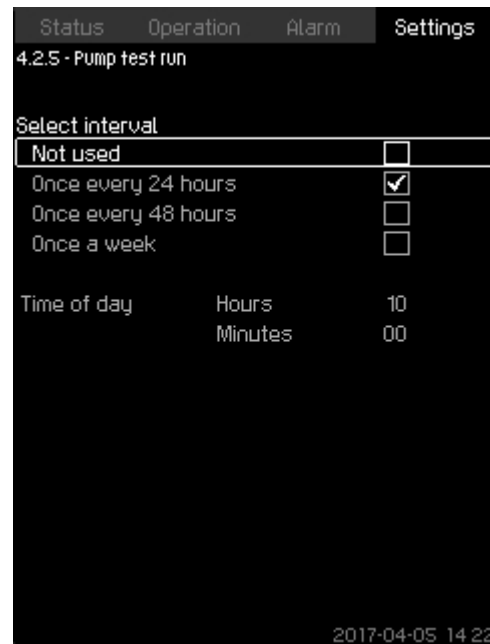

4-2-5_TM032364_057

Pump test run

This function is primarily used for connecting pumps that do not run every day.

Benefits:

- Pumps do not seize up during a long standstill due to deposits from the pumped liquid.
- The pumped liquid does not decay in the pump.
- Trapped air is removed from the pump.
- The pump starts automatically and runs for a short time.

Dry-running protection

This function is one of the most important ones, as dry running may damage bearings and shaft seals.

The inlet pressure of the system or the water level in a tank, if any, on the inlet side is monitored. If the inlet pressure or the water level is too low, all pumps stop.

Level switches, pressure switches or analog sensors indicating water shortage at a set level can be used. The system can also be reset and restarted manually or automatically after water shortage.

Stop function

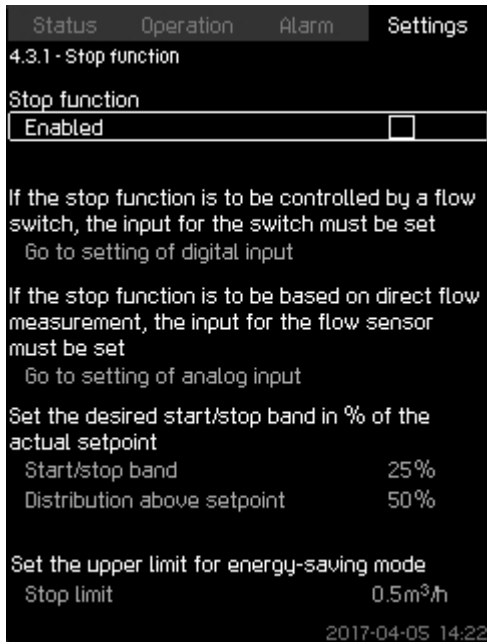

4-3-1_TM032355_102

Stop function

The stop function makes it possible to stop the last pump in operation if there is no or very low consumption.

Purposes are to:

- save energy
- prevent heating of shaft-seal faces due to increased mechanical friction as a result of reduced cooling by the pumped liquid
- prevent heating of the pumped liquid.

This function is only used in systems with variable-speed pumps.

When the stop function is enabled, CU 352 continuously monitors the flow rate of the system. If there is no flow or the flow rate is low ($Q < Q_{min}$), CU 352 changes from normal constant-pressure operation to on/off control of the last pump in operation.

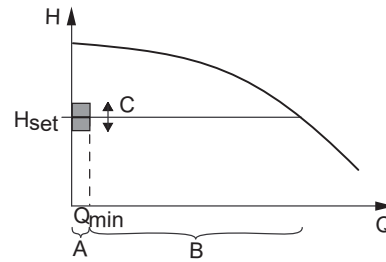

TM078147

On/off band

Pos.	Description
A	On/off control
B	Normal operation
C	Start/stop band

As long as the flow rate is lower than Q_{min} , the pumps run in on/off operation. If the flow rate rises above Q_{min} , the pumps return to normal constant-pressure operation.

Via CU 352, you can set the system to operate as energy-efficiently as possible or with the highest level of comfort.

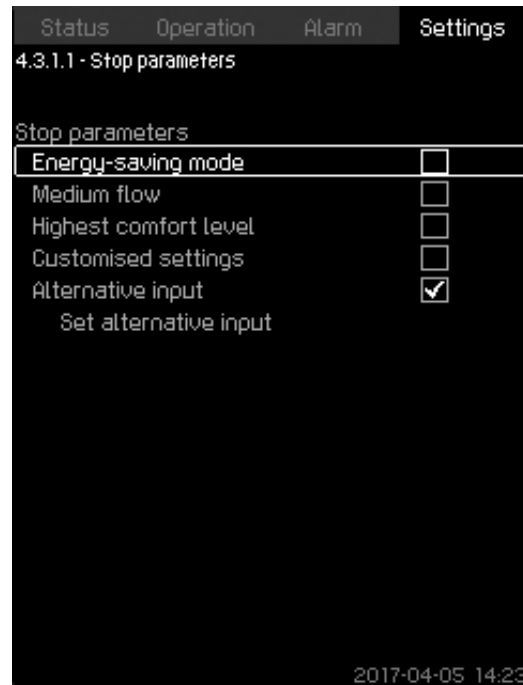

4-3-1_1_STOP_PARAMETERS_171

Stop parameters

Five stop parameters can be selected:

- **Energy-saving mode (factory setting)**
It is the most energy-efficient mode possible.
- **Medium flow**
It combines energy efficiency with high comfort.
- **Highest comfort level**
It achieves the highest comfort level without too many pump starts or stops.
- **Customised settings**

It allows for customized setup.

- **Alternative input**

It allows for defining the stop flow on the basis of the system setpoint, total tank volume or pre-charge pressure.

Status	Operation	Alarm	Settings
4.3.1.1.1 - Alternative input			
Precharge factor		0.7	
Pressure drop		6%	
Speed reduction		8%	
Desired stop flow		3.0m ³ /h	
System setpoint		4.0bar	
Total tank volume		8Litres	
Dt, pump stopped		0.4s	
Dt, pump running		0.5s	

2017-04-05 14:23

4-3-1-1-1_ALTERNATIVE_INPUT_201

Alternative input

Setpoint ramp

Status	Operation	Alarm	Settings
4.1.9 - Setpoint ramp			
Setpoint ramp			
Disabled		<input checked="" type="checkbox"/>	
Enabled		<input type="checkbox"/>	
Change per minute		2.0bar	

2017-04-05 14:23

4-1-9_TM052969_174

Setpoint ramp

If this function is enabled, it slows down the setpoint change, whether the setpoint change is done by the control unit, the clock program or a SCADA system, to keep the system stable.

Pilot pump

The pilot pump takes over the operation from the main pumps when the consumption is so low that the stop function of the main pumps is activated.

Purposes are to:

- reduce the necessary size of the diaphragm tank
- reduce the number of operating hours of the main pumps.

Password

Status	Operation	Alarm	Settings
4.5.4 - Password			
Password, menu Operation			
Disabled		<input checked="" type="checkbox"/>	
Enabled		<input type="checkbox"/>	
Enter password		1 2 3 4	
Password, menu Settings			
Disabled		<input checked="" type="checkbox"/>	
Enabled		<input type="checkbox"/>	
Enter password		1 2 3 4	

2017-04-05 14:23

4-5-4_TM032899_115

Password

Passwords make it possible to limit the access to the **Operation** and **Settings** menus of the control unit. If the access is limited, it is not possible to view or set any parameter in the menus.

Clock program



Clock program

This function allows for specifying day and time for up to ten events, including activation or deactivation, for example, activating the sprinkling system of a golf course at fixed times for the individual greens.

Proportional pressure

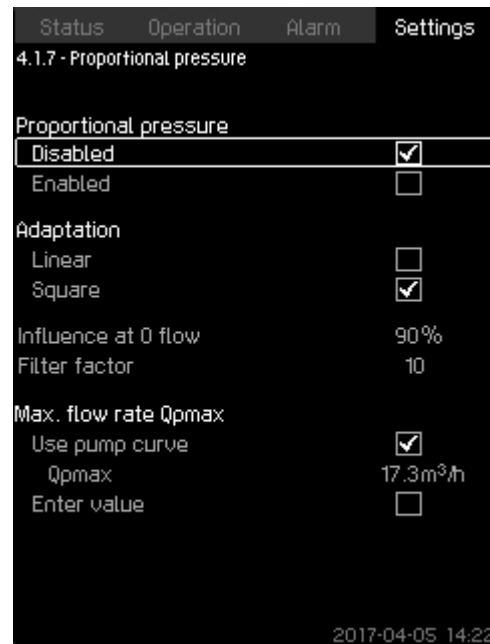

Proportional pressure

This function can be used in applications with a large pipe system, for instance, a village supplied with water from a pumping station or waterworks.

Purposes are to:

- deliver the required water at all times
- compensate for friction loss
- keep energy consumption at a minimum
- ensure the highest comfort level at tapping points, etc.
- minimize water loss from leaks
- reduce wear and tear on pipes.

With high flow rate, the pressure loss in the pipe system is relatively high. To deliver a system pressure of 5 bar in such a situation, the outlet pressure of the system must be set to 6 bar if the pressure loss in the pipe system is 1 bar.

With low flow rate, the pressure loss in the pipe system may only be 0.2 bar. Here the system pressure is 5.8 bar if the setpoint is fixed to 6 bar. That 0.8 bar is too high compared with the peak situation above.

To compensate for excessive system pressure, the proportional pressure function of CU 352 automatically adapts the setpoint to the actual flow rate. The adaptation can be linear or square. Such an automatic adaptation results in large energy savings and optimum comfort at the tapping point.

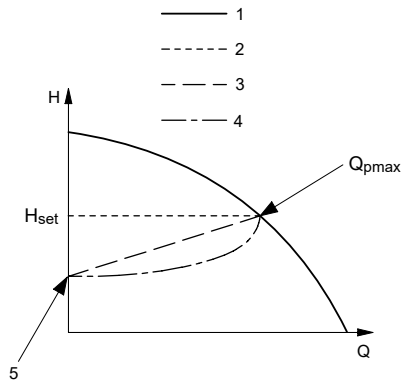

TM038524

Proportional-pressure control

Pos.	Description
1	Pump curve
2	Setpoint
3	Resultant setpoint, linear
4	Resultant setpoint, square
5	Starting point of proportional-pressure control (influence at 0 flow = x % of H_{set})

Q_{pmax} is the expected maximum flow rate. It can be set to either the maximum flow that the system can deliver at a determined setpoint, or a value entered manually based on a known or assessed maximum flow rate.

Example

Influence at 0 flow (Q_0) = pressure loss in supply pipe x 100 % / setpoint.

Influence at 0 flow (Q_0) = 1 bar x 100 % / 6 bar = 16.67 %.

Setpoint at Q_{min} with proportional-pressure control:

6 bar - (6 bar x 0.1667) = 5 bar.

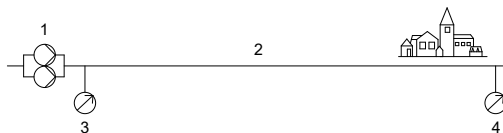

TM081526

Without proportional-pressure control

Pos.	Description
1	Pumping station
	Pressure loss
2	Q_{max} : 1 bar Q_{min} : 0.2 bar
3	Setpoint: 6 bar
	System pressure
4	Q_{max} : 5 bar Q_{min} : 5.8 bar

Soft pressure build-up

Status	Operation	Alarm	Settings
4.3.3 - Soft pressure build-up			
Soft pressure build-up			
Disabled			<input checked="" type="checkbox"/>
Enabled			<input type="checkbox"/>
Filling phase			
Speed			70 %
Number of pumps			1
Filling pressure			0.0 bar
Max. time			60 s
Max. time reaction			
Warning			<input type="checkbox"/>
Alarm + stop			<input checked="" type="checkbox"/>
Pressure build-up phase			
Ramp time			10 s

2017-04-05 14:22

4-3-3_TM038970_133

Soft pressure build-up

This function is typically used in pressure-boosting applications and ensures a smooth startup of systems with, for instance, empty pipes.

Startup takes place in two phases:

- **Filling phase (1):** The pipes are slowly filled with water. When the pressure sensor of the system detects that the pipes are filled, phase 2 begins.
- **Pressure build-up phase (2):** The system pressure increases until it reaches the setpoint (SP). The pressure buildup takes place over a ramp time. If SP is not reached within a given time, a warning or an alarm will be given, and the pumps will be stopped at the same time.

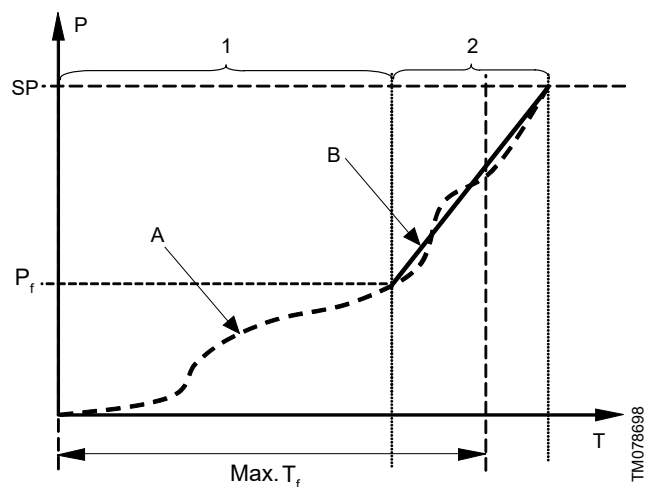

TM078698

Filling and pressure buildup phases

P: Pressure	T: Time [second]
P _f : Filling pressure	T _f : Filling time
<hr/>	
Pos.	Description
1	Filling phase: constant-curve operation
2	Pressure build-up phase: constant-pressure operation
A	Actual value
B	Setpoint ramp-up

Emergency run

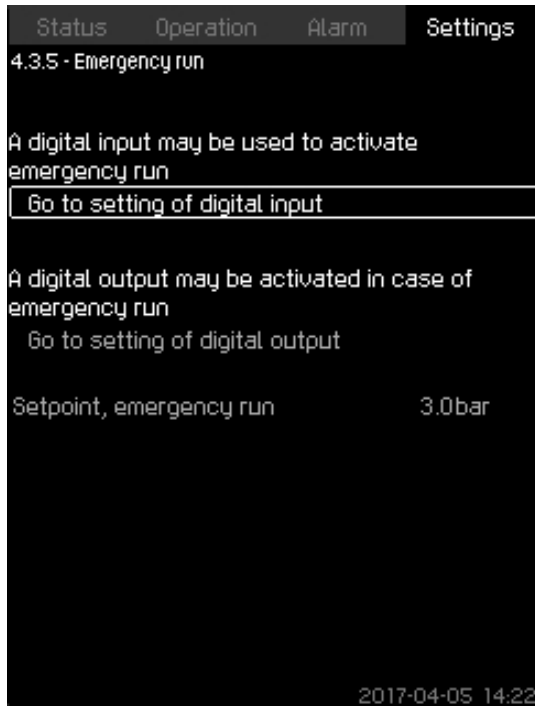

4-3-5_TMO38971_132

Emergency run

This function is for systems where the operation must not be interrupted. The function keeps all pumps running regardless of warnings or alarms. The pumps run according to a setpoint set specifically for this function.

Reduced operation

This function makes it possible to reduce the operation of the system via a digital input. The function is used in applications where the mains power is sometimes switched to generator power. To avoid using more power than the generator can deliver, the system can be derated via a digital input.

Status display menu

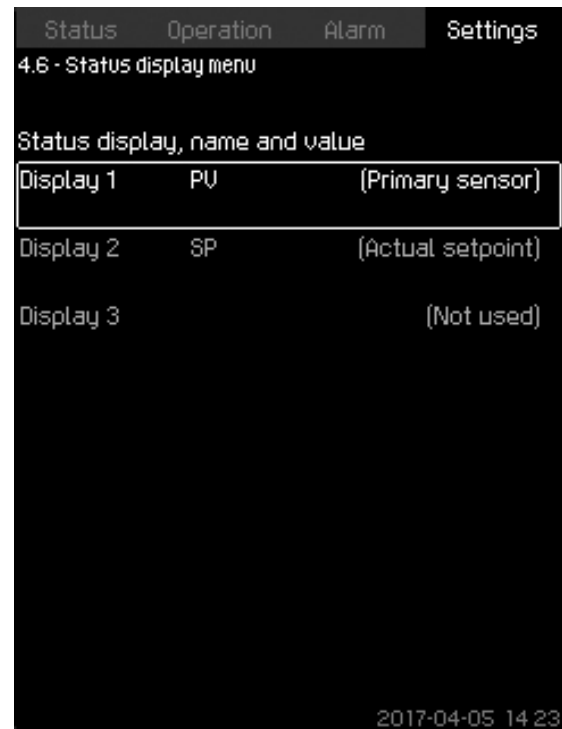

4-6_STATUS_DISPLAY_MENU_196

Status display menu

This main status menu can display up to three status values.

In this menu, you can define each status value and a name for the value.

Examples:

- PV: process value
- SP: setpoint
- Q: flow rate.

Setting range

- Name of each display value.
- Selection of displays 1 to 3.

Setting the display value

1. Go to the **Settings** menu.
2. Select **Status display menu**.
3. Mark the display and press **OK**.
4. Enter a name for the display value.
5. Define the function of the display.

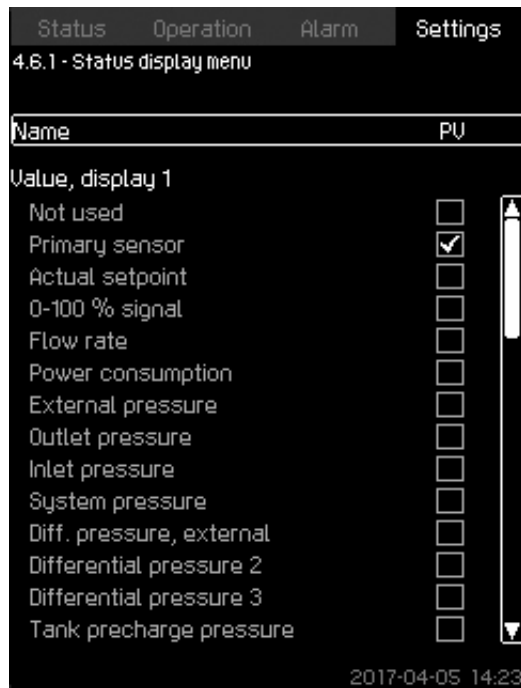

4-6-1_STATUS_DISPLAY_MENU_197

Status display menu

Factory settings

Display 1: PV, primary sensor.

Display 2: SP, actual setpoint.

Non-return valve

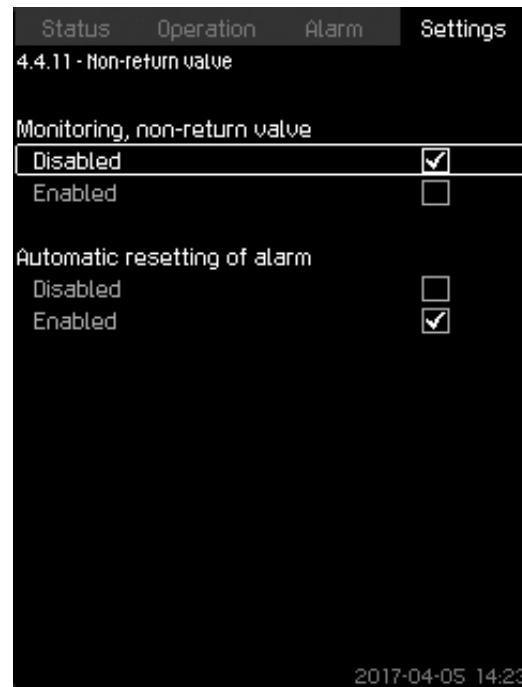

4-4-11_NON-RETURN_VALVE_202

Non-return valve

The function enables CU 352 to detect if a non-return valve is leaking or faulty. After five accumulated incidents, a small leakage triggers a warning. A faulty non-return valve instantly results in an alarm and pump stop. In such case, the motor is not able to overcome the backflow through the pump with the faulty non-return valve.



The function is only valid for an MPC-E system with MLE motors, model F, G, H, I, J or K.

Multisensor settings

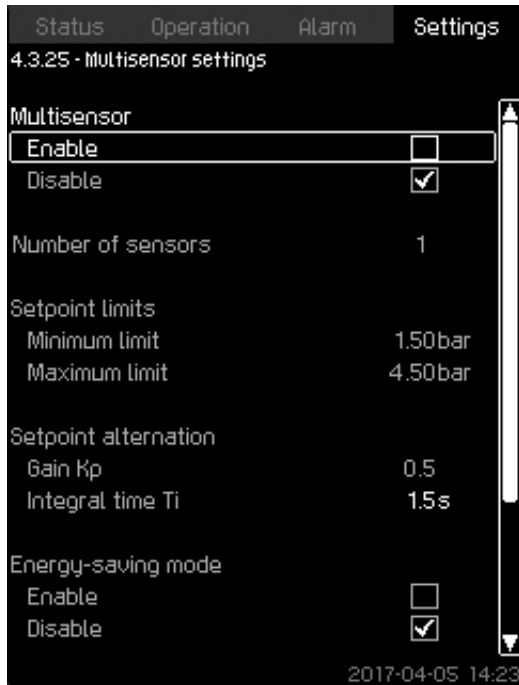

4-3-25_MULTISENSOR_186

Multisensor settings

The function is designed for controlling up to six different zones in a HVAC system with a defined differential-pressure band. If one of the multi-sensor signals is outside the specific sensor limits (minimum or maximum), the function adjusts the setpoint (SP) up or down to ensure that the specific sensor or zone is kept within its pressure band. You can adjust the reaction of the setpoint influence by means of dedicated setpoint alternation, Kp and Ti values. If more sensors are below or above their limits, they can be prioritized. Through activating the energy-saving mode, the system can optimize the actual setpoint by lowering it to the minimum limit of one of the multisensors.

If the multisensor function is enabled, it has higher priority and the following programs are overruled:



- **Clock program**
- **Proportional pressure**
- **Alternative setpoints**
- **External setpoint influence**
- **Setpoint ramp.**

Counter inputs



4-3-11-1_VOLUME_COUNTER_195

Volume counter

You can set CU 352 to accumulate a pumped volume from a digital water meter.



This menu only appears if an IO 351B module is connected to CU 352.

5. Installation

Mechanical installation

Location

The system is only designed for indoor installation and must not be exposed to direct sunlight.

- Install the system in a well-ventilated room to ensure sufficient cooling of the control cabinet and pumps.
- Install the system with a one-meter (3 ft) clearance on all sides for inspection and removal.

Pipes

Arrows on the pump base show the water flow direction through the pump.

The pipes connected to the system must be of adequate size.

Connect the pipes to the manifolds of the system. Either end can be used. Apply sealing compound to the unused end of the manifold, and fit the screw cap. For manifolds with flanges, fit a blanking flange with a gasket.

To optimize operation and minimize noise and vibration, consider vibration dampening of the system.

Noise and vibration are generated by motor and pump rotations, and by the flow in pipes and fittings. The effect on the environment is subjective and depends on correct installation and the condition of the other parts of the system.

If systems are installed in blocks of flats or the first consumer on the line is close to the system, we recommend that you fit expansion joints on the inlet and outlet pipes to prevent vibration from being transmitted through the pipes.

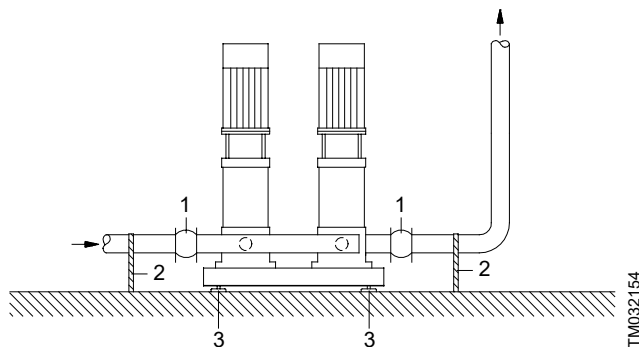

Example showing the position of expansion joints, pipe supports and vibration dampers

Pos.	Description
1	Expansion joint
2	Pipe support (and good location for system isolation valve)
3	Vibration damper

Expansion joints, pipe supports and vibration dampers shown in the figure above are not included in a standard system.

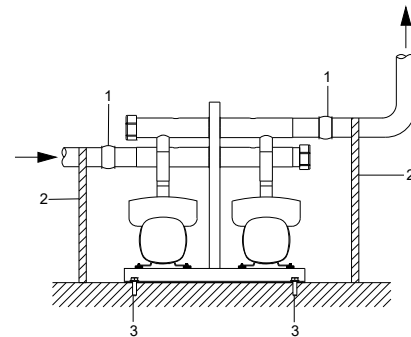

Example showing the position of expansion joints, pipe supports and mounting bolts

Pos.	Description
1	Expansion joint (recommended accessory, good location for system isolating valves)
2	Pipe support
3	Mounting bolt

Expansion joints, pipe supports and mounting bolts shown in the figure above are not included in a standard system.

Foundation

We recommend that you install the system on an even and solid surface, such as a concrete floor or foundation. If the system is not equipped with vibration dampers, bolt it to the floor or foundation.

The weight of a concrete foundation must be at least 1.5 times the weight of the system.

Vibration dampers

To prevent the transmission of vibration to buildings, we recommend that you isolate the system foundation from the building parts by vibration dampers.

A proper damper varies in different installation situations, and a wrong damper may increase the vibration level. Vibration dampers must therefore be sized by the supplier. If the system is installed on a base frame with vibration dampers, always install expansion joints on the manifolds. This is important to prevent the system from "hanging" on the pipes.

Expansion joints

Fit expansion joints for these reasons:

- to absorb expansions or contractions in the pipes caused by changing liquid temperature
- to reduce mechanical strains in connection with pressure surges in the pipes
- to isolate mechanical structure-borne noise in the pipes (only rubber bellows expansion joints).

You must not install the expansion joints to compensate for inaccuracies in the pipes such as center displacement of flanges.

Fit expansion joints at a distance of at least 1 to 1.5 times the nominal flange diameter from the manifold both on the inlet and on the outlet sides. This prevents the development of turbulence in the expansion joints, resulting in better inlet conditions and a minimum pressure loss on the pressure side.

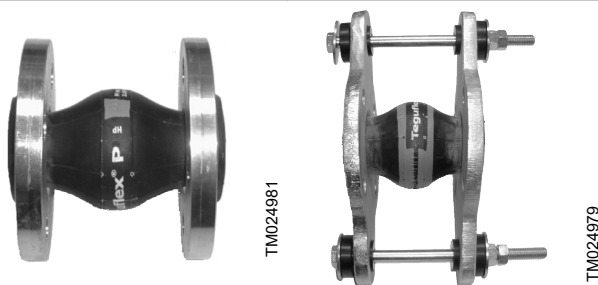

Examples of rubber bellows expansion joints without limiting rods

Examples of rubber bellows expansion joints with limiting rods

Expansion joints with limiting rods can minimize the forces caused by the expansion joints. We always recommend that you use expansion joints with limiting rods for flanges larger than 4 inches.

Anchor the pipes so that they do not stress the expansion joints, manifolds and the pump. Follow the supplier's instructions and pass them on to advisers or pipe installers.

Electrical installation

The electrical installation must be carried out by authorized personnel in accordance with local regulations.

- The electrical installation of the system must be carried out in accordance with enclosure class:
 - UL Type 3R, for control cabinet without VFD in it
 - UL Type 12, for control cabinet with VFD in it.
- Check that the supply voltage and frequency correspond to the values stated on the nameplate. Contact Grundfos if you have special voltage requirements.
- Make sure that the conductor cross-section meets the specifications in the wiring diagram.
- The mains connection must be carried out as shown in the wiring diagram.

Hygiene

Grundfos systems are functionally tested and may therefore contain small amounts of residual water. Contaminated drinking water can endanger health, so before using the system, it must be rinsed or flushed thoroughly. This also applies if the system is not used for a longer period.

Rinsing and flushing must always be done in accordance with local regulations and practices.

6. Sizing

When sizing a system, take the following into account:

- The performance of the system must meet the highest possible demand in terms of both flow rate and pressure.
- The system must not be oversized. This is important in relation to installation and operating costs.

You can size the systems via Grundfos Product Center or this data booklet.

Sizing in Grundfos Product Center (recommended)

We recommend that you size your system in Grundfos Product Center, which is a selection program offered by Grundfos. For further information, see section Grundfos Product Center.

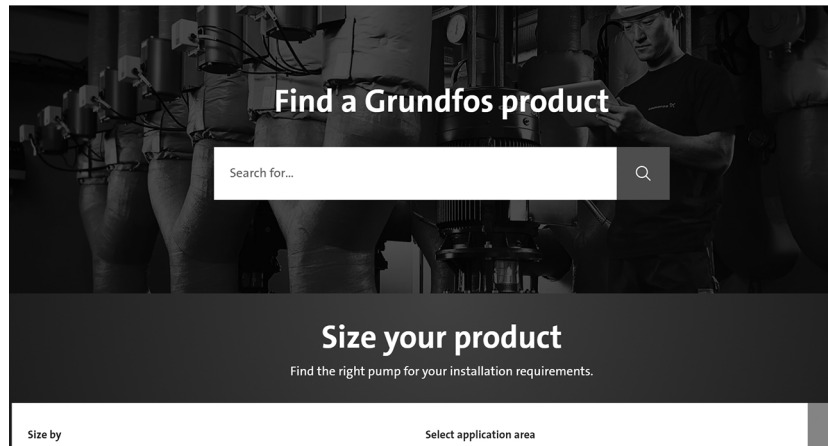

TM083490

Sizing in Grundfos Product Center

Sizing via this data booklet

There are seven steps:

1. maximum flow requirement
2. required outlet pressure
3. system layout
4. consumption profile and load profile
5. inlet pressure
6. system selection
7. accessories.

Related information

[16. Grundfos Product Center](#)

Maximum flow requirement

The total consumption and the required maximum flow rate depend on the specific application. The maximum flow requirement can be calculated by means of the table below which is based on statistical data.

Consumer	Unit	Q_{year}	Consumption period	Q_{day}	$f_d^{10)}$	$Q_{(m)\text{day}}$	$f_t^{11)}$	Maximum flow rate
		[gal/year]	[days/year]	[gal/day]		[gal/day]		[gpm]
Residence building	Residence (2.5 persons)	48,343.5	365	132.4	1.3	172.1	1.7	0.203
Office building	Employee	6,604.3	250	26.4	1.2	31.7	3.6	0.8
Shopping center	Employee	6,604.3	300	22.0	1.2	26.4	4.3	0.078
Supermarket	Employee	21,133.8	300	70.4	1.5	105.6	3.0	0.22
Hotel	Bed	47,551	365	130.3	1.5	195.5	4.0	0.54
Hospital	Bed	79,251.6	365	217.1	1.2	260.5	3.0	0.54
School	Pupil	2,113.4	200	10.6	1.3	13.8	2.5	0.023

¹⁰⁾ Maximum consumption factor, day

¹¹⁾ Maximum consumption factor, hour

Example: Hotel with 540 beds

Number of beds:	n
Total annual consumption:	$Q_{\text{year}} \times n$
Consumption period:	d
Average consumption per day:	$(Q_{\text{year}} \times n) / d$
Maximum consumption per day:	$Q_{(m)\text{day}} = f_d \times Q_{\text{day}}$
Maximum flow requirement per hour:	$Q_{\text{max}} = \text{maximum flow rate/min} \times \text{number of beds}$

Calculation

n	=	540 beds
$Q_{\text{year}} \times n$	=	$47,551 \times 540 = 25,677,540$ gal/year
d	=	365 days/year
$(Q_{\text{year}} \times n)/d$	=	$25,677,540/365 = 70,349.4$ gal/day
$Q_{(m)\text{day}}$	=	$f_d \times Q_{\text{day}} = 1.5 \times 70,349.4 = 105,524.1$ gal/day
Q_{max}	=	Maximum flow rate/min \times number of beds = $0.54 \times 540 = 292$ gpm

Required outlet pressure

The required outlet pressure of the system can be calculated with the following equation:

P_{set}	=	$P_{\text{tap(min)}} + P_f + (h_{\text{max}}/10.2)$
P_{boost}	=	$P_{\text{set}} - P_{\text{in(min)}}$

Key

P_{set}	=	Required outlet pressure in psi
$P_{\text{tap(min)}}$	=	Required minimum pressure at the highest tapping point in psi
P_f	=	Total pipe friction loss in psi
h_{max}	=	Height from system outlet port to highest tapping point in feet
$P_{\text{in(min)}}$	=	Minimum inlet pressure in psi
P_{boost}	=	Required boost in psi

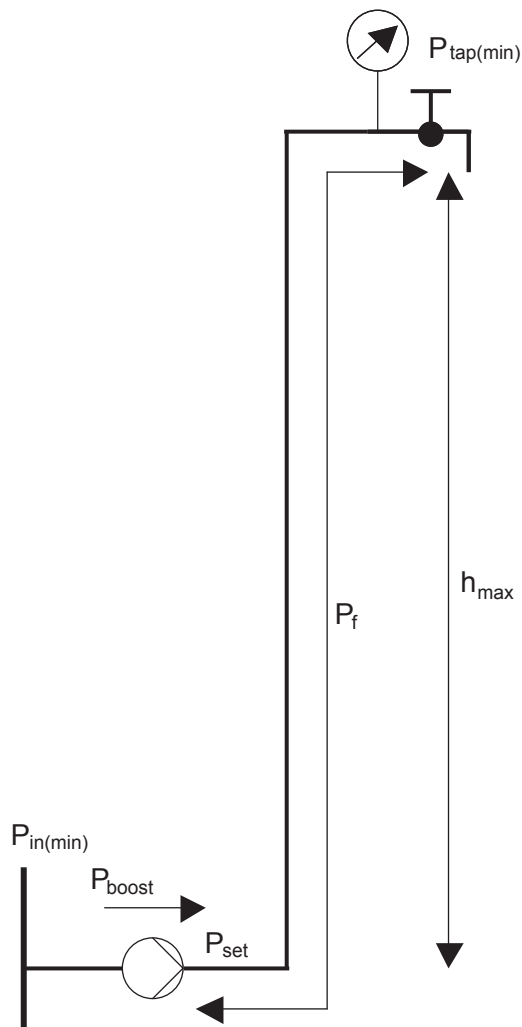

Calculation of required outlet pressure

Example calculation

$P_{tap(min)}$	=	29 psi
P_f	=	17.4 psi
h_{max}	=	136 ft
$P_{in(min)}$	=	29 psi
P_{set}	=	$29 + 17.4 + (136/2.31) = 105.3$ psi
P_{boost}	=	$105.3 - 29 = 76.3$ psi

System layout

- Direct boosting

Example: The system is connected to water mains designed to distribute water from one place to another.

- Break tank

Example: The system is connected to a break tank installed before the system.

- Pressure boosting in zones

Example: A high-rise building or a hilly landscape where the water supply system is divided into zones.

- Roof tank

Example: The system distributes water to a roof tank on top of a high-rise building.

Consumption profile and load profile

The consumption pattern of the installation can be illustrated as a 24-hour consumption profile and a load profile.

24-hour consumption profile

The 24-hour consumption profile is the relation between the time of the day and the flow rate.

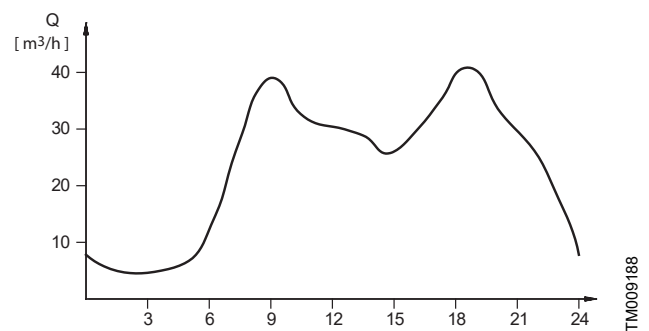

Example of a 24-hour consumption profile

If the consumption is variable and optimum comfort is required, use pumps with continuously variable speed.

Load profile

You can make the load profile when the 24-hour consumption profile is determined.

The load profile shows the percentage of the flow rate at which the system operates per day.

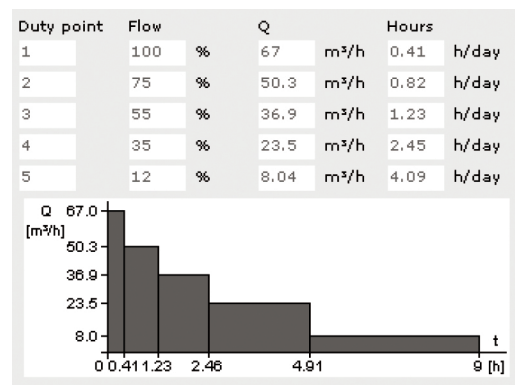

Load profile

Examples of typical 24-hour consumption profiles and their load profiles:

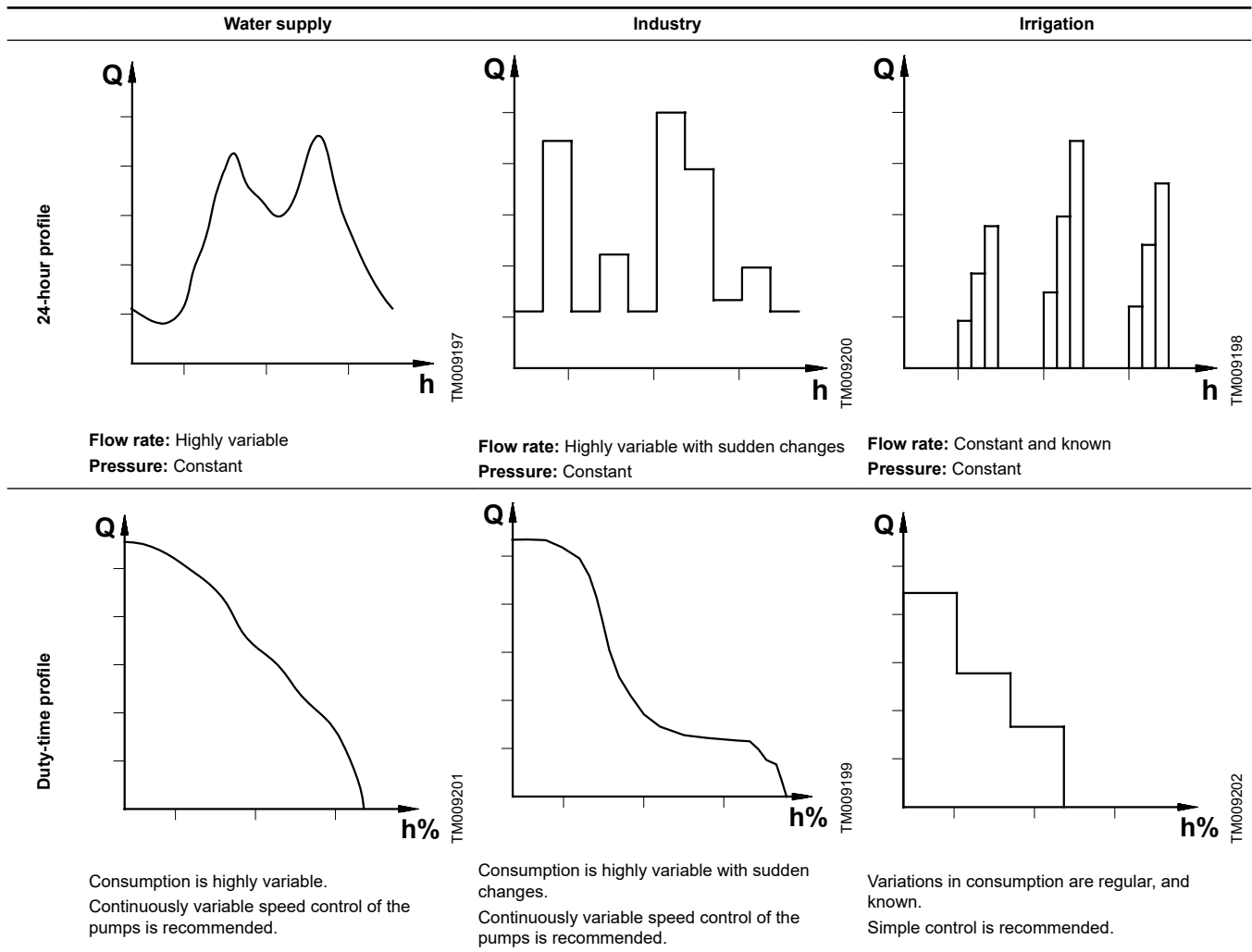

Inlet pressure

If there is positive inlet pressure, take the inlet pressure into consideration to ensure safe and energy-optimal operation. Ensure that the system maximum head and the inlet pressure do not exceed the PN rating for the system.

System selection

Select the system on the basis of these factors:

- maximum flow requirement
- required outlet pressure
- load profile
- number of pumps required
- possible standby pumps.

Accessories

When you have selected the optimum system, consider whether you require any of the accessories mentioned below.

Dry-running protection

Every system must be protected against dry running. The inlet conditions determine the type of dry-running protection:

- If the system draws water from a tank or a well, select a level switch or an electrode relay for dry-running protection.
- If the system has inlet pressure, select a pressure transmitter or a pressure switch for dry-running protection.

Pilot pump

If a pilot pump is selected, size it according to the size of the main pumps in the system. The flow of the pilot pump should not be less than 1/5 of the flow of a main pump at the desired setpoint.

Diaphragm tank

The need for a diaphragm tank is estimated on the basis of the following guidelines:

- Due to the stop function, all systems in buildings must be equipped with a diaphragm tank.
- In water supply applications, a diaphragm tank is usually not required, because miles of piping both provide the necessary capacity and have elasticity to offer sufficient capacity.



To avoid the risk of water hammer, a diaphragm tank may be necessary.

- Estimate the need for a diaphragm tank for the systems in industrial applications from situation to situation on the basis of the individual factors on site.



If the system includes pilot pumps, the diaphragm tank is to be sized according to the capacity of this pump.

The tank consists of a bladder usually made of rubber. The water is contained in the bladder and does not come in direct contact with air in the tank.

As the bladder fills with water, it expands into the pressurized air space in the tank. As system uses water, the bladder collapses until the water is almost emptied, activating the system, before the minimum pressure is reached.

The tank is pressurized at the factory, typically around 1.5 bar, but the pressure must be adjusted according to the setpoint using the air valve located near the top of the tank, with no system pressure at the tank inlet.

- In E-systems, 0.7 x setpoint.

For further information about optional equipment and accessories, see sections Optional equipment and Accessories.

Recommended tank size V_0 can be calculated from the following equations:

$$V_0 = \frac{K_Q \times Q \times (P_{set} + 1)^2 \times \left(\frac{3600}{N} - 10\right)}{3.6 \times (k_f \times P_{set} + 1) \times k_H \times P_{set}}$$

Symbol	Description
V_0	Tank volume
k_Q	The ratio between rated flow rate Q_{nom} of the smallest pump in the system and the flow rate Q_{min} at which the pump is changed to on/off operation $k_Q = Q_{min}/Q_{nom}$ It is only used in E-system with speed regulated pumps and can be set to 2-10 % depending on the pump size.
Q	Nominal flow rate of the smallest pump in the system
P_{set}	Setpoint of the system

Symbol	Description
k_H	The ratio between the on/off band ΔH and the setpoint P_{set} . $k_H = \Delta H/P_{set}$
k_f	The ratio between the tank precharge pressure P_0 and the setpoint P_{set} . $k_f = P_0/P_{set}$ 0.7 for Hydro MPC-E
N	Maximum number of starts/stops per hour which depends on the motor type or size and the application, in systems with E-motors it is allowed to have up to 200 times per hour. All prefabricated MPC-E/EC systems delivered with tanks are calculated based on this value.

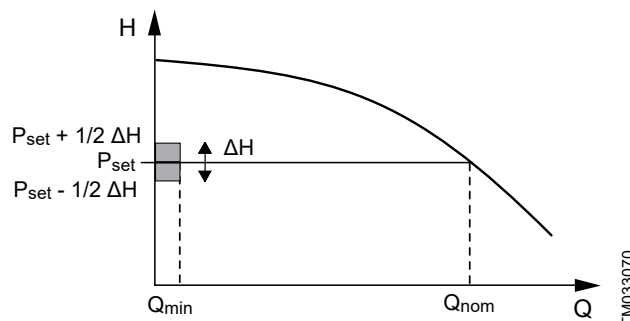

The tank values are based on the following data:

Symbol	Hydro MPC-E/EC
Q	Q_{nom} of one pump
k_Q	10 %
P_{set}	58 psi (4 bar)
k_H	20 %
k_f	0.7

Example of Hydro MPC-E with CRE 10

Symbol	Hydro MPC-E
Q [gpm (m ³ /h)]	44 (10)
k_Q	10 %
k_H	20 %
P_{set} [psi (bar)]	58 (4)
N [h ⁻¹]	200
Result	
V_0 [gallons (liter)]	4.83 (18)
Selected tank [gallon (liter)]	4.4 or 10.3 (16.65 or 38.61)
ΔH [psi (bar)]	11.6 (0.8)
P_0 [psi (bar)]	40.6 (2.8)

For further information, see the document Tank calculation in E systems in section Product manuals.

Related information

12. [Optional equipment](#)
13. [Accessories](#)
14. [Product manuals](#)

Example: How to select a system

- A flow rate of 67.5 m³/h is required.
- A head of 73 metres is required.

Draw a vertical line from the required flow rate.

Draw a horizontal line from the required head.

The intersection of the two lines gives the number of pumps required for the system (three CRE, CRIE 20-7).

The pump type best meeting this specification can be determined using the y-axis, for instance, three CRE, CRIE 20-7.

Select only systems with performance ranges within the hatched area in the example.

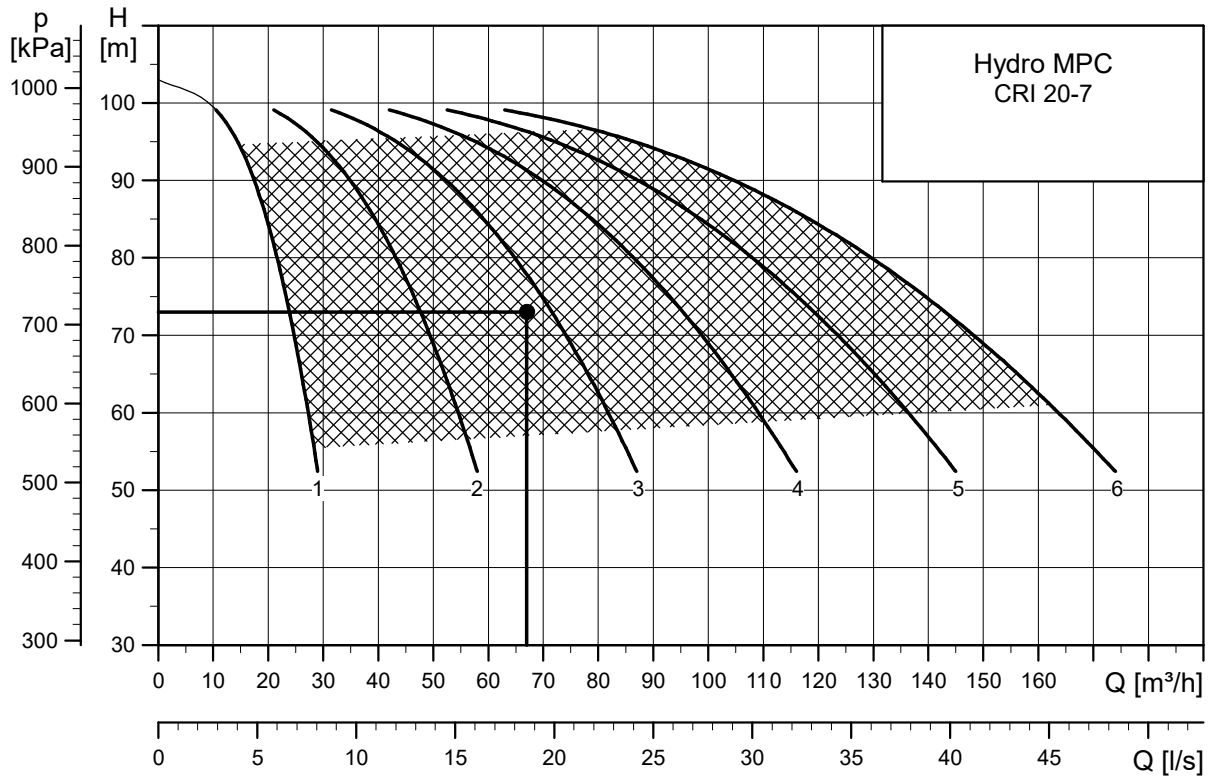

TM063297

7. Curve conditions

How to read the performance curve

The guidelines below apply to the curves on the following pages:

- Measurements are made with airless water at a temperature of 20 °C (68 °F).
- The curves apply to a kinematic viscosity: $\nu = 1 \text{ mm}^2/\text{s}$ (1 cSt).
- The QH curves apply to fixed speeds of 2900 RPM at 50 Hz and 3480 RPM at 60 Hz.



In most cases, the actual speed deviates from the above-mentioned speeds. For actual curves, refer to Grundfos Product Center where the pump curves include the characteristics of the selected motor and therefore show curves at actual speeds. In Grundfos Product Center, you can also adjust the curves depending on the density and viscosity.

- The conversion between head H [m] ([ft]) and pressure P [kPa] ([psi]) applies to a specific weight equal to 8.3 lb/gal, water density of $\rho = 1000 \text{ kg/m}^3$.

8. Curve charts, Hydro MPC-E, 60 Hz

Hydro MPC-E with CR, CRE 3

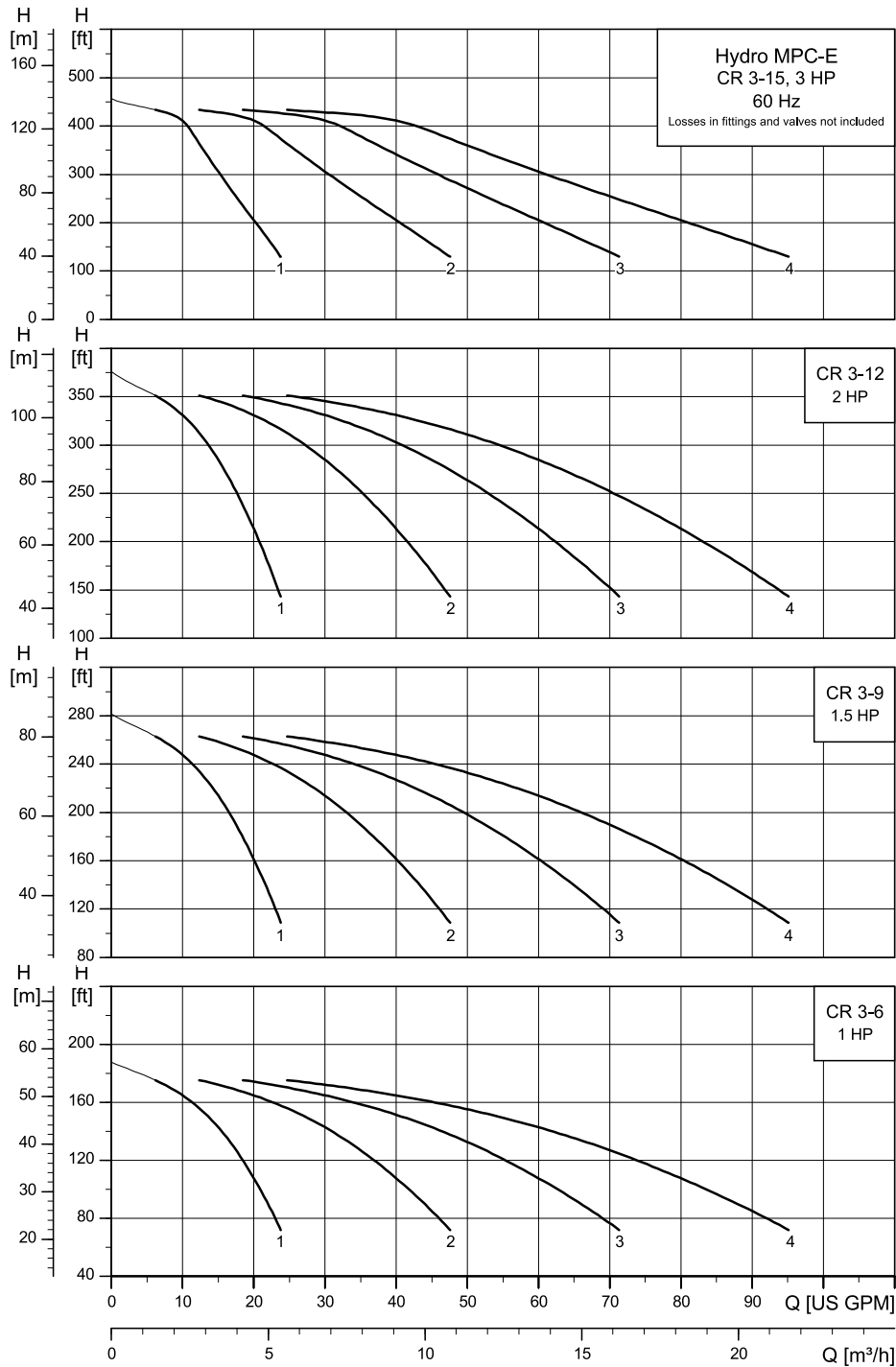

Irrespective of the input frequency, the 100 % speed of pumps is approximately 3480 min⁻¹.

TM073108

Hydro MPC-E with CR, CRE 5

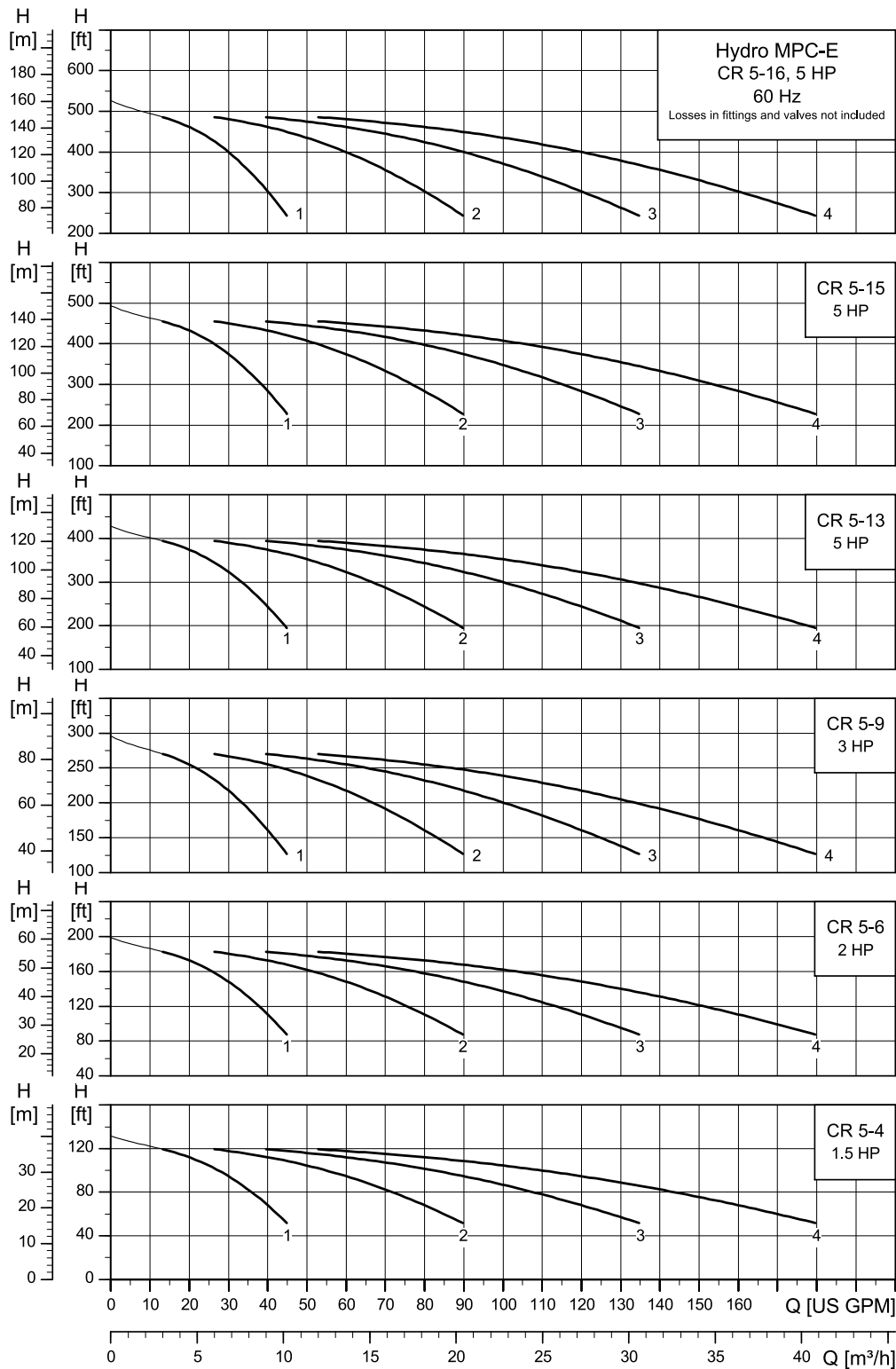

TM073109

Irrespective of the input frequency, the 100 % speed of pumps is approximately 3480 min⁻¹.

Hydro MPC-E with CR, CRE 10

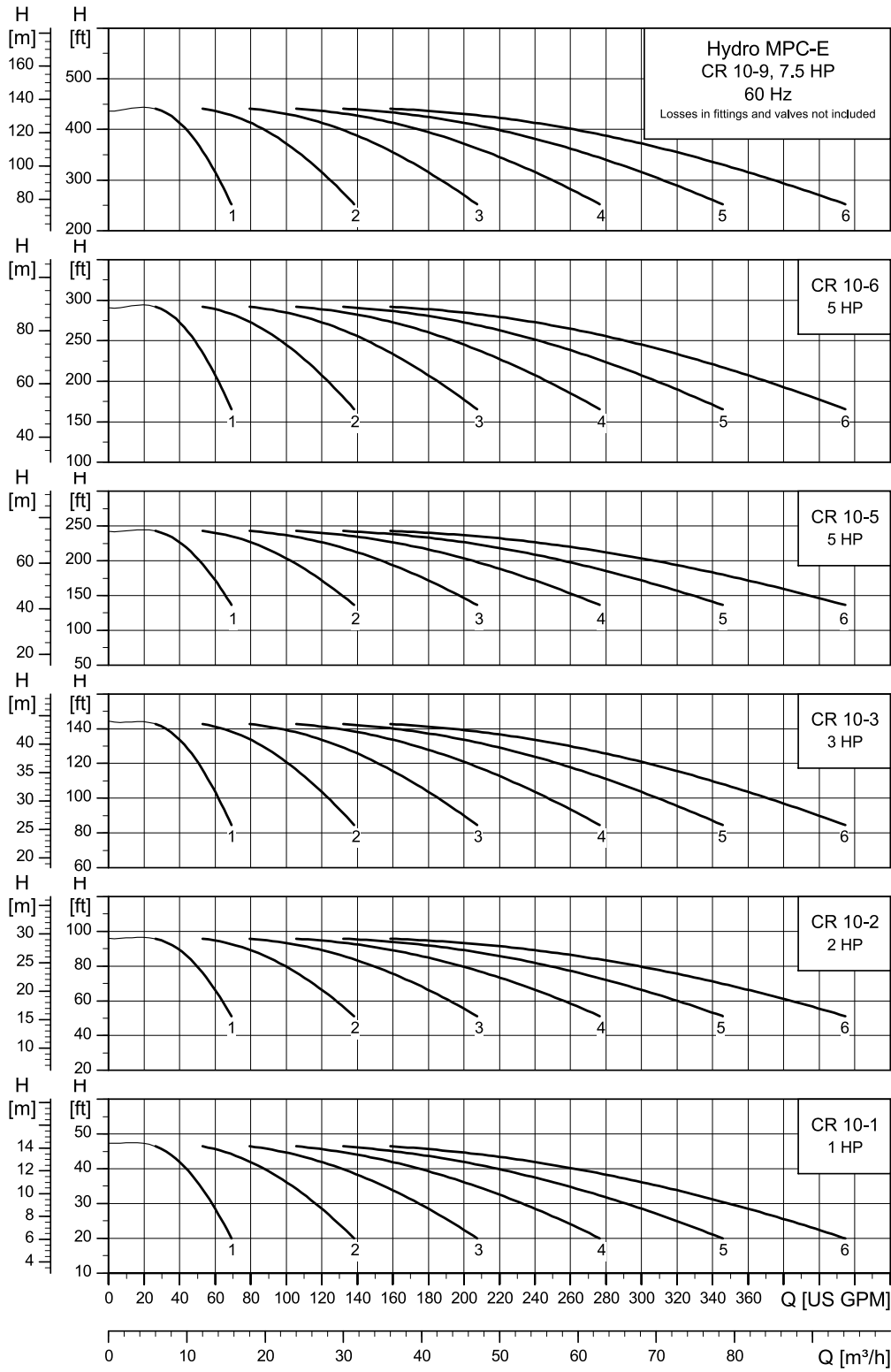

Irrespective of the input frequency, the 100 % speed of pumps is approximately 3480 min⁻¹.

TM073110

Hydro MPC-E with CR, CRE 15

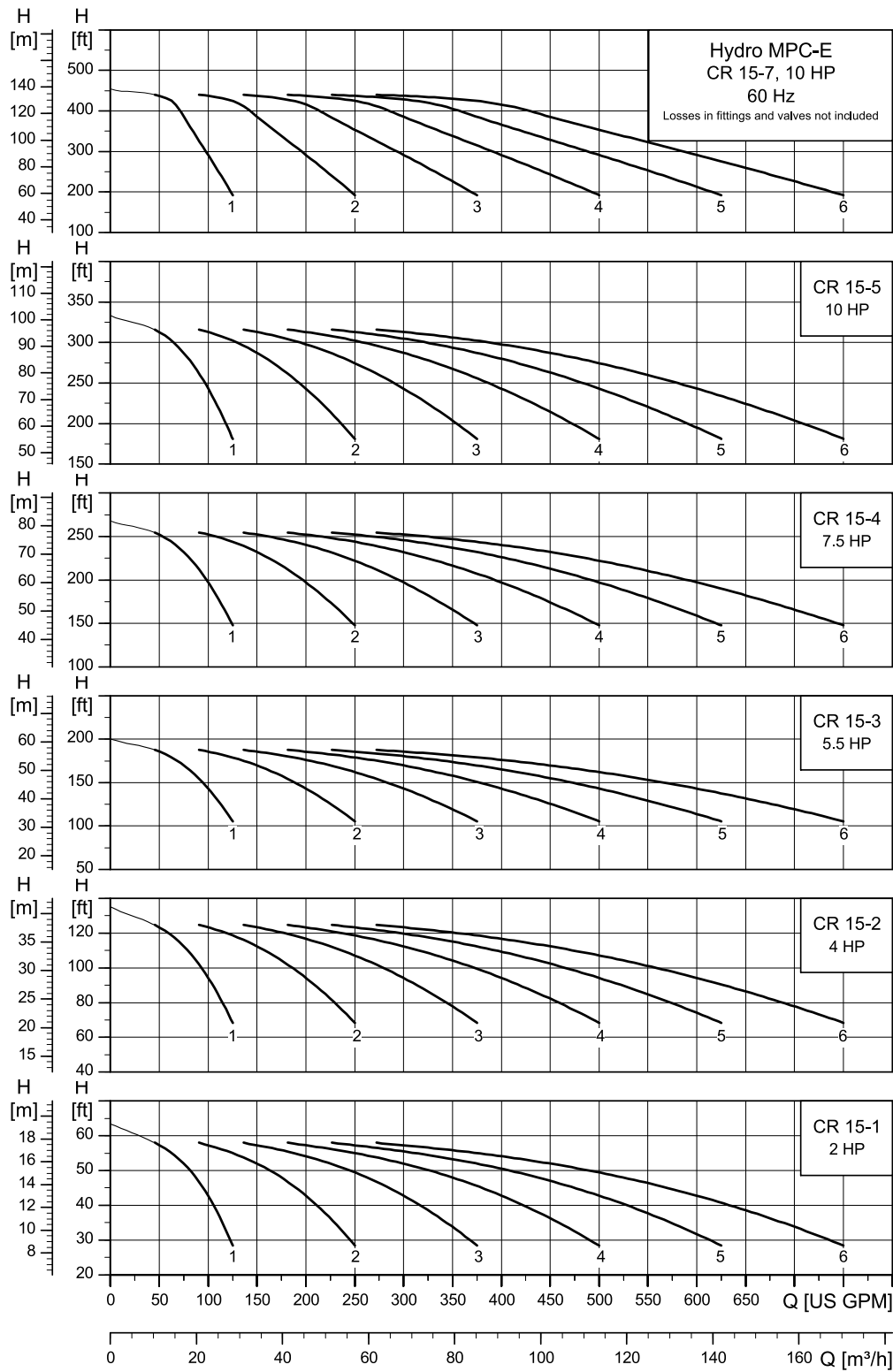

TM073111

Irrespective of the input frequency, the 100 % speed of pumps is approximately 3480 min⁻¹.

Hydro MPC-E with CR, CRE 20

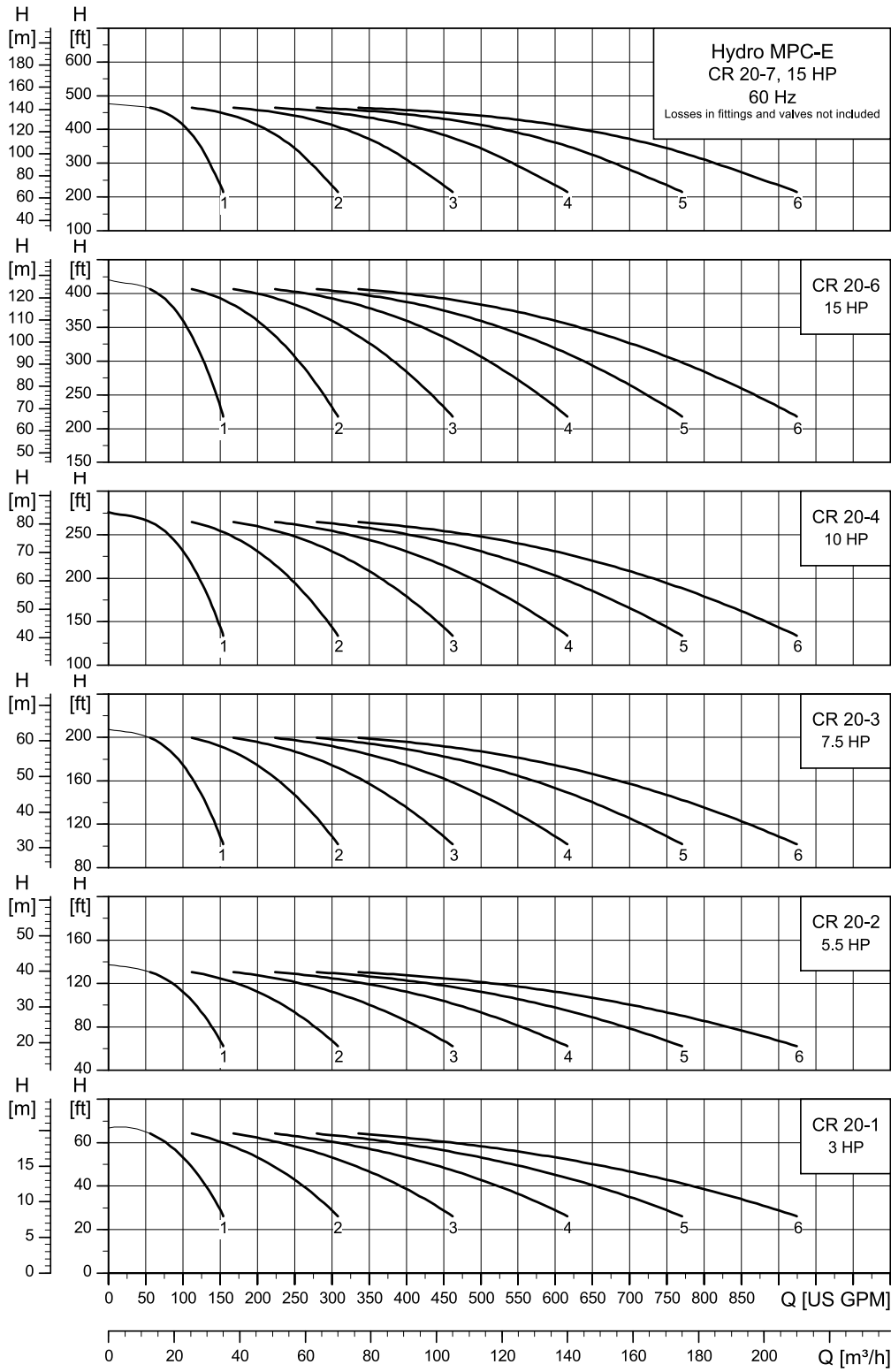

TM073112

Irrespective of the input frequency, the 100 % speed of pumps is approximately 3480 min⁻¹.

Hydro MPC-E with CR, CRE 32

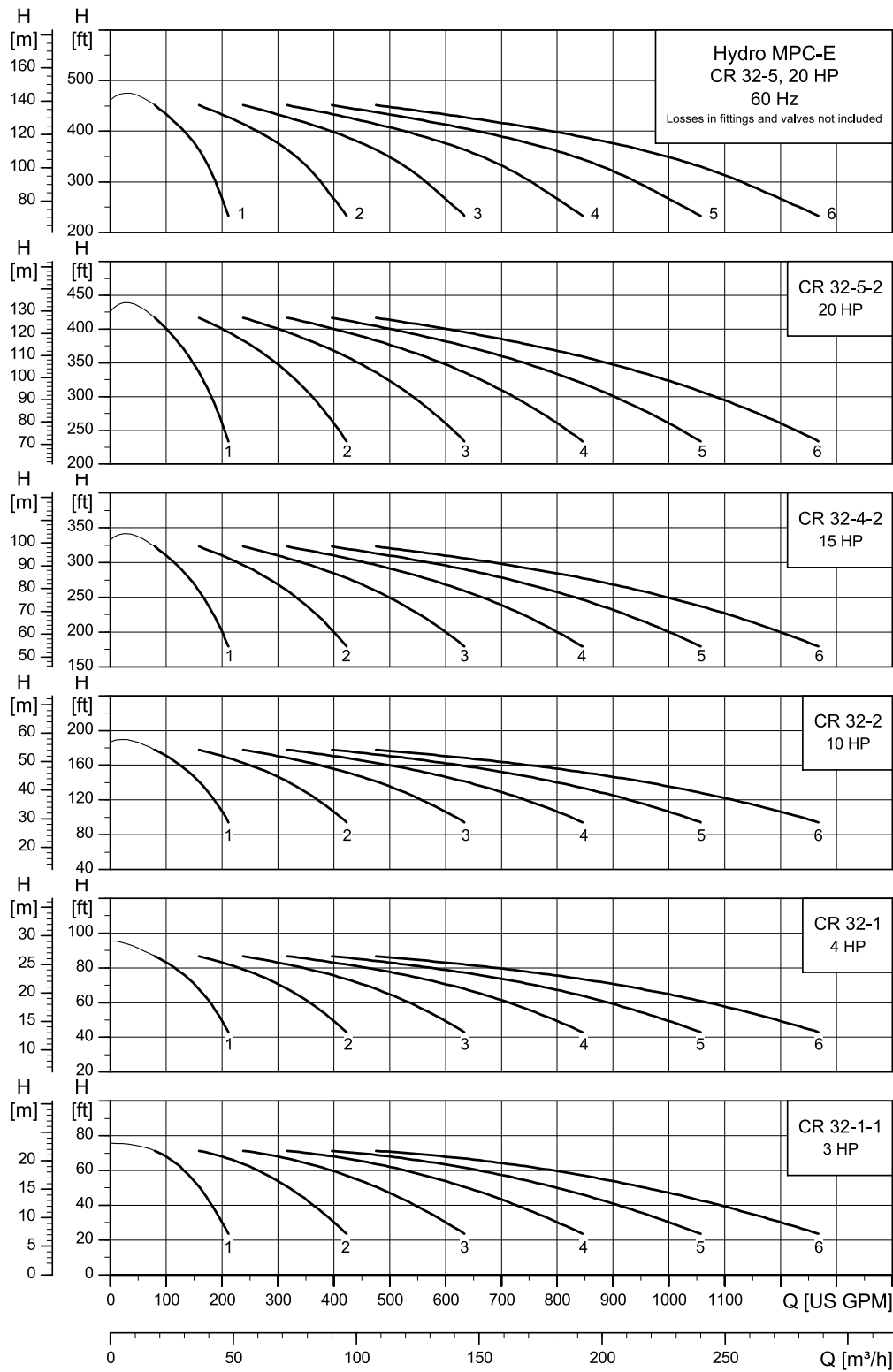

TM073113

Irrespective of the input frequency, the 100 % speed of pumps is approximately 3480 min⁻¹.

Hydro MPC-E with CR, CRE 45

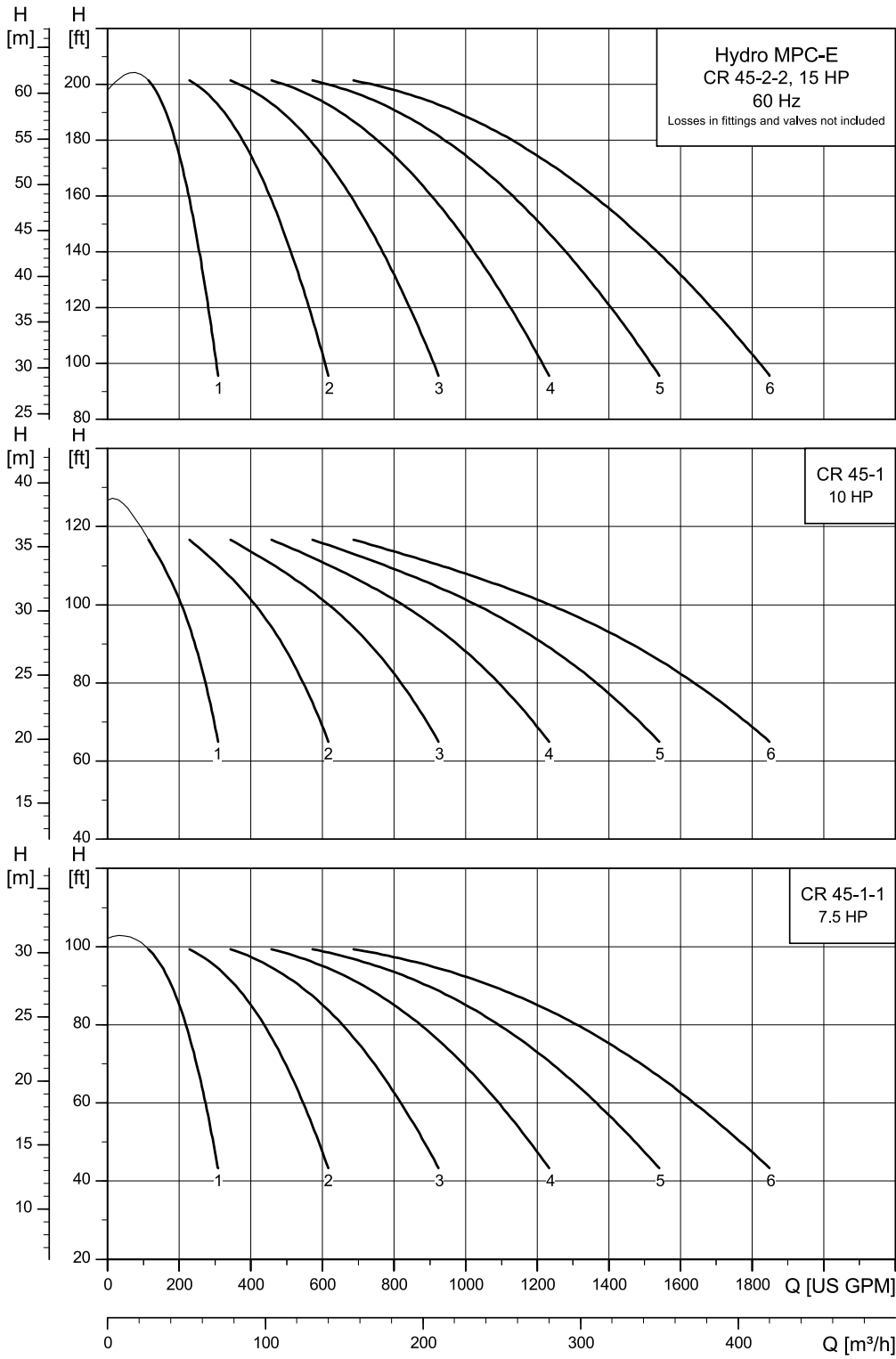

TM073114

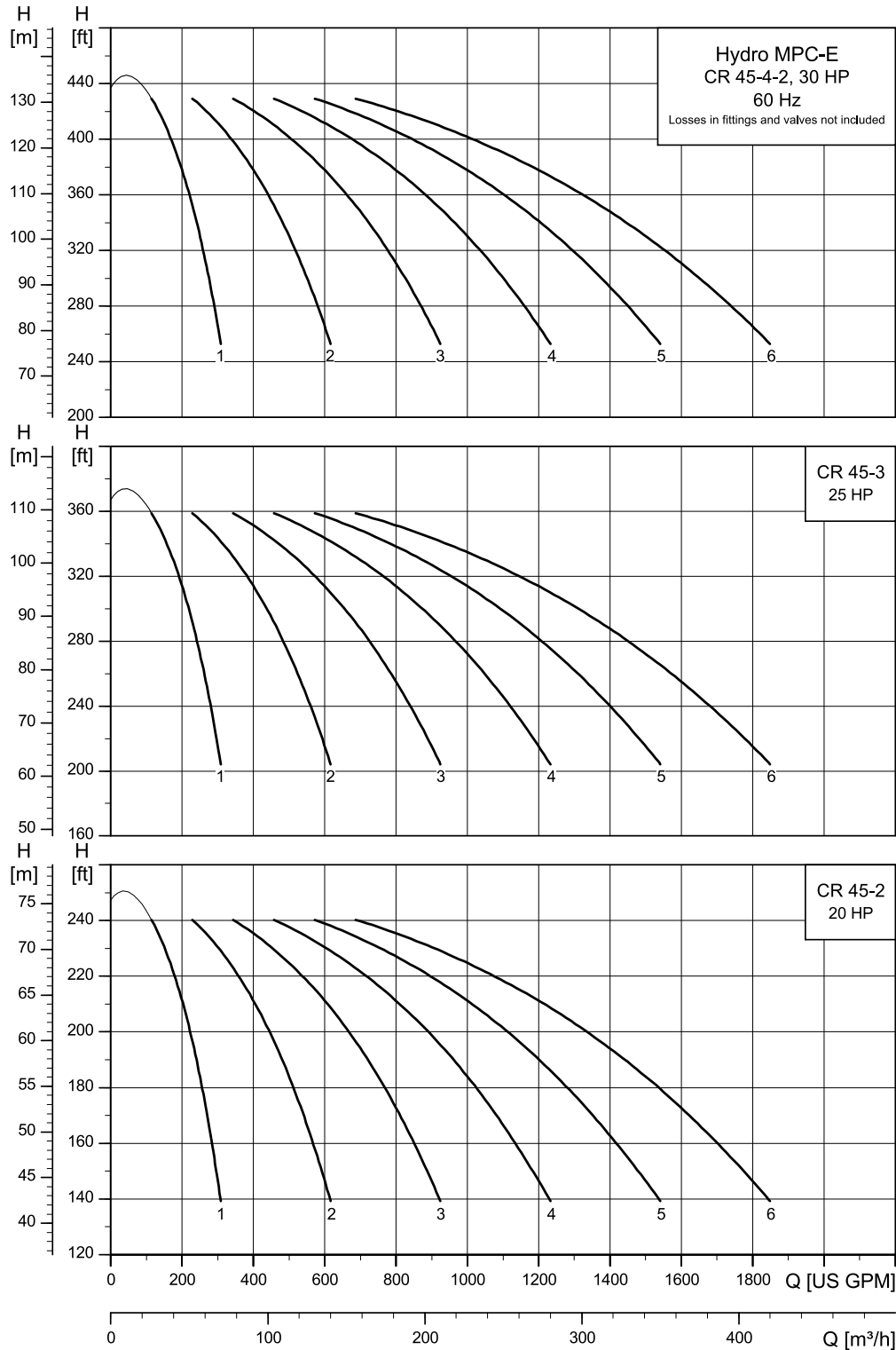

TM073115

Irrespective of the input frequency, the 100 % speed of pumps is approximately 3480 min⁻¹.

Hydro MPC-E with CR, CRE 64

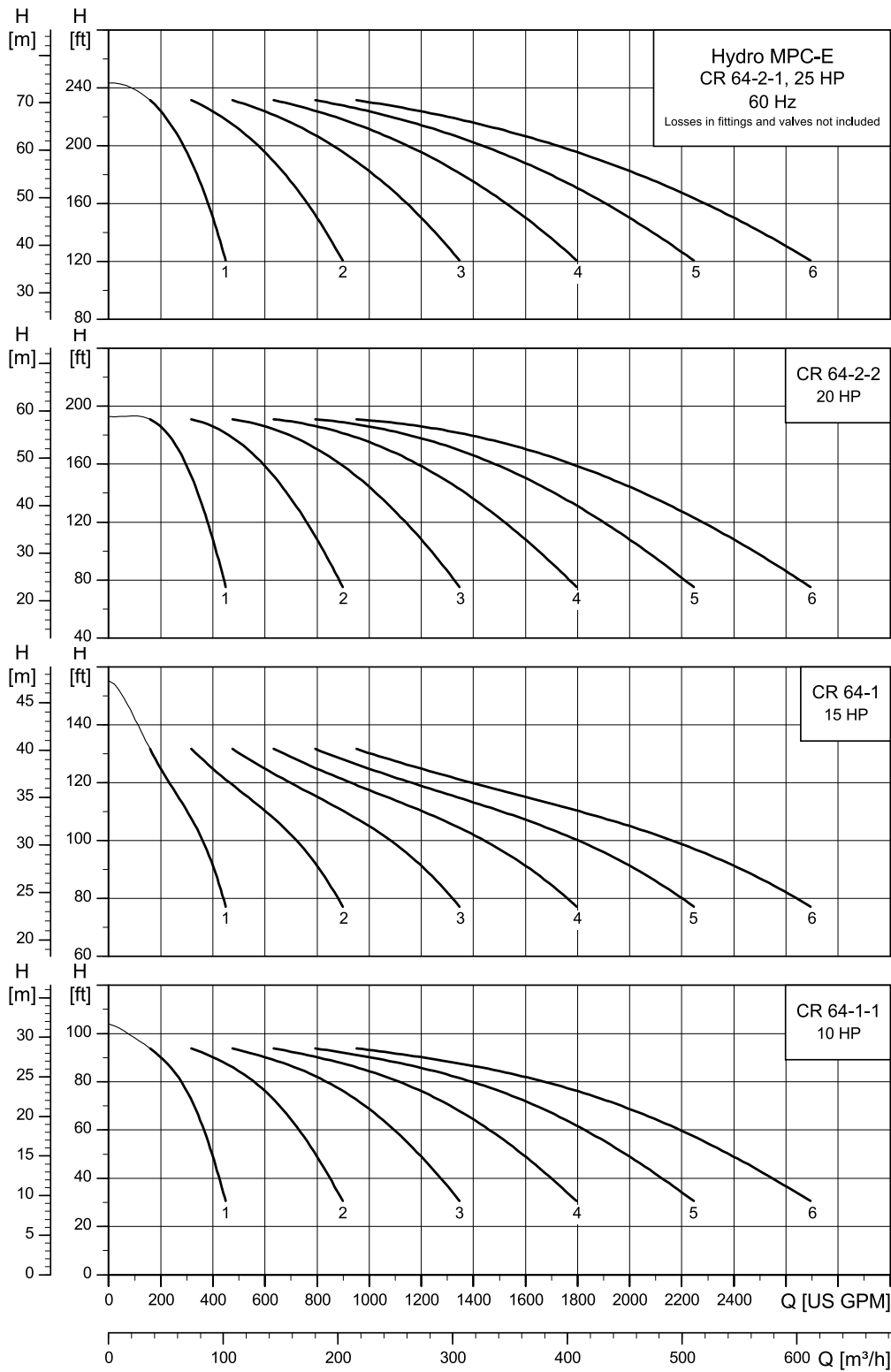

TM073116

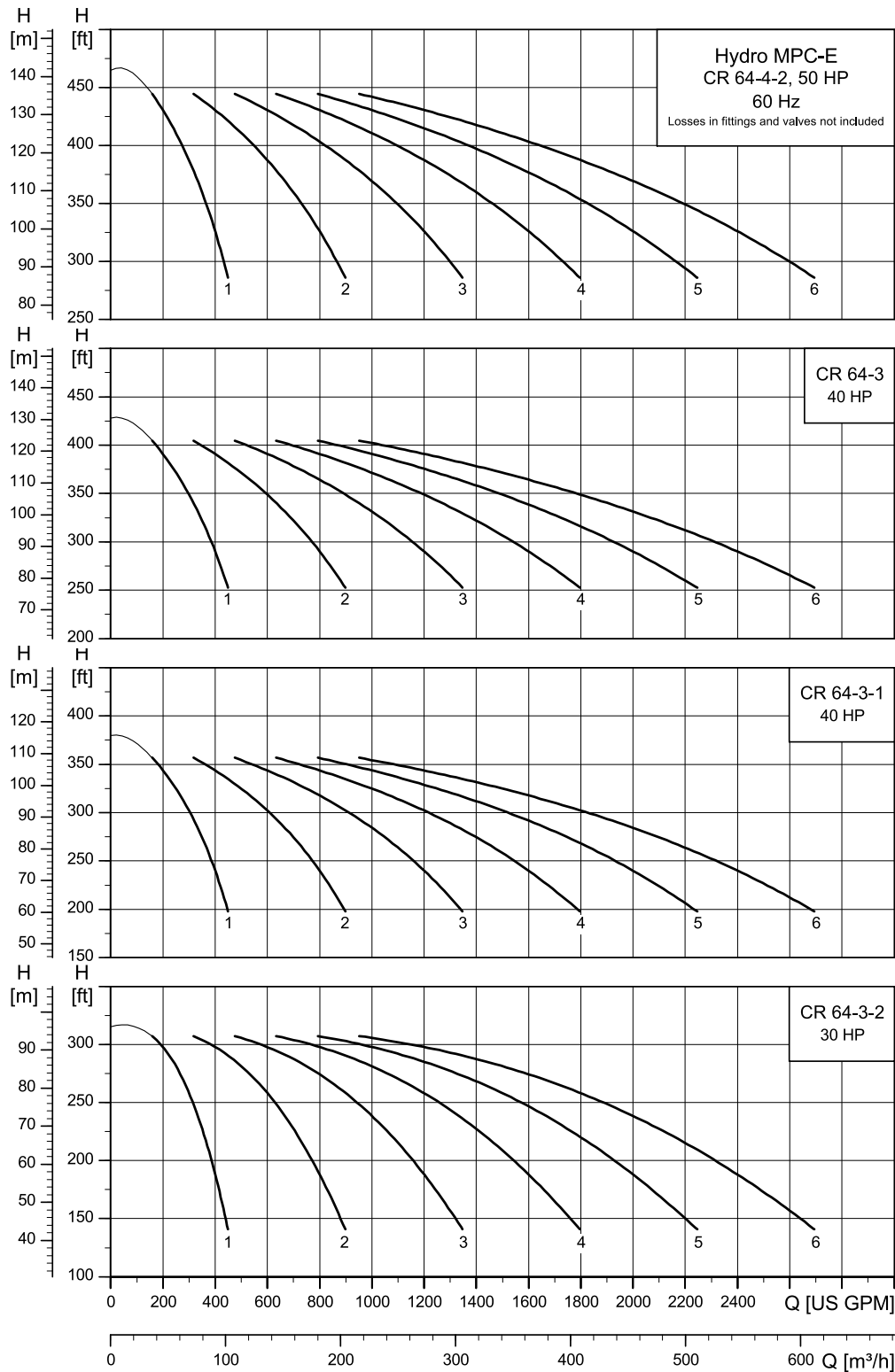

TM073117

Irrespective of the input frequency, the 100 % speed of pumps is approximately 3480 min⁻¹.

Hydro MPC-E with CR, CRE 95

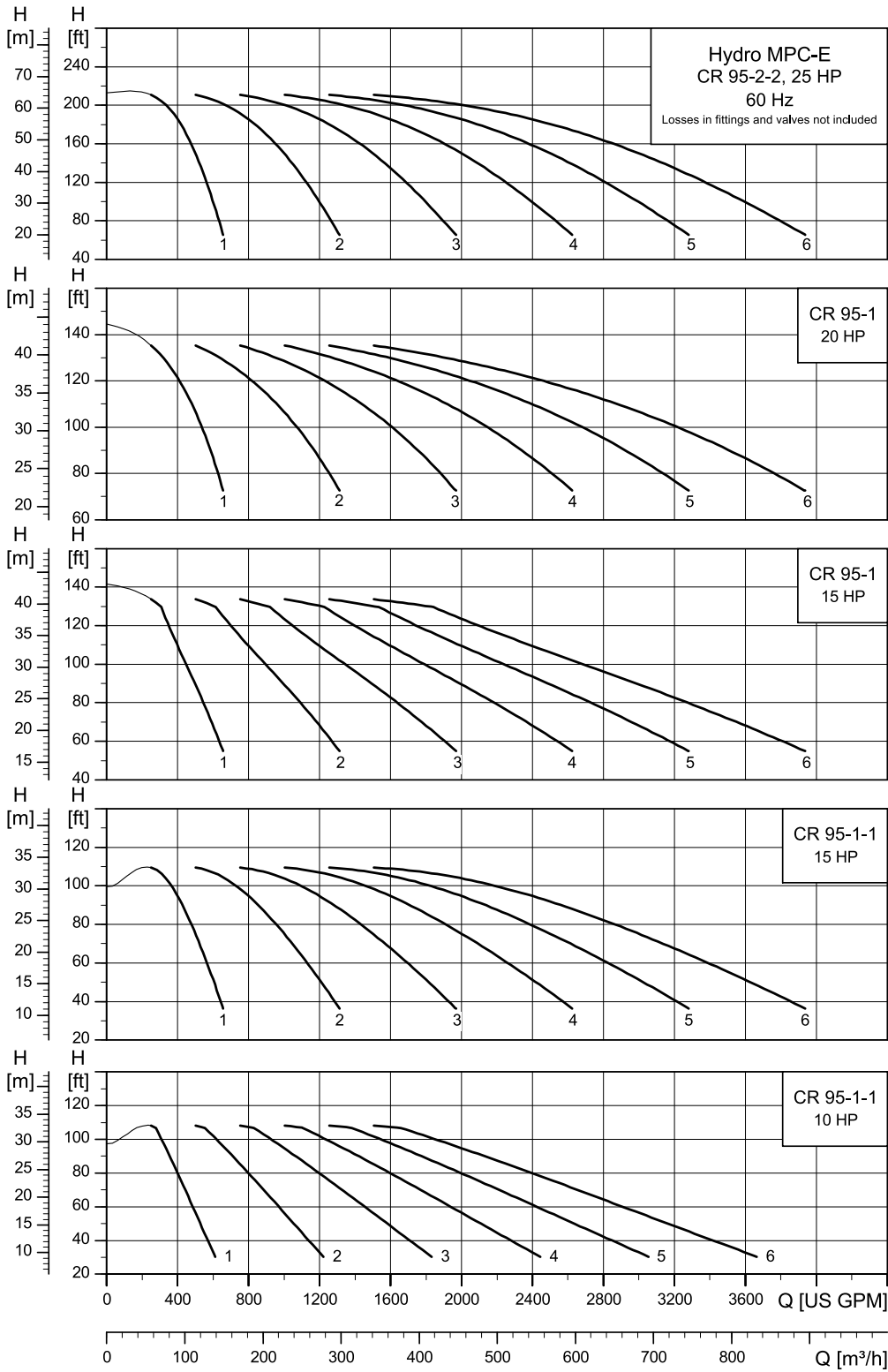

TM073118

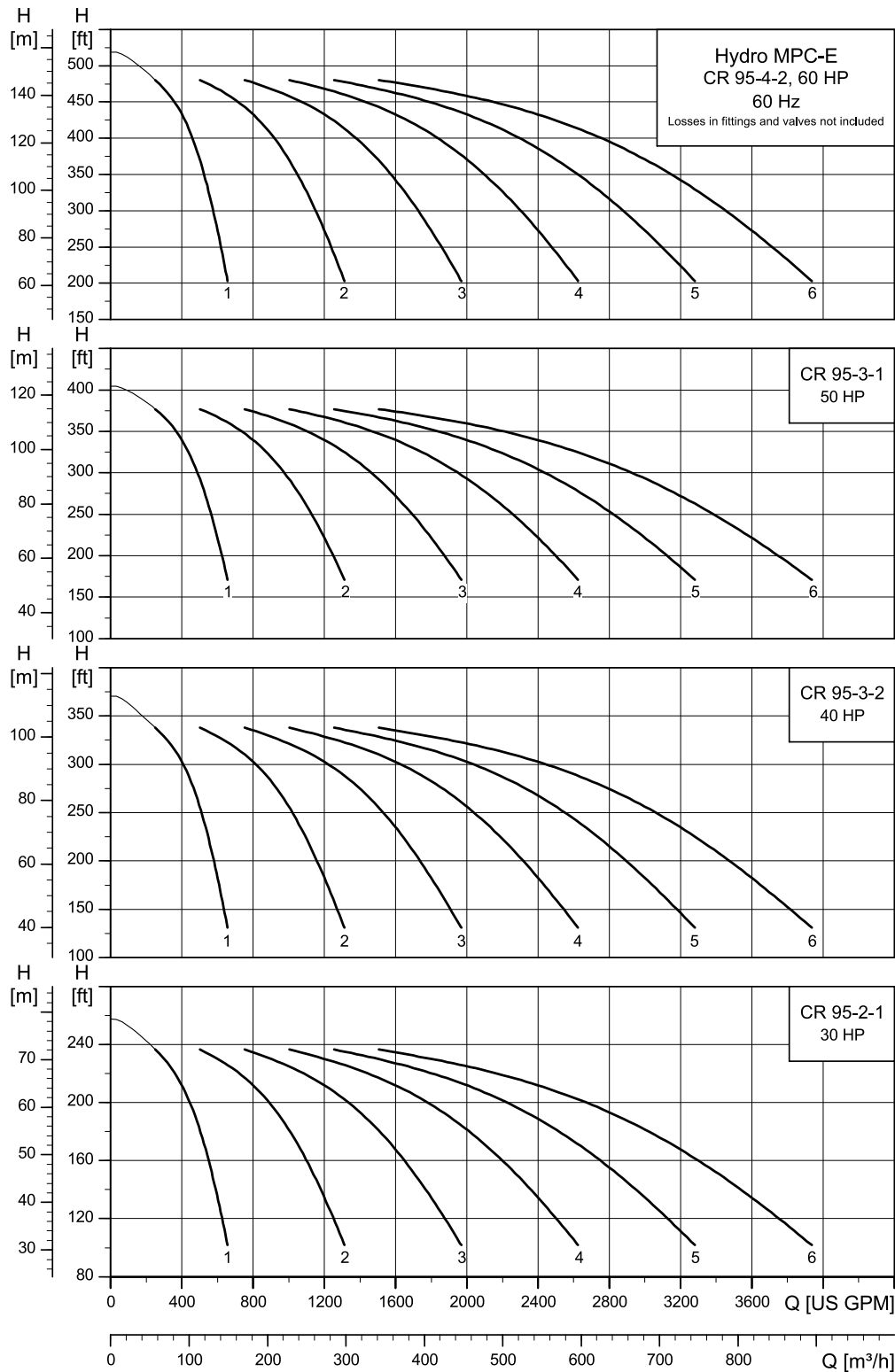

TM073119

Irrespective of the input frequency, the 100 % speed of pumps is approximately 3480 min⁻¹.

Hydro MPC-E with CR, CRE 125

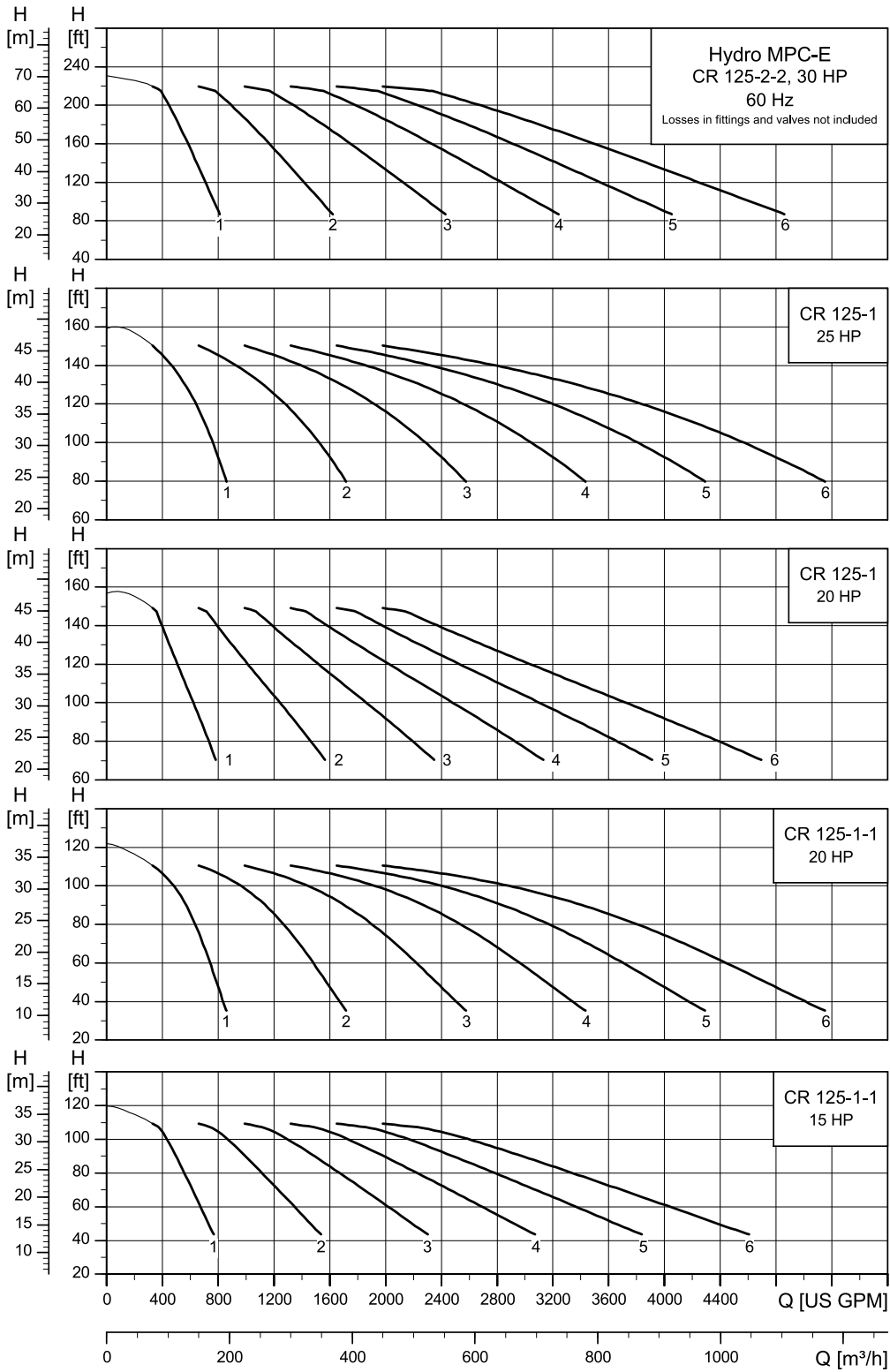

TM073120

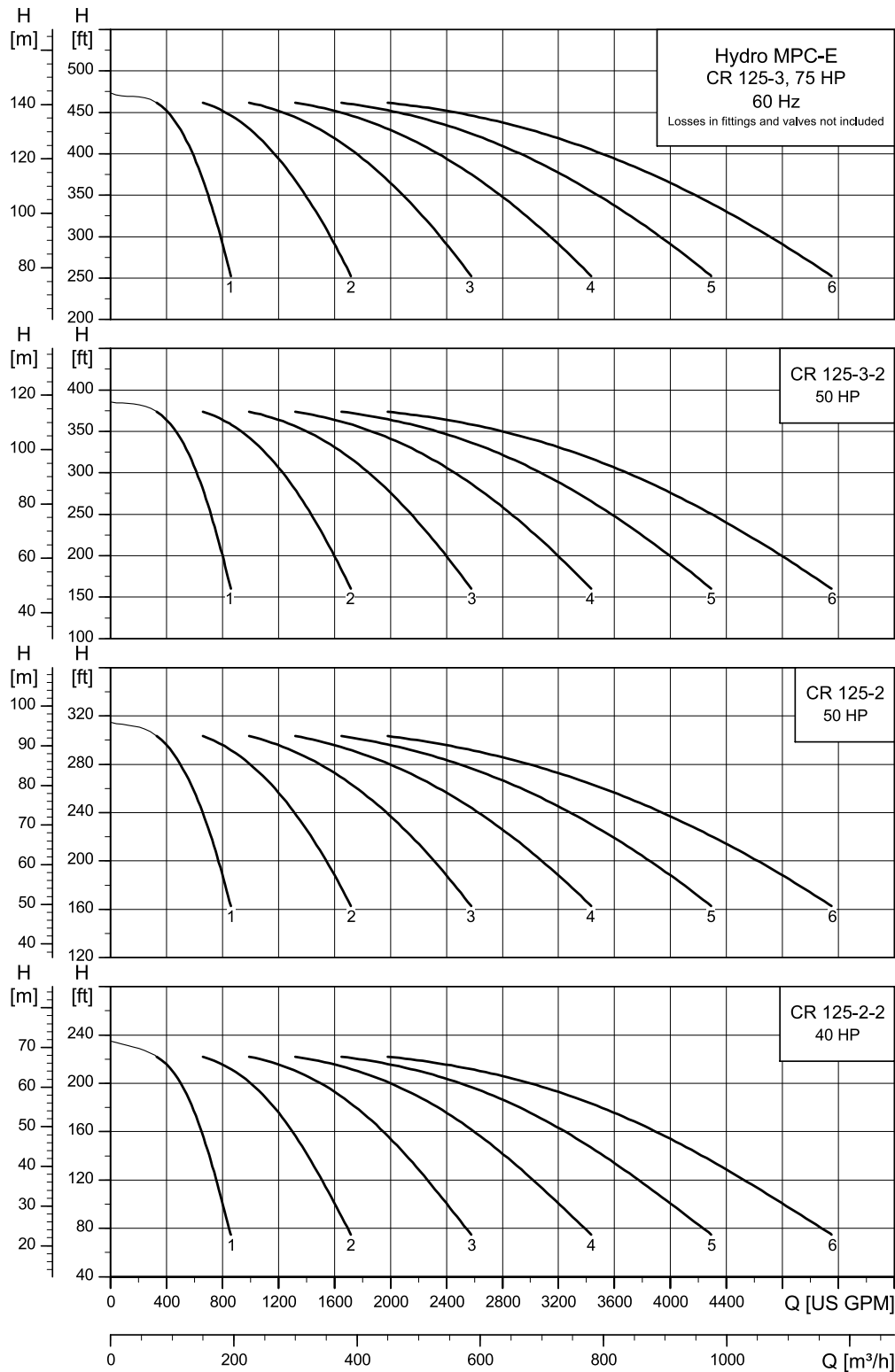

TM073121

Irrespective of the input frequency, the 100 % speed of pumps is approximately 3480 min⁻¹.

Hydro MPC-E with CR, CRE 155

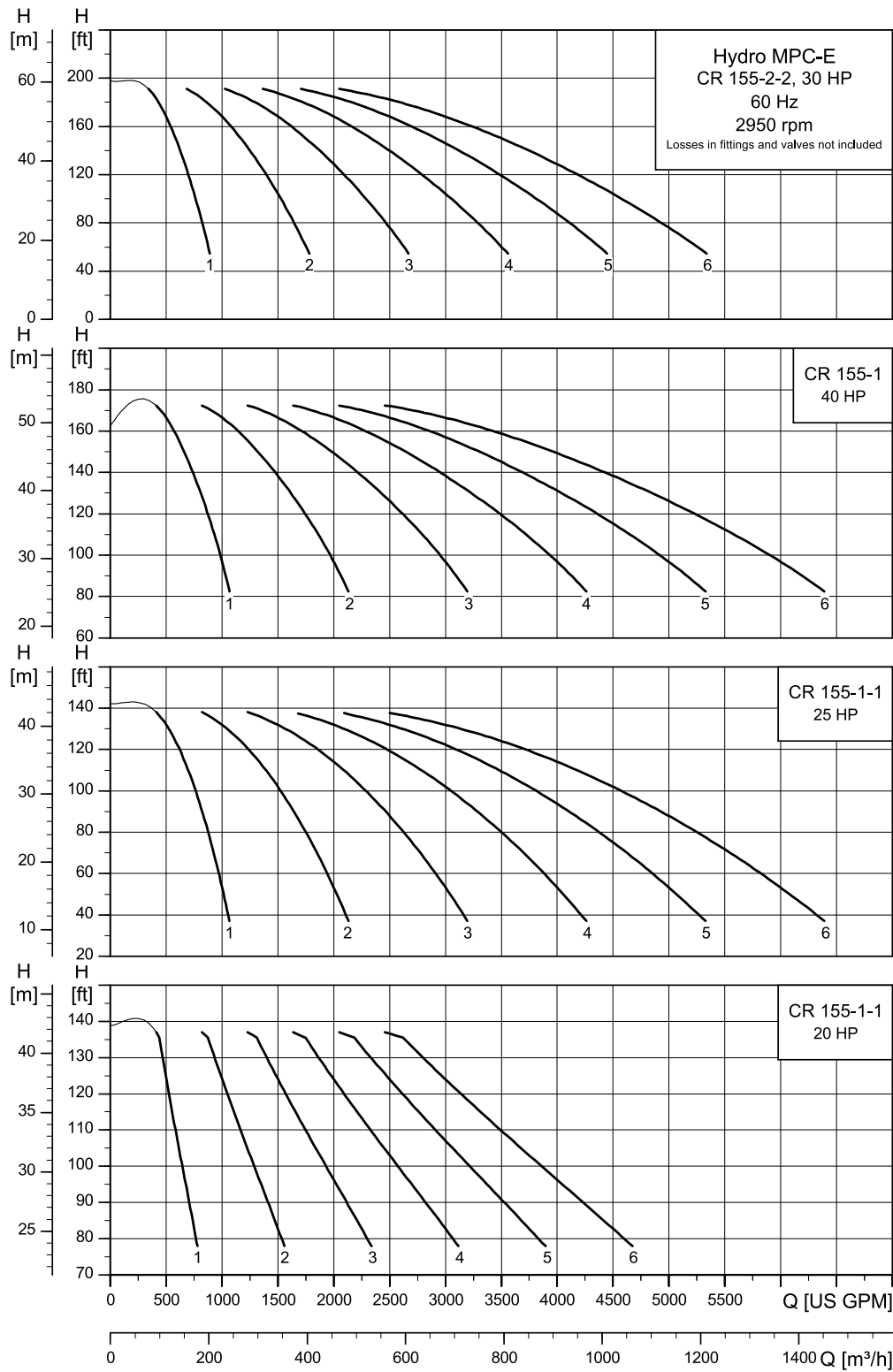

TM073122

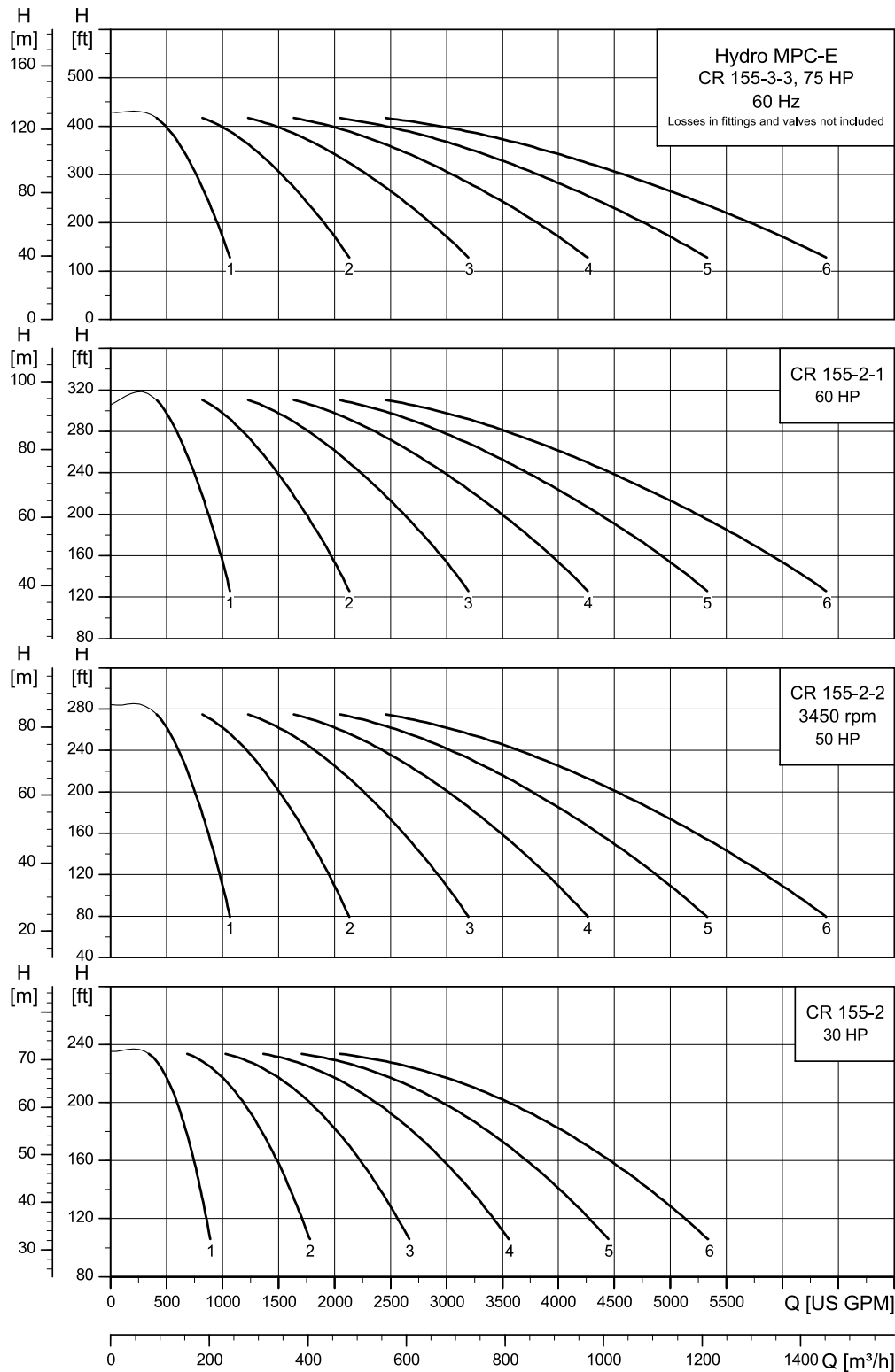

TM073123

Irrespective of the input frequency, the 100 % speed of pumps is approximately 3480 min⁻¹.

Hydro MPC-E with CR 185

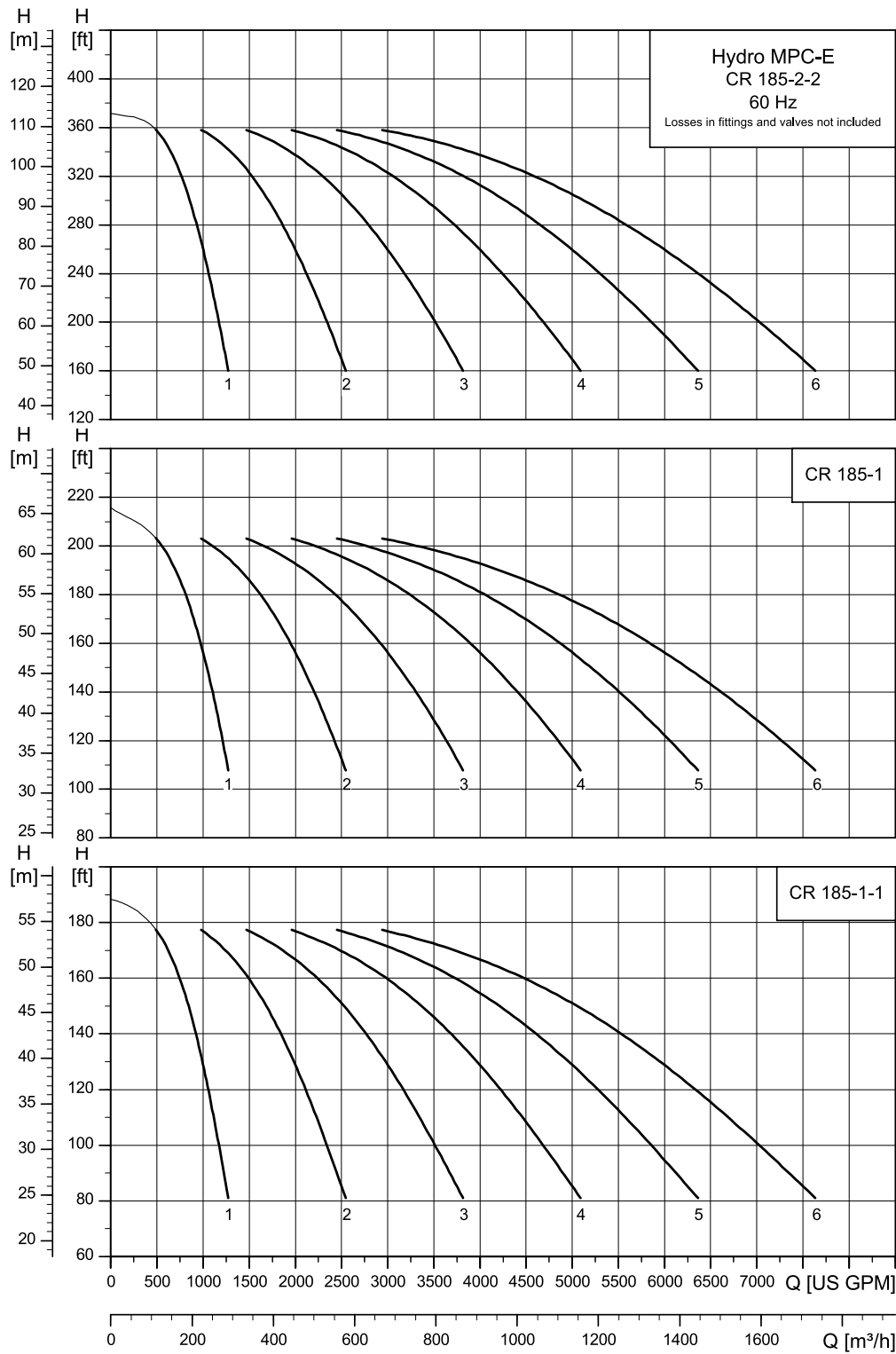

TM086617

Irrespective of the input frequency, the 100 % speed of pumps is approximately 3480 min⁻¹.

Hydro MPC-E with CR 215

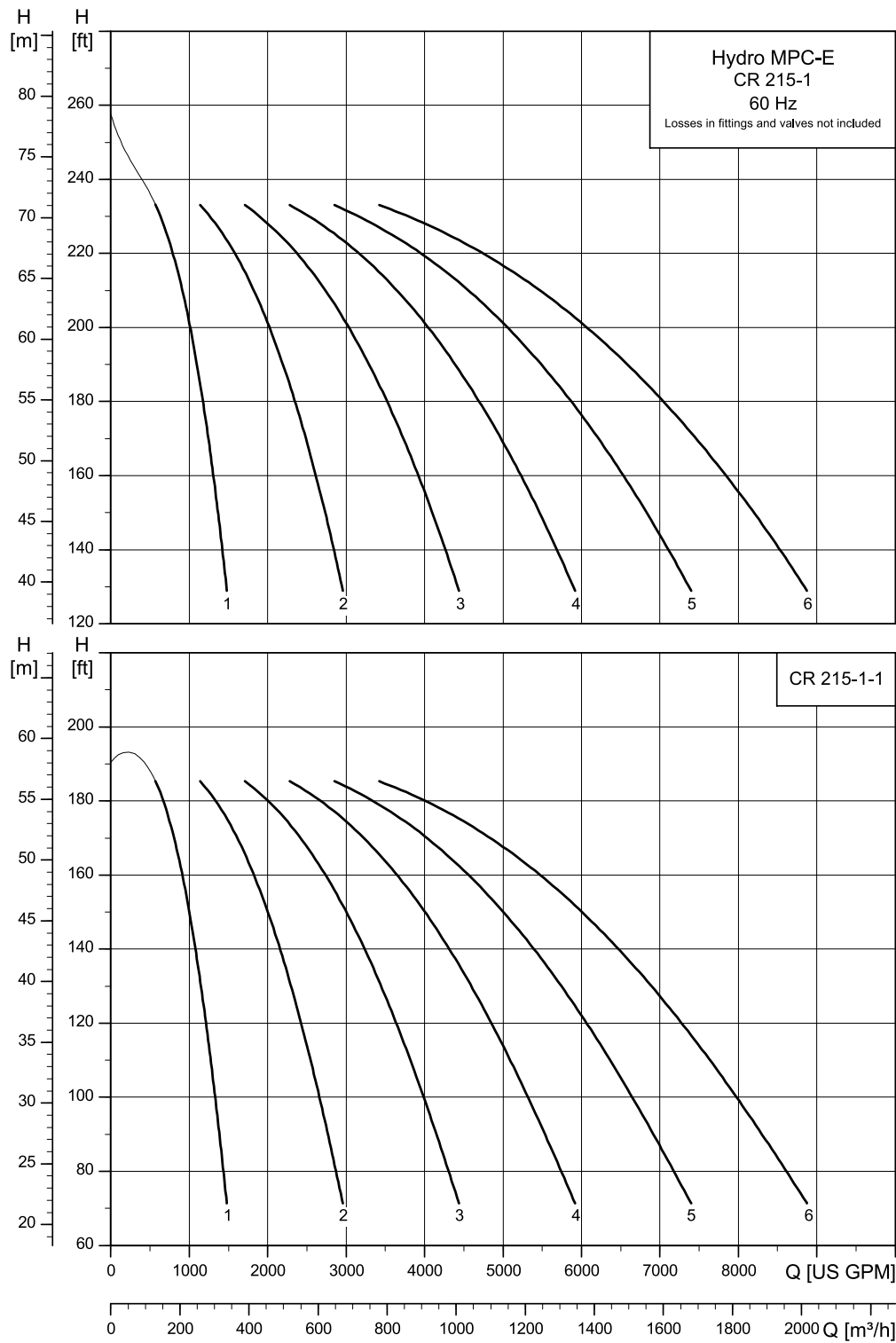

TM086618

Irrespective of the input frequency, the 100 % speed of pumps is approximately 3480 min^{-1} .

Hydro MPC-E with CR 255

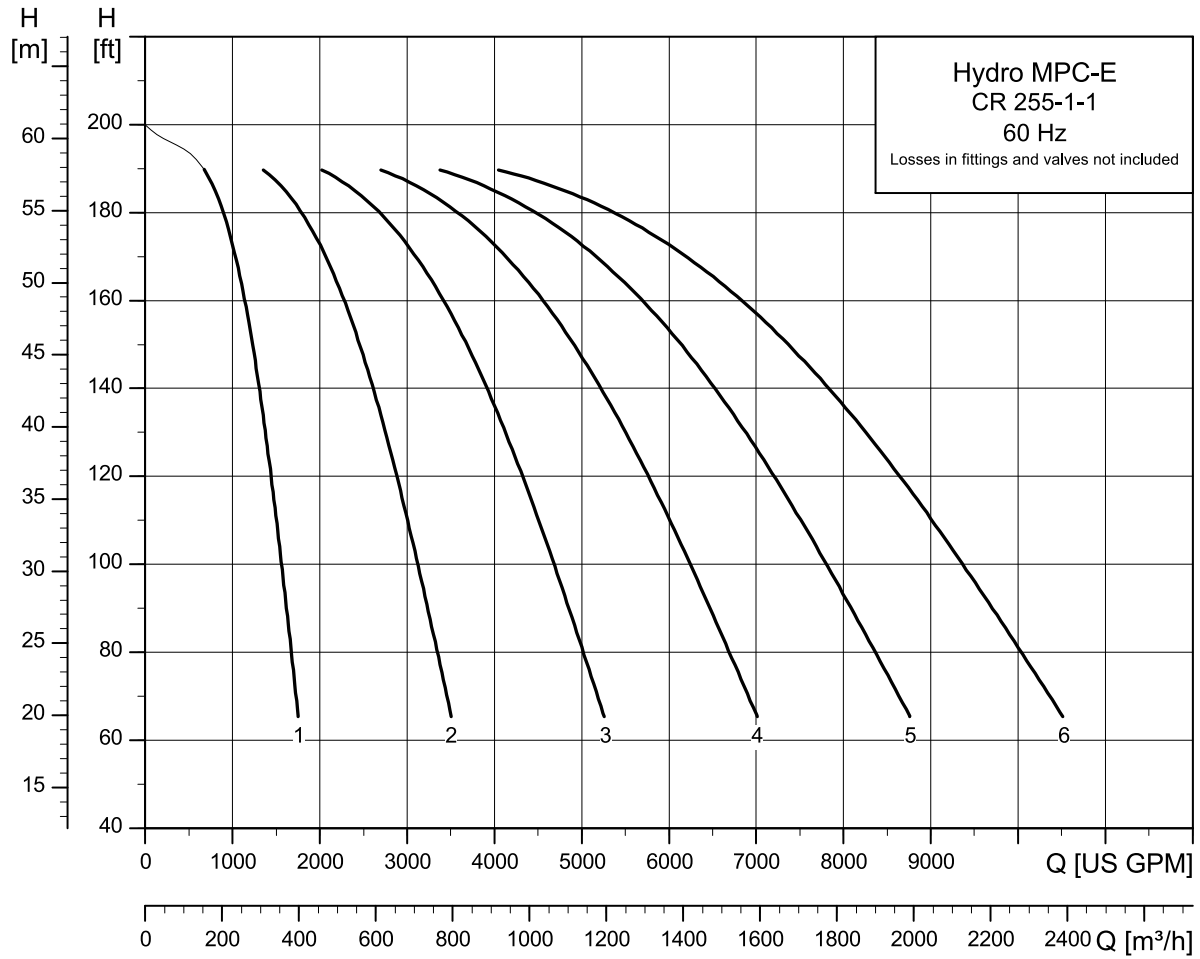

TM066619

Irrespective of the input frequency, the 100 % speed of pumps is approximately 3480 min⁻¹.

9. Curve charts, Hydro MPC CME, 60 Hz

Hydro MPC with CME 3

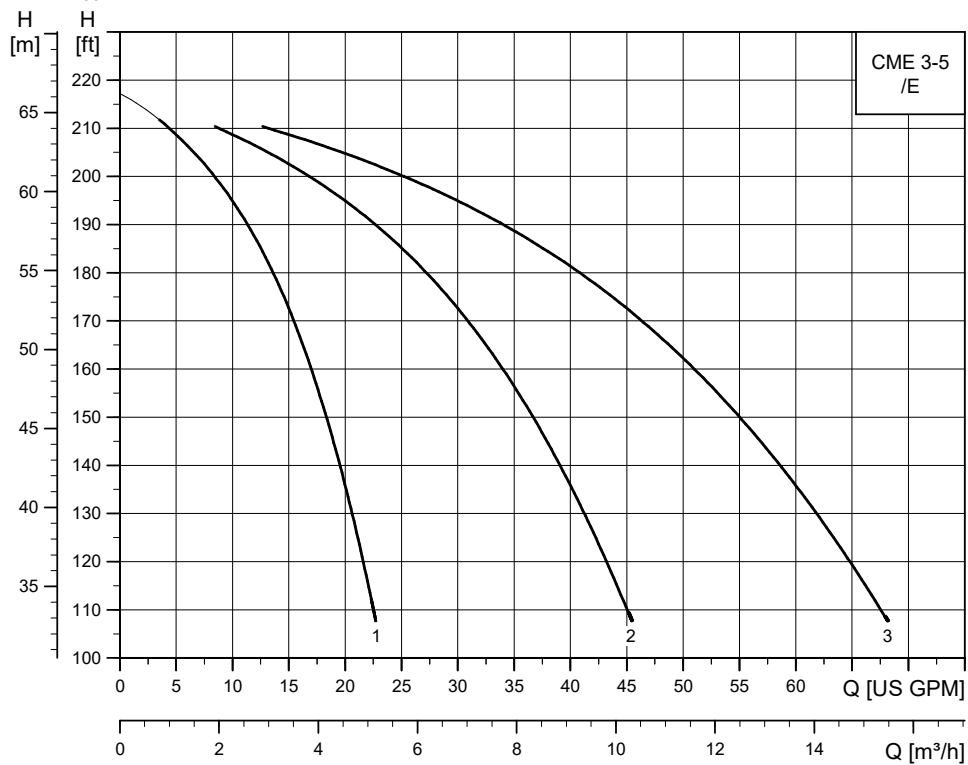
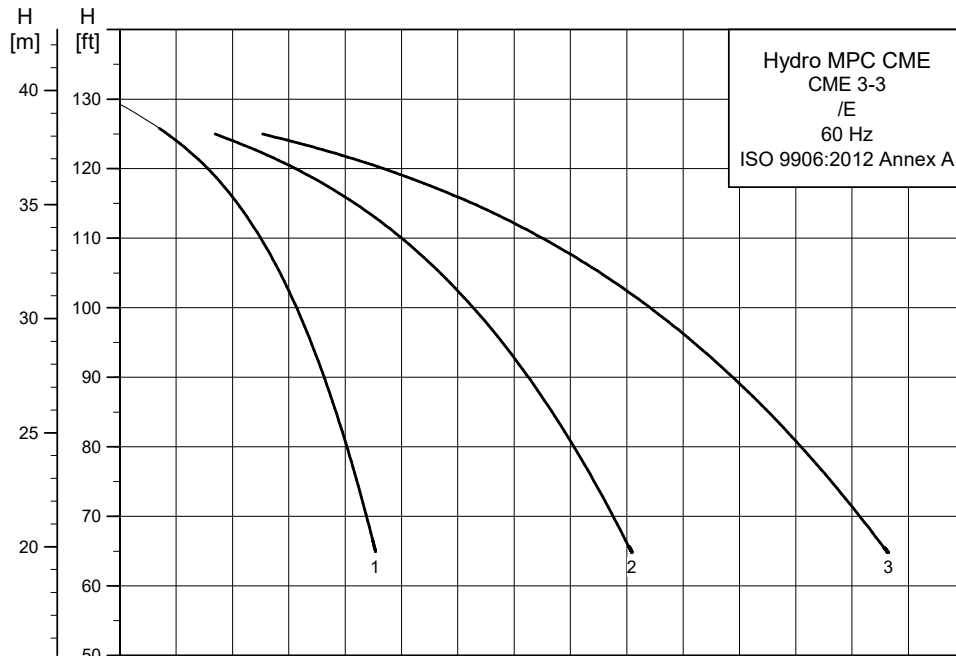

TM074908

Hydro MPC with CME 5

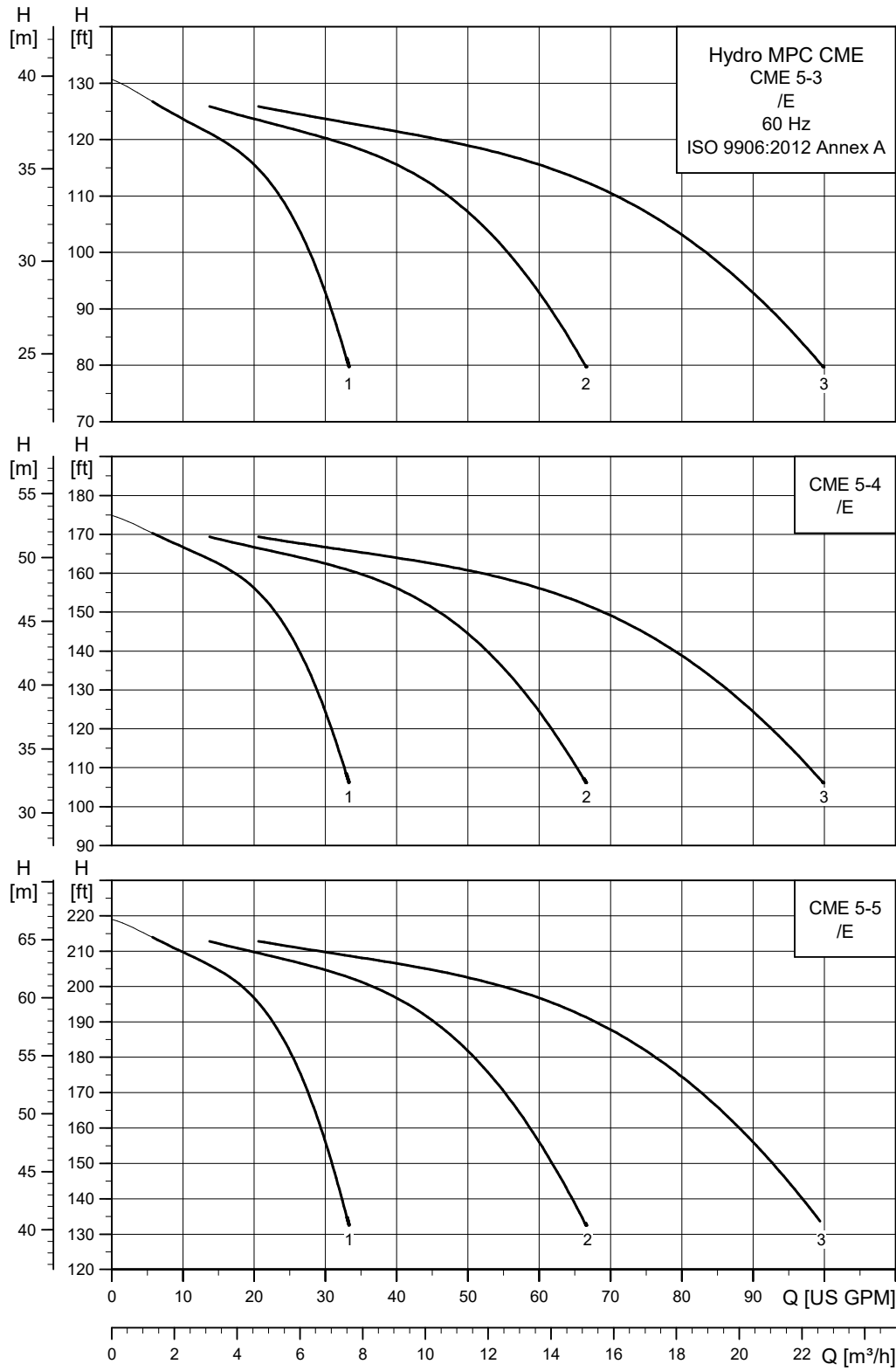

TM074909

Hydro MPC with CME 10

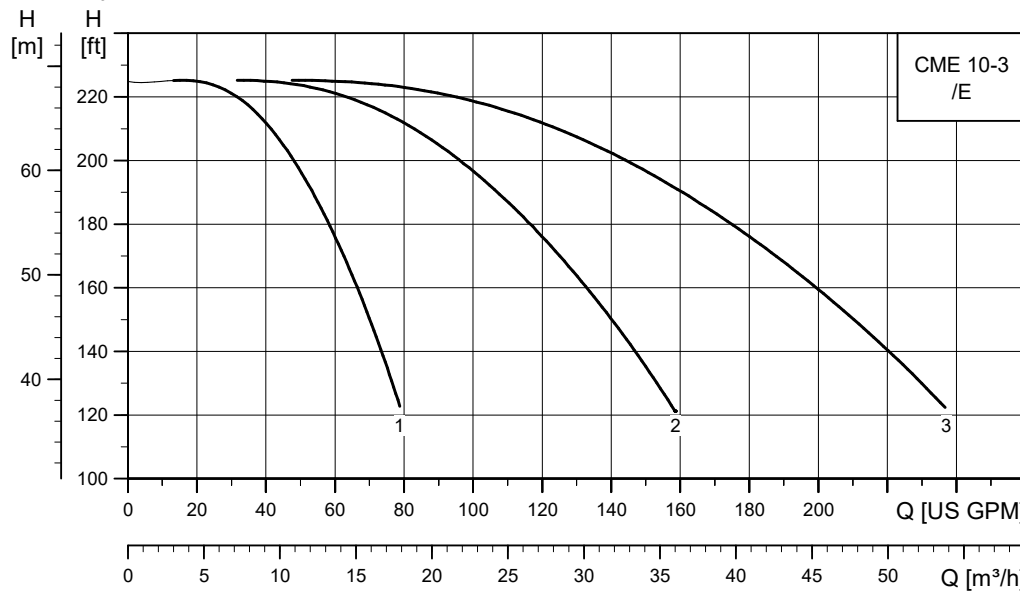
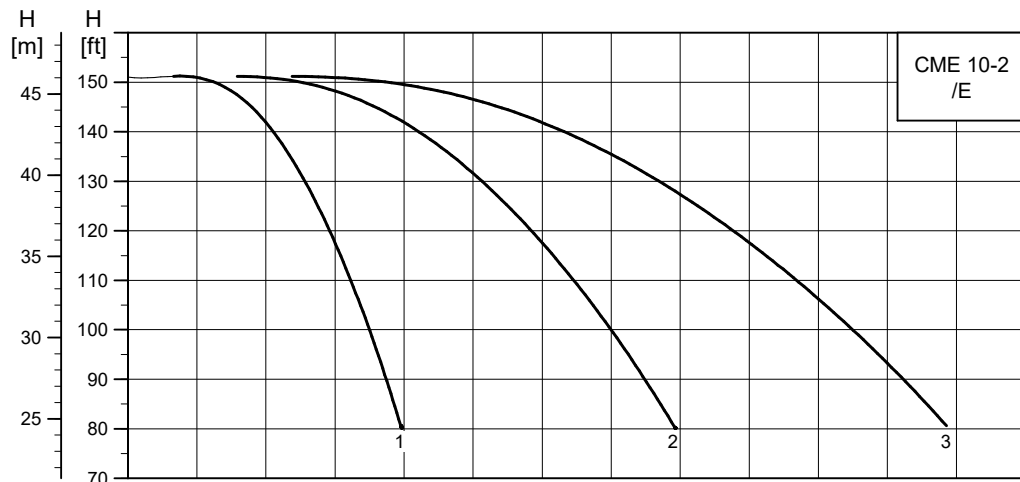
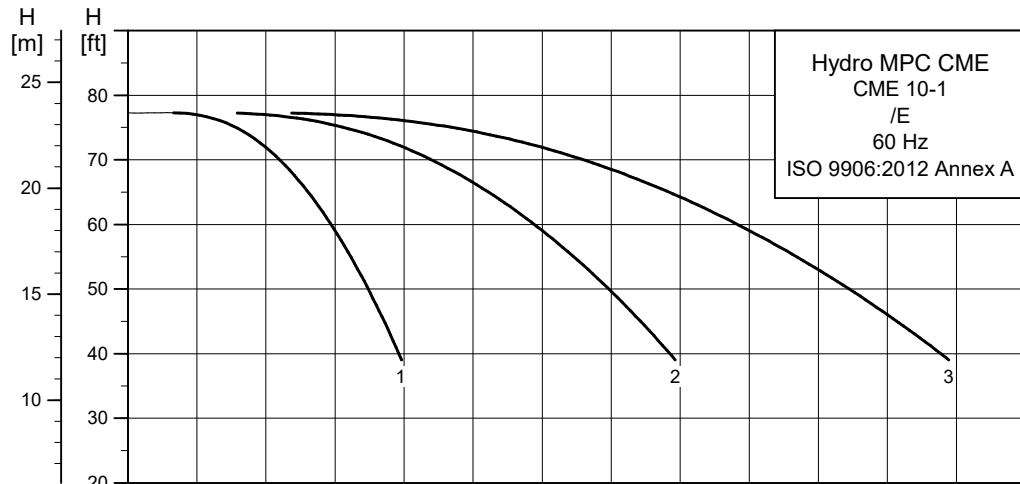

TM074910

Hydro MPC with CME 15

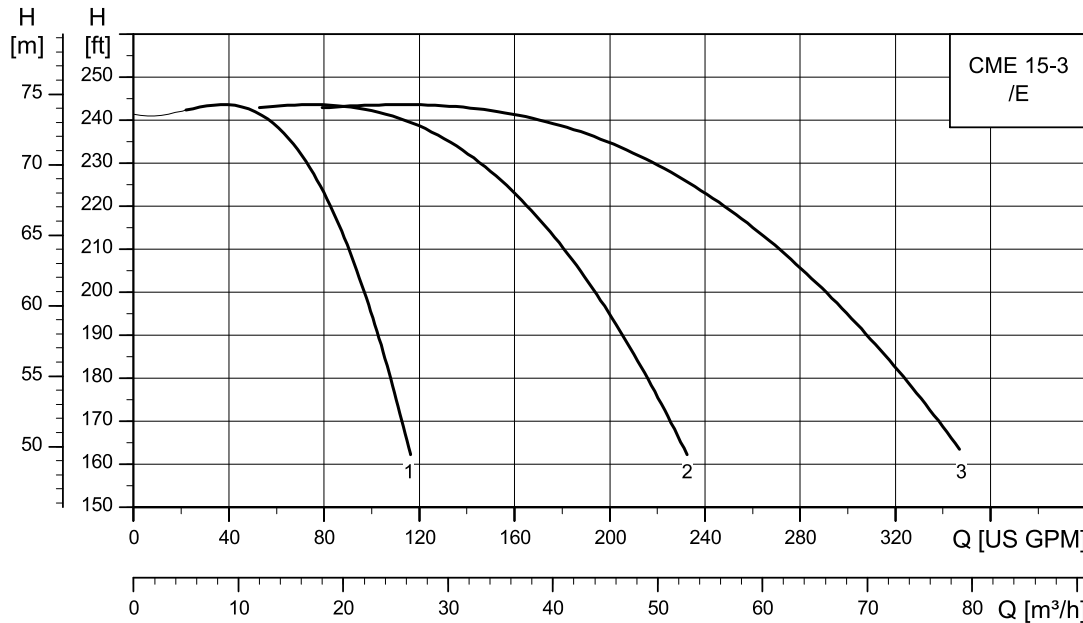
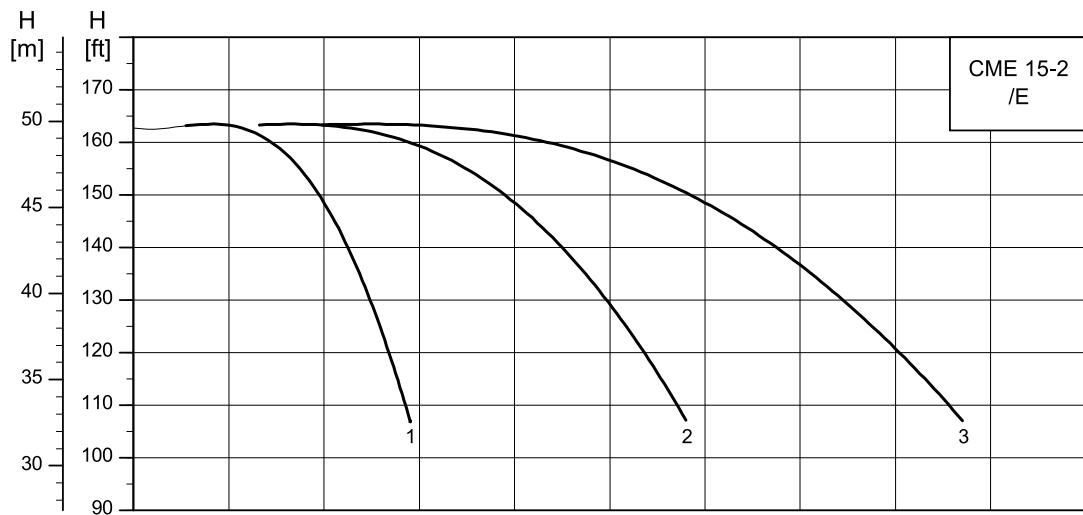
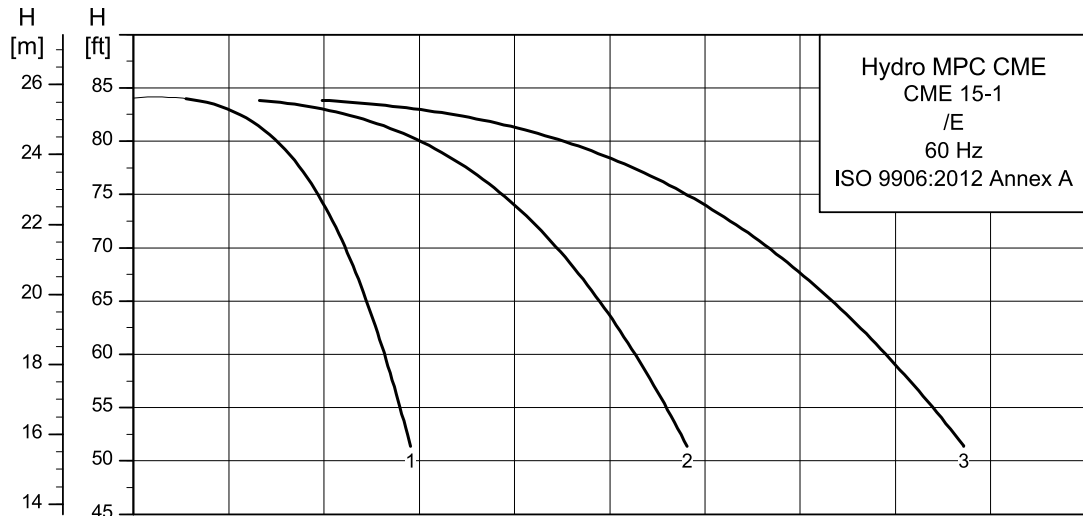

TM074911

Hydro MPC with CME 25

Curve charts, Hydro MPC CME, 60 Hz

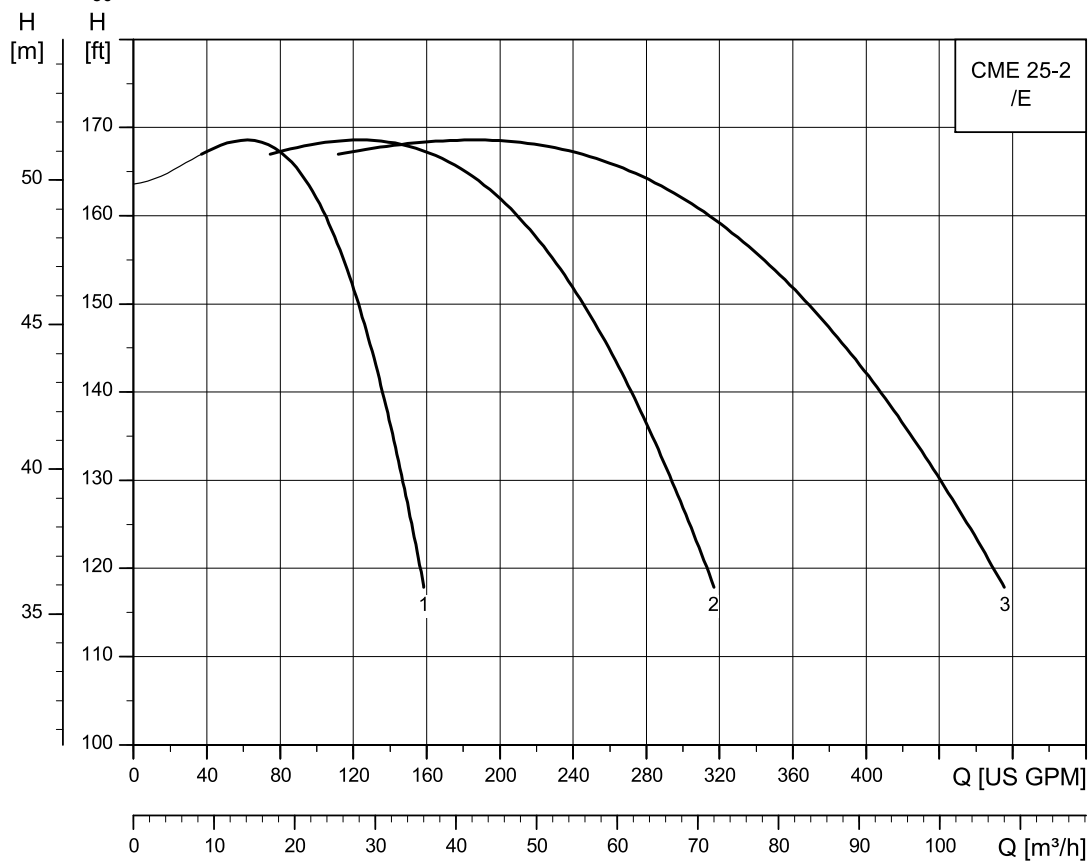
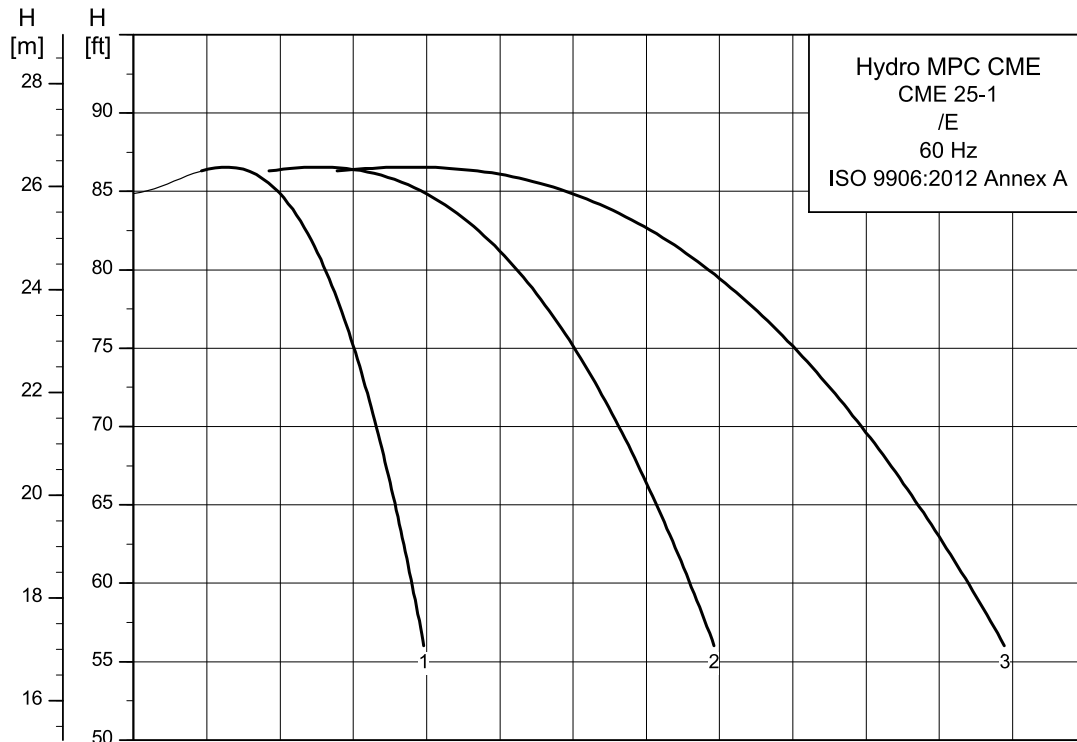

TM08616

10. Technical data, Hydro MPC-E, 60 Hz

Dimensional sketches for CR, CRE

Below is the dimensional sketch of a system in different designs. The system is shown as an example. The pumps supplied may differ from the sketch.

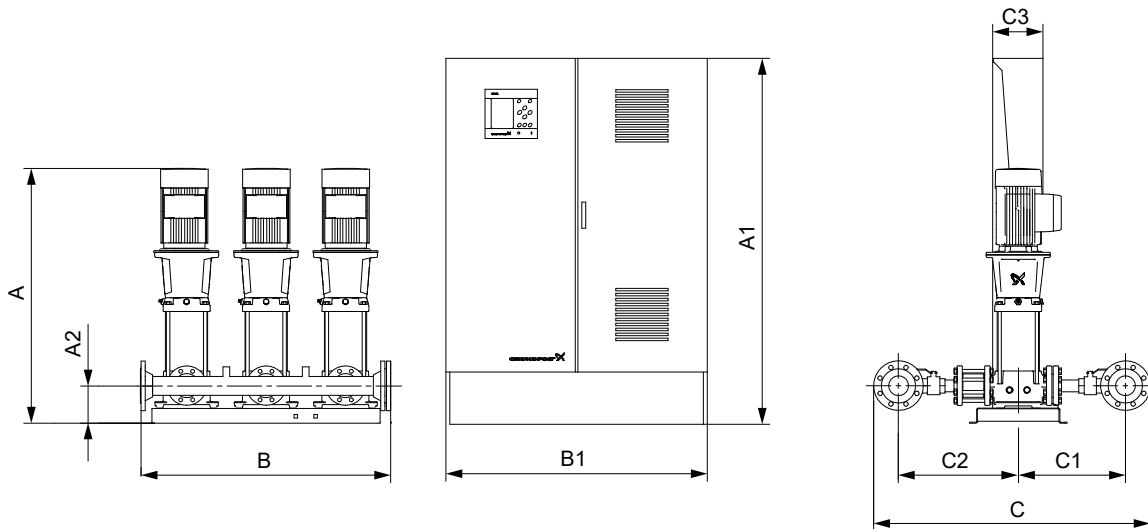

TM072034

Design C

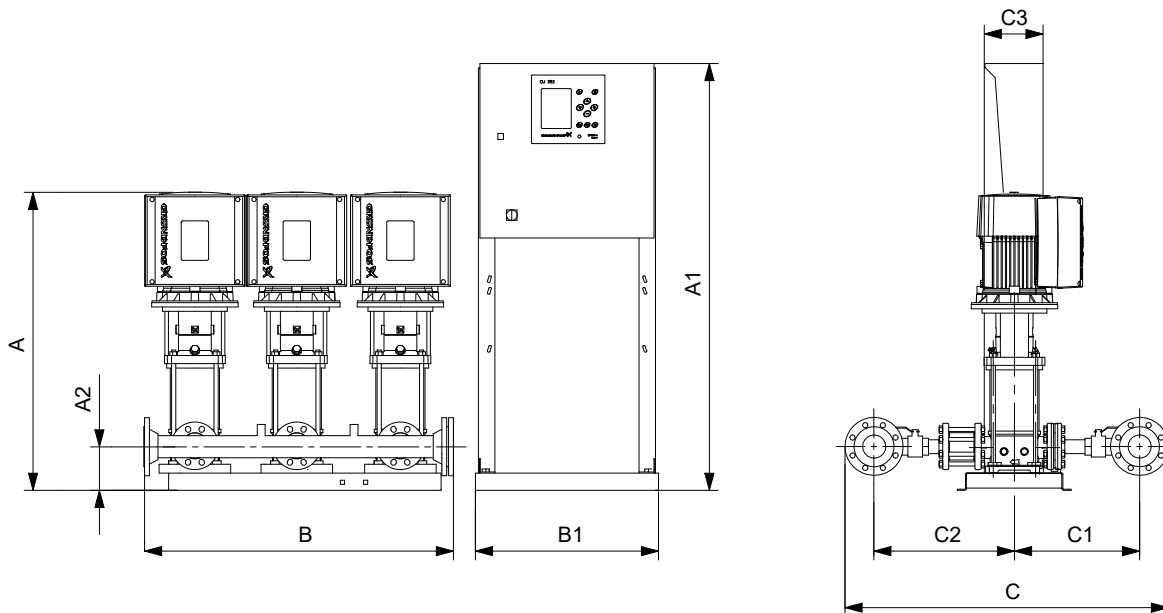

TM072035

Design D

Hydro MPC-E with CR, CRE 3

Hydro MPC-E with CR 3

Number of pumps	Pump type	Mains phases	Voltage code	Motor power [hp (kW)]	Connection size	A [in (mm)]	A1 [in (mm)]	A2 [in (mm)]	B [in (mm)]	B1 [in (mm)]	C [in (mm)]	C1 [in (mm)]	C2 [in (mm)]	C3 [in (mm)]	Gross weight [lbs (kg)]	Net weight [lbs (kg)]	Design
2	CR 3-6	3	UK	1 (0.75)	NPT 2"	24.9 (633)	59.1 (1500)	4.7 (120)	24.4 (621)	35.4 (900)	25.7 (652)	10.2 (260)	12.5 (318)	15.7 (400)	725 (329)	441 (200)	C
	CR 3-6	3	UL	1 (0.75)		24.9 (633)	59.1 (1500)	4.7 (120)	24.4 (621)	35.4 (900)	25.7 (652)	10.2 (260)	12.5 (318)	15.7 (400)	725 (329)	441 (200)	C
	CR 3-9	3	UK	1.5 (1.1)		29.7 (754)	59.1 (1500)	4.7 (120)	24.4 (621)	35.4 (900)	25.7 (652)	10.2 (260)	12.5 (318)	15.7 (400)	765 (347)	481 (218)	C
	CR 3-9	3	UL	1.5 (1.1)		29.7 (754)	59.1 (1500)	4.7 (120)	24.4 (621)	35.4 (900)	25.7 (652)	10.2 (260)	12.5 (318)	15.7 (400)	765 (347)	481 (218)	C
	CR 3-12	3	UK	2 (1.5)		32.6 (828)	59.1 (1500)	4.7 (120)	24.4 (621)	35.4 (900)	25.7 (652)	10.2 (260)	12.5 (318)	15.7 (400)	779.7 (354)	495.6 (225)	C
	CR 3-12	3	UL	2 (1.5)		32.6 (828)	59.1 (1500)	4.7 (120)	24.4 (621)	35.4 (900)	25.7 (652)	10.2 (260)	12.5 (318)	15.7 (400)	780 (354)	496 (225)	C
3	CR 3-6	3	UK	1 (0.75)	NPT 2"	24.9 (633)	59.1 (1500)	4.7 (120)	37 (941)	35.4 (900)	25.7 (652)	10.2 (260)	12.5 (318)	15.7 (400)	829 (376)	531 (241)	C
	CR 3-6	3	UL	1 (0.75)		24.9 (633)	59.1 (1500)	4.7 (120)	37 (941)	35.4 (900)	25.7 (652)	10.2 (260)	12.5 (318)	15.7 (400)	829 (376)	531 (241)	C
	CR 3-9	3	UK	1.5 (1.1)		29.7 (754)	59.1 (1500)	4.7 (120)	37 (941)	35.4 (900)	25.7 (652)	10.2 (260)	12.5 (318)	15.7 (400)	888 (403)	591 (268)	C
	CR 3-9	3	UL	1.5 (1.1)		29.7 (754)	59.1 (1500)	4.7 (120)	37 (941)	35.4 (900)	25.7 (652)	10.2 (260)	12.5 (318)	15.7 (400)	888 (403)	591 (268)	C
	CR 3-12	3	UK	2 (1.5)		32.6 (828)	59.1 (1500)	4.7 (120)	37 (941)	35.4 (900)	25.7 (652)	10.2 (260)	12.5 (318)	15.7 (400)	909.7 (413)	612.3 (278)	C
	CR 3-12	3	UL	2 (1.5)		32.6 (828)	59.1 (1500)	4.7 (120)	37 (941)	35.4 (900)	25.7 (652)	10.2 (260)	12.5 (318)	15.7 (400)	910 (413)	613 (278)	C
4	CR 3-6	3	UK	1 (0.75)	NPT 2 1/2"	24.9 (633)	59.1 (1500)	4.7 (120)	49.5 (1258)	35.4 (900)	28.5 (723)	11.3 (287)	13.6 (345)	15.7 (400)	989 (449)	637 (289)	C
	CR 3-6	3	UL	1 (0.75)		24.9 (633)	59.1 (1500)	4.7 (120)	49.5 (1258)	35.4 (900)	28.5 (723)	11.3 (287)	13.6 (345)	15.7 (400)	989 (449)	637 (289)	C
	CR 3-9	3	UK	1.5 (1.1)		29.7 (754)	59.1 (1500)	4.7 (120)	49.5 (1258)	35.4 (900)	28.5 (723)	11.3 (287)	13.6 (345)	15.7 (400)	1069 (485)	716 (325)	C
	CR 3-9	3	UL	1.5 (1.1)		29.7 (754)	59.1 (1500)	4.7 (120)	49.5 (1258)	35.4 (900)	28.5 (723)	11.3 (287)	13.6 (345)	15.7 (400)	1069 (485)	716 (325)	C
	CR 3-12	3	UK	2 (1.5)		32.6 (828)	59.1 (1500)	4.7 (120)	49.5 (1258)	35.4 (900)	28.5 (723)	11.3 (287)	13.6 (345)	15.7 (400)	1100 (499)	747 (339)	C
	CR 3-12	3	UL	2 (1.5)		32.6 (828)	59.1 (1500)	4.7 (120)	49.5 (1258)	35.4 (900)	28.5 (723)	11.3 (287)	13.6 (345)	15.7 (400)	1097 (498)	745 (338)	C
5	CR 3-6	3	UK	1 (0.75)	NPT 2 1/2"	24.9 (633)	74.8 (1900)	4.7 (120)	62.1 (1578)	47.2 (1200)	28.5 (723)	11.3 (287)	13.6 (345)	19.7 (500)	1152 (523)	743 (337)	C
	CR 3-6	3	UL	1 (0.75)		24.9 (633)	74.8 (1900)	4.7 (120)	62.1 (1578)	47.2 (1200)	28.5 (723)	11.3 (287)	13.6 (345)	19.7 (500)	1150 (522)	741 (336)	C
	CR 3-9	3	UK	1.5 (1.1)		29.7 (754)	74.8 (1900)	4.7 (120)	62.1 (1578)	47.2 (1200)	28.5 (723)	11.3 (287)	13.6 (345)	19.7 (500)	1252 (568)	842 (382)	C
	CR 3-9	3	UL	1.5 (1.1)		29.7 (754)	74.8 (1900)	4.7 (120)	62.1 (1578)	47.2 (1200)	28.5 (723)	11.3 (287)	13.6 (345)	19.7 (500)	1249 (567)	840 (381)	C
	CR 3-12	3	UK	2 (1.5)		32.6 (828)	74.8 (1900)	4.7 (120)	62.1 (1578)	47.2 (1200)	28.5 (723)	11.3 (287)	13.6 (345)	19.7 (500)	1287 (584)	877 (398)	C
	CR 3-12	3	UL	2 (1.5)		32.6 (828)	74.8 (1900)	4.7 (120)	62.1 (1578)	47.2 (1200)	28.5 (723)	11.3 (287)	13.6 (345)	19.7 (500)	1285 (583)	875 (397)	C

Number of pumps	Pump type	Mains phases	Voltage code	Motor power [hp (kW)]	Connection size	A [in (mm)]	A1 [in (mm)]	A2 [in (mm)]	B [in (mm)]	B1 [in (mm)]	C [in (mm)]	C1 [in (mm)]	C2 [in (mm)]	C3 [in (mm)]	Gross weight [lbs (kg)]	Net weight [lbs (kg)]	Design
6	CR 3-6	3	UK	1 (0.75)	NPT 2 1/2"	24.9 (633)	74.8 (1900)	4.7 (120)	74.7 (1898)	47.2 (1200)	28.5 (723)	11.3 (287)	13.6 (345)	19.7 (500)	1245 (565)	835 (379)	C
	CR 3-6	3	UL	1 (0.75)		24.9 (633)	74.8 (1900)	4.7 (120)	74.7 (1898)	47.2 (1200)	28.5 (723)	11.3 (287)	13.6 (345)	19.7 (500)	1243 (564)	833 (378)	C
	CR 3-9	3	UK	1.5 (1.1)		29.7 (754)	74.8 (1900)	4.7 (120)	74.7 (1898)	47.2 (1200)	28.5 (723)	11.3 (287)	13.6 (345)	19.7 (500)	1366 (620)	956 (434)	C
	CR 3-9	3	UL	1.5 (1.1)		29.7 (754)	74.8 (1900)	4.7 (120)	74.7 (1898)	47.2 (1200)	28.5 (723)	11.3 (287)	13.6 (345)	19.7 (500)	1364 (619)	954 (433)	C
	CR 3-12	3	UK	2 (1.5)		32.6 (828)	74.8 (1900)	4.7 (120)	74.7 (1898)	47.2 (1200)	28.5 (723)	11.3 (287)	13.6 (345)	19.7 (500)	1410 (640)	1000 (454)	C
	CR 3-12	3	UL	2 (1.5)		32.6 (828)	74.8 (1900)	4.7 (120)	74.7 (1898)	47.2 (1200)	28.5 (723)	11.3 (287)	13.6 (345)	19.7 (500)	1406 (638)	996 (452)	C

Dimensions may vary by ± 0.5 inch (12.7 mm).

Hydro MPC-E with CRE 3

Number of pumps	Pump type	Mains phases	Voltage code	Motor power [hp (kW)]	Connection size	A [in (mm)]	A1 [in (mm)]	A2 [in (mm)]	B [in (mm)]	B1 [in (mm)]	C [in (mm)]	C1 [in (mm)]	C2 [in (mm)]	C3 [in (mm)]	Gross weight [lbs (kg)]	Net weight [lbs (kg)]	Design
2	CRE 3-6	1	UJ	1.5 (1.1)	NPT 2"	24.3 (618)	57.5 (1460)	4.7 (120)	24.4 (621)	24.8 (630)	25.7 (652)	10.2 (260)	12.5 (318)	7.9 (200)	494 (224)	274 (124)	D
	CRE 3-6	3	UK	1.5 (1.1)		25.9 (658)	57.5 (1460)	4.7 (120)	24.4 (621)	24.8 (630)	25.7 (652)	10.2 (260)	12.5 (318)	7.9 (200)	498 (226)	278 (126)	D
	CRE 3-6	3	UL	1 (0.75)		25.9 (658)	57.5 (1460)	4.7 (120)	24.4 (621)	24.8 (630)	25.7 (652)	10.2 (260)	12.5 (318)	7.9 (200)	496 (225)	276 (125)	D
	CRE 3-9	1	UJ	2 (1.5)		27.2 (692)	57.5 (1460)	4.7 (120)	24.4 (621)	24.8 (630)	25.7 (652)	10.2 (260)	12.5 (318)	7.9 (200)	507 (230)	287 (130)	D
	CRE 3-9	3	UK	1.5 (1.1)		28 (712)	57.5 (1460)	4.7 (120)	24.4 (621)	24.8 (630)	25.7 (652)	10.2 (260)	12.5 (318)	7.9 (200)	505 (229)	285 (129)	D
	CRE 3-9	3	UL	1.5 (1.1)		28 (712)	57.5 (1460)	4.7 (120)	24.4 (621)	24.8 (630)	25.7 (652)	10.2 (260)	12.5 (318)	7.9 (200)	505 (229)	285 (129)	D
	CRE 3-11	1	UJ	2 (1.5)		28.7 (728)	57.5 (1460)	4.7 (120)	24.4 (621)	24.8 (630)	25.7 (652)	10.2 (260)	12.5 (318)	7.9 (200)	509 (231)	289 (131)	D
	CRE 3-12	3	UK	2 (1.5)		30.9 (786)	57.5 (1460)	4.7 (120)	24.4 (621)	24.8 (630)	25.7 (652)	10.2 (260)	12.5 (318)	7.9 (200)	518 (235)	298 (135)	D
	CRE 3-12	3	UL	2 (1.5)		30.9 (786)	57.5 (1460)	4.7 (120)	24.4 (621)	24.8 (630)	25.7 (652)	10.2 (260)	12.5 (318)	7.9 (200)	518 (235)	298 (135)	D

Number of pumps	Pump type	Mains phases	Voltage code	Motor power [hp (kW)]	Connection size	A [in (mm)]	A1 [in (mm)]	A2 [in (mm)]	B [in (mm)]	B1 [in (mm)]	C [in (mm)]	C1 [in (mm)]	C2 [in (mm)]	C3 [in (mm)]	Gross weight [lbs (kg)]	Net weight [lbs (kg)]	Design
3	CRE 3-6	1	UJ	1.5 (1.1)	NPT 2"	24.3 (618)	57.5 (1460)	4.7 (120)	37 (941)	24.8 (630)	25.7 (652)	10.2 (260)	12.5 (318)	7.9 (200)	655 (297)	357 (162)	D
	CRE 3-6	3	UK	1.5 (1.1)		25.9 (658)	57.5 (1460)	4.7 (120)	37 (941)	24.8 (630)	25.7 (652)	10.2 (260)	12.5 (318)	7.9 (200)	661 (300)	364 (165)	D
	CRE 3-6	3	UL	1 (0.75)		25.9 (658)	57.5 (1460)	4.7 (120)	37 (941)	24.8 (630)	25.7 (652)	10.2 (260)	12.5 (318)	7.9 (200)	657 (298)	359 (163)	D
	CRE 3-9	1	UJ	2 (1.5)		27.2 (692)	57.5 (1460)	4.7 (120)	37 (941)	24.8 (630)	25.7 (652)	10.2 (260)	12.5 (318)	7.9 (200)	674 (306)	377 (171)	D
	CRE 3-9	3	UK	1.5 (1.1)		28 (712)	57.5 (1460)	4.7 (120)	37 (941)	24.8 (630)	25.7 (652)	10.2 (260)	12.5 (318)	7.9 (200)	670 (304)	373 (169)	D
	CRE 3-9	3	UL	1.5 (1.1)		28 (712)	57.5 (1460)	4.7 (120)	37 (941)	24.8 (630)	25.7 (652)	10.2 (260)	12.5 (318)	7.9 (200)	672 (305)	375 (170)	D
	CRE 3-11	1	UJ	2 (1.5)		28.7 (728)	57.5 (1460)	4.7 (120)	37 (941)	24.8 (630)	25.7 (652)	10.2 (260)	12.5 (318)	7.9 (200)	679 (308)	382 (173)	D
	CRE 3-12	3	UK	2 (1.5)		30.9 (786)	57.5 (1460)	4.7 (120)	37 (941)	24.8 (630)	25.7 (652)	10.2 (260)	12.5 (318)	7.9 (200)	690 (313)	393 (178)	D
	CRE 3-12	3	UL	2 (1.5)		30.9 (786)	57.5 (1460)	4.7 (120)	37 (941)	24.8 (630)	25.7 (652)	10.2 (260)	12.5 (318)	7.9 (200)	690 (313)	393 (178)	D
4	CRE 3-6	1	UJ	1.5 (1.1)	NPT 2 1/2"	24.3 (618)	57.5 (1460)	4.7 (120)	49.5 (1258)	24.8 (630)	28.5 (723)	11.3 (287)	13.6 (345)	7.9 (200)	749 (340)	452 (205)	D
	CRE 3-6	3	UK	1.5 (1.1)		25.9 (658)	57.5 (1460)	4.7 (120)	49.5 (1258)	24.8 (630)	28.5 (723)	11.3 (287)	13.6 (345)	7.9 (200)	765 (347)	467 (212)	D
	CRE 3-6	3	UL	1 (0.75)		25.9 (658)	57.5 (1460)	4.7 (120)	49.5 (1258)	24.8 (630)	28.5 (723)	11.3 (287)	13.6 (345)	7.9 (200)	758 (344)	461 (209)	D
	CRE 3-9	1	UJ	2 (1.5)		27.2 (692)	57.5 (1460)	4.7 (120)	49.5 (1258)	24.8 (630)	28.5 (723)	11.3 (287)	13.6 (345)	7.9 (200)	776 (352)	478 (217)	D
	CRE 3-9	3	UK	1.5 (1.1)		28 (712)	57.5 (1460)	4.7 (120)	49.5 (1258)	24.8 (630)	28.5 (723)	11.3 (287)	13.6 (345)	7.9 (200)	776 (352)	478 (217)	D
	CRE 3-9	3	UL	1.5 (1.1)		28 (712)	57.5 (1460)	4.7 (120)	49.5 (1258)	24.8 (630)	28.5 (723)	11.3 (287)	13.6 (345)	7.9 (200)	776 (352)	478 (217)	D
	CRE 3-11	1	UJ	2 (1.5)		28.7 (728)	57.5 (1460)	4.7 (120)	49.5 (1258)	24.8 (630)	28.5 (723)	11.3 (287)	13.6 (345)	7.9 (200)	782 (355)	485 (220)	D
	CRE 3-12	3	UK	2 (1.5)		30.9 (786)	57.5 (1460)	4.7 (120)	49.5 (1258)	24.8 (630)	28.5 (723)	11.3 (287)	13.6 (345)	7.9 (200)	800 (363)	503 (228)	D
	CRE 3-12	3	UL	2 (1.5)		30.9 (786)	57.5 (1460)	4.7 (120)	49.5 (1258)	24.8 (630)	28.5 (723)	11.3 (287)	13.6 (345)	7.9 (200)	802 (364)	505 (229)	D
5	CRE 3-6	1	UJ	1.5 (1.1)	NPT 2 1/2"	24.3 (618)	57.5 (1460)	4.7 (120)	62.1 (1578)	24.8 (630)	28.5 (723)	11.3 (287)	13.6 (345)	7.9 (200)	890 (404)	538 (244)	D
	CRE 3-6	3	UK	1.5 (1.1)		25.9 (658)	57.5 (1460)	4.7 (120)	62.1 (1578)	24.8 (630)	28.5 (723)	11.3 (287)	13.6 (345)	7.9 (200)	910 (413)	558 (253)	D
	CRE 3-6	3	UL	1 (0.75)		25.9 (658)	57.5 (1460)	4.7 (120)	62.1 (1578)	24.8 (630)	28.5 (723)	11.3 (287)	13.6 (345)	7.9 (200)	904 (410)	551 (250)	D
	CRE 3-9	1	UJ	2 (1.5)		27.2 (692)	57.5 (1460)	4.7 (120)	62.1 (1578)	24.8 (630)	28.5 (723)	11.3 (287)	13.6 (345)	7.9 (200)	926 (420)	573 (260)	D
	CRE 3-9	3	UK	1.5 (1.1)		28 (712)	57.5 (1460)	4.7 (120)	62.1 (1578)	24.8 (630)	28.5 (723)	11.3 (287)	13.6 (345)	7.9 (200)	926 (420)	573 (260)	D
	CRE 3-9	3	UL	1.5 (1.1)		28 (712)	57.5 (1460)	4.7 (120)	62.1 (1578)	24.8 (630)	28.5 (723)	11.3 (287)	13.6 (345)	7.9 (200)	926 (420)	573 (260)	D
	CRE 3-11	1	UJ	2 (1.5)		28.7 (728)	57.5 (1460)	4.7 (120)	62.1 (1578)	24.8 (630)	28.5 (723)	11.3 (287)	13.6 (345)	7.9 (200)	932 (423)	580 (263)	D
	CRE 3-12	3	UK	2 (1.5)		30.9 (786)	57.5 (1460)	4.7 (120)	62.1 (1578)	24.8 (630)	28.5 (723)	11.3 (287)	13.6 (345)	7.9 (200)	956 (434)	604 (274)	D
	CRE 3-12	3	UL	2 (1.5)		30.9 (786)	57.5 (1460)	4.7 (120)	62.1 (1578)	24.8 (630)	28.5 (723)	11.3 (287)	13.6 (345)	7.9 (200)	959 (435)	606 (275)	D

Number of pumps	Pump type	Mains phases	Voltage code	Motor power [hp (kW)]	Connection size	A [in (mm)]	A1 [in (mm)]	A2 [in (mm)]	B [in (mm)]	B1 [in (mm)]	C [in (mm)]	C1 [in (mm)]	C2 [in (mm)]	C3 [in (mm)]	Gross weight [lbs (kg)]	Net weight [lbs (kg)]	Design
6	CRE 3-6	1	UJ	1.5 (1.1)	NPT 2 1/2"	24.3 (618)	57.5 (1460)	4.7 (120)	74.7 (1898)	24.8 (630)	28.5 (723)	11.3 (287)	13.6 (345)	7.9 (200)	1020 (463)	624 (283)	D
	CRE 3-6	3	UK	1.5 (1.1)		25.9 (658)	57.5 (1460)	4.7 (120)	74.7 (1898)	24.8 (630)	28.5 (723)	11.3 (287)	13.6 (345)	7.9 (200)	1045 (474)	648 (294)	D
	CRE 3-6	3	UL	1 (0.75)		25.9 (658)	57.5 (1460)	4.7 (120)	74.7 (1898)	24.8 (630)	28.5 (723)	11.3 (287)	13.6 (345)	7.9 (200)	1036 (470)	639 (290)	D
	CRE 3-9	1	UJ	2 (1.5)		27.2 (692)	57.5 (1460)	4.7 (120)	74.7 (1898)	24.8 (630)	28.5 (723)	11.3 (287)	13.6 (345)	7.9 (200)	1060 (481)	663 (301)	D
	CRE 3-9	3	UK	1.5 (1.1)		28 (712)	57.5 (1460)	4.7 (120)	74.7 (1898)	24.8 (630)	28.5 (723)	11.3 (287)	13.6 (345)	7.9 (200)	1062 (482)	666 (302)	D
	CRE 3-9	3	UL	1.5 (1.1)		28 (712)	57.5 (1460)	4.7 (120)	74.7 (1898)	24.8 (630)	28.5 (723)	11.3 (287)	13.6 (345)	7.9 (200)	1062 (482)	666 (302)	D
	CRE 3-11	1	UJ	2 (1.5)		28.7 (728)	57.5 (1460)	4.7 (120)	74.7 (1898)	24.8 (630)	28.5 (723)	11.3 (287)	13.6 (345)	7.9 (200)	1071 (486)	674 (306)	D
	CRE 3-12	3	UK	2 (1.5)		30.9 (786)	57.5 (1460)	4.7 (120)	74.7 (1898)	24.8 (630)	28.5 (723)	11.3 (287)	13.6 (345)	7.9 (200)	1100 (499)	703 (319)	D
	CRE 3-12	3	UL	2 (1.5)		30.9 (786)	57.5 (1460)	4.7 (120)	74.7 (1898)	24.8 (630)	28.5 (723)	11.3 (287)	13.6 (345)	7.9 (200)	1102 (500)	705 (320)	D

Dimensions may vary by ± 0.5 inch (12.7 mm).

Hydro MPC-E with CR, CRE 5

Hydro MPC-E with CR 5

Number of pumps	Pump type	Mains phases	Voltage code	Motor power [hp (kW)]	Connection size	A [in (mm)]	A1 [in (mm)]	A2 [in (mm)]	B [in (mm)]	B1 [in (mm)]	C [in (mm)]	C1 [in (mm)]	C2 [in (mm)]	C3 [in (mm)]	Gross weight [lbs (kg)]	Net weight [lbs (kg)]	Design
2	CR 5-4	3	UK	1.5 (1.1)	NPT 2"	27.6 (700)	59.1 (1500)	4.7 (120)	24.4 (621)	35.4 (900)	25.7 (652)	10.2 (260)	12.5 (318)	15.7 (400)	760 (345)	476 (216)	C
	CR 5-4	3	UL	1.5 (1.1)		27.6 (700)	59.1 (1500)	4.7 (120)	24.4 (621)	35.4 (900)	25.7 (652)	10.2 (260)	12.5 (318)	15.7 (400)	760 (345)	476 (216)	C
	CR 5-6	3	UK	2 (1.5)		30.5 (774)	59.1 (1500)	4.7 (120)	24.4 (621)	35.4 (900)	25.7 (652)	10.2 (260)	12.5 (318)	15.7 (400)	774 (351)	489 (222)	C
	CR 5-6	3	UL	2 (1.5)		30.5 (774)	59.1 (1500)	4.7 (120)	24.4 (621)	35.4 (900)	25.7 (652)	10.2 (260)	12.5 (318)	15.7 (400)	774 (351)	489 (222)	C
	CR 5-9	3	UK	3 (2.2)		36 (914)	59.1 (1500)	4.7 (120)	24.4 (621)	35.4 (900)	25.7 (652)	10.2 (260)	12.5 (318)	15.7 (400)	853 (387)	569 (258)	C
	CR 5-9	3	UL	3 (2.2)		36 (914)	59.1 (1500)	4.7 (120)	24.4 (621)	35.4 (900)	25.7 (652)	10.2 (260)	12.5 (318)	15.7 (400)	853 (387)	569 (258)	C
3	CR 5-4	3	UK	1.5 (1.1)	NPT 2 1/2"	27.6 (700)	59.1 (1500)	4.7 (120)	36.9 (938)	35.4 (900)	28.5 (723)	11.3 (287)	13.6 (345)	15.7 (400)	886 (402)	589 (267)	C
	CR 5-4	3	UL	1.5 (1.1)		27.6 (700)	59.1 (1500)	4.7 (120)	36.9 (938)	35.4 (900)	28.5 (723)	11.3 (287)	13.6 (345)	15.7 (400)	886 (402)	589 (267)	C
	CR 5-6	3	UK	2 (1.5)		30.5 (774)	59.1 (1500)	4.7 (120)	36.9 (938)	35.4 (900)	28.5 (723)	11.3 (287)	13.6 (345)	15.7 (400)	906 (411)	608 (276)	C
	CR 5-6	3	UL	2 (1.5)		30.5 (774)	59.1 (1500)	4.7 (120)	36.9 (938)	35.4 (900)	28.5 (723)	11.3 (287)	13.6 (345)	15.7 (400)	906 (411)	608 (276)	C
	CR 5-9	3	UK	3 (2.2)		36 (914)	59.1 (1500)	4.7 (120)	36.9 (938)	35.4 (900)	28.5 (723)	11.3 (287)	13.6 (345)	15.7 (400)	1027 (466)	730 (331)	C
	CR 5-9	3	UL	3 (2.2)		36 (914)	59.1 (1500)	4.7 (120)	36.9 (938)	35.4 (900)	28.5 (723)	11.3 (287)	13.6 (345)	15.7 (400)	1025 (465)	727 (330)	C
4	CR 5-4	3	UK	1.5 (1.1)	NPT 3"	27.6 (700)	59.1 (1500)	4.7 (120)	49.6 (1261)	35.4 (900)	29.2 (742)	11.3 (287)	13.6 (345)	15.7 (400)	1060 (481)	707 (321)	C
	CR 5-4	3	UL	1.5 (1.1)		27.6 (700)	59.1 (1500)	4.7 (120)	49.6 (1261)	35.4 (900)	29.2 (742)	11.3 (287)	13.6 (345)	15.7 (400)	1060 (481)	707 (321)	C
	CR 5-6	3	UK	2 (1.5)		30.5 (774)	59.1 (1500)	4.7 (120)	49.6 (1261)	35.4 (900)	29.2 (742)	11.3 (287)	13.6 (345)	15.7 (400)	1091 (495)	738 (335)	C
	CR 5-6	3	UL	2 (1.5)		30.5 (774)	59.1 (1500)	4.7 (120)	49.6 (1261)	35.4 (900)	29.2 (742)	11.3 (287)	13.6 (345)	15.7 (400)	1089 (494)	736 (334)	C
	CR 5-9	3	UK	3 (2.2)		36 (914)	59.1 (1500)	4.7 (120)	49.6 (1261)	35.4 (900)	29.2 (742)	11.3 (287)	13.6 (345)	15.7 (400)	1249 (567)	897 (407)	C
	CR 5-9	3	UL	3 (2.2)		36 (914)	59.1 (1500)	4.7 (120)	49.6 (1261)	35.4 (900)	29.2 (742)	11.3 (287)	13.6 (345)	15.7 (400)	1245 (565)	893 (405)	C
5	CR 5-4	3	UK	1.5 (1.1)	NPT 3"	27.6 (700)	74.8 (1900)	4.7 (120)	62.2 (1581)	47.2 (1200)	29.2 (742)	11.3 (287)	13.6 (345)	19.7 (500)	1241 (563)	831 (377)	C
	CR 5-4	3	UL	1.5 (1.1)		27.6 (700)	74.8 (1900)	4.7 (120)	62.2 (1581)	47.2 (1200)	29.2 (742)	11.3 (287)	13.6 (345)	19.7 (500)	1238 (562)	829 (376)	C
	CR 5-6	3	UK	2 (1.5)		30.5 (774)	74.8 (1900)	4.7 (120)	62.2 (1581)	47.2 (1200)	29.2 (742)	11.3 (287)	13.6 (345)	19.7 (500)	1276 (579)	866 (393)	C
	CR 5-6	3	UL	2 (1.5)		30.5 (774)	74.8 (1900)	4.7 (120)	62.2 (1581)	47.2 (1200)	29.2 (742)	11.3 (287)	13.6 (345)	19.7 (500)	1274 (578)	864 (392)	C
	CR 5-9	3	UK	3 (2.2)		36 (914)	74.8 (1900)	4.7 (120)	62.2 (1581)	47.2 (1200)	29.2 (742)	11.3 (287)	13.6 (345)	19.7 (500)	1476 (670)	1067 (484)	C
	CR 5-9	3	UL	3 (2.2)		36 (914)	74.8 (1900)	4.7 (120)	62.2 (1581)	47.2 (1200)	29.2 (742)	11.3 (287)	13.6 (345)	19.7 (500)	1474 (669)	1064 (483)	C

Number of pumps	Pump type	Mains phases	Voltage code	Motor power [hp (kW)]	Connection size	A [in (mm)]	A1 [in (mm)]	A2 [in (mm)]	B [in (mm)]	B1 [in (mm)]	C [in (mm)]	C1 [in (mm)]	C2 [in (mm)]	C3 [in (mm)]	Gross weight [lbs (kg)]	Net weight [lbs (kg)]	Design
6	CR 5-4	3	UK	1.5 (1.1)	4" Class 150	27.6 (700)	74.8 (1900)	4.7 (120)	75 (1906)	47.2 (1200)	34.1 (865)	11.4 (289)	13.7 (347)	19.7 (500)	1388 (630)	978 (444)	C
	CR 5-4	3	UL	1.5 (1.1)		27.6 (700)	74.8 (1900)	4.7 (120)	75 (1906)	47.2 (1200)	34.1 (865)	11.4 (289)	13.7 (347)	19.7 (500)	1386 (629)	976 (443)	C
	CR 5-6	3	UK	2 (1.5)		30.5 (774)	74.8 (1900)	4.7 (120)	75 (1906)	47.2 (1200)	34.1 (865)	11.4 (289)	13.7 (347)	19.7 (500)	1432 (650)	1022 (464)	C
	CR 5-6	3	UL	2 (1.5)		30.5 (774)	74.8 (1900)	4.7 (120)	75 (1906)	47.2 (1200)	34.1 (865)	11.4 (289)	13.7 (347)	19.7 (500)	1428 (648)	1018 (462)	C
	CR 5-9	3	UK	3 (2.2)		36 (914)	74.8 (1900)	4.7 (120)	75 (1906)	47.2 (1200)	34.1 (865)	11.4 (289)	13.7 (347)	19.7 (500)	1670 (758)	1260 (572)	C
	CR 5-9	3	UL	3 (2.2)		36 (914)	74.8 (1900)	4.7 (120)	75 (1906)	47.2 (1200)	34.1 (865)	11.4 (289)	13.7 (347)	19.7 (500)	1668 (757)	1258 (571)	C

Dimensions may vary by ± 0.5 inch (12.7 mm).

Hydro MPC-E with CRE 5

Number of pumps	Pump type	Mains phases	Voltage code	Motor power [hp (kW)]	Connection size	A [in (mm)]	A1 [in (mm)]	A2 [in (mm)]	B [in (mm)]	B1 [in (mm)]	C [in (mm)]	C1 [in (mm)]	C2 [in (mm)]	C3 [in (mm)]	Gross weight [lbs (kg)]	Net weight [lbs (kg)]	Design
2	CRE 5-4	1	UJ	1.5 (1.1)	NPT 2"	24.3 (618)	57.5 (1460)	4.7 (120)	24.4 (621)	24.8 (630)	25.7 (652)	10.2 (260)	12.5 (318)	7.9 (200)	494 (224)	274 (124)	D
	CRE 5-4	3	UK	1.5 (1.1)		25.9 (658)	57.5 (1460)	4.7 (120)	24.4 (621)	24.8 (630)	25.7 (652)	10.2 (260)	12.5 (318)	7.9 (200)	498 (226)	278 (126)	D
	CRE 5-4	3	UL	1.5 (1.1)		25.9 (658)	57.5 (1460)	4.7 (120)	24.4 (621)	24.8 (630)	25.7 (652)	10.2 (260)	12.5 (318)	7.9 (200)	498 (226)	278 (126)	D
	CRE 5-5	1	UJ	2 (1.5)		26.2 (665)	57.5 (1460)	4.7 (120)	24.4 (621)	24.8 (630)	25.7 (652)	10.2 (260)	12.5 (318)	7.9 (200)	503 (228)	282 (128)	D
	CRE 5-6	3	UK	2 (1.5)		28.8 (732)	57.5 (1460)	4.7 (120)	24.4 (621)	24.8 (630)	25.7 (652)	10.2 (260)	12.5 (318)	7.9 (200)	511 (232)	291 (132)	D
	CRE 5-6	3	UL	2 (1.5)		28.8 (732)	57.5 (1460)	4.7 (120)	24.4 (621)	24.8 (630)	28.6 (726)	11.6 (295)	14 (355)	7.9 (200)	111 (50)	89 (40)	D
	CRE 5-6	3	UL	2 (1.5)		28.8 (732)	57.5 (1460)	4.7 (120)	24.4 (621)	24.8 (630)	25.7 (652)	10.2 (260)	12.5 (318)	7.9 (200)	511 (232)	291 (132)	D
	CRE 5-9	3	UK	3 (2.2)		35.4 (900)	57.5 (1460)	4.7 (120)	24.4 (621)	24.8 (630)	25.7 (652)	10.2 (260)	12.5 (318)	7.9 (200)	560 (254)	340 (154)	D
	CRE 5-9	3	UL	3 (2.2)		33.1 (841)	57.5 (1460)	4.7 (120)	24.4 (621)	24.8 (630)	25.7 (652)	10.2 (260)	12.5 (318)	7.9 (200)	542 (246)	322 (146)	D
	3	CRE 5-4	1	UJ		1.5 (1.1)	NPT 2 1/2"	24.3 (618)	57.5 (1460)	4.7 (120)	36.9 (938)	24.8 (630)	28.5 (723)	11.3 (287)	13.6 (345)	7.9 (200)	661 (300)
CRE 5-4		3	UK	1.5 (1.1)	25.9 (658)	57.5 (1460)		4.7 (120)	36.9 (938)	24.8 (630)	28.5 (723)	11.3 (287)	13.6 (345)	7.9 (200)	668 (303)	370 (168)	D
CRE 5-4		3	UL	1.5 (1.1)	25.9 (658)	57.5 (1460)		4.7 (120)	36.9 (938)	24.8 (630)	28.5 (723)	11.3 (287)	13.6 (345)	7.9 (200)	668 (303)	370 (168)	D
CRE 5-5		1	UJ	2 (1.5)	26.2 (665)	57.5 (1460)		4.7 (120)	36.9 (938)	24.8 (630)	28.5 (723)	11.3 (287)	13.6 (345)	7.9 (200)	674 (306)	377 (171)	D
CRE 5-6		3	UK	2 (1.5)	28.8 (732)	57.5 (1460)		4.7 (120)	36.9 (938)	24.8 (630)	28.5 (723)	11.3 (287)	13.6 (345)	7.9 (200)	688 (312)	390 (177)	D
CRE 5-6		3	UL	2 (1.5)	28.8 (732)	57.5 (1460)		4.7 (120)	36.9 (938)	24.8 (630)	28.5 (723)	11.3 (287)	13.6 (345)	7.9 (200)	688 (312)	390 (177)	D
CRE 5-9		3	UK	3 (2.2)	35.4 (900)	57.5 (1460)		4.7 (120)	36.9 (938)	24.8 (630)	28.5 (723)	11.3 (287)	13.6 (345)	7.9 (200)	758 (344)	461 (209)	D
CRE 5-9		3	UL	3 (2.2)	33.1 (841)	57.5 (1460)		4.7 (120)	36.9 (938)	24.8 (630)	28.5 (723)	11.3 (287)	13.6 (345)	7.9 (200)	734 (333)	437 (198)	D

Number of pumps	Pump type	Mains phases	Voltage code	Motor power [hp (kW)]	Connection size	A [in (mm)]	A1 [in (mm)]	A2 [in (mm)]	B [in (mm)]	B1 [in (mm)]	C [in (mm)]	C1 [in (mm)]	C2 [in (mm)]	C3 [in (mm)]	Gross weight [lbs (kg)]	Net weight [lbs (kg)]	Design
4	CRE 5-4	1	UJ	1.5 (1.1)	NPT 3"	24.3 (618)	57.5 (1460)	4.7 (120)	49.6 (1261)	24.8 (630)	29.2 (742)	11.3 (287)	13.6 (345)	7.9 (200)	752 (341)	454 (206)	D
	CRE 5-4	3	UK	1.5 (1.1)		25.9 (658)	57.5 (1460)	4.7 (120)	49.6 (1261)	24.8 (630)	29.2 (742)	11.3 (287)	13.6 (345)	7.9 (200)	767 (348)	470 (213)	D
	CRE 5-4	3	UL	1.5 (1.1)		25.9 (658)	57.5 (1460)	4.7 (120)	49.6 (1261)	24.8 (630)	29.2 (742)	11.3 (287)	13.6 (345)	7.9 (200)	767 (348)	470 (213)	D
	CRE 5-5	1	UJ	2 (1.5)		26.2 (665)	57.5 (1460)	4.7 (120)	49.6 (1261)	24.8 (630)	29.2 (742)	11.3 (287)	13.6 (345)	7.9 (200)	771 (350)	474 (215)	D
	CRE 5-6	3	UK	2 (1.5)		28.8 (732)	57.5 (1460)	4.7 (120)	49.6 (1261)	24.8 (630)	29.2 (742)	11.3 (287)	13.6 (345)	7.9 (200)	791 (359)	494 (224)	D
	CRE 5-6	3	UL	2 (1.5)		28.8 (732)	57.5 (1460)	4.7 (120)	49.6 (1261)	24.8 (630)	29.2 (742)	11.3 (287)	13.6 (345)	7.9 (200)	793 (360)	496 (225)	D
	CRE 5-9	3	UK	3 (2.2)		35.4 (900)	57.5 (1460)	4.7 (120)	49.6 (1261)	24.8 (630)	29.2 (742)	11.3 (287)	13.6 (345)	7.9 (200)	888 (403)	591 (268)	D
	CRE 5-9	3	UL	3 (2.2)		33.1 (841)	57.5 (1460)	4.7 (120)	49.6 (1261)	24.8 (630)	29.2 (742)	11.3 (287)	13.6 (345)	7.9 (200)	855 (388)	558 (253)	D
5	CRE 5-4	1	UJ	1.5 (1.1)	NPT 3"	24.3 (618)	57.5 (1460)	4.7 (120)	62.2 (1581)	24.8 (630)	29.2 (742)	11.3 (287)	13.6 (345)	7.9 (200)	895 (406)	542 (246)	D
	CRE 5-4	3	UK	1.5 (1.1)		25.9 (658)	57.5 (1460)	4.7 (120)	62.2 (1581)	24.8 (630)	29.2 (742)	11.3 (287)	13.6 (345)	7.9 (200)	915 (415)	562 (255)	D
	CRE 5-4	3	UL	1.5 (1.1)		25.9 (658)	57.5 (1460)	4.7 (120)	62.2 (1581)	24.8 (630)	29.2 (742)	11.3 (287)	13.6 (345)	7.9 (200)	915 (415)	562 (255)	D
	CRE 5-5	1	UJ	2 (1.5)		26.2 (665)	57.5 (1460)	4.7 (120)	62.2 (1581)	24.8 (630)	29.2 (742)	11.3 (287)	13.6 (345)	7.9 (200)	919 (417)	567 (257)	D
	CRE 5-6	3	UK	2 (1.5)		28.8 (732)	57.5 (1460)	4.7 (120)	62.2 (1581)	24.8 (630)	29.2 (742)	11.3 (287)	13.6 (345)	7.9 (200)	945 (429)	593 (269)	D
	CRE 5-6	3	UL	2 (1.5)		28.8 (732)	57.5 (1460)	4.7 (120)	62.2 (1581)	24.8 (630)	29.2 (742)	11.3 (287)	13.6 (345)	7.9 (200)	948 (430)	595 (270)	D
	CRE 5-9	3	UK	3 (2.2)		35.4 (900)	57.5 (1460)	4.7 (120)	62.2 (1581)	24.8 (630)	29.2 (742)	11.3 (287)	13.6 (345)	7.9 (200)	1064 (483)	712 (323)	D
	CRE 5-9	3	UL	3 (2.2)		33.1 (841)	57.5 (1460)	4.7 (120)	62.2 (1581)	24.8 (630)	29.2 (742)	11.3 (287)	13.6 (345)	7.9 (200)	1025 (465)	672 (305)	D
6	CRE 5-4	1	UJ	1.5 (1.1)	4" Class 150	24.3 (618)	57.5 (1460)	4.7 (120)	75 (1906)	24.8 (630)	34.1 (865)	11.4 (289)	13.7 (347)	7.9 (200)	1060 (481)	663 (301)	D
	CRE 5-4	3	UK	1.5 (1.1)		25.9 (658)	57.5 (1460)	4.7 (120)	75 (1906)	24.8 (630)	34.1 (865)	11.4 (289)	13.7 (347)	7.9 (200)	1084 (492)	688 (312)	D
	CRE 5-4	3	UL	1.5 (1.1)		25.9 (658)	57.5 (1460)	4.7 (120)	75 (1906)	24.8 (630)	34.1 (865)	11.4 (289)	13.7 (347)	7.9 (200)	1084 (492)	688 (312)	D
	CRE 5-5	1	UJ	2 (1.5)		26.2 (665)	57.5 (1460)	4.7 (120)	75 (1906)	24.8 (630)	34.1 (865)	11.4 (289)	13.7 (347)	7.9 (200)	1091 (495)	694 (315)	D
	CRE 5-6	3	UK	2 (1.5)		28.8 (732)	57.5 (1460)	4.7 (120)	75 (1906)	24.8 (630)	34.1 (865)	11.4 (289)	13.7 (347)	7.9 (200)	1122 (509)	725 (329)	D
	CRE 5-6	3	UL	2 (1.5)		28.8 (732)	57.5 (1460)	4.7 (120)	75 (1906)	24.8 (630)	34.1 (865)	11.4 (289)	13.7 (347)	7.9 (200)	1124 (510)	727 (330)	D
	CRE 5-9	3	UK	3 (2.2)		35.4 (900)	57.5 (1460)	4.7 (120)	75 (1906)	24.8 (630)	34.1 (865)	11.4 (289)	13.7 (347)	7.9 (200)	1265 (574)	868 (394)	D
	CRE 5-9	3	UL	3 (2.2)		33.1 (841)	57.5 (1460)	4.7 (120)	75 (1906)	24.8 (630)	34.1 (865)	11.4 (289)	13.7 (347)	7.9 (200)	1216 (552)	820 (372)	D

Dimensions may vary by ± 0.5 inch (12.7 mm).

Hydro MPC-E with CR, CRE 10

Hydro MPC-E with CR 10

Number of pumps	Pump type	Mains phases	Voltage code	Motor power [hp (kW)]	Connection size	A [in (mm)]	A1 [in (mm)]	A2 [in (mm)]	B [in (mm)]	B1 [in (mm)]	C [in (mm)]	C1 [in (mm)]	C2 [in (mm)]	C3 [in (mm)]	Gross weight [lbs (kg)]	Net weight [lbs (kg)]	Design
2	CR 10-2	3	UK	1.5 (1.1)	NPT 2 1/2"	29.7 (755)	59.1 (1500)	6.3 (160)	26.7 (678)	35.4 (900)	39.2 (995)	16.5 (418)	19.1 (486)	15.7 (400)	904 (410)	619 (281)	C
	CR 10-2	3	UL	1.5 (1.1)		29.7 (755)	59.1 (1500)	6.3 (160)	26.7 (678)	35.4 (900)	39.2 (995)	16.5 (418)	19.1 (486)	15.7 (400)	904 (410)	619 (281)	C
	CR 10-4	3	UK	3 (2.2)		34.8 (885)	59.1 (1500)	6.3 (160)	26.7 (678)	35.4 (900)	39.2 (995)	16.5 (418)	19.1 (486)	15.7 (400)	1009 (458)	725 (329)	C
	CR 10-4	3	UL	3 (2.2)		34.8 (885)	59.1 (1500)	6.3 (160)	26.7 (678)	35.4 (900)	39.2 (995)	16.5 (418)	19.1 (486)	15.7 (400)	1009 (458)	725 (329)	C
	CR 10-6	3	UK	5 (3.7)		38.8 (985)	59.1 (1500)	6.3 (160)	26.7 (678)	35.4 (900)	39.2 (995)	16.5 (418)	19.1 (486)	15.7 (400)	1058 (480)	774 (351)	C
	CR 10-6	3	UL	5 (3.7)		38.8 (985)	59.1 (1500)	6.3 (160)	26.7 (678)	35.4 (900)	39.2 (995)	16.5 (418)	19.1 (486)	15.7 (400)	1045 (474)	760 (345)	C
	CR 10-8	3	UK	7.5 (5.5)		43.1 (1096)	59.1 (1500)	6.3 (160)	26.7 (678)	35.4 (900)	39.2 (995)	16.5 (418)	19.1 (486)	15.7 (400)	1212 (550)	928 (421)	C
	CR 10-8	3	UL	7.5 (5.5)		43.1 (1096)	59.1 (1500)	6.3 (160)	26.7 (678)	35.4 (900)	39.2 (995)	16.5 (418)	19.1 (486)	15.7 (400)	1174 (533)	890 (404)	C
	CR 10-10	3	UK	7.5 (5.5)		45.5 (1156)	59.1 (1500)	6.3 (160)	26.7 (678)	35.4 (900)	39.2 (995)	16.5 (418)	19.1 (486)	15.7 (400)	1221 (554)	937 (425)	C
	CR 10-10	3	UL	7.5 (5.5)		45.5 (1156)	59.1 (1500)	6.3 (160)	26.7 (678)	35.4 (900)	39.2 (995)	16.5 (418)	19.1 (486)	15.7 (400)	1183 (537)	899 (408)	C
3	CR 10-2	3	UK	1.5 (1.1)	NPT 3"	29.7 (755)	59.1 (1500)	6.3 (160)	39.4 (1001)	35.4 (900)	40 (1015)	16.5 (418)	19.2 (487)	15.7 (400)	1097 (498)	800 (363)	C
	CR 10-2	3	UL	1.5 (1.1)		29.7 (755)	59.1 (1500)	6.3 (160)	39.4 (1001)	35.4 (900)	40 (1015)	16.5 (418)	19.2 (487)	15.7 (400)	1097 (498)	800 (363)	C
	CR 10-4	3	UK	3 (2.2)		34.8 (885)	59.1 (1500)	6.3 (160)	39.4 (1001)	35.4 (900)	40 (1015)	16.5 (418)	19.2 (487)	15.7 (400)	1258 (571)	961 (436)	C
	CR 10-4	3	UL	3 (2.2)		34.8 (885)	59.1 (1500)	6.3 (160)	39.4 (1001)	35.4 (900)	40 (1015)	16.5 (418)	19.2 (487)	15.7 (400)	1256 (570)	959 (435)	C
	CR 10-6	3	UK	5 (3.7)		38.8 (985)	59.1 (1500)	6.3 (160)	39.4 (1001)	35.4 (900)	40 (1015)	16.5 (418)	19.2 (487)	15.7 (400)	1331 (604)	1033 (469)	C
	CR 10-6	3	UL	5 (3.7)		38.8 (985)	59.1 (1500)	6.3 (160)	39.4 (1001)	35.4 (900)	40 (1015)	16.5 (418)	19.2 (487)	15.7 (400)	1309 (594)	1011 (459)	C
	CR 10-8	3	UK	7.5 (5.5)		43.1 (1096)	74.8 (1900)	6.3 (160)	39.4 (1001)	47.2 (1200)	40 (1015)	16.5 (418)	19.2 (487)	19.7 (500)	1564 (710)	1267 (575)	C
	CR 10-8	3	UL	7.5 (5.5)		43.1 (1096)	59.1 (1500)	6.3 (160)	39.4 (1001)	35.4 (900)	40 (1015)	16.5 (418)	19.2 (487)	15.7 (400)	1511 (686)	1214 (551)	C
	CR 10-10	3	UK	7.5 (5.5)		45.5 (1156)	74.8 (1900)	6.3 (160)	39.4 (1001)	47.2 (1200)	40 (1015)	16.5 (418)	19.2 (487)	19.7 (500)	1578 (716)	1280 (581)	C
	CR 10-10	3	UL	7.5 (5.5)		45.5 (1156)	59.1 (1500)	6.3 (160)	39.4 (1001)	35.4 (900)	40 (1015)	16.5 (418)	19.2 (487)	15.7 (400)	1525 (692)	1227 (557)	C

Number of pumps	Pump type	Mains phases	Voltage code	Motor power [hp (kW)]	Connection size	A [in (mm)]	A1 [in (mm)]	A2 [in (mm)]	B [in (mm)]	B1 [in (mm)]	C [in (mm)]	C1 [in (mm)]	C2 [in (mm)]	C3 [in (mm)]	Gross weight [lbs (kg)]	Net weight [lbs (kg)]	Design
4	CR 10-2	3	UK	1.5 (1.1)	4" Class 150	29.7 (755)	59.1 (1500)	6.3 (160)	52.2 (1326)	35.4 (900)	44.7 (1136)	16.5 (419)	19.2 (488)	15.7 (400)	1370 (622)	1018 (462)	C
	CR 10-2	3	UL	1.5 (1.1)		29.7 (755)	59.1 (1500)	6.3 (160)	52.2 (1326)	35.4 (900)	44.7 (1136)	16.5 (419)	19.2 (488)	15.7 (400)	1370 (622)	1018 (462)	C
	CR 10-4	3	UK	3 (2.2)		34.8 (885)	59.1 (1500)	6.3 (160)	52.2 (1326)	35.4 (900)	44.7 (1136)	16.5 (419)	19.2 (488)	15.7 (400)	1589 (721)	1236 (561)	C
	CR 10-4	3	UL	3 (2.2)		34.8 (885)	59.1 (1500)	6.3 (160)	52.2 (1326)	35.4 (900)	44.7 (1136)	16.5 (419)	19.2 (488)	15.7 (400)	1582 (718)	1230 (558)	C
	CR 10-6	3	UK	5 (3.7)		38.8 (985)	59.1 (1500)	6.3 (160)	52.2 (1326)	35.4 (900)	44.7 (1136)	16.5 (419)	19.2 (488)	15.7 (400)	1685 (765)	1333 (605)	C
	CR 10-6	3	UL	5 (3.7)		38.8 (985)	59.1 (1500)	6.3 (160)	52.2 (1326)	35.4 (900)	44.7 (1136)	16.5 (419)	19.2 (488)	15.7 (400)	1659 (753)	1307 (593)	C
	CR 10-8	3	UK	7.5 (5.5)		43.1 (1096)	74.8 (1900)	6.3 (160)	52.2 (1326)	47.2 (1200)	44.7 (1136)	16.5 (419)	19.2 (488)	19.7 (500)	2038 (925)	1646 (747)	C
	CR 10-8	3	UL	7.5 (5.5)		43.1 (1096)	59.1 (1500)	6.3 (160)	52.2 (1326)	35.4 (900)	44.7 (1136)	16.5 (419)	19.2 (488)	15.7 (400)	1921 (872)	1569 (712)	C
	CR 10-10	3	UK	7.5 (5.5)		45.5 (1156)	74.8 (1900)	6.3 (160)	52.2 (1326)	47.2 (1200)	44.7 (1136)	16.5 (419)	19.2 (488)	19.7 (500)	2056 (933)	1663 (755)	C
	CR 10-10	3	UL	7.5 (5.5)		45.5 (1156)	59.1 (1500)	6.3 (160)	52.2 (1326)	35.4 (900)	44.7 (1136)	16.5 (419)	19.2 (488)	15.7 (400)	1939 (880)	1586 (720)	C
5	CR 10-2	3	UK	1.5 (1.1)	4" Class 150	29.7 (755)	74.8 (1900)	6.3 (160)	64.8 (1646)	47.2 (1200)	44.7 (1136)	16.5 (419)	19.2 (488)	19.7 (500)	1624 (737)	1214 (551)	C
	CR 10-2	3	UL	1.5 (1.1)		29.7 (755)	74.8 (1900)	6.3 (160)	64.8 (1646)	47.2 (1200)	44.7 (1136)	16.5 (419)	19.2 (488)	19.7 (500)	1622 (736)	1212 (550)	C
	CR 10-4	3	UK	3 (2.2)		34.8 (885)	74.8 (1900)	6.3 (160)	64.8 (1646)	47.2 (1200)	44.7 (1136)	16.5 (419)	19.2 (488)	19.7 (500)	1893 (859)	1483 (673)	C
	CR 10-4	3	UL	3 (2.2)		34.8 (885)	74.8 (1900)	6.3 (160)	64.8 (1646)	47.2 (1200)	44.7 (1136)	16.5 (419)	19.2 (488)	19.7 (500)	1890 (858)	1481 (672)	C
	CR 10-6	3	UK	5 (3.7)		38.8 (985)	74.8 (1900)	6.3 (160)	64.8 (1646)	47.2 (1200)	44.7 (1136)	16.5 (419)	19.2 (488)	19.7 (500)	2014 (914)	1604 (728)	C
	CR 10-6	3	UL	5 (3.7)		38.8 (985)	74.8 (1900)	6.3 (160)	64.8 (1646)	47.2 (1200)	44.7 (1136)	16.5 (419)	19.2 (488)	19.7 (500)	1978 (898)	1569 (712)	C
	CR 10-8	3	UK	7.5 (5.5)		43.1 (1096)	82.7 (2100)	6.3 (160)	64.8 (1646)	63 (1600)	44.7 (1136)	16.5 (419)	19.2 (488)	19.7 (500)	2723 (1236)	2243 (1018)	C
	CR 10-8	3	UL	7.5 (5.5)		43.1 (1096)	74.8 (1900)	6.3 (160)	64.8 (1646)	47.2 (1200)	44.7 (1136)	16.5 (419)	19.2 (488)	19.7 (500)	2313 (1050)	1904 (864)	C
	CR 10-10	3	UK	7.5 (5.5)		45.5 (1156)	82.7 (2100)	6.3 (160)	64.8 (1646)	63 (1600)	44.7 (1136)	16.5 (419)	19.2 (488)	19.7 (500)	2745 (1246)	2265 (1028)	C
	CR 10-10	3	UL	7.5 (5.5)		45.5 (1156)	74.8 (1900)	6.3 (160)	64.8 (1646)	47.2 (1200)	44.7 (1136)	16.5 (419)	19.2 (488)	19.7 (500)	2335 (1060)	1926 (874)	C

Number of pumps	Pump type	Mains phases	Voltage code	Motor power [hp (kW)]	Connection size	A [in (mm)]	A1 [in (mm)]	A2 [in (mm)]	B [in (mm)]	B1 [in (mm)]	C [in (mm)]	C1 [in (mm)]	C2 [in (mm)]	C3 [in (mm)]	Gross weight [lbs (kg)]	Net weight [lbs (kg)]	Design
6	CR 10-2	3	UK	1.5 (1.1)	6" Class 150	29.7 (755)	74.8 (1900)	6.3 (160)	77.4 (1967)	47.2 (1200)	48.9 (1242)	17.6 (447)	20.3 (516)	19.7 (500)	1877 (852)	1439 (653)	C
	CR 10-2	3	UL	1.5 (1.1)		29.7 (755)	74.8 (1900)	6.3 (160)	77.4 (1967)	47.2 (1200)	48.9 (1242)	17.6 (447)	20.3 (516)	19.7 (500)	1875 (851)	1437 (652)	C
	CR 10-4	3	UK	3 (2.2)		34.8 (885)	74.8 (1900)	6.3 (160)	77.4 (1967)	47.2 (1200)	48.9 (1242)	17.6 (447)	20.3 (516)	19.7 (500)	2199 (998)	1760 (799)	C
	CR 10-4	3	UL	3 (2.2)		34.8 (885)	74.8 (1900)	6.3 (160)	77.4 (1967)	47.2 (1200)	48.9 (1242)	17.6 (447)	20.3 (516)	19.7 (500)	2199 (998)	1760 (799)	C
	CR 10-6	3	UK	5 (3.7)		38.8 (985)	74.8 (1900)	6.3 (160)	77.4 (1967)	47.2 (1200)	48.9 (1242)	17.6 (447)	20.3 (516)	19.7 (500)	2348 (1066)	1910 (867)	C
	CR 10-6	3	UL	5 (3.7)		38.8 (985)	74.8 (1900)	6.3 (160)	77.4 (1967)	47.2 (1200)	48.9 (1242)	17.6 (447)	20.3 (516)	19.7 (500)	2304 (1046)	1866 (847)	C
	CR 10-8	3	UK	7.5 (5.5)		43.1 (1096)	82.7 (2100)	6.3 (160)	77.4 (1967)	63 (1600)	48.9 (1242)	17.6 (447)	20.3 (516)	19.7 (500)	3190 (1448)	2617 (1188)	C
	CR 10-8	3	UL	7.5 (5.5)		43.1 (1096)	74.8 (1900)	6.3 (160)	77.4 (1967)	47.2 (1200)	48.9 (1242)	17.6 (447)	20.3 (516)	19.7 (500)	2703 (1227)	2265 (1028)	C
	CR 10-10	3	UK	7.5 (5.5)		45.5 (1156)	82.7 (2100)	6.3 (160)	77.4 (1967)	63 (1600)	48.9 (1242)	17.6 (447)	20.3 (516)	19.7 (500)	3216 (1460)	2644 (1200)	C
	CR 10-10	3	UL	7.5 (5.5)		45.5 (1156)	74.8 (1900)	6.3 (160)	77.4 (1967)	47.2 (1200)	48.9 (1242)	17.6 (447)	20.3 (516)	19.7 (500)	2730 (1239)	2291 (1040)	C

Dimensions may vary by ± 0.5 inch (12.7 mm).

Hydro MPC-E with CRE 10

Number of pumps	Pump type	Mains phases	Voltage code	Motor power [hp (kW)]	Connection size	A [in (mm)]	A1 [in (mm)]	A2 [in (mm)]	B [in (mm)]	B1 [in (mm)]	C [in (mm)]	C1 [in (mm)]	C2 [in (mm)]	C3 [in (mm)]	Gross weight [lbs (kg)]	Net weight [lbs (kg)]	Design
2	CRE 10-2	1	UJ	2 (1.5)	NPT 2 1/2"	27.3 (693)	57.5 (1460)	6.3 (160)	26.7 (678)	24.8 (630)	39.2 (995)	16.5 (418)	19.1 (486)	7.9 (200)	644 (292)	423 (192)	D
	CRE 10-2	3	UK	1.5 (1.1)		28.1 (713)	57.5 (1460)	6.3 (160)	26.7 (678)	24.8 (630)	39.2 (995)	16.5 (418)	19.1 (486)	7.9 (200)	644 (292)	423 (192)	D
	CRE 10-2	3	UL	1.5 (1.1)		28.1 (713)	57.5 (1460)	6.3 (160)	26.7 (678)	24.8 (630)	39.2 (995)	16.5 (418)	19.1 (486)	7.9 (200)	644 (292)	423 (192)	D
	CRE 10-4	3	UK	3 (2.2)		34.3 (871)	57.5 (1460)	6.3 (160)	26.7 (678)	24.8 (630)	39.2 (995)	16.5 (418)	19.1 (486)	7.9 (200)	719 (326)	498 (226)	D
	CRE 10-4	3	UL	3 (2.2)		32 (812)	57.5 (1460)	6.3 (160)	26.7 (678)	24.8 (630)	39.2 (995)	16.5 (418)	19.1 (486)	7.9 (200)	701 (318)	481 (218)	D
	CRE 10-6	3	UK	5 (3.7)		36.7 (931)	57.5 (1460)	6.3 (160)	26.7 (678)	24.8 (630)	39.2 (995)	16.5 (418)	19.1 (486)	7.9 (200)	758 (344)	538 (244)	D
	CRE 10-6	3	UL	5 (3.7)		36.7 (931)	57.5 (1460)	6.3 (160)	26.7 (678)	24.8 (630)	39.2 (995)	16.5 (418)	19.1 (486)	7.9 (200)	763 (346)	542 (246)	D
	CRE 10-8	3	UK	7.5 (5.5)		41.5 (1054)	57.5 (1460)	6.3 (160)	40.1 (1018)	24.8 (630)	39.2 (995)	16.5 (418)	19.1 (486)	7.9 (200)	848 (385)	628 (285)	D
	CRE 10-8	3	UL	7.5 (5.5)		40.6 (1030)	57.5 (1460)	6.3 (160)	26.7 (678)	24.8 (630)	39.2 (995)	16.5 (418)	19.1 (486)	7.9 (200)	815 (370)	595 (270)	D
	CRE 10-10	3	UK	7.5 (5.5)		43.9 (1114)	57.5 (1460)	6.3 (160)	40.1 (1018)	24.8 (630)	39.2 (995)	16.5 (418)	19.1 (486)	7.9 (200)	857 (389)	637 (289)	D
CRE 10-10	3	UL	7.5 (5.5)	42.9 (1090)	57.5 (1460)	6.3 (160)	26.7 (678)	24.8 (630)	39.2 (995)	16.5 (418)	19.1 (486)	7.9 (200)	824 (374)	604 (274)	D		
3	CRE 10-2	1	UJ	2 (1.5)	NPT 3"	27.3 (693)	57.5 (1460)	6.3 (160)	39.4 (1001)	24.8 (630)	40 (1015)	16.5 (418)	19.2 (487)	7.9 (200)	882 (400)	584 (265)	D
	CRE 10-2	3	UK	1.5 (1.1)		28.1 (713)	57.5 (1460)	6.3 (160)	39.4 (1001)	24.8 (630)	40 (1015)	16.5 (418)	19.2 (487)	7.9 (200)	879 (399)	582 (264)	D
	CRE 10-2	3	UL	1.5 (1.1)		28.1 (713)	57.5 (1460)	6.3 (160)	39.4 (1001)	24.8 (630)	40 (1015)	16.5 (418)	19.2 (487)	7.9 (200)	879 (399)	582 (264)	D
	CRE 10-4	3	UK	3 (2.2)		34.3 (871)	57.5 (1460)	6.3 (160)	39.4 (1001)	24.8 (630)	40 (1015)	16.5 (418)	19.2 (487)	7.9 (200)	992 (450)	694 (315)	D
	CRE 10-4	3	UL	3 (2.2)		32 (812)	57.5 (1460)	6.3 (160)	39.4 (1001)	24.8 (630)	40 (1015)	16.5 (418)	19.2 (487)	7.9 (200)	965 (438)	668 (303)	D
	CRE 10-6	3	UK	5 (3.7)		36.7 (931)	57.5 (1460)	6.3 (160)	39.4 (1001)	24.8 (630)	40 (1015)	16.5 (418)	19.2 (487)	7.9 (200)	1053 (478)	756 (343)	D
	CRE 10-6	3	UL	5 (3.7)		36.7 (931)	57.5 (1460)	6.3 (160)	39.4 (1001)	24.8 (630)	40 (1015)	16.5 (418)	19.2 (487)	7.9 (200)	1058 (480)	760 (345)	D
	CRE 10-8	3	UK	7.5 (5.5)		41.5 (1054)	57.5 (1460)	6.3 (160)	59.9 (1521)	24.8 (630)	40 (1015)	16.5 (418)	19.2 (487)	7.9 (200)	1192 (541)	895 (406)	D
	CRE 10-8	3	UL	7.5 (5.5)		40.6 (1030)	57.5 (1460)	6.3 (160)	39.4 (1001)	24.8 (630)	40 (1015)	16.5 (418)	19.2 (487)	7.9 (200)	1137 (516)	840 (381)	D
	CRE 10-10	3	UK	7.5 (5.5)		43.9 (1114)	57.5 (1460)	6.3 (160)	59.9 (1521)	24.8 (630)	40 (1015)	16.5 (418)	19.2 (487)	7.9 (200)	1205 (547)	908 (412)	D
CRE 10-10	3	UL	7.5 (5.5)	42.9 (1090)	57.5 (1460)	6.3 (160)	39.4 (1001)	24.8 (630)	40 (1015)	16.5 (418)	19.2 (487)	7.9 (200)	1150 (522)	853 (387)	D		

Number of pumps	Pump type	Mains phases	Voltage code	Motor power [hp (kW)]	Connection size	A [in (mm)]	A1 [in (mm)]	A2 [in (mm)]	B [in (mm)]	B1 [in (mm)]	C [in (mm)]	C1 [in (mm)]	C2 [in (mm)]	C3 [in (mm)]	Gross weight [lbs (kg)]	Net weight [lbs (kg)]	Design
4	CRE 10-2	1	UJ	2 (1.5)	4" Class 150	27.3 (693)	57.5 (1460)	6.3 (160)	52.2 (1326)	24.8 (630)	44.7 (1136)	16.5 (419)	19.2 (488)	7.9 (200)	1130 (513)	778 (353)	D
	CRE 10-2	3	UK	1.5 (1.1)		28.1 (713)	57.5 (1460)	6.3 (160)	52.2 (1326)	24.8 (630)	44.7 (1136)	16.5 (419)	19.2 (488)	7.9 (200)	1133 (514)	780 (354)	D
	CRE 10-2	3	UL	1.5 (1.1)		28.1 (713)	57.5 (1460)	6.3 (160)	52.2 (1326)	24.8 (630)	44.7 (1136)	16.5 (419)	19.2 (488)	7.9 (200)	1133 (514)	780 (354)	D
	CRE 10-4	3	UK	3 (2.2)		34.3 (871)	57.5 (1460)	6.3 (160)	52.2 (1326)	24.8 (630)	44.7 (1136)	16.5 (419)	19.2 (488)	7.9 (200)	1282 (582)	930 (422)	D
	CRE 10-4	3	UL	3 (2.2)		32 (812)	57.5 (1460)	6.3 (160)	52.2 (1326)	24.8 (630)	44.7 (1136)	16.5 (419)	19.2 (488)	7.9 (200)	1247 (566)	895 (406)	D
	CRE 10-6	3	UK	5 (3.7)		36.7 (931)	57.5 (1460)	6.3 (160)	52.2 (1326)	24.8 (630)	44.7 (1136)	16.5 (419)	19.2 (488)	7.9 (200)	1368 (621)	1016 (461)	D
	CRE 10-6	3	UL	5 (3.7)		36.7 (931)	57.5 (1460)	6.3 (160)	52.2 (1326)	24.8 (630)	44.7 (1136)	16.5 (419)	19.2 (488)	7.9 (200)	1370 (622)	1018 (462)	D
	CRE 10-8	3	UK	7.5 (5.5)		41.5 (1054)	57.5 (1460)	6.3 (160)	79.8 (2026)	24.8 (630)	44.7 (1136)	16.5 (419)	19.2 (488)	7.9 (200)	1600 (726)	1203 (546)	D
	CRE 10-8	3	UL	7.5 (5.5)		40.6 (1030)	57.5 (1460)	6.3 (160)	52.2 (1326)	24.8 (630)	44.7 (1136)	16.5 (419)	19.2 (488)	7.9 (200)	1478 (671)	1126 (511)	D
	CRE 10-10	3	UK	7.5 (5.5)		43.9 (1114)	57.5 (1460)	6.3 (160)	79.8 (2026)	24.8 (630)	44.7 (1136)	16.5 (419)	19.2 (488)	7.9 (200)	1617 (734)	1221 (554)	D
CRE 10-10	3	UL	7.5 (5.5)	42.9 (1090)	57.5 (1460)	6.3 (160)	52.2 (1326)	24.8 (630)	44.7 (1136)	16.5 (419)	19.2 (488)	7.9 (200)	1496 (679)	1144 (519)	D		
5	CRE 10-2	1	UJ	2 (1.5)	4" Class 150	27.3 (693)	57.5 (1460)	6.3 (160)	64.8 (1646)	24.8 (630)	44.7 (1136)	16.5 (419)	19.2 (488)	7.9 (200)	1293 (587)	941 (427)	D
	CRE 10-2	3	UK	1.5 (1.1)		28.1 (713)	57.5 (1460)	6.3 (160)	64.8 (1646)	24.8 (630)	44.7 (1136)	16.5 (419)	19.2 (488)	7.9 (200)	1296 (588)	943 (428)	D
	CRE 10-2	3	UL	1.5 (1.1)		28.1 (713)	57.5 (1460)	6.3 (160)	64.8 (1646)	24.8 (630)	44.7 (1136)	16.5 (419)	19.2 (488)	7.9 (200)	1296 (588)	943 (428)	D
	CRE 10-4	3	UK	3 (2.2)		34.3 (871)	57.5 (1460)	6.3 (160)	64.8 (1646)	24.8 (630)	44.7 (1136)	16.5 (419)	19.2 (488)	7.9 (200)	1483 (673)	1130 (513)	D
	CRE 10-4	3	UL	3 (2.2)		32 (812)	57.5 (1460)	6.3 (160)	64.8 (1646)	24.8 (630)	44.7 (1136)	16.5 (419)	19.2 (488)	7.9 (200)	1439 (653)	1086 (493)	D
	CRE 10-6	3	UK	5 (3.7)		36.7 (931)	57.5 (1460)	6.3 (160)	64.8 (1646)	24.8 (630)	44.7 (1136)	16.5 (419)	19.2 (488)	7.9 (200)	1611 (731)	1258 (571)	D
	CRE 10-6	3	UL	5 (3.7)		36.7 (931)	57.5 (1460)	6.3 (160)	64.8 (1646)	24.8 (630)	44.7 (1136)	16.5 (419)	19.2 (488)	7.9 (200)	1593 (723)	1241 (563)	D
	CRE 10-8	3	UK	7.5 (5.5)		41.5 (1054)	57.5 (1460)	6.3 (160)	99.4 (2526)	24.8 (630)	44.7 (1136)	16.5 (419)	19.2 (488)	7.9 (200)	1912 (868)	1483 (673)	D
	CRE 10-8	3	UL	7.5 (5.5)		40.6 (1030)	57.5 (1460)	6.3 (160)	64.8 (1646)	24.8 (630)	44.7 (1136)	16.5 (419)	19.2 (488)	7.9 (200)	1747 (793)	1395 (633)	D
	CRE 10-10	3	UK	7.5 (5.5)		43.9 (1114)	57.5 (1460)	6.3 (160)	99.4 (2526)	24.8 (630)	44.7 (1136)	16.5 (419)	19.2 (488)	7.9 (200)	1934 (878)	1505 (683)	D
CRE 10-10	3	UL	7.5 (5.5)	42.9 (1090)	57.5 (1460)	6.3 (160)	64.8 (1646)	24.8 (630)	44.7 (1136)	16.5 (419)	19.2 (488)	7.9 (200)	1769 (803)	1417 (643)	D		

Number of pumps	Pump type	Mains phases	Voltage code	Motor power [hp (kW)]	Connection size	A [in (mm)]	A1 [in (mm)]	A2 [in (mm)]	B [in (mm)]	B1 [in (mm)]	C [in (mm)]	C1 [in (mm)]	C2 [in (mm)]	C3 [in (mm)]	Gross weight [lbs (kg)]	Net weight [lbs (kg)]	Design
6	CRE 10-2	1	UJ	2 (1.5)	6" Class 150	27.3 (693)	57.5 (1460)	6.3 (160)	77.4 (1967)	24.8 (630)	48.9 (1242)	17.6 (447)	20.3 (516)	7.9 (200)	1540 (699)	1144 (519)	D
	CRE 10-2	3	UK	1.5 (1.1)		28.1 (713)	57.5 (1460)	6.3 (160)	77.4 (1967)	24.8 (630)	48.9 (1242)	17.6 (447)	20.3 (516)	7.9 (200)	1542 (700)	1146 (520)	D
	CRE 10-2	3	UL	1.5 (1.1)		28.1 (713)	57.5 (1460)	6.3 (160)	77.4 (1967)	24.8 (630)	48.9 (1242)	17.6 (447)	20.3 (516)	7.9 (200)	1542 (700)	1146 (520)	D
	CRE 10-4	3	UK	3 (2.2)		34.3 (871)	57.5 (1460)	6.3 (160)	77.4 (1967)	24.8 (630)	48.9 (1242)	17.6 (447)	20.3 (516)	7.9 (200)	1767 (802)	1370 (622)	D
	CRE 10-4	3	UL	3 (2.2)		32 (812)	57.5 (1460)	6.3 (160)	77.4 (1967)	24.8 (630)	48.9 (1242)	17.6 (447)	20.3 (516)	7.9 (200)	1714 (778)	1318 (598)	D
	CRE 10-6	3	UK	5 (3.7)		36.7 (931)	57.5 (1460)	6.3 (160)	77.4 (1967)	24.8 (630)	48.9 (1242)	17.6 (447)	20.3 (516)	7.9 (200)	1923 (873)	1527 (693)	D
	CRE 10-6	3	UL	5 (3.7)		36.7 (931)	57.5 (1460)	6.3 (160)	77.4 (1967)	24.8 (630)	48.9 (1242)	17.6 (447)	20.3 (516)	7.9 (200)	1899 (862)	1503 (682)	D
	CRE 10-8	3	UK	7.5 (5.5)		41.5 (1054)	57.5 (1460)	6.3 (160)	119.2 (3027)	24.8 (630)	48.9 (1242)	17.6 (447)	20.3 (516)	7.9 (200)	2492 (1131)	1855 (842)	D
	CRE 10-8	3	UL	7.5 (5.5)		40.6 (1030)	57.5 (1460)	6.3 (160)	77.4 (1967)	24.8 (630)	48.9 (1242)	17.6 (447)	20.3 (516)	7.9 (200)	2089 (948)	1692 (768)	D
	CRE 10-10	3	UK	7.5 (5.5)		43.9 (1114)	57.5 (1460)	6.3 (160)	119.2 (3027)	24.8 (630)	48.9 (1242)	17.6 (447)	20.3 (516)	7.9 (200)	2518 (1143)	1882 (854)	D
CRE 10-10	3	UL	7.5 (5.5)	42.9 (1090)	57.5 (1460)	6.3 (160)	77.4 (1967)	24.8 (630)	48.9 (1242)	17.6 (447)	20.3 (516)	7.9 (200)	2115 (960)	1719 (780)	D		

Dimensions may vary by ± 0.5 inch (12.7 mm).

Hydro MPC-E with CR, CRE 15

Hydro MPC-E with CR 15

Number of pumps	Pump type	Mains phases	Voltage code	Motor power [hp (kW)]	Connection size	A [in (mm)]	A1 [in (mm)]	A2 [in (mm)]	B [in (mm)]	B1 [in (mm)]	C [in (mm)]	C1 [in (mm)]	C2 [in (mm)]	C3 [in (mm)]	Gross weight [lbs (kg)]	Net weight [lbs (kg)]	Design
2	CR 15-2	3	UK	5 (3.7)	4" Class 150	35.2 (895)	59.1 (1500)	6.3 (160)	29.4 (746)	35.4 (900)	44.8 (1138)	16.5 (420)	19.3 (489)	15.7 (400)	1078 (489)	793 (360)	C
	CR 15-2	3	UL	5 (3.7)		35.2 (895)	59.1 (1500)	6.3 (160)	29.4 (746)	35.4 (900)	44.8 (1138)	16.5 (420)	19.3 (489)	15.7 (400)	1067 (484)	782 (355)	C
	CR 15-3	3	UK	7.5 (5.5)		39 (991)	59.1 (1500)	6.3 (160)	29.4 (746)	35.4 (900)	44.8 (1138)	16.5 (420)	19.3 (489)	15.7 (400)	1227 (557)	943 (428)	C
	CR 15-3	3	UL	7.5 (5.5)		39 (991)	59.1 (1500)	6.3 (160)	29.4 (746)	35.4 (900)	44.8 (1138)	16.5 (420)	19.3 (489)	15.7 (400)	1192 (541)	908 (412)	C
	CR 15-4	3	UK	7.5 (5.5)		40.8 (1036)	59.1 (1500)	6.3 (160)	29.4 (746)	35.4 (900)	44.8 (1138)	16.5 (420)	19.3 (489)	15.7 (400)	1236 (561)	952 (432)	C
	CR 15-4	3	UL	7.5 (5.5)		40.8 (1036)	59.1 (1500)	6.3 (160)	29.4 (746)	35.4 (900)	44.8 (1138)	16.5 (420)	19.3 (489)	15.7 (400)	1201 (545)	917 (416)	C
	CR 15-5	3	UL	10 (7.5)		44.4 (1128)	59.1 (1500)	6.3 (160)	29.4 (746)	35.4 (900)	44.8 (1138)	16.5 (420)	19.3 (489)	15.7 (400)	1271 (577)	987 (448)	C
	CR 15-7	3	UL	15 (11)		51.9 (1319)	59.1 (1500)	7.9 (200)	40.4 (1026)	35.4 (900)	44.8 (1138)	16.5 (420)	19.3 (489)	15.7 (400)	1377 (625)	1093 (496)	C
3	CR 15-2	3	UK	5 (3.7)	4" Class 150	35.2 (895)	59.1 (1500)	6.3 (160)	42 (1066)	35.4 (900)	44.8 (1138)	16.5 (420)	19.3 (489)	15.7 (400)	1340 (608)	1042 (473)	C
	CR 15-2	3	UL	5 (3.7)		35.2 (895)	59.1 (1500)	6.3 (160)	42 (1066)	35.4 (900)	44.8 (1138)	16.5 (420)	19.3 (489)	15.7 (400)	1320 (599)	1022 (464)	C
	CR 15-3	3	UK	7.5 (5.5)		39 (991)	74.8 (1900)	6.3 (160)	42 (1066)	47.2 (1200)	44.8 (1138)	16.5 (420)	19.3 (489)	19.7 (500)	1567 (711)	1269 (576)	C
	CR 15-3	3	UL	7.5 (5.5)		39 (991)	59.1 (1500)	6.3 (160)	42 (1066)	35.4 (900)	44.8 (1138)	16.5 (420)	19.3 (489)	15.7 (400)	1516 (688)	1219 (553)	C
	CR 15-4	3	UK	7.5 (5.5)		40.8 (1036)	74.8 (1900)	6.3 (160)	42 (1066)	47.2 (1200)	44.8 (1138)	16.5 (420)	19.3 (489)	19.7 (500)	1580 (717)	1282 (582)	C
	CR 15-4	3	UL	7.5 (5.5)		40.8 (1036)	59.1 (1500)	6.3 (160)	42 (1066)	35.4 (900)	44.8 (1138)	16.5 (420)	19.3 (489)	15.7 (400)	1529 (694)	1232 (559)	C
	CR 15-5	3	UL	10 (7.5)		44.4 (1128)	59.1 (1500)	6.3 (160)	42 (1066)	35.4 (900)	44.8 (1138)	16.5 (420)	19.3 (489)	15.7 (400)	1628 (739)	1331 (604)	C
	CR 15-7	3	UL	15 (11)		51.9 (1319)	74.8 (1900)	7.9 (200)	60.1 (1526)	47.2 (1200)	44.8 (1138)	16.5 (420)	19.3 (489)	19.7 (500)	1895 (860)	1503 (682)	C
4	CR 15-2	3	UK	5 (3.7)	6" Class 150	35.2 (895)	59.1 (1500)	6.3 (160)	54.6 (1387)	35.4 (900)	46.9 (1190)	16.6 (421)	19.3 (490)	15.7 (400)	1692 (768)	1340 (608)	C
	CR 15-2	3	UL	5 (3.7)		35.2 (895)	59.1 (1500)	6.3 (160)	54.6 (1387)	35.4 (900)	46.9 (1190)	16.6 (421)	19.3 (490)	15.7 (400)	1668 (757)	1315 (597)	C
	CR 15-3	3	UK	7.5 (5.5)		39 (991)	74.8 (1900)	6.3 (160)	54.6 (1387)	47.2 (1200)	46.9 (1190)	16.6 (421)	19.3 (490)	19.7 (500)	2036 (924)	1644 (746)	C
	CR 15-3	3	UL	7.5 (5.5)		39 (991)	59.1 (1500)	6.3 (160)	54.6 (1387)	35.4 (900)	46.9 (1190)	16.6 (421)	19.3 (490)	15.7 (400)	1921 (872)	1569 (712)	C
	CR 15-4	3	UK	7.5 (5.5)		40.8 (1036)	74.8 (1900)	6.3 (160)	54.6 (1387)	47.2 (1200)	46.9 (1190)	16.6 (421)	19.3 (490)	19.7 (500)	2053 (932)	1661 (754)	C
	CR 15-4	3	UL	7.5 (5.5)		40.8 (1036)	59.1 (1500)	6.3 (160)	54.6 (1387)	35.4 (900)	46.9 (1190)	16.6 (421)	19.3 (490)	15.7 (400)	1939 (880)	1586 (720)	C
	CR 15-5	3	UL	10 (7.5)		44.4 (1128)	59.1 (1500)	6.3 (160)	54.6 (1387)	35.4 (900)	46.9 (1190)	16.6 (421)	19.3 (490)	15.7 (400)	2078 (943)	1725 (783)	C
	CR 15-7	3	UL	15 (11)		51.9 (1319)	74.8 (1900)	7.9 (200)	79.8 (2027)	47.2 (1200)	46.9 (1190)	16.6 (421)	19.3 (490)	19.7 (500)	2390 (1085)	1952 (886)	C

Number of pumps	Pump type	Mains phases	Voltage code	Motor power [hp (kW)]	Connection size	A [in (mm)]	A1 [in (mm)]	A2 [in (mm)]	B [in (mm)]	B1 [in (mm)]	C [in (mm)]	C1 [in (mm)]	C2 [in (mm)]	C3 [in (mm)]	Gross weight [lbs (kg)]	Net weight [lbs (kg)]	Design
5	CR 15-2	3	UK	5 (3.7)	6" Class 150	35.2 (895)	74.8 (1900)	6.3 (160)	67.2 (1707)	47.2 (1200)	46.9 (1190)	16.6 (421)	19.3 (490)	19.7 (500)	2016 (915)	1606 (729)	C
	CR 15-2	3	UL	5 (3.7)		35.2 (895)	74.8 (1900)	6.3 (160)	67.2 (1707)	47.2 (1200)	46.9 (1190)	16.6 (421)	19.3 (490)	19.7 (500)	1981 (899)	1571 (713)	C
	CR 15-3	3	UK	7.5 (5.5)		39 (991)	82.7 (2100)	6.3 (160)	67.2 (1707)	63 (1600)	46.9 (1190)	16.6 (421)	19.3 (490)	19.7 (500)	2714 (1232)	2234 (1014)	C
	CR 15-3	3	UL	7.5 (5.5)		39 (991)	74.8 (1900)	6.3 (160)	67.2 (1707)	47.2 (1200)	46.9 (1190)	16.6 (421)	19.3 (490)	19.7 (500)	2304 (1046)	1895 (860)	C
	CR 15-4	3	UK	7.5 (5.5)		40.8 (1036)	82.7 (2100)	6.3 (160)	67.2 (1707)	63 (1600)	46.9 (1190)	16.6 (421)	19.3 (490)	19.7 (500)	2736 (1242)	2256 (1024)	C
	CR 15-4	3	UL	7.5 (5.5)		40.8 (1036)	74.8 (1900)	6.3 (160)	67.2 (1707)	47.2 (1200)	46.9 (1190)	16.6 (421)	19.3 (490)	19.7 (500)	2326 (1056)	1917 (870)	C
	CR 15-5	3	UL	10 (7.5)		44.4 (1128)	74.8 (1900)	6.3 (160)	67.2 (1707)	47.2 (1200)	46.9 (1190)	16.6 (421)	19.3 (490)	19.7 (500)	2492 (1131)	2082 (945)	C
	CR 15-7	3	UL	15 (11)		51.9 (1319)	82.7 (2100)	7.9 (200)	99.5 (2527)	63 (1600)	46.9 (1190)	16.6 (421)	19.3 (490)	19.7 (500)	3313 (1504)	2668 (1211)	C
6	CR 15-2	3	UK	5 (3.7)	6" Class 150	35.2 (895)	74.8 (1900)	6.3 (160)	79.8 (2027)	47.2 (1200)	46.9 (1190)	16.6 (421)	19.3 (490)	19.7 (500)	2304 (1046)	1866 (847)	C
	CR 15-2	3	UL	5 (3.7)		35.2 (895)	74.8 (1900)	6.3 (160)	79.8 (2027)	47.2 (1200)	46.9 (1190)	16.6 (421)	19.3 (490)	19.7 (500)	2258 (1025)	1820 (826)	C
	CR 15-3	3	UK	7.5 (5.5)		39 (991)	82.7 (2100)	6.3 (160)	79.8 (2027)	63 (1600)	46.9 (1190)	16.6 (421)	19.3 (490)	19.7 (500)	3133 (1422)	2560 (1162)	C
	CR 15-3	3	UL	7.5 (5.5)		39 (991)	74.8 (1900)	6.3 (160)	79.8 (2027)	47.2 (1200)	46.9 (1190)	16.6 (421)	19.3 (490)	19.7 (500)	2646 (1201)	2207 (1002)	C
	CR 15-4	3	UK	7.5 (5.5)		40.8 (1036)	82.7 (2100)	6.3 (160)	79.8 (2027)	63 (1600)	46.9 (1190)	16.6 (421)	19.3 (490)	19.7 (500)	3159 (1434)	2586 (1174)	C
	CR 15-4	3	UL	7.5 (5.5)		40.8 (1036)	74.8 (1900)	6.3 (160)	79.8 (2027)	47.2 (1200)	46.9 (1190)	16.6 (421)	19.3 (490)	19.7 (500)	2672 (1213)	2234 (1014)	C
	CR 15-5	3	UL	10 (7.5)		44.4 (1128)	74.8 (1900)	6.3 (160)	79.8 (2027)	47.2 (1200)	46.9 (1190)	16.6 (421)	19.3 (490)	19.7 (500)	2870 (1303)	2432 (1104)	C
	CR 15-7	3	UL	15 (11)		51.9 (1319)	82.7 (2100)	7.9 (200)	119.2 (3027)	63 (1600)	46.9 (1190)	16.6 (421)	19.3 (490)	19.7 (500)	3591 (1630)	3093 (1404)	C

Dimensions may vary by ± 0.5 inch (12.7 mm).

Hydro MPC-E with CRE 15

Number of pumps	Pump type	Mains phases	Voltage code	Motor power [hp (kW)]	Connection size	A [in (mm)]	A1 [in (mm)]	A2 [in (mm)]	B [in (mm)]	B1 [in (mm)]	C [in (mm)]	C1 [in (mm)]	C2 [in (mm)]	C3 [in (mm)]	Gross weight [lbs (kg)]	Net weight [lbs (kg)]	Design
2	CRE 15-1	1	UJ	2 (1.5)	4" Class 150	28.5 (723)	57.5 (1460)	6.3 (160)	29.4 (746)	24.8 (630)	44.8 (1138)	16.5 (420)	19.3 (489)	7.9 (200)	747 (339)	463 (210)	D
	CRE 15-2	3	UK	5 (3.7)		33.1 (841)	57.5 (1460)	6.3 (160)	29.4 (746)	24.8 (630)	44.8 (1138)	16.5 (420)	19.3 (489)	7.9 (200)	844 (383)	560 (254)	D
	CRE 15-2	3	UL	5 (3.7)		33.1 (841)	57.5 (1460)	6.3 (160)	29.4 (746)	24.8 (630)	44.8 (1138)	16.5 (420)	19.3 (489)	7.9 (200)	846 (384)	562 (255)	D
	CRE 15-3	3	UK	7.5 (5.5)		37.4 (949)	57.5 (1460)	6.3 (160)	40.4 (1026)	24.8 (630)	44.8 (1138)	16.5 (420)	19.3 (489)	7.9 (200)	930 (422)	646 (293)	D
	CRE 15-3	3	UL	7.5 (5.5)		36.4 (925)	57.5 (1460)	6.3 (160)	29.4 (746)	24.8 (630)	44.8 (1138)	16.5 (420)	19.3 (489)	7.9 (200)	895 (406)	611 (277)	D
	CRE 15-4	3	UK	7.5 (5.5)		39.1 (994)	57.5 (1460)	6.3 (160)	40.4 (1026)	24.8 (630)	44.8 (1138)	16.5 (420)	19.3 (489)	7.9 (200)	939 (426)	655 (297)	D
	CRE 15-4	3	UL	7.5 (5.5)		38.2 (970)	57.5 (1460)	6.3 (160)	29.4 (746)	24.8 (630)	44.8 (1138)	16.5 (420)	19.3 (489)	7.9 (200)	904 (410)	619 (281)	D
	CRE 15-5	3	UL	10 (7.5)		40.9 (1039)	57.5 (1460)	6.3 (160)	40.4 (1026)	24.8 (630)	44.8 (1138)	16.5 (420)	19.3 (489)	7.9 (200)	972 (441)	688 (312)	D
	CRE 15-7	3	UL	15 (11)		49.3 (1251)	57.5 (1460)	7.9 (200)	40.4 (1026)	24.8 (630)	44.8 (1138)	16.5 (420)	19.3 (489)	7.9 (200)	1062 (482)	778 (353)	D
3	CRE 15-1	1	UJ	2 (1.5)	4" Class 150	28.5 (723)	57.5 (1460)	6.3 (160)	42 (1066)	24.8 (630)	44.8 (1138)	16.5 (420)	19.3 (489)	7.9 (200)	919 (417)	622 (282)	D
	CRE 15-2	3	UK	5 (3.7)		33.1 (841)	57.5 (1460)	6.3 (160)	42 (1066)	24.8 (630)	44.8 (1138)	16.5 (420)	19.3 (489)	7.9 (200)	1064 (483)	767 (348)	D
	CRE 15-2	3	UL	5 (3.7)		33.1 (841)	57.5 (1460)	6.3 (160)	42 (1066)	24.8 (630)	44.8 (1138)	16.5 (420)	19.3 (489)	7.9 (200)	1069 (485)	771 (350)	D
	CRE 15-3	3	UK	7.5 (5.5)		37.4 (949)	57.5 (1460)	6.3 (160)	60.1 (1526)	24.8 (630)	44.8 (1138)	16.5 (420)	19.3 (489)	7.9 (200)	1196 (543)	899 (408)	D
	CRE 15-3	3	UL	7.5 (5.5)		36.4 (925)	57.5 (1460)	6.3 (160)	42 (1066)	24.8 (630)	44.8 (1138)	16.5 (420)	19.3 (489)	7.9 (200)	1141 (518)	844 (383)	D
	CRE 15-4	3	UK	7.5 (5.5)		39.1 (994)	57.5 (1460)	6.3 (160)	60.1 (1526)	24.8 (630)	44.8 (1138)	16.5 (420)	19.3 (489)	7.9 (200)	1210 (549)	912 (414)	D
	CRE 15-4	3	UL	7.5 (5.5)		38.2 (970)	57.5 (1460)	6.3 (160)	42 (1066)	24.8 (630)	44.8 (1138)	16.5 (420)	19.3 (489)	7.9 (200)	1155 (524)	857 (389)	D
	CRE 15-5	3	UL	10 (7.5)		40.9 (1039)	57.5 (1460)	6.3 (160)	60.1 (1526)	24.8 (630)	44.8 (1138)	16.5 (420)	19.3 (489)	7.9 (200)	1260 (572)	963 (437)	D
CRE 15-7	3	UL	15 (11)	49.3 (1251)	57.5 (1460)	7.9 (200)	60.1 (1526)	24.8 (630)	44.8 (1138)	16.5 (420)	19.3 (489)	7.9 (200)	1397 (634)	1100 (499)	D		

Number of pumps	Pump type	Mains phases	Voltage code	Motor power [hp (kW)]	Connection size	A [in (mm)]	A1 [in (mm)]	A2 [in (mm)]	B [in (mm)]	B1 [in (mm)]	C [in (mm)]	C1 [in (mm)]	C2 [in (mm)]	C3 [in (mm)]	Gross weight [lbs (kg)]	Net weight [lbs (kg)]	Design
4	CRE 15-1	1	UJ	2 (1.5)	6" Class 150	28.5 (723)	57.5 (1460)	6.3 (160)	54.6 (1387)	24.8 (630)	46.9 (1190)	16.6 (421)	19.3 (490)	7.9 (200)	1174 (533)	822 (373)	D
	CRE 15-2	3	UK	5 (3.7)		33.1 (841)	57.5 (1460)	6.3 (160)	54.6 (1387)	24.8 (630)	46.9 (1190)	16.6 (421)	19.3 (490)	7.9 (200)	1377 (625)	1025 (465)	D
	CRE 15-2	3	UL	5 (3.7)		33.1 (841)	57.5 (1460)	6.3 (160)	54.6 (1387)	24.8 (630)	46.9 (1190)	16.6 (421)	19.3 (490)	7.9 (200)	1377 (625)	1025 (465)	D
	CRE 15-3	3	UK	7.5 (5.5)		37.4 (949)	57.5 (1460)	6.3 (160)	79.8 (2027)	24.8 (630)	46.9 (1190)	16.6 (421)	19.3 (490)	7.9 (200)	1602 (727)	1205 (547)	D
	CRE 15-3	3	UL	7.5 (5.5)		36.4 (925)	57.5 (1460)	6.3 (160)	54.6 (1387)	24.8 (630)	46.9 (1190)	16.6 (421)	19.3 (490)	7.9 (200)	1476 (670)	1124 (510)	D
	CRE 15-4	3	UK	7.5 (5.5)		39.1 (994)	57.5 (1460)	6.3 (160)	79.8 (2027)	24.8 (630)	46.9 (1190)	16.6 (421)	19.3 (490)	7.9 (200)	1619 (735)	1223 (555)	D
	CRE 15-4	3	UL	7.5 (5.5)		38.2 (970)	57.5 (1460)	6.3 (160)	54.6 (1387)	24.8 (630)	46.9 (1190)	16.6 (421)	19.3 (490)	7.9 (200)	1494 (678)	1141 (518)	D
	CRE 15-5	3	UL	10 (7.5)		40.9 (1039)	57.5 (1460)	6.3 (160)	79.8 (2027)	24.8 (630)	46.9 (1190)	16.6 (421)	19.3 (490)	7.9 (200)	1685 (765)	1289 (585)	D
	CRE 15-7	3	UL	15 (11)		49.3 (1251)	57.5 (1460)	7.9 (200)	79.8 (2027)	24.8 (630)	46.9 (1190)	16.6 (421)	19.3 (490)	7.9 (200)	1866 (847)	1470 (667)	D
5	CRE 15-1	1	UJ	2 (1.5)	6" Class 150	28.5 (723)	57.5 (1460)	6.3 (160)	67.2 (1707)	24.8 (630)	46.9 (1190)	16.6 (421)	19.3 (490)	7.9 (200)	1340 (608)	987 (448)	D
	CRE 15-2	3	UK	5 (3.7)		33.1 (841)	57.5 (1460)	6.3 (160)	67.2 (1707)	24.8 (630)	46.9 (1190)	16.6 (421)	19.3 (490)	7.9 (200)	1613 (732)	1260 (572)	D
	CRE 15-2	3	UL	5 (3.7)		33.1 (841)	57.5 (1460)	6.3 (160)	67.2 (1707)	24.8 (630)	46.9 (1190)	16.6 (421)	19.3 (490)	7.9 (200)	1595 (724)	1243 (564)	D
	CRE 15-3	3	UK	7.5 (5.5)		37.4 (949)	57.5 (1460)	6.3 (160)	99.5 (2527)	24.8 (630)	46.9 (1190)	16.6 (421)	19.3 (490)	7.9 (200)	1943 (882)	1514 (687)	D
	CRE 15-3	3	UL	7.5 (5.5)		36.4 (925)	57.5 (1460)	6.3 (160)	67.2 (1707)	24.8 (630)	46.9 (1190)	16.6 (421)	19.3 (490)	7.9 (200)	1738 (789)	1386 (629)	D
	CRE 15-4	3	UK	7.5 (5.5)		39.1 (994)	57.5 (1460)	6.3 (160)	99.5 (2527)	24.8 (630)	46.9 (1190)	16.6 (421)	19.3 (490)	7.9 (200)	1965 (892)	1536 (697)	D
	CRE 15-4	3	UL	7.5 (5.5)		38.2 (970)	57.5 (1460)	6.3 (160)	67.2 (1707)	24.8 (630)	46.9 (1190)	16.6 (421)	19.3 (490)	7.9 (200)	1760 (799)	1408 (639)	D
	CRE 15-5	3	UL	10 (7.5)		40.9 (1039)	57.5 (1460)	6.3 (160)	99.5 (2527)	24.8 (630)	46.9 (1190)	16.6 (421)	19.3 (490)	7.9 (200)	2047 (929)	1617 (734)	D
	CRE 15-7	3	UL	15 (11)		49.3 (1251)	57.5 (1460)	7.9 (200)	99.5 (2527)	24.8 (630)	46.9 (1190)	16.6 (421)	19.3 (490)	7.9 (200)	2276 (1033)	1846 (838)	D
6	CRE 15-1	1	UJ	2 (1.5)	6" Class 150	28.5 (723)	57.5 (1460)	6.3 (160)	79.8 (2027)	24.8 (630)	46.9 (1190)	16.6 (421)	19.3 (490)	7.9 (200)	1549 (703)	1152 (523)	D
	CRE 15-2	3	UK	5 (3.7)		33.1 (841)	57.5 (1460)	6.3 (160)	79.8 (2027)	24.8 (630)	46.9 (1190)	16.6 (421)	19.3 (490)	7.9 (200)	1879 (853)	1483 (673)	D
	CRE 15-2	3	UL	5 (3.7)		33.1 (841)	57.5 (1460)	6.3 (160)	79.8 (2027)	24.8 (630)	46.9 (1190)	16.6 (421)	19.3 (490)	7.9 (200)	1855 (842)	1459 (662)	D
	CRE 15-3	3	UK	7.5 (5.5)		37.4 (949)	57.5 (1460)	6.3 (160)	119.2 (3027)	24.8 (630)	46.9 (1190)	16.6 (421)	19.3 (490)	7.9 (200)	2437 (1106)	1800 (817)	D
	CRE 15-3	3	UL	7.5 (5.5)		36.4 (925)	57.5 (1460)	6.3 (160)	79.8 (2027)	24.8 (630)	46.9 (1190)	16.6 (421)	19.3 (490)	7.9 (200)	2029 (921)	1633 (741)	D
	CRE 15-4	3	UK	7.5 (5.5)		39.1 (994)	57.5 (1460)	6.3 (160)	119.2 (3027)	24.8 (630)	46.9 (1190)	16.6 (421)	19.3 (490)	7.9 (200)	2463 (1118)	1826 (829)	D
	CRE 15-4	3	UL	7.5 (5.5)		38.2 (970)	57.5 (1460)	6.3 (160)	79.8 (2027)	24.8 (630)	46.9 (1190)	16.6 (421)	19.3 (490)	7.9 (200)	2056 (933)	1659 (753)	D
	CRE 15-5	3	UL	10 (7.5)		40.9 (1039)	57.5 (1460)	6.3 (160)	119.2 (3027)	24.8 (630)	46.9 (1190)	16.6 (421)	19.3 (490)	7.9 (200)	2560 (1162)	1923 (873)	D
	CRE 15-7	3	UL	15 (11)		49.3 (1251)	57.5 (1460)	7.9 (200)	119.2 (3027)	24.8 (630)	46.9 (1190)	16.6 (421)	19.3 (490)	7.9 (200)	2837 (1288)	2201 (999)	D

Dimensions may vary by ± 0.5 inch (12.7 mm).

Hydro MPC-E with CR, CRE 20

Hydro MPC-E with CR 20

Number of pumps	Pump type	Mains phases	Voltage code	Motor power [hp (kW)]	Connection size	A [in (mm)]	A1 [in (mm)]	A2 [in (mm)]	B [in (mm)]	B1 [in (mm)]	C [in (mm)]	C1 [in (mm)]	C2 [in (mm)]	C3 [in (mm)]	Gross weight [lbs (kg)]	Net weight [lbs (kg)]	Design
2	CR 20-1	3	UK	3 (2.2)	4" Class 150	33.7 (855)	59.1 (1500)	6.3 (160)	29.4 (746)	35.4 (900)	44.8 (1138)	16.5 (420)	19.3 (489)	15.7 (400)	1036 (470)	752 (341)	C
	CR 20-1	3	UL	3 (2.2)		33.7 (855)	59.1 (1500)	6.3 (160)	29.4 (746)	35.4 (900)	44.8 (1138)	16.5 (420)	19.3 (489)	15.7 (400)	1036 (470)	752 (341)	C
	CR 20-2	3	UK	5 (3.7)		35.2 (895)	59.1 (1500)	6.3 (160)	29.4 (746)	35.4 (900)	44.8 (1138)	16.5 (420)	19.3 (489)	15.7 (400)	1078 (489)	793 (360)	C
	CR 20-2	3	UL	5 (3.7)		35.2 (895)	59.1 (1500)	6.3 (160)	29.4 (746)	35.4 (900)	44.8 (1138)	16.5 (420)	19.3 (489)	15.7 (400)	1067 (484)	782 (355)	C
	CR 20-3	3	UK	7.5 (5.5)		39 (991)	59.1 (1500)	6.3 (160)	29.4 (746)	35.4 (900)	44.8 (1138)	16.5 (420)	19.3 (489)	15.7 (400)	1227 (557)	943 (428)	C
	CR 20-3	3	UL	7.5 (5.5)		39 (991)	59.1 (1500)	6.3 (160)	29.4 (746)	35.4 (900)	44.8 (1138)	16.5 (420)	19.3 (489)	15.7 (400)	1192 (541)	908 (412)	C
	CR 20-4	3	UL	10 (7.5)		42.6 (1083)	59.1 (1500)	6.3 (160)	29.4 (746)	35.4 (900)	44.8 (1138)	16.5 (420)	19.3 (489)	15.7 (400)	1263 (573)	978 (444)	C
	CR 20-5	3	UL	15 (11)		48.4 (1229)	59.1 (1500)	7.9 (200)	40.4 (1026)	35.4 (900)	44.8 (1138)	16.5 (420)	19.3 (489)	15.7 (400)	1364 (619)	1080 (490)	C
3	CR 20-6	3	UL	15 (11)	50.2 (1274)	59.1 (1500)	7.9 (200)	40.4 (1026)	35.4 (900)	44.8 (1138)	16.5 (420)	19.3 (489)	15.7 (400)	1368 (621)	1084 (492)	C	
	CR 20-1	3	UK	3 (2.2)	33.7 (855)	59.1 (1500)	6.3 (160)	42 (1066)	35.4 (900)	44.8 (1138)	16.5 (420)	19.3 (489)	15.7 (400)	1276 (579)	978 (444)	C	
	CR 20-1	3	UL	3 (2.2)	33.7 (855)	59.1 (1500)	6.3 (160)	42 (1066)	35.4 (900)	44.8 (1138)	16.5 (420)	19.3 (489)	15.7 (400)	1274 (578)	976 (443)	C	
	CR 20-2	3	UK	5 (3.7)	35.2 (895)	59.1 (1500)	6.3 (160)	42 (1066)	35.4 (900)	44.8 (1138)	16.5 (420)	19.3 (489)	15.7 (400)	1340 (608)	1042 (473)	C	
	CR 20-2	3	UL	5 (3.7)	35.2 (895)	59.1 (1500)	6.3 (160)	42 (1066)	35.4 (900)	44.8 (1138)	16.5 (420)	19.3 (489)	15.7 (400)	1320 (599)	1022 (464)	C	
	CR 20-3	3	UK	7.5 (5.5)	39 (991)	74.8 (1900)	6.3 (160)	42 (1066)	47.2 (1200)	44.8 (1138)	16.5 (420)	19.3 (489)	19.7 (500)	1567 (711)	1269 (576)	C	
	CR 20-3	3	UL	7.5 (5.5)	39 (991)	59.1 (1500)	6.3 (160)	42 (1066)	35.4 (900)	44.8 (1138)	16.5 (420)	19.3 (489)	15.7 (400)	1516 (688)	1219 (553)	C	
	CR 20-4	3	UL	10 (7.5)	42.6 (1083)	59.1 (1500)	6.3 (160)	42 (1066)	35.4 (900)	44.8 (1138)	16.5 (420)	19.3 (489)	15.7 (400)	1615 (733)	1318 (598)	C	
3	CR 20-5	3	UL	15 (11)	48.4 (1229)	74.8 (1900)	7.9 (200)	60.1 (1526)	47.2 (1200)	44.8 (1138)	16.5 (420)	19.3 (489)	19.7 (500)	1875 (851)	1483 (673)	C	
	CR 20-6	3	UL	15 (11)	50.2 (1274)	74.8 (1900)	7.9 (200)	60.1 (1526)	47.2 (1200)	44.8 (1138)	16.5 (420)	19.3 (489)	19.7 (500)	1882 (854)	1489 (676)	C	

Number of pumps	Pump type	Mains phases	Voltage code	Motor power [hp (kW)]	Connection size	A [in (mm)]	A1 [in (mm)]	A2 [in (mm)]	B [in (mm)]	B1 [in (mm)]	C [in (mm)]	C1 [in (mm)]	C2 [in (mm)]	C3 [in (mm)]	Gross weight [lbs (kg)]	Net weight [lbs (kg)]	Design
4	CR 20-1	3	UK	3 (2.2)	6" Class 150	33.7 (855)	59.1 (1500)	6.3 (160)	54.6 (1387)	35.4 (900)	46.9 (1190)	16.6 (421)	19.3 (490)	15.7 (400)	1606 (729)	1254 (569)	C
	CR 20-1	3	UL	3 (2.2)		33.7 (855)	59.1 (1500)	6.3 (160)	54.6 (1387)	35.4 (900)	46.9 (1190)	16.6 (421)	19.3 (490)	15.7 (400)	1600 (726)	1247 (566)	C
	CR 20-2	3	UK	5 (3.7)		35.2 (895)	59.1 (1500)	6.3 (160)	54.6 (1387)	35.4 (900)	46.9 (1190)	16.6 (421)	19.3 (490)	15.7 (400)	1692 (768)	1340 (608)	C
	CR 20-2	3	UL	5 (3.7)		35.2 (895)	59.1 (1500)	6.3 (160)	54.6 (1387)	35.4 (900)	46.9 (1190)	16.6 (421)	19.3 (490)	15.7 (400)	1668 (757)	1315 (597)	C
	CR 20-3	3	UK	7.5 (5.5)		39 (991)	74.8 (1900)	6.3 (160)	54.6 (1387)	47.2 (1200)	46.9 (1190)	16.6 (421)	19.3 (490)	19.7 (500)	2036 (924)	1644 (746)	C
	CR 20-3	3	UL	7.5 (5.5)		39 (991)	59.1 (1500)	6.3 (160)	54.6 (1387)	35.4 (900)	46.9 (1190)	16.6 (421)	19.3 (490)	15.7 (400)	1921 (872)	1569 (712)	C
	CR 20-4	3	UL	10 (7.5)		42.6 (1083)	59.1 (1500)	6.3 (160)	54.6 (1387)	35.4 (900)	46.9 (1190)	16.6 (421)	19.3 (490)	15.7 (400)	2060 (935)	1707 (775)	C
	CR 20-5	3	UL	15 (11)		48.4 (1229)	74.8 (1900)	7.9 (200)	79.8 (2027)	47.2 (1200)	46.9 (1190)	16.6 (421)	19.3 (490)	19.7 (500)	2364 (1073)	1926 (874)	C
5	CR 20-6	3	UL	15 (11)	50.2 (1274)	74.8 (1900)	7.9 (200)	79.8 (2027)	47.2 (1200)	46.9 (1190)	16.6 (421)	19.3 (490)	19.7 (500)	2373 (1077)	1934 (878)	C	
	CR 20-1	3	UK	3 (2.2)	33.7 (855)	74.8 (1900)	6.3 (160)	67.2 (1707)	47.2 (1200)	46.9 (1190)	16.6 (421)	19.3 (490)	19.7 (500)	1906 (865)	1496 (679)	C	
	CR 20-1	3	UL	3 (2.2)	33.7 (855)	74.8 (1900)	6.3 (160)	67.2 (1707)	47.2 (1200)	46.9 (1190)	16.6 (421)	19.3 (490)	19.7 (500)	1904 (864)	1494 (678)	C	
	CR 20-2	3	UK	5 (3.7)	35.2 (895)	74.8 (1900)	6.3 (160)	67.2 (1707)	47.2 (1200)	46.9 (1190)	16.6 (421)	19.3 (490)	19.7 (500)	2016 (915)	1606 (729)	C	
	CR 20-2	3	UL	5 (3.7)	35.2 (895)	74.8 (1900)	6.3 (160)	67.2 (1707)	47.2 (1200)	46.9 (1190)	16.6 (421)	19.3 (490)	19.7 (500)	1981 (899)	1571 (713)	C	
	CR 20-3	3	UK	7.5 (5.5)	39 (991)	82.7 (2100)	6.3 (160)	67.2 (1707)	63 (1600)	46.9 (1190)	16.6 (421)	19.3 (490)	19.7 (500)	2714 (1232)	2234 (1014)	C	
	CR 20-3	3	UL	7.5 (5.5)	39 (991)	74.8 (1900)	6.3 (160)	67.2 (1707)	47.2 (1200)	46.9 (1190)	16.6 (421)	19.3 (490)	19.7 (500)	2304 (1046)	1895 (860)	C	
	CR 20-4	3	UL	10 (7.5)	42.6 (1083)	74.8 (1900)	6.3 (160)	67.2 (1707)	47.2 (1200)	46.9 (1190)	16.6 (421)	19.3 (490)	19.7 (500)	2470 (1121)	2060 (935)	C	
6	CR 20-5	3	UL	15 (11)	48.4 (1229)	82.7 (2100)	7.9 (200)	99.5 (2527)	63 (1600)	46.9 (1190)	16.6 (421)	19.3 (490)	19.7 (500)	3280 (1489)	2635 (1196)	C	
	CR 20-6	3	UL	15 (11)	50.2 (1274)	82.7 (2100)	7.9 (200)	99.5 (2527)	63 (1600)	46.9 (1190)	16.6 (421)	19.3 (490)	19.7 (500)	3291 (1494)	2646 (1201)	C	
	CR 20-1	3	UK	3 (2.2)	33.7 (855)	74.8 (1900)	6.3 (160)	79.8 (2027)	47.2 (1200)	46.9 (1190)	16.6 (421)	19.3 (490)	19.7 (500)	2168 (984)	1730 (785)	C	
	CR 20-1	3	UL	3 (2.2)	33.7 (855)	74.8 (1900)	6.3 (160)	79.8 (2027)	47.2 (1200)	46.9 (1190)	16.6 (421)	19.3 (490)	19.7 (500)	2166 (983)	1727 (784)	C	
	CR 20-2	3	UK	5 (3.7)	35.2 (895)	74.8 (1900)	6.3 (160)	79.8 (2027)	47.2 (1200)	46.9 (1190)	16.6 (421)	19.3 (490)	19.7 (500)	2304 (1046)	1866 (847)	C	
	CR 20-2	3	UL	5 (3.7)	35.2 (895)	74.8 (1900)	6.3 (160)	79.8 (2027)	47.2 (1200)	46.9 (1190)	16.6 (421)	19.3 (490)	19.7 (500)	2258 (1025)	1820 (826)	C	
	CR 20-3	3	UK	7.5 (5.5)	39 (991)	82.7 (2100)	6.3 (160)	79.8 (2027)	63 (1600)	46.9 (1190)	16.6 (421)	19.3 (490)	19.7 (500)	3133 (1422)	2560 (1162)	C	
	CR 20-3	3	UL	7.5 (5.5)	39 (991)	74.8 (1900)	6.3 (160)	79.8 (2027)	47.2 (1200)	46.9 (1190)	16.6 (421)	19.3 (490)	19.7 (500)	2646 (1201)	2207 (1002)	C	
6	CR 20-4	3	UL	10 (7.5)	42.6 (1083)	74.8 (1900)	6.3 (160)	79.8 (2027)	47.2 (1200)	46.9 (1190)	16.6 (421)	19.3 (490)	19.7 (500)	2844 (1291)	2406 (1092)	C	
	CR 20-5	3	UL	15 (11)	48.4 (1229)	82.7 (2100)	7.9 (200)	119.2 (3027)	63 (1600)	46.9 (1190)	16.6 (421)	19.3 (490)	19.7 (500)	3551 (1612)	3053 (1386)	C	
	CR 20-6	3	UL	15 (11)	50.2 (1274)	82.7 (2100)	7.9 (200)	119.2 (3027)	63 (1600)	46.9 (1190)	16.6 (421)	19.3 (490)	19.7 (500)	3564 (1618)	3067 (1392)	C	

Dimensions may vary by ± 0.5 inch (12.7 mm).

Hydro MPC-E with CRE 20

Number of pumps	Pump type	Mains phases	Voltage code	Motor power [hp (kW)]	Connection size	A [in (mm)]	A1 [in (mm)]	A2 [in (mm)]	B [in (mm)]	B1 [in (mm)]	C [in (mm)]	C1 [in (mm)]	C2 [in (mm)]	C3 [in (mm)]	Gross weight [lbs (kg)]	Net weight [lbs (kg)]	Design
2	CRE 20-1	3	UK	3 (2.2)	4" Class 150	33.1 (841)	57.5 (1460)	6.3 (160)	29.4 (746)	24.8 (630)	44.8 (1138)	16.5 (420)	19.3 (489)	7.9 (200)	807 (366)	522 (237)	D
	CRE 20-1	3	UL	3 (2.2)		30.8 (782)	57.5 (1460)	6.3 (160)	29.4 (746)	24.8 (630)	44.8 (1138)	16.5 (420)	19.3 (489)	7.9 (200)	789 (358)	505 (229)	D
	CRE 20-2	3	UK	5 (3.7)		33.1 (841)	57.5 (1460)	6.3 (160)	29.4 (746)	24.8 (630)	44.8 (1138)	16.5 (420)	19.3 (489)	7.9 (200)	844 (383)	560 (254)	D
	CRE 20-2	3	UL	5 (3.7)		33.1 (841)	57.5 (1460)	6.3 (160)	29.4 (746)	24.8 (630)	44.8 (1138)	16.5 (420)	19.3 (489)	7.9 (200)	846 (384)	562 (255)	D
	CRE 20-3	3	UK	7.5 (5.5)		37.4 (949)	57.5 (1460)	6.3 (160)	40.4 (1026)	24.8 (630)	44.8 (1138)	16.5 (420)	19.3 (489)	7.9 (200)	930 (422)	646 (293)	D
	CRE 20-3	3	UL	7.5 (5.5)		36.4 (925)	57.5 (1460)	6.3 (160)	29.4 (746)	24.8 (630)	44.8 (1138)	16.5 (420)	19.3 (489)	7.9 (200)	895 (406)	611 (277)	D
	CRE 20-4	3	UL	10 (7.5)		39.1 (994)	57.5 (1460)	6.3 (160)	40.4 (1026)	24.8 (630)	44.8 (1138)	16.5 (420)	19.3 (489)	7.9 (200)	967 (439)	683 (310)	D
	CRE 20-5	3	UL	15 (11)		45.7 (1161)	57.5 (1460)	7.9 (200)	40.4 (1026)	24.8 (630)	44.8 (1138)	16.5 (420)	19.3 (489)	7.9 (200)	1049 (476)	765 (347)	D
	CRE 20-6	3	UL	15 (11)		47.5 (1206)	57.5 (1460)	7.9 (200)	40.4 (1026)	24.8 (630)	44.8 (1138)	16.5 (420)	19.3 (489)	7.9 (200)	1053 (478)	769 (349)	D
	3	CRE 20-1	3	UK		3 (2.2)	4" Class 150	33.1 (841)	57.5 (1460)	6.3 (160)	42 (1066)	24.8 (630)	44.8 (1138)	16.5 (420)	19.3 (489)	7.9 (200)	1009 (458)
CRE 20-1		3	UL	3 (2.2)	30.8 (782)	57.5 (1460)		6.3 (160)	42 (1066)	24.8 (630)	44.8 (1138)	16.5 (420)	19.3 (489)	7.9 (200)	983 (446)	685 (311)	D
CRE 20-2		3	UK	5 (3.7)	33.1 (841)	57.5 (1460)		6.3 (160)	42 (1066)	24.8 (630)	44.8 (1138)	16.5 (420)	19.3 (489)	7.9 (200)	1064 (483)	767 (348)	D
CRE 20-2		3	UL	5 (3.7)	33.1 (841)	57.5 (1460)		6.3 (160)	42 (1066)	24.8 (630)	44.8 (1138)	16.5 (420)	19.3 (489)	7.9 (200)	1069 (485)	771 (350)	D
CRE 20-3		3	UK	7.5 (5.5)	37.4 (949)	57.5 (1460)		6.3 (160)	60.1 (1526)	24.8 (630)	44.8 (1138)	16.5 (420)	19.3 (489)	7.9 (200)	1196 (543)	899 (408)	D
CRE 20-3		3	UL	7.5 (5.5)	36.4 (925)	57.5 (1460)		6.3 (160)	42 (1066)	24.8 (630)	44.8 (1138)	16.5 (420)	19.3 (489)	7.9 (200)	1141 (518)	844 (383)	D
CRE 20-4		3	UL	10 (7.5)	39.1 (994)	57.5 (1460)		6.3 (160)	60.1 (1526)	24.8 (630)	44.8 (1138)	16.5 (420)	19.3 (489)	7.9 (200)	1254 (569)	956 (434)	D
CRE 20-5		3	UL	15 (11)	45.7 (1161)	57.5 (1460)		7.9 (200)	60.1 (1526)	24.8 (630)	44.8 (1138)	16.5 (420)	19.3 (489)	7.9 (200)	1377 (625)	1080 (490)	D
CRE 20-6		3	UL	15 (11)	47.5 (1206)	57.5 (1460)		7.9 (200)	60.1 (1526)	24.8 (630)	44.8 (1138)	16.5 (420)	19.3 (489)	7.9 (200)	1384 (628)	1086 (493)	D

Number of pumps	Pump type	Mains phases	Voltage code	Motor power [hp (kW)]	Connection size	A [in (mm)]	A1 [in (mm)]	A2 [in (mm)]	B [in (mm)]	B1 [in (mm)]	C [in (mm)]	C1 [in (mm)]	C2 [in (mm)]	C3 [in (mm)]	Gross weight [lbs (kg)]	Net weight [lbs (kg)]	Design
4	CRE 20-1	3	UK	3 (2.2)	6" Class 150	33.1 (841)	57.5 (1460)	6.3 (160)	54.6 (1387)	24.8 (630)	46.9 (1190)	16.6 (421)	19.3 (490)	7.9 (200)	1298 (589)	945 (429)	D
	CRE 20-1	3	UL	3 (2.2)		30.8 (782)	57.5 (1460)	6.3 (160)	54.6 (1387)	24.8 (630)	46.9 (1190)	16.6 (421)	19.3 (490)	7.9 (200)	1263 (573)	910 (413)	D
	CRE 20-2	3	UK	5 (3.7)		33.1 (841)	57.5 (1460)	6.3 (160)	54.6 (1387)	24.8 (630)	46.9 (1190)	16.6 (421)	19.3 (490)	7.9 (200)	1377 (625)	1025 (465)	D
	CRE 20-2	3	UL	5 (3.7)		33.1 (841)	57.5 (1460)	6.3 (160)	54.6 (1387)	24.8 (630)	46.9 (1190)	16.6 (421)	19.3 (490)	7.9 (200)	1377 (625)	1025 (465)	D
	CRE 20-3	3	UK	7.5 (5.5)		37.4 (949)	57.5 (1460)	6.3 (160)	79.8 (2027)	24.8 (630)	46.9 (1190)	16.6 (421)	19.3 (490)	7.9 (200)	1602 (727)	1205 (547)	D
	CRE 20-3	3	UL	7.5 (5.5)		36.4 (925)	57.5 (1460)	6.3 (160)	54.6 (1387)	24.8 (630)	46.9 (1190)	16.6 (421)	19.3 (490)	7.9 (200)	1476 (670)	1124 (510)	D
	CRE 20-4	3	UL	10 (7.5)		39.1 (994)	57.5 (1460)	6.3 (160)	79.8 (2027)	24.8 (630)	46.9 (1190)	16.6 (421)	19.3 (490)	7.9 (200)	1677 (761)	1280 (581)	D
	CRE 20-5	3	UL	15 (11)		45.7 (1161)	57.5 (1460)	7.9 (200)	79.8 (2027)	24.8 (630)	46.9 (1190)	16.6 (421)	19.3 (490)	7.9 (200)	1840 (835)	1443 (655)	D
5	CRE 20-6	3	UL	15 (11)	47.5 (1206)	57.5 (1460)	7.9 (200)	79.8 (2027)	24.8 (630)	46.9 (1190)	16.6 (421)	19.3 (490)	7.9 (200)	1848 (839)	1452 (659)	D	
	CRE 20-1	3	UK	3 (2.2)	33.1 (841)	57.5 (1460)	6.3 (160)	67.2 (1707)	24.8 (630)	46.9 (1190)	16.6 (421)	19.3 (490)	7.9 (200)	1496 (679)	1144 (519)	D	
	CRE 20-1	3	UL	3 (2.2)	30.8 (782)	57.5 (1460)	6.3 (160)	67.2 (1707)	24.8 (630)	46.9 (1190)	16.6 (421)	19.3 (490)	7.9 (200)	1452 (659)	1100 (499)	D	
	CRE 20-2	3	UK	5 (3.7)	33.1 (841)	57.5 (1460)	6.3 (160)	67.2 (1707)	24.8 (630)	46.9 (1190)	16.6 (421)	19.3 (490)	7.9 (200)	1613 (732)	1260 (572)	D	
	CRE 20-2	3	UL	5 (3.7)	33.1 (841)	57.5 (1460)	6.3 (160)	67.2 (1707)	24.8 (630)	46.9 (1190)	16.6 (421)	19.3 (490)	7.9 (200)	1595 (724)	1243 (564)	D	
	CRE 20-3	3	UK	7.5 (5.5)	37.4 (949)	57.5 (1460)	6.3 (160)	99.5 (2527)	24.8 (630)	46.9 (1190)	16.6 (421)	19.3 (490)	7.9 (200)	1943 (882)	1514 (687)	D	
	CRE 20-3	3	UL	7.5 (5.5)	36.4 (925)	57.5 (1460)	6.3 (160)	67.2 (1707)	24.8 (630)	46.9 (1190)	16.6 (421)	19.3 (490)	7.9 (200)	1738 (789)	1386 (629)	D	
	CRE 20-4	3	UL	10 (7.5)	39.1 (994)	57.5 (1460)	6.3 (160)	99.5 (2527)	24.8 (630)	46.9 (1190)	16.6 (421)	19.3 (490)	7.9 (200)	2036 (924)	1606 (729)	D	
6	CRE 20-5	3	UL	15 (11)	45.7 (1161)	57.5 (1460)	7.9 (200)	99.5 (2527)	24.8 (630)	46.9 (1190)	16.6 (421)	19.3 (490)	7.9 (200)	2243 (1018)	1813 (823)	D	
	CRE 20-6	3	UL	15 (11)	47.5 (1206)	57.5 (1460)	7.9 (200)	99.5 (2527)	24.8 (630)	46.9 (1190)	16.6 (421)	19.3 (490)	7.9 (200)	2254 (1023)	1824 (828)	D	
	CRE 20-1	3	UK	3 (2.2)	33.1 (841)	57.5 (1460)	6.3 (160)	79.8 (2027)	24.8 (630)	46.9 (1190)	16.6 (421)	19.3 (490)	7.9 (200)	1736 (788)	1340 (608)	D	
	CRE 20-1	3	UL	3 (2.2)	30.8 (782)	57.5 (1460)	6.3 (160)	79.8 (2027)	24.8 (630)	46.9 (1190)	16.6 (421)	19.3 (490)	7.9 (200)	1683 (764)	1287 (584)	D	
	CRE 20-2	3	UK	5 (3.7)	33.1 (841)	57.5 (1460)	6.3 (160)	79.8 (2027)	24.8 (630)	46.9 (1190)	16.6 (421)	19.3 (490)	7.9 (200)	1879 (853)	1483 (673)	D	
	CRE 20-2	3	UL	5 (3.7)	33.1 (841)	57.5 (1460)	6.3 (160)	79.8 (2027)	24.8 (630)	46.9 (1190)	16.6 (421)	19.3 (490)	7.9 (200)	1855 (842)	1459 (662)	D	
	CRE 20-3	3	UK	7.5 (5.5)	37.4 (949)	57.5 (1460)	6.3 (160)	119.2 (3027)	24.8 (630)	46.9 (1190)	16.6 (421)	19.3 (490)	7.9 (200)	2437 (1106)	1800 (817)	D	
	CRE 20-3	3	UL	7.5 (5.5)	36.4 (925)	57.5 (1460)	6.3 (160)	79.8 (2027)	24.8 (630)	46.9 (1190)	16.6 (421)	19.3 (490)	7.9 (200)	2029 (921)	1633 (741)	D	
6	CRE 20-4	3	UL	10 (7.5)	39.1 (994)	57.5 (1460)	6.3 (160)	119.2 (3027)	24.8 (630)	46.9 (1190)	16.6 (421)	19.3 (490)	7.9 (200)	2547 (1156)	1910 (867)	D	
	CRE 20-5	3	UL	15 (11)	45.7 (1161)	57.5 (1460)	7.9 (200)	119.2 (3027)	24.8 (630)	46.9 (1190)	16.6 (421)	19.3 (490)	7.9 (200)	2798 (1270)	2161 (981)	D	
	CRE 20-6	3	UL	15 (11)	47.5 (1206)	57.5 (1460)	7.9 (200)	119.2 (3027)	24.8 (630)	46.9 (1190)	16.6 (421)	19.3 (490)	7.9 (200)	2811 (1276)	2174 (987)	D	

Dimensions may vary by ± 0.5 inch (12.7 mm).

Hydro MPC-E with CR, CRE 32

Hydro MPC-E with CR 32

Number of pumps	Pump type	Mains phases	Voltage code	Motor power [hp (kW)]	Connection size	A [in (mm)]	A1 [in (mm)]	A2 [in (mm)]	B [in (mm)]	B1 [in (mm)]	C [in (mm)]	C1 [in (mm)]	C2 [in (mm)]	C3 [in (mm)]	Gross weight [lbs (kg)]	Net weight [lbs (kg)]	Design
2	CR 32-1	3	UK	5 (3.7)	4" Class 150	38.1 (968)	59.1 (1500)	6.9 (175)	40.4 (1026)	35.4 (900)	47.8 (1213)	14.6 (371)	24.1 (613)	15.7 (400)	1188 (539)	904 (410)	C
	CR 32-1	3	UL	5 (3.7)		38.1 (968)	59.1 (1500)	6.9 (175)	40.4 (1026)	35.4 (900)	47.8 (1213)	14.6 (371)	24.1 (613)	15.7 (400)	1177 (534)	893 (405)	C
	CR 32-2-1	3	UK	7.5 (5.5)		42.6 (1081)	59.1 (1500)	6.9 (175)	40.4 (1026)	35.4 (900)	47.8 (1213)	14.6 (371)	24.1 (613)	15.7 (400)	1337 (607)	1053 (478)	C
	CR 32-2-1	3	UL	7.5 (5.5)		42.6 (1081)	59.1 (1500)	6.9 (175)	40.4 (1026)	35.4 (900)	47.8 (1213)	14.6 (371)	24.1 (613)	15.7 (400)	1302 (591)	1018 (462)	C
	CR 32-3-2	3	UL	10 (7.5)		47.2 (1198)	59.1 (1500)	6.9 (175)	40.4 (1026)	35.4 (900)	47.8 (1213)	14.6 (371)	24.1 (613)	15.7 (400)	1379 (626)	1095 (497)	C
	CR 32-4-2	3	UL	15 (11)		55.5 (1409)	59.1 (1500)	8.5 (215)	40.4 (1026)	35.4 (900)	47.8 (1213)	14.6 (371)	24.1 (613)	15.7 (400)	1489 (676)	1205 (547)	C
3	CR 32-1	3	UK	5 (3.7)	6" Class 150	38.1 (968)	59.1 (1500)	6.9 (175)	60.1 (1527)	35.4 (900)	49.7 (1263)	14.6 (371)	24.1 (613)	15.7 (400)	1611 (731)	1258 (571)	C
	CR 32-1	3	UL	5 (3.7)		38.1 (968)	59.1 (1500)	6.9 (175)	60.1 (1527)	35.4 (900)	49.7 (1263)	14.6 (371)	24.1 (613)	15.7 (400)	1589 (721)	1236 (561)	C
	CR 32-2-1	3	UK	7.5 (5.5)		42.6 (1081)	74.8 (1900)	6.9 (175)	60.1 (1527)	47.2 (1200)	49.7 (1263)	14.6 (371)	24.1 (613)	19.7 (500)	1875 (851)	1483 (673)	C
	CR 32-2-1	3	UL	7.5 (5.5)		42.6 (1081)	59.1 (1500)	6.9 (175)	60.1 (1527)	35.4 (900)	49.7 (1263)	14.6 (371)	24.1 (613)	15.7 (400)	1782 (809)	1430 (649)	C
	CR 32-3-2	3	UL	10 (7.5)		47.2 (1198)	59.1 (1500)	6.9 (175)	60.1 (1527)	35.4 (900)	49.7 (1263)	14.6 (371)	24.1 (613)	15.7 (400)	1893 (859)	1540 (699)	C
	CR 32-4-2	3	UL	15 (11)		55.5 (1409)	74.8 (1900)	8.5 (215)	60.1 (1527)	47.2 (1200)	49.7 (1263)	14.6 (371)	24.1 (613)	19.7 (500)	2111 (958)	1719 (780)	C
4	CR 32-1	3	UK	5 (3.7)	6" Class 150	38.1 (968)	59.1 (1500)	6.9 (175)	79.8 (2027)	35.4 (900)	49.7 (1263)	14.6 (371)	24.1 (613)	15.7 (400)	2014 (914)	1584 (719)	C
	CR 32-1	3	UL	5 (3.7)		38.1 (968)	59.1 (1500)	6.9 (175)	79.8 (2027)	35.4 (900)	49.7 (1263)	14.6 (371)	24.1 (613)	15.7 (400)	1987 (902)	1558 (707)	C
	CR 32-2-1	3	UK	7.5 (5.5)		42.6 (1081)	74.8 (1900)	6.9 (175)	79.8 (2027)	47.2 (1200)	49.7 (1263)	14.6 (371)	24.1 (613)	19.7 (500)	2324 (1055)	1886 (856)	C
	CR 32-2-1	3	UL	7.5 (5.5)		42.6 (1081)	59.1 (1500)	6.9 (175)	79.8 (2027)	35.4 (900)	49.7 (1263)	14.6 (371)	24.1 (613)	15.7 (400)	2241 (1017)	1811 (822)	C
	CR 32-3-2	3	UL	10 (7.5)		47.2 (1198)	59.1 (1500)	6.9 (175)	79.8 (2027)	35.4 (900)	49.7 (1263)	14.6 (371)	24.1 (613)	15.7 (400)	2393 (1086)	1963 (891)	C
	CR 32-4-2	3	UL	15 (11)		55.5 (1409)	74.8 (1900)	8.5 (215)	79.8 (2027)	47.2 (1200)	49.7 (1263)	14.6 (371)	24.1 (613)	19.7 (500)	2630 (1194)	2192 (995)	C
5	CR 32-1	3	UK	5 (3.7)	8" Class 150	39.7 (1008)	74.8 (1900)	8.5 (215)	99.6 (2530)	47.2 (1200)	53.9 (1369)	15.4 (392)	25 (634)	19.7 (500)	2553 (1159)	2045 (928)	C
	CR 32-1	3	UL	5 (3.7)		39.7 (1008)	74.8 (1900)	8.5 (215)	99.6 (2530)	47.2 (1200)	53.9 (1369)	15.4 (392)	25 (634)	19.7 (500)	2516 (1142)	2007 (911)	C
	CR 32-2-1	3	UK	7.5 (5.5)		44.1 (1121)	82.7 (2100)	8.5 (215)	99.6 (2530)	63 (1600)	53.9 (1369)	15.4 (392)	25 (634)	19.7 (500)	3313 (1504)	2668 (1211)	C
	CR 32-2-1	3	UL	7.5 (5.5)		44.1 (1121)	74.8 (1900)	8.5 (215)	99.6 (2530)	47.2 (1200)	53.9 (1369)	15.4 (392)	25 (634)	19.7 (500)	2837 (1288)	2329 (1057)	C
	CR 32-3-2	3	UL	10 (7.5)		48.7 (1238)	74.8 (1900)	8.5 (215)	99.6 (2530)	47.2 (1200)	53.9 (1369)	15.4 (392)	25 (634)	19.7 (500)	3020 (1371)	2511 (1140)	C
	CR 32-4-2	3	UL	15 (11)		55.5 (1409)	82.7 (2100)	8.5 (215)	99.6 (2530)	63 (1600)	53.9 (1369)	15.4 (392)	25 (634)	19.7 (500)	3670 (1666)	3025 (1373)	C

Number of pumps	Pump type	Mains phases	Voltage code	Motor power [hp (kW)]	Connection size	A [in (mm)]	A1 [in (mm)]	A2 [in (mm)]	B [in (mm)]	B1 [in (mm)]	C [in (mm)]	C1 [in (mm)]	C2 [in (mm)]	C3 [in (mm)]	Gross weight [lbs (kg)]	Net weight [lbs (kg)]	Design
6	CR 32-1	3	UK	5 (3.7)	8" Class 150	39.7 (1008)	74.8 (1900)	8.5 (215)	119.3 (3030)	47.2 (1200)	53.9 (1369)	15.4 (392)	25 (634)	19.7 (500)	2873 (1304)	2375 (1078)	C
	CR 32-1	3	UL	5 (3.7)		39.7 (1008)	74.8 (1900)	8.5 (215)	119.3 (3030)	47.2 (1200)	53.9 (1369)	15.4 (392)	25 (634)	19.7 (500)	2826 (1283)	2329 (1057)	C
	CR 32-2-1	3	UK	7.5 (5.5)		44.1 (1121)	82.7 (2100)	8.5 (215)	119.3 (3030)	63 (1600)	53.9 (1369)	15.4 (392)	25 (634)	19.7 (500)	3562 (1617)	3064 (1391)	C
	CR 32-2-1	3	UL	7.5 (5.5)		44.1 (1121)	74.8 (1900)	8.5 (215)	119.3 (3030)	47.2 (1200)	53.9 (1369)	15.4 (392)	25 (634)	19.7 (500)	3210 (1457)	2712 (1231)	C
	CR 32-3-2	3	UL	10 (7.5)		48.7 (1238)	74.8 (1900)	8.5 (215)	119.3 (3030)	47.2 (1200)	53.9 (1369)	15.4 (392)	25 (634)	19.7 (500)	3430 (1557)	2932 (1331)	C
	CR 32-4-2	3	UL	15 (11)		55.5 (1409)	82.7 (2100)	8.5 (215)	119.3 (3030)	63 (1600)	53.9 (1369)	15.4 (392)	25 (634)	19.7 (500)	3992 (1812)	3494 (1586)	C

Dimensions may vary by ± 0.5 inch (12.7 mm).

Hydro MPC-E with CRE 32

Number of pumps	Pump type	Mains phases	Voltage code	Motor power [hp (kW)]	Connection size	A [in (mm)]	A1 [in (mm)]	A2 [in (mm)]	B [in (mm)]	B1 [in (mm)]	C [in (mm)]	C1 [in (mm)]	C2 [in (mm)]	C3 [in (mm)]	Gross weight [lbs (kg)]	Net weight [lbs (kg)]	Design
2	CRE 32-1	3	UK	5 (3.7)	4" Class 150	35.8 (909)	57.5 (1460)	6.9 (175)	40.4 (1026)	24.8 (630)	47.8 (1213)	14.6 (371)	24.1 (613)	7.9 (200)	941 (427)	657 (298)	D
	CRE 32-1	3	UL	5 (3.7)		35.8 (909)	57.5 (1460)	6.9 (175)	40.4 (1026)	24.8 (630)	47.8 (1213)	14.6 (371)	24.1 (613)	7.9 (200)	941 (427)	657 (298)	D
	CRE 32-2-1	3	UK	7.5 (5.5)		40.7 (1034)	57.5 (1460)	6.9 (175)	40.4 (1026)	24.8 (630)	47.8 (1213)	14.6 (371)	24.1 (613)	7.9 (200)	1018 (462)	734 (333)	D
	CRE 32-2-1	3	UL	7.5 (5.5)		39.8 (1010)	57.5 (1460)	6.9 (175)	40.4 (1026)	24.8 (630)	47.8 (1213)	14.6 (371)	24.1 (613)	7.9 (200)	998 (453)	714 (324)	D
	CRE 32-3-2	3	UL	10 (7.5)		43.5 (1104)	57.5 (1460)	6.9 (175)	40.4 (1026)	24.8 (630)	47.8 (1213)	14.6 (371)	24.1 (613)	7.9 (200)	1047 (475)	763 (346)	D
	CRE 32-4-2	3	UL	15 (11)		52.8 (1341)	57.5 (1460)	8.5 (215)	40.4 (1026)	24.8 (630)	47.8 (1213)	14.6 (371)	24.1 (613)	7.9 (200)	1179 (535)	895 (406)	D
3	CRE 32-1	3	UK	5 (3.7)	6" Class 150	35.8 (909)	57.5 (1460)	6.9 (175)	60.1 (1527)	24.8 (630)	49.7 (1263)	14.6 (371)	24.1 (613)	7.9 (200)	1315 (597)	963 (437)	D
	CRE 32-1	3	UL	5 (3.7)		35.8 (909)	57.5 (1460)	6.9 (175)	60.1 (1527)	24.8 (630)	49.7 (1263)	14.6 (371)	24.1 (613)	7.9 (200)	1313 (596)	961 (436)	D
	CRE 32-2-1	3	UK	7.5 (5.5)		40.7 (1034)	57.5 (1460)	6.9 (175)	60.1 (1527)	24.8 (630)	49.7 (1263)	14.6 (371)	24.1 (613)	7.9 (200)	1428 (648)	1075 (488)	D
	CRE 32-2-1	3	UL	7.5 (5.5)		39.8 (1010)	57.5 (1460)	6.9 (175)	60.1 (1527)	24.8 (630)	49.7 (1263)	14.6 (371)	24.1 (613)	7.9 (200)	1399 (635)	1047 (475)	D
	CRE 32-3-2	3	UL	10 (7.5)		43.5 (1104)	57.5 (1460)	6.9 (175)	60.1 (1527)	24.8 (630)	49.7 (1263)	14.6 (371)	24.1 (613)	7.9 (200)	1474 (669)	1122 (509)	D
	CRE 32-4-2	3	UL	15 (11)		52.8 (1341)	57.5 (1460)	8.5 (215)	60.1 (1527)	24.8 (630)	49.7 (1263)	14.6 (371)	24.1 (613)	7.9 (200)	1672 (759)	1320 (599)	D

Number of pumps	Pump type	Mains phases	Voltage code	Motor power [hp (kW)]	Connection size	A [in (mm)]	A1 [in (mm)]	A2 [in (mm)]	B [in (mm)]	B1 [in (mm)]	C [in (mm)]	C1 [in (mm)]	C2 [in (mm)]	C3 [in (mm)]	Gross weight [lbs (kg)]	Net weight [lbs (kg)]	Design
4	CRE 32-1	3	UK	5 (3.7)	6" Class 150	35.8 (909)	57.5 (1460)	6.9 (175)	79.8 (2027)	24.8 (630)	49.7 (1263)	14.6 (371)	24.1 (613)	7.9 (200)	1639 (744)	1243 (564)	D
	CRE 32-1	3	UL	5 (3.7)		35.8 (909)	57.5 (1460)	6.9 (175)	79.8 (2027)	24.8 (630)	49.7 (1263)	14.6 (371)	24.1 (613)	7.9 (200)	1635 (742)	1238 (562)	D
	CRE 32-2-1	3	UK	7.5 (5.5)		40.7 (1034)	57.5 (1460)	6.9 (175)	79.8 (2027)	24.8 (630)	49.7 (1263)	14.6 (371)	24.1 (613)	7.9 (200)	1791 (813)	1395 (633)	D
	CRE 32-2-1	3	UL	7.5 (5.5)		39.8 (1010)	57.5 (1460)	6.9 (175)	79.8 (2027)	24.8 (630)	49.7 (1263)	14.6 (371)	24.1 (613)	7.9 (200)	1752 (795)	1355 (615)	D
	CRE 32-3-2	3	UL	10 (7.5)		43.5 (1104)	57.5 (1460)	6.9 (175)	79.8 (2027)	24.8 (630)	49.7 (1263)	14.6 (371)	24.1 (613)	7.9 (200)	1848 (839)	1452 (659)	D
	CRE 32-4-2	3	UL	15 (11)		52.8 (1341)	57.5 (1460)	8.5 (215)	79.8 (2027)	24.8 (630)	49.7 (1263)	14.6 (371)	24.1 (613)	7.9 (200)	2113 (959)	1716 (779)	D
5	CRE 32-1	3	UK	5 (3.7)	8" Class 150	37.4 (949)	57.5 (1460)	8.5 (215)	99.6 (2530)	24.8 (630)	53.9 (1369)	15.4 (392)	25 (634)	7.9 (200)	2214 (1005)	1650 (749)	D
	CRE 32-1	3	UL	5 (3.7)		37.4 (949)	57.5 (1460)	8.5 (215)	99.6 (2530)	24.8 (630)	53.9 (1369)	15.4 (392)	25 (634)	7.9 (200)	2190 (994)	1626 (738)	D
	CRE 32-2-1	3	UK	7.5 (5.5)		42.3 (1074)	57.5 (1460)	8.5 (215)	99.6 (2530)	24.8 (630)	53.9 (1369)	15.4 (392)	25 (634)	7.9 (200)	2406 (1092)	1842 (836)	D
	CRE 32-2-1	3	UL	7.5 (5.5)		41.3 (1050)	57.5 (1460)	8.5 (215)	99.6 (2530)	24.8 (630)	53.9 (1369)	15.4 (392)	25 (634)	7.9 (200)	2355 (1069)	1791 (813)	D
	CRE 32-3-2	3	UL	10 (7.5)		45 (1144)	57.5 (1460)	8.5 (215)	99.6 (2530)	24.8 (630)	53.9 (1369)	15.4 (392)	25 (634)	7.9 (200)	2476 (1124)	1912 (868)	D
	CRE 32-4-2	3	UL	15 (11)		52.8 (1341)	57.5 (1460)	8.5 (215)	99.6 (2530)	24.8 (630)	53.9 (1369)	15.4 (392)	25 (634)	7.9 (200)	2776 (1260)	2212 (1004)	D
6	CRE 32-1	3	UK	5 (3.7)	8" Class 150	37.4 (949)	57.5 (1460)	8.5 (215)	119.3 (3030)	24.8 (630)	53.9 (1369)	15.4 (392)	25 (634)	7.9 (200)	2575 (1169)	1939 (880)	D
	CRE 32-1	3	UL	5 (3.7)		37.4 (949)	57.5 (1460)	8.5 (215)	119.3 (3030)	24.8 (630)	53.9 (1369)	15.4 (392)	25 (634)	7.9 (200)	2542 (1154)	1906 (865)	D
	CRE 32-2-1	3	UK	7.5 (5.5)		42.3 (1074)	57.5 (1460)	8.5 (215)	119.3 (3030)	24.8 (630)	53.9 (1369)	15.4 (392)	25 (634)	7.9 (200)	2804 (1273)	2168 (984)	D
	CRE 32-2-1	3	UL	7.5 (5.5)		41.3 (1050)	57.5 (1460)	8.5 (215)	119.3 (3030)	24.8 (630)	53.9 (1369)	15.4 (392)	25 (634)	7.9 (200)	2743 (1245)	2106 (956)	D
	CRE 32-3-2	3	UL	10 (7.5)		45 (1144)	57.5 (1460)	8.5 (215)	119.3 (3030)	24.8 (630)	53.9 (1369)	15.4 (392)	25 (634)	7.9 (200)	2890 (1312)	2254 (1023)	D
	CRE 32-4-2	3	UL	15 (11)		52.8 (1341)	57.5 (1460)	8.5 (215)	119.3 (3030)	24.8 (630)	53.9 (1369)	15.4 (392)	25 (634)	7.9 (200)	3249 (1475)	2613 (1186)	D

Dimensions may vary by ± 0.5 inch (12.7 mm).

Hydro MPC-E with CR, CRE 45

Hydro MPC-E with CR 45

Number of pumps	Pump type	Mains phases	Voltage code	Motor power [hp (kW)]	Connection size	A [in (mm)]	A1 [in (mm)]	A2 [in (mm)]	B [in (mm)]	B1 [in (mm)]	C [in (mm)]	C1 [in (mm)]	C2 [in (mm)]	C3 [in (mm)]	Gross weight [lbs (kg)]	Net weight [lbs (kg)]	Design
2	CR 45-1-1	3	UK	7.5 (5.5)	6" Class 150	41.9 (1065)	59.1 (1500)	8.3 (210)	40.4 (1027)	35.4 (900)	51.5 (1309)	15.5 (394)	25 (636)	15.7 (400)	1397 (634)	1113 (505)	C
	CR 45-1-1	3	UL	7.5 (5.5)		41.9 (1065)	59.1 (1500)	8.3 (210)	40.4 (1027)	35.4 (900)	51.5 (1309)	15.5 (394)	25 (636)	15.7 (400)	1362 (618)	1078 (489)	C
	CR 45-1	3	UL	10 (7.5)		43.8 (1112)	59.1 (1500)	8.3 (210)	40.4 (1027)	35.4 (900)	51.5 (1309)	15.5 (394)	25 (636)	15.7 (400)	1426 (647)	1141 (518)	C
	CR 45-2	3	UL	15 (11)		52.5 (1333)	59.1 (1500)	9.8 (250)	40.4 (1027)	35.4 (900)	51.5 (1309)	15.5 (394)	25 (636)	15.7 (400)	1540 (699)	1256 (570)	C
	CR 45-3-2	3	UL	20 (15)		55.6 (1413)	59.1 (1500)	9.8 (250)	40.4 (1027)	35.4 (900)	51.5 (1309)	15.5 (394)	25 (636)	15.7 (400)	1547 (702)	1263 (573)	C
	CR 45-3	3	UL	25 (18)		59.1 (1502)	59.1 (1500)	9.8 (250)	40.4 (1027)	35.4 (900)	51.5 (1309)	15.5 (394)	25 (636)	15.7 (400)	1837 (834)	1553 (705)	C
3	CR 45-1-1	3	UK	7.5 (5.5)	6" Class 150	41.9 (1065)	74.8 (1900)	8.3 (210)	60.1 (1527)	47.2 (1200)	51.5 (1309)	15.5 (394)	25 (636)	19.7 (500)	1910 (867)	1518 (689)	C
	CR 45-1-1	3	UL	7.5 (5.5)		41.9 (1065)	59.1 (1500)	8.3 (210)	60.1 (1527)	35.4 (900)	51.5 (1309)	15.5 (394)	25 (636)	15.7 (400)	1818 (825)	1465 (665)	C
	CR 45-1	3	UL	10 (7.5)		43.8 (1112)	59.1 (1500)	8.3 (210)	60.1 (1527)	35.4 (900)	51.5 (1309)	15.5 (394)	25 (636)	15.7 (400)	1908 (866)	1556 (706)	C
	CR 45-2	3	UL	15 (11)		52.5 (1333)	74.8 (1900)	9.8 (250)	60.1 (1527)	47.2 (1200)	51.5 (1309)	15.5 (394)	25 (636)	19.7 (500)	2130 (967)	1738 (789)	C
	CR 45-3-2	3	UL	20 (15)		55.6 (1413)	74.8 (1900)	9.8 (250)	60.1 (1527)	47.2 (1200)	51.5 (1309)	15.5 (394)	25 (636)	19.7 (500)	2146 (974)	1754 (796)	C
	CR 45-3	3	UL	25 (18)		59.1 (1502)	74.8 (1900)	9.8 (250)	60.1 (1527)	47.2 (1200)	51.5 (1309)	15.5 (394)	25 (636)	19.7 (500)	2575 (1169)	2183 (991)	C
4	CR 45-1-1	3	UK	7.5 (5.5)	8" Class 150	43.5 (1105)	74.8 (1900)	9.8 (250)	79.9 (2030)	47.2 (1200)	55.6 (1413)	16.3 (414)	25.8 (656)	19.7 (500)	2582 (1172)	2009 (912)	C
	CR 45-1-1	3	UL	7.5 (5.5)		43.5 (1105)	59.1 (1500)	9.8 (250)	79.9 (2030)	35.4 (900)	55.6 (1413)	16.3 (414)	25.8 (656)	15.7 (400)	2496 (1133)	1932 (877)	C
	CR 45-1	3	UL	10 (7.5)		45.4 (1152)	59.1 (1500)	9.8 (250)	79.9 (2030)	35.4 (900)	55.6 (1413)	16.3 (414)	25.8 (656)	15.7 (400)	2622 (1190)	2058 (934)	C
	CR 45-2	3	UL	15 (11)		52.5 (1333)	74.8 (1900)	9.8 (250)	79.9 (2030)	47.2 (1200)	55.6 (1413)	16.3 (414)	25.8 (656)	19.7 (500)	2840 (1289)	2267 (1029)	C
	CR 45-3-2	3	UL	20 (15)		55.6 (1413)	74.8 (1900)	9.8 (250)	79.9 (2030)	47.2 (1200)	55.6 (1413)	16.3 (414)	25.8 (656)	19.7 (500)	2859 (1298)	2287 (1038)	C
	CR 45-3	3	UL	25 (18)		59.1 (1502)	74.8 (1900)	9.8 (250)	79.9 (2030)	47.2 (1200)	55.6 (1413)	16.3 (414)	25.8 (656)	19.7 (500)	3432 (1558)	2859 (1298)	C
5	CR 45-1-1	3	UK	7.5 (5.5)	8" Class 150	43.5 (1105)	82.7 (2100)	9.8 (250)	99.6 (2530)	63 (1600)	55.6 (1413)	16.3 (414)	25.8 (656)	19.7 (500)	3373 (1531)	2727 (1238)	C
	CR 45-1-1	3	UL	7.5 (5.5)		43.5 (1105)	74.8 (1900)	9.8 (250)	99.6 (2530)	47.2 (1200)	55.6 (1413)	16.3 (414)	25.8 (656)	19.7 (500)	3033 (1377)	2388 (1084)	C
	CR 45-1	3	UL	10 (7.5)		45.4 (1152)	74.8 (1900)	9.8 (250)	99.6 (2530)	47.2 (1200)	55.6 (1413)	16.3 (414)	25.8 (656)	19.7 (500)	3181 (1444)	2536 (1151)	C
	CR 45-2	3	UL	15 (11)		52.5 (1333)	82.7 (2100)	9.8 (250)	99.6 (2530)	63 (1600)	55.6 (1413)	16.3 (414)	25.8 (656)	19.7 (500)	3701 (1680)	3056 (1387)	C
	CR 45-3-2	3	UL	20 (15)		55.6 (1413)	82.7 (2100)	9.8 (250)	99.6 (2530)	63 (1600)	55.6 (1413)	16.3 (414)	25.8 (656)	19.7 (500)	3721 (1689)	3075 (1396)	C
	CR 45-3	3	UL	25 (18)		59.1 (1502)	82.7 (2100)	9.8 (250)	99.6 (2530)	63 (1600)	55.6 (1413)	16.3 (414)	25.8 (656)	19.7 (500)	4437 (2014)	3791 (1721)	C

Number of pumps	Pump type	Mains phases	Voltage code	Motor power [hp (kW)]	Connection size	A [in (mm)]	A1 [in (mm)]	A2 [in (mm)]	B [in (mm)]	B1 [in (mm)]	C [in (mm)]	C1 [in (mm)]	C2 [in (mm)]	C3 [in (mm)]	Gross weight [lbs (kg)]	Net weight [lbs (kg)]	Design
6	CR 45-1-1	3	UK	7.5 (5.5)	10" Class 150	45.9 (1165)	82.7 (2100)	12.2 (310)	119.4 (3032)	63 (1600)	62 (1574)	18.2 (463)	27.8 (705)	19.7 (500)	4225 (1918)	3589 (1629)	C
	CR 45-1-1	3	UL	7.5 (5.5)		45.9 (1165)	74.8 (1900)	12.2 (310)	119.4 (3032)	47.2 (1200)	62 (1574)	18.2 (463)	27.8 (705)	19.7 (500)	3873 (1758)	3236 (1469)	C
	CR 45-1	3	UL	10 (7.5)		47.7 (1212)	74.8 (1900)	12.2 (310)	119.4 (3032)	47.2 (1200)	62 (1574)	18.2 (463)	27.8 (705)	19.7 (500)	4049 (1838)	3412 (1549)	C
	CR 45-2	3	UL	15 (11)		54.8 (1393)	82.7 (2100)	12.2 (310)	119.4 (3032)	63 (1600)	62 (1574)	18.2 (463)	27.8 (705)	19.7 (500)	4619 (2097)	3983 (1808)	C
	CR 45-3-2	3	UL	20 (15)		58 (1473)	82.7 (2100)	12.2 (310)	119.4 (3032)	63 (1600)	62 (1574)	18.2 (463)	27.8 (705)	19.7 (500)	4644 (2108)	4007 (1819)	C
	CR 45-3	3	UL	25 (18)		61.5 (1562)	82.7 (2100)	12.2 (310)	119.4 (3032)	63 (1600)	62 (1574)	18.2 (463)	27.8 (705)	19.7 (500)	5514 (2503)	4877 (2214)	C

Dimensions may vary by ± 0.5 inch (12.7 mm).

Hydro MPC-E with CRE 45

Number of pumps	Pump type	Mains phases	Voltage code	Motor power [hp (kW)]	Connection size	A [in (mm)]	A1 [in (mm)]	A2 [in (mm)]	B [in (mm)]	B1 [in (mm)]	C [in (mm)]	C1 [in (mm)]	C2 [in (mm)]	C3 [in (mm)]	Gross weight [lbs (kg)]	Net weight [lbs (kg)]	Design
2	CRE 45-1-1	3	UK	7.5 (5.5)	6" Class 150	40.1 (1018)	57.5 (1460)	8.3 (210)	40.4 (1027)	24.8 (630)	51.5 (1309)	15.5 (394)	25 (636)	7.9 (200)	1078 (489)	793 (360)	D
	CRE 45-1-1	3	UL	7.5 (5.5)		39.1 (994)	57.5 (1460)	8.3 (210)	40.4 (1027)	24.8 (630)	51.5 (1309)	15.5 (394)	25 (636)	7.9 (200)	1060 (481)	776 (352)	D
	CRE 45-1	3	UL	10 (7.5)		40.1 (1018)	57.5 (1460)	8.3 (210)	40.4 (1027)	24.8 (630)	51.5 (1309)	15.5 (394)	25 (636)	7.9 (200)	1106 (502)	822 (373)	D
	CRE 45-2	3	UL	15 (11)		49.8 (1265)	57.5 (1460)	9.8 (250)	40.4 (1027)	24.8 (630)	51.5 (1309)	15.5 (394)	25 (636)	7.9 (200)	1230 (558)	945 (429)	D
	CRE 45-3-2	3	UL	20 (15)		56.2 (1428)	57.5 (1460)	9.8 (250)	40.4 (1027)	24.8 (630)	51.5 (1309)	15.5 (394)	25 (636)	7.9 (200)	1553 (705)	1269 (576)	D
	CRE 45-3	3	UL	25 (18)		60.2 (1528)	57.5 (1460)	9.8 (250)	40.4 (1027)	24.8 (630)	51.5 (1309)	15.5 (394)	25 (636)	7.9 (200)	1611 (731)	1326 (602)	D
3	CRE 45-1-1	3	UK	7.5 (5.5)	6" Class 150	40.1 (1018)	57.5 (1460)	8.3 (210)	60.1 (1527)	24.8 (630)	51.5 (1309)	15.5 (394)	25 (636)	7.9 (200)	1465 (665)	1113 (505)	D
	CRE 45-1-1	3	UL	7.5 (5.5)		39.1 (994)	57.5 (1460)	8.3 (210)	60.1 (1527)	24.8 (630)	51.5 (1309)	15.5 (394)	25 (636)	7.9 (200)	1434 (651)	1082 (491)	D
	CRE 45-1	3	UL	10 (7.5)		40.1 (1018)	57.5 (1460)	8.3 (210)	60.1 (1527)	24.8 (630)	51.5 (1309)	15.5 (394)	25 (636)	7.9 (200)	1507 (684)	1155 (524)	D
	CRE 45-2	3	UL	15 (11)		49.8 (1265)	57.5 (1460)	9.8 (250)	60.1 (1527)	24.8 (630)	51.5 (1309)	15.5 (394)	25 (636)	7.9 (200)	1692 (768)	1340 (608)	D
	CRE 45-3-2	3	UL	20 (15)		56.2 (1428)	57.5 (1460)	9.8 (250)	60.1 (1527)	24.8 (630)	51.5 (1309)	15.5 (394)	25 (636)	7.9 (200)	2174 (987)	1822 (827)	D
	CRE 45-3	3	UL	25 (18)		60.2 (1528)	57.5 (1460)	9.8 (250)	60.1 (1527)	24.8 (630)	51.5 (1309)	15.5 (394)	25 (636)	7.9 (200)	2260 (1026)	1908 (866)	D

Number of pumps	Pump type	Mains phases	Voltage code	Motor power [hp (kW)]	Connection size	A [in (mm)]	A1 [in (mm)]	A2 [in (mm)]	B [in (mm)]	B1 [in (mm)]	C [in (mm)]	C1 [in (mm)]	C2 [in (mm)]	C3 [in (mm)]	Gross weight [lbs (kg)]	Net weight [lbs (kg)]	Design
4	CRE 45-1-1	3	UK	7.5 (5.5)	8" Class 150	41.7 (1058)	57.5 (1460)	9.8 (250)	79.9 (2030)	24.8 (630)	55.6 (1413)	16.3 (414)	25.8 (656)	7.9 (200)	1989 (903)	1516 (688)	D
	CRE 45-1-1	3	UL	7.5 (5.5)		40.7 (1034)	57.5 (1460)	9.8 (250)	79.9 (2030)	24.8 (630)	55.6 (1413)	16.3 (414)	25.8 (656)	7.9 (200)	1950 (885)	1476 (670)	D
	CRE 45-1	3	UL	10 (7.5)		41.7 (1058)	57.5 (1460)	9.8 (250)	79.9 (2030)	24.8 (630)	55.6 (1413)	16.3 (414)	25.8 (656)	7.9 (200)	2047 (929)	1573 (714)	D
	CRE 45-2	3	UL	15 (11)		49.8 (1265)	57.5 (1460)	9.8 (250)	79.9 (2030)	24.8 (630)	55.6 (1413)	16.3 (414)	25.8 (656)	7.9 (200)	2265 (1028)	1791 (813)	D
	CRE 45-3-2	3	UL	20 (15)		56.2 (1428)	57.5 (1460)	9.8 (250)	79.9 (2030)	24.8 (630)	55.6 (1413)	16.3 (414)	25.8 (656)	7.9 (200)	2939 (1334)	2465 (1119)	D
	CRE 45-3	3	UL	25 (18)		60.2 (1528)	57.5 (1460)	9.8 (250)	79.9 (2030)	24.8 (630)	55.6 (1413)	16.3 (414)	25.8 (656)	7.9 (200)	3056 (1387)	2582 (1172)	D
5	CRE 45-1-1	3	UK	7.5 (5.5)	8" Class 150	41.7 (1058)	57.5 (1460)	9.8 (250)	99.6 (2530)	24.8 (630)	55.6 (1413)	16.3 (414)	25.8 (656)	7.9 (200)	2463 (1118)	1899 (862)	D
	CRE 45-1-1	3	UL	7.5 (5.5)		40.7 (1034)	57.5 (1460)	9.8 (250)	99.6 (2530)	24.8 (630)	55.6 (1413)	16.3 (414)	25.8 (656)	7.9 (200)	2412 (1095)	1848 (839)	D
	CRE 45-1	3	UL	10 (7.5)		41.7 (1058)	57.5 (1460)	9.8 (250)	99.6 (2530)	24.8 (630)	55.6 (1413)	16.3 (414)	25.8 (656)	7.9 (200)	2533 (1150)	1970 (894)	D
	CRE 45-2	3	UL	15 (11)		49.8 (1265)	57.5 (1460)	9.8 (250)	99.6 (2530)	24.8 (630)	55.6 (1413)	16.3 (414)	25.8 (656)	7.9 (200)	2807 (1274)	2243 (1018)	D
	CRE 45-3-2	3	UL	20 (15)		56.2 (1428)	57.5 (1460)	9.8 (250)	99.6 (2530)	32.7 (830)	55.6 (1413)	16.3 (414)	25.8 (656)	11.8 (300)	3674 (1668)	3111 (1412)	D
	CRE 45-3	3	UL	25 (18)		60.2 (1528)	57.5 (1460)	9.8 (250)	99.6 (2530)	32.7 (830)	55.6 (1413)	16.3 (414)	25.8 (656)	11.8 (300)	3822 (1735)	3258 (1479)	D
6	CRE 45-1-1	3	UK	7.5 (5.5)	10" Class 150	44 (1118)	57.5 (1460)	12.2 (310)	119.4 (3032)	24.8 (630)	62 (1574)	18.2 (463)	27.8 (705)	7.9 (200)	3326 (1510)	2690 (1221)	D
	CRE 45-1-1	3	UL	7.5 (5.5)		43.1 (1094)	57.5 (1460)	12.2 (310)	119.4 (3032)	24.8 (630)	62 (1574)	18.2 (463)	27.8 (705)	7.9 (200)	3267 (1483)	2630 (1194)	D
	CRE 45-1	3	UL	10 (7.5)		44 (1118)	57.5 (1460)	12.2 (310)	119.4 (3032)	24.8 (630)	62 (1574)	18.2 (463)	27.8 (705)	7.9 (200)	3410 (1548)	2774 (1259)	D
	CRE 45-2	3	UL	15 (11)		52.2 (1325)	57.5 (1460)	12.2 (310)	119.4 (3032)	24.8 (630)	62 (1574)	18.2 (463)	27.8 (705)	7.9 (200)	3738 (1697)	3102 (1408)	D
	CRE 45-3-2	3	UL	20 (15)		58.6 (1488)	57.5 (1460)	12.2 (310)	119.4 (3032)	32.7 (830)	62 (1574)	18.2 (463)	27.8 (705)	11.8 (300)	4756 (2159)	4119 (1870)	D
	CRE 45-3	3	UL	25 (18)		62.5 (1588)	57.5 (1460)	12.2 (310)	119.4 (3032)	32.7 (830)	62 (1574)	18.2 (463)	27.8 (705)	11.8 (300)	4932 (2239)	4296 (1950)	D

Dimensions may vary by ± 0.5 inch (12.7 mm).

Hydro MPC-E with CR, CRE 64

Hydro MPC-E with CR 64

Number of pumps	Pump type	Mains phases	Voltage code	Motor power [hp (kW)]	Connection size	A [in (mm)]	A1 [in (mm)]	A2 [in (mm)]	B [in (mm)]	B1 [in (mm)]	C [in (mm)]	C1 [in (mm)]	C2 [in (mm)]	C3 [in (mm)]	Gross weight [lbs (kg)]	Net weight [lbs (kg)]	Design
2	CR 64-1-1	3	UL	10 (7.5)	6" Class 150	43.9 (1114)	59.1 (1500)	8.3 (210)	40.4 (1027)	35.4 (900)	54.3 (1379)	16.6 (421)	26.7 (679)	15.7 (400)	1498 (680)	1214 (551)	C
	CR 64-1	3	UL	15 (11)		49.4 (1255)	59.1 (1500)	9.8 (250)	40.4 (1027)	35.4 (900)	54.3 (1379)	16.6 (421)	26.7 (679)	15.7 (400)	1595 (724)	1311 (595)	C
	CR 64-2-1	3	UL	20 (15)		52.7 (1338)	59.1 (1500)	9.8 (250)	40.4 (1027)	35.4 (900)	54.3 (1379)	16.6 (421)	26.7 (679)	15.7 (400)	1606 (729)	1322 (600)	C
	CR 64-2	3	UL	25 (18)		56.2 (1427)	59.1 (1500)	9.8 (250)	40.4 (1027)	35.4 (900)	54.3 (1379)	16.6 (421)	26.7 (679)	15.7 (400)	1897 (861)	1613 (732)	C
	CR 64-3-2	3	UL	30 (22)		59.4 (1509)	74.8 (1900)	9.8 (250)	40.4 (1027)	47.2 (1200)	54.3 (1379)	16.6 (421)	26.7 (679)	19.7 (500)	1978 (898)	1681 (763)	C
3	CR 64-1-1	3	UL	10 (7.5)	8" Class 150	45.4 (1154)	59.1 (1500)	9.8 (250)	60.2 (1530)	35.4 (900)	56.4 (1433)	16.4 (416)	26.5 (674)	15.7 (400)	2212 (1004)	1738 (789)	C
	CR 64-1	3	UL	15 (11)		49.4 (1255)	74.8 (1900)	9.8 (250)	60.2 (1530)	47.2 (1200)	56.4 (1433)	16.4 (416)	26.5 (674)	19.7 (500)	2355 (1069)	1875 (851)	C
	CR 64-2-1	3	UL	20 (15)		52.7 (1338)	74.8 (1900)	9.8 (250)	60.2 (1530)	47.2 (1200)	56.4 (1433)	16.4 (416)	26.5 (674)	19.7 (500)	2373 (1077)	1893 (859)	C
	CR 64-2	3	UL	25 (18)		56.2 (1427)	74.8 (1900)	9.8 (250)	60.2 (1530)	47.2 (1200)	56.4 (1433)	16.4 (416)	26.5 (674)	19.7 (500)	2802 (1272)	2322 (1054)	C
	CR 64-3-2	3	UL	30 (22)		59.4 (1509)	74.8 (1900)	9.8 (250)	60.2 (1530)	47.2 (1200)	56.4 (1433)	16.4 (416)	26.5 (674)	19.7 (500)	2895 (1314)	2415 (1096)	C
4	CR 64-1-1	3	UL	10 (7.5)	8" Class 150	45.4 (1154)	59.1 (1500)	9.8 (250)	79.9 (2030)	35.4 (900)	56.4 (1433)	16.4 (416)	26.5 (674)	15.7 (400)	2771 (1258)	2207 (1002)	C
	CR 64-1	3	UL	15 (11)		49.4 (1255)	74.8 (1900)	9.8 (250)	79.9 (2030)	47.2 (1200)	56.4 (1433)	16.4 (416)	26.5 (674)	19.7 (500)	2959 (1343)	2386 (1083)	C
	CR 64-2-1	3	UL	20 (15)		52.7 (1338)	74.8 (1900)	9.8 (250)	79.9 (2030)	47.2 (1200)	56.4 (1433)	16.4 (416)	26.5 (674)	19.7 (500)	2985 (1355)	2412 (1095)	C
	CR 64-2	3	UL	25 (18)		56.2 (1427)	74.8 (1900)	9.8 (250)	79.9 (2030)	47.2 (1200)	56.4 (1433)	16.4 (416)	26.5 (674)	19.7 (500)	3556 (1614)	2983 (1354)	C
	CR 64-3-2	3	UL	30 (22)		59.4 (1509)	82.7 (2100)	9.8 (250)	79.9 (2030)	63 (1600)	56.4 (1433)	16.4 (416)	26.5 (674)	19.7 (500)	3939 (1788)	3366 (1528)	C
5	CR 64-1-1	3	UL	10 (7.5)	10" Class 150	47.8 (1214)	74.8 (1900)	12.2 (310)	99.7 (2532)	47.2 (1200)	64.3 (1632)	19.1 (484)	29.2 (742)	19.7 (500)	3837 (1742)	3192 (1449)	C
	CR 64-1	3	UL	15 (11)		51.8 (1315)	82.7 (2100)	12.2 (310)	99.7 (2532)	63 (1600)	64.3 (1632)	19.1 (484)	29.2 (742)	19.7 (500)	4315 (1959)	3670 (1666)	C
	CR 64-2-1	3	UL	20 (15)		55 (1398)	82.7 (2100)	12.2 (310)	99.7 (2532)	63 (1600)	64.3 (1632)	19.1 (484)	29.2 (742)	19.7 (500)	4344 (1972)	3699 (1679)	C
	CR 64-2	3	UL	25 (18)		58.5 (1487)	82.7 (2100)	12.2 (310)	99.7 (2532)	63 (1600)	64.3 (1632)	19.1 (484)	29.2 (742)	19.7 (500)	5058 (2296)	4412 (2003)	C
	CR 64-3-2	3	UL	30 (22)		61.8 (1569)	82.7 (2100)	12.2 (310)	99.7 (2532)	70.9 (1800)	64.3 (1632)	19.1 (484)	29.2 (742)	19.7 (500)	5210 (2365)	4637 (2105)	C
6	CR 64-1-1	3	UL	10 (7.5)	12" Class 150	47.8 (1214)	74.8 (1900)	12.2 (310)	119.4 (3034)	47.2 (1200)	68.9 (1751)	19.9 (505)	30 (763)	19.7 (500)	4699 (2133)	4062 (1844)	C
	CR 64-1	3	UL	15 (11)		51.8 (1315)	82.7 (2100)	12.2 (310)	119.4 (3034)	63 (1600)	68.9 (1751)	19.9 (505)	30 (763)	19.7 (500)	5221 (2370)	4584 (2081)	C
	CR 64-2-1	3	UL	20 (15)		55 (1398)	82.7 (2100)	12.2 (310)	119.4 (3034)	63 (1600)	68.9 (1751)	19.9 (505)	30 (763)	19.7 (500)	5252 (2384)	4615 (2095)	C
	CR 64-2	3	UL	25 (18)		58.5 (1487)	82.7 (2100)	12.2 (310)	119.4 (3034)	63 (1600)	68.9 (1751)	19.9 (505)	30 (763)	19.7 (500)	6124 (2780)	5487 (2491)	C
	CR 64-3-2	3	UL	30 (22)		61.8 (1569)	82.7 (2100)	12.2 (310)	119.4 (3034)	70.9 (1800)	68.9 (1751)	19.9 (505)	30 (763)	19.7 (500)	6373 (2893)	5727 (2600)	C

Technical data, Hydro MPC-E, 60 Hz

Dimensions may vary by ± 0.5 inch (12.7 mm).

Hydro MPC-E with CRE 64

Number of pumps	Pump type	Mains phases	Voltage code	Motor power [hp (kW)]	Connection size	A [in (mm)]	A1 [in (mm)]	A2 [in (mm)]	B [in (mm)]	B1 [in (mm)]	C [in (mm)]	C1 [in (mm)]	C2 [in (mm)]	C3 [in (mm)]	Gross weight [lbs (kg)]	Net weight [lbs (kg)]	Design
2	CRE 64-1-1	3	UL	10 (7.5)	6" Class 150	40.2 (1020)	57.5 (1460)	8.3 (210)	40.4 (1027)	24.8 (630)	54.3 (1379)	16.6 (421)	26.7 (679)	7.9 (200)	1179 (535)	895 (406)	D
	CRE 64-1	3	UL	15 (11)		46.7 (1187)	57.5 (1460)	9.8 (250)	40.4 (1027)	24.8 (630)	54.3 (1379)	16.6 (421)	26.7 (679)	7.9 (200)	1285 (583)	1000 (454)	D
	CRE 64-2-1	3	UL	20 (15)		53.3 (1353)	57.5 (1460)	9.8 (250)	40.4 (1027)	24.8 (630)	54.3 (1379)	16.6 (421)	26.7 (679)	7.9 (200)	1611 (731)	1326 (602)	D
	CRE 64-2	3	UL	25 (18)		57.2 (1453)	57.5 (1460)	9.8 (250)	40.4 (1027)	24.8 (630)	54.3 (1379)	16.6 (421)	26.7 (679)	7.9 (200)	1668 (757)	1384 (628)	D
	CRE 64-3-2	3	UL	30 (22)		60.4 (1535)	57.5 (1460)	9.8 (250)	40.4 (1027)	24.8 (630)	54.3 (1379)	16.6 (421)	26.7 (679)	7.9 (200)	1741 (790)	1456 (661)	D
3	CRE 64-1-1	3	UL	10 (7.5)	8" Class 150	41.7 (1060)	57.5 (1460)	9.8 (250)	60.2 (1530)	24.8 (630)	56.4 (1433)	16.4 (416)	26.5 (674)	7.9 (200)	1811 (822)	1337 (607)	D
	CRE 64-1	3	UL	15 (11)		46.7 (1187)	57.5 (1460)	9.8 (250)	60.2 (1530)	24.8 (630)	56.4 (1433)	16.4 (416)	26.5 (674)	7.9 (200)	1950 (885)	1476 (670)	D
	CRE 64-2-1	3	UL	20 (15)		53.3 (1353)	57.5 (1460)	9.8 (250)	60.2 (1530)	24.8 (630)	56.4 (1433)	16.4 (416)	26.5 (674)	7.9 (200)	2437 (1106)	1963 (891)	D
	CRE 64-2	3	UL	25 (18)		57.2 (1453)	57.5 (1460)	9.8 (250)	60.2 (1530)	24.8 (630)	56.4 (1433)	16.4 (416)	26.5 (674)	7.9 (200)	2522 (1145)	2049 (930)	D
	CRE 64-3-2	3	UL	30 (22)		60.4 (1535)	57.5 (1460)	9.8 (250)	60.2 (1530)	24.8 (630)	56.4 (1433)	16.4 (416)	26.5 (674)	7.9 (200)	2630 (1194)	2157 (979)	D
4	CRE 64-1-1	3	UL	10 (7.5)	8" Class 150	41.7 (1060)	57.5 (1460)	9.8 (250)	79.9 (2030)	24.8 (630)	56.4 (1433)	16.4 (416)	26.5 (674)	7.9 (200)	2196 (997)	1723 (782)	D
	CRE 64-1	3	UL	15 (11)		46.7 (1187)	57.5 (1460)	9.8 (250)	79.9 (2030)	24.8 (630)	56.4 (1433)	16.4 (416)	26.5 (674)	7.9 (200)	2384 (1082)	1910 (867)	D
	CRE 64-2-1	3	UL	20 (15)		53.3 (1353)	57.5 (1460)	9.8 (250)	79.9 (2030)	24.8 (630)	56.4 (1433)	16.4 (416)	26.5 (674)	7.9 (200)	3062 (1390)	2589 (1175)	D
	CRE 64-2	3	UL	25 (18)		57.2 (1453)	57.5 (1460)	9.8 (250)	79.9 (2030)	24.8 (630)	56.4 (1433)	16.4 (416)	26.5 (674)	7.9 (200)	3181 (1444)	2707 (1229)	D
	CRE 64-3-2	3	UL	30 (22)		60.4 (1535)	57.5 (1460)	9.8 (250)	79.9 (2030)	24.8 (630)	56.4 (1433)	16.4 (416)	26.5 (674)	7.9 (200)	3324 (1509)	2851 (1294)	D
5	CRE 64-1-1	3	UL	10 (7.5)	10" Class 150	44.1 (1120)	57.5 (1460)	12.2 (310)	99.7 (2532)	24.8 (630)	64.3 (1632)	19.1 (484)	29.2 (742)	7.9 (200)	3190 (1448)	2626 (1192)	D
	CRE 64-1	3	UL	15 (11)		49.1 (1247)	57.5 (1460)	12.2 (310)	99.7 (2532)	24.8 (630)	64.3 (1632)	19.1 (484)	29.2 (742)	7.9 (200)	3423 (1554)	2859 (1298)	D
	CRE 64-2-1	3	UL	20 (15)		55.6 (1413)	57.5 (1460)	12.2 (310)	99.7 (2532)	32.7 (830)	64.3 (1632)	19.1 (484)	29.2 (742)	11.8 (300)	4296 (1950)	3732 (1694)	D
	CRE 64-2	3	UL	25 (18)		59.6 (1513)	57.5 (1460)	12.2 (310)	99.7 (2532)	32.7 (830)	64.3 (1632)	19.1 (484)	29.2 (742)	11.8 (300)	4443 (2017)	3879 (1761)	D
	CRE 64-3-2	3	UL	30 (22)		62.8 (1595)	57.5 (1460)	12.2 (310)	99.7 (2532)	32.7 (830)	64.3 (1632)	19.1 (484)	29.2 (742)	11.8 (300)	4624 (2099)	4060 (1843)	D
6	CRE 64-1-1	3	UL	10 (7.5)	12" Class 150	44.1 (1120)	57.5 (1460)	12.2 (310)	119.4 (3034)	24.8 (630)	68.9 (1751)	19.9 (505)	30 (763)	7.9 (200)	4060 (1843)	3423 (1554)	D
	CRE 64-1	3	UL	15 (11)		49.1 (1247)	57.5 (1460)	12.2 (310)	119.4 (3034)	24.8 (630)	68.9 (1751)	19.9 (505)	30 (763)	7.9 (200)	4340 (1970)	3703 (1681)	D
	CRE 64-2-1	3	UL	20 (15)		55.6 (1413)	57.5 (1460)	12.2 (310)	119.4 (3034)	32.7 (830)	68.9 (1751)	19.9 (505)	30 (763)	11.8 (300)	5364 (2435)	4727 (2146)	D
	CRE 64-2	3	UL	25 (18)		59.6 (1513)	57.5 (1460)	12.2 (310)	119.4 (3034)	32.7 (830)	68.9 (1751)	19.9 (505)	30 (763)	11.8 (300)	5542 (2516)	4906 (2227)	D
	CRE 64-3-2	3	UL	30 (22)		62.8 (1595)	57.5 (1460)	12.2 (310)	119.4 (3034)	32.7 (830)	68.9 (1751)	19.9 (505)	30 (763)	11.8 (300)	5758 (2614)	5122 (2325)	D

Dimensions may vary by ± 0.5 inch (12.7 mm).

Hydro MPC-E with CR, CRE 95

Hydro MPC-E with CR 95

Number of pumps	Pump type	Mains phases	Voltage code	Motor power [hp (kW)]	Connection size	A [in (mm)]	A1 [in (mm)]	A2 [in (mm)]	B [in (mm)]	B1 [in (mm)]	C [in (mm)]	C1 [in (mm)]	C2 [in (mm)]	C3 [in (mm)]	Gross weight [lbs (kg)]	Net weight [lbs (kg)]	Design
2	CR 95-1-1	3	UL	15 (11)	8" Class 150	52.6 (1336)	59.1 (1500)	11.9 (302)	40.6 (1030)	35.4 (900)	84.5 (2146)	29.3 (745)	41.7 (1058)	15.7 (400)	2219 (1007)	1811 (822)	C
	CR 95-1	3	UL	20 (15)		53.4 (1356)	59.1 (1500)	11.9 (302)	40.6 (1030)	35.4 (900)	84.5 (2146)	29.3 (745)	41.7 (1058)	15.7 (400)	2300 (1044)	1893 (859)	C
	CR 95-2-2	3	UL	25 (18)		61.5 (1561)	59.1 (1500)	11.9 (302)	40.6 (1030)	35.4 (900)	84.5 (2146)	29.3 (745)	41.7 (1058)	15.7 (400)	2674 (1214)	2267 (1029)	C
	CR 95-2	3	UL	30 (22)		61.5 (1561)	74.8 (1900)	11.9 (302)	40.6 (1030)	47.2 (1200)	84.5 (2146)	29.3 (745)	41.7 (1058)	19.7 (500)	2776 (1260)	2340 (1062)	C
	CR 95-2-1	3	UL	30 (22)		61.5 (1561)	74.8 (1900)	11.9 (302)	40.6 (1030)	47.2 (1200)	84.5 (2146)	29.3 (745)	41.7 (1058)	19.7 (500)	2776 (1260)	2340 (1062)	C
3	CR 95-1-1	3	UL	15 (11)	8" Class 150	52.6 (1336)	74.8 (1900)	11.9 (302)	60.2 (1530)	47.2 (1200)	84.5 (2146)	29.3 (745)	41.7 (1058)	19.7 (500)	3082 (1399)	2553 (1159)	C
	CR 95-1	3	UL	20 (15)		53.4 (1356)	74.8 (1900)	11.9 (302)	60.2 (1530)	47.2 (1200)	84.5 (2146)	29.3 (745)	41.7 (1058)	19.7 (500)	3207 (1456)	2679 (1216)	C
	CR 95-2-2	3	UL	25 (18)		61.5 (1561)	74.8 (1900)	11.9 (302)	60.2 (1530)	47.2 (1200)	84.5 (2146)	29.3 (745)	41.7 (1058)	19.7 (500)	3763 (1708)	3234 (1468)	C
	CR 95-2	3	UL	30 (22)		61.5 (1561)	74.8 (1900)	11.9 (302)	60.2 (1530)	47.2 (1200)	84.5 (2146)	29.3 (745)	41.7 (1058)	19.7 (500)	3862 (1753)	3333 (1513)	C
	CR 95-2-1	3	UL	30 (22)		61.5 (1561)	74.8 (1900)	11.9 (302)	60.2 (1530)	47.2 (1200)	84.5 (2146)	29.3 (745)	41.7 (1058)	19.7 (500)	3862 (1753)	3333 (1513)	C
4	CR 95-1-1	3	UL	15 (11)	10" Class 150	52.6 (1336)	74.8 (1900)	11.9 (302)	80 (2032)	47.2 (1200)	87 (2211)	29.4 (746)	41.7 (1059)	19.7 (500)	4432 (2012)	3815 (1732)	C
	CR 95-1	3	UL	20 (15)		53.4 (1356)	74.8 (1900)	11.9 (302)	80 (2032)	47.2 (1200)	87 (2211)	29.4 (746)	41.7 (1059)	19.7 (500)	4597 (2087)	3981 (1807)	C
	CR 95-2-2	3	UL	25 (18)		61.5 (1561)	74.8 (1900)	11.9 (302)	80 (2032)	47.2 (1200)	87 (2211)	29.4 (746)	41.7 (1059)	19.7 (500)	5340 (2424)	4723 (2144)	C
	CR 95-2	3	UL	30 (22)		61.5 (1561)	82.7 (2100)	11.9 (302)	80 (2032)	63 (1600)	87 (2211)	29.4 (746)	41.7 (1059)	19.7 (500)	5734 (2603)	5117 (2323)	C
	CR 95-2-1	3	UL	30 (22)		61.5 (1561)	82.7 (2100)	11.9 (302)	80 (2032)	63 (1600)	87 (2211)	29.4 (746)	41.7 (1059)	19.7 (500)	5734 (2603)	5117 (2323)	C
5	CR 95-1-1	3	UL	15 (11)	12" Class 150	52.6 (1336)	82.7 (2100)	11.9 (302)	99.8 (2534)	63 (1600)	92.4 (2348)	30.6 (776)	42.9 (1089)	19.7 (500)	6100 (2769)	5406 (2454)	C
	CR 95-1	3	UL	20 (15)		53.4 (1356)	82.7 (2100)	11.9 (302)	99.8 (2534)	63 (1600)	92.4 (2348)	30.6 (776)	42.9 (1089)	19.7 (500)	6302 (2861)	5608 (2546)	C
	CR 95-2-2	3	UL	25 (18)		61.5 (1561)	82.7 (2100)	11.9 (302)	99.8 (2534)	63 (1600)	92.4 (2348)	30.6 (776)	42.9 (1089)	19.7 (500)	7230 (3282)	6536 (2967)	C
	CR 95-2	3	UL	30 (22)		61.5 (1561)	82.7 (2100)	11.9 (302)	99.8 (2534)	70.9 (1800)	92.4 (2348)	30.6 (776)	42.9 (1089)	19.7 (500)	7388 (3354)	6771 (3074)	C
	CR 95-2-1	3	UL	30 (22)		61.5 (1561)	82.7 (2100)	11.9 (302)	99.8 (2534)	70.9 (1800)	92.4 (2348)	30.6 (776)	42.9 (1089)	19.7 (500)	7388 (3354)	6771 (3074)	C
6	CR 95-1-1	3	UL	15 (11)	14" Class 150	52.6 (1336)	82.7 (2100)	11.9 (302)	119.6 (3037)	63 (1600)	95.6 (2428)	31.1 (791)	43.5 (1104)	19.7 (500)	7241 (3287)	6560 (2978)	C
	CR 95-1	3	UL	20 (15)		53.4 (1356)	82.7 (2100)	11.9 (302)	119.6 (3037)	63 (1600)	95.6 (2428)	31.1 (791)	43.5 (1104)	19.7 (500)	7483 (3397)	6802 (3088)	C
	CR 95-2-2	3	UL	25 (18)		61.5 (1561)	82.7 (2100)	11.9 (302)	119.6 (3037)	63 (1600)	95.6 (2428)	31.1 (791)	43.5 (1104)	19.7 (500)	8608 (3908)	7928 (3599)	C
	CR 95-2	3	UL	30 (22)		61.5 (1561)	82.7 (2100)	11.9 (302)	119.6 (3037)	70.9 (1800)	95.6 (2428)	31.1 (791)	43.5 (1104)	19.7 (500)	8866 (4025)	8185 (3716)	C
	CR 95-2-1	3	UL	30 (22)		61.5 (1561)	82.7 (2100)	11.9 (302)	119.6 (3037)	70.9 (1800)	95.6 (2428)	31.1 (791)	43.5 (1104)	19.7 (500)	8866 (4025)	8185 (3716)	C

Dimensions may vary by ± 0.5 inch (12.7 mm).

Hydro MPC-E with CRE 95

Number of pumps	Pump type	Mains phases	Voltage code	Motor power [hp (kW)]	Connection size	A [in (mm)]	A1 [in (mm)]	A2 [in (mm)]	B [in (mm)]	B1 [in (mm)]	C [in (mm)]	C1 [in (mm)]	C2 [in (mm)]	C3 [in (mm)]	Gross weight [lbs (kg)]	Net weight [lbs (kg)]	Design
2	CRE 95-1-1	3	UL	15 (11)	8" Class 150	49.8 (1264)	57.5 (1460)	11.9 (302)	40.6 (1030)	24.8 (630)	84.5 (2146)	29.3 (745)	41.7 (1058)	7.9 (200)	1882 (854)	1474 (669)	D
	CRE 95-1	3	UL	20 (15)		52.6 (1336)	57.5 (1460)	11.9 (302)	40.6 (1030)	24.8 (630)	84.5 (2146)	29.3 (745)	41.7 (1058)	7.9 (200)	2192 (995)	1785 (810)	D
	CRE 95-2-2	3	UL	25 (18)		60.6 (1540)	57.5 (1460)	11.9 (302)	40.6 (1030)	24.8 (630)	84.5 (2146)	29.3 (745)	41.7 (1058)	7.9 (200)	2278 (1034)	1870 (849)	D
	CRE 95-2	3	UL	30 (22)		60.6 (1540)	57.5 (1460)	11.9 (302)	40.6 (1030)	24.8 (630)	84.5 (2146)	29.3 (745)	41.7 (1058)	7.9 (200)	2331 (1058)	1923 (873)	D
	CRE 95-2-1	3	UL	30 (22)		60.6 (1540)	57.5 (1460)	11.9 (302)	40.6 (1030)	24.8 (630)	84.5 (2146)	29.3 (745)	41.7 (1058)	7.9 (200)	2331 (1058)	1923 (873)	D
3	CRE 95-1-1	3	UL	15 (11)	8" Class 150	49.8 (1264)	57.5 (1460)	11.9 (302)	60.2 (1530)	24.8 (630)	84.5 (2146)	29.3 (745)	41.7 (1058)	7.9 (200)	2635 (1196)	2117 (961)	D
	CRE 95-1	3	UL	20 (15)		52.6 (1336)	57.5 (1460)	11.9 (302)	60.2 (1530)	24.8 (630)	84.5 (2146)	29.3 (745)	41.7 (1058)	7.9 (200)	3097 (1406)	2580 (1171)	D
	CRE 95-2-2	3	UL	25 (18)		60.6 (1540)	57.5 (1460)	11.9 (302)	60.2 (1530)	24.8 (630)	84.5 (2146)	29.3 (745)	41.7 (1058)	7.9 (200)	3223 (1463)	2705 (1228)	D
	CRE 95-2	3	UL	30 (22)		60.6 (1540)	57.5 (1460)	11.9 (302)	60.2 (1530)	24.8 (630)	84.5 (2146)	29.3 (745)	41.7 (1058)	7.9 (200)	3302 (1499)	2785 (1264)	D
	CRE 95-2-1	3	UL	30 (22)		60.6 (1540)	57.5 (1460)	11.9 (302)	60.2 (1530)	24.8 (630)	84.5 (2146)	29.3 (745)	41.7 (1058)	7.9 (200)	3302 (1499)	2785 (1264)	D
4	CRE 95-1-1	3	UL	15 (11)	10" Class 150	49.8 (1264)	57.5 (1460)	11.9 (302)	80 (2032)	24.8 (630)	87 (2211)	29.4 (746)	41.7 (1059)	7.9 (200)	3897 (1769)	3289 (1493)	D
	CRE 95-1	3	UL	20 (15)		52.6 (1336)	57.5 (1460)	11.9 (302)	80 (2032)	24.8 (630)	87 (2211)	29.4 (746)	41.7 (1059)	7.9 (200)	4542 (2062)	3934 (1786)	D
	CRE 95-2-2	3	UL	25 (18)		60.6 (1540)	57.5 (1460)	11.9 (302)	80 (2032)	24.8 (630)	87 (2211)	29.4 (746)	41.7 (1059)	7.9 (200)	4714 (2140)	4106 (1864)	D
	CRE 95-2	3	UL	30 (22)		60.6 (1540)	57.5 (1460)	11.9 (302)	80 (2032)	24.8 (630)	87 (2211)	29.4 (746)	41.7 (1059)	7.9 (200)	4820 (2188)	4212 (1912)	D
	CRE 95-2-1	3	UL	30 (22)		60.6 (1540)	57.5 (1460)	11.9 (302)	80 (2032)	24.8 (630)	87 (2211)	29.4 (746)	41.7 (1059)	7.9 (200)	4820 (2188)	4212 (1912)	D
5	CRE 95-1-1	3	UL	15 (11)	12" Class 150	49.8 (1264)	57.5 (1460)	11.9 (302)	99.8 (2534)	24.8 (630)	92.4 (2348)	30.6 (776)	42.9 (1089)	7.9 (200)	5137 (2332)	4529 (2056)	D
	CRE 95-1	3	UL	20 (15)		52.6 (1336)	57.5 (1460)	11.9 (302)	99.8 (2534)	32.7 (830)	92.4 (2348)	30.6 (776)	42.9 (1089)	11.8 (300)	5972 (2711)	5364 (2435)	D
	CRE 95-2-2	3	UL	25 (18)		60.6 (1540)	57.5 (1460)	11.9 (302)	99.8 (2534)	32.7 (830)	92.4 (2348)	30.6 (776)	42.9 (1089)	11.8 (300)	6188 (2809)	5580 (2533)	D
	CRE 95-2	3	UL	30 (22)		60.6 (1540)	57.5 (1460)	11.9 (302)	99.8 (2534)	32.7 (830)	92.4 (2348)	30.6 (776)	42.9 (1089)	11.8 (300)	6320 (2869)	5712 (2593)	D
	CRE 95-2-1	3	UL	30 (22)		60.6 (1540)	57.5 (1460)	11.9 (302)	99.8 (2534)	32.7 (830)	92.4 (2348)	30.6 (776)	42.9 (1089)	11.8 (300)	6320 (2869)	5712 (2593)	D
6	CRE 95-1-1	3	UL	15 (11)	14" Class 150	49.8 (1264)	57.5 (1460)	11.9 (302)	119.6 (3037)	24.8 (630)	95.6 (2428)	31.1 (791)	43.5 (1104)	7.9 (200)	6285 (2853)	5604 (2544)	D
	CRE 95-1	3	UL	20 (15)		52.6 (1336)	57.5 (1460)	11.9 (302)	119.6 (3037)	32.7 (830)	95.6 (2428)	31.1 (791)	43.5 (1104)	11.8 (300)	7260 (3296)	6580 (2987)	D
	CRE 95-2-2	3	UL	25 (18)		60.6 (1540)	57.5 (1460)	11.9 (302)	119.6 (3037)	32.7 (830)	95.6 (2428)	31.1 (791)	43.5 (1104)	11.8 (300)	7520 (3414)	6840 (3105)	D
	CRE 95-2	3	UL	30 (22)		60.6 (1540)	57.5 (1460)	11.9 (302)	119.6 (3037)	32.7 (830)	95.6 (2428)	31.1 (791)	43.5 (1104)	11.8 (300)	7679 (3486)	6998 (3177)	D
	CRE 95-2-1	3	UL	30 (22)		60.6 (1540)	57.5 (1460)	11.9 (302)	119.6 (3037)	32.7 (830)	95.6 (2428)	31.1 (791)	43.5 (1104)	11.8 (300)	7679 (3486)	6998 (3177)	D

Dimensions may vary by ± 0.5 inch (12.7 mm).

Hydro MPC-E with CR, CRE 125

Hydro MPC-E with CR 125

Number of pumps	Pump type	Mains phases	Voltage code	Motor power [hp (kW)]	Connection size	A [in (mm)]	A1 [in (mm)]	A2 [in (mm)]	B [in (mm)]	B1 [in (mm)]	C [in (mm)]	C1 [in (mm)]	C2 [in (mm)]	C3 [in (mm)]	Gross weight [lbs (kg)]	Net weight [lbs (kg)]	Design
2	CR 125-1-1	3	UL	20 (15)	8" Class 150	59.1 (1501)	59.2 (1504)	16.9 (429)	52.4 (1331)	35.4 (899)	87.2 (2215)	29.9 (759)	43.8 (1113)	15.7 (399)	2952 (1340)	2379 (1080)	C
	CR 125-1	3	UL	25 (18.5)		62.7 (1593)	59.2 (1504)	16.9 (429)	52.4 (1331)	35.4 (899)	87.2 (2215)	29.9 (759)	43.8 (1113)	15.7 (399)	3322 (1508)	2749 (1248)	C
	CR 125-2-2	3	UL	30 (22)		67.5 (1715)	75 (1905)	16.9 (429)	52.4 (1331)	47 (1194)	87.2 (2215)	29.9 (759)	43.8 (1113)	20 (508)	3443 (1563)	2871 (1303)	C
	CR 125-2-1	3	UL	40 (30)		70.5 (1791)	75 (1905)	16.9 (429)	52.4 (1331)	47 (1194)	87.2 (2215)	29.9 (759)	43.8 (1113)	20 (508)	3734 (1695)	3190 (1448)	C
	CR 125-2	3	UL	50 (37)		70.5 (1791)	75 (1905)	16.9 (429)	52.4 (1331)	47 (1194)	87.2 (2215)	29.9 (759)	43.8 (1113)	20 (508)	3862 (1753)	3289 (1493)	C
	CR 125-3-2	3	UL	60 (45)		75.3 (1913)	75 (1905)	16.9 (429)	52.4 (1331)	47 (1194)	87.2 (2215)	29.9 (759)	43.8 (1113)	20 (508)	4538 (2060)	3965 (1800)	C
3	CR 125-1-1	3	UL	20 (15)	10" Class 150	59.1 (1501)	75 (1905)	16.9 (429)	78 (1981)	47 (1194)	96.4 (2449)	33.2 (843)	47.2 (1199)	20 (508)	4474 (2031)	3679 (1670)	C
	CR 125-1	3	UL	25 (18.5)		62.7 (1593)	75 (1905)	16.9 (429)	78 (1981)	47 (1194)	96.4 (2449)	33.2 (843)	47.2 (1199)	20 (508)	5023 (2280)	4227 (1919)	C
	CR 125-2-2	3	UL	30 (22)		67.5 (1715)	75 (1905)	16.9 (429)	78 (1981)	47 (1194)	96.4 (2449)	33.2 (843)	47.2 (1199)	20 (508)	5192 (2357)	4397 (1996)	C
	CR 125-2-1	3	UL	40 (30)		70.5 (1791)	75 (1905)	16.9 (429)	78 (1981)	47 (1194)	96.4 (2449)	33.2 (843)	47.2 (1199)	20 (508)	5661 (2570)	4866 (2209)	C
	CR 125-2	3	UL	50 (37)		70.5 (1791)	75 (1905)	16.9 (429)	78 (1981)	47 (1194)	96.4 (2449)	33.2 (843)	47.2 (1199)	20 (508)	5811 (2638)	5016 (2277)	C
	CR 125-3-2	3	UL	60 (45)		75.3 (1913)	83 (2108)	16.9 (429)	78 (1981)	63.3 (1608)	96.4 (2449)	33.2 (843)	47.2 (1199)	20 (508)	6934 (3148)	6309 (2864)	C
4	CR 125-1-1	3	UL	20 (15)	12" Class 150	59.1 (1501)	75 (1905)	16.9 (429)	103.7 (2634)	47 (1194)	99.4 (2525)	33.2 (843)	47.2 (1199)	20 (508)	6285 (2853)	5311 (2411)	C
	CR 125-1	3	UL	25 (18.5)		62.7 (1593)	75 (1905)	16.9 (429)	103.7 (2634)	47 (1194)	99.4 (2525)	33.2 (843)	47.2 (1199)	20 (508)	7012 (3183)	6036 (2740)	C
	CR 125-2-2	3	UL	30 (22)		67.5 (1715)	83 (2108)	16.9 (429)	103.7 (2634)	63.3 (1608)	99.4 (2525)	33.2 (843)	47.2 (1199)	20 (508)	7331 (3328)	6525 (2962)	C
	CR 125-2-1	3	UL	40 (30)		70.5 (1791)	83 (2108)	16.9 (429)	103.7 (2634)	63.3 (1608)	99.4 (2525)	33.2 (843)	47.2 (1199)	20 (508)	7972 (3619)	7168 (3254)	C
	CR 125-2	3	UL	50 (37)		70.5 (1791)	83 (2108)	16.9 (429)	103.7 (2634)	63.3 (1608)	99.4 (2525)	33.2 (843)	47.2 (1199)	20 (508)	8170 (3709)	7366 (3344)	C
	CR 125-3-2	3	UL	60 (45)		75.3 (1913)	83 (2108)	16.9 (429)	103.7 (2634)	71 (1803)	99.4 (2525)	33.2 (843)	47.2 (1199)	20 (508)	9584 (4351)	8780 (3986)	C
5	CR 125-1-1	3	UL	20 (15)	14" Class 150	59.1 (1501)	83 (2108)	16.9 (429)	129.5 (3289)	63.3 (1608)	101.4 (2576)	33.2 (843)	47.2 (1199)	20 (508)	7423 (3370)	6397 (2904)	C
	CR 125-1	3	UL	25 (18.5)		62.7 (1593)	83 (2108)	16.9 (429)	129.5 (3289)	63.3 (1608)	101.4 (2576)	33.2 (843)	47.2 (1199)	20 (508)	8331 (3782)	7302 (3315)	C
	CR 125-2-2	3	UL	30 (22)		67.5 (1715)	83 (2108)	16.9 (429)	129.5 (3289)	71 (1803)	101.4 (2576)	33.2 (843)	47.2 (1199)	20 (508)	8688 (3944)	7659 (3477)	C
	CR 125-2-1	3	UL	40 (30)		70.5 (1791)	83 (2108)	16.9 (429)	129.5 (3289)	71 (1803)	101.4 (2576)	33.2 (843)	47.2 (1199)	20 (508)	9474 (4301)	8445 (3834)	C
	CR 125-2	3	UL	50 (37)		70.5 (1791)	83 (2108)	16.9 (429)	129.5 (3289)	71 (1803)	101.4 (2576)	33.2 (843)	47.2 (1199)	20 (508)	9719 (4412)	8692 (3946)	C
	CR 125-3-2	3	UL	60 (45)		75.3 (1913)	83 (2108)	16.9 (429)	129.5 (3289)	71 (1803)	101.4 (2576)	33.2 (843)	47.2 (1199)	20 (508)	11448 (5197)	10419 (4730)	C

Number of pumps	Pump type	Mains phases	Voltage code	Motor power [hp (kW)]	Connection size	A [in (mm)]	A1 [in (mm)]	A2 [in (mm)]	B [in (mm)]	B1 [in (mm)]	C [in (mm)]	C1 [in (mm)]	C2 [in (mm)]	C3 [in (mm)]	Gross weight [lbs (kg)]	Net weight [lbs (kg)]	Design
6	CR 125-1-1	3	UL	20 (15)	14" Class 150	59.1 (1501)	83 (2108)	16.9 (429)	155 (3937)	63.3 (1608)	101.4 (2576)	33.2 (843)	47.2 (1199)	20 (508)	9249 (4199)	7998 (3631)	C
	CR 125-1	3	UL	25 (18.5)		62.7 (1593)	83 (2108)	16.9 (429)	155 (3937)	63.3 (1608)	101.4 (2576)	33.2 (843)	47.2 (1199)	20 (508)	10287 (4670)	9102 (4132)	C
	CR 125-2-2	3	UL	30 (22)		67.5 (1715)	83 (2108)	16.9 (429)	155 (3937)	71 (1803)	101.4 (2576)	33.2 (843)	47.2 (1199)	20 (508)	10752 (4881)	9500 (4313)	C
	CR 125-2-1	3	UL	40 (30)		70.5 (1791)	83 (2108)	16.9 (429)	155 (3937)	71 (1803)	101.4 (2576)	33.2 (843)	47.2 (1199)	20 (508)	12815 (5818)	10454 (4746)	C
	CR 125-2	3	UL	50 (37)		70.5 (1791)	83 (2108)	16.9 (429)	155 (3937)	71 (1803)	101.4 (2576)	33.2 (843)	47.2 (1199)	20 (508)	12025 (5459)	10774 (4891)	C
	CR 125-3-2	3	UL	60 (45)		75.3 (1913)	86.7 (2202)	16.9 (429)	155 (3937)	125.8 (3195)	101.4 (2576)	33.2 (843)	47.2 (1199)	23.8 (605)	14842 (6738)	13591 (6170)	C

Dimensions may vary by ± 0.5 inch (12.7 mm).

Hydro MPC-E with CRE 125

Number of pumps	Pump type	Mains phases	Voltage code	Motor power [hp (kW)]	Connection size	A [in (mm)]	A1 [in (mm)]	A2 [in (mm)]	B [in (mm)]	B1 [in (mm)]	C [in (mm)]	C1 [in (mm)]	C2 [in (mm)]	C3 [in (mm)]	Gross weight [lbs (kg)]	Net weight [lbs (kg)]	Design
2	CRE 125-1-1	3	UL	20 (15)	8" Class 150	59.8 (1519)	57.6 (1463)	16.9 (429)	52.4 (1331)	24.8 (630)	87.2 (2215)	29.9 (759)	43.8 (1113)	10 (254)	2663 (1209)	2260 (1026)	D
	CRE 125-1	3	UL	25 (18.5)		62.4 (1585)	57.6 (1463)	16.9 (429)	52.4 (1331)	24.8 (630)	87.2 (2215)	29.9 (759)	43.8 (1113)	10 (254)	2747 (1247)	2344 (1064)	D
	CRE 125-2-2	3	UL	30 (22)		67.1 (1704)	57.6 (1463)	16.9 (429)	52.4 (1331)	24.8 (630)	87.2 (2215)	29.9 (759)	43.8 (1113)	10 (254)	2849 (1293)	2445 (1110)	D
3	CRE 125-1-1	3	UL	20 (15)	10" Class 150	59.8 (1519)	57.6 (1463)	16.9 (429)	78 (1981)	24.8 (630)	96.4 (2449)	33.2 (843)	47.2 (1199)	8 (203)	4192 (1903)	3567 (1619)	D
	CRE 125-1	3	UL	25 (18.5)		62.4 (1585)	57.6 (1463)	16.9 (429)	78 (1981)	24.8 (630)	96.4 (2449)	33.2 (843)	47.2 (1199)	8 (203)	4333 (1967)	3708 (1683)	D
	CRE 125-2-2	3	UL	30 (22)		67.1 (1704)	57.6 (1463)	16.9 (429)	78 (1981)	24.8 (630)	96.4 (2449)	33.2 (843)	47.2 (1199)	8 (203)	4483 (2035)	3857 (1751)	D
4	CRE 125-1-1	3	UL	20 (15)	12" Class 150	59.8 (1519)	57.6 (1463)	16.9 (429)	103.7 (2634)	24.8 (630)	99.4 (2525)	33.2 (843)	47.2 (1199)	8 (203)	6069 (2755)	5265 (2390)	D
	CRE 125-1	3	UL	25 (18.5)		62.4 (1585)	57.6 (1463)	16.9 (429)	103.7 (2634)	24.8 (630)	99.4 (2525)	33.2 (843)	47.2 (1199)	8 (203)	6238 (2832)	5434 (2467)	D
	CRE 125-2-2	3	UL	30 (22)		67.1 (1704)	57.6 (1463)	16.9 (429)	103.7 (2634)	24.8 (630)	99.4 (2525)	33.2 (843)	47.2 (1199)	8 (203)	6441 (2924)	5635 (2558)	D
5	CRE 125-1-1	3	UL	20 (15)	14" Class 150	59.8 (1519)	57.6 (1463)	16.9 (429)	129.5 (3289)	32.7 (831)	101.4 (2576)	33.2 (843)	47.2 (1199)	12 (305)	7309 (3318)	6282 (2852)	D
	CRE 125-1	3	UL	25 (18.5)		62.4 (1585)	57.6 (1463)	16.9 (429)	129.5 (3289)	32.7 (831)	101.4 (2576)	33.2 (843)	47.2 (1199)	12 (305)	7525 (3416)	6496 (2949)	D
	CRE 125-2-2	3	UL	30 (22)		67.1 (1704)	57.6 (1463)	16.9 (429)	129.5 (3289)	32.7 (831)	101.4 (2576)	33.2 (843)	47.2 (1199)	12 (305)	7774 (3529)	6747 (3063)	D
6	CRE 125-1-1	3	UL	20 (15)	14" Class 150	59.8 (1519)	57.6 (1463)	16.9 (429)	155 (3937)	32.7 (831)	101.4 (2576)	33.2 (843)	47.2 (1199)	12 (305)	9161 (4159)	7910 (3591)	D
	CRE 125-1	3	UL	25 (18.5)		62.4 (1585)	57.6 (1463)	16.9 (429)	155 (3937)	32.7 (831)	101.4 (2576)	33.2 (843)	47.2 (1199)	12 (305)	9417 (4275)	8166 (3707)	D
	CRE 125-2-2	3	UL	30 (22)		67.1 (1704)	57.6 (1463)	16.9 (429)	155 (3937)	32.7 (831)	101.4 (2576)	33.2 (843)	47.2 (1199)	12 (305)	9719 (4412)	8467 (3844)	D

Dimensions may vary by ± 0.5 inch (12.7 mm).

Hydro MPC-E with CR, CRE 155

Hydro MPC-E with CR 155

Number of pumps	Pump type	Mains phases	Voltage code	Motor power [hp (kW)]	Connection size	A [in (mm)]	A1 [in (mm)]	A2 [in (mm)]	B [in (mm)]	B1 [in (mm)]	C [in (mm)]	C1 [in (mm)]	C2 [in (mm)]	C3 [in (mm)]	Gross weight [lbs (kg)]	Net weight [lbs (kg)]	Design
2	CR 155-1-1	3	UL	25 (18.5)	10" Class 150	64.3 (1633)	59.2 (1504)	16.9 (429)	52.4 (1331)	35.4 (899)	105.9 (2690)	36.7 (932)	53.2 (1351)	15.7 (399)	3923 (1781)	3353 (1522)	C
	CR 155-1	3	UL	40 (30)		67.8 (1722)	75 (1905)	16.9 (429)	52.4 (1331)	47 (1194)	105.9 (2690)	36.7 (932)	53.2 (1351)	20 (508)	4318 (1960)	3745 (1700)	C
	CR 155-2-2	3	UL	50 (37)		72.6 (1844)	75 (1905)	16.9 (429)	52.4 (1331)	47 (1194)	105.9 (2690)	36.7 (932)	53.2 (1351)	20 (508)	4465 (2027)	3893 (1767)	C
	CR 155-2-1	3	UL	60 (45)		75.3 (1913)	75 (1905)	16.9 (429)	52.4 (1331)	47 (1194)	105.9 (2690)	36.7 (932)	53.2 (1351)	20 (508)	5093 (2312)	4523 (2053)	C
3	CR 155-1-1	3	UL	25 (18.5)	12" Class 150	64.3 (1633)	75 (1905)	16.9 (429)	78.1 (1984)	47 (1194)	109 (2769)	36.7 (932)	53.2 (1351)	20 (508)	5666 (2572)	4871 (2211)	C
	CR 155-1	3	UL	40 (30)		67.8 (1722)	75 (1905)	16.9 (429)	78.1 (1984)	47 (1194)	109 (2769)	36.7 (932)	53.2 (1351)	20 (508)	6234 (2830)	5439 (2469)	C
	CR 155-2-2	3	UL	50 (37)		72.6 (1844)	75 (1905)	16.9 (429)	78.1 (1984)	47 (1194)	109 (2769)	36.7 (932)	53.2 (1351)	20 (508)	6456 (2931)	5661 (2570)	C
	CR 155-2-1	3	UL	60 (45)		75.3 (1913)	83 (2108)	16.9 (429)	78.1 (1984)	63.3 (1608)	109 (2769)	36.7 (932)	53.2 (1351)	20 (508)	7507 (3408)	6882 (3124)	C
4	CR 155-1-1	3	UL	25 (18.5)	14" Class 150	64.3 (1633)	75 (1905)	16.9 (429)	103.9 (2639)	47 (1194)	110.9 (2817)	36.7 (932)	53.2 (1351)	20 (508)	7987 (3626)	7014 (3184)	C
	CR 155-1	3	UL	40 (30)		67.8 (1722)	83 (2108)	16.9 (429)	103.9 (2639)	63.3 (1608)	110.9 (2817)	36.7 (932)	53.2 (1351)	20 (508)	8855 (4020)	8051 (3655)	C
	CR 155-2-2	3	UL	50 (37)		72.6 (1844)	83 (2108)	16.9 (429)	103.9 (2639)	63.3 (1608)	110.9 (2817)	36.7 (932)	53.2 (1351)	20 (508)	9148 (4153)	8344 (3788)	C
	CR 155-2-1	3	UL	60 (45)		75.3 (1913)	83 (2108)	16.9 (429)	103.9 (2639)	71 (1803)	110.9 (2817)	36.7 (932)	53.2 (1351)	20 (508)	10467 (4752)	9663 (4387)	C
5	CR 155-1-1	3	UL	25 (18.5)	16" Class 150	64.3 (1633)	83 (2108)	16.9 (429)	129.5 (3289)	63.3 (1608)	113.4 (2880)	36.7 (932)	53.2 (1351)	20 (508)	9906 (4497)	8879 (4031)	C
	CR 155-1	3	UL	40 (30)		67.8 (1722)	83 (2108)	16.9 (429)	129.5 (3289)	71 (1803)	113.4 (2880)	36.7 (932)	53.2 (1351)	20 (508)	10930 (4962)	9901 (4495)	C
	CR 155-2-2	3	UL	50 (37)		72.6 (1844)	83 (2108)	16.9 (429)	129.5 (3289)	71 (1803)	113.4 (2880)	36.7 (932)	53.2 (1351)	20 (508)	11296 (5128)	10267 (4661)	C
	CR 155-2-1	3	UL	60 (45)		75.3 (1913)	83 (2108)	16.9 (429)	129.5 (3289)	71 (1803)	113.4 (2880)	36.7 (932)	53.2 (1351)	20 (508)	12906 (5859)	11877 (5392)	C
6	CR 155-1-1	3	UL	25 (18.5)	16" Class 150	64.3 (1633)	83 (2108)	16.9 (429)	155.1 (3940)	63.3 (1608)	113.4 (2880)	36.7 (932)	53.2 (1351)	20 (508)	11463 (5204)	10212 (4636)	C
	CR 155-1	3	UL	40 (30)		67.8 (1722)	83 (2108)	16.9 (429)	155.1 (3940)	71 (1803)	113.4 (2880)	36.7 (932)	53.2 (1351)	20 (508)	12675 (5754)	11423 (5186)	C
	CR 155-2-2	3	UL	50 (37)		72.6 (1844)	83 (2108)	16.9 (429)	155.1 (3940)	71 (1803)	113.4 (2880)	36.7 (932)	53.2 (1351)	20 (508)	13139 (5965)	11888 (5397)	C
	CR 155-2-1	3	UL	60 (45)		75.3 (1913)	86.7 (2202)	16.9 (429)	155.1 (3940)	125.8 (3195)	113.4 (2880)	36.7 (932)	53.2 (1351)	23.8 (605)	15813 (7179)	14562 (6611)	C

Dimensions may vary by ± 0.5 inch (12.7 mm).

Hydro MPC-E with CRE 155

Number of pumps	Pump type	Mains phases	Voltage code	Motor power [hp (kW)]	Connection size	A [in (mm)]	A1 [in (mm)]	A2 [in (mm)]	B [in (mm)]	B1 [in (mm)]	C [in (mm)]	C1 [in (mm)]	C2 [in (mm)]	C3 [in (mm)]	Gross weight [lbs (kg)]	Net weight [lbs (kg)]	Design
2	CRE 155-1-1	3	UL	25 (18.5)	10" Class 150	63.9 (1623)	57.6 (1463)	16.9 (429)	52.4 (1331)	24.8 (630)	105.9 (2690)	36.7 (932)	53.2 (1351)	9.9 (251)	3360 (1525)	2959 (1343)	D
3	CRE 155-1-1	3	UL	25 (18.5)	12" Class 150	63.9 (1623)	57.6 (1463)	16.9 (429)	78.1 (1984)	24.8 (630)	109 (2769)	36.7 (932)	53.2 (1351)	9.9 (251)	4976 (2259)	4351 (1975)	D
4	CRE 155-1-1	3	UL	25 (18.5)	14" Class 150	63.9 (1623)	57.6 (1463)	16.9 (429)	103.9 (2639)	24.8 (630)	110.9 (2817)	36.7 (932)	53.2 (1351)	9.9 (251)	7216 (3276)	6412 (2911)	D
5	CRE 155-1-1	3	UL	25 (18.5)	16" Class 150	63.9 (1623)	57.6 (1463)	16.9 (429)	129.5 (3289)	32.7 (831)	113.4 (2880)	36.7 (932)	53.2 (1351)	9.9 (251)	9100 (4131)	7954 (3611)	D
6	CRE 155-1-1	3	UL	25 (18.5)	16" Class 150	63.9 (1623)	57.6 (1463)	16.9 (429)	155.1 (3940)	32.7 (831)	113.4 (2880)	36.7 (932)	53.2 (1351)	9.9 (251)	10529 (4780)	9161 (4159)	D

Dimensions may vary by ± 0.5 inch (12.7 mm).

Hydro MPC-E with CR 185

Number of pumps	Pump type	Mains phases	Voltage code	Motor power [hp (kW)]	Connection size	A [in (mm)]	A1 [in (mm)]	A2 [in (mm)]	B [in (mm)]	B1 [in (mm)]	C [in (mm)]	C1 [in (mm)]	C2 [in (mm)]	C3 [in (mm)]	Gross weight [lbs (kg)]	Net weight [lbs (kg)]	Design
2	CR 185-1-1	3	UL	40 (30)	10" Class 150	71.1 (1806)	75 (1905)	18.3 (465)	52.4 (1331)	47 (1194)	108.9 (2766)	38.2 (970)	54.7 (1389)	20 (508)	4970 (2256)	4210 (1911)	C
	CR 185-1	3	UL	50 (37)		71.1 (1806)	75 (1905)	18.3 (465)	52.4 (1331)	47 (1194)	108.9 (2766)	38.2 (970)	54.7 (1389)	20 (508)	5073 (2303)	4313 (1958)	C
	CR 185-2-2	3	UL	75 (55)		78.9 (2004)	83 (2108)	18.3 (465)	52.4 (1331)	63 (1600)	108.9 (2766)	38.2 (970)	54.7 (1389)	20 (508)	6296 (2858)	5320 (2415)	C
3	CR 185-1-1	3	UL	40 (30)	12" Class 150	71.1 (1806)	75 (1905)	18.3 (465)	78.1 (1984)	47 (1194)	112 (2845)	38.2 (970)	54.7 (1389)	20 (508)	6974 (3166)	6161 (2797)	C
	CR 185-1	3	UL	50 (37)		71.1 (1806)	75 (1905)	18.3 (465)	78.1 (1984)	47 (1194)	112 (2845)	38.2 (970)	54.7 (1389)	20 (508)	7130 (3237)	6318 (2868)	C
	CR 185-2-2	3	UL	75 (55)		78.9 (2004)	83 (2108)	18.3 (465)	78.1 (1984)	63 (1600)	112 (2845)	38.2 (970)	54.7 (1389)	20 (508)	8756 (3975)	7699 (3495)	C
4	CR 185-1-1	3	UL	40 (30)	14" Class 150	71.1 (1806)	83 (2108)	18.3 (465)	103.9 (2639)	63 (1600)	114 (2896)	38.2 (970)	54.7 (1389)	20 (508)	10368 (4707)	8978 (4076)	C
	CR 185-1	3	UL	50 (37)		71.1 (1806)	83 (2108)	18.3 (465)	103.9 (2639)	63 (1600)	114 (2896)	38.2 (970)	54.7 (1389)	20 (508)	10575 (4801)	9186 (4170)	C
	CR 185-2-2	3	UL	75 (55)		78.9 (2004)	83 (2108)	18.3 (465)	103.9 (2639)	71 (1803)	114 (2896)	38.2 (970)	54.7 (1389)	20 (508)	12238 (5556)	10785 (4896)	C
5	CR 185-1-1	3	UL	40 (30)	16" Class 150	71.1 (1806)	83 (2108)	18.3 (465)	129.5 (3289)	71 (1803)	116.4 (2957)	38.2 (970)	54.7 (1389)	20 (508)	12545 (5695)	11089 (5034)	C
	CR 185-1	3	UL	50 (37)		71.1 (1806)	83 (2108)	18.3 (465)	129.5 (3289)	71 (1803)	116.4 (2957)	38.2 (970)	54.7 (1389)	20 (508)	12802 (5812)	11349 (5152)	C
	CR 185-2-2	3	UL	75 (55)		78.9 (2004)	79 (2007)	18.3 (465)	129.5 (3289)	110 (2794)	116.4 (2957)	38.2 (970)	54.7 (1389)	24 (610)	15662 (7104)	14066 (6380)	C
6	CR 185-1-1	3	UL	40 (30)	18" Class 150	71.1 (1806)	83 (2108)	18.3 (465)	155.2 (3942)	71 (1803)	119.9 (3045)	39.2 (996)	55.7 (1415)	20 (508)	14802 (6720)	13293 (6035)	C
	CR 185-1	3	UL	50 (37)		71.1 (1806)	83 (2108)	18.3 (465)	155.2 (3942)	71 (1803)	119.9 (3045)	39.2 (996)	55.7 (1415)	20 (508)	15137 (6872)	13630 (6188)	C
	CR 185-2-2	3	UL	75 (55)		78.9 (2004)	79 (2007)	18.3 (465)	155.2 (3942)	126 (3200)	119.9 (3045)	39.2 (996)	55.7 (1415)	24 (610)	18568 (8422)	16917 (7673)	C

Dimensions may vary by ± 0.5 inch (12.7 mm).

Hydro MPC-E with CR 215

Number of pumps	Pump type	Mains phases	Voltage code	Motor power [hp (kW)]	Connection size	A [in (mm)]	A1 [in (mm)]	A2 [in (mm)]	B [in (mm)]	B1 [in (mm)]	C [in (mm)]	C1 [in (mm)]	C2 [in (mm)]	C3 [in (mm)]	Gross weight [lbs (kg)]	Net weight [lbs (kg)]	Design
2	CR 215-1-1	3	UL	50 (37)	10"	71.1 (1806)	75 (1905)	18.3 (465)	52.4 (1331)	47 (1194)	108.9 (2766)	38.2 (970)	54.7 (1389)	20 (508)	5073 (2303)	4313 (1958)	C
	CR 215-1	3	UL	75 (55)	Class 150	73.9 (1877)	83 (2108)	18.3 (465)	52.4 (1331)	63 (1600)	108.9 (2766)	38.2 (970)	54.7 (1389)	20 (508)	6214 (2821)	5236 (2377)	C
3	CR 215-1-1	3	UL	50 (37)	12"	71.1 (1806)	75 (1905)	18.3 (465)	78.1 (1984)	47 (1194)	112 (2845)	38.2 (970)	54.7 (1389)	20 (508)	7130 (3237)	6318 (2868)	C
	CR 215-1	3	UL	75 (55)	Class 150	73.9 (1877)	83 (2108)	18.3 (465)	78.1 (1984)	63 (1600)	112 (2845)	38.2 (970)	54.7 (1389)	20 (508)	8606 (3907)	7575 (3439)	C
4	CR 215-1-1	3	UL	50 (37)	14"	71.1 (1806)	83 (2108)	18.3 (465)	103.9 (2639)	63 (1600)	114 (2896)	38.2 (970)	54.7 (1389)	20 (508)	10575 (4801)	9186 (4170)	C
	CR 215-1	3	UL	75 (55)	Class 150	73.9 (1877)	83 (2108)	18.3 (465)	103.9 (2639)	71 (1803)	114 (2896)	38.2 (970)	54.7 (1389)	20 (508)	12023 (5458)	10622 (4822)	C
5	CR 215-1-1	3	UL	50 (37)	16"	71.1 (1806)	83 (2108)	18.3 (465)	129.5 (3289)	71 (1803)	116.4 (2957)	38.2 (970)	54.7 (1389)	20 (508)	12802 (5812)	11349 (5152)	C
	CR 215-1	3	UL	75 (55)	Class 150	73.9 (1877)	79 (2007)	18.3 (465)	129.5 (3289)	110 (2794)	116.4 (2957)	38.2 (970)	54.7 (1389)	24 (610)	15404 (6987)	13861 (6287)	C
6	CR 215-1-1	3	UL	50 (37)	18"	71.1 (1806)	83 (2108)	18.3 (465)	155.2 (3942)	71 (1803)	119.9 (3045)	39.2 (996)	55.7 (1415)	20 (508)	15139 (6873)	13630 (6188)	C
	CR 215-1	3	UL	75 (55)	Class 150	73.9 (1877)	79 (2007)	18.3 (465)	155.2 (3942)	126 (3200)	119.9 (3045)	39.2 (996)	55.7 (1415)	24 (610)	18268 (8286)	16670 (7561)	C

Dimensions may vary by ± 0.5 inch (12.7 mm).

Hydro MPC-E with CR 255

Number of pumps	Pump type	Mains phases	Voltage code	Motor power [hp (kW)]	Connection size	A [in (mm)]	A1 [in (mm)]	A2 [in (mm)]	B [in (mm)]	B1 [in (mm)]	C [in (mm)]	C1 [in (mm)]	C2 [in (mm)]	C3 [in (mm)]	Gross weight [lbs (kg)]	Net weight [lbs (kg)]	Design
2	CR 255-1-1	3	UL	60 (45)	10" Class 150	73.9 (1877)	75 (1905)	18.3 (465)	52.4 (1331)	47 (1194)	108.9 (2766)	38.2 (970)	54.7 (1389)	20 (508)	5703 (2589)	4943 (2244)	C
3	CR 255-1-1	3	UL	60 (45)	14" Class 150	73.9 (1877)	83 (2108)	18.3 (465)	78.2 (1986)	63 (1600)	114 (2896)	38.2 (970)	54.7 (1389)	20 (508)	8804 (3997)	7774 (3529)	C
4	CR 255-1-1	3	UL	60 (45)	16" Class 150	73.9 (1877)	83 (2108)	18.3 (465)	103.9 (2639)	71 (1803)	116.4 (2957)	38.2 (970)	54.7 (1389)	20 (508)	12188 (5533)	10787 (4897)	C
5	CR 255-1-1	3	UL	60 (45)	18" Class 150	73.9 (1877)	83 (2108)	18.3 (465)	129.6 (3292)	71 (1803)	119.9 (3045)	39.2 (996)	55.7 (1415)	20 (508)	14853 (6743)	13397 (6082)	C
6	CR 255-1-1	3	UL	60 (45)	20" Class 150	73.9 (1877)	87 (2210)	18.3 (465)	155.4 (3947)	126 (3200)	124.5 (3162)	40.2 (1021)	56.7 (1440)	24 (610)	18408 (8357)	16811 (7632)	C

Dimensions may vary by ± 0.5 inch (12.7 mm).

11. Technical data, Hydro MPC CME, 60 Hz

Dimensional sketches for CME

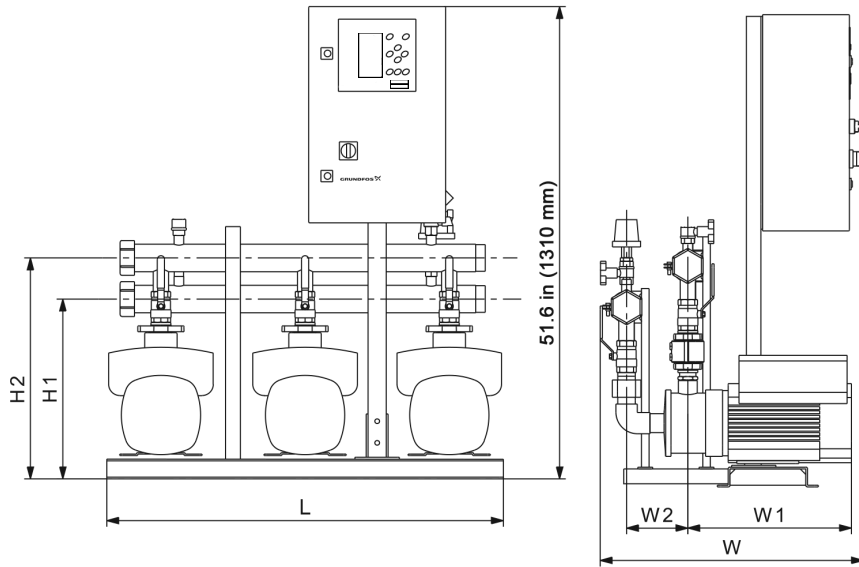

TM074709

Hydro MPC CME system with three CME pumps

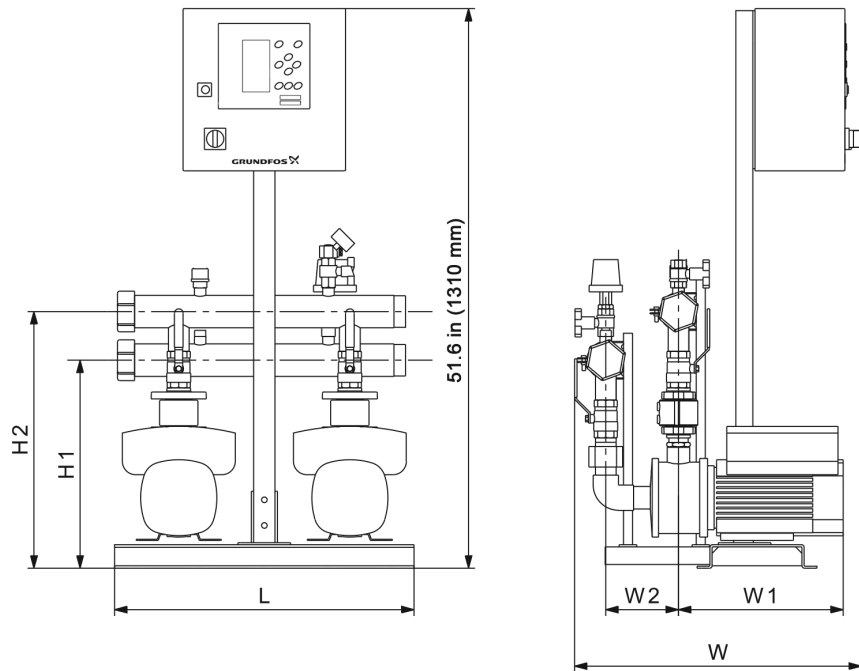

TM074702

Hydro MPC CME system with two CME pumps

Hydro MPC CME with CME 3

Number of pumps	Pump type	Motor power [hp (kW)]	Voltage code	Connection size [in]	L [in (mm)]	W [in (mm)]	W1 [in (mm)]	W2 [in (mm)]	H1 [in (mm)]	H2 [in (mm)]	Gross weight [lbs (kg)]	Net weight [lbs (kg)]
2	CME 3-3	1.5 (1.1)	UJ	NPT 2"	27.6 (701)	25.1 (638)	9.9 (251)	5.9 (150)	18.1 (460)	23.9 (607)	293 (133)	177 (80)
	CME 3-5	1.5 (1.1)	UJ		27.6 (701)	26.5 (673)	9.9 (251)	7.3 (185)	18.1 (460)	23.9 (607)	296 (134)	179 (81)
3	CME 3-3	1.5 (1.1)	UJ	NPT 2"	43.3 (1100)	24.1 (612)	9.9 (251)	5.9 (150)	18.1 (460)	23.9 (607)	465 (211)	243 (110)
	CME 3-5	1.5 (1.1)	UJ		43.3 (1100)	25.5 (648)	9.9 (251)	7.3 (185)	18.1 (460)	23.9 (607)	467 (212)	245 (111)

Dimensions may vary by ± 0.5 inch (12.7 mm).

Hydro MPC CME with CME 5

Number of pumps	Pump type	Motor power [hp (kW)]	Voltage code	Connection size [in]	L [in (mm)]	W [in (mm)]	W1 [in (mm)]	W2 [in (mm)]	H1 [in (mm)]	H2 [in (mm)]	Gross weight [lbs (kg)]	Net weight [lbs (kg)]
2	CME 5-3	1.5 (1.1)	UJ	NPT 2"	27.6 (701)	27.1 (688)	10 (254)	7.5 (191)	19.3 (490)	24.2 (615)	291 (132)	177 (80)
	CME 5-4	2 (1.5)	UJ		27.6 (701)	26.7 (678)	9.6 (244)	7.5 (191)	19.3 (490)	25.7 (653)	309 (140)	194 (88)
	CME 5-4	2 (1.5)	UK		27.6 (701)	26.7 (678)	9.57 (243)	7.5 (191)	19.3 (490)	25.7 (653)	373 (169)	256 (116)
	CME 5-4	2 (1.5)	UL		27.6 (701)	26.7 (678)	9.57 (243)	7.5 (191)	19.3 (490)	25.7 (653)	318 (144)	201 (91)
	CME 5-5	2 (1.5)	UK		27.6 (701)	27.5 (699)	9.6 (244)	8.4 (213)	19.3 (490)	25.7 (653)	373 (169)	258 (117)
	CME 5-5	2 (1.5)	UL		27.6 (701)	27.5 (699)	9.57 (243)	8.4 (213)	19.3 (490)	25.7 (653)	320 (145)	203 (92)
3	CME 5-3	1.5 (1.1)	UJ	NPT 2"	43.3 (1100)	26.1 (663)	10 (254)	7.5 (191)	19.3 (490)	24.2 (615)	465 (211)	243 (110)
	CME 5-4	2 (1.5)	UJ		43.3 (1100)	25.7 (653)	9.6 (244)	7.5 (191)	19.3 (490)	25.7 (653)	494 (224)	271 (123)
	CME 5-4	2 (1.5)	UK		43.3 (1100)	27.5 (699)	9.57 (243)	7.5 (191)	19.3 (490)	25.7 (653)	516 (234)	293 (133)
	CME 5-4	2 (1.5)	UL		43.3 (1100)	25.7 (653)	9.57 (243)	7.5 (191)	19.3 (490)	25.7 (653)	503 (228)	280 (127)
	CME 5-5	2 (1.5)	UK		43.3 (1100)	26.6 (676)	9.6 (244)	8.4 (213)	19.3 (490)	25.7 (653)	589 (267)	366 (166)
	CME 5-5	2 (1.5)	UL		43.3 (1100)	26.6 (676)	9.57 (243)	8.4 (213)	19.3 (490)	25.7 (653)	507 (230)	285 (129)

Dimensions may vary by ± 0.5 inch (12.7 mm).

Hydro MPC CME with CME 10

Number of pumps	Pump type	Motor power [hp (kW)]	Voltage code	Connection size [in]	L [in (mm)]	W [in (mm)]	W1 [in (mm)]	W2 [in (mm)]	H1 [in (mm)]	H2 [in (mm)]	Gross weight [lbs (kg)]	Net weight [lbs (kg)]
2	CME 10-1	1.5 (1.1)	UJ	NPT 2.5"	27.6 (701)	27.5 (699)	9.9 (251)	7.4 (188)	21.5 (546)	27.5 (699)	355 (161)	238 (108)
	CME 10-2	3 (2.2)	UK		27.6 (701)	28 (711)	14.2 (361)	7.4 (188)	21.5 (546)	27.5 (699)	549 (249)	326 (148)
	CME 10-2	3 (2.2)	UL		27.6 (701)	8 (711)	14.2 (361)	7.4 (188)	21.5 (546)	27.5 (699)	483 (219)	265 (120)
	CME 10-3	5 (3.7)	UK		27.6 (701)	30.5 (775)	16.7 (424)	8.6 (218)	22 (559)	27.9 (709)	536 (243)	313 (142)
	CME 10-3	5 (3.7)	UL		27.6 (701)	30.5 (775)	16.7 (424)	8.6 (218)	22 (559)	27.9 (709)	591 (268)	368 (167)
	CME 10-1	1.5 (1.1)	UJ		43.3 (1100)	26.6 (676)	9.9 (251)	7.4 (188)	21.5 (546)	27.5 (699)	558 (253)	335 (152)
3	CME 10-2	3 (2.2)	UK	NPT 2.5"	43.3 (1100)	27.5 (699)	14.2 (361)	7.4 (188)	21.5 (546)	27.5 (699)	690 (313)	467 (212)
	CME 10-2	3 (2.2)	UL		43.3 (1100)	27.5 (699)	14.2 (361)	7.4 (188)	21.5 (546)	27.5 (699)	597 (271)	375 (170)
	CME 10-3	5 (3.7)	UK		43.3 (1100)	30 (762)	16.7 (424)	8.6 (218)	22 (559)	27.9 (709)	672 (305)	450 (204)
	CME 10-3	5 (3.7)	UL		43.3 (1100)	0 (762)	16.7 (424)	8.6 (218)	22 (559)	27.9 (709)	754 (342)	531 (241)
	CME 10-3	5 (3.7)	UL		43.3 (1100)	0 (762)	16.7 (424)	8.6 (218)	22 (559)	27.9 (709)	754 (342)	531 (241)

Dimensions may vary by ± 0.5 inch (12.7 mm).

Hydro MPC CME with CME 15

Number of pumps	Pump type	Motor power [hp (kW)]	Voltage code	Connection size [in]	L [in (mm)]	W [in (mm)]	W1 [in (mm)]	W2 [in (mm)]	H1 [in (mm)]	H2 [in (mm)]	Gross weight [lbs (kg)]	Net weight [lbs (kg)]
2	CME 15-1	3 (2.2)	UK	3" Class 150	27.6 (701)	30.4 (772)	14.2 (361)	9.6 (244)	22.3 (566)	26.6 (676)	584 (265)	362 (164)
	CME 15-1	3 (2.2)	UL		27.6 (701)	30.4 (772)	14.2 (361)	9.6 (244)	22.3 (566)	26.5 (673)	525 (238)	302 (137)
	CME 15-2	5 (3.7)	UK		27.6 (701)	31.7 (805)	16.7 (424)	9.6 (244)	22.7 (577)	27.1 (688)	571 (259)	349 (158)
	CME 15-2	5 (3.7)	UL		27.6 (701)	31.7 (805)	16.7 (424)	9.6 (244)	22.6 (574)	27 (686)	586 (266)	364 (165)
	CME 15-3	7.5 (5.5)	UK		27.6 (701)	32.9 (836)	16.7 (424)	10.8 (274)	22.7 (577)	27.1 (688)	639 (290)	417 (189)
	CME 15-3	7.5 (5.5)	UL		27.6 (701)	32.9 (836)	16.7 (424)	10.8 (274)	22.7 (577)	27.1 (688)	630 (286)	408 (185)
3	CME 15-1	3 (2.2)	UK	4" Class 150	43.3 (1100)	30.6 (777)	14.2 (361)	9.6 (244)	22.7 (577)	27 (686)	760 (345)	538 (244)
	CME 15-1	3 (2.2)	UL		43.3 (1100)	30.6 (777)	14.2 (361)	9.6 (244)	22.7 (577)	27 (686)	666 (302)	443 (201)
	CME 15-2	5 (3.7)	UK		43.3 (1100)	31.9 (810)	16.7 (424)	9.6 (244)	23.2 (589)	27.5 (699)	741 (336)	518 (235)
	CME 15-2	5 (3.7)	UL		43.3 (1100)	31.9 (810)	16.7 (424)	9.6 (244)	23.2 (589)	27.5 (699)	760 (345)	538 (244)
	CME 15-3	7.5 (5.5)	UK		43.3 (1100)	31 (841)	16.7 (424)	10.8 (274)	23.2 (589)	27.5 (699)	844 (383)	622 (282)
	CME 15-3	7.5 (5.5)	UL		43.3 (1100)	33.1 (841)	16.7 (424)	10.8 (274)	23.2 (589)	27.5 (699)	826 (375)	604 (274)

Dimensions may vary by ± 0.5 inch (12.7 mm).

Hydro MPC CME with CME 25

Number of pumps	Pump type	Motor power [hp (kW)]	Voltage code	Connection size [in]	L [in (mm)]	W [in (mm)]	W1 [in (mm)]	W2 [in (mm)]	H1 [in (mm)]	H2 [in (mm)]	Gross weight [lbs (kg)]	Net weight [lbs (kg)]
2	CME 25-1	5 (3.7)	UK	4" Class 150	27.6 (701)	32.4 (823)	16.7 (424)	9.6 (244)	23.3 (592)	27.6 (701)	624 (283)	401 (182)
	CME 25-1	5 (3.7)	UL		27.6 (701)	32.4 (823)	16. (424)	9.6 (244)	23.3 (592)	27.6 (701)	628 (285)	406 (184)
	CME 25-2	7.5 (5.5)	UK		27.6 (701)	32.4 (823)	16.7 (424)	9.6 (244)	23.3 (592)	27.6 (701)	690 (313)	467 (212)
	CME 25-2	7.5 (5.5)	UL		27.6 (701)	32.4 (823)	16.7 (424)	9.6 (244)	23.3 (592)	27.6 (701)	672 (305)	450 (204)
3	CME 25-1	5 (3.7)	UK	4" Class 150	43.3 (1100)	31.9 (810)	16.7 (424)	9.6 (244)	23.2 (589)	27.5 (699)	743 (337)	520 (236)
	CME 25-1	5 (3.7)	UL		43.3 (1100)	31.9 (810)	16.7 (424)	9.6 (244)	23.2 (589)	27.5 (699)	756 (343)	534 (242)
	CME 25-2	7.5 (5.5)	UK		43.3 (1100)	32 (813)	16.7 (424)	9.6 (244)	23.2 (589)	27.5 (699)	844 (383)	622 (282)
	CME 25-2	7.5 (5.5)	UL		43.3 (1100)	32 (813)	16.7 (424)	9.6 (244)	23.2 (589)	27.5 (699)	822 (373)	600 (272)

Dimensions may vary by ± 0.5 inch (12.7 mm).

Maximum system amps (full load amperage)

Number of pumps	Motor power [hp (kW)]	MPC-E (CRE/CME)			MPC-E (CUE)			
		1 x 230 V	3 x 208-230 V	3 x 460-480 V	1 x 230 V	3 x 208-230 V	3 x 460-480 V	3 x 575-600V
2	1 (0.75)	10.4		4.3		11.2	6.2	5.4
	1.5 (1.1)	14.4	9.2	5.1	27	15.2	7.4	6.8
	2 (1.5)	19.2	11.8	6.3	32	17	8.8	7.4
	3 (2.2)		16.8	8.6	43	23.2	11.6	9.8
	5 (4)		27.4	13.4	66	35.4	18.4	14.2
	7.5 (5.5)		41	19.2	94	50.4	24	20
	10 (7.5)			25.8	120	63.6	31	24
	15 (11)			36.8		94.4	44	38
	20 (15)			53		120.8	56	46
	25 (18.5)			62		151.6	70	56
	30 (22)			74			82	70
	40 (30)						106	84
	50 (37)						132	106
	60 (44)						162	126

Number of pumps	Motor power [hp (kW)]	MPC-E (CRE/CME)			MPC-E (CUE)			
		1 x 230 V	3 x 208-230 V	3 x 460-480 V	1 x 230 V	3 x 208-230 V	3 x 460-480 V	3 x 575-600V
3	1 (0.75)	15.1		5.95		15.8	8.3	7.1
	1.5 (1.1)	21.1	13.3	7.15	39.5	21.8	10.1	9.2
	2 (1.5)	28.3	17.2	8.95	47	24.5	12.2	10.1
	3 (2.2)		24.7	12.4	63.5	33.8	16.4	13.7
	5 (4)		40.6	19.6	98	52.1	26.6	20.3
	7.5 (5.5)		61	28.3	140	74.6	35	29
	10 (7.5)			38.2	179	94.4	45.5	35
	15 (11)			54.7		140.6	65	56
	20 (15)			79		180.2	83	68
	25 (18.5)			92.5		226.4	104	83
	30 (22)			110.5			122	104
	40 (30)						158	125
	50 (37)						197	158
60 (44)						242	188	
4	1 (0.75)	19.8		7.6		20.4	10.4	8.8
	1.5 (1.1)	27.8	17.4	9.2	52	28.4	12.8	11.6
	2 (1.5)	37.4	22.6	11.6	62	32	15.6	12.8
	3 (2.2)		32.6	16.2	84	44.4	21.2	17.6
	5 (4)		53.8	25.8	130	68.8	34.8	26.4
	7.5 (5.5)		81	37.4	186	98.8	46	38
	10 (7.5)			50.6	238	125.2	60	46
	15 (11)			72.6		186.8	86	74
20 (15)			105		239.6	110	90	

Number of pumps	Motor power [hp (kW)]	MPC-E (CRE/CME)			MPC-E (CUE)			
		1 x 230 V	3 x 208-230 V	3 x 460-480 V	1 x 230 V	3 x 208-230 V	3 x 460-480 V	3 x 575-600V
4	25 (18.5)			123		301.2	138	110
	30 (22)			147			162	138
	40 (30)						210	166
	50 (37)						262	210
	60 (44)						322	250
5	1 (0.75)	24.5		9.25		25	12.5	10.5
	1.5 (1.1)	34.5	21.5	11.25	64.5	35	15.5	14
	2 (1.5)	46.5	28	14.25	77	39.5	19	15.5
	3 (2.2)		40.5	20	104.5	55	26	21.5
	5 (4)		67	32	162	85.5	43	32.5
	7.5 (5.5)		101	46.5	232	123	57	47
	10 (7.5)			63	297	156	74.5	57
	15 (11)			90.5		233	107	92
	20 (15)			131		299	137	112
	25 (18.5)			153.5		376	172	137
	30 (22)			183.5			202	172
	40 (30)						262	207
	50 (37)						327	262
	60 (44)						402	312

Number of pumps	Motor power [hp (kW)]	MPC-E (CRE/CME)			MPC-E (CUE)			
		1 x 230 V	3 x 208-230 V	3 x 460-480 V	1 x 230 V	3 x 208-230 V	3 x 460-480 V	3 x 575-600V
6	1 (0.75)	29.2		10.9		29.6	14.6	12.2
	1.5 (1.1)	41.2	25.6	13.3	77	41.6	18.2	16.4
	2 (1.5)	55.6	33.4	16.9	92	47	22.4	18.2
	3 (2.2)		48.4	23.8	125	65.6	30.8	25.4
	5 (4)		80.2	38.2	194	102.2	51.2	38.6
	7.5 (5.5)		121	55.6	278	147.2	68	56
	10 (7.5)			75.4	356	186.8	89	68
	15 (11)			108.4		279.2	128	110
	20 (15)			157		358.4	164	134
	25 (18.5)			184		450.8	206	164
	30 (22)			220			242	206
	40 (30)						314	248
	50 (37)						392	314
	60 (44)						482	374







Maximum system amperage reflects panels with no options and may change due to panel options requested.

12. Optional equipment

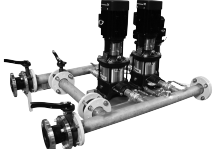

All optional equipment must be specified when ordering the system, as it must be installed at the factory before delivery. See options in the type key.



The options listed below are not all available for all markets.

Option	Description	Location	Options (type key for Hydro MPC)
Standard hydraulics, PN 16	 This is the standard option for Hydro MPC hydraulics rated for PN 16 as a minimum.	System	A
Pilot pump	 The pilot pump takes over operation from main pumps during periods of low consumption. The pilot pump can deliver the necessary flow and thereby maintain high efficiency. The typically pump size is 25 % of the main pump. Pilot pumps are available for Hydro MPC-E and -F control variants.	System	B
Bypass connection	 The bypass connection is a pipe diversion consisting of a manifold, two isolating valves and a check valve. The bypass connection allows water to bypass the pumps from the inlet to the outlet manifold.	System	C
Elbow manifold	- Manifolds with elbows in one end can reduce dead ends. On request.	Inlet or outlet side	E
No inlet manifold	 Depending on the application or installation site, the system can be ordered without inlet manifold.	-	F
Diaphragm tank	 In buildings it is usually necessary to install a diaphragm tank on the outlet side of the system. As standard, the system is designed for a maximum system pressure of 16 bar. A standard system includes pressure transmitters and one gauge with a rated pressure of 16 bar (full scale). Hydro MPC systems designed for PN 16 diaphragm tanks up to 33 litres are mounted on the outlet manifold.	On outlet manifold Up to 33 l	G
Dry-running protection	 The system must be protected against dry running. The inlet conditions determine the type of dry-running protection. <ul style="list-style-type: none"> If the system draws water from a tank or a well, select a level switch or an electrode relay for dry-running protection. If the system has an inlet pressure, select a pressure transmitter or a pressure switch for dry-running protection. For further description, see section Dry-running protection.	On inlet manifold	H
Repair switch	- With a repair switch fitted on the individual pumps of the Hydro system, the supply voltage to the pump can be switched off during, for example, repair. One switch per pump.	On the pump	I

Option		Description	Location	Options (type key for Hydro MPC)
Redundant primary sensor		To increase the reliability, a redundant primary sensor can be connected as a backup sensor for the primary sensor. The redundant primary sensor must be of the same type as the primary sensor. For further description, see section Redundant primary sensor.	-	J
One free pump position		Systems with one free pump position are available for the system with 3 to 6 pumps. The systems, including the control cabinet, are prepared for the future pump.	-	K
Two free pump positions	-	Systems with two free pump positions are available for the system with 4 to 6 pumps. The systems, including the control cabinet, are prepared for the future pumps.	-	L
Three free pump positions		Systems with three free pump positions are available for the system with 5 to 6 pumps. The systems, including the control cabinet, are prepared for the future pumps.	-	M
PN 10 pressure rating	-	With this option, the rated pressure of the Hydro MPC hydraulics is at least PN 10.	-	N
PN 25 pressure rating	-	With this option, the rated pressure of the Hydro MPC hydraulics is at least PN 25.	-	O
PN 40 pressure rating	-	With this option, the rated pressure of the Hydro MPC hydraulics is at least PN 40.	-	P
Low pre-pressure (low NPSH)	-	The systems are available with CR low-NPSH pumps designed to eliminate the risk of cavitation and ensure a stable and reliable operation. The CR low-NPSH has a special inlet design that reduces the NPSH value required by the pump and prevents erosion and damage to the pump, pipes and valves. The improved inlet design may expose the low-NPSH pump to more stress than conventional pumps, but it does not affect the stability of operation. The CR low-NPSH pump reduces excess pressure itself and does not require any additional tank to provide supplementary pressure. Systems are available on request with CR low-NPSH from CR, CRI 3 to CR, CRI 20 and CRN, CRNE from CRN, CRNE 3 to CRN, CRNE 64.	-	Q
RPM = 50 Hz	-	50 Hz pumps.	-	R
Customized variant	-	Customized systems can be produced on request. For further information contact your local Grundfos sales office.	-	S
Certificate	-	For further information contact your local Grundfos sales office.	-	T

Option	Description	Location	Options (type key for Hydro MPC)
Undersized motor	 <p>We recommend a Hydro system with undersized motors if operating conditions deviate from those stated in the Hydro MPC Data Booklet and Grundfos Product Center.</p> <p>We especially recommend undersized motors if the duty point is constant and the flow rate is significantly lower than the maximum recommended flow rate.</p>	-	U
Standard controls with options	 <p>See Control MPC installation and operating instructions.</p>	-	V
Customized controls	 <p>See Control MPC installation and operating instructions.</p>	-	W

Related information

[Dry-running protection](#)

[Redundant primary sensor](#)

Dry-running protection

Description	Range [psi (bar)]
Dry-running protection by means of an electrode relay, without electrodes and electrode cable ¹²⁾	-
	0-87 (0-6)
Inlet pressure sensor ¹³⁾	0-145 (0-10)
	0-232 (0-16)

¹²⁾ Only one type of dry-running protection can be selected, as it must be connected to the same digital input as CU 352. This also applies to level switches. For further information about CU 352, see section CU 352.

¹³⁾ The inlet pressure sensor is normally connected to the analog input AI2 of CU 352. If this input is used for another function, such as "External setpoint", connect the sensor to the analog input AI3. If, however, this input is also occupied, increase the number of analog inputs by installing an IO 351B module, see section Optional equipment, Control MPC. For further information about IO 351B, see section IO 351.

Related information

[CU 352](#)

[IO 351](#)



Redundant primary sensor

Description	Range [bar]
	0-10
	0-16
Redundant primary sensor ¹⁴⁾	0-25
	0-40

¹⁴⁾ The redundant primary sensor is normally connected to the analog input AI3 of CU 352. If this input is occupied, increase the number of analog inputs by installing an IO 351B module, see Control MPC installation and operating instructions.

13. Accessories

All accessories can be fitted to the system after delivery.

Option	Description
Dry-running protection	- The system must be protected against dry running. Dry-running protection by means of level switches is used in installations where the system draws water from a tank or well. For further description, see section Dry-running protection.
Diaphragm tank	-  A diaphragm tank can be installed on the outlet side of the system. The diaphragm tanks are separate tanks without valve, fittings and pipes. For further data, see section Diaphragm tank.
Grundfos GO	- Grundfos GO is used for wireless infrared or radio communication with the pumps. Various Grundfos GO variants are available. For further description, see section Grundfos GO.
MI 301	-  The MI 301 is a module with built-in infrared and radio communication. Use the MI 301 in conjunction with an Android- or iOS-based Smartphone with a Bluetooth connection. The MI 301 has a rechargeable Li-ion battery and must be charged separately. For further description, see section Grundfos GO.

Related information

[Dry-running protection](#)

[Diaphragm tank](#)

[Grundfos GO](#)

Dry-running protection

Description	Product number
Level switch including 5 m of cable ¹⁵⁾	96020142

¹⁵⁾ The input for the level switch is not included.

See section Optional equipment.

Only one type of dry-running protection can be selected, as it must be connected to the same digital input as CU 352. This also applies to level switches.

Related information

[12. Optional equipment](#)

Diaphragm tank

Recommended diaphragm tank size for systems with CR, CRE pumps

Pump type	Tank size [gallons]	
	-E	-E (CUE)
CR, CRE 3	4.4	4.4
CR, CRE 5	4.4	4.4
CR, CRE 10	10.3	10.3
CR, CRE 15	34	34
CR, CRE 20	34	34
CR, CRE 32	44	44
CR, CRE 45	86	86
CR, CRE 64	132	132

Pump type	Tank size [gallons]	
	-E	-E (CUE)
CR, CRE 95	132	132
CR, CRE 125	211	211
CR, CRE 155	211	211

Recommended diaphragm tank size for systems with CME pumps

Pump type	Tank size [gal (l)]
CME 3	4.4 (17)
CME 5	4.4 (17)
CME 10	10.3 (39)
CME 15	34 (129)

Grundfos GO

The Grundfos GO is used for wireless infrared or radio communication with the pumps.

MI 301

MI 301 is a module with built-in infrared and radio communication. MI 301 must be used in conjunction with an Android or iOS-based Smartphone via Bluetooth connection. MI 301 has a rechargeable Li-ion battery and the battery must be charged separately.



TM053890

MI 301

Supplied with the product:

- Grundfos MI 301
- battery charger
- quick guide.

Product numbers for MI 301

Grundfos GO variant	Product number
Grundfos MI 301	98046408

14. Product manuals

Title	Document type	QR code	Link	Publication number
CR, CRI, CRN (60 Hz)	Data booklet		http://net.grundfos.com/qr/i/98446676	98446676
CR, CRI, CRN, CRT, GRE, CRIE, CRNE, CRTE custom-built pumps (60 Hz)	Data booklet		http://net.grundfos.com/qr/i/98522834	98522834
CR, CRN 95-255 (60 Hz)	Data booklet		http://net.grundfos.com/qr/i/99407996	99407996
CRE, CRIE, CRNE	Data booklet		http://net.grundfos.com/qr/i/98556115	98556115
CR, CRI, CRN, CRT	Installation and operating instructions		http://net.grundfos.com/qr/i/98419736	98419736
CR, CRN 95-255	Installation and operating instructions		http://net.grundfos.com/qr/i/99347135	99347135
CR, CRN 95-255	Service instructions		http://net.grundfos.com/qr/i/99233360	99233360
CM, CME	Data booklet		http://net.grundfos.com/qr/i/98435269	98435269
CM, CME	Installation and operating instructions		http://net.grundfos.com/qr/i/97526969	97526969
Hydro MPC	Installation and operating instructions		http://net.grundfos.com/qr/i/99320238	99320238
Hydro MPC	Quick guide		http://net.grundfos.com/qr/i/99107595	99107595
Control MPC	Installation and operating instructions		http://net.grundfos.com/qr/i/99725671	99725671
Tank calculation in E systems -			http://net.grundfos.com/qr/i/92845021	92845021

The documents are available in Grundfos Product Center on www.grundfos.com.

Related information

[16. Grundfos Product Center](#)

15. Alternative systems

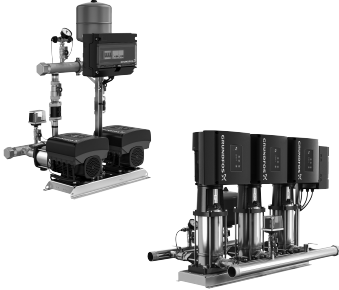
System	Data and features	
Hydro Multi-E 	Maximum head	10 to 145 m
	Flow rate	2 to 144 m ³ /h
	Max. operating pressure	16 bar
	Number of pumps	2 or 4
	Pump type	CRE, CRIE, CME
Features	Specially designed for water supply in buildings. 100 % adaptation to consumption. Easy to install and commission. Small footprint. Data communication via Grundfos GO.	

16. Grundfos Product Center

Online search and sizing tool to help you make the right choice.

From the international view, you can select your specific country to view the product range available to you.

International view: <https://product-selection.grundfos.com>

All the information you need in one place

Performance curves, technical specifications, pictures, dimensional drawings, motor curves, wiring diagrams, spare parts, service kits, 3D drawings, documents, system parts. The Product Center displays any recent and saved items - including complete projects - right on the main page.

Downloads

On the product pages, you can download installation and operating instructions, data booklets, service instructions, etc., in PDF format.

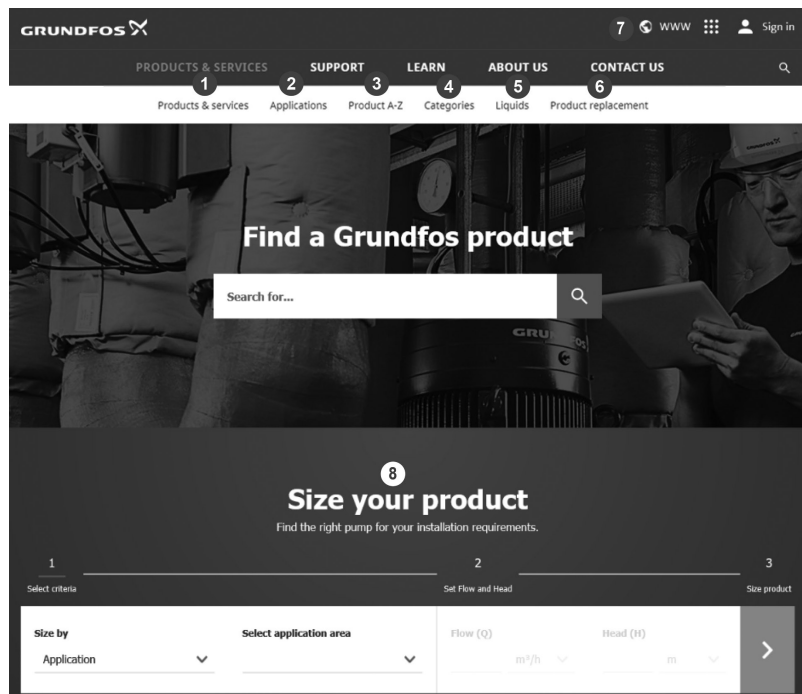

When you select your country, you will see the menus below. Note that some menus may not be available depending on the country.

Example: <https://product-selection.grundfos.com/uk>

Pos.	Description
1	Products & services enables you to find products and documents by typing a product number or name into the search field.
2	Applications enables you to choose an application to see how Grundfos can help you design and optimise your system.
3	Products A-Z enables you to look through a list of all the Grundfos products.
4	Categories enables you to look for a product category.
5	Liquids enables you to find pumps designed for aggressive, flammable or other special liquids.
6	Product replacement enables you to find a suitable replacement.
7	WWW enables you to select the country, which changes the language, the available product range and the structure of the website.
8	Sizing enables you to size a product based on your application and operating conditions.

17. Grundfos GO

Mobile solution for professionals on the GO!

Grundfos GO is the mobile toolbox for professional users on the go. It is the most comprehensive platform for mobile pump control and pump selection, including sizing, replacement and documentation. It offers intuitive, handheld assistance and access to Grundfos online tools, and it saves valuable time for reporting and data collection.

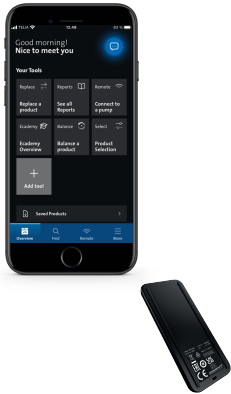

GET IT ON
Google play

Available on the
App Store



99537904 06.2024

ECM: 1397574

GRUNDFOS Holding A/S
Poul Due Jensens Vej 7
DK-8850 Bjerringbro
Tel: +45 87 50 14 00
www.grundfos.com

GRUNDFOS 