

# SP

Submersible pumps, motors, and accessories  
North America, 60 Hz



<b>1. Product data</b> . . . . .	<b>3</b>	SP 800S (800 gpm) . . . . .	104
Introduction . . . . .	3	SP 1100S (1100 gpm) . . . . .	109
Pump Energy Index . . . . .	3		
Applications . . . . .	4	<b>7. Electrical data</b> . . . . .	<b>114</b>
Features and benefits . . . . .	4		
Performance range 60 Hz . . . . .	9	<b>8. Approvals</b> . . . . .	<b>117</b>
Pump range . . . . .	10		
Motor protection and controllers range . . . . .	10	<b>9. Accessories</b> . . . . .	<b>118</b>
Identification . . . . .	11	Grundfos RSI (Renewable Solar Inverter) . . . . .	118
<b>2. Construction</b> . . . . .	<b>15</b>	SmartFlo variable frequency drive . . . . .	120
Sectional drawing, SP pump 4" spline shaft (SP		SmartFlo installation . . . . .	125
5S - 25S) . . . . .	15	SmartFlo electrical connection . . . . .	126
Sectional drawing, SP pump 4" smooth shaft (SP		SmartFlo technical data . . . . .	133
35S - 77S) . . . . .	16	CUE variable frequency drive . . . . .	143
Sectional drawing, SP pump 6" (SP 90S - 300S) . . . . .	17	MP 204 . . . . .	145
Sectional drawing, SP pump 8" (SP 385S - 475S) . . . . .	18	Connecting pieces . . . . .	148
Sectional drawing, SP pump 10" (SP 625S -		Zinc anodes . . . . .	148
1100S) . . . . .	19	SA-SPM 6 control boxes . . . . .	149
Sectional drawing, MS motors . . . . .	20	Pt100/Pt1000 . . . . .	150
Sectional drawing, MMS motors . . . . .	21		
<b>3. Operating conditions</b> . . . . .	<b>22</b>	<b>10. Energy consumption</b> . . . . .	<b>153</b>
Operating conditions . . . . .	22	Energy consumption of submersible pumps . . . . .	153
<b>4. Selection</b> . . . . .	<b>23</b>	<b>11. Cables</b> . . . . .	<b>154</b>
5S - 25S easy selection charts . . . . .	23	Cable sizing charts . . . . .	154
<b>5. Performance curves and technical data</b> . . . . .	<b>32</b>	<b>12. Friction loss tables</b> . . . . .	<b>159</b>
How to read the curve charts . . . . .	32	<b>13. Grundfos Product Center</b> . . . . .	<b>162</b>
Curve conditions . . . . .	33	<b>14. Document quality feedback</b> . . . . .	<b>163</b>
<b>6. Curve charts and technical data</b> . . . . .	<b>34</b>		
4" and larger wells . . . . .	34		
SP 5S (5 gpm) . . . . .	34		
SP 7S (7 gpm) . . . . .	36		
SP 10S (10 gpm) . . . . .	38		
SP 16S (16 gpm) . . . . .	40		
SP 25S (25 gpm) . . . . .	42		
SP 35S (35 gpm) . . . . .	44		
SP 45S (45 gpm) . . . . .	50		
SP 62S (62 gpm) . . . . .	55		
SP 77S (77 gpm) . . . . .	60		
6" and larger wells . . . . .	64		
SP 90S (90 gpm) . . . . .	64		
SP 160S (160 gpm) . . . . .	71		
SP 230S (230 gpm) . . . . .	77		
SP 300S (300 gpm) . . . . .	83		
8" and larger wells . . . . .	89		
SP 385S (385 gpm) . . . . .	89		
SP 475S (475 gpm) . . . . .	94		
10" and larger wells . . . . .	99		
SP 625S (625 gpm) . . . . .	99		

# 1. Product data

## Introduction

The Grundfos SP range of submersible pumps is renowned for high efficiency and reliability. SP pumps are ideal for a wide variety of applications and are made entirely of corrosion resistant stainless steel.

Grundfos SP pumps represent state-of-the-art hydraulic design. SP pumps are built to deliver optimum efficiency during periods of high demand, and they provide low long-term costs and high operating reliability regardless of the application.

The SP range offers high efficiency, high resistance to sand and other abrasives, motor burnout protection, and easy maintenance. A complete monitoring and control system is available for constant optimization of the pumping system.



Grundfos SP pumps

TM064950

## Pump Energy Index

Pump Energy Index (PEI) was established by the U.S. Department of Energy (DOE) and adopted by Canada as the standard metric used to evaluate pump efficiency. The value is the ratio of the pump efficiency rating (PER) divided by the calculated minimally compliant PER (PER<sub>STD</sub>) for the pump type. This provides a representation of a pump's actual performance compared to the minimal standard performance required by regulation. The lower the PEI value, the more efficient a pump is at the tested operating points.

PER is determined by defined testing parameters required by the DOE. This includes testing a particular pump model at its best efficiency point (BEP).

There are two different PEI values:

- PEI<sub>CL</sub> (constant load): Applies to a bare-shaft pump, and a pump sold with a motor
- PEI<sub>VL</sub> (variable load): Applies to pumps sold with a motor and controller (such as VFD, VSD).

The DOE has set the maximum PEI value as 1.00. Any pump, pump and motor, or pump, motor and controller that exceeds a PEI value of 1.00 can no longer be manufactured after January 26, 2020.

PEI is a generalized efficiency value. PEI cannot be used to determine the efficiency of a pump in a specific application.

Pump type	Pole	PEI <sub>CL</sub> bare-shaft pump	PEI <sub>CL</sub> pump with motor	PEI <sub>VL</sub> pump with motor plus controller <sup>1)</sup>	Impeller diameter [in (mm)]
25S		0.93	0.93	0.59	2.87 (72)
35S		0.85	0.87	0.54	2.88 (73)
45S		0.84	0.84	0.54	2.87 (72)
62S		0.88	0.88	0.54	2.78 (71)
77S	2	0.89	0.91	0.54	2.78 (71)
90S		0.84	0.84	0.51	3.49 (89)
160S		0.91	0.91	0.56	3.52 (89)
230S		0.92	0.92	0.54	3.87 (98)
300S		0.92	0.92	0.53	3.90 (99)

<sup>1)</sup> Grundfos CUE continuous controls.

## Applications

Grundfos large SP submersible pumps are suitable for:

- Groundwater supply to waterworks
- irrigation in horticulture and agriculture
- groundwater lowering (dewatering)
- pressure boosting
- industrial applications
- domestic water supply.

## Pumped liquids

Grundfos SP pumps are suitable for pumping clean, thin, non-aggressive liquids without solid particles or fibers.

SP offers stainless steel construction which ensures good wear resistance and a reduced risk of corrosion where the water has minor chloride content.

Optional, upgraded stainless steel construction is available for pumping more aggressive liquids:

- A complete range of zinc anodes for cathodic protection is available. See, for example, sea water applications in section Zinc anodes.
- For slightly polluted liquids, such as containing oil, Grundfos offers a complete range of stainless steel SP NE pumps with all rubber parts made of FKM.

## Related information

[Zinc anodes](#)

## Features and benefits

Grundfos SP submersible pumps offer these features and benefits:

- State-of-the-art hydraulics provide high efficiency and low operating costs
- 100 % stainless steel components inside and outside for long service life
- sand resistant
- resistant to aggressive water
- dry-running protection
- monitoring, protection and communication via
  - protection unit MP 204
  - Grundfos GO.

## A wide pump range

Grundfos offers energy-efficient SP submersible pumps with a performance range of up to 1,400 gpm (318 m<sup>3</sup>/h) and 2,100 ft (640 m) of head.

The pump range consists of many pump sizes, and each pump size is available with an optional number of stages to match any duty point.

## High pump efficiency

Pump efficiency is often given less consideration than the price of a pump; however, owners who choose efficiency find substantial savings in energy costs over time. See the figure below for an illustration of SP efficiencies in relation to flow rate.

### Example

For example, choosing a pump and motor with a 10 % higher efficiency than a cheaper, less efficient pump can amount to more than \$80,000 savings over 10 years<sup>2)</sup>.

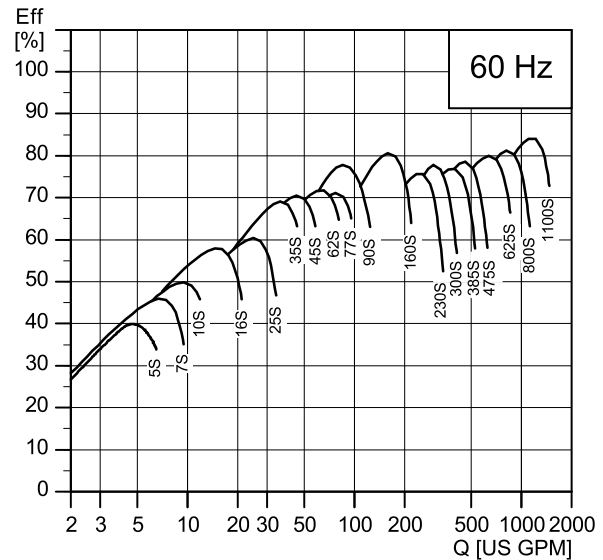

TM050057

SP pump and motor efficiencies in relation to flow rate

<sup>2)</sup> If producing 880 gpm at 325 ft of head for 10 years at 13.8 cents per kWh. U.S. kWh costs range from 6 cents to more than 20 cents, depending on region.

### Pump design

Grundfos SP submersible pumps feature components that contribute to the superior performance and durability of the range.

### Lower installation costs

Stainless steel means low weight for ease of pump handling, resulting in lower equipment costs and reduced installation and service time.

### Bearings with sand channels

All bearings are water-lubricated and have a squared shape enabling sand particles, if any, to leave the pump together with the pumped liquid.



TM0007301

Bearing

### Inlet strainer

The inlet strainer prevents particles over a certain size from entering the pump.

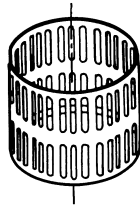

TM0007302

Inlet strainer

### Check valve

All pumps are equipped with a reliable check valve in the valve casing preventing back flow in connection with pump stoppage.

The short closing time of the check valve reduces the risk of destructive water hammer to a minimum.

The valve casing is designed for optimum hydraulic properties to minimize the pressure loss across the valve, and thus to contribute to the high efficiency of the pump.

**Note:** As shown in fig. Check valve, the check valve is spring-assisted and intended for vertical pump applications. When installing the pump at an angle, installation requires an additional check valve installed in the outlet piping. This prevents misalignment or failure to seat the pump check valve at an angle. Additional check valves in outlet piping are sold separately.

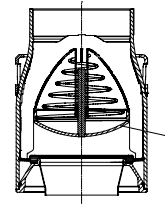

TM0124991

Check valve

Pos.	Description
1	Check valve

### Priming screw

All Grundfos 4" pumps with radial impellers are fitted with a priming screw. Consequently, dry running is prevented because the priming screw ensures that the pump bearings are always lubricated.

Due to the semi-axial impellers of large SP pumps, this priming is provided automatically.

However, if the water table is lowered to a level below the pump inlet, neither the pump nor the motor is protected against dry running. This applies to all pump types.

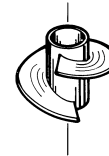

TM0007304

Priming screw

### Stop ring

The stop ring prevents damage to the pump during transport and in case of up-thrust in connection with startup.

The stop ring, which is designed as a thrust bearing, limits axial movements of the pump shaft.

#### Example: SP 385S

The stationary part of the stop ring (A) is secured in the upper intermediate chamber.

The rotating part (B) is fitted above the split cone (C).

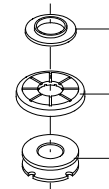

TM013327

Stop ring (rotating and stationary part) and the split cone

## Grundfos submersible motors

### A complete motor range

Grundfos offers a complete submersible motor range in different voltages. For an overview of motor types, sizes and voltages, see section Electrical data.

- MS402 is designed for the domestic ground water market and covers outputs.
- The MS4000C and MS6000C series are designed for use in a variety of applications in water supply. When equipped with features like oversized motor, temperature measurement, cooling jacket, and SiC/SiC mechanical shaft seals, these motors are suitable for heavy-duty industrial applications, such as dewatering operations.

As a standard, all external surfaces of Grundfos MS motors in contact with water are made of AISI 304 stainless steel. For aggressive water, such as seawater or brackish water, R versions made of AISI 904L are available.

#### Related information

##### [7. Electrical data](#)

### Grundfos rewindable MMS motor range

Grundfos MMS motors are suitable for any submersible installation, including heavy-duty industrial applications and dewatering operations (when equipped with temperature control, oversized motor, cooling jacket, and SiC/SiC mechanical shaft seals).

As standard MMS motors are supplied with black cast-iron end-bells. Optionally, the range is available in all-stainless steel AISI 316 or AISI 904L versions.

The 2-pole Grundfos MMS submersible motors are all easy to rewind. The windings of the stator are made of pure electrolytic copper sheathed with special non-hydroscopic thermoplastic material. The fine dielectric properties of this material allow direct contact between the windings and the liquid for efficient cooling of the windings.

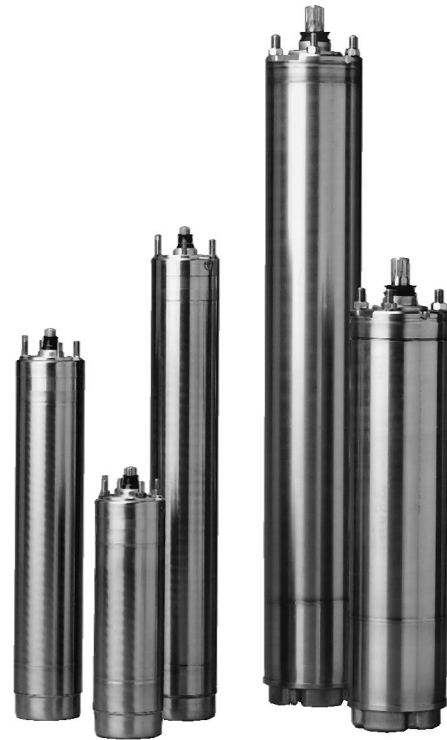

TM007305

Grundfos MS motors

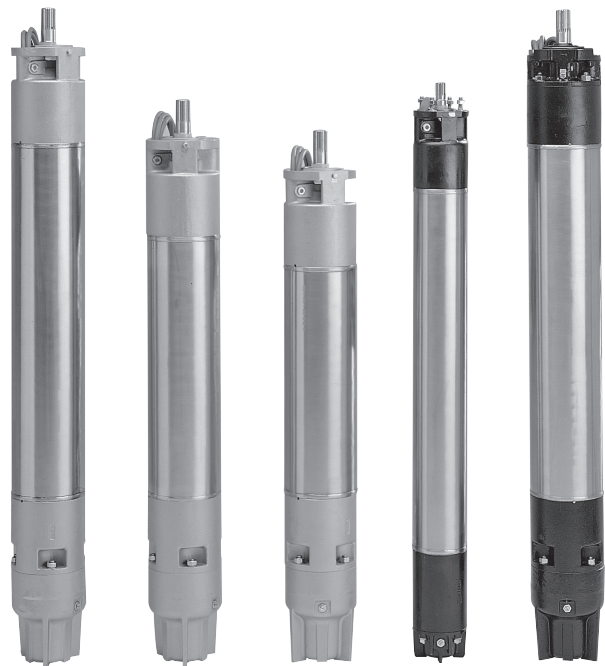

TM086096

Grundfos MMS motors

## Industrial submersible motors and MS 6000C T60 versions

For heavy-duty applications, Grundfos offers a complete motor range of industrial motors with up to 5 % higher efficiency than that of Grundfos' standard motors.

The cooling of the motor is very efficient due to the large motor surface. The efficient cooling makes it possible to increase the liquid temperature on T60 motors to 140 °F (60 °C) at a minimum flow rate of 3.3 fps (1.0 m/s) past the motor.

The industrial motors are for customers who value low operating costs and long life more than price.

Grundfos industrial motors are developed for difficult operating conditions. These motors stand a higher thermal load than standard motors, and thus have a longer life when subjected to high load. This applies whether the high load is caused by bad power supply, hot water, bad cooling conditions, high pump load or other conditions.

Note that heavy duty motors are longer than motors for standard conditions.

### Overtemperature protection

Accessories for overtemperature protection are available for both Grundfos MS and MMS submersible motors. When the temperature becomes too high, the protection device cuts out so damage to the pump and motor can be avoided.

Restart of the motor after cut-out can be achieved in two ways:

- manual restart
- automatic restart.

Automatic restart means that MP 204 attempts to restart the motor after 15 minutes. If the first attempt is not successful, restarting is reattempted at 30-minute intervals.

**MS:** The Grundfos MS submersible motors (with the exception of MS 402) are available with a built-in Tempcon temperature transmitter for overtemperature protection. It is possible to read out and/or monitor the motor temperature by a transmitter through an MP 204.

The Grundfos MS 402, MS 4000C, and MS 6000C submersible motors can be fitted with a Pt100/Pt1000. Pt100/Pt1000 is fitted in the motor and connected directly to MP 204 or monitored by the PR 5714 relay.

**MMS:** For overtemperature protection, Grundfos offers the Pt100/Pt1000 temperature sensor as an optional extra.

Pt100/Pt1000 is fitted in the motor and connected directly to MP 204 or monitored by the PR 5714 relay.

### Upthrust protection

In case of a very low counter pressure during startup, there is a risk that the entire chamber stack may rise. This is called upthrust. Upthrust may damage both pump and motor. Grundfos pumps and motors are protected against upthrust as standard, preventing upthrust from occurring during the critical startup phase. The protection consists of either a built-in stop ring or hydraulic balancing.

## Built-in cooling chambers

In all Grundfos MS submersible motors, efficient cooling is ensured by cooling chambers at the top and at the bottom of the motor, and by an internal circulation of motor liquid. See fig. Shaft seal, MS 4000C.

As long as the required flow velocity past the motor is maintained, cooling of the motor is efficient.

### Related information

[MS4000C](#)

### Lightning protection

The smallest Grundfos submersible motors, such as MS 402, are all insulated to minimize the risk of motor burnout caused by lightning strike.

### Reduced risk of short-circuit

The embedded stator winding in the Grundfos MS submersible motor is hermetically enclosed in stainless steel. The result is high mechanical stability and optimum cooling. It also eliminates the risk of short-circuit of the windings caused by water condensation.

## Shaft seal

### MS402

The shaft seal is of the lip seal type characterized by low friction against the rotor shaft.

The rubber material offers good wear resistance, good elasticity and resistance to particles, and it is approved for use in drinking water.

### MS4000C

Ceramic/carbon materials provide the MS shaft seals with optimum sealing, optimum wear resistance and long life.

### MS6000C

The MS6000C shaft seal material is SiC/SiC. The spring loaded shaft seal is designed with a large surface and a sand shield. The result is a minimum exchange of pumped and motor liquids and no penetration of particles.

Motors, version R, are supplied with a SiC/SiC shaft seal. Other combinations are available on request. See figures Shaft seal, MS4000C and Shaft seal, MS6000C for an illustration of shaft seal components and configuration.

#### Related information

[MMS rewindable motors](#)

### MMS rewindable motors

The standard shaft seal is a SiC/SiC mechanical shaft seal. The shaft seal is replaceable.

The material features good wear resistance and resistance to particles.

Together with the shaft seal housing, the sand shield forms a labyrinth seal, which during normal operating conditions prevents penetration of sand particles into the shaft seal.

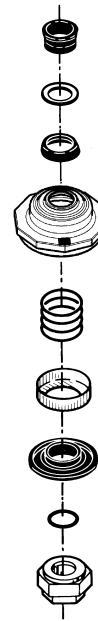

Shaft seal, MS 4000C

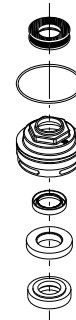

Shaft seal, MS 6000C

TM007306\_0412

TM039225



Performance range 60 Hz

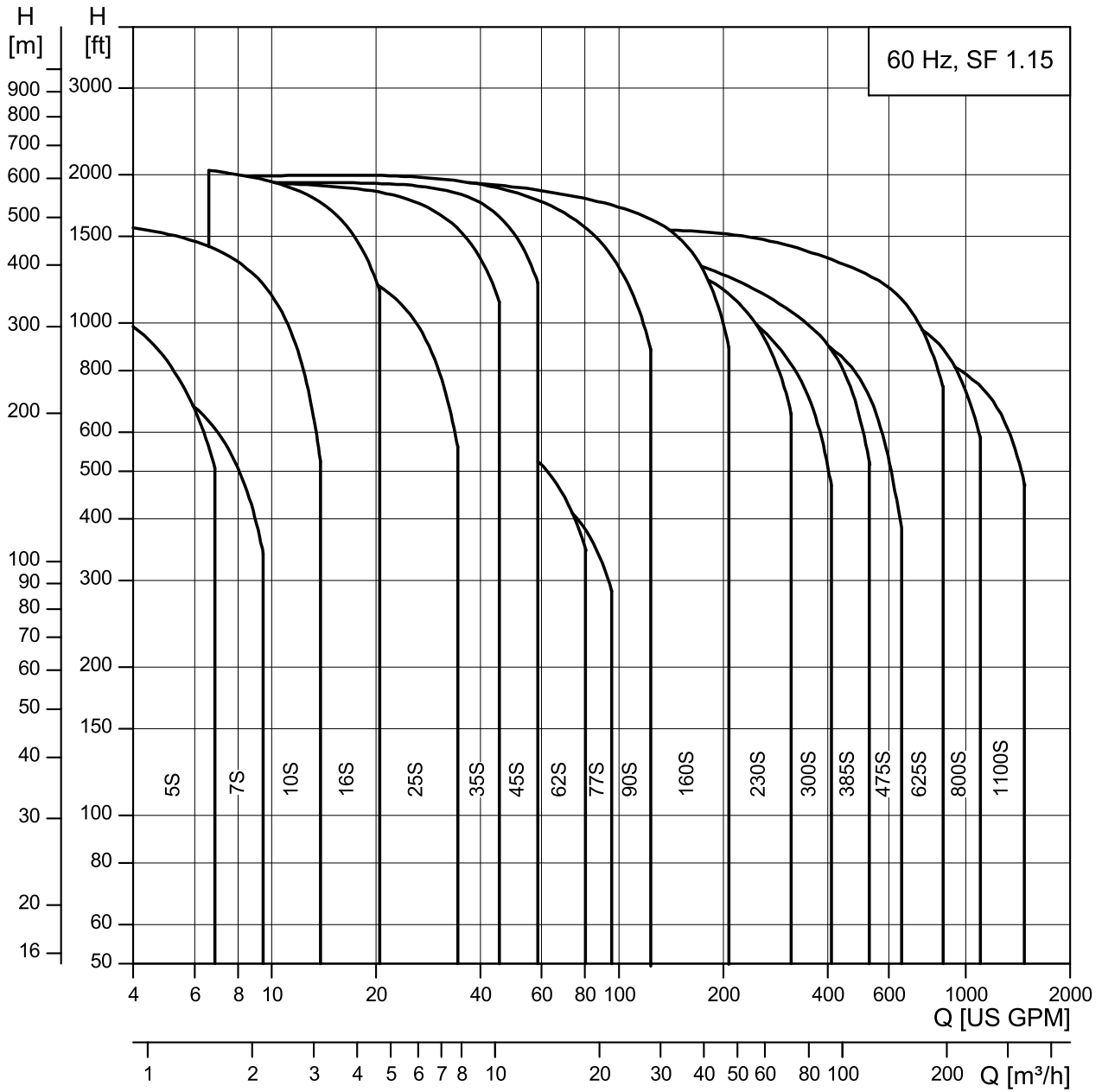

TM050056

## Pump range

Type	5S	10S	16S	25S	35S	45S	62S	77S	90S	160S	230S	300S	385S	475S	625S	800S	1100S	
AISI 304 (EN 1.4301) stainless steel	•	•	•	•	•	•	•	•	•	•	•	•	•	•	•	•	•	
AISI 316 (EN 1.4401) stainless steel			•	•	•	•	•	•	•	•	•	•	•	•	•	•	•	
AISI 904L (EN 1.4539) stainless steel				•	•	•	•	•	•	•	•	•	•	•	•	•	•	
Connection <sup>3)</sup>	NPT	1"	1.25"	1.25"	1.5"	1.5" (2")	2" (2")	2"	2"	(3")	(3")	3" (4")	3" (4")	4"	6"	6"	6"	6"
Flange connection: Grundfos flange													4"	6"	6"	6"	6"	

<sup>3)</sup> Figures in brackets ( ) indicate connection for pumps including sleeve and male thread.

## Motor protection and controllers range

Motor output [Hp]	0.5	0.75	1.0	1.5	1.5	3.0	5.0	7.5	10.0	15	20	25	30	40	50	60	75	100	125	150	175	200	250	
MP 204	•	•	•	•	•	•	•	•	•	•	•	•	•	•	•	•	•	•	•	•	•	•	•	•
Pt100							•	•	•	•	•	•	•	•	•	•	•	•	•	•	•	•	•	•
Pt1000	•	•	•	•	•	•	•	•																
Zinc anode				•	•	•	•	•	•	•	•	•	•	•	•	•	•	•	•	•	•	•	•	•
Vertical flow sleeve	•	•	•	•	•	•	•	•	•	•	•	•	•	•	•	•	•	•	•	•	•	•	•	•
Horizontal flow sleeve	•	•	•	•	•	•	•	•	•	•	•	•	•	•	•	•	•	•	•	•	•	•	•	•
SA-SPM6	•	•	•	•	•	•	•	•	•	•														
GO remote	•	•	•	•	•	•	•	•	•	•	•	•	•	•	•	•	•	•	•	•	•	•	•	•
RS-485 communication module	•	•	•	•	•	•	•	•	•	•	•	•	•	•	•	•	•	•	•	•	•	•	•	•

For motor protection of single-phase motors, see section Electrical data.

### Related information

[7. Electrical data](#)

## Identification

### Type key, SP pumps

Example: 475S500-5-AB

<b>Example</b>	<b>475</b>	<b>S</b>	<b>500 -</b>	<b>5 -</b>	<b>A</b>	<b>B</b>
Pos.	1	2	3	4	5	6

Pos.	Description
1	Rated flow rate in gpm
2	Type range Stainless steel parts of material
	S = AISI 304 (EN 1.4301) SS
	N = AISI 316 (EN 1.4401) SS
	R = AISI 904L (EN 1.4539) SS
3	Hp of motor
4	Number of impellers
5	First reduced-diameter impeller (A, B or C)
6	Second reduced-diameter impeller (A, B or C)

### Type key, MS402 motors

Example: MS402

<b>Example</b>	<b>MS</b>	<b>4</b>	<b>02</b>
Pos.	1	2	3

Pos.	Description
1	Motor submersible
2	Minimum well casing diameter in inches
3	Generation
4	Material type
-	= AISI 304 (EN 1.4301) stainless steel

### Type key, MS4000C motors

Example: MS4000RESWDMXT4 3 x 380-415/60 10 Hp

<b>Example</b>	<b>MS4000 A</b>	<b>R</b>	<b>E</b>	<b>S</b>	<b>W</b>	<b>D</b>	<b>M</b>	<b>X</b>	<b>T4</b>	<b>3 x 380-415/50</b>	<b>7.5 kW</b>
Pos.	1	2	3	4	5	6	7	8	9	10	11

Pos.	Description
1	Motor type
	MS4000A = MS4000 asynchronous motor
2	Material version
	Z = EN 1.4301
	R = EN 1.4539
3	Elastomers
	B = NBR
	E = FKM
4	Shaft seal
	C = Hard metal / Ceramic
	S = SiC/SiC
	Bearing system
5	W = Ceramic

6	Motor liquid		
	L	=	SML-3
	D	=	Demineralised water
	H	=	Glycol 60 vol % HTF
7	Thread		
	U	=	UNF 5/16
	M	=	M8
8	Tempcon		
	J	=	With
	X	=	Without
9	Max. liquid temperature at 0.15 m/s		
	T4	=	40 °C at min. 0.15 m/s
	T6	=	60 °C at min. 1.0 m/s
10	Voltage		
	Code	Voltage	Thread
	08	= 3 x 340 - 360 - 380 V, 50 Hz, 3 x 440 V, 60 Hz	= M8
	09	= 3 x 200 V, 50 Hz, 3 x 200 - 220 V, 60 Hz	= M8
	10	= 3 x 220 - 230 V, 50 Hz	= M8
	17	= 3 x 440 - 460 V, 50 Hz	= M8
	18	= 3 x 500 - 525 V, 50 Hz	= M8
	19	= 3 x 380 - 400 - 415 V, 50 Hz, 3 x 440 - 460 - 480 V, 60 Hz	= M8
	21	= 1 x 220-230 V CSCR, 50 Hz	= M8
	24	= 1 x 240 V CSCR, 50 Hz	= M8
	25	= 1 x 240 V PSC, 50 Hz	= M8
	28	= 3 x 208 - 220 - 230 V, 60 Hz	= M8
	30	= 3 x 208 - 220 - 230 V, 60 Hz	= UNF
	31	= 3 x 230 V, 60 Hz	= UNF
	32	= 3 x 208 V, 60 Hz	= UNF
	33	= 3 x 380 - 400 - 415 V, 60 Hz	= M8
	35	= 3 x 440 - 460 V, 60 Hz	= UNF
	39	= 3 x 575 V, 60 Hz	= UNF
	45	= 1 x 230 V CSCR, 60 Hz	= UNF
	65	= 3 x 400 V, 50 Hz, 3 x 400 - 415 - 440 V, 60 Hz	= M8
	75	= 1 x 220 - 240 V CSCR, 50 Hz	= M8

Pos.	Description				
11	Motor power				
	kW	hp	Service factor (60 Hz)		Power code
			Global/US	Japan	
	0.37	0.50	1.60	-	02
	0.55	0.75	1.50	-	03
	0.75	1.00	1.40	1.00	04
	1.10	1.50	1.30	1.00	05
	1.50	2.00	1.25	1.00	06
	1.90	2.50	-	1.00	95
	2.20	3.00	1.15	1.00	07
	2.70	3.60	-	1.00	96
	3.00	4.00	1.15	1.00	08
	3.70	5.00	1.15	1.00	09
	4.00	5.50	1.15	1.00	10
	5.50	7.50	1.15	1.00	11
	7.50	10.00	1.15	1.00	12

**Note:** The type key cannot be used for ordering as not all combinations are possible.

## Type key, MS6000C

Example: MS6000CQFT40 3 × 460/60 25 Hp

Example	MS6000C			Q			F			T40	3 × 460/60		25 Hp
Pos.	1	2	3	4	5	6	7	8	9	10	11	12	
<b>Pos.</b>	<b>Description</b>												
1	Motor type												
2	Material type												
	-	=	AISI 304 stainless steel (EN 1.4301)										
	R	=	AISI 904L stainless steel (EN 1.4539)										
3	Rubber												
	-	=	NRB										
	E	=	FKM										
4	Shaft seal												
	-	-	Ceramic/carbon				BXPFF/NBR						
	S	S	SiC/SiC				Q1Q1VFF/FKM						
	Q	Q	SiC/SiC				Q1Q1PFF/NBR						
5	Radial bearings												
	-	=	Ceramic/hard metal										
	W	=	SiC/Tungsten carbide										
6	Motor liquid												
	-	=	SML-3										
	D	=	Demineralized water										
	H	=	Glycol 60 vol % HTF										
7	Flange extension												
	F	=	Without										
	-	=	With										
8	Tempcon												
	-	=	With										
	X	=	Without										
9	Maximum liquid temperature												
	T40	=	104 °F (40 °C)										
	T60	=	140 °F (60 °C)										
10	Voltage												
	3 × 460/60		=	3 × 440-460-480 V, 60 Hz									
	3 × 208-230/60		=	3 × 208-220-230 V, 60 Hz									
	3 × 575/60		=	3 × 575 V, 60 Hz									
11	Method of starting												
	-	=	DOL										
	SD	=	SD										
12	Motor power												
	5 Hp	3.7 kW	6"										
	7.5 Hp	5.5 kW	6"										
	10 Hp	7.5 kW	6"										
	15 Hp	11 kW	6"										
	20 Hp	15 kW	6"										
	25 Hp	18.5 kW	6"										
	30 Hp	22 kW	6"										
	40 Hp	30 kW	6"										

## Type key, MMS motors

Example: MMS 3 × 460/60 75 Hp

Example	MMS	6	000	N	3 × 460/60	75 Hp	
Pos.	1	2	3	4	5	6	7
Pos.	Description						
1	Motor type						
2	Minimum well casing diameter in inches						
3	Generation						
4	Material type						
	-	=	Cast iron EN-JL1040				
	N	=	AISI 316 (EN1.4401) SS				
5	Voltage						
	3 × 460/60		=	3 × 440-460-480 V, 60 Hz			
6	Method of starting						
	-	=	DOL				
	SD	=	SD				
7	Motor power						
	40 Hp	30 kW	8"				
	50 Hp	37 kW	6"				
	50 Hp	37 kW	8"				
	60 Hp	45 kW	6"				
	60 Hp	45 kW	8"				
	75 Hp	55 kW	8"				
	100 Hp	75 kW	8"				
	125 Hp	92 kW	8"				
	150 Hp	110 kW	8"				
	175 Hp	132 kW	10"				
	200 Hp	147 kW	10"				
	250 Hp	190 kW	10"				

## 2. Construction

### Sectional drawing, SP pump 4" spline shaft (SP 5S - 25S)

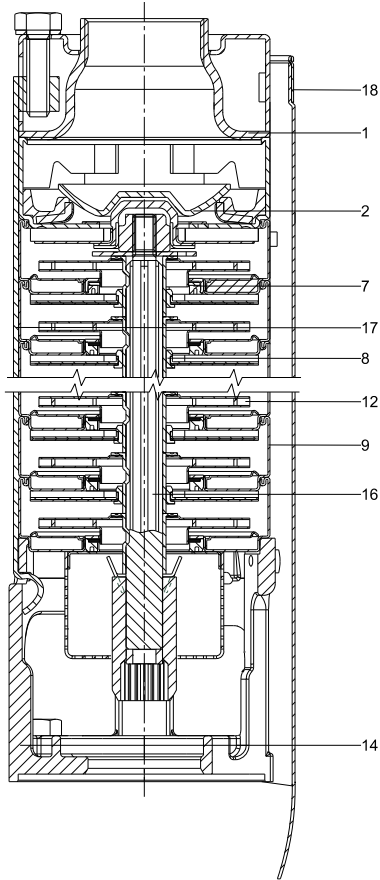

TM061193

SP pump, 4" spline shaft (SP 5S - 25S)

### Material specification

Pos.	Component	Material	Standard	N-version	R-version
			[AISI (EN)]		
1	Valve casing	Stainless steel	304 (1.4308)	316 (1.4408)	904L (1.4517)
2	Valve cup	Stainless steel	304 (1.4301)	316 (1.4401)	904L (1.4539)
7	Neck ring	Elastomer	NBR/TPU	NBR/TPU	NBR/TPU
8	Bearing	Elastomer	NBR	NBR	NBR
9	Chamber	Stainless steel	304 (1.4301)	316 (1.4401)	904L (1.4539)
12	Impeller	Stainless steel	304 (1.4301)	316 (1.4401)	904L (1.4539)
14	Suction interconnector	Cast stainless steel	304 (1.4308)	316 (1.4408)	904L (1.4517)
16	Shaft complete	Stainless steel	431 (1.4057)	329 (1.4460)	904L (1.4462)
17	Strap	Stainless steel	304 (1.4301)	316 (1.4401)	904L (1.4539)
18	Cable guard	Stainless steel	304 (1.4301)	316 (1.4401)	904L (1.4539)
	Washer for stop ring	Carbon/graphite	HY22 in PTFE mass	HY22 in PTFE mass	HY22 in PTFE mass
	Strainer	Stainless steel	304 (1.4301)	316 (1.4401)	904L (1.4539)
	Valve seat	Elastomer	NBR	NBR-FKM	NBR-FKM

### Sectional drawing, SP pump 4" smooth shaft (SP 35S - 77S)

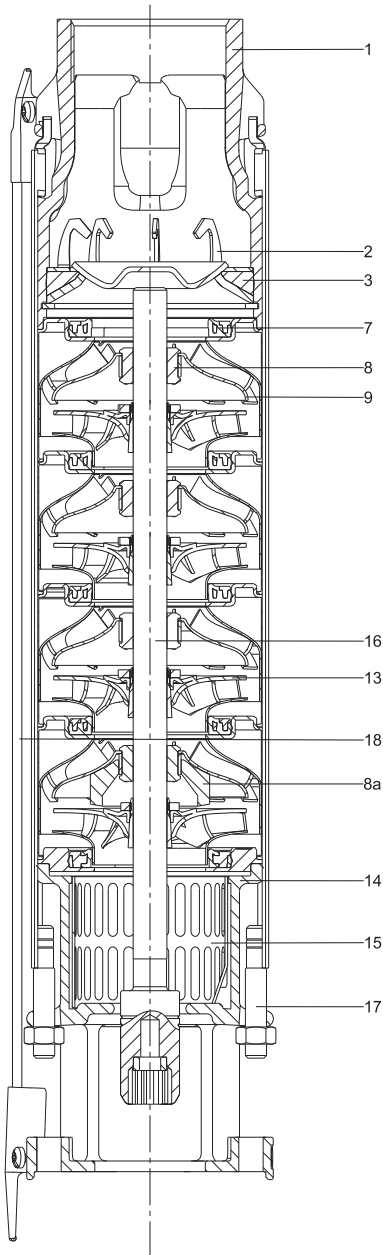

### Material specification

Pos.	Component	Material	Standard	N-version	R-version
			[AISI (EN)]		
1	Valve casing	Cast stainless steel	304 (1.4308)	316 (1.4408)	904L (1.4517)
2	Valve cup	Cast stainless steel	304 (1.4301)	316 (1.4401)	904L (1.4539)
3	Valve seat	NBR-FKM	NBR-FKM	NBR-FKM	NBR-FKM
7	Neck ring	TPU/PPS-FKM	TPU/ PPS-FKM	TPU/ PPS-FKM	TPU/ PPS-FKM
8	Bearing	LSR-FKM	LSR/FKM	LSR/FKM	LSR/FKM
8a	Washer for stop ring	Carbon/graphite	HY22 in PTFE mass	HY22 in PTFE mass	HY22 in PTFE mass
9	Chamber	Stainless steel	304 (1.4301)	316 (1.4401)	904L (1.4539)
13	Impeller	Stainless steel	304 (1.4301)	316 (1.4401)	904L (1.4539)
14	Suction interconnector	Cast stainless steel	304 (1.4308)	316 (1.4408)	904L (1.4517)
15	Strainer	Stainless steel	304 (1.4301)	316 (1.4401)	904L (1.4539)
16	Shaft complete	Stainless steel	1.4057	1.4460	1.4462
17	Strap	Stainless steel	304 (1.4301)	316 (1.4401)	904L (1.4539)
18	Cable guard	Stainless steel	304 (1.4301)	316 (1.4401)	904L (1.4539)

SP pump, 4" smooth shaft (SP 35S - 77S)

TM061110



**Sectional drawing, SP pump 6" (SP 90S - 300S)**

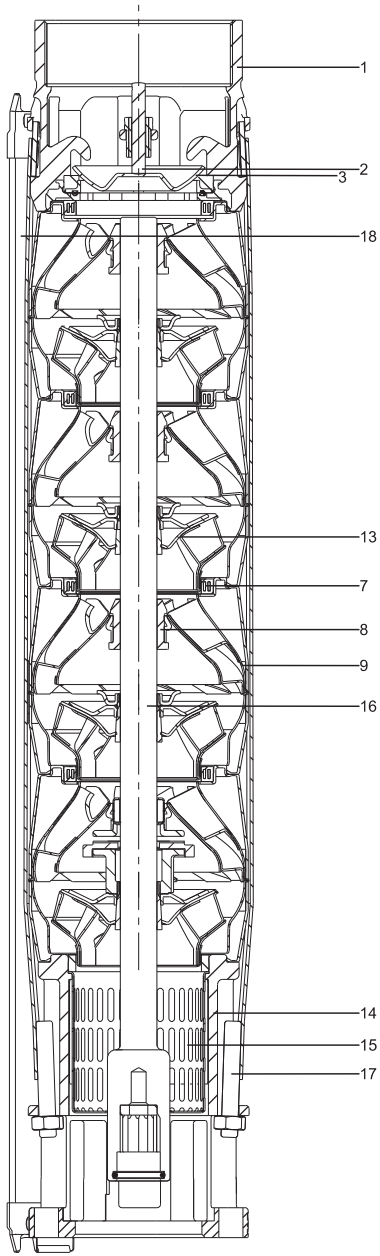

TM069924

*Example, SP pump, 6" (SP 90S - 300S)*

**Material specification**

Pos.	Component	Material	Standard	N-version	R-version
			[AISI (EN)]		
1	Valve casing	Stainless steel	304 (1.4308)	316 (1.4408)	904L (1.4517)
2	Valve cup	Stainless steel	304 (1.4301)	316 (1.4401)	904L (1.4539)
3	Valve seat	Elastomer	NBR-FKM	NBR-FKM	NBR-FKM
7	Neck ring	Elastomer	NBR-FKM	NBR-FKM	NBR-FKM
8	Bearing	NBR-FKM-LSR	NBR-FKM-LSR	NBR-FKM-LSR	NBR-FKM-LSR
9	Chamber	Stainless steel	304 (1.4301)	316 (1.4401)	904L (1.4539)
13	Impeller	Stainless steel	304 (1.4301)	316 (1.4401)	904L (1.4539)
14	Suction interconnector	Cast stainless steel	304 (1.4308)	316 (1.4408)	904L (1.4517)
15	Strainer	Stainless steel	304 (1.4301)	316 (1.4401)	904L (1.4539)
16	Shaft complete	Stainless steel	431 (1.4057)	329 (1.4460)	904L (1.4462)
17	Strap	Stainless steel	304 (1.4301)	316 (1.4401)	904L (1.4539)
18	Cable guard	Stainless steel	304 (1.4301)	316 (1.4401)	904L (1.4539)

## Sectional drawing, SP pump 8" (SP 385S - 475S)

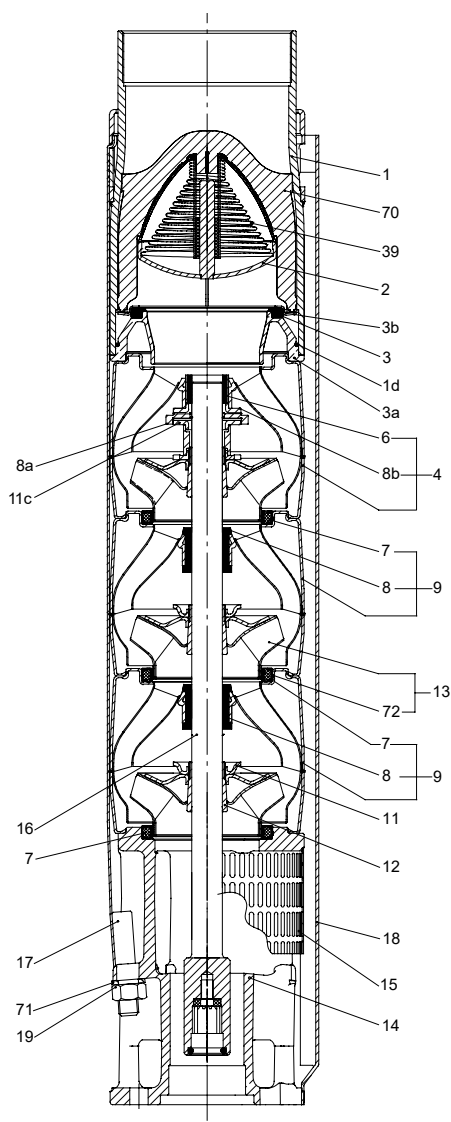

SP pump, 8" (SP 385S - 475S)

TM012359

## Material specification

Pos.	Component	Material	Standard	N	R
			[AISI (EN)]		
			304 (1.4301)	316 (1.4401)	904L (1.4539)
1	Valve casing	Stainless steel	304 (1.4301)	316 (1.4401)	904L (1.4539)
1d	O-ring	Elastomer	NBR	NBR	NBR
2	Valve cup	Stainless steel	304 (1.4301)	316 (1.4401)	904L (1.4539)
3	Valve seat	Elastomer	NBR	NBR	FKM
3a	Lower valve seat retainer	Stainless steel	316 (1.4401)	316 (1.4401)	904L (1.4517)
3b	Upper valve seat retainer	Stainless steel	304 (1.4301)	316 (1.4401)	904L (1.4539)
4	Top chamber	Stainless steel	304 (1.4301)	316 (1.4401)	904L (1.4539)
6	Upper bearing	Stainless steel/NBR	304 (1.4301)	316 (1.4401)	904L (1.4539)
7	Neck ring	Elastomer (optional FKM)	NBR/PPS	NBR/PPS	NBR/PPS
8	Bearing	Elastomer (optional FKM)	NBR	NBR	NBR
8a	Washer for stop ring	Carbon	graphite HY22 in PTFE mass	graphite HY22 in PTFE mass	graphite HY22 in PTFE mass
8b	Stop ring	Stainless steel	316 (1.4401)	316 (1.4401)	904L (1.4539)
9	Chamber	Stainless steel	304 (1.4301)	316 (1.4401)	904L (1.4539)
11	Split cone nut	Stainless steel	304 (1.4301)	316 (1.4401)	904L (1.4539)
11c	Nut for stop ring	Stainless steel	316 (1.4401)	316 (1.4401)	904L (1.4539)
12	Split cone	Stainless steel	304 (1.4301)	316 (1.4401)	904L (1.4539)
13	Impeller	Stainless steel	304 (1.4301)	316 (1.4401)	904L (1.4539)
14	Suction interconnector	Stainless steel	304 (1.4308)	316 (1.4408)	904L (1.4517)
15	Strainer	Stainless steel	304 (1.4301)	316 (1.4401)	904L (1.4539)
16	Shaft complete	Stainless steel	431 (1.4057)	329 (1.4460)	329 (1.4460)
17	Strap	Stainless steel	304 (1.4301)	316 (1.4401)	904L (1.4539)
18	Cable guard	Stainless steel	304 (1.4301)	316 (1.4401)	904L (1.4539)
19	Nut for strap	Stainless steel	304 (1.4301)	316 (1.4401)	904L (1.4539)
39	Spring for valve cup	Stainless steel	304 (1.4301)	316 (1.4401)	SAF 2205
70	Valve guide	Stainless steel	304 (1.4301)	316 (1.4401)	904L (1.4539)
71	Washer	Stainless steel	316 (1.4401)	316 (1.4401)	904L (1.4539)
72	Wear ring	Stainless steel	304 (1.4301)	316 (1.4401)	904L (1.4539)

**Sectional drawing, SP pump 10" (SP 625S - 1100S)**

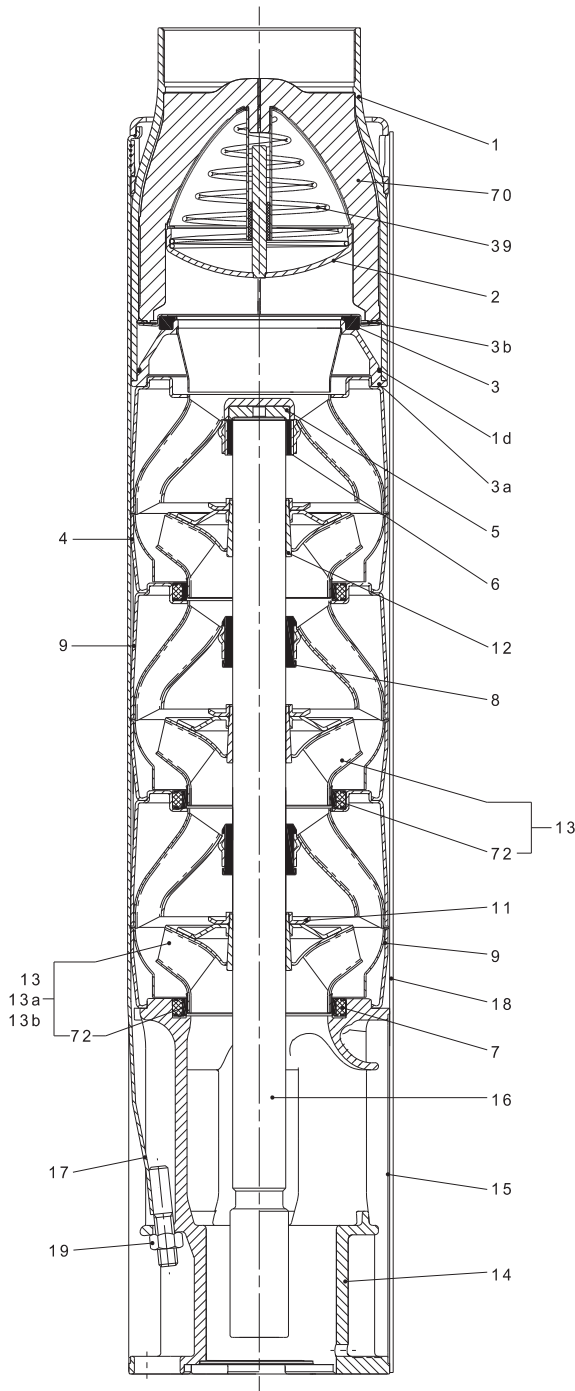

TM012363

SP pump, 10" (SP 625S - 1100S)

**Material specification**

Pos.	Component	Material	Standard	
			[AISI (EN)]	N version
Valve casing				
1	Valve casing	Stainless steel	304 (1.4301)	316 (1.4401)
1d	O-ring	Elastomer	NBR	NBR
2	Valve cup	Stainless steel	304 (1.4301)	316 (1.4401)
3	Valve seat	Stainless steel	304 (1.4301)	316 (1.4401)
3a	Lower valve seat retainer	Stainless steel	304 (1.4301)	316 (1.4401)
3b	Upper valve seat retainer	Stainless steel	304 (1.4301)	316 (1.4401)
39	Spring for valve cup	Stainless steel	301 (1.4310)	316 (1.4401)
70	Valve guide	Stainless steel	304 (1.4301)	316 (1.4401)
78	Nameplate	Stainless steel	304 (1.4301)	316 (1.4401)
79	Rivet	Stainless steel	304 (1.4301)	316 (1.4401)
63	Connecting piece	Stainless steel	304 (1.4301)	316 (1.4401)
Chamber stack				
4	Top chamber	Stainless steel	304 (1.4301)	316 (1.4401)
5	Uphrust disc	Carbon/graphite HY22 in PTFE mass		
6	Top bearing	Stainless steel/ NBR	304 (1.4301)	316 (1.4401)
7	Neck ring	Elastomer	NBR/PPS	NBR/PPS
8	Bearing	Elastomer	NBR	NBR
9	Chamber	Stainless steel	304 (1.4301)	316 (1.4401)
11	Nut for split cone	Stainless steel	304 (1.4301)	316 (1.4401)
12	Split cone	Stainless steel	304 (1.4301)	316 (1.4401)
13	Impeller	Stainless steel	304 (1.4301)	316 (1.4401)
16	Shaft with coupling	Stainless steel	431 (1.4057)	329 (1.4460)
18	Cable guard	Stainless steel	304 (1.4301)	316 (1.4401)
18a, 18b	Screw for cable guard	Stainless steel	304 (1.4301)	316 (1.4401)
23	Rubber guard	Elastomer	NBR	NBR
72	Wear ring	Stainless steel	304 (1.4301)	316 (1.4401)
Suction interconnector				
14	Suction interconnector	Stainless steel	304 (1.4308)	316 (1.4408)
15	Strainer	Stainless steel	304 (1.4301)	316 (1.4401)
17	Strap	Stainless steel	304 (1.4301)	316 (1.4401)
19	Nut for strap	Stainless steel	304 (1.4301)	316 (1.4401)
19a	Nut	Stainless steel	316 (1.4401)	316 (1.4401)
22	Bolts	Stainless steel	316 (1.4401)	316 (1.4401)
28, 28a	Lock for strainer	Stainless steel	329 (1.4460)	329 (1.4460)

## Sectional drawing, MS motors

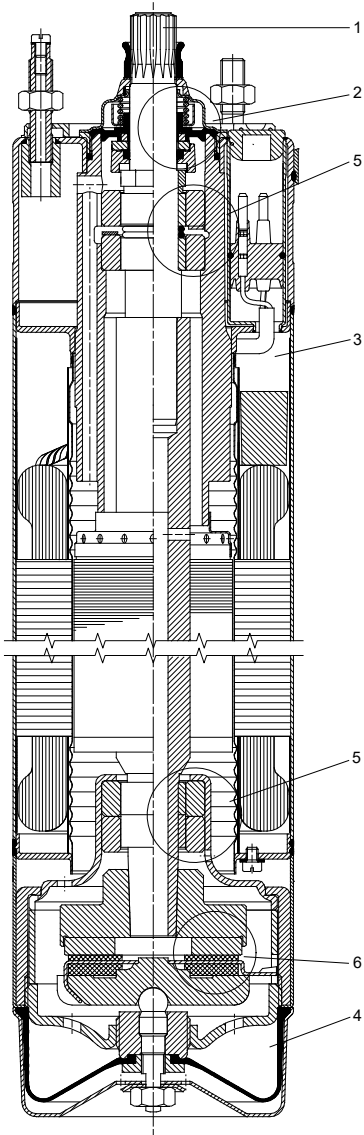

MS4000C motor

TM0078651

## Material specification, MS402, MS4000C, and MS6000C motors

Pos.	Component	MS402	MS4000C MS6000C
		[AISI (EN)]	
1	Shaft	431	431
2	Shaft seal	NBR	NBR/SiC/SiC
3	Motor sleeve	304 (1.4301)	304 (1.4301)
4	Motor end shield	304 (1.4301)	304 (1.4301)
5	Radial bearing	Ceramic	Ceramic/tungsten carbide
6	Axial bearing	Ceramic/carbon	Ceramic/carbon
	Rubber parts	NBR	NBR

## R-version motor

Pos.	Component	MS4000C MS6000C
1	Shaft	318 LN
2	Shaft seal	SiC/SiC
3	Motor sleeve	904L (1.4539)
4	Motor end shield	904L (1.4539)
5	Radial bearing	Ceramic/tungsten carbide
6	Thrust bearing	Ceramic/carbon
	Rubber parts	NBR

## Sectional drawing, MMS motors

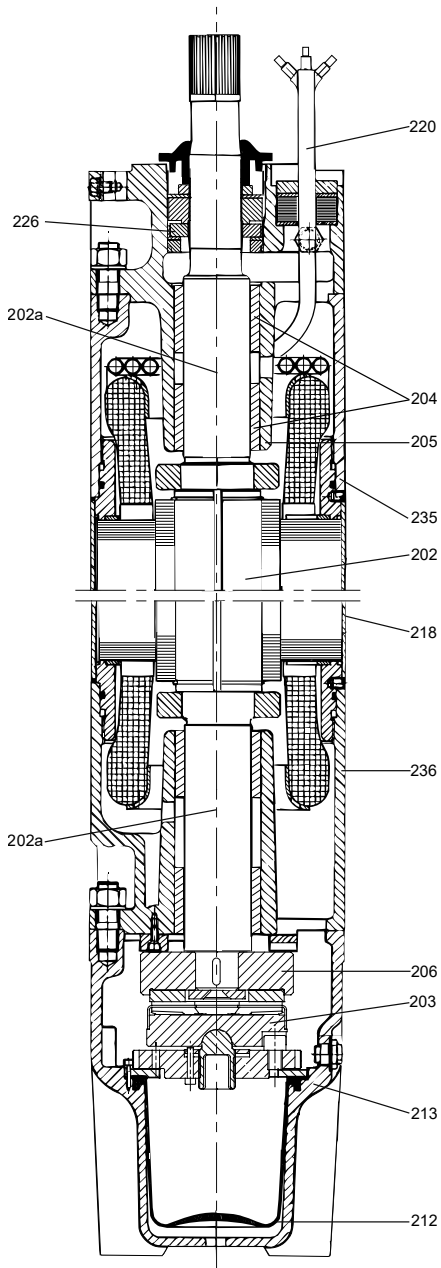

MMS 10000 motor

TM014985

## Material specification

### MMS motors, submersible rewindable versions

Pos.	Component	Material	[AISI (EN)]
202	Shaft	Steel	(1.0533)
202a	Shaft ends	Stainless steel	316/329 (1.4401/1.4460)
203/ 206	Thrust bearing Stationary/ rotating part	6", 0.5 - 20 Hp	Hardened steel/ EPDM
		8" - 10"	
204	Bearing bush	6" - 10"	Carbon
205	Bearing housing, upper		Cast iron
212	Diaphragm		CR
213	Motor end shield		Cast iron
218	Motor sleeve		Stainless steel
220	Motor cable		EPR
226	Shaft seal		SiC/SiC
235	Intermediate housing		Cast iron
236	Bearing housing, lower		Cast iron

### MMS motors, N and R versions

Pos.	Component	Material	Version	
			N	R
[AISI (EN)]				
202	Shaft	Steel	(1.0533)	
202a	Shaft ends	Stainless steel	316/329 (1.4401/1.4460)	318LN (1.4462)
203/ 206	Thrust bearing Stationary/ rotating part	6", 0.5 - 20 Hp	Hardened steel/EPDM	
			6", 25-50 Hp	Ceramic/ carbon
		8" - 10"		
204	Bearing bush	6" - 10"	Carbon	
205	Bearing housing, upper	Stainless steel	316 (1.4401)	904L (1.4539)
212	Diaphragm		CR	
213	Motor end shield	Stainless steel	316 (1.4401)	904L (1.4539)
218	Motor sleeve	Stainless steel	316 (1.4401)	904L (1.4539)
220	Motor cable		EPR	
226	Shaft seal		SiC/SiC	
235	Intermediate housing	Stainless steel	316 (1.4401)	904L (1.4539)
236	Bearing housing, lower	Stainless steel	316 (1.4401)	904L (1.4539)

## 3. Operating conditions

### Operating conditions

Flow rate, Q: 0.44 - 1475 gpm (0.1 - 335 m<sup>3</sup>/h).

Head, H: Maximum 2657 ft (810 m).

### Maximum liquid temperature

Motor type	Motor cooling requirements <sup>4)</sup>				
	Min. well casing or sleeve diameter	Minimum velocity	Minimum flow	Maximum temperature of pumped liquid	
				Vertical installation	Horizontal installation
in. (mm)	fps (m/s)	gpm (m <sup>3</sup> /h)	°F (°C)	°F (°C)	
MS402, MS4000C	4 (102)	If at 0.0	If at 0.0	86 (30)	Flow sleeve recommended
MS402, MS4000C	4 (102)	0.25 (0.08)	1.2 (0.27)	104 (40)	104 (40)
MS6000C (T40) (Standard)	6 (152)	0.50 (0.15)	9 (2)	104 (40)	104 (40)
MS6000C (T60) (High temperature)	6 (152)	3.3 (1.0)	30 (6.8)	140 (60)	140 (60)
MMS6	6 (152)	0.15 (0.05)	13 (3)	86 (30)	86 (30)
MMS8000	8 (203)	0.50 (0.15)	25 (5.7)	86 (30)	86 (30)
MMS10000 (175, 200 HP)	10 (254)	0.50 (0.15)	55 (12.5)	86 (30)	86 (30)
MMS10000 (250 HP)	10 (254)	0.50 (0.15)	41 (9.3)	86 (30)	86 (30)

<sup>4)</sup> Maximum liquid temperature / minimum velocity / flow past the motor

**Note:** For MMS6, 50 Hp; MMS8000, 150 Hp; the maximum liquid temperature is 9 °F (5 °C) lower than the values stated in the table.

For MMS10000, 250 Hp, the temperature is 18 °F (10 °C) lower.

### Operating pressure

Motor	Maximum operating pressure
MS402, 4"	217 psi (1.5 Mpa) (15 bar)
MS4000C, 4"	
MS6000C, 6"	870 psi (6 Mpa) (60 bar)
MMS 6" to 10" rewindable	

# 4. Selection

## 5S - 25S easy selection charts

### 5 gpm easy selection chart

Flow range 1.2 to 7 gpm

Pump outlet 1" NPT

Ratings in gallons per minute (gpm)

Pump model	Hp	psi	Depth to pumping water level (lift) in ft																											
			20	40	60	80	100	120	140	160	180	200	220	240	260	280	300	340	400	460	520	600	700	800	900	1000	1100			
5S03-9	0.33	0				7.1	6.7	6.2	5.8	5.3	4.8	4.3	3.2	2.1																
		20		7.0	6.6	6.1	5.7	5.2	4.6	4.0	2.8	1.6																		
		30		6.5	6.0	5.6	5.1	4.6	3.8	2.9	1.5																			
		40	6.7	6.0	5.5	5.1	4.4	3.8	2.4																					
		50	6.2	5.5	4.9	4.4	3.4	2.5	1.3																					
		60	4.6	4.9	4.2	3.5	1.9																							
Shut-off psi			102	94	85	76	68	59	50	42	33	24	16	7																
5S05-13	0.5	0					7.1	6.8	6.4	6.1	5.8	5.5	5.2	4.8	4.5	3.9	2.3													
		20			7.3	7.0	6.7	6.3	6.0	5.7	5.4	5.1	4.7	4.3	3.7	3.1	2.0													
		30			7.2	6.9	6.6	6.3	6.0	5.7	5.4	5.0	4.7	4.2	3.7	2.8	2.0													
		40	7.2	6.9	6.6	6.3	5.9	5.6	5.3	5.0	4.6	4.2	3.5	2.8	1.6															
		50	6.8	6.5	6.2	5.9	5.6	5.3	4.9	4.6	4.0	3.5	2.6	1.6																
		60	6.5	6.2	5.8	5.5	5.2	4.9	4.5	4.0	3.3	2.6	1.3																	
Shut-off psi			152	143	134	126	117	108	100	91	82	74	65	56	48	39	30	13												
5S07-18	0.75	0							7.1	6.9	6.7	6.4	6.2	6.0	5.8	5.6	5.1	4.2	2.7											
		20						7.1	6.8	6.6	6.4	6.2	5.9	5.7	5.5	5.3	5.0	4.5	3.2											
		30					7.0	6.8	6.6	6.3	6.1	5.9	5.7	5.5	5.2	5.0	4.7	4.0	2.5											
		40			7.2	7.0	6.8	6.5	6.3	6.1	5.9	5.6	5.4	5.2	4.9	4.7	4.4	3.5	1.5											
		50		7.2	7.0	6.7	6.5	6.3	6.1	5.8	5.6	5.4	5.1	4.9	4.6	4.3	3.9	2.9												
		60	7.1	6.9	6.7	6.5	6.2	6.0	5.8	5.6	5.3	5.1	4.9	4.6	4.3	3.9	3.4	2.1												
Shut-off psi			213	204	195	187	178	169	161	152	143	135	126	117	109	100	91	74	48	22										
5S10-22	1.0	0									7.1	6.9	6.7	6.6	6.4	6.2	5.8	5.3	4.7	3.8	1.7									
		20								7.1	6.9	6.7	6.5	6.3	6.1	6.0	5.8	5.4	4.8	4.0	2.8									
		30						7.0	6.8	6.7	6.5	6.3	6.1	5.9	5.7	5.6	5.2	4.6	3.6	2.1										
		40					7.0	6.8	6.6	6.5	6.3	6.1	5.9	5.7	5.5	5.4	5.0	4.3	3.1	1.3										
		50			7.2	7.0	6.8	6.6	6.4	6.2	6.1	5.9	5.7	5.5	5.3	5.1	4.7	3.9	2.5											
		60		7.1	6.9	6.8	6.6	6.4	6.2	6.0	6.0	5.7	5.5	5.3	5.1	4.9	4.4	3.5	1.7											
Shut-off psi			245	237	228	219	211	202	194	185	176	168	159	150	142	124	98	72	46	12										
5S15-26	1.5	0										7.1	7.0	6.8	6.7	6.4	5.9	5.4	4.9	4.1	2.1									
		20										7.1	6.9	6.8	6.6	6.5	6.3	6.0	5.5	5.1	4.5	3.4								
		30									7.1	6.9	6.7	6.6	6.4	6.3	6.1	5.8	5.4	4.8	4.2	2.9								
		40								7.0	6.9	6.7	6.6	6.4	6.3	6.1	6.0	5.6	5.2	4.6	5.6	2.4								
		50							7.0	6.9	6.7	6.5	6.4	6.2	6.1	5.9	5.8	5.5	5.0	4.4	3.6	1.7								
		60						7.0	6.8	6.7	6.5	6.4	6.2	6.1	5.9	5.8	5.6	5.3	4.8	4.1	3.1									
Shut-off psi							269	260	252	243	234	226	217	208	200	191	174	148	122	96	61	18								

Pump model	Hp	psi	Depth to pumping water level (lift) in ft																							
			20	40	60	80	100	120	140	160	180	200	220	240	260	280	300	340	400	460	520	600	700	800	900	1000
5S15-31	1.5	0														7.1	7.0	6.7	6.3	5.9	5.5	6.7	4.1	2.6		
		20												7.1	6.9	6.8	6.7	6.4	6.0	5.6	5.2	4.6	3.5	1.6		
		30										7.0	6.9	6.8	6.6	6.5	6.2	5.9	5.5	5.1	4.4	3.2	0.9			
		40									7.0	6.9	6.8	6.6	6.5	6.4	6.1	5.7	5.3	4.9	4.2	2.8				
		50									7.1	7.0	6.9	6.7	6.6	6.5	6.3	6.2	6.0	5.6	5.2	4.7	4.0	2.3		
		60									7.1	7.0	6.8	6.7	6.6	6.5	6.3	6.2	6.1	5.8	5.4	5.0	4.5	3.7	1.7	
<b>Shut-off psi</b>											320	311	303	294	285	277	268	259	251	233	207	181	155	121	77	34

These values are approximate. For more precise values and for higher head models, see section SP 5S (5 gpm) performance curves.

Specifications are subject to change without notice.

#### Related information

[SP 5S \(5 gpm\)](#)



### 7 gpm easy selection chart

Flow range 3 to 10 gpm

Pump outlet 1" NPT

Ratings in gallons per minute (gpm)

Pump model	Hp	psi	Depth to pumping water level (lift) in ft																										
			20	40	60	80	100	120	140	160	180	200	220	240	260	280	300	340	400	460	520	600	700	800	900	1000	1100		
7S03-8	0.33	20	10.0	9.5	8.7	8.0	7.2	6.4	5.0	3.7	1.8																		
		30	9.3	8.7	7.9	7.1	6.1	5.1	2.6																				
		40	8.5	7.8	7.0	6.1	4.5	2.9	1.5																				
		50	7.6	6.9	5.8	4.7	2.3																						
		60	6.7	5.8	3.9	2.0																							
Shut-off psi			86	77	69	60	52	43	34	26	17	8																	
7S05-11	0.5	0					9.9	9.5	8.9	8.4	7.8	7.3	6.7	6.0	5.0	4.0													
		20			9.8	9.3	8.8	8.2	7.7	7.1	6.5	5.8	4.7	3.5	1.8														
		30	10.1	9.7	9.2	8.7	8.1	7.6	7.0	6.4	5.6	4.7	2.9																
		40	9.6	9.2	8.6	8.1	7.5	6.9	6.2	5.6	4.3	3.0	1.5																
		50	9.1	8.5	8.0	7.4	6.8	6.2	5.3	4.3	2.2																		
Shut-off psi			122	113	105	96	87	79	70	61	53	44	35	27	18	10													
7S07-15	0.75	0					10.2	9.9	9.5	9.2	8.8	8.4	8.0	7.6	7.1	6.7	5.6	2.9											
		20			10.1	9.8	9.4	9.0	8.6	8.2	7.8	7.4	7.0	6.5	6.1	5.4	3.6												
		30		10.0	9.7	9.4	9.0	8.6	8.2	7.8	7.4	6.9	6.5	5.9	5.4	4.5	1.8												
		40	10.0	9.7	9.3	8.9	8.5	8.1	7.7	7.3	6.9	6.4	5.9	5.2	4.5	3.2	1.0												
		50	9.9	9.6	9.2	8.9	8.5	8.1	7.6	7.2	6.8	6.4	5.8	5.2	4.2	3.2	1.6												
Shut-off psi			170	101	153	144	135	127	118	110	101	92	84	75	66	58	49	32	6										
7S10-19	1.0	0						10.1	9.8	9.6	9.3	9.0	8.7	8.4	8.0	7.4	6.4	4.8											
		20					10.0	9.8	9.5	9.2	8.9	8.6	8.3	7.9	7.6	7.3	6.6	5.3	2.8										
		30					10.0	9.7	9.5	9.2	8.9	8.5	8.2	7.9	7.6	7.3	6.9	6.2	4.6	1.4									
		40			10.0	9.7	9.4	9.1	8.8	8.5	8.2	7.8	7.5	7.2	6.9	6.5	5.6	3.7											
		50	10.2	9.9	9.7	9.4	9.1	8.8	8.4	8.1	7.8	7.4	7.1	6.8	6.4	6.0	5.0	2.4											
Shut-off psi			218	209	200	192	183	174	166	157	148	140	131	123	114	105	97	79	53	27									
7S15-26	1.5	0										10.1	9.9	9.7	9.5	9.3	8.8	8.1	7.4	6.7	5.5								
		20									10.0	9.8	9.6	9.4	9.2	9.0	8.8	8.3	7.6	6.9	6.1	4.4							
		30									10.0	9.8	9.6	9.4	9.2	9.0	8.7	8.5	8.0	7.3	6.6	5.7	3.7						
		40					10.1	10.0	9.8	9.6	9.4	9.1	8.9	8.7	8.5	8.2	7.8	7.1	6.3	5.2	2.9								
		50			10.1	9.9	9.7	9.6	9.3	9.1	8.9	8.7	8.4	8.2	8.0	7.5	6.8	5.9	4.7	1.9									
Shut-off psi					274	265	257	248	239	231	222	213	205	196	187	179	161	135	110	84	49								
7S20-32	2.0	0										10.6	10.5	10.4	10.4	10.3	10.1	9.6	9.1	8.4	7.3	5.7							
		20									10.5	10.5	10.4	10.3	10.3	10.2	10.0	9.8	9.2	8.6	7.8	6.6	4.8						
		30									10.5	10.5	10.4	10.3	10.2	10.1	10.0	9.9	9.6	9.0	8.3	7.5	6.2	4.3					
		40						10.5	10.5	10.4	10.3	10.2	10.1	10.0	9.9	9.7	9.4	8.8	8.0	7.2	5.8	3.9							
		50						10.5	10.4	10.3	10.2	10.1	10.0	9.8	9.7	9.5	9.1	8.5	7.7	6.8	5.4	3.3							
Shut-off psi							343	334	326	317	308	300	291	282	274	265	256	239	213	187	161	126	83						

These values are approximate. For more precise values and for higher head models, see section SP 7S (7 gpm) performance curves.

Specifications are subject to change without notice.

#### Related information

[SP 7S \(7 gpm\)](#)



These values are approximate. For more precise values and for higher head models, see section SP 10S (10 gpm) performance curves.

Specifications are subject to change without notice.

**Related information**

[SP 10S \(10 gpm\)](#)

## 16 gpm easy selection chart

Flow range 10 to 20 gpm

Pump outlet 1.25" NPT

Ratings in gallons per minute (gpm)

Pump model	Hp	psi	Depth to pumping water level (lift) in ft																											
			20	40	60	80	100	120	140	160	180	200	220	240	260	280	300	340	400	460	520	600	700	800	900	1000	1100			
16205-5	.5	20	20.3	18.2	14.1	10.0	5.0																							
		30	17.3	14.4	8.0	1.6																								
		40	12.7	8.0	4.0																									
		50	6.5																											
		60	2.9																											
Shut-off psi			58	49	40	32	23	14																						
16S07-8	.75	0				20.5	19.2	17.5	15.8	12.8	9.8	5.2																		
		20			20.1	18.8	16.9	15.2	11.8	8.5	4.3																			
		30	21.2	19.9	18.4	16.9	14.3	11.8	7.5	3.2	1.6																			
		40	19.7	18.3	16.3	14.3	10.8	7.2	3.6																					
		50	17.9	16.3	13.5	10.7	6.2	1.7																						
Shut-off psi			97	88	80	71	62	54	45	36	28	19	10																	
16S10-10	1.0	0				20.8	19.8	18.8	17.3	15.9	13.7	11.4	8.0	4.7																
		20			20.5	19.4	18.3	16.8	15.3	12.9	10.5	7.0	3.5	1.8																
		30		20.3	19.3	18.1	16.8	14.8	12.8	9.8	6.7	3.3																		
		40	20.2	19.1	18.0	16.4	14.8	12.2	9.6	5.9	2.3																			
		50	20.0	19.0	17.7	16.3	14.2	12.0	8.8	5.6	2.8																			
Shut-off psi			123	115	106	97	89	80	71	63	54	45	37	28	19	11														
16S15-14	1.5	0						21.0	20.3	19.6	18.8	18.0	16.9	15.8	14.3	10.7	3.3													
		20						20.1	19.3	18.5	17.7	16.6	15.4	13.8	12.2	10.0	5.1													
		30				20.7	20.0	19.2	18.4	17.4	16.5	15.1	13.7	11.8	9.8	7.3	2.4													
		40			20.6	19.8	19.1	18.3	17.4	16.0	15.0	13.3	11.6	9.3	7.0	4.3														
		50		20.4	19.8	18.9	18.2	17.2	16.1	14.7	13.2	11.2	9.1	6.5	3.9	2.0														
Shut-off psi			167	158	149	141	132	123	115	106	97	89	80	71	63	54	37	28												
16S20-18	2.0	0								21.2	20.6	20.0	19.5	18.9	18.2	16.7	13.5	8.8	2.7											
		20								20.4	19.8	19.3	18.7	18.0	17.3	16.4	14.3	10.0	4.2											
		30								20.3	19.8	19.2	18.6	17.9	17.2	16.3	15.3	12.8	7.9	1.9										
		40								20.3	19.7	19.1	18.5	17.8	17.1	16.1	15.2	13.9	11.1	5.7										
		50					20.2	19.6	19.0	18.3	17.7	16.8	16.0	14.9	13.8	12.3	9.2	3.2												
Shut-off psi						194	186	177	168	160	151	142	134	125	116	108	90	65	39	13										
16S30-24	3.0	0														19.6	18.3	16.5	14.2	9.8	2.1									
		20														20.3	19.9	19.5	18.6	17.0	14.8	11.8	6.5							
		30														20.3	19.8	19.4	19.0	18.0	16.3	13.7	10.4	4.7						
		40														20.2	19.8	19.3	18.9	18.4	17.3	15.3	12.5	8.9	2.8					
		50														20.2	19.8	19.3	18.8	18.3	17.8	16.7	14.3	11.3	7.3					
Shut-off psi										239	230	221	213	204	195	187	169	143	117	91	57	13								
16S50-38	5.0	0																		21.5	20.4	18.7	16.5	13.4	8.9	2.1				
		20																		20.9	19.6	17.7	15.2	11.5	6.1					
		30																		21.4	20.5	19.2	17.2	14.5	10.5	4.5				
		40																		21.1	20.2	18.8	16.7	13.7	9.3	2.7				
		50																		21.6	20.7	19.8	18.4	16.1	12.8	8.0	0.8			
Shut-off psi																				314	288	262	227	184	141	98	54	11		

These values are approximate. For more precise values and for higher head models, see section SP 16S (16 gpm) performance curves.

Specifications are subject to change without notice.

**Related information**

[SP 16S \(16 gpm\)](#)



These values are approximate. For more precise values and for higher head models, see section SP 25S (25 gpm) performance curves.

Specifications are subject to change without notice.

**Related information**

[SP 25S \(25 gpm\)](#)

## 5. Performance curves and technical data

### How to read the curve charts

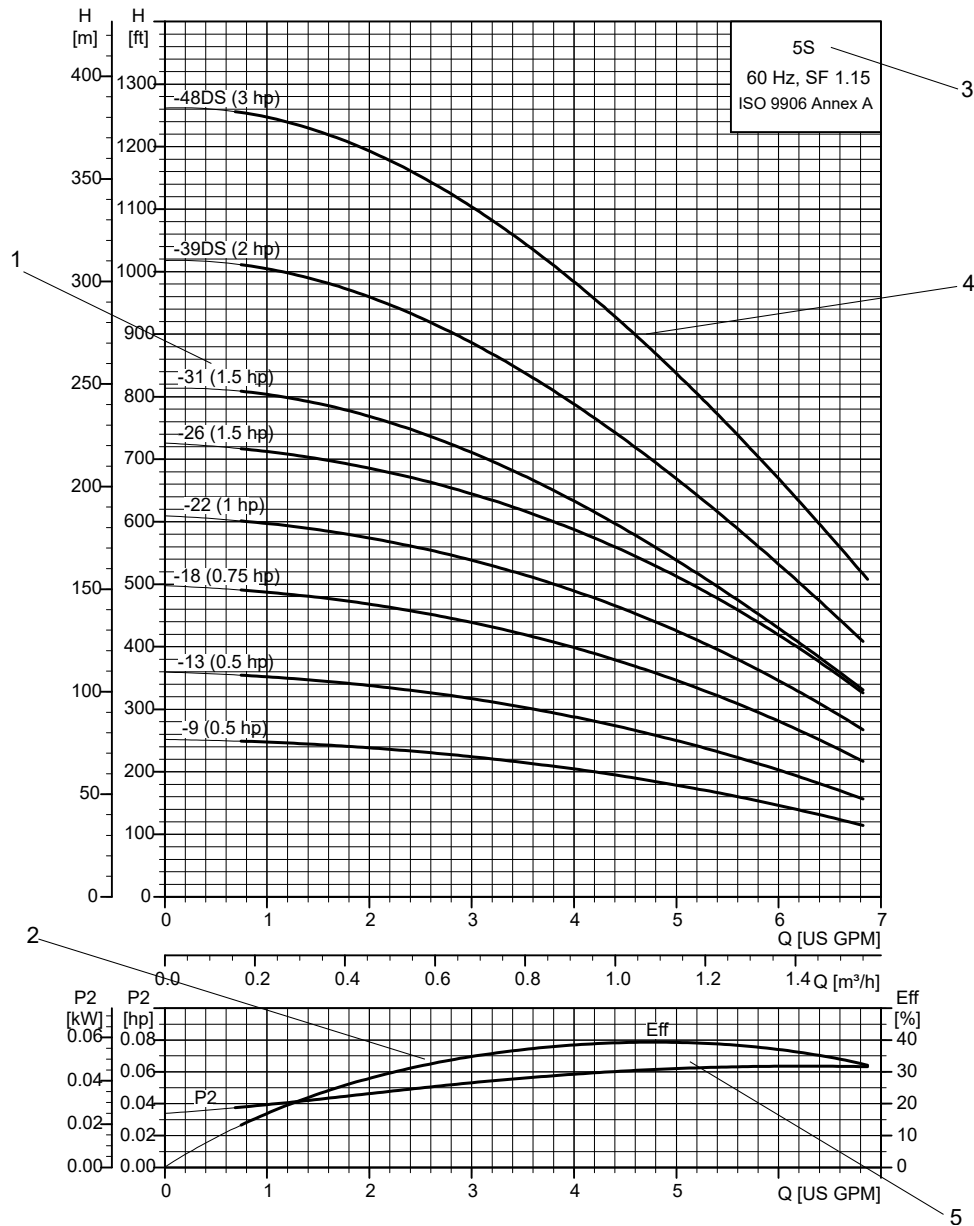

TM080018

Pos.	Description
1	Number of stages. First figure: number of stages; second figure: impeller trim(s).
2	The efficiency curve (Eff) shows the efficiency of the pump. The efficiency curve is an average curve of all the pump types shown in the chart. The efficiency of pumps with reduced-diameter impellers is approximately 2 % lower than the efficiency curve shown in the chart.
3	Pump type, frequency, and service factor.
4	QH curve for the individual pump. The <b>bold</b> curves indicate the <b>recommended</b> performance range for best efficiency.
5	The power curves (P2) indicate pump input power <b>per stage</b> . Curves are shown for complete (1/1) and for reduced-diameter (2/3) impellers.



## Curve conditions

The conditions below apply to the curves shown in section Curve charts and technical data below.

### General

- Curve tolerances according to ISO 9906, Annex A.
- The performance curves show pump performance at actual speed, cf. standard motor range. The motor speeds are listed in the data tables in section Curve charts and technical data below.
- The measurements were made with airless water at a temperature of 68 °F (20 °C). The curves apply to a kinematic viscosity of 1 mm<sup>2</sup>/s (1 cSt). When pumping liquids with a density higher than that of water, use motors with correspondingly higher outputs.
- The **bold** curves indicate the recommended performance range.
- The performance curves are inclusive of possible losses such as check valve loss.
- **Pump rpm:** The curves include the actual motor rpm. The actual motor rpm is listed in the data charts in section Curve charts and technical data below.
- **Q/H:** The curves are inclusive of valve and inlet losses at the actual speed. Operation without check valve increases the actual head at rated performance by 1.6 to 3.3 ft (0.5 to 1.0 m).
- **NPSH:** The curve is inclusive of pressure loss in the suction interconnector and shows required inlet pressure.
- **Power curve:** P<sub>2</sub> shows pump power input [Hp] at the actual speed of each individual pump size.
- **Efficiency curve:** Eta shows pump stage efficiency. If Eta for the actual pump size is needed, consult the Grundfos Product Center.

## 6. Curve charts and technical data

### 4" and larger wells

#### SP 5S (5 gpm)

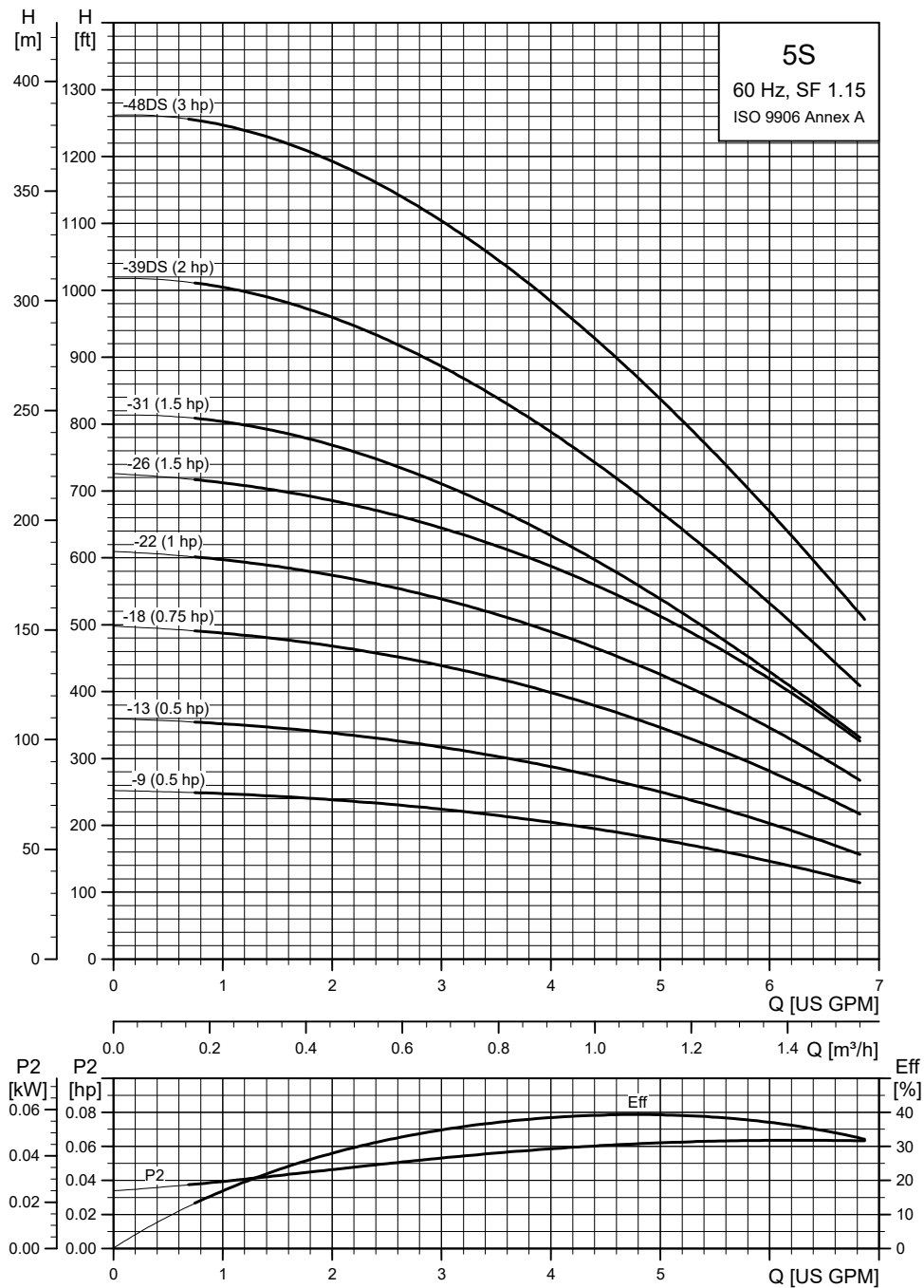

TM050229

**SP 5S (5 gpm) pump with 4" motor**

Pump model	Nom. head [ft]	Ph	Motor			Dimensions [in (mm)]					Net weight (complete) [lb]	5S		
			Volts [V]	[Hp]	[rpm]	A	B	C	D	E				
<b>5S, motor diameter 4-inch, 2-wire motor, 60 Hz - rated flow rate 5 gpm (1" NPT)</b>														
5S05-9	184	1	230	.5	■	3517	24.57 (624)	11.03 (280)	13.55 (344)	3.74 (95)	3.98 (101)	21.6		
5S05-13	258	1	115	.5	■	3360	27.88 (708)	11.03 (280)	16.86 (428)	3.74 (95)	3.98 (101)	26.9		
			230	.5	■	3474	27.88 (708)	11.03 (280)	16.86 (428)	3.74 (95)	3.98 (101)	26.1		
5S07-18	357	1	230	.75	■	3465	32.60 (828)	11.62 (295)	20.99 (533)	3.74 (95)	3.98 (101)	29.7		
5S10-22	439	1	230	1	■	3400	36.50 (927)	12.21 (310)	24.30 (617)	3.74 (95)	3.98 (101)	32.4		
5S15-26	529	1	230	1.5	■	3439	41.30 (1049)	13.71 (348)	27.60 (701)	3.74 (95)	3.98 (101)	41.4		
5S15-31	585	1	230	1.5	■	3410	47.21 (1199)	13.71 (348)	33.51 (851)	3.74 (95)	3.98 (101)	47.7		
<b>5S, motor diameter 4-inch, 3-wire motor, 60 Hz - rated flow rate 5 gpm (1" NPT)</b>														
5S05-9	184	1	230	.5	■	3450	24.57 (624)	11.03 (280)	13.55 (344)	3.74 (95)	3.98 (101)	22.5		
5S05-13	258	1	115	.5	■	3382	27.88 (708)	11.03 (280)	16.86 (428)	3.74 (95)	3.98 (101)	26.9		
			230	.5	■	3352	27.88 (708)	11.03 (280)	16.86 (428)	3.74 (95)	3.98 (101)	25.2		
5S07-18	357	1	230	.75	■	3346	32.60 (828)	11.62 (295)	20.99 (533)	3.74 (95)	3.98 (101)	28.8		
5S10-22	439	1	230	1	■	3379	36.50 (927)	12.21 (310)	24.30 (617)	3.74 (95)	3.98 (101)	32.4		
5S15-26	529	3	1	230	1.5	■	3459	41.30 (1049)	13.71 (348)	27.60 (701)	3.74 (95)	3.98 (101)	37.8	
			230	1.5	■	3465	39.81 (1011)	12.21 (310)	27.60 (701)	3.74 (95)	3.98 (101)	38.7		
			460	1.5	■	3465	39.81 (1011)	12.21 (310)	27.60 (701)	3.74 (95)	3.98 (101)	38.7		
5S15-31	585	3	1	230	1.5	■	3423	47.21 (1199)	13.71 (348)	33.51 (851)	3.74 (95)	3.98 (101)	47.7	
			230	1.5	■	3437	45.71 (1161)	12.21 (310)	33.51 (851)	3.74 (95)	3.98 (101)	45.0		
			460	1.5	■	3437	45.71 (1161)	12.21 (310)	33.51 (851)	3.74 (95)	3.98 (101)	45.0		
5S20-39DS	730	3	1	230	2	●	3428	59.61 (1514)	19.49 (495)	40.12 (1019)	3.74 (95)	4.25 (108)	57.6	
			230	2	■	3426	53.82 (1367)	13.71 (348)	40.12 (1019)	3.74 (95)	4.25 (108)	54.0		
			460	2	■	3426	53.82 (1367)	13.71 (348)	40.12 (1019)	3.74 (95)	4.25 (108)	54.0		
5S30-48DS	909	3	1	230	3	●	3450	70.16 (1782)	22.60 (574)	47.56 (1208)	3.74 (95)	4.25 (108)	77.4	
			208	3	●	3485	65.56 (1665)	18.00 (457)	47.56 (1208)	3.74 (95)	4.25 (108)	77.4		
			230	3	●	3485	65.56 (1665)	18.00 (457)	47.56 (1208)	3.74 (95)	4.25 (108)	77.4		
			460	3	●	3485	65.56 (1665)	18.00 (457)	47.56 (1208)	3.74 (95)	4.25 (108)	77.4		

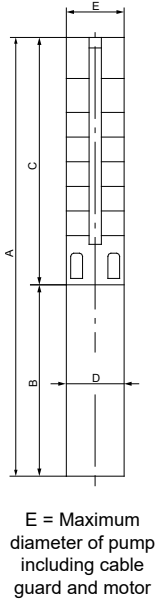

**Notes:**

Control box is required for 3-wire, single-phase applications. Data does not include control box.  
 DS designation = Built into sleeve, 1 - 1/2" NPT, 6" minimum well diameter.  
 Performance conforms to ISO 9906. 1999 (E) Annex A. Minimum submergence is 2 ft (0.6 m).

- MS402 motor
- MS4000C motor

# SP 7S (7 gpm)

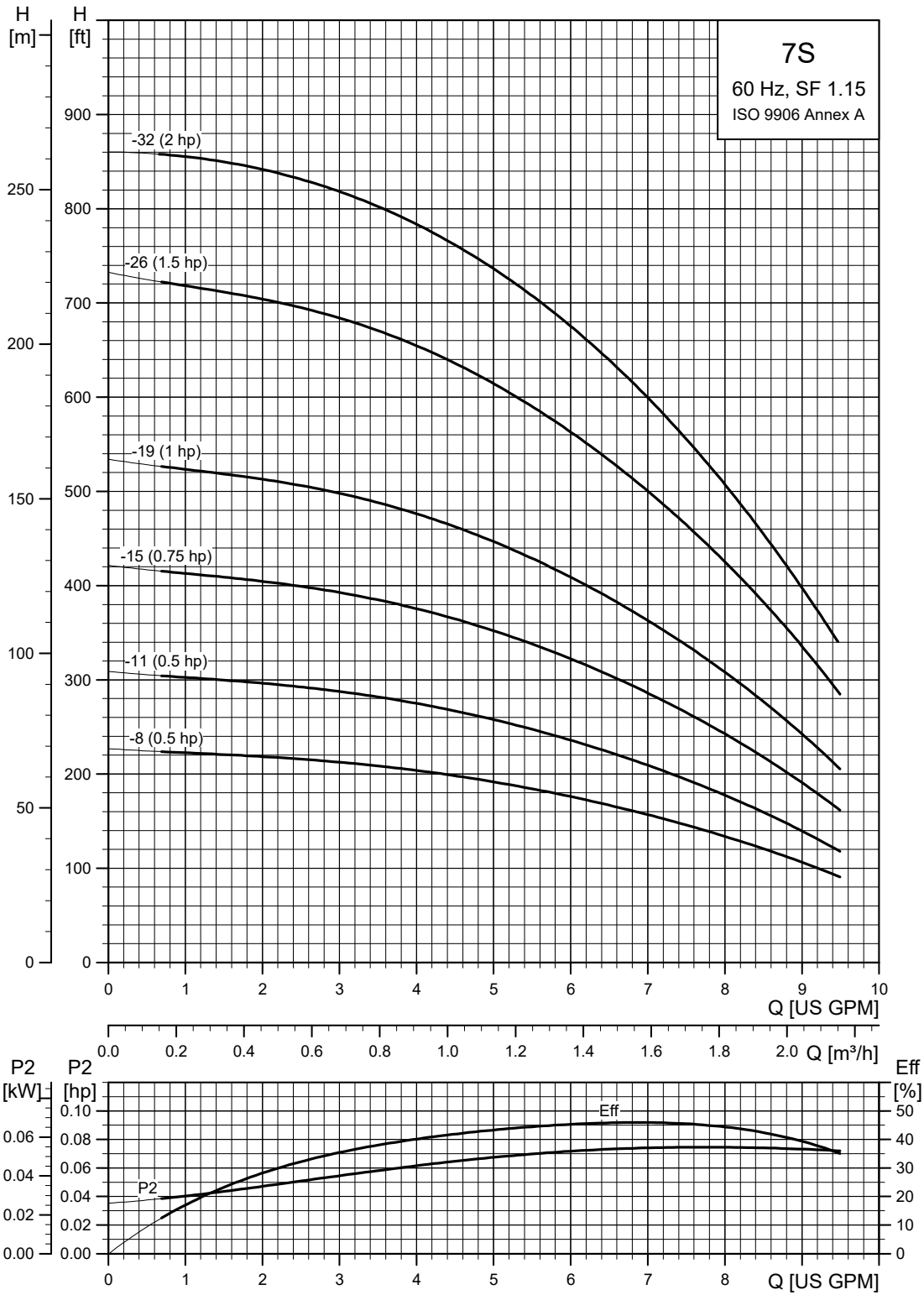

TM050982

**SP 7S (7 gpm) pump with 4" motor**

Pump model	Nom. head [ft]	Ph	Motor			Dimensions [in (mm)]					Net weight (complete) [lb]	90S		
			Volts [V]	[Hp]	[rpm]	A	B	C	D	E				
<b>7S, motor diameter 4-inch, 2-wire motor, 60 Hz - rated flow rate 7 gpm (1" NPT)</b>														
7S05-8	164	1	230	.5	■	3512	23.75 (603)	11.03 (280)	12.72 (323)	3.74 (95)	3.98 (101)	21.6		
7S05-11	222	1	115	.5	■	3359	26.23 (666)	11.03 (280)	15.20 (386)	3.74 (95)	3.98 (101)	29.7		
			230	.5	■	3472	26.23 (666)	11.03 (280)	15.20 (386)	3.74 (95)	3.98 (101)	24.3		
7S07-15	303	1	230	.75	■	3467	30.12 (765)	11.62 (295)	18.51 (470)	3.74 (95)	3.98 (101)	29.7		
7S10-19	385	1	230	1	■	3394	34.02 (864)	12.21 (310)	21.82 (554)	3.74 (95)	3.98 (101)	32.4		
7S15-26	525	1	230	1.5	■	3408	41.3 (1049)	13.71 (348)	27.60 (701)	3.74 (95)	3.98 (101)	41.4		
<b>7S, motor diameter 4-inch, 3-wire motor, 60 Hz - rated flow rate 7 gpm (1" NPT)</b>														
7S05-8	164	1	230	.5	■	3438	23.75 (603)	11.03 (280)	12.72 (323)	3.74 (95)	3.98 (101)	21.6		
7S05-11	222	1	115	.5	■	3380	26.23 (666)	11.03 (280)	15.20 (386)	3.74 (95)	3.98 (101)	21.6		
			230	.5	■	3349	26.23 (666)	11.03 (280)	15.20 (386)	3.74 (95)	3.98 (101)	30.6		
7S07-15	303	1	230	.75	■	3349	30.12 (765)	11.62 (295)	18.51 (470)	3.74 (95)	3.98 (101)	27.9		
7S10-19	385	1	230	1	■	3369	34.02 (864)	12.21 (310)	21.82 (554)	3.74 (95)	3.98 (101)	39.6		
7S15-26	525	3	1	230	1.5	■	3419	41.30 (1049)	13.71 (348)	27.60 (701)	3.74 (95)	3.98 (101)	38.7	
			230	1.5	■	3435	39.81 (1011)	12.21 (310)	27.60 (701)	3.74 (95)	3.98 (101)	38.7		
			460	1.5	■	3435	39.81 (1011)	12.21 (310)	27.60 (701)	3.74 (95)	3.98 (101)	38.7		
7S20-32	630	3	1	230	2	●	3590	52.05 (1322)	19.49 (495)	32.56 (827)	3.74 (95)	3.98 (101)	48.5	
			230	2	■	3596	46.26 (1175)	13.71 (348)	32.56 (827)	3.74 (95)	3.98 (101)	48.5		
			460	2	■	3596	46.26 (1175)	13.71 (348)	32.56 (827)	3.74 (95)	3.98 (101)	48.5		

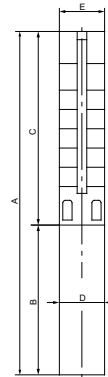

E = Maximum diameter of pump including cable guard and motor.

**Notes:**

Control box is required for 3-wire, single-phase applications. Data does not include control box.  
 DS designation = Built into sleeve, 1 - 1/2" NPT, 6" minimum well diameter.  
 Performance conforms to ISO 9906. 1999 (E) Annex A. Minimum submergence is 2 ft (0.6 m).

■	MS402 motor
●	MS4000C motor

### SP 10S (10 gpm)

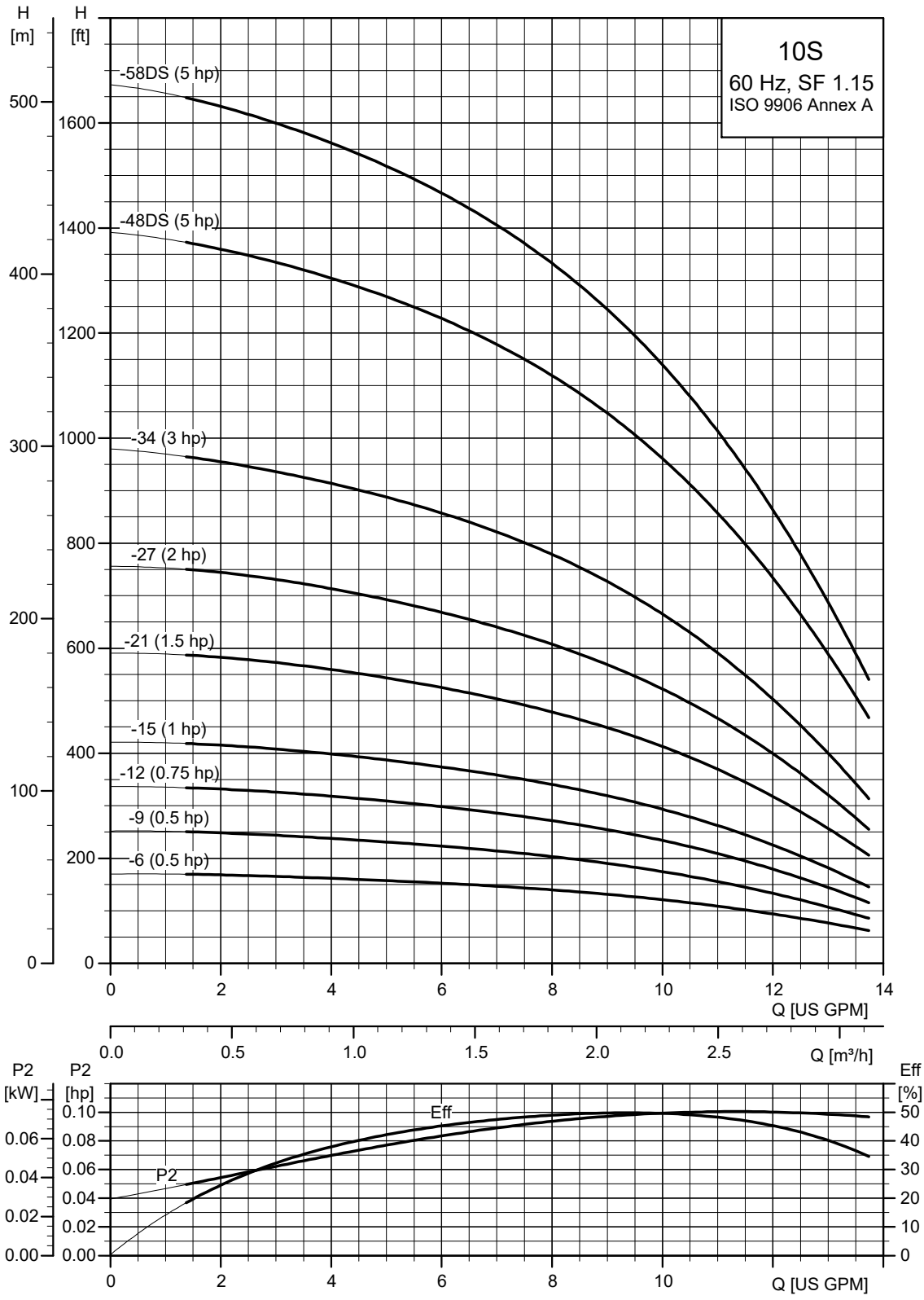

TM050230

**SP 10S (10 gpm) pump with 4" motor**

Pump model	Nom. head [ft]	Ph	Motor				Dimensions [in (mm)]					Net weight (complete) [lb]	10S	
			Volts [V]	[Hp]	[rpm]	A	B	C	D	E				
<b>10S, motor diameter 4-inch, 2-wire motor, 60 Hz - rated flow rate 10 gpm (1.25" NPT)</b>														
10S05-6	126	1	230	.5	■	3454	22.05 (560)	10.99 (279)	11.07 (281)	3.74 (95)	3.98 (101)	20.7		
10S05-9	185	1	115	.5	■	3336	24.53 (623)	10.99 (279)	13.55 (344)	3.74 (95)	3.98 (101)	24.3		
			230	.5	■	3457	24.53 (623)	10.99 (279)	13.55 (344)	3.74 (95)	3.98 (101)	23.4		
10S07-12	246	1	230	.75	■	3453	27.60 (701)	11.58 (294)	16.03 (407)	3.74 (95)	3.98 (101)	24.3		
10S10-15	309	1	230	1	■	3382	30.67 (779)	12.17 (309)	18.51 (470)	3.74 (95)	3.98 (101)	29.7		
10S15-21	433	1	230	1.5	■	3392	37.17 (944)	13.71 (348)	23.47 (596)	3.74 (95)	3.98 (101)	35.1		
<b>10S, motor diameter 4-inch, 3-wire motor, 60 Hz - rated flow rate 10 gpm (1.25" NPT)</b>														
10S05-6	126	1	230	.5	■	3279	24.77 (629)	13.71 (348)	11.07 (281)	3.74 (95)	3.98 (101)	21.6		
10S05-9	185	1	115	.5	■	3350	24.53 (623)	10.99 (279)	13.55 (344)	3.74 (95)	3.98 (101)	25.4		
			230	.5	■	3313	24.53 (623)	10.99 (279)	13.55 (344)	3.74 (95)	3.98 (101)	24.3		
10S07-12	246	1	230	.75	■	3320	27.60 (701)	11.58 (294)	16.03 (407)	3.74 (95)	3.98 (101)	28.8		
10S10-15	309	1	230	1	■	3348	30.67 (779)	12.17 (309)	18.51 (470)	3.74 (95)	3.98 (101)	29.7		
10S15-21	433	3	1	230	1.5	■	3398	37.17 (944)	13.71 (348)	23.47 (596)	3.74 (95)	3.98 (101)	35.1	
			230	1.5	■	3419	35.63 (905)	12.17 (309)	23.47 (596)	3.74 (95)	3.98 (101)	32.4		
			460	1.5	■	3419	35.63 (905)	12.17 (309)	23.47 (596)	3.74 (95)	3.98 (101)	36.0		
10S20-27	554	3	1	230	2	●	3400	47.92 (1217)	19.49 (495)	28.43 (722)	3.74 (95)	3.98 (101)	45.9	
			230	2	■	3399	42.13 (1070)	13.71 (348)	28.43 (722)	3.74 (95)	3.98 (101)	44.1		
			460	2	■	3399	42.13 (1070)	13.71 (348)	28.43 (722)	3.74 (95)	3.98 (101)	44.1		
10S30-34	716	3	1	230	3	●	3418	58.59 (1488)	22.6 (574)	35.99 (914)	3.74 (95)	3.98 (101)	81.9	
			208	3	●	3465	53.98 (1371)	18.00 (457)	35.99 (914)	3.74 (95)	3.98 (101)	74.7		
			230	3	●	3465	53.98 (1371)	18.00 (457)	35.99 (914)	3.74 (95)	3.98 (101)	74.7		
10S50-48DS 1020	1020	3	460	3	●	3465	53.98 (1371)	18.00 (457)	35.99 (914)	3.74 (95)	3.98 (101)	74.7		
			1	230	5	●	3476	74.18 (1884)	26.62 (676)	47.56 (1208)	3.74 (95)	4.25 (108)	103.5	
			208	5	●	3499	70.16 (1782)	22.60 (574)	47.56 (1208)	3.74 (95)	4.25 (108)	103.5		
10S50-58DS 1225	1225	3	460	5	●	3497	70.16 (1782)	22.60 (574)	47.56 (1208)	3.74 (95)	4.25 (108)	103.5		
			1	230	5	●	3441	89.49 (2272)	26.62 (676)	62.88 (1597)	3.74 (95)	4.25 (108)	132.3	
			208	5	●	3473	85.48 (2171)	22.60 (574)	62.88 (1597)	3.74 (95)	4.25 (108)	132.3		
10S50-58DS 1225	1225	3	230	5	●	3473	85.48 (2171)	22.60 (574)	62.88 (1597)	3.74 (95)	4.25 (108)	132.3		
			460	5	●	3470	85.48 (2171)	22.60 (574)	62.88 (1597)	3.74 (95)	4.25 (108)	132.3		

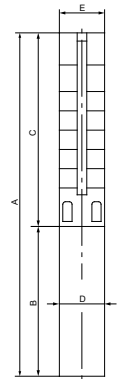

E = Maximum diameter of pump including cable guard and motor

**Notes:**

Control box is required for 3-wire, single-phase applications. Data does not include control box.

DS designation = Built into sleeve, 1 - 1/2" NPT, 6" minimum well diameter.

Performance conforms to ISO 9906. 1999 (E) Annex A. Minimum submergence is 2 ft (0.6 m).

- MS402 motor
- MS4000C motor

# SP 16S (16 gpm)

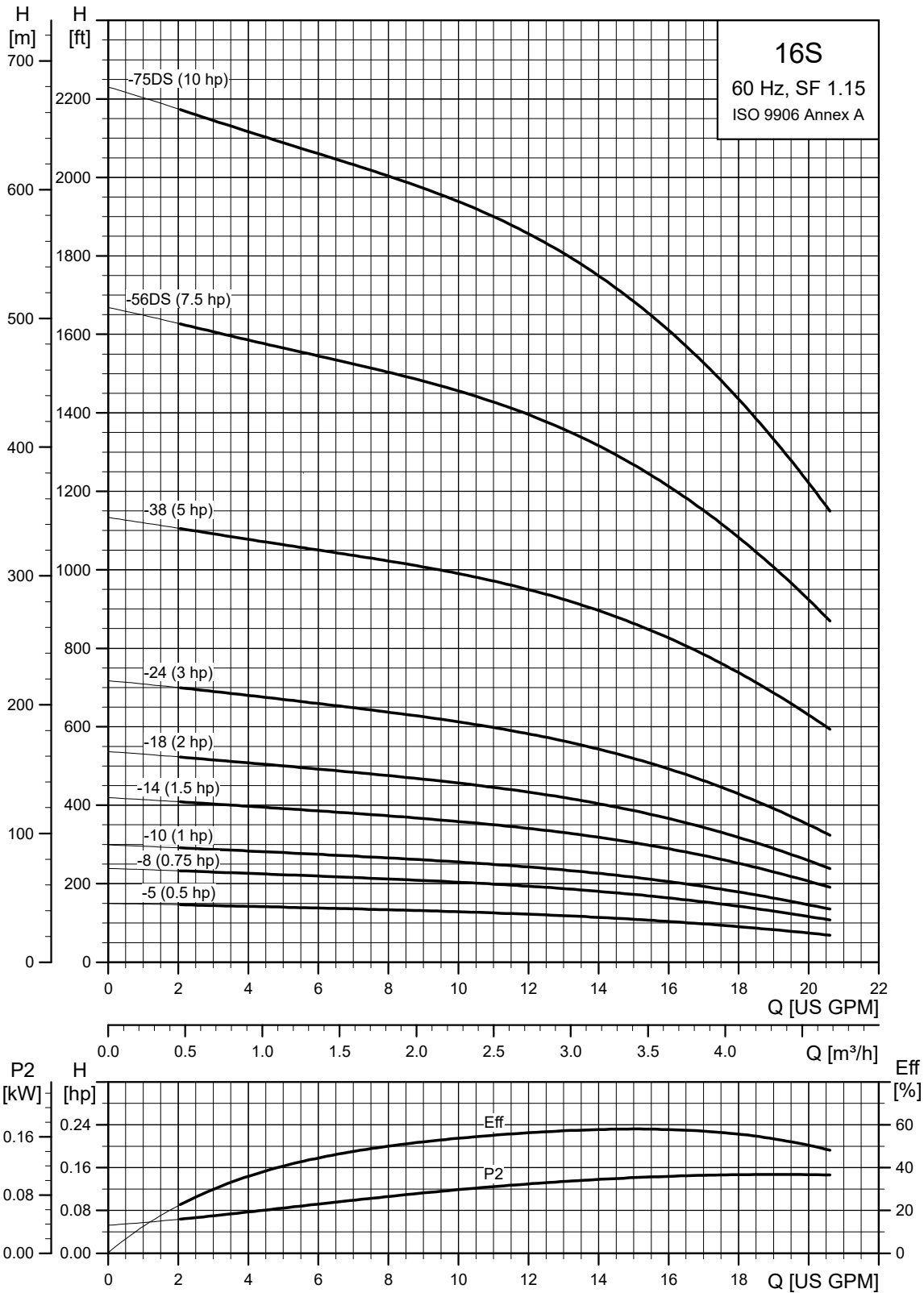

TM050231



**SP 16S (16 gpm) pump with 4", 6" motors**

Pump model	Nom. head [ft]	Ph	Motor			Dimensions [in (mm)]					Net weight (complete) [lb]	16S
			Volts [V]	[Hp]	[rpm]	A	B	C	D	E		
<b>16S, motor diameter 4-inch, 2-wire motor, 60 Hz - rated flow rate 16 gpm (1.25" NPT)</b>												
16S05-5	112	1	115	.5	■	3391	21.26 (540)	11.03 (280)	10.24 (260)	3.74 (95)	3.98 (101)	21.6
			230	.5	■	3393	21.26 (540)	11.03 (280)	10.24 (260)	3.74 (95)	3.98 (101)	23.4
16S07-8	177	1	230	.75	■	3464	24.34 (618)	11.62 (295)	12.72 (323)	3.74 (95)	3.98 (101)	24.3
16S10-10	223	1	230	1	■	3394	26.58 (675)	12.21 (310)	14.38 (365)	3.74 (95)	3.98 (101)	27.9
16S15-14	313	1	230	1.5	■	3403	31.38 (797)	13.71 (348)	17.68 (449)	3.74 (95)	3.98 (101)	36.0
<b>16S, motor diameter 4-inch, 3-wire motor, 60 Hz - rated flow rate 16 gpm (1.25" NPT)</b>												
16S05-5	112	1	115	.5	■	3419	21.26 (540)	11.03 (280)	10.24 (260)	3.74 (95)	3.98 (101)	21.6
			230	.5	■	3396	21.26 (540)	11.03 (280)	10.24 (260)	3.74 (95)	3.98 (101)	21.6
16S07-8	177	1	230	.75	■	3343	24.34 (618)	11.62 (295)	12.72 (323)	3.74 (95)	3.98 (101)	27.0
16S10-10	223	1	230	1	■	3369	26.58 (675)	12.21 (310)	14.38 (365)	3.74 (95)	3.98 (101)	27.9
		1	230	1.5	■	3414	31.38 (797)	13.71 (348)	17.68 (449)	3.74 (95)	3.98 (101)	32.4
16S15-14	313	3	230	1.5	■	3430	29.89 (759)	12.21 (310)	17.68 (449)	3.74 (95)	3.98 (101)	28.8
			460	1.5	■	3430	29.89 (759)	12.21 (310)	17.68 (449)	3.74 (95)	3.98 (101)	28.8
16S20-18	397	3	230	2	●	3414	40.48 (1028)	19.49 (495)	20.99 (533)	3.74 (95)	3.98 (101)	36.0
			230	2	■	3413	34.69 (881)	13.71 (348)	20.99 (533)	3.74 (95)	3.98 (101)	36.0
16S30-24	533	3	460	2	■	3413	34.69 (881)	13.71 (348)	20.99 (533)	3.74 (95)	3.98 (101)	36.0
			1	230	3	●	3416	48.55 (1233)	22.60 (574)	25.95 (659)	3.74 (95)	3.98 (101)
16S30-24	533	3	208	3	●	3464	43.94 (1116)	18.00 (457)	25.95 (659)	3.74 (95)	3.98 (101)	57.6
			230	3	●	3464	43.94 (1116)	18.00 (457)	25.95 (659)	3.74 (95)	3.98 (101)	57.6
16S50-38	832	3	460	3	●	3464	43.94 (1116)	18.00 (457)	25.95 (659)	3.74 (95)	3.98 (101)	57.6
			1	230	5	●	3449	65.91 (1674)	26.62 (676)	39.30 (998)	3.74 (95)	3.98 (101)
16S50-38	832	3	208	5	●	3479	62.01 (1575)	22.72 (577)	39.30 (998)	3.74 (95)	3.98 (101)	90.0
			230	5	●	3479	62.01 (1575)	22.72 (577)	39.30 (998)	3.74 (95)	3.98 (101)	90.0
16S50-38	832	3	460	5	●	3476	62.01 (1575)	22.72 (577)	39.30 (998)	3.74 (95)	3.98 (101)	90.0
<b>SP 16S, motor diameter 6 inch, 60 Hz - rated flow rate 16 gpm (1.25" NPT)</b>												
-	3	3	208	5	▲	3480	-	23.51 (597)	-	5.50 (139.5)	-	80.0
			230	5	▲	3510	-	23.51 (597)	-	5.50 (139.5)	-	80.0
			460	5	▲	3500	-	23.51 (597)	-	5.50 (139.5)	-	80.0
16S75-56DS	1224	3	208	7.5	▲	3478	92.28 (2344)	23.51 (597)	68.78 (1747)	5.63 (143)	5.51 (140)	165.1
			230	7.5	▲	3478	92.28 (2344)	23.51 (597)	68.78 (1747)	5.63 (143)	5.51 (140)	165.1
			460	7.5	▲	3491	92.28 (2344)	23.51 (597)	68.78 (1747)	5.63 (143)	5.51 (140)	165.1
16S100-75DS	1636	3	460	10	▲	3482	109.18 (2773)	24.69 (627)	84.49 (2146)	5.63 (143)	5.51 (140)	190.0

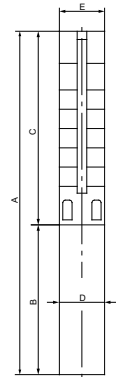

E = Maximum diameter of pump including cable guard and motor

**Notes:**

Control box is required for 3-wire, single-phase applications. Data does not include control box.

DS designation = Built into sleeve, 1 - 1/2" NPT, 6" minimum well diameter.

Performance conforms to ISO 9906. 1999 (E) Annex A. Minimum submergence is 2 ft (0.6 ft).

■	MS402 motor
●	MS4000C motor
▲	MS6000C motor

# SP 25S (25 gpm)

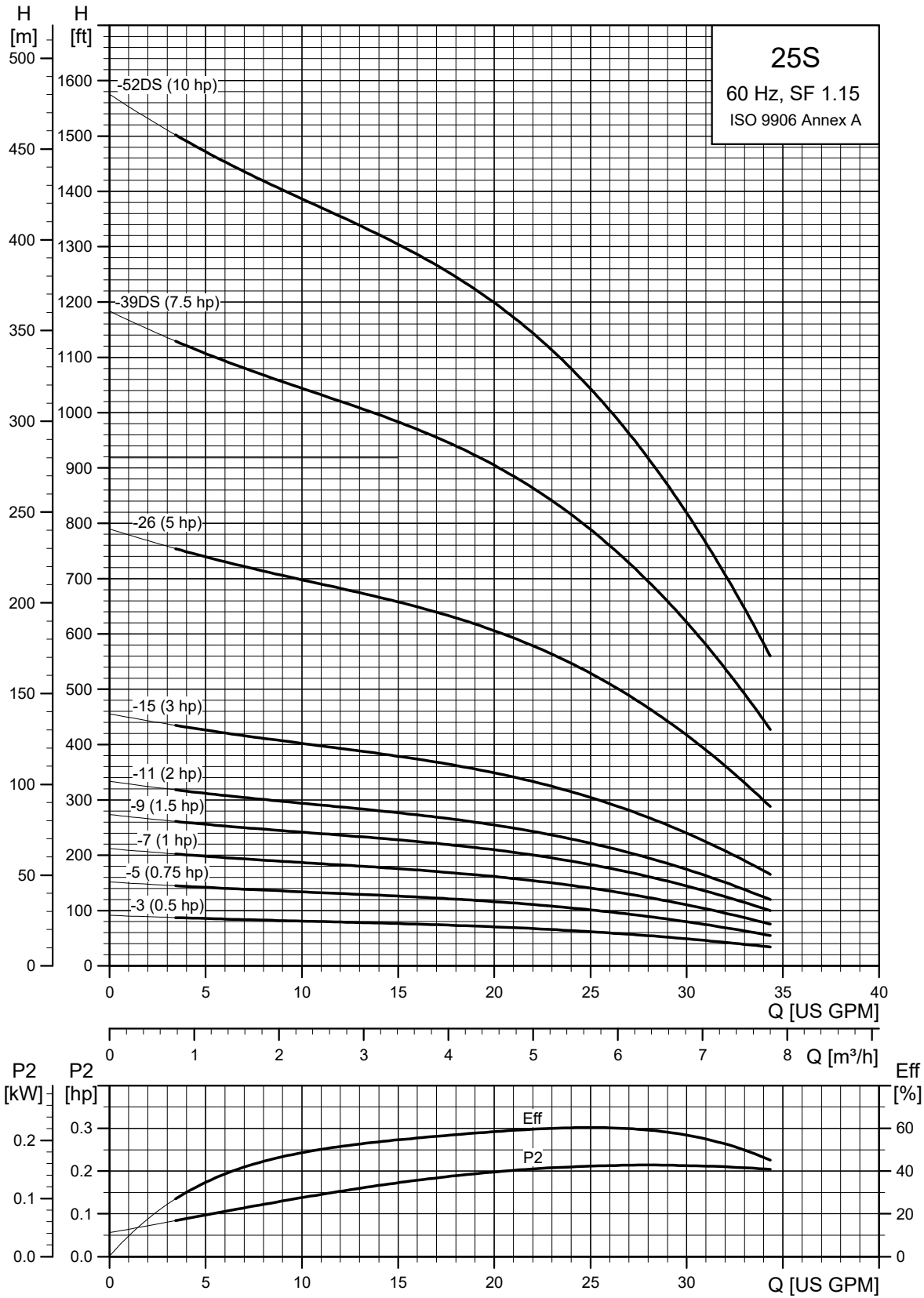

TM050232

**SP 25S (25 gpm) pump with 4", 6" inch motors**

Pump model	Nom. head [ft]	Ph	Motor			Dimensions [in (mm)]					Net weight (complete) [lb]	25S	
			Volts [V]	[Hp]	[rpm]	A	B	C	D	E			
<b>25S, motor diameter 4-inch, 2-wire motor, 60 Hz - rated flow rate 25 gpm (1.5" NPT)</b>													
25S05-3	64	1	115	.5	■	3411	19.61 (498)	11.03 (280)	8.59 (218)	3.74 (95)	3.98 (101)	21.6	
			230	.5	■	3505	19.61 (498)	11.03 (280)	8.59 (218)	3.74 (95)	3.98 (101)	21.6	
25S07-5	105	1	230	.75	■	3474	21.86 (555)	11.62 (295)	10.24 (260)	3.74 (95)	3.98 (101)	23.4	
25S10-7	146	1	230	1	■	3383	24.10 (612)	12.21 (310)	11.89 (302)	3.74 (95)	3.98 (101)	25.2	
25S15-9	189	1	230	1.5	■	3410	27.25 (692)	13.71 (348)	13.55 (344)	3.74 (95)	3.98 (101)	28.8	
<b>25S, motor diameter 4-inch, 3-wire motor, 60 Hz - rated flow rate 25 gpm (1.5" NPT)</b>													
25S05-3	64	1	115	.5	■	3441	19.61 (498)	11.03 (280)	8.59 (218)	3.74 (95)	3.98 (101)	21.6	
			230	.5	■	3423	19.61 (498)	11.03 (280)	8.59 (218)	3.74 (95)	3.98 (101)	21.6	
25S07-5	105	1	230	.75	■	3365	21.86 (555)	11.62 (295)	10.24 (260)	3.74 (95)	3.98 (101)	23.4	
25S10-7	146	1	230	1	■	3349	24.10 (612)	12.21 (310)	11.89 (302)	3.74 (95)	3.98 (101)	25.2	
		1	230	1.5	■	3422	27.25 (692)	13.71 (348)	13.55 (344)	3.74 (95)	3.98 (101)	29.7	
25S15-9	189	3	230	1.5	■	3437	25.75 (654)	12.21 (310)	13.55 (344)	3.74 (95)	3.98 (101)	27.0	
			460	1.5	■	3437	25.75 (654)	12.21 (310)	13.55 (344)	3.74 (95)	3.98 (101)	28.8	
25S20-11	229	1	230	2	●	3434	34.69 (881)	19.49 (495)	15.20 (386)	3.74 (95)	3.98 (101)	33.1	
		3	230	2	■	3431	28.90 (734)	13.71 (348)	15.20 (386)	3.74 (95)	3.98 (101)	37.0	
			460	2	■	3431	28.90 (734)	13.71 (348)	15.20 (386)	3.74 (95)	3.98 (101)	33.3	
25S30-15	314	1	230	3	●	3432	41.11 (1044)	22.60 (574)	18.51 (470)	3.74 (95)	3.98 (101)	61.2	
		3	208	3	●	3474	36.50 (927)	18.00 (457)	18.51 (470)	3.74 (95)	3.98 (101)	53.1	
			230	3	●	3474	36.50 (927)	18.00 (457)	18.51 (470)	3.74 (95)	3.98 (101)	53.1	
25S50-26	546	3	460	3	●	3474	36.50 (927)	18.00 (457)	18.51 (470)	3.74 (95)	3.98 (101)	53.1	
			1	230	5	●	3449	54.22 (1377)	26.62 (676)	27.60 (701)	3.74 (95)	3.98 (101)	72.9
			208	5	●	3479	50.32 (1278)	22.72 (577)	27.60 (701)	3.74 (95)	3.98 (101)	72.9	
25S50-26	546	3	230	5	●	3479	50.32 (1278)	22.72 (577)	27.60 (701)	3.74 (95)	3.98 (101)	72.9	
			460	5	●	3476	50.32 (1278)	22.72 (577)	27.60 (701)	3.74 (95)	3.98 (101)	72.9	
			230	5	●	3479	50.32 (1278)	22.72 (577)	27.60 (701)	3.74 (95)	3.98 (101)	72.9	
<b>SP 25S, motor diameter 6 inch, 60 Hz - rated flow rate 25 gpm (1.5" NPT)</b>													
-	-	3	208	5	▲	3480	-	23.51 (597)	-	5.50 (139.5)	-	80.0	
			230	5	▲	3510	-	23.51 (597)	-	5.50 (139.5)	-	80.0	
			460	5	▲	3500	-	23.51 (597)	-	5.50 (139.5)	-	80.0	
25S75-39DS	815	3	208	7.5	▲	3475	66.06 (1678)	23.51 (597)	42.56 (1081)	5.63 (143)	5.43 (138)	122.1	
			230	7.5	▲	3475	66.06 (1678)	23.51 (597)	42.56 (1081)	5.63 (143)	5.43 (138)	122.1	
			460	7.5	▲	3488	66.06 (1678)	23.51 (597)	42.56 (1081)	5.63 (143)	5.43 (138)	122.1	
25S100-52DS	1082	3	460	10	▲	3480	90.17 (2290)	24.69 (627)	65.48 (1663)	5.63 (143)	5.51 (140)	163.1	

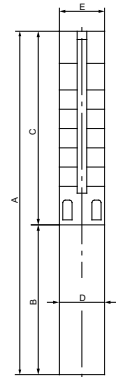

E = Maximum diameter of pump including cable guard and motor

**Notes:**

Control box is required for 3-wire, single-phase applications. Data does not include control box.

DS designation = Built into sleeve, 1 - 1/2" NPT, 6" minimum well diameter.

Performance conforms to ISO 9906. 1999 (E) Annex A. Minimum submergence is 2 ft (0.6 m).

■	MS402 motor
●	MS4000C motor
▲	MS6000C motor

## SP 35S (35 gpm)

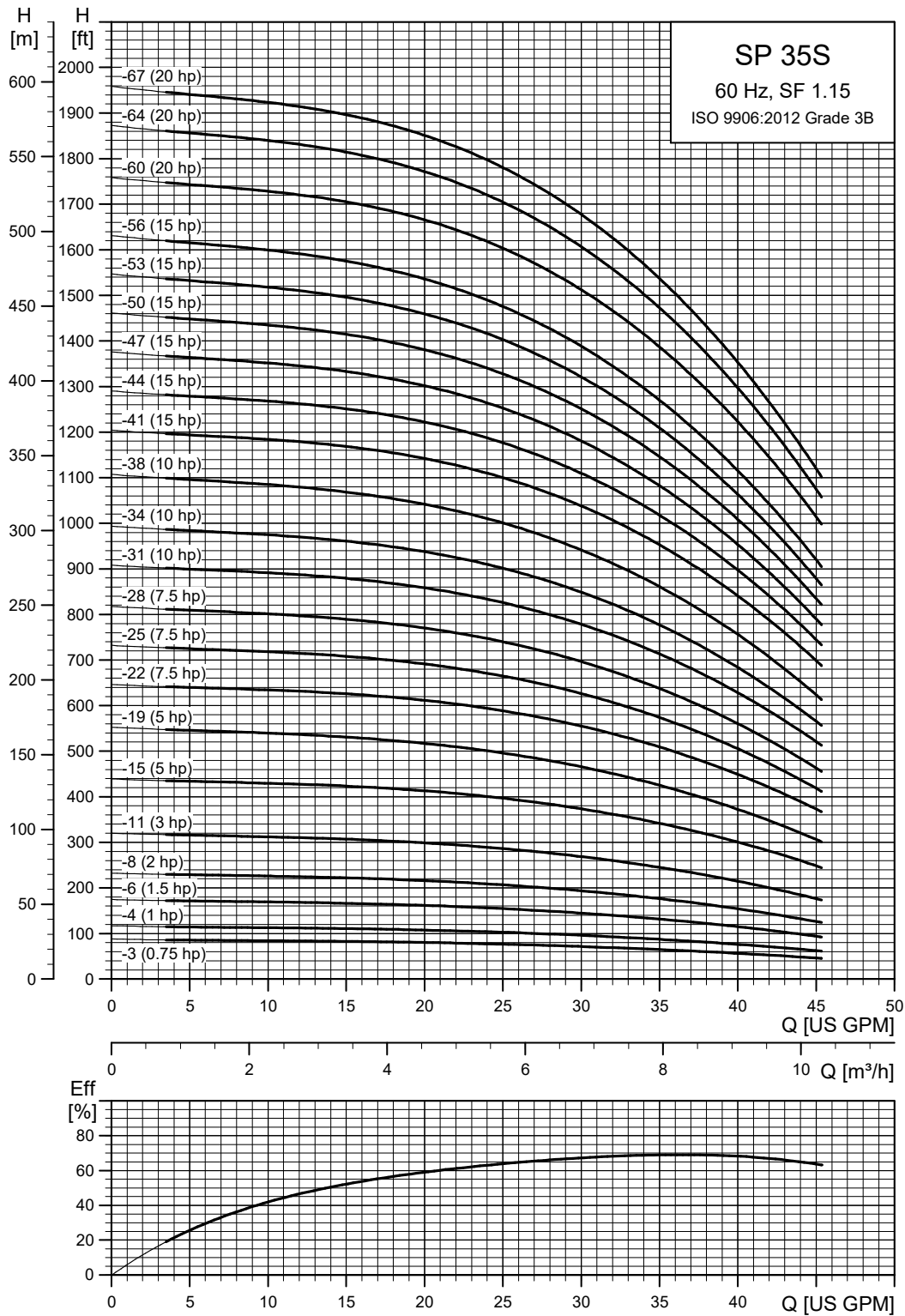

TM064614

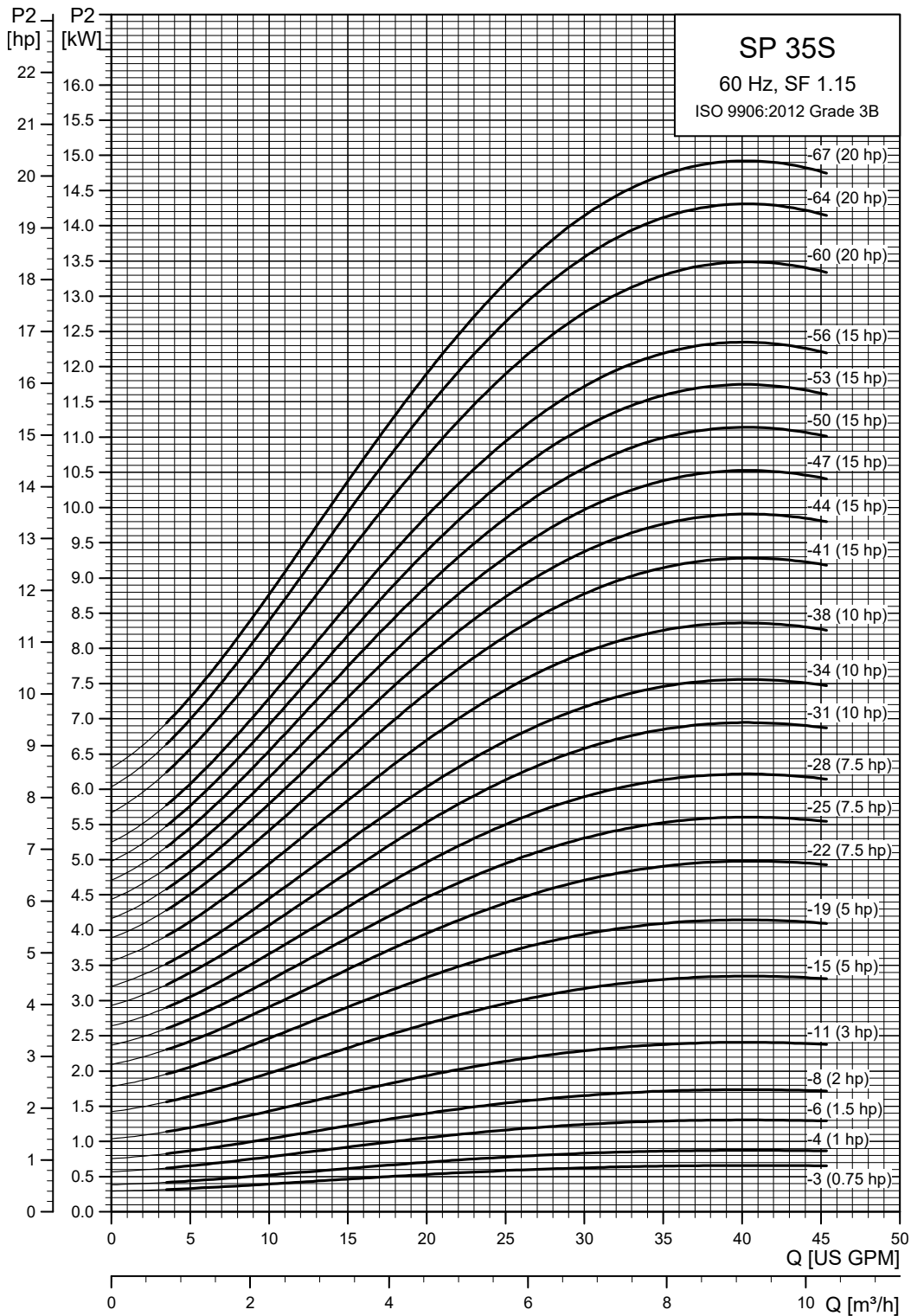

TM064615

## SP 35S (35 gpm) pump with 4" motor

Pump model	Nom. head [ft]	Motor				Dimensions [in (mm)]					Net weight (complete) [lb]	35S
		Ph	Volts [V]	[Hp]	[rpm]	A	B	C	D	E		
<b>35S - Motor diameter 4-inch, 3-wire motor, 60 Hz, rated flow rate 35 gpm (1 1/2" NPT)</b>												
35S07-3	61	1	230	.75	■	3427	28.35 (720)	13.08 (332)	15.28 (388)	3.75 (95)	3.98 (101)	29.9
			230	.75	■	3439	26.97 (685)	11.70 (297)	15.28 (388)	3.75 (95)	3.98 (101)	26.9
		3	460	.75	■	3439	26.97 (685)	11.70 (297)	15.28 (388)	3.75 (95)	3.98 (101)	26.9
			575	.75	■	3428	26.97 (685)	11.70 (297)	15.28 (388)	3.75 (95)	3.98 (101)	26.9
35S10-4	82	1	230	1	■	3429	30.91 (785)	13.67 (347)	17.25 (438)	3.75 (95)	3.98 (101)	32.8
			230	1	■	3445	29.73 (755)	12.49 (317)	17.25 (438)	3.75 (95)	3.98 (101)	30.1
		3	460	1	■	3445	29.73 (755)	12.49 (317)	17.25 (438)	3.75 (95)	3.98 (101)	29.9
			575	1	■	3431	29.73 (755)	12.49 (317)	17.25 (438)	3.75 (95)	3.98 (101)	29.9
35S15-6	126	1	230	1.5	■	3442	36.42 (925)	15.24 (387)	21.19 (538)	3.75 (95)	3.98 (101)	39.1
			230	1.5	■	3451	34.85 (885)	13.67 (347)	21.19 (538)	3.75 (95)	3.98 (101)	35.5
		3	460	1.5	■	3451	34.85 (885)	13.67 (347)	21.19 (538)	3.75 (95)	3.98 (101)	35.5
			575	1.5	■	3427	34.85 (885)	13.67 (347)	21.19 (538)	3.75 (95)	3.98 (101)	35.3
35S20-8	168	1	230	2	●	3434	44.69 (1135)	19.57 (497)	25.12 (638)	3.75 (95)	3.98 (101)	57.3
			230	2	■	3432	40.36 (1025)	15.24 (387)	25.12 (638)	3.75 (95)	3.98 (101)	41.9
		3	460	2	■	3432	40.36 (1025)	15.24 (387)	25.12 (638)	3.75 (95)	3.98 (101)	42.1
			575	2	■	3430	40.36 (1025)	15.24 (387)	25.12 (638)	3.75 (95)	3.98 (101)	41.9
35S30-11	232	1	230	3	●	3431	53.75 (1365)	22.72 (577)	31.03 (788)	3.75 (95)	3.98 (101)	69.9
			208	3	●	3440	49.02 (1245)	18.00 (457)	31.03 (788)	3.75 (95)	3.98 (101)	56.7
		3	230	3	●	3440	49.02 (1245)	18.00 (457)	31.03 (788)	3.75 (95)	3.98 (101)	56.7
			460	3	●	3468	49.02 (1245)	18.00 (457)	31.03 (788)	3.75 (95)	3.98 (101)	56.7
35S50-15	327	1	230	5	●	3483	65.56 (1665)	26.66 (677)	38.90 (988)	3.75 (95)	3.98 (101)	86.1
			208	5	●	3502	61.62 (1565)	22.72 (577)	38.90 (988)	3.75 (95)	3.98 (101)	75.1
		3	230	5	●	3502	61.62 (1565)	22.72 (577)	38.90 (988)	3.75 (95)	3.98 (101)	75.1
			460	5	●	3501	61.62 (1565)	22.72 (577)	38.90 (988)	3.75 (95)	3.98 (101)	75.1
35S50-19	407	1	230	5	●	3446	73.43 (1865)	26.66 (677)	46.78 (1188)	3.75 (95)	3.98 (101)	91.2
			208	5	●	3473	69.49 (1765)	22.72 (577)	46.78 (1188)	3.75 (95)	3.98 (101)	80.2
		3	230	5	●	3473	69.49 (1765)	22.72 (577)	46.78 (1188)	3.75 (95)	3.98 (101)	80.2
			460	5	●	3471	69.49 (1765)	22.72 (577)	46.78 (1188)	3.75 (95)	3.98 (101)	80.2
35S75-22	485	3	208	7.5	●	3495	79.34 (2015)	26.66 (677)	52.68 (1338)	3.75 (95)	3.98 (101)	95.0
			230	7.5	●	3495	79.34 (2015)	26.66 (677)	52.68 (1338)	3.75 (95)	3.98 (101)	95.0
		3	460	7.5	●	3495	79.34 (2015)	26.66 (677)	52.68 (1338)	3.75 (95)	3.98 (101)	95.0
			575	7.5	●	3495	79.34 (2015)	26.66 (677)	52.68 (1338)	3.75 (95)	3.98 (101)	95.0

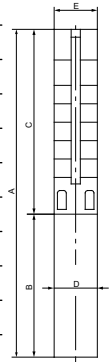

E = Maximum diameter of pump including cable guard and motor

**Notes:**

Control box is required for 3-wire, single-phase applications. Data does not include control box.  
Performance conforms to ISO 9906. 1999 (E) Annex A. Minimum submergence is 5 ft (1.5 m).

- MS402 motor
- MS4000C motor

SP 35S (35 gpm) pump with 4" motor, continued

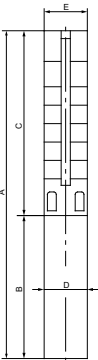
Pump model	Nom. head [ft]	Motor				Dimensions [in (mm)]					Net weight (complete) [lb]	35S	
		Ph	Volts [V]	[Hp]	[rpm]	A	B	C	D	E			
<b>35S - Motor diameter 4-inch, 3-wire motor, 60 Hz, rated flow rate 35 gpm (1 1/2" NPT)</b>													
35S75-25	547	3	208	7.5	●	3479	85.24 (2165)	26.66 (677)	58.59 (1488)	3.75 (95)	3.98 (101)	98.9	 <p>E = Maximum diameter of pump including cable guard and motor.</p>
			230	7.5	●	3479	85.24 (2165)	26.66 (677)	58.59 (1488)	3.75 (95)	3.98 (101)	98.9	
			460	7.5	●	3479	85.24 (2165)	26.66 (677)	58.59 (1488)	3.75 (95)	3.98 (101)	98.9	
			575	7.5	●	3479	85.24 (2165)	26.66 (677)	58.59 (1488)	3.75 (95)	3.98 (101)	98.9	
35S75-28	607	3	208	7.5	●	3463	91.15 (2315)	26.66 (677)	64.49 (1638)	3.75 (95)	3.98 (101)	102.7	
			230	7.5	●	3463	91.15 (2315)	26.66 (677)	64.49 (1638)	3.75 (95)	3.98 (101)	102.7	
			460	7.5	●	3463	91.15 (2315)	26.66 (677)	64.49 (1638)	3.75 (95)	3.98 (101)	102.7	
35S100-31	682	3	460	10	●	3487	100.99 (2565)	30.60 (777)	70.40 (1788)	3.75 (95)	3.98 (101)	115.4	
			575	10	●	3487	100.99 (2565)	30.60 (777)	70.40 (1788)	3.75 (95)	3.98 (101)	115.4	
35S100-34	743	3	460	10	●	3475	106.89 (2715)	30.60 (777)	76.30 (1938)	3.75 (95)	3.98 (101)	119.2	
			575	10	●	3475	106.89 (2715)	30.60 (777)	76.30 (1938)	3.75 (95)	3.98 (101)	119.2	
35S100-38	823	3	460	10	●	3459	114.77 (2915)	30.60 (777)	84.18 (2138)	3.75 (95)	3.98 (101)	124.3	
			575	10	●	3459	114.77 (2915)	30.60 (777)	84.18 (2138)	3.75 (95)	3.98 (101)	124.3	

- MS402 motor
- MS4000C motor

**SP 35S (35 gpm) pump with 6" motor**

Pump model	Nom. head [ft]	Motor				Dimensions [in (mm)]					Net weight (complete) [lb]	35S
		Ph	Volts [V]	[Hp]	[rpm]	A	B	C	D	E		
<b>35S - Motor diameter 6 inch, 60 Hz, rated flow rate 35 gpm (1 1/2" NPT)</b>												
35S75-22	487	3	208	7.5 ▲	3502	78.67 (1998)	23.51 (597)	55.16 (1401)	5.50 (140)	5.50 (140)	123.6	
	487	3	230	7.5 ▲	3502	78.67 (1998)	23.51 (597)	55.16 (1401)	5.50 (140)	5.50 (140)	123.6	
	490	3	460	7.5 ▲	3510	78.67 (1998)	23.51 (597)	55.16 (1401)	5.50 (140)	5.50 (140)	123.6	
	489	3	575	7.5 ▲	3509	78.67 (1998)	23.51 (597)	55.16 (1401)	5.50 (140)	5.50 (140)	123.6	
35S75-25	549	3	208	7.5 ▲	3487	84.57 (2148)	23.51 (597)	61.07 (1551)	5.50 (140)	5.50 (140)	127.5	
	549	3	230	7.5 ▲	3487	84.57 (2148)	23.51 (597)	61.07 (1551)	5.50 (140)	5.50 (140)	127.5	
	553	3	460	7.5 ▲	3498	84.57 (2148)	23.51 (597)	61.07 (1551)	5.50 (140)	5.50 (140)	127.5	
	552	3	575	7.5 ▲	3496	84.57 (2148)	23.51 (597)	61.07 (1551)	5.50 (140)	5.50 (140)	127.5	
35S75-28	611	3	208	7.5 ▲	3472	90.48 (2298)	23.51 (597)	66.97 (1701)	5.50 (140)	5.50 (140)	131.4	
	611	3	230	7.5 ▲	3472	90.48 (2298)	23.51 (597)	66.97 (1701)	5.50 (140)	5.50 (140)	131.4	
	615	3	460	7.5 ▲	3484	90.48 (2298)	23.51 (597)	66.97 (1701)	5.50 (140)	5.50 (140)	131.4	
	614	3	575	7.5 ▲	3483	90.48 (2298)	23.51 (597)	66.97 (1701)	5.50 (140)	5.50 (140)	131.4	
35S100-31	688	3	208	10 ▲	3489	97.56 (2478)	24.69 (627)	72.88 (1851)	5.50 (140)	5.50 (140)	142.0	
	687	3	230	10 ▲	3489	97.56 (2478)	24.69 (627)	72.88 (1851)	5.50 (140)	5.50 (140)	142.0	
	687	3	460	10 ▲	3499	97.56 (2478)	24.69 (627)	72.88 (1851)	5.50 (140)	5.50 (140)	142.0	
	687	3	575	10 ▲	3498	97.56 (2478)	24.69 (627)	72.88 (1851)	5.50 (140)	5.50 (140)	142.0	
35S100-34	744	3	208	10 ▲	3476	103.47 (2628)	24.69 (627)	78.78 (2001)	5.50 (140)	5.50 (140)	145.9	
	744	3	230	10 ▲	3476	103.47 (2628)	24.69 (627)	78.78 (2001)	5.50 (140)	5.50 (140)	145.9	
	749	3	460	10 ▲	3488	103.47 (2628)	24.69 (627)	78.78 (2001)	5.50 (140)	5.50 (140)	145.9	
	749	3	575	10 ▲	3488	103.47 (2628)	24.69 (627)	78.78 (2001)	5.50 (140)	5.50 (140)	145.9	
35S100-38	824	3	208	10 ▲	3459	111.34 (2828)	24.69 (627)	86.66 (2201)	5.50 (140)	5.50 (140)	151.1	
	824	3	230	10 ▲	3459	111.34 (2828)	24.69 (627)	86.66 (2201)	5.50 (140)	5.50 (140)	151.1	
	830	3	460	10 ▲	3474	111.34 (2828)	24.69 (627)	86.66 (2201)	5.50 (140)	5.50 (140)	151.1	
	830	3	575	10 ▲	3473	111.34 (2828)	24.69 (627)	86.66 (2201)	5.50 (140)	5.50 (140)	151.1	

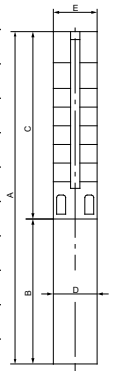

E = Maximum diameter of pump including cable guard and motor

**Notes:**

Performance conforms to ISO 9906, 1999 (E) Annex A. Minimum submergence is 5 ft (1.5 m).

▲ MS6000C motor



SP 35S (35 gpm) pump with 6" motor, continued

Pump model	Nom. head [ft]	Motor				Dimensions [in (mm)]					Net weight (complete) [lb]	35S
		Ph	Volts [V]	[Hp]	[rpm]	A	B	C	D	E		
<b>35S - Motor diameter 6 inch, 60 Hz, rated flow rate 35 gpm (2" NPT)</b>												
35S150-41DS	912	3	208	15	▲	3503	131.23 (3333)	27.05 (687)	104.18 (2646)	5.50 (140)	5.50 (140)	217.3
	912	3	230	15	▲	3503	131.23 (3333)	27.05 (687)	104.18 (2646)	5.50 (140)	5.50 (140)	217.3
	914	3	460	15	▲	3507	131.23 (3333)	27.05 (687)	104.18 (2646)	5.50 (140)	5.50 (140)	217.3
	913	3	575	15	▲	3506	131.23 (3333)	27.05 (687)	104.18 (2646)	5.50 (140)	5.50 (140)	217.3
35S150-44DS	975	3	208	15	▲	3496	137.13 (3483)	27.05 (687)	110.08 (2796)	5.50 (140)	5.50 (140)	223.1
	975	3	230	15	▲	3496	137.13 (3483)	27.05 (687)	110.08 (2796)	5.50 (140)	5.50 (140)	223.1
	977	3	460	15	▲	3500	137.13 (3483)	27.05 (687)	110.08 (2796)	5.50 (140)	5.50 (140)	223.1
	976	3	575	15	▲	3499	137.13 (3483)	27.05 (687)	110.08 (2796)	5.50 (140)	5.50 (140)	223.1
35S150-47DS	1037	3	208	15	▲	3488	143.04 (3633)	27.05 (687)	115.99 (2946)	5.50 (140)	5.50 (140)	228.8
	1037	3	230	15	▲	3488	143.04 (3633)	27.05 (687)	115.99 (2946)	5.50 (140)	5.50 (140)	228.8
	1040	3	460	15	▲	3493	143.04 (3633)	27.05 (687)	115.99 (2946)	5.50 (140)	5.50 (140)	228.8
	1039	3	575	15	▲	3491	143.04 (3633)	27.05 (687)	115.99 (2946)	5.50 (140)	5.50 (140)	228.8
35S150-50DS	1098	3	208	15	▲	3480	148.94 (3783)	27.05 (687)	121.89 (3096)	5.50 (140)	5.50 (140)	234.6
	1098	3	230	15	▲	3480	148.94 (3783)	27.05 (687)	121.89 (3096)	5.50 (140)	5.50 (140)	234.6
	1101	3	460	15	▲	3485	148.94 (3783)	27.05 (687)	121.89 (3096)	5.50 (140)	5.50 (140)	234.6
	1100	3	575	15	▲	3484	148.94 (3783)	27.05 (687)	121.89 (3096)	5.50 (140)	5.50 (140)	234.6
35S150-53DS	1159	3	208	15	▲	3472	154.85 (3933)	27.05 (687)	127.80 (3246)	5.50 (140)	5.50 (140)	240.3
	1159	3	230	15	▲	3472	154.85 (3933)	27.05 (687)	127.80 (3246)	5.50 (140)	5.50 (140)	240.3
	1163	3	460	15	▲	3478	154.85 (3933)	27.05 (687)	127.80 (3246)	5.50 (140)	5.50 (140)	240.3
	1161	3	575	15	▲	3476	154.85 (3933)	27.05 (687)	127.80 (3246)	5.50 (140)	5.50 (140)	240.3
35S150-56DS	1218	3	208	15	▲	3464	160.75 (4083)	27.05 (687)	133.71 (3396)	5.50 (140)	5.50 (140)	246.1
	1218	3	230	15	▲	3464	160.75 (4083)	27.05 (687)	133.71 (3396)	5.50 (140)	5.50 (140)	246.1
	1223	3	460	15	▲	3470	160.75 (4083)	27.05 (687)	133.71 (3396)	5.50 (140)	5.50 (140)	246.1
	1222	3	575	15	▲	3468	160.75 (4083)	27.05 (687)	133.71 (3396)	5.50 (140)	5.50 (140)	246.1
35S200-60DS	1329	3	208	20	▲	3494	171.19 (4348)	29.61 (752)	141.58 (3596)	5.50 (140)	5.50 (140)	269.2
	1329	3	230	20	▲	3494	171.19 (4348)	29.61 (752)	141.58 (3596)	5.50 (140)	5.50 (140)	269.2
	1337	3	460	20	▲	3503	171.19 (4348)	29.61 (752)	141.58 (3596)	5.50 (140)	5.50 (140)	269.2
	1338	3	575	20	▲	3506	171.19 (4348)	29.61 (752)	141.58 (3596)	5.50 (140)	5.50 (140)	269.2
35S200-64DS	1412	3	208	20	▲	3486	179.06 (4548)	29.61 (752)	149.45 (3796)	5.50 (140)	5.50 (140)	276.9
	1412	3	230	20	▲	3486	179.06 (4548)	29.61 (752)	149.45 (3796)	5.50 (140)	5.50 (140)	276.9
	1420	3	460	20	▲	3497	179.06 (4548)	29.61 (752)	149.45 (3796)	5.50 (140)	5.50 (140)	276.9
	1422	3	575	20	▲	3499	179.06 (4548)	29.61 (752)	149.45 (3796)	5.50 (140)	5.50 (140)	276.9
35S200-67DS	1473	3	208	20	▲	3491	184.97 (4698)	29.61 (752)	155.36 (3946)	5.50 (140)	5.50 (140)	282.7
	1473	3	230	20	▲	3491	184.97 (4698)	29.61 (752)	155.36 (3946)	5.50 (140)	5.50 (140)	282.7
	1482	3	460	20	▲	3480	184.97 (4698)	29.61 (752)	155.36 (3946)	5.50 (140)	5.50 (140)	282.7
	1485	3	575	20	▲	3494	184.97 (4698)	29.61 (752)	155.36 (3946)	5.50 (140)	5.50 (140)	282.7

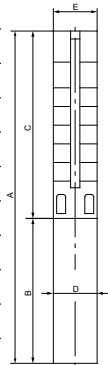

E = Maximum diameter of pump including cable guard and motor

Notes:

DS designation = Built into sleeve, 2" NPT, 6" minimum well diameter.

Performance conforms to ISO 9906. 1999 (E) Annex A. Minimum submergence is 5 ft (1.5 m).

▲ MS6000C motor

## SP 45S (45 gpm)

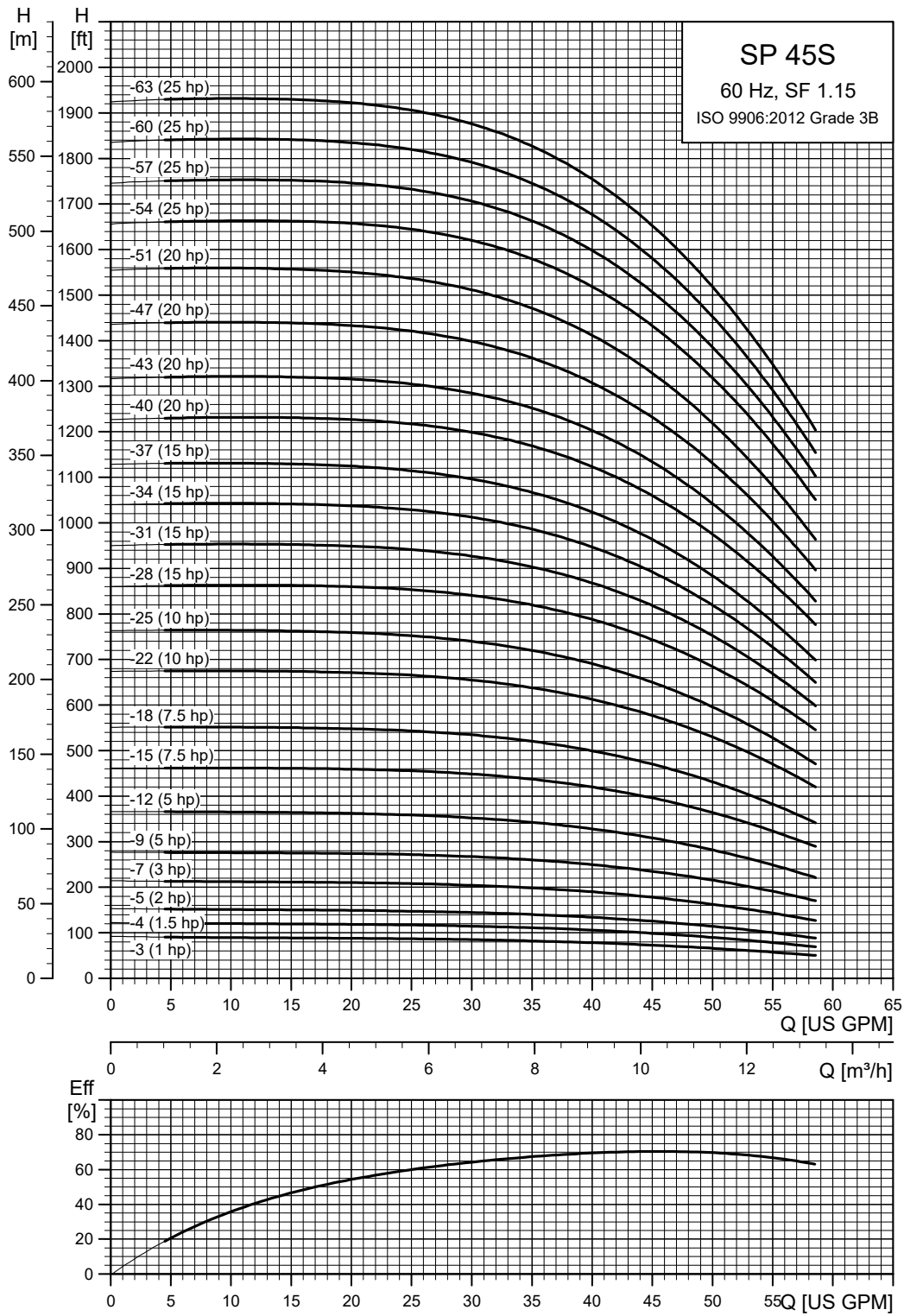

TM064616

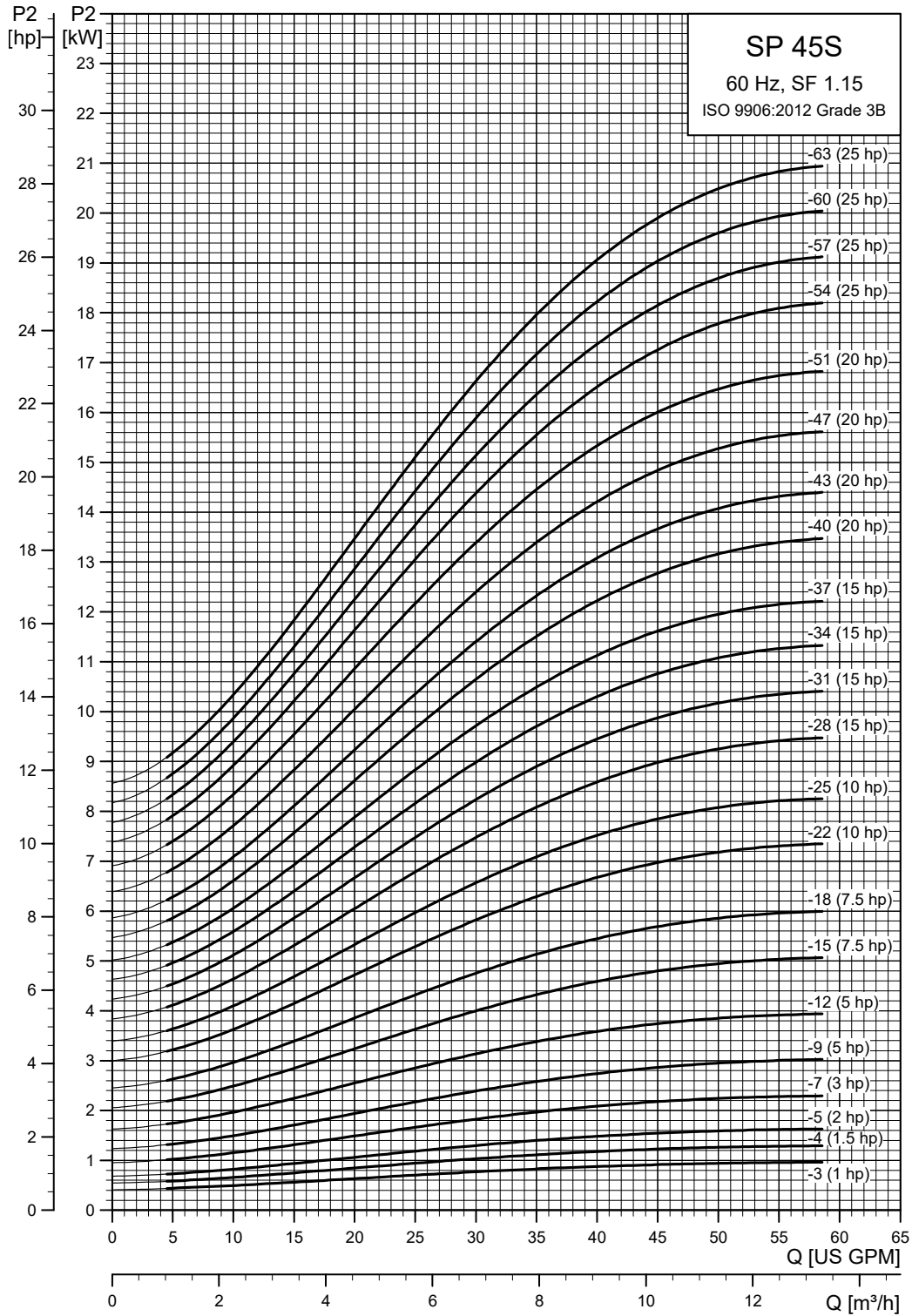

TM064617

## SP 45S (45 gpm) pump with 4" motor

Pump model	Nom. head [ft]	Motor				Dimensions [in (mm)]					Net weight (complete) [lb]	45S
		Ph	Volts [V]	[Hp]	[rpm]	A	B	C	D	E		
<b>45S - Motor diameter 4-inch, 3-wire motor, 60 Hz, rated flow rate 45 gpm (2" NPT)</b>												
45S10-3	72	1	230	1	■	3416	28.94 (735)	13.67 (347)	15.28 (388)	3.75 (95)	3.98 (101)	31.5
	73	3	230	1	■	3435	27.76 (705)	12.49 (317)	15.28 (388)	3.75 (95)	3.98 (101)	28.8
	73	3	460	1	■	3435	27.76 (705)	12.49 (317)	15.28 (388)	3.75 (95)	3.98 (101)	28.6
45S15-4	72	3	575	1	■	3422	27.76 (705)	12.49 (317)	15.28 (388)	3.75 (95)	3.98 (101)	28.6
	98	1	230	1.5	■	3451	32.49 (825)	15.24 (387)	17.25 (438)	3.75 (95)	3.98 (101)	36.5
	99	3	230	1.5	■	3458	30.91 (785)	13.67 (347)	17.25 (438)	3.75 (95)	3.98 (101)	33.0
45S20-5	99	3	460	1.5	■	3458	30.91 (785)	13.67 (347)	17.25 (438)	3.75 (95)	3.98 (101)	33.0
	97	3	575	1.5	■	3435	30.91 (785)	13.67 (347)	17.25 (438)	3.75 (95)	3.98 (101)	32.8
	124	1	230	2	●	3454	38.78 (985)	19.57 (497)	19.22 (488)	3.75 (95)	3.98 (101)	53.4
45S30-7	124	3	230	2	■	3451	34.45 (875)	15.24 (387)	19.22 (488)	3.75 (95)	3.98 (101)	38.0
	124	3	460	2	■	3451	34.45 (875)	15.24 (387)	19.22 (488)	3.75 (95)	3.98 (101)	38.2
	123	3	575	2	■	3446	34.45 (875)	15.24 (387)	19.22 (488)	3.75 (95)	3.98 (101)	38.0
45S30-7	174	1	230	3	●	3448	45.87 (1165)	22.72 (577)	23.15 (588)	3.75 (95)	3.98 (101)	64.8
	174	3	208	3	●	3452	41.15 (1045)	18.00 (457)	23.15 (588)	3.75 (95)	3.98 (101)	51.6
	174	3	230	3	●	3452	41.15 (1045)	18.00 (457)	23.15 (588)	3.75 (95)	3.98 (101)	51.6
45S50-9	178	3	460	3	●	3481	41.15 (1045)	18.00 (457)	23.15 (588)	3.75 (95)	3.98 (101)	51.6
	185	3	575	3	●	3530	41.15 (1045)	18.00 (457)	23.15 (588)	3.75 (95)	3.98 (101)	51.4
	232	1	230	5	●	3502	53.75 (1365)	26.66 (677)	27.09 (688)	3.75 (95)	3.98 (101)	78.4
45S50-12	234	3	208	5	●	3517	49.81 (1265)	22.72 (577)	27.09 (688)	3.75 (95)	3.98 (101)	67.4
	234	3	230	5	●	3517	49.81 (1265)	22.72 (577)	27.09 (688)	3.75 (95)	3.98 (101)	67.4
	234	3	460	5	●	3516	49.81 (1265)	22.72 (577)	27.09 (688)	3.75 (95)	3.98 (101)	67.4
45S50-12	237	3	575	5	●	3515	49.81 (1265)	22.72 (577)	27.09 (688)	3.75 (95)	3.98 (101)	67.2
	301	1	230	5	●	3462	59.65 (1515)	26.66 (677)	33.00 (838)	3.75 (95)	3.98 (101)	82.2
	306	3	208	5	●	3486	55.71 (1415)	22.72 (577)	33.00 (838)	3.75 (95)	3.98 (101)	71.2
45S75-15	306	3	230	5	●	3486	55.71 (1415)	22.72 (577)	33.00 (838)	3.75 (95)	3.98 (101)	71.2
	306	3	460	5	●	3483	55.71 (1415)	22.72 (577)	33.00 (838)	3.75 (95)	3.98 (101)	71.2
	308	3	575	5	●	3485	55.71 (1415)	22.72 (577)	33.00 (838)	3.75 (95)	3.98 (101)	71.0
45S75-18	386	3	208	7.5	●	3497	65.56 (1665)	26.66 (677)	38.90 (988)	3.75 (95)	3.98 (101)	86.1
	386	3	230	7.5	●	3497	65.56 (1665)	26.66 (677)	38.90 (988)	3.75 (95)	3.98 (101)	86.1
	386	3	460	7.5	●	3497	65.56 (1665)	26.66 (677)	38.90 (988)	3.75 (95)	3.98 (101)	86.1
45S100-22	386	3	575	7.5	●	3497	65.56 (1665)	26.66 (677)	38.90 (988)	3.75 (95)	3.98 (101)	86.1
	458	3	208	7.5	●	3474	71.46 (1815)	26.66 (677)	44.81 (1138)	3.75 (95)	3.98 (101)	89.9
	458	3	230	7.5	●	3474	71.46 (1815)	26.66 (677)	44.81 (1138)	3.75 (95)	3.98 (101)	89.9
45S100-25	458	3	460	7.5	●	3474	71.46 (1815)	26.66 (677)	44.81 (1138)	3.75 (95)	3.98 (101)	89.9
	458	3	575	7.5	●	3474	71.46 (1815)	26.66 (677)	44.81 (1138)	3.75 (95)	3.98 (101)	89.9
	564	3	460	10	●	3484	83.27 (2115)	30.60 (777)	52.68 (1338)	3.75 (95)	3.98 (101)	103.8
45S100-25	564	3	575	10	●	3484	83.27 (2115)	30.60 (777)	52.68 (1338)	3.75 (95)	3.98 (101)	103.8
	632	3	460	10	●	3466	89.18 (2265)	30.60 (777)	58.59 (1488)	3.75 (95)	3.98 (101)	107.7
45S100-25	632	3	575	10	●	3466	89.18 (2265)	30.60 (777)	58.59 (1488)	3.75 (95)	3.98 (101)	107.7

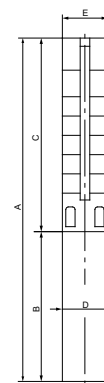

E = Maximum diameter of pump including cable guard and motor

**Notes:**

Control box is required for 3-wire, single-phase applications. Data does not include control box.

Performance conforms to ISO 9906. 1999 (E) Annex A. Minimum submergence is 5 ft (1.5 m).

- MS402 motor
- MS4000C motor

**SP 45S (45 gpm) pump with 6" motor**

Pump model	Nom. head [ft]	Ph	Motor			Dimensions [in (mm)]					Net weight (complete) [lb]	45S
			Volts [V]	[Hp]	[rpm]	A	B	C	D	E		
<b>45S - Motor diameter 6 inch, 60 Hz, rated flow rate 45 gpm (2" NPT)</b>												
45S75-15	388	3	208	7.5 ▲	3504	64.89 (1648)	23.51 (597)	41.38 (1051)	5.50 (140)	5.50 (140)	114.4	
	388	3	230	7.5 ▲	3504	64.89 (1648)	23.51 (597)	41.38 (1051)	5.50 (140)	5.50 (140)	114.4	
	390	3	460	7.5 ▲	3512	64.89 (1648)	23.51 (597)	41.38 (1051)	5.50 (140)	5.50 (140)	114.4	
	390	3	575	7.5 ▲	3511	64.89 (1648)	23.51 (597)	41.38 (1051)	5.50 (140)	5.50 (140)	114.4	
45S75-18	460	3	208	7.5 ▲	3482	70.79 (1798)	23.51 (597)	47.29 (1201)	5.50 (140)	5.50 (140)	118.3	
	460	3	230	7.5 ▲	3482	70.79 (1798)	23.51 (597)	47.29 (1201)	5.50 (140)	5.50 (140)	118.3	
	463	3	460	7.5 ▲	3493	70.79 (1798)	23.51 (597)	47.29 (1201)	5.50 (140)	5.50 (140)	118.3	
	462	3	575	7.5 ▲	3492	70.79 (1798)	23.51 (597)	47.29 (1201)	5.50 (140)	5.50 (140)	118.3	
45S100-22	564	3	208	10 ▲	3485	79.85 (2028)	24.69 (627)	55.16 (1401)	5.50 (140)	5.50 (140)	130.2	
	564	3	230	10 ▲	3485	79.85 (2028)	24.69 (627)	55.16 (1401)	5.50 (140)	5.50 (140)	130.2	
	568	3	460	10 ▲	3496	79.85 (2028)	24.69 (627)	55.16 (1401)	5.50 (140)	5.50 (140)	130.2	
	568	3	575	10 ▲	3496	79.85 (2028)	24.69 (627)	55.16 (1401)	5.50 (140)	5.50 (140)	130.2	
45S100-25	632	3	208	10 ▲	3467	85.75 (2178)	24.69 (627)	61.07 (1551)	5.50 (140)	5.50 (140)	134.1	
	632	3	230	10 ▲	3467	85.75 (2178)	24.69 (627)	61.07 (1551)	5.50 (140)	5.50 (140)	134.1	
	640	3	460	10 ▲	3481	85.75 (2178)	24.69 (627)	61.07 (1551)	5.50 (140)	5.50 (140)	134.1	
	640	3	575	10 ▲	3480	85.75 (2178)	24.69 (627)	61.07 (1551)	5.50 (140)	5.50 (140)	134.1	
45S150-28	727	3	208	15 ▲	3505	94.02 (2388)	27.05 (687)	66.97 (1701)	5.50 (140)	5.50 (140)	160.6	
	727	3	230	15 ▲	3505	94.02 (2388)	27.05 (687)	66.97 (1701)	5.50 (140)	5.50 (140)	160.6	
	729	3	460	15 ▲	3508	94.02 (2388)	27.05 (687)	66.97 (1701)	5.50 (140)	5.50 (140)	160.6	
	728	3	575	15 ▲	3507	94.02 (2388)	27.05 (687)	66.97 (1701)	5.50 (140)	5.50 (140)	160.6	
45S150-31	801	3	208	15 ▲	3494	99.93 (2538)	27.05 (687)	72.88 (1851)	5.50 (140)	5.50 (140)	164.7	
	801	3	230	15 ▲	3494	99.93 (2538)	27.05 (687)	72.88 (1851)	5.50 (140)	5.50 (140)	164.7	
	803	3	460	15 ▲	3498	99.93 (2538)	27.05 (687)	72.88 (1851)	5.50 (140)	5.50 (140)	164.7	
	802	3	575	15 ▲	3497	99.93 (2538)	27.05 (687)	72.88 (1851)	5.50 (140)	5.50 (140)	164.7	
45S150-34	869	3	208	15 ▲	3482	105.83 (2688)	27.05 (687)	78.78 (2001)	5.50 (140)	5.50 (140)	168.8	
	869	3	230	15 ▲	3482	105.83 (2688)	27.05 (687)	78.78 (2001)	5.50 (140)	5.50 (140)	168.8	
	876	3	460	15 ▲	3487	105.83 (2688)	27.05 (687)	78.78 (2001)	5.50 (140)	5.50 (140)	168.8	
	875	3	575	15 ▲	3486	105.83 (2688)	27.05 (687)	78.78 (2001)	5.50 (140)	5.50 (140)	168.8	
45S150-37	939	3	208	15 ▲	3470	111.74 (2838)	27.05 (687)	84.69 (2151)	5.50 (140)	5.50 (140)	172.9	
	939	3	230	15 ▲	3470	111.74 (2838)	27.05 (687)	84.69 (2151)	5.50 (140)	5.50 (140)	172.9	
	942	3	460	15 ▲	3476	111.74 (2838)	27.05 (687)	84.69 (2151)	5.50 (140)	5.50 (140)	172.9	
	941	3	575	15 ▲	3474	111.74 (2838)	27.05 (687)	84.69 (2151)	5.50 (140)	5.50 (140)	172.9	

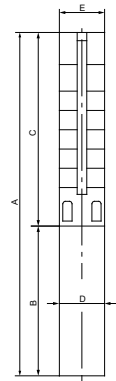

E = Maximum diameter of pump including cable guard and motor

**Notes:**

Performance conforms to ISO 9906. 1999 (E) Annex A. Minimum submergence is 5 ft (1.5 m).

▲ MS6000C motor

## SP 45S (45 gpm) pump with 6" motor, continued

Pump model	Nom. head [ft]	Motor				Dimensions [in (mm)]					Net weight (complete) [lb]	45S
		Ph	Volts [V]	[Hp]	[rpm]	A	B	C	D	E		
<b>45S - Motor diameter 6 inch, 60 Hz, rated flow rate 45 gpm (2" NPT)</b>												
45S200-40DS	1037	3	208	20	▲	3498	131.82 (3348)	29.61 (752)	102.21 (2596)	5.50 (140)	5.50 (140)	230.8
	1037	3	230	20	▲	3498	131.82 (3348)	29.61 (752)	102.21 (2596)	5.50 (140)	5.50 (140)	230.8
	1043	3	460	20	▲	3507	131.82 (3348)	29.61 (752)	102.21 (2596)	5.50 (140)	5.50 (140)	230.8
	1044	3	575	20	▲	3509	131.82 (3348)	29.61 (752)	102.21 (2596)	5.50 (140)	5.50 (140)	230.8
45S200-43DS	1105	3	208	20	▲	3489	137.72 (3498)	29.61 (752)	108.12 (2746)	5.50 (140)	5.50 (140)	236.6
	1105	3	230	20	▲	3489	137.72 (3498)	29.61 (752)	108.12 (2746)	5.50 (140)	5.50 (140)	236.6
	1117	3	460	20	▲	3500	137.72 (3498)	29.61 (752)	108.12 (2746)	5.50 (140)	5.50 (140)	236.6
	1118	3	575	20	▲	3502	137.72 (3498)	29.61 (752)	108.12 (2746)	5.50 (140)	5.50 (140)	236.6
45S200-47DS	1199	3	208	20	▲	3478	145.60 (3698)	29.61 (752)	115.99 (2946)	5.50 (140)	5.50 (140)	244.2
	1208	3	230	20	▲	3489	145.60 (3698)	29.61 (752)	115.99 (2946)	5.50 (140)	5.50 (140)	244.2
	1208	3	460	20	▲	3489	145.60 (3698)	29.61 (752)	115.99 (2946)	5.50 (140)	5.50 (140)	244.2
	1216	3	575	20	▲	3492	145.60 (3698)	29.61 (752)	115.99 (2946)	5.50 (140)	5.50 (140)	244.2
45S200-51DS	1291	3	208	20	▲	3466	153.47 (3898)	29.61 (752)	123.86 (3146)	5.50 (140)	5.50 (140)	251.9
	1291	3	230	20	▲	3466	153.47 (3898)	29.61 (752)	123.86 (3146)	5.50 (140)	5.50 (140)	251.9
	1392	3	460	20	▲	3479	153.47 (3898)	29.61 (752)	123.86 (3146)	5.50 (140)	5.50 (140)	251.9
	1302	3	575	20	▲	3482	153.47 (3898)	29.61 (752)	123.86 (3146)	5.50 (140)	5.50 (140)	251.9
45S250-54DS	1389	3	208	25	▲	3490	161.54 (4103)	31.78 (807)	129.77 (3296)	5.50 (140)	5.50 (140)	267.6
	1389	3	230	25	▲	3490	161.54 (4103)	31.78 (807)	129.77 (3296)	5.50 (140)	5.50 (140)	267.6
	1404	3	460	25	▲	3501	161.54 (4103)	31.78 (807)	129.77 (3296)	5.50 (140)	5.50 (140)	267.6
	1405	3	575	25	▲	3501	161.54 (4103)	31.78 (807)	129.77 (3296)	5.50 (140)	5.50 (140)	267.6
45S250-57DS	1460	3	208	25	▲	3484	167.45 (4253)	31.78 (807)	135.67 (3446)	5.50 (140)	5.50 (140)	273.4
	1460	3	230	25	▲	3484	167.45 (4253)	31.78 (807)	135.67 (3446)	5.50 (140)	5.50 (140)	273.4
	1471	3	460	25	▲	3494	167.45 (4253)	31.78 (807)	135.67 (3446)	5.50 (140)	5.50 (140)	273.4
	1471	3	575	25	▲	3495	167.45 (4253)	31.78 (807)	135.67 (3446)	5.50 (140)	5.50 (140)	273.4
45S250-60DS	1530	3	208	25	▲	3477	173.35 (4403)	31.78 (807)	141.58 (3596)	5.50 (140)	5.50 (140)	279.1
	1530	3	230	25	▲	3477	173.35 (4403)	31.78 (807)	141.58 (3596)	5.50 (140)	5.50 (140)	279.1
	1542	3	460	25	▲	3488	173.35 (4403)	31.78 (807)	141.58 (3596)	5.50 (140)	5.50 (140)	279.1
	1543	3	575	25	▲	3489	173.35 (4403)	31.78 (807)	141.58 (3596)	5.50 (140)	5.50 (140)	279.1
45S250-63DS	1599	3	208	25	▲	3470	167.64 (4258)	31.78 (807)	135.87 (3451)	5.50 (140)	5.50 (140)	233.7
	1599	3	230	25	▲	3470	167.64 (4258)	31.78 (807)	135.87 (3451)	5.50 (140)	5.50 (140)	233.7
	1612	3	460	25	▲	3482	167.64 (4258)	31.78 (807)	135.87 (3451)	5.50 (140)	5.50 (140)	233.7
	1613	3	575	25	▲	3483	167.64 (4258)	31.78 (807)	135.87 (3451)	5.50 (140)	5.50 (140)	233.7

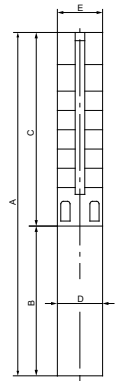

E = Maximum diameter of pump including cable guard and motor

**Notes:**

DS designation = Built into sleeve, 2" NPT, 6" minimum well diameter.

Performance conforms to ISO 9906. 1999 (E) Annex A. Minimum submergence is 5 ft (1.5 m).

▲ MS6000C motor

**SP 62S (62 gpm)**

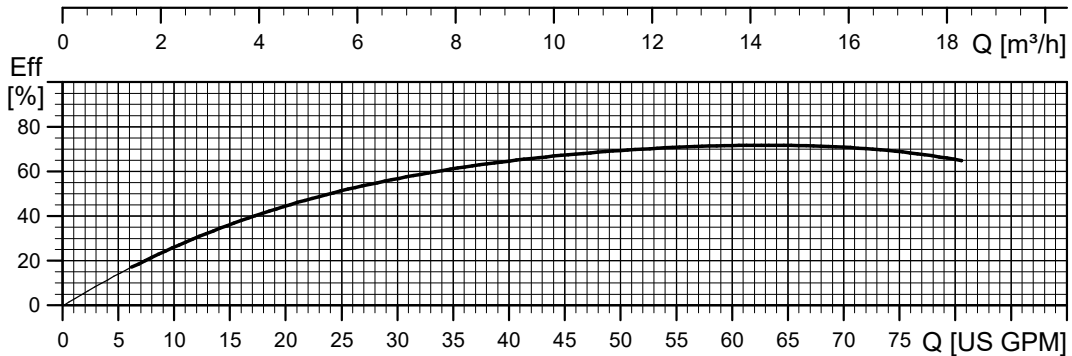
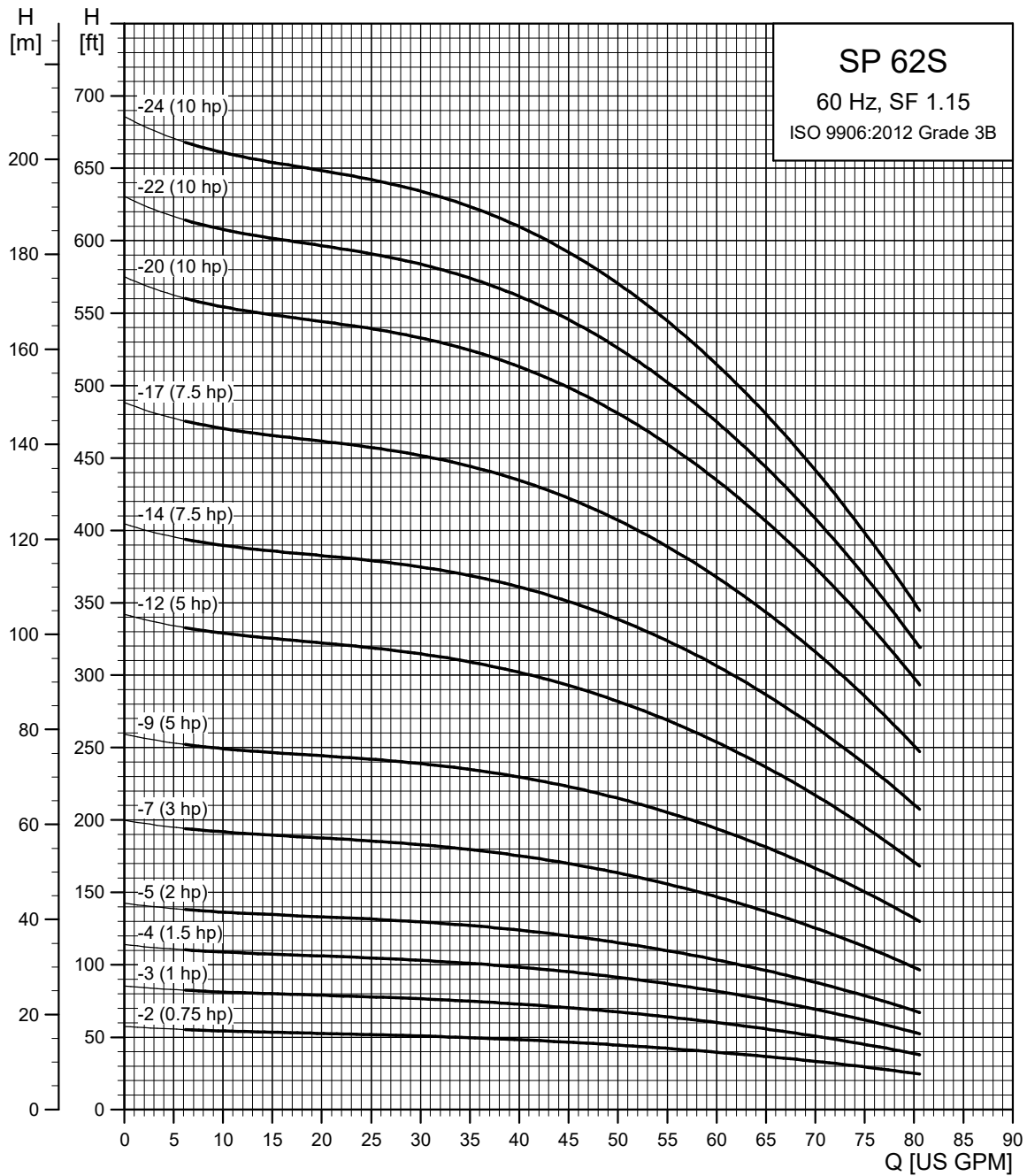

TM064618

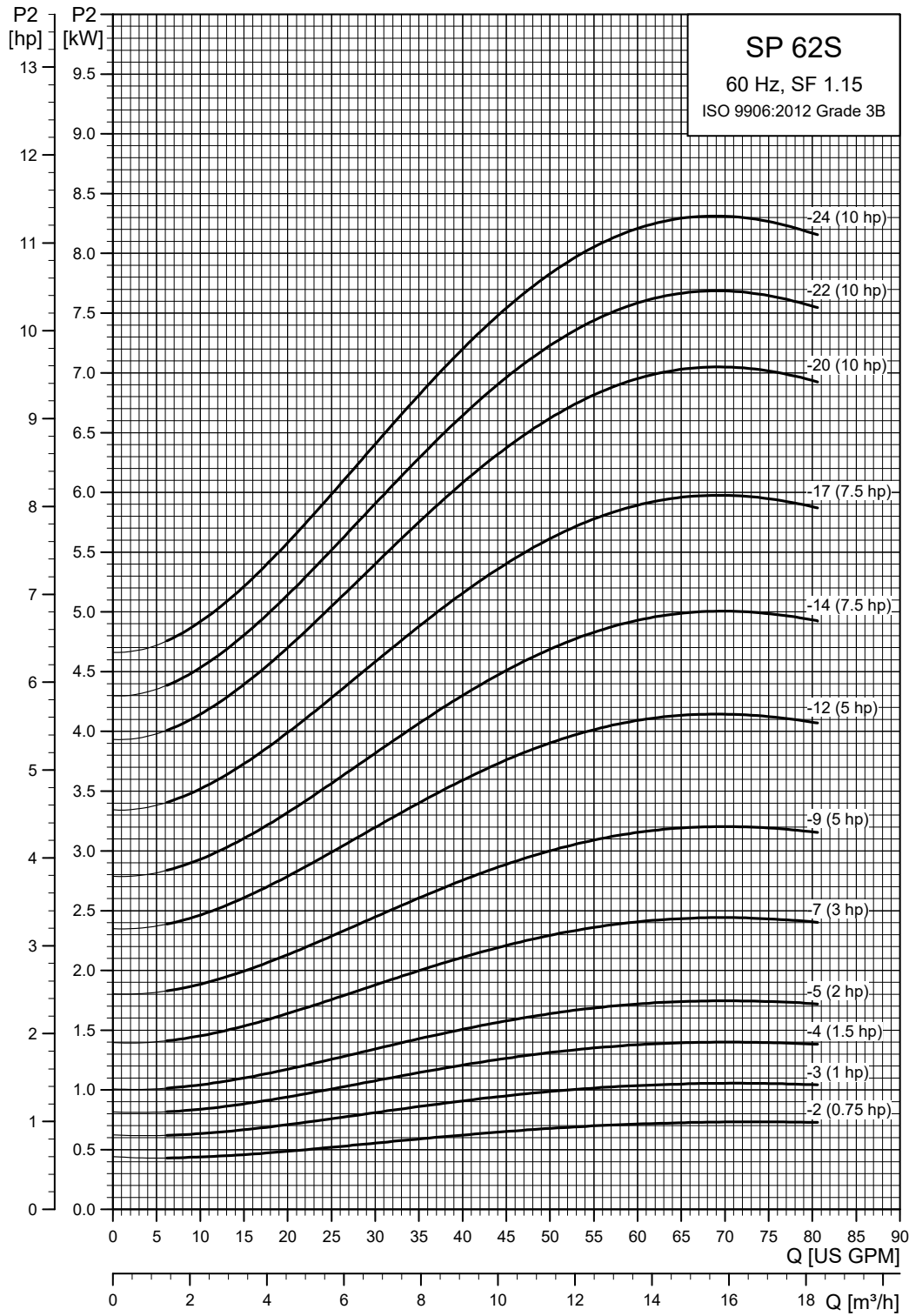

TM064619



**SP 62S (62 gpm) pump with 4" motor**

Pump model	Nom. head [ft]	Ph	Motor			Dimensions [in (mm)]					Net weight (complete) [lb]	62S
			Volts [V]	[Hp]	[rpm]	A	B	C	D	E		
<b>62S - Motor diameter 4-inch, 3-wire motor, 60 Hz, rated flow rate 62 gpm (2" NPT)</b>												
62S07-2	40	1	230	.75	■	3407	28.35 (720)	13.08 (332)	15.28 (388)	3.75 (95)	3.98 (101)	29.7
	40	3	230	.75	■	3423	26.97 (685)	11.70 (297)	15.28 (388)	3.75 (95)	3.98 (101)	26.7
	40	3	460	.75	■	3423	26.97 (685)	11.70 (297)	15.28 (388)	3.75 (95)	3.98 (101)	26.7
	40	3	575	.75	■	3414	26.97 (685)	11.70 (297)	15.28 (388)	3.75 (95)	3.98 (101)	26.7
62S10-3	57	1	230	1	■	3381	31.89 (810)	13.67 (347)	18.23 (463)	3.75 (95)	3.98 (101)	33.0
	58	3	230	1	■	3407	30.71 (780)	12.49 (317)	18.23 (463)	3.75 (95)	3.98 (101)	30.4
	58	3	460	1	■	3407	30.71 (780)	12.49 (317)	18.23 (463)	3.75 (95)	3.98 (101)	30.2
	57	3	575	1	■	3398	30.71 (780)	12.49 (317)	18.23 (463)	3.75 (95)	3.98 (101)	30.2
62S15-4	78	1	230	1.5	■	3427	36.42 (925)	15.24 (387)	21.19 (538)	3.75 (95)	3.98 (101)	38.5
	79	3	230	1.5	■	3439	34.85 (885)	13.67 (347)	21.19 (538)	3.75 (95)	3.98 (101)	35.0
	79	3	460	1.5	■	3439	34.85 (885)	13.67 (347)	21.19 (538)	3.75 (95)	3.98 (101)	35.0
	78	3	575	1.5	■	3415	34.85 (885)	13.67 (347)	21.19 (538)	3.75 (95)	3.98 (101)	34.8
62S20-5	98	1	230	2	●	3433	43.71 (1110)	19.57 (497)	24.14 (613)	3.75 (95)	3.98 (101)	56.0
	98	3	230	2	■	3431	39.38 (1000)	15.24 (387)	24.14 (613)	3.75 (95)	3.98 (101)	40.5
	98	3	460	2	■	3431	39.38 (1000)	15.24 (387)	24.14 (613)	3.75 (95)	3.98 (101)	40.7
	98	3	575	2	■	3430	39.38 (1000)	15.24 (387)	24.14 (613)	3.75 (95)	3.98 (101)	40.5
62S30-7	136	1	230	3	●	3427	52.76 (1340)	22.72 (577)	30.04 (763)	3.75 (95)	3.98 (101)	68.3
	138	3	208	3	●	3437	48.04 (1220)	18.00 (457)	30.04 (763)	3.75 (95)	3.98 (101)	55.1
	138	3	230	3	●	3437	48.04 (1220)	18.00 (457)	30.04 (763)	3.75 (95)	3.98 (101)	55.1
	141	3	460	3	●	3466	48.04 (1220)	18.00 (457)	30.04 (763)	3.75 (95)	3.98 (101)	55.1
62S50-9	184	1	230	5	●	3490	62.60 (1590)	26.66 (677)	35.95 (913)	3.75 (95)	3.98 (101)	82.8
	186	3	208	5	●	3507	58.67 (1490)	22.72 (577)	35.95 (913)	3.75 (95)	3.98 (101)	71.8
	186	3	230	5	●	3507	58.67 (1490)	22.72 (577)	35.95 (913)	3.75 (95)	3.98 (101)	71.8
	186	3	460	5	●	3506	58.67 (1490)	22.72 (577)	35.95 (913)	3.75 (95)	3.98 (101)	71.8
62S50-12	242	3	575	5	●	3470	58.67 (1490)	22.72 (577)	35.95 (913)	3.75 (95)	3.98 (101)	71.6
	237	1	230	5	●	3446	71.46 (1815)	26.66 (677)	44.81 (1138)	3.75 (95)	3.98 (101)	88.1
	242	3	208	5	●	3473	67.52 (1715)	22.72 (577)	44.81 (1138)	3.75 (95)	3.98 (101)	77.1
	242	3	230	5	●	3473	67.52 (1715)	22.72 (577)	44.81 (1138)	3.75 (95)	3.98 (101)	77.1
62S50-12	242	3	460	5	●	3471	67.52 (1715)	22.72 (577)	44.81 (1138)	3.75 (95)	3.98 (101)	77.1
	244	3	575	5	●	3470	67.52 (1715)	22.72 (577)	44.81 (1138)	3.75 (95)	3.98 (101)	76.9

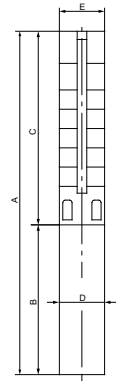

E = Maximum diameter of pump including cable guard and motor

**Notes:**

Control box is required for 3-wire, single-phase applications. Data does not include control box. Performance conforms to ISO 9906. 1999 (E) Annex A. Minimum submergence is 5 ft (1.5 m).

- MS402 motor
- MS4000C motor

SP 62S (62 gpm) pump with 4" motor, continued

Pump model	Nom. head [ft]	Motor				Dimensions [in (mm)]					Net weight (complete) [lb]	62S	
		Ph	Volts [V]	[Hp]	[rpm]	A	B	C	D	E			
<b>62S - Motor diameter 4-inch, 3-wire motor, 60 Hz, rated flow rate 62 gpm (2" NPT)</b>													
62S75-14	287	3	208	7.5	●	3494	77.37 (1965)	26.66 (677)	50.71 (1288)	3.75 (95)	3.98 (101)	91.6	
	287	3	230	7.5	●	3494	77.37 (1965)	26.66 (677)	50.71 (1288)	3.75 (95)	3.98 (101)	91.6	
	287	3	460	7.5	●	3494	77.37 (1965)	26.66 (677)	50.71 (1288)	3.75 (95)	3.98 (101)	91.6	
	287	3	575	7.5	●	3494	77.37 (1965)	26.66 (677)	50.71 (1288)	3.75 (95)	3.98 (101)	91.6	
62S75-17	342	3	208	7.5	●	3469	86.23 (2190)	26.66 (677)	59.57 (1513)	3.75 (95)	3.98 (101)	96.9	
	342	3	230	7.5	●	3469	86.23 (2190)	26.66 (677)	59.57 (1513)	3.75 (95)	3.98 (101)	96.9	
	342	3	460	7.5	●	3469	86.23 (2190)	26.66 (677)	59.57 (1513)	3.75 (95)	3.98 (101)	96.9	
	342	3	575	7.5	●	3469	86.23 (2190)	26.66 (677)	59.57 (1513)	3.75 (95)	3.98 (101)	96.9	
62S100-20	407	3	460	10	●	3485	99.02 (2515)	30.60 (777)	68.43 (1738)	3.75 (95)	3.98 (101)	111.0	
	407	3	575	10	●	3485	99.02 (2515)	30.60 (777)	68.43 (1738)	3.75 (95)	3.98 (101)	111.0	
62S100-22	445	3	460	10	●	3472	104.93 (2665)	30.60 (777)	74.34 (1888)	3.75 (95)	3.98 (101)	114.5	
	445	3	575	10	●	3472	104.93 (2665)	30.60 (777)	74.34 (1888)	3.75 (95)	3.98 (101)	114.5	
62S100-24	478	3	460	10	●	3460	110.83 (2815)	30.60 (777)	80.24 (2038)	3.75 (95)	3.98 (101)	118.0	
	478	3	575	10	●	3460	110.83 (2815)	30.60 (777)	80.24 (2038)	3.75 (95)	3.98 (101)	118.0	

Notes:

Control box is required for 3-wire, single-phase applications. Data does not include control box. Performance conforms to ISO 9906. 1999 (E) Annex A. Minimum submergence is 5 ft (1.5 m).

■	MS402 motor
●	MS4000C motor

**SP 62S (62 gpm) pump with 6" motor**

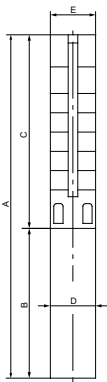
Pump model	Nom. head [ft]	Motor				Dimensions [in (mm)]					Net weight (complete) [lb]	62S
		Ph	Volts [V]	[Hp]	[rpm]	A	B	C	D	E		
<b>62S - Motor diameter 6 inch, 60 Hz, rated flow rate 62 gpm (2" NPT)</b>												
62S75-14	288	3	208	7.5 ▲	3501	76.70 (1948)	23.51 (597)	53.19 (1351)	5.50 (140)	5.50 (140)	119.3	 <p>E = Maximum diameter of pump including cable guard and motor</p>
	288	3	230	7.5 ▲	3501	76.70 (1948)	23.51 (597)	53.19 (1351)	5.50 (140)	5.50 (140)	119.3	
	292	3	460	7.5 ▲	3510	76.70 (1948)	23.51 (597)	53.19 (1351)	5.50 (140)	5.50 (140)	119.3	
	291	3	575	7.5 ▲	3509	76.70 (1948)	23.51 (597)	53.19 (1351)	5.50 (140)	5.50 (140)	119.3	
62S75-17	344	3	208	7.5 ▲	3478	85.56 (2173)	23.51 (597)	62.05 (1576)	5.50 (140)	5.50 (140)	124.6	
	344	3	230	7.5 ▲	3478	85.56 (2173)	23.51 (597)	62.05 (1576)	5.50 (140)	5.50 (140)	124.6	
	347	3	460	7.5 ▲	3489	85.56 (2173)	23.51 (597)	62.05 (1576)	5.50 (140)	5.50 (140)	124.6	
	347	3	575	7.5 ▲	3488	85.56 (2173)	23.51 (597)	62.05 (1576)	5.50 (140)	5.50 (140)	124.6	
62S100-20	408	3	208	10 ▲	3486	95.60 (2428)	24.69 (627)	70.91 (1801)	5.50 (140)	5.50 (140)	136.4	
	408	3	230	10 ▲	3486	95.60 (2428)	24.69 (627)	70.91 (1801)	5.50 (140)	5.50 (140)	136.4	
	411	3	460	10 ▲	3497	95.60 (2428)	24.69 (627)	70.91 (1801)	5.50 (140)	5.50 (140)	136.4	
	410	3	575	10 ▲	3496	95.60 (2428)	24.69 (627)	70.91 (1801)	5.50 (140)	5.50 (140)	136.4	
62S100-22	445	3	208	10 ▲	3474	101.50 (2578)	24.69 (627)	76.82 (1951)	5.50 (140)	5.50 (140)	139.9	
	445	3	230	10 ▲	3474	101.50 (2578)	24.69 (627)	76.82 (1951)	5.50 (140)	5.50 (140)	139.9	
	449	3	460	10 ▲	3486	101.50 (2578)	24.69 (627)	76.82 (1951)	5.50 (140)	5.50 (140)	139.9	
	448	3	575	10 ▲	3485	101.50 (2578)	24.69 (627)	76.82 (1951)	5.50 (140)	5.50 (140)	139.9	
62S100-24	478	3	208	10 ▲	3460	107.41 (2728)	24.69 (627)	82.72 (2101)	5.50 (140)	5.50 (140)	143.4	
	478	3	230	10 ▲	3460	107.41 (2728)	24.69 (627)	82.72 (2101)	5.50 (140)	5.50 (140)	143.4	
	486	3	460	10 ▲	3474	107.41 (2728)	24.69 (627)	82.72 (2101)	5.50 (140)	5.50 (140)	143.4	
	486	3	575	10 ▲	3473	107.41 (2728)	24.69 (627)	82.72 (2101)	5.50 (140)	5.50 (140)	143.4	

**Notes:**

Performance conforms to ISO 9906. 1999 (E) Annex A. Minimum submergence is 5 ft (1.5 m).

▲ MS6000C motor

## SP 77S (77 gpm)

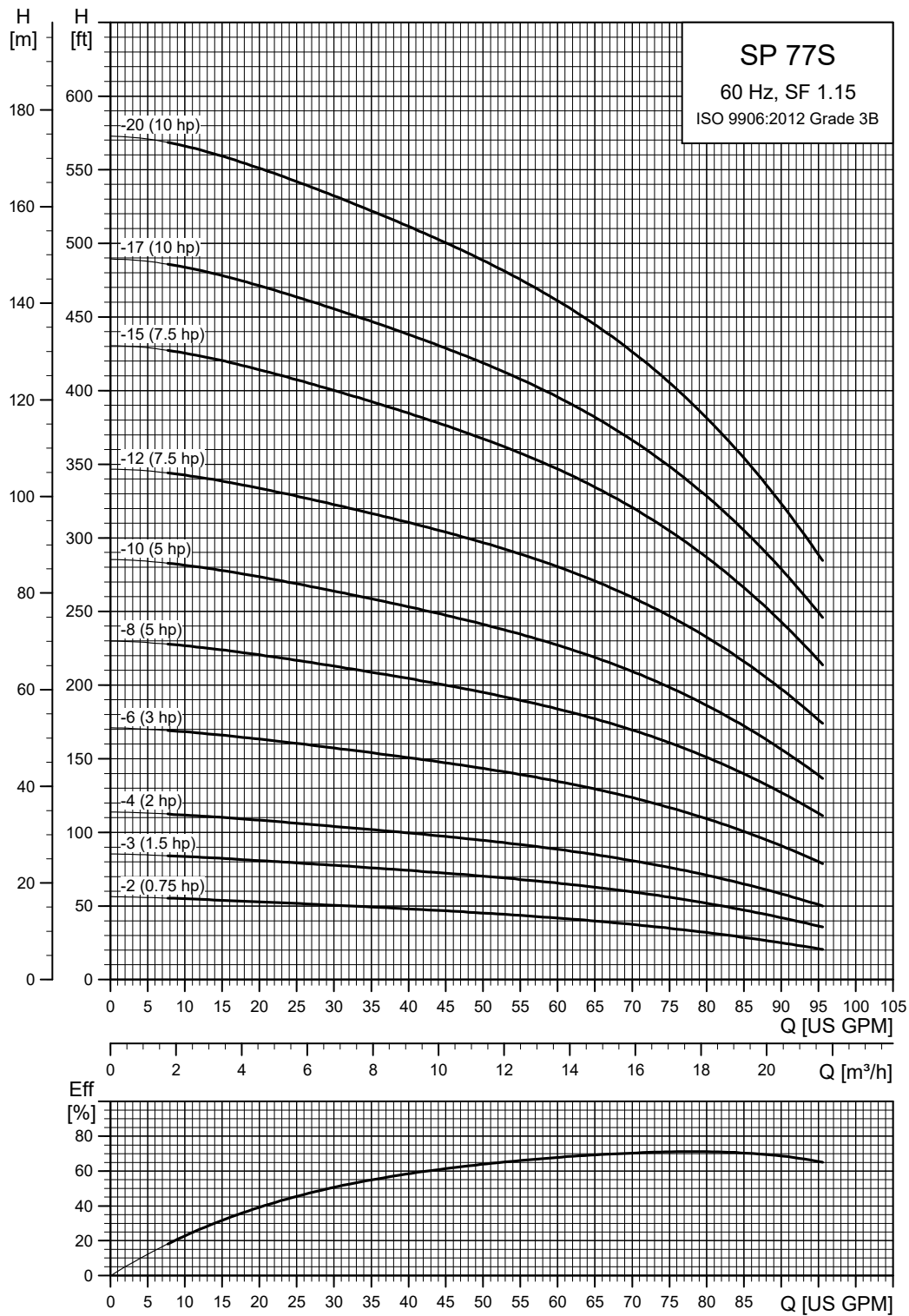

TM064620

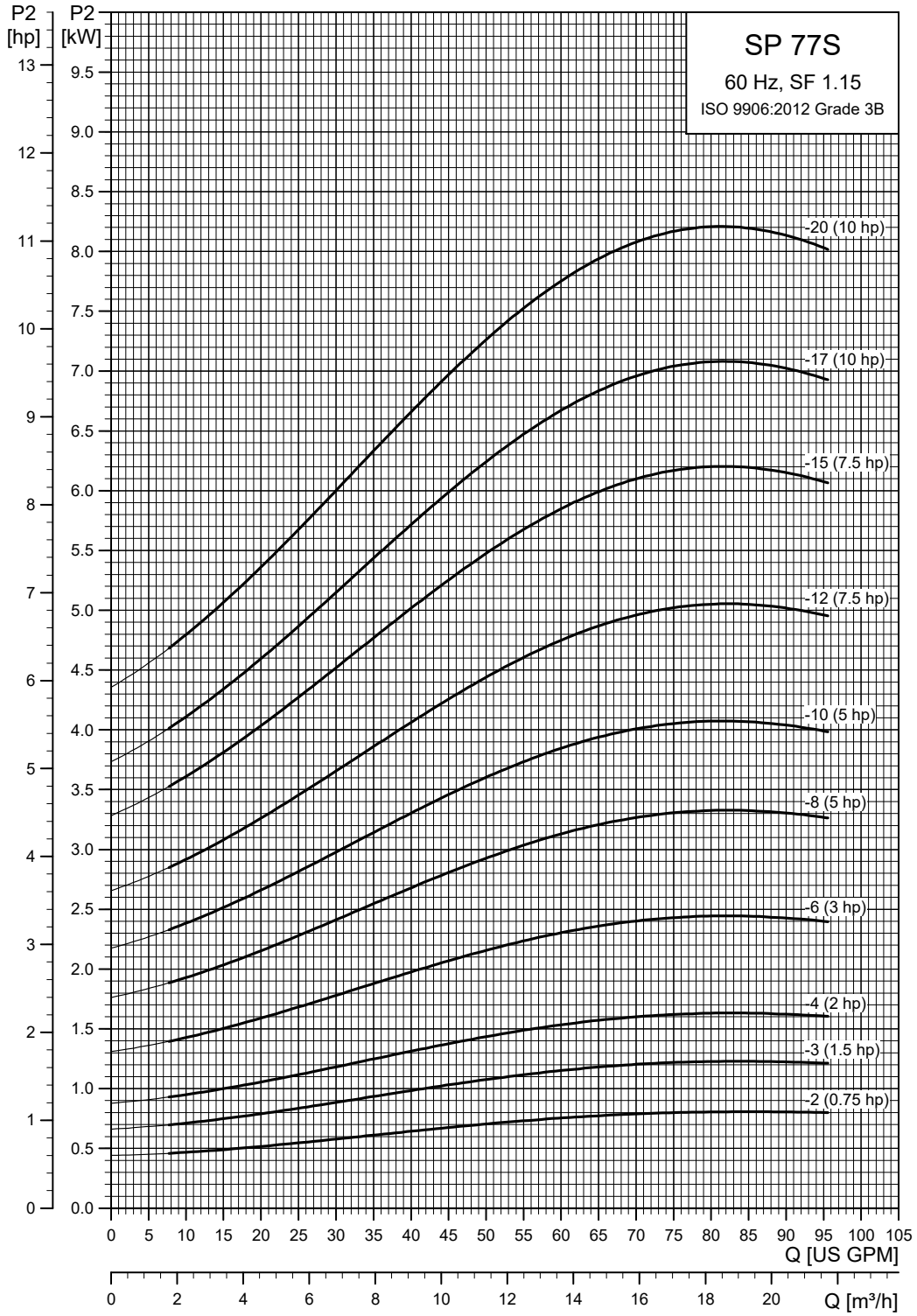

TM064621

## SP 77S (77 gpm) pump with 4" motor

Pump model	Nom. head [ft]	Motor				Dimensions [in (mm)]					Net weight (complete) [lb]	77S
		Ph	Volts [V]	[Hp]	[rpm]	A	B	C	D	E		
<b>77S - Motor diameter 4-inch, 3-wire motor, 60 Hz, rated flow rate 77 gpm (2" NPT)</b>												
77S07-2	37	1	230	.75	■	3380	28.35 (720)	13.08 (332)	15.28 (388)	3.75 (95)	3.98 (101)	29.7
	38	3	230	.75	■	3401	26.97 (685)	11.70 (297)	15.28 (388)	3.75 (95)	3.98 (101)	26.7
	38	3	460	.75	■	3401	26.97 (685)	11.70 (297)	15.28 (388)	3.75 (95)	3.98 (101)	26.7
	37	3	575	.75	■	3393	26.97 (685)	11.70 (297)	15.28 (388)	3.75 (95)	3.98 (101)	26.7
77S15-3	61	1	230	1	■	3457	33.47 (850)	15.24 (387)	18.23 (463)	3.75 (95)	3.98 (101)	36.8
	61	3	230	1.5	■	3463	31.89 (810)	13.67 (347)	18.23 (463)	3.75 (95)	3.98 (101)	33.3
	61	3	460	1.5	■	3463	31.89 (810)	13.67 (347)	18.23 (463)	3.75 (95)	3.98 (101)	33.3
	60	3	575	1.5	■	3440	31.89 (810)	13.67 (347)	18.23 (463)	3.75 (95)	3.98 (101)	33.0
77S20-4	77	1	230	2	●	3447	40.75 (1035)	19.57 (497)	21.19 (538)	3.75 (95)	3.98 (101)	54.2
	77	3	230	2	■	3445	36.42 (925)	15.24 (387)	21.19 (538)	3.75 (95)	3.98 (101)	38.8
	77	3	460	2	■	3445	36.42 (925)	15.24 (387)	21.19 (538)	3.75 (95)	3.98 (101)	39.0
	77	3	575	2	■	3441	36.42 (925)	15.24 (387)	21.19 (538)	3.75 (95)	3.98 (101)	38.8
77S30-6	113	1	230	3	●	3427	49.81 (1265)	22.72 (577)	27.09 (688)	3.75 (95)	3.98 (101)	66.5
	114	3	208	3	●	3437	45.08 (1145)	18.00 (457)	27.09 (688)	3.75 (95)	3.98 (101)	53.3
	114	3	230	3	●	3437	45.08 (1145)	18.00 (457)	27.09 (688)	3.75 (95)	3.98 (101)	53.3
	117	3	460	3	●	3466	45.08 (1145)	18.00 (457)	27.09 (688)	3.75 (95)	3.98 (101)	53.3
77S50-8	157	1	230	5	●	3484	59.65 (1515)	26.66 (677)	33.00 (838)	3.75 (95)	3.98 (101)	81.1
	159	3	208	5	●	3503	55.71 (1415)	22.72 (577)	33.00 (838)	3.75 (95)	3.98 (101)	70.1
	159	3	230	5	●	3503	55.71 (1415)	22.72 (577)	33.00 (838)	3.75 (95)	3.98 (101)	70.1
	159	3	460	5	●	3501	55.71 (1415)	22.72 (577)	33.00 (838)	3.75 (95)	3.98 (101)	70.1
77S50-10	192	1	230	5	●	3449	65.56 (1665)	26.66 (677)	38.90 (988)	3.75 (95)	3.98 (101)	84.6
	195	3	208	5	●	3476	61.62 (1565)	22.72 (577)	38.90 (988)	3.75 (95)	3.98 (101)	73.6
	195	3	230	5	●	3476	61.62 (1565)	22.72 (577)	38.90 (988)	3.75 (95)	3.98 (101)	73.6
	195	3	460	5	●	3473	61.62 (1565)	22.72 (577)	38.90 (988)	3.75 (95)	3.98 (101)	73.6
77S75-12	237	3	208	7.5	●	3493	71.46 (1815)	26.66 (677)	44.81 (1138)	3.75 (95)	3.98 (101)	88.1
	237	3	230	7.5	●	3493	71.46 (1815)	26.66 (677)	44.81 (1138)	3.75 (95)	3.98 (101)	88.1
	237	3	460	7.5	●	3493	71.46 (1815)	26.66 (677)	44.81 (1138)	3.75 (95)	3.98 (101)	88.1
	237	3	575	7.5	●	3493	71.46 (1815)	26.66 (677)	44.81 (1138)	3.75 (95)	3.98 (101)	88.1
	293	3	208	7.5	●	3463	80.32 (2040)	26.66 (677)	53.67 (1363)	3.75 (95)	3.98 (101)	93.4
77S75-15	293	3	230	7.5	●	3463	80.32 (2040)	26.66 (677)	53.67 (1363)	3.75 (95)	3.98 (101)	93.4
	293	3	460	7.5	●	3463	80.32 (2040)	26.66 (677)	53.67 (1363)	3.75 (95)	3.98 (101)	93.4
	293	3	575	7.5	●	3463	80.32 (2040)	26.66 (677)	53.67 (1363)	3.75 (95)	3.98 (101)	93.4
77S100-17	337	3	460	10	●	3484	90.16 (2290)	30.60 (777)	59.57 (1513)	3.75 (95)	3.98 (101)	105.7
	337	3	575	10	●	3484	90.16 (2290)	30.60 (777)	59.57 (1513)	3.75 (95)	3.98 (101)	105.7
77S100-20	392	3	460	10	●	3462	99.02 (2515)	30.60 (777)	68.43 (1738)	3.75 (95)	3.98 (101)	111.0
	392	3	575	10	●	3462	99.02 (2515)	30.60 (777)	68.43 (1738)	3.75 (95)	3.98 (101)	111.0

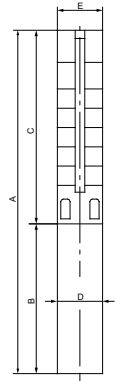

E = Maximum diameter of pump including cable guard and motor

**Notes:**

Control box is required for 3-wire, single-phase applications. Data does not include control box.  
Performance conforms to ISO 9906. 1999 (E) Annex A. Minimum submergence is 5 ft (1.5 m).

- MS402 motor
- MS4000C motor

**SP 77S (77 gpm) pump with 6" motor**

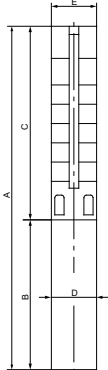
Pump model	Nom. head [ft]	Ph	Motor			Dimensions [in (mm)]					Net weight (complete) [lb]	77S
			Volts [V]	[Hp]	[rpm]	A	B	C	D	E		
<b>77S - Motor diameter 6 inch, 60 Hz, rated flow rate 77 gpm (2" NPT)</b>												
77S75-12	239	3	208	7.5 ▲	3500	70.79 (1798)	23.51 (597)	47.29 (1201)	5.50 (140)	5.50 (140)	115.8	 <p>E = Maximum diameter of pump including cable guard and motor</p>
	239	3	230	7.5 ▲	3500	70.79 (1798)	23.51 (597)	47.29 (1201)	5.50 (140)	5.50 (140)	115.8	
	240	3	460	7.5 ▲	3509	70.79 (1798)	23.51 (597)	47.29 (1201)	5.50 (140)	5.50 (140)	115.8	
	240	3	575	7.5 ▲	3508	70.79 (1798)	23.51 (597)	47.29 (1201)	5.50 (140)	5.50 (140)	115.8	
77S75-15	295	3	208	7.5 ▲	3472	79.65 (2023)	23.51 (597)	56.15 (1426)	5.50 (140)	5.50 (140)	121.1	
	295	3	230	7.5 ▲	3472	79.65 (2023)	23.51 (597)	56.15 (1426)	5.50 (140)	5.50 (140)	121.1	
	297	3	460	7.5 ▲	3484	79.65 (2023)	23.51 (597)	56.15 (1426)	5.50 (140)	5.50 (140)	121.1	
	297	3	575	7.5 ▲	3483	79.65 (2023)	23.51 (597)	56.15 (1426)	5.50 (140)	5.50 (140)	121.1	
77S100-17	337	3	208	10 ▲	3486	86.74 (2203)	24.69 (627)	62.05 (1576)	5.50 (140)	5.50 (140)	131.2	
	337	3	230	10 ▲	3486	86.74 (2203)	24.69 (627)	62.05 (1576)	5.50 (140)	5.50 (140)	131.2	
	340	3	460	10 ▲	3496	86.74 (2203)	24.69 (627)	62.05 (1576)	5.50 (140)	5.50 (140)	131.2	
	340	3	575	10 ▲	3496	86.74 (2203)	24.69 (627)	62.05 (1576)	5.50 (140)	5.50 (140)	131.2	
77S100-20	393	3	208	10 ▲	3462	95.60 (2428)	24.69 (627)	70.91 (1801)	5.50 (140)	5.50 (140)	136.4	
	393	3	230	10 ▲	3476	95.60 (2428)	24.69 (627)	70.91 (1801)	5.50 (140)	5.50 (140)	136.4	
	396	3	460	10 ▲	3476	95.60 (2428)	24.69 (627)	70.91 (1801)	5.50 (140)	5.50 (140)	136.4	
	396	3	575	10 ▲	3475	95.60 (2428)	24.69 (627)	70.91 (1801)	5.50 (140)	5.50 (140)	136.4	

**Notes:**

Performance conforms to ISO 9906. 1999 (E) Annex A. Minimum submergence is 5 ft (1.5 m).

▲ MS6000C motor

### 6" and larger wells SP 90S (90 gpm)

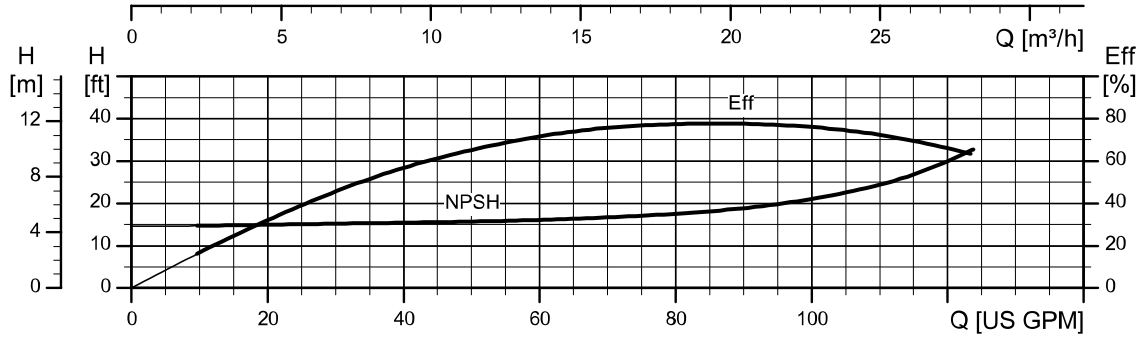
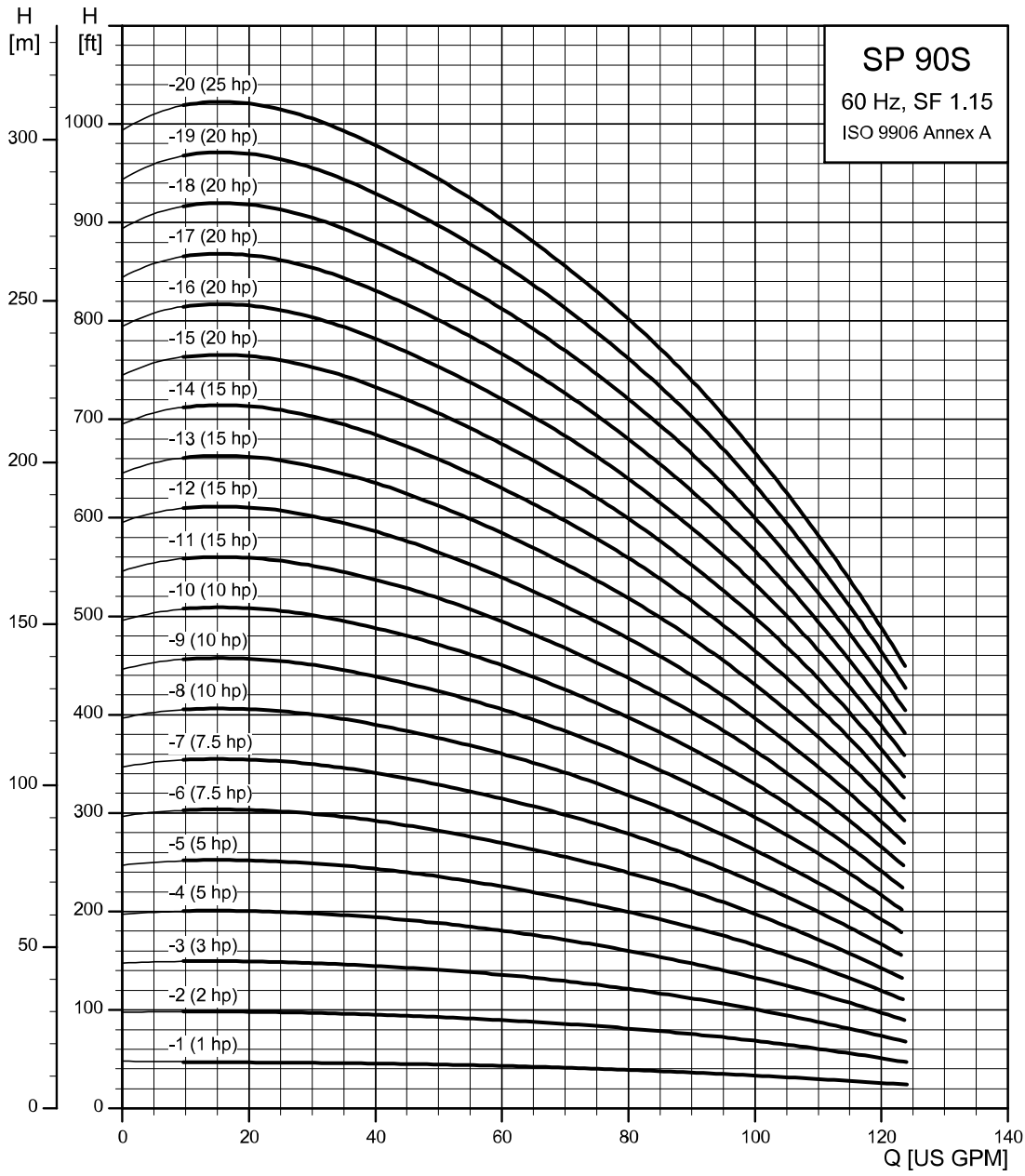

TM084241



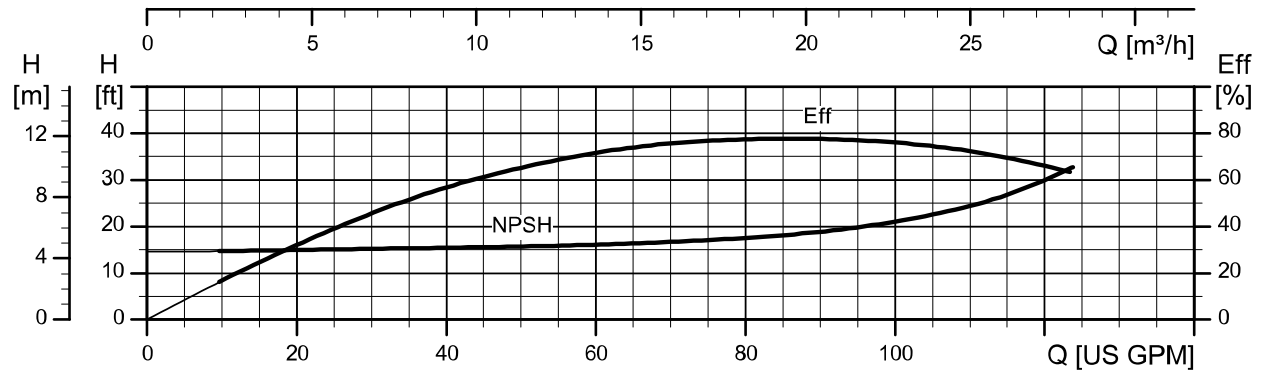
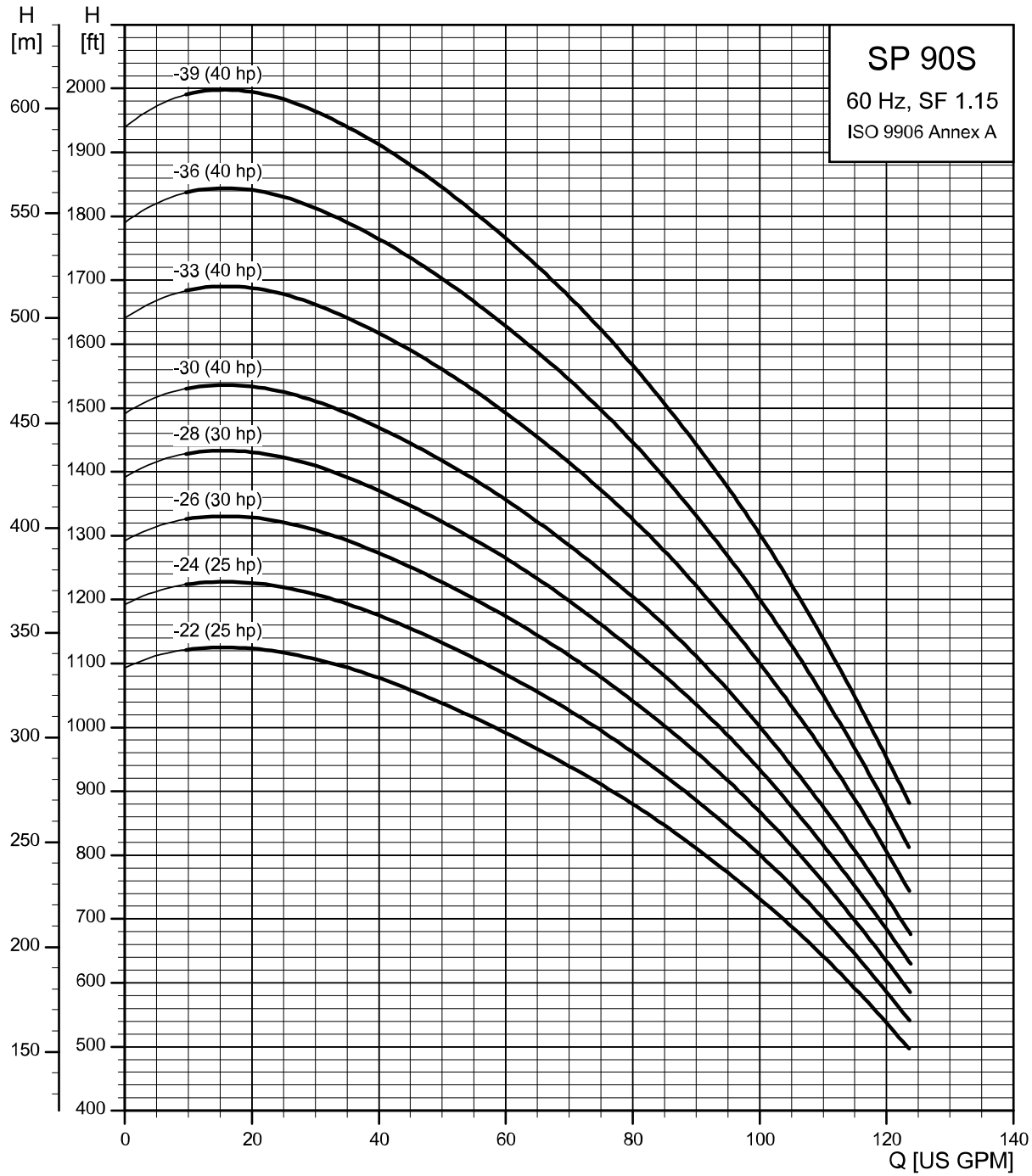

TM084242

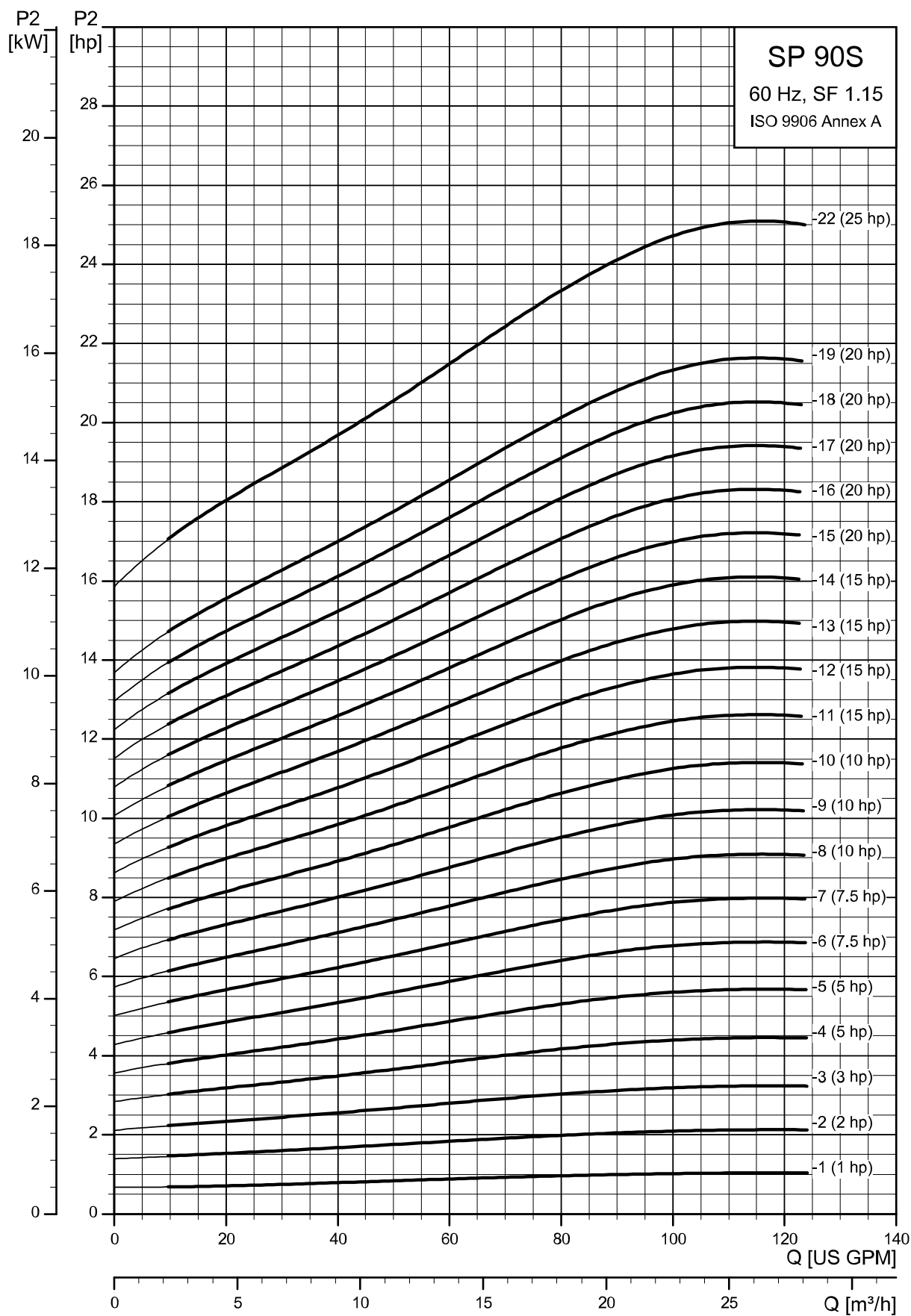

TM084243

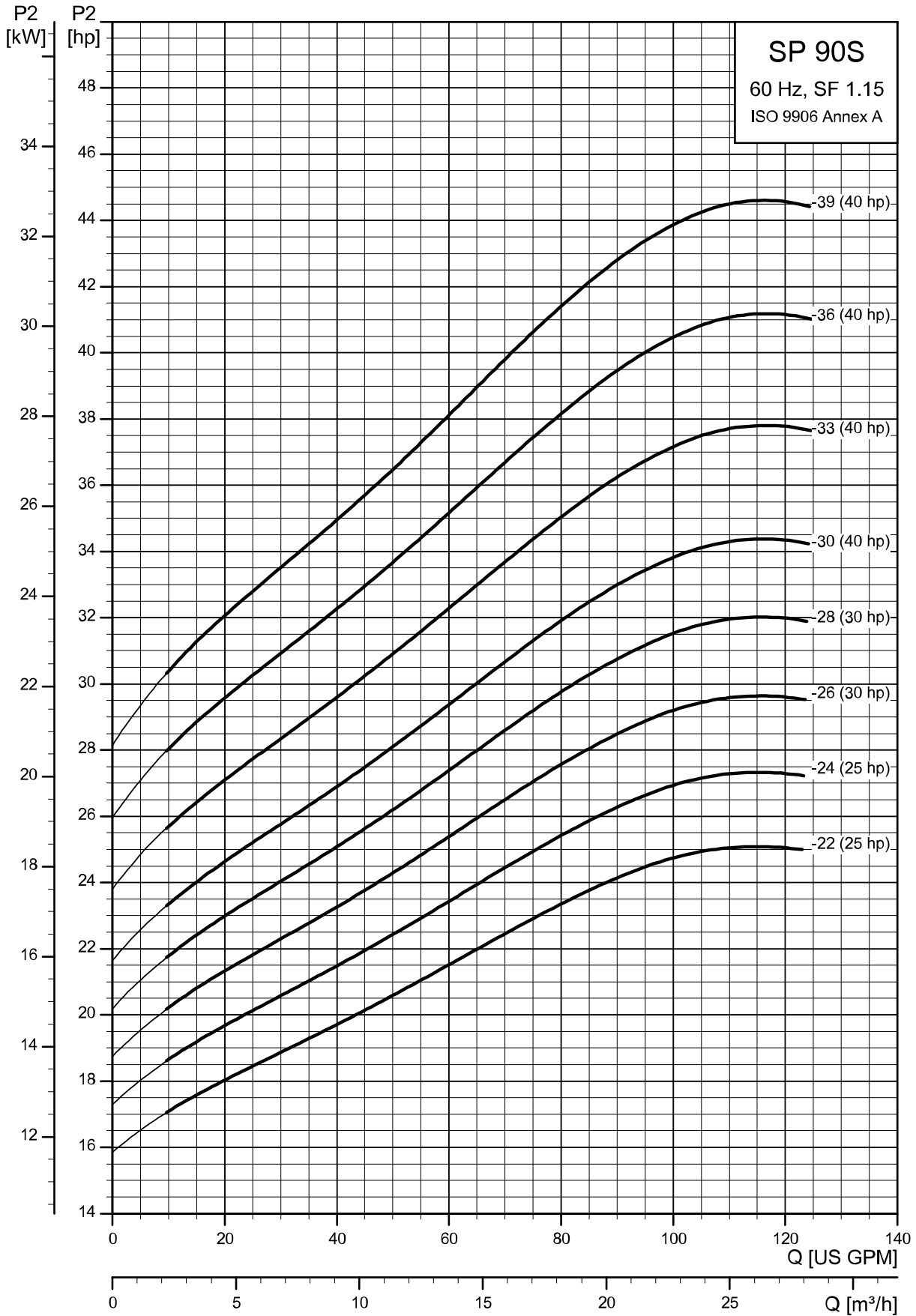

TM084244

## SP 90S (90 gpm) pump with 4" motors

Pump model	Nom. head [ft]	Motor				Dimensions [in (mm)]					Net weight (complete) [lb]	90S
		Ph	Volts [V]	[Hp]	[rpm]	A	B	C	D	E		
<b>90S - Motor diameter 4-inch, 3-wire motor, 60 Hz, rated flow rate 90 gpm (3" NPT)</b>												
90S10-1	42	1	230	1	■	3519	25.00 (634)	12.17 (309)	12.80 (325)	3.75 (95)	5.28 (134)	32.2
		3	230	1	■	3516	28.62 (727)	15.83 (402)	12.80 (325)	3.75 (95)	5.28 (134)	40.2
		3	460	1	■	3516	2.62 (727)	15.83 (402)	12.80 (325)	3.75 (95)	5.28 (134)	40.2
90S20-2	87	1	230	2	●	3500	34.72 (882)	19.57 (497)	15.16 (385)	3.75 (95)	5.28 (134)	53.1
		3	230	2	●	3491	31.57 (802)	16.42 (417)	15.16 (385)	3.75 (95)	5.28 (134)	45.4
		3	460	2	●	3517	31.57 (802)	16.42 (417)	15.16 (385)	3.75 (95)	5.28 (134)	45.4
90S30-3	135	1	230	3	●	3520	40.28 (1023)	22.72 (577)	17.56 (446)	3.75 (95)	5.28 (134)	64.9
		3	230	3	●	3531	35.55 (903)	17.99 (457)	17.56 (446)	3.75 (95)	5.28 (134)	51.7
		3	460	3	●	3530	35.55 (903)	17.99 (457)	17.56 (446)	3.75 (95)	5.28 (134)	52.8
90S50-4	170	1	230	5	●	3482	46.58 (1183)	26.66 (677)	19.93 (506)	3.75 (95)	5.28 (134)	79.0
		3	230	5	●	3502	42.63 (1083)	22.68 (577)	19.93 (506)	3.75 (95)	5.28 (134)	68.0
		3	460	5	●	3500	42.63 (1083)	22.68 (577)	19.93 (506)	3.75 (95)	5.28 (134)	68.0
90S50-5	215	3	230	5	●	3510	45.03 (1144)	22.68 (577)	22.33 (567)	3.75 (95)	5.28 (134)	71.0
		3	460	5	●	3510	45.03 (1144)	22.68 (577)	22.33 (567)	3.75 (95)	5.28 (134)	71.0
90S75-6	256	3	230	7.5	●	3490	51.33 (1304)	26.65 (677)	24.69 (627)	3.75 (95)	5.28 (134)	85.0
		3	460	7.5	●	3490	51.33 (1304)	26.65 (677)	24.69 (627)	3.75 (95)	5.28 (134)	85.0
90S75-7	301	3	460	7.5	●	3503	53.74 (1365)	26.65 (677)	27.09 (688)	3.75 (95)	5.28 (134)	88.1
90S100-8	342	3	460	10	●	3488	60.03 (1525)	30.59 (777)	29.45 (748)	3.75 (95)	5.28 (134)	99.9
90S100-9	382	3	460	10	●	3472	62.41 (1585)	30.59 (777)	31.86 (809)	3.75 (95)	5.28 (134)	102.9

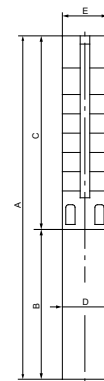

E = Maximum diameter of pump including cable guard and motor

**Notes:**

Control box is required for 3-wire, single-phase applications. Data does not include control box.

Performance conforms to ISO 9906. 1999 (E) Annex A. Minimum submergence is 5 ft (1.5 m).

- MS402 motor
- MS4000C motor

**SP 90S (90 gpm) pump with 6" motors**

Pump model	Nom. head [ft]	Motor				Dimensions [in (mm)]					Net weight (complete) [lb]	90S
		Ph	Volts [V]	[Hp]	[rpm]	A	B	C	D	E		
<b>90S - Motor diameter 6-inch, 3-wire motor, 60 Hz, rated flow rate 90gpm (3" NPT)</b>												
90S50-5	216	3	230	5 ▲	3516	46.50 (1181)	23.51 (597)	23.08 (584)	5.52 (140)	5.59 (142)	113.4	
	217	3	460	5 ▲	3523	46.50 (1181)	23.51 (597)	23.08 (584)	5.52 (140)	5.59 (142)	113.4	
90S75-6	257	3	230	7.5 ▲	3498	48.86 (1241)	23.51 (597)	25.44 (644)	5.52 (140)	5.59 (142)	114.8	
	258	3	460	7.5 ▲	3507	48.86 (1241)	23.51 (597)	25.44 (644)	5.52 (140)	5.59 (142)	114.8	
90S75-7	301	3	230	7.5 ▲	3505	52.44 (1332)	24.69 (627)	27.84 (705)	5.52 (140)	5.59 (142)	116.1	
	303	3	460	7.5 ▲	3513	52.44 (1332)	24.69 (627)	27.84 (705)	5.52 (140)	5.59 (142)	116.1	
90S100-8	342	3	230	10 ▲	3490	54.80 (1392)	24.69 (627)	30.00 (765)	5.52 (140)	5.59 (142)	124.1	
	344	3	460	10 ▲	3500	54.80 (1392)	24.69 (627)	30.00 (765)	5.52 (140)	5.59 (142)	124.1	
90S100-9	383	3	230	10 ▲	3474	57.20 (1453)	24.69 (627)	32.52 (826)	5.52 (140)	5.59 (142)	127.2	
	385	3	460	10 ▲	3486	57.20 (1453)	24.69 (627)	32.52 (826)	5.52 (140)	5.59 (142)	127.2	
90S100-10	432	3	230	10 ▲	3509	59.57 (1513)	24.69 (627)	34.88 (886)	5.52 (140)	5.59 (142)	130.2	
	433	3	460	10 ▲	3513	59.57 (1513)	24.69 (627)	34.88 (886)	5.52 (140)	5.59 (142)	130.2	
90S150-11	473	3	230	15 ▲	3499	64.33 (1634)	27.05 (687)	37.28 (947)	5.52 (140)	5.59 (142)	153.0	
	474	3	460	15 ▲	3503	64.33 (1634)	27.05 (687)	37.28 (947)	5.52 (140)	5.59 (142)	153.0	
90S150-12	513	3	230	15 ▲	3489	66.69 (1694)	27.05 (687)	39.65 (1007)	5.52 (140)	5.59 (142)	156.1	
	514	3	460	15 ▲	3494	66.69 (1694)	27.05 (687)	39.65 (1007)	5.52 (140)	5.59 (142)	156.1	
90S150-13	553	3	230	15 ▲	3479	69.09 (1755)	27.05 (687)	42.05 (1068)	5.52 (140)	5.59 (142)	159.1	
	554	3	460	15 ▲	3484	69.09 (1755)	27.05 (687)	42.05 (1068)	5.52 (140)	5.59 (142)	159.1	

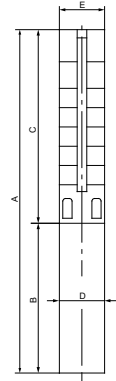

E = Maximum diameter of pump including cable guard and motor

**Notes:**

Control box is required for 3-wire, single-phase applications. Data does not include control box. Performance conforms to ISO 9906. 1999 (E) Annex A. Minimum submergence is 5 ft (1.5 m).

▲ MS6000C motor

## SP 90S (90 gpm) pump with 6", 8" motors

Pump model	Nom. head [ft]	Ph	Motor			Dimensions [in (mm)]					Net weight (complete) [lb]	90S
			Volts [V]	[Hp]	[rpm]	A	B	C	D	E		
<b>90S - Motor diameter 6-inch, 60 Hz, rated flow rate 90 gpm (3" NPT)</b>												
90S150-14	604	3	230	15	▲	3505	71.46 (1815)	27.05 (687)	44.41 (1128)	5.52 (140)	5.59 (142)	162.1
	607	3	460	15	▲	3513	71.46 (1815)	27.05 (687)	44.41 (1128)	5.52 (140)	5.59 (142)	162.1
90S200-15	644	3	230	20	▲	3497	76.42 (1941)	29.61 (752)	46.89 (1189)	5.52 (140)	5.59 (142)	180.1
	648	3	460	20	▲	3507	76.42 (1941)	29.61 (752)	46.89 (1189)	5.52 (140)	5.59 (142)	180.1
90S200-16	685	3	230	20	▲	3490	78.78 (2001)	29.61 (752)	49.17 (1249)	5.52 (140)	5.59 (142)	183.6
	689	3	460	20	▲	3500	78.78 (2001)	29.61 (752)	49.17 (1249)	5.52 (140)	5.59 (142)	183.6
90S200-17	724	3	230	20	▲	3482	81.18 (2062)	29.61 (752)	51.57 (1310)	5.52 (140)	5.59 (142)	186.6
	729	3	460	20	▲	3493	81.18 (2062)	29.61 (752)	51.57 (1310)	5.52 (140)	5.59 (142)	186.6
90S200-18	764	3	230	20	▲	3474	83.54 (2122)	29.61 (752)	53.94 (1370)	5.52 (140)	5.59 (142)	189.6
	769	3	460	20	▲	3486	83.54 (2122)	29.61 (752)	53.94 (1370)	5.52 (140)	5.59 (142)	189.6
90S200-19	817	3	230	20	▲	3497	85.94 (2183)	29.61 (752)	56.34 (1431)	5.52 (140)	5.59 (142)	192.6
	821	3	460	20	▲	3506	85.94 (2183)	29.61 (752)	56.34 (1431)	5.52 (140)	5.59 (142)	192.6
90S250-20	857	3	230	25	▲	3491	90.47 (2298)	31.78 (807)	58.70 (1491)	5.52 (140)	5.59 (142)	205.6
	862	3	460	25	▲	3501	90.47 (2298)	31.78 (807)	58.70 (1491)	5.52 (140)	5.59 (142)	205.6
90S250-22	936	3	230	25	▲	3479	95.24 (2419)	31.78 (807)	63.46 (1612)	5.52 (140)	5.59 (142)	211.6
	942	3	460	25	▲	3490	95.24 (2419)	31.78 (807)	63.46 (1612)	5.52 (140)	5.59 (142)	211.6
90S250-24	1023	3	230	25	▲	3482	100.00 (2540)	31.78 (807)	68.23 (1733)	5.52 (140)	5.59 (142)	217.7
	1030	3	460	25	▲	3493	100.00 (2540)	31.78 (807)	68.23 (1733)	5.52 (140)	5.59 (142)	217.7
90S300-26	1102	3	230	30	▲	3471	107.12 (2721)	34.14 (867)	72.99 (1854)	5.52 (140)	5.59 (142)	239.1
	1110	3	460	30	▲	3483	107.12 (2721)	34.14 (867)	72.99 (1854)	5.52 (140)	5.92 (142)	239.1
90S300-28	1212	3	460	30	▲	3508	111.89 (2842)	34.14 (867)	77.76 (1975)	5.52 (140)	5.59 (142)	245.2
90S400-30	1294	3	460	40	▲	3501	121.77 (3093)	39.26 (997)	82.52 (2096)	5.52 (140)	5.59 (142)	281.0
90S400-33DS	1416	3	460	40	▲	3490	143.54 (3646)	39.26 (997)	104.29 (2649)	5.52 (140)	6.89 (175)	353.0
90S400-36DS	1535	3	460	40	▲	3479	150.67 (3827)	39.26 (997)	111.42 (2830)	5.52 (140)	6.89 (175)	364.0
90S400-39DS	1670	3	460	40	▲	3487	157.0 (4008)	39.26 (997)	118.58 (3012)	5.52 (140)	6.89 (175)	375.1
<b>90S - Motor diameter 8 inch, 60 Hz, rated flow rate 85 gpm (3" NPT)</b>												
90S400-33DS	1427	3	460	40	*	3505	145.12 (3756)	46.46 (1180)	101.42 (2576)	7.56 (192)	7.56 (192)	522.7
90S400-36DS	1549	3	460	40	*	3496	155.00 (3937)	46.46 (1180)	108.55 (2757)	7.56 (192)	7.56 (192)	533.8
90S400-39DS	1690	3	460	50	*	3508	162.17 (4119)	46.46 (1180)	115.71 (2939)	7.56 (192)	7.56 (192)	544.8

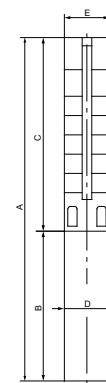

E = Maximum diameter of pump including cable guard and motor

DS designation = Built into sleeve, 3" NPT, 8" minimum well diameter.

Performance conforms to ISO 9906. 1999 (E) Annex A. Minimum submergence is 5 ft (1.5 m).

▲ MS6000C motor

\* Takes MMS8000 motor; not available as complete.

**SP 160S (160 gpm)**

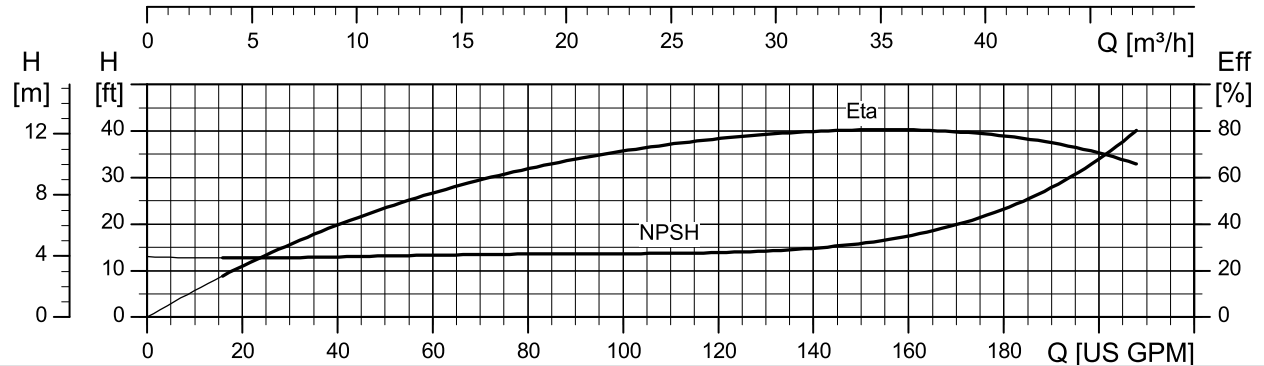
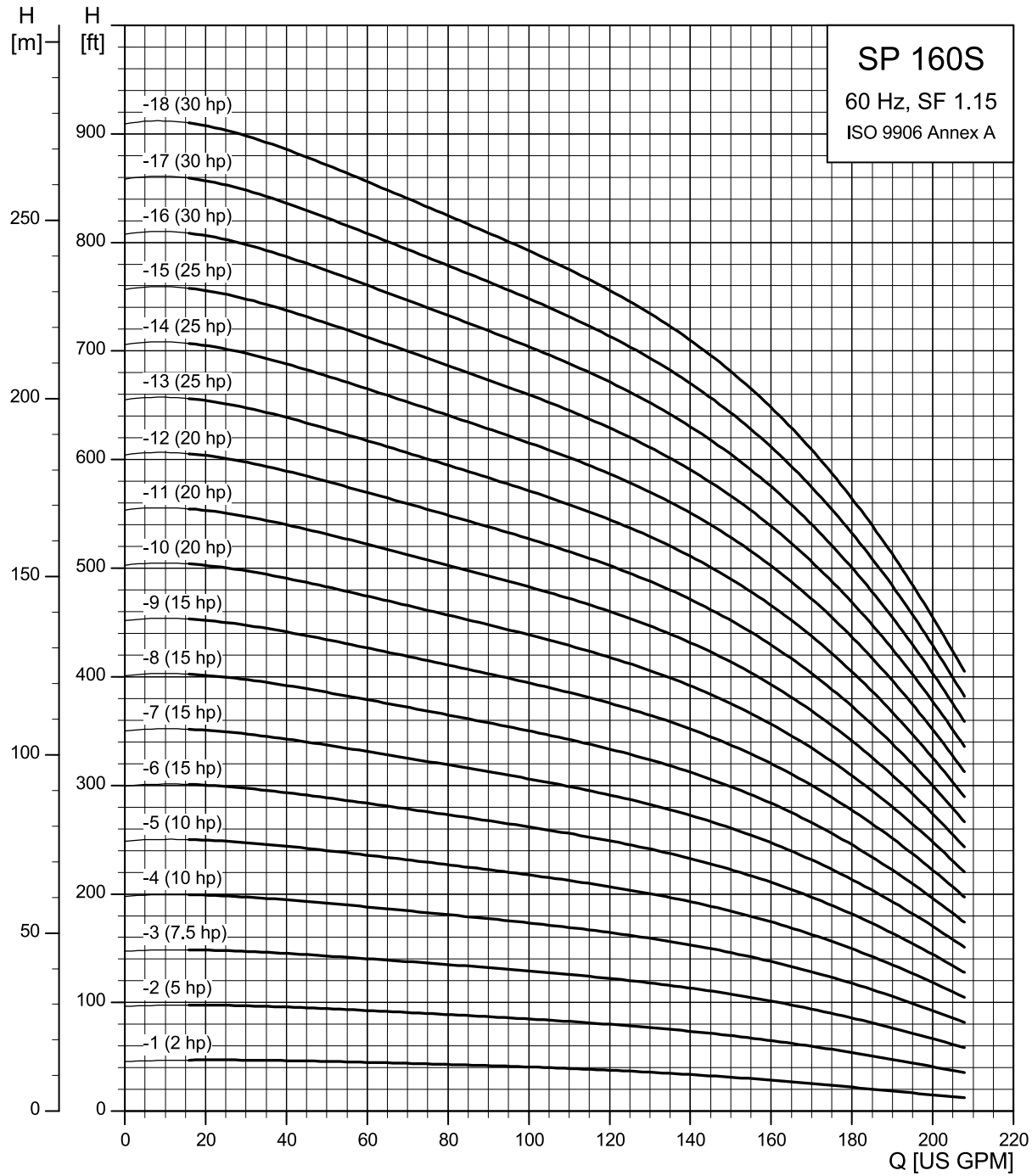

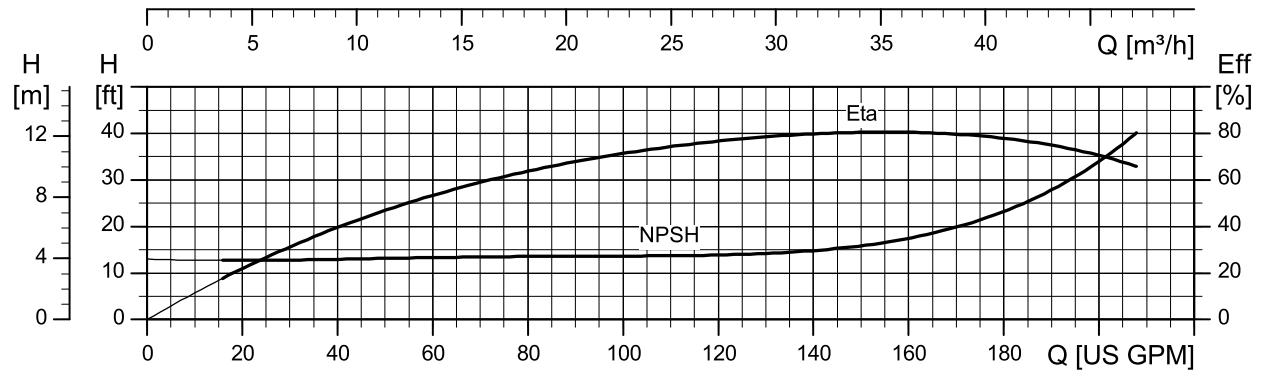
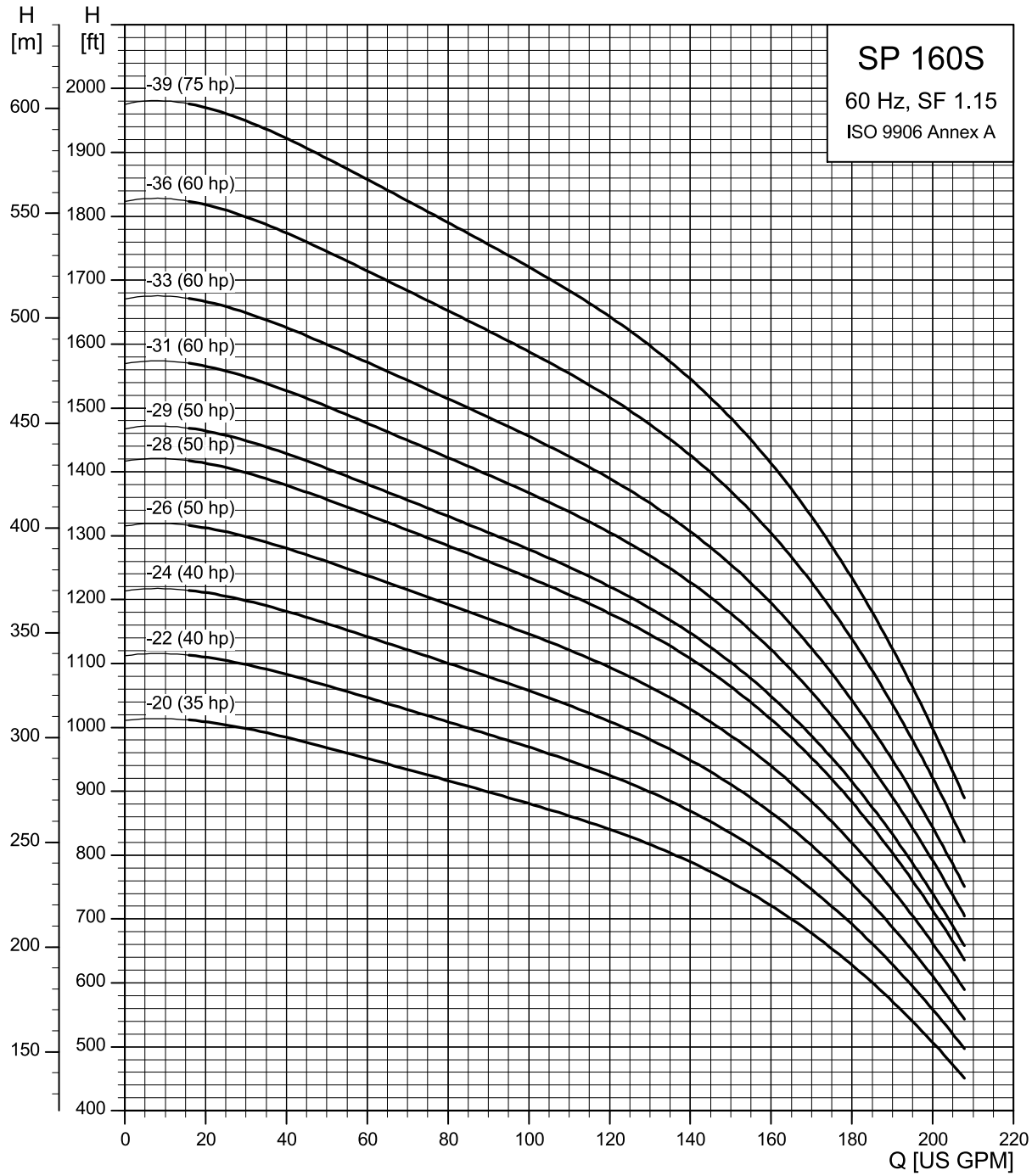



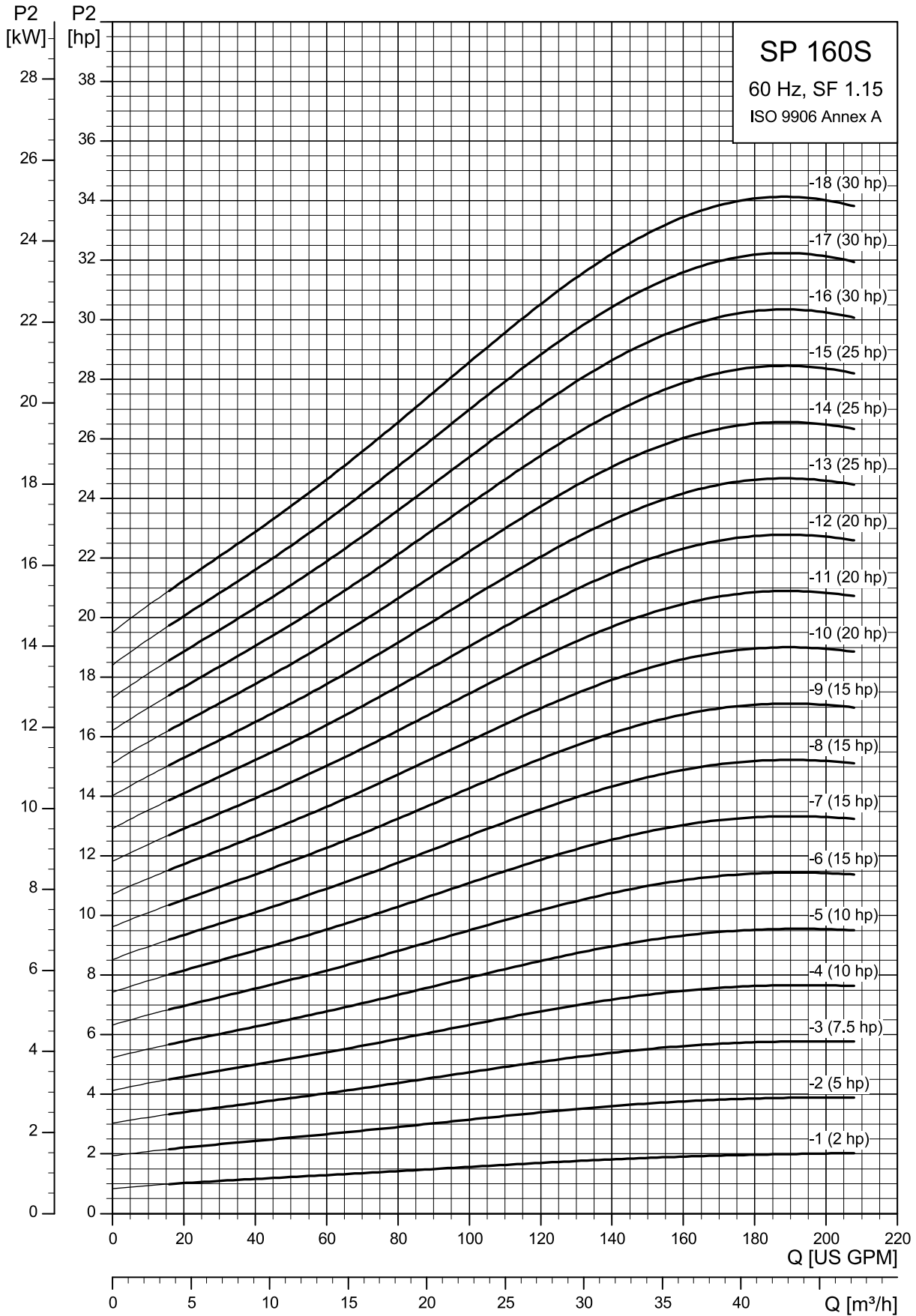

TM087027

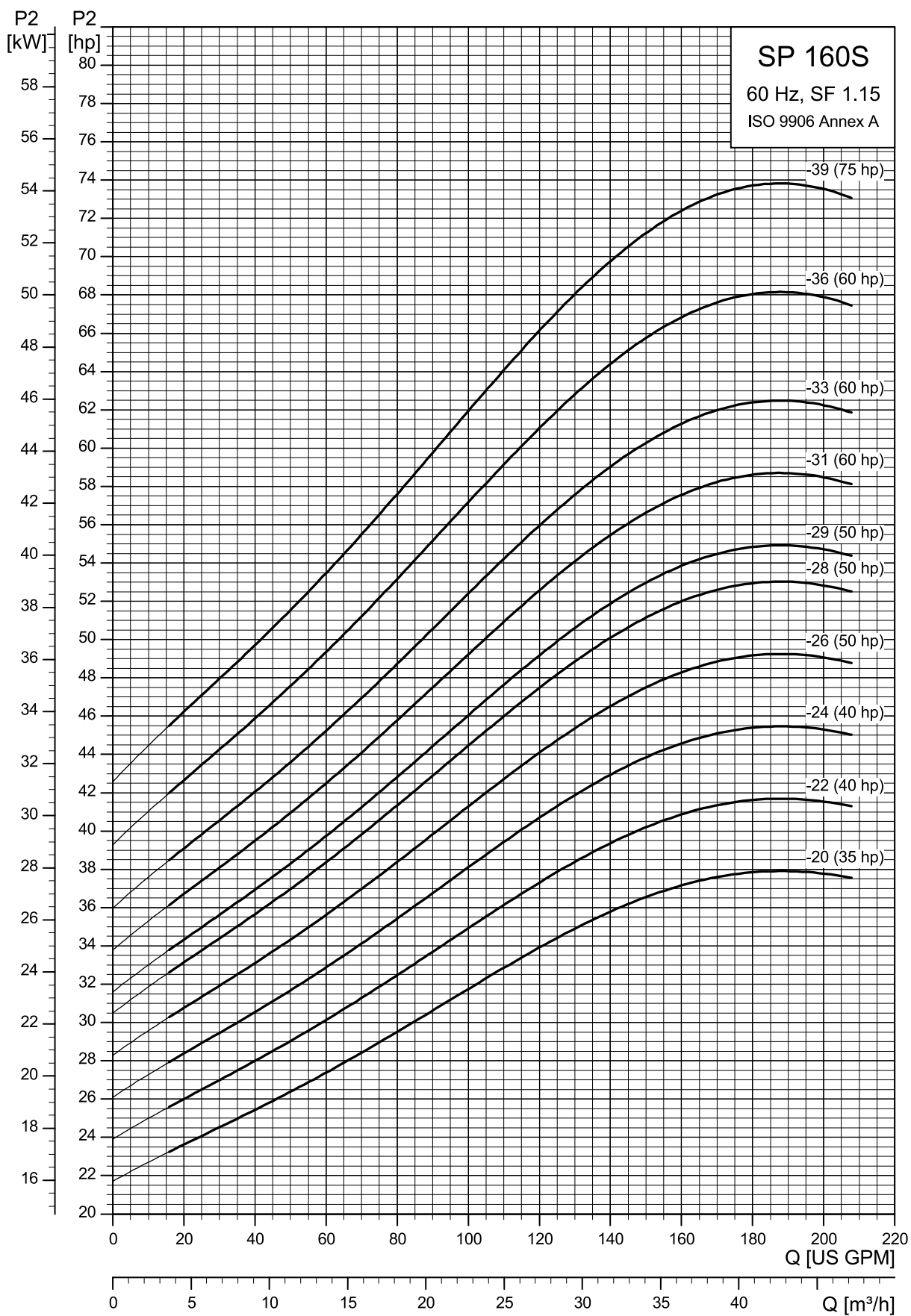

**SP 160S (160 gpm) pump with 4", 6" motor**

Pump model	Nom. head [ft]	Ph	Motor			Dimensions [in (mm)]					Net weight (complete) [lb]	160S
			Volts [V]	[Hp]	[rpm]	A	B	C	D	E		
<b>160S - Motor diameter 4-inch, 3-wire motor, 60 Hz, rated flow rate 160 gpm (3" NPT)</b>												
160S20-1	39	1	230	2	●	3477	33.67 (855)	19.57 (497)	14.10 (358)	3.75 (95)	5.28 (134)	52.0
	39	3	230	2	■	3474	27.83 (707)	13.74 (3349)	14.10 (358)	3.75 (95)	5.28 (134)	37.0
	39	3	460	2	■	3474	28.83 (707)	13.74 (349)	14.10 (358)	3.75 (95)	5.28 (134)	37.0
160S50-2	78	1	230	5	●	3502	44.53 (1131)	26.66 (677)	17.88 (454)	3.75 (95)	5.28 (134)	76.2
	79	3	230	5	●	3517	40.59 (1031)	22.71 (577)	17.88 (454)	3.75 (95)	5.28 (134)	42.3
	79	3	460	5	●	3516	40.59 (1031)	22.71 (577)	17.88 (454)	3.75 (95)	5.28 (134)	65.1
160S75-3	118	3	230	7.5	●	3508	48.30 (1227)	26.65 (677)	21.66 (550)	3.75 (95)	5.28 (134)	80.4
	118	3	460	7.5	●	3508	48.30 (1227)	26.65 (677)	21.66 (550)	3.75 (95)	5.28 (134)	80.4
160S100-4	154	3	230	10	●	3473	52.08 (1323)	26.65 (677)	25.44 (646)	3.75 (95)	5.28 (134)	84.7
	154	3	460	10	●	3473	52.08 (1323)	26.65 (677)	25.44 (646)	3.75 (95)	5.28 (134)	84.7
160S100-5	195	3	460	10	●	3481	59.0 (1519)	30.59 (777)	29.22 (742)	3.75 (95)	5.28 (134)	97.8
<b>160S - Motor diameter 6 inch, 60 Hz, rated flow rate 160 gpm (3" NPT)</b>												
160S100-4	155	3	230	10	▲	3482	49.69 (1262)	23.51 (597)	26.19 (665)	5.49 (139.5)	5.59 (142)	109.9
	156	3	460	10	▲	3493	49.69 (1262)	23.51 (597)	26.19 (665)	5.49 (139.5)	5.59 (142)	109.9
160S100-5	195	3	230	10	▲	3482	54.65 (1388)	24.69 (627)	29.97 (761)	5.49 (139.5)	5.59 (142)	120.8
	196	3	460	10	▲	3493	54.65 (1388)	24.69 (627)	29.97 (761)	5.49 (139.5)	5.59 (142)	120.8
160S150-6	238	3	230	15	▲	3508	60.79 (1544)	27.05 (687)	33.75 (857)	5.49 (139.5)	5.59 (142)	144.9
	239	3	460	15	▲	3511	60.79 (1544)	27.05 (687)	33.75 (857)	5.49 (139.5)	5.59 (142)	144.9
160S150-7	276	3	230	15	▲	3492	64.57 (1640)	27.05 (687)	37.52 (953)	5.49 (139.5)	5.59 (142)	149.2
	277	3	460	15	▲	3496	64.57 (1640)	27.05 (687)	37.52 (953)	5.49 (139.5)	5.59 (142)	149.2
160S150-8	313	3	230	15	▲	3474	68.35 (1736)	27.05 (687)	41.30 (1049)	5.49 (139.5)	5.59 (142)	153.5
	314	3	460	15	▲	3480	68.35 (1736)	27.05 (687)	41.30 (1049)	5.49 (139.5)	5.59 (142)	153.5
160S150-9	357	3	230	15	▲	3496	72.16 (1832)	27.05 (687)	45.08 (1145)	5.49 (139.5)	5.59 (142)	157.8
	359	3	460	15	▲	3506	72.16 (1832)	27.05 (687)	45.08 (1145)	5.49 (139.5)	5.59 (142)	157.8
160S200-10	395	3	230	20	▲	3484	78.47 (1993)	29.61 (752)	48.86 (1241)	5.49 (139.5)	5.59 (142)	177.5
	397	3	460	20	▲	3495	78.47 (1993)	29.61 (752)	48.86 (1241)	5.49 (139.5)	5.59 (142)	177.5
160S200-11	431	3	230	20	▲	3471	82.25 (2089)	29.61 (752)	52.64 (1337)	5.49 (139.5)	5.59 (142)	181.7
	435	3	460	20	▲	3483	82.25 (2089)	29.61 (752)	52.64 (1337)	5.49 (139.5)	5.59 (142)	181.7
160S200-12	477	3	230	20	▲	3490	88.19 (2185)	29.61 (752)	56.42 (1433)	5.49 (139.5)	5.59 (142)	186.0
	479	3	460	20	▲	3500	88.19 (2185)	29.61 (752)	56.42 (1433)	5.49 (139.5)	5.59 (142)	186.0
160S250-13	514	3	230	25	▲	3480	91.97 (2336)	31.78 (807)	60.20 (1529)	5.49 (139.5)	5.59 (142)	200.2
	517	3	460	25	▲	3492	91.97 (2336)	31.78 (807)	60.20 (1529)	5.49 (139.5)	5.59 (142)	200.2
160S250-14	550	3	230	25	▲	3470	95.75 (2432)	31.78 (807)	63.98 (1625)	5.49 (139.5)	5.59 (142)	204.5
	554	3	460	25	▲	3482	95.75 (2432)	31.78 (807)	63.98 (1625)	5.49 (139.5)	5.59 (142)	204.5

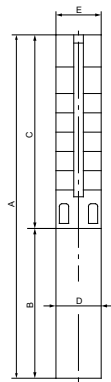

E = Maximum diameter of pump including cable guard and motor

**Notes:**

Control box is required for 3-wire, single-phase applications. Data does not include control box. Performance conforms to ISO 9906. 1999 (E) Annex A. Minimum submergence is 5 ft (1.5 m).

■	MS402 motor
●	MS4000C motor
▲	MS6000C motor

## SP 160S (160 gpm) pump with 6", 8" motor

Pump model	Nom. head [ft]	Ph	Motor			Dimensions [in (mm)]					Net weight (complete) [lb]	160S
			Volts [V]	[Hp]	[rpm]	A	B	C	D	E		
<b>160S - Motor diameter 6 inch, 60 Hz, rated flow rate 160 gpm (3" NPT)</b>												
160S250-15	592	3	230	25	▲	3476	99.53 (2528)	34.14 (807)	67.76 (1721)	5.49 (139.5)	5.59 (142)	208.8
	596	3	460	25	▲	3488	99.53 (2528)	34.14 (807)	67.76 (1721)	5.49 (139.5)	5.59 (142)	208.8
160S300-16	628	3	230	30	▲	3466	105.67 (2684)	34.14 (867)	71.54 (1817)	5.49 (139.5)	5.59 (142)	228.5
	633	3	460	30	▲	3479	105.67 (2684)	34.14 (867)	71.54 (1817)	5.49 (139.5)	5.59 (142)	228.5
160S300-17	664	3	230	30	▲	3456	109.45 (2780)	34.14 (867)	75.32 (1913)	5.49 (139.5)	5.59 (142)	232.8
	670	3	460	30	▲	3471	109.45 (2780)	34.14 (867)	75.32 (1913)	5.49 (139.5)	5.59 (142)	232.8
160S300-18	721	3	460	30	▲	3501	113.23 (2876)	34.14 (867)	79.10 (2009)	5.49 (139.5)	5.59 (142)	237.0
160S400-20	797	3	460	40	▲	3489	125.91 (3198)	39.26 (997)	86.66 (2201)	5.49 (139.5)	5.59 (142)	275.4
160S400-22	871	3	460	40	▲	3476	133.47 (3390)	39.26 (997)	94.22 (2393)	5.49 (139.5)	5.59 (142)	283.9
160S400-24	954	3	460	40	▲	3483	141.0 (3582)	39.26 (997)	101.78 (2585)	5.49 (139.5)	5.59 (142)	292.5
160S500-26	1028	3	460	50	☼	3473	165.44 (4202)	56.11 (1425)	109.34 (2777)	5.67 (144)	5.67 (144)	385.2
160S500-28	1100	3	460	50	☼	3462	167.00 (4262)	50.91 (1293)	116.89 (2969)	5.67 (144)	6.22 (158)	393.5
160S500-29DS	1131	3	460	50	☼	3465	186.18 (4729)	50.91 (1293)	135.28 (3436)	5.67 (144)	6.89 (175)	488.2
160S600-31DS	1209	3	460	60	☼	3455	200.20 (5085)	57.36 (1457)	142.83 (3628)	5.67 (144)	6.89 (175)	500.0
<b>160S - Motor diameter 8 inch, 60 Hz, rated flow rate 160 gpm (3" NPT)</b>												
160S600-33DS	1332	3	460	60	*	3508	200.20 (5085)	50.00 (1270)	147.45 (3745)	7.56 (192)	7.56 (192)	648.5
160S600-36DS	1467	3	460	60	*	3524	211.53 (5373)	52.76 (1340)	158.78 (4033)	7.56 (192)	7.56 (192)	666.1
160S750-39DS	1584	3	460	75	*	3518	226.02 (5741)	55.91 (1420)	170.12 (4321)	7.56 (192)	7.56 (192)	716.9

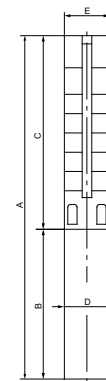

E = Maximum diameter of pump including cable guard and motor

**Notes:**

DS designation = Built into sleeve, 3" NPT, 8" minimum well diameter.

Performance conforms to ISO 9906. 1999 (E) Annex A. Minimum submergence is 5 ft (1.5 m).

▲	MS6000C motor
☼	Takes MMS6 motor; not available as complete.
*	Takes MMS8000 motor; not available as complete.

SP 230S (230 gpm)

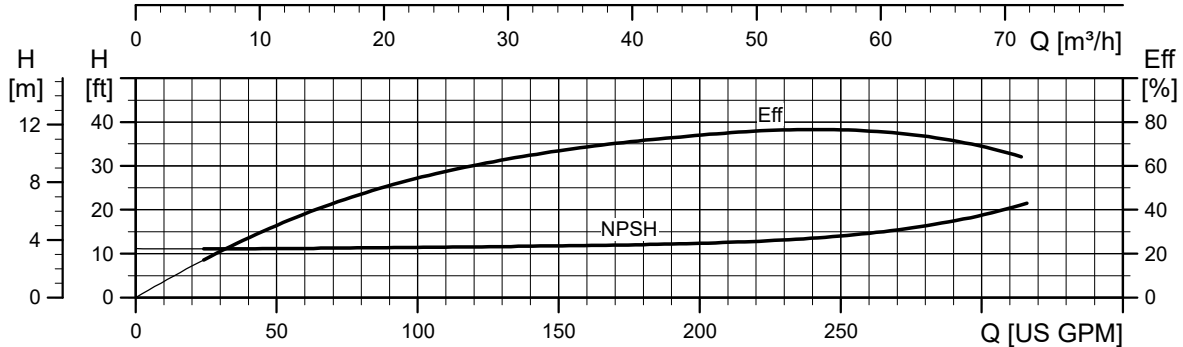
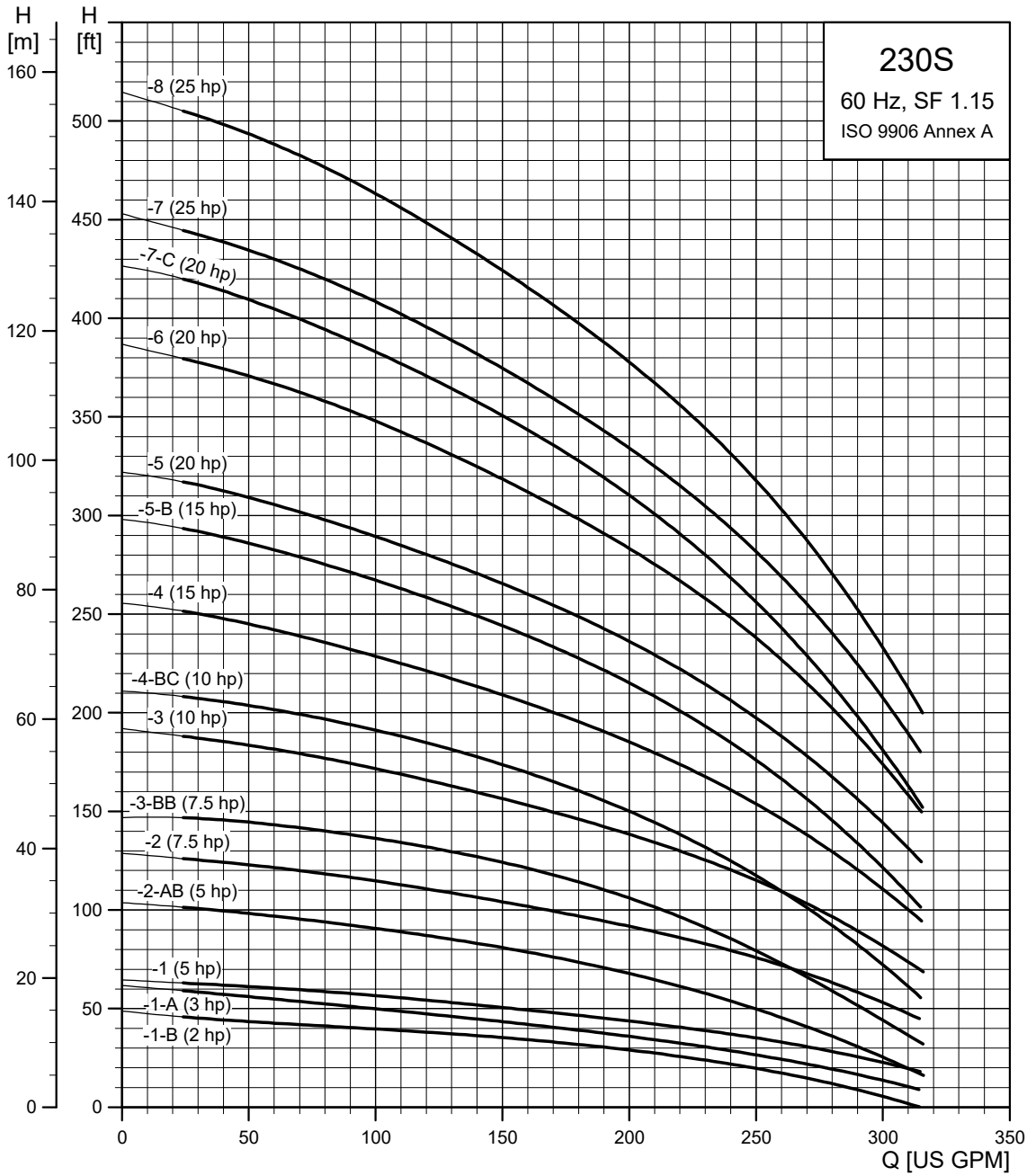

TM050243

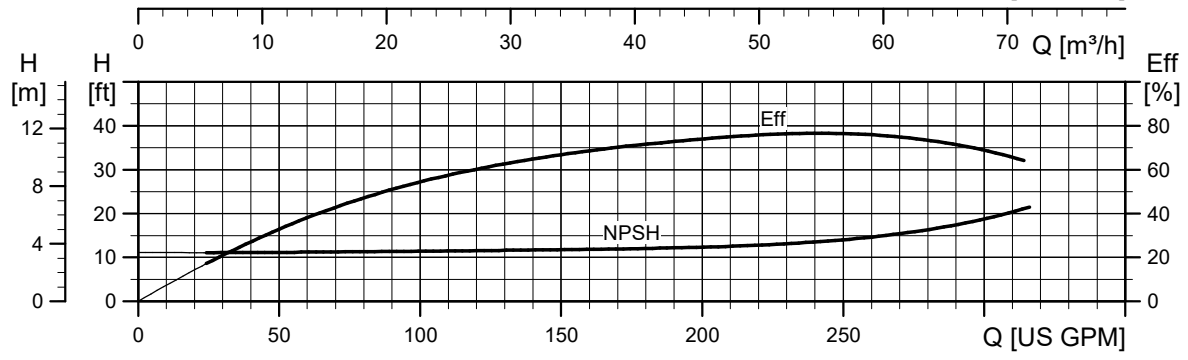
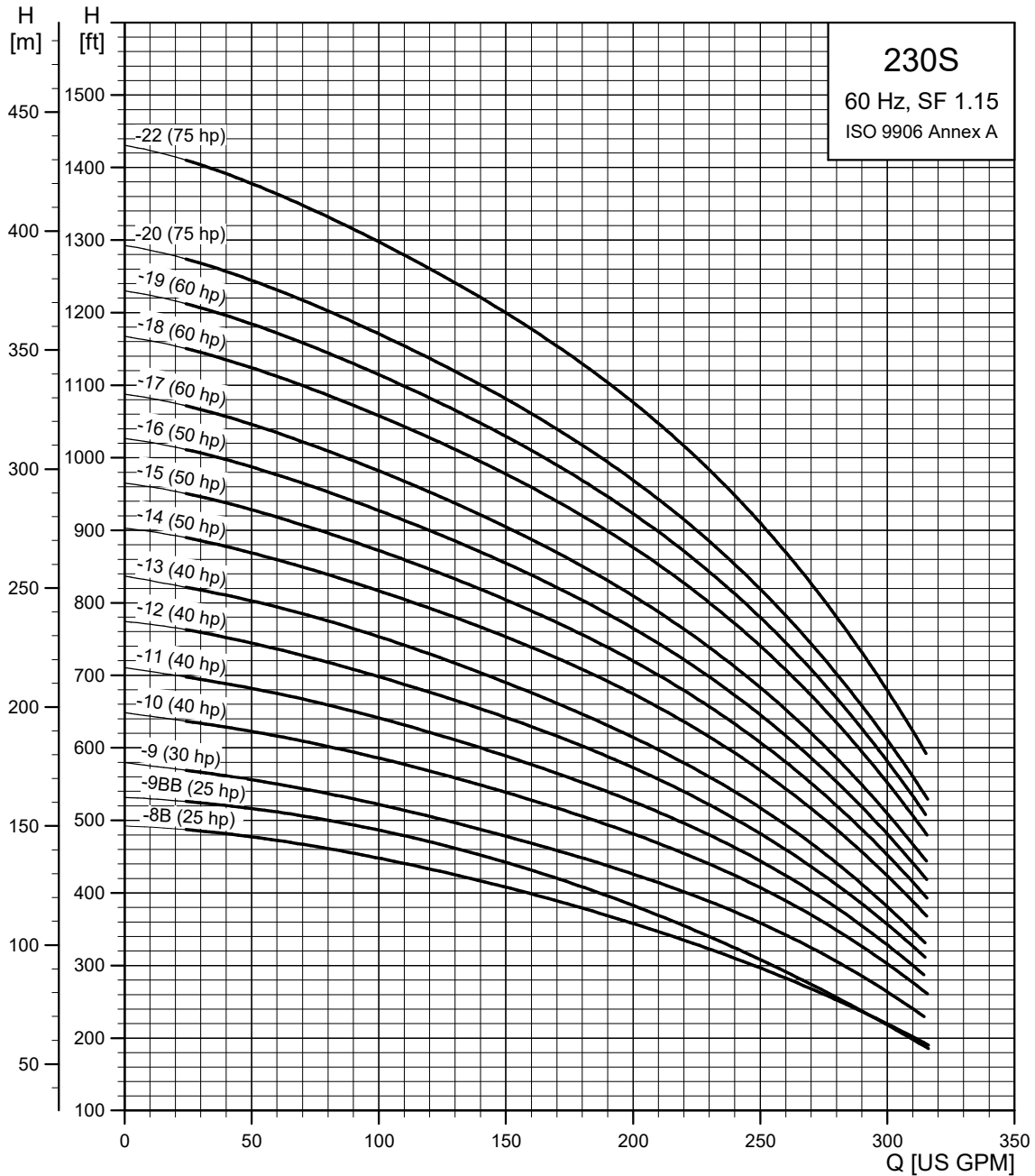

TM050244

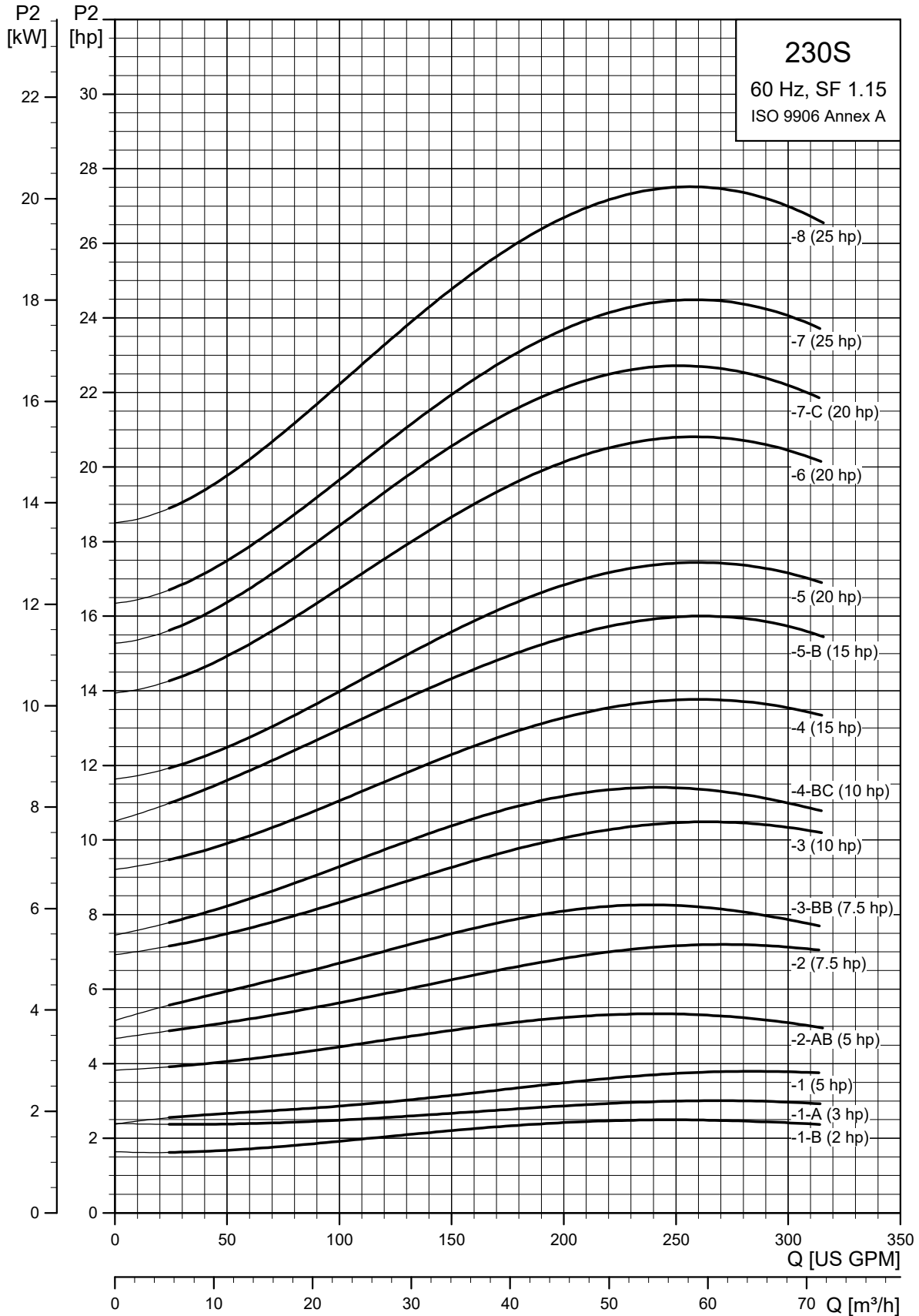

TM050245

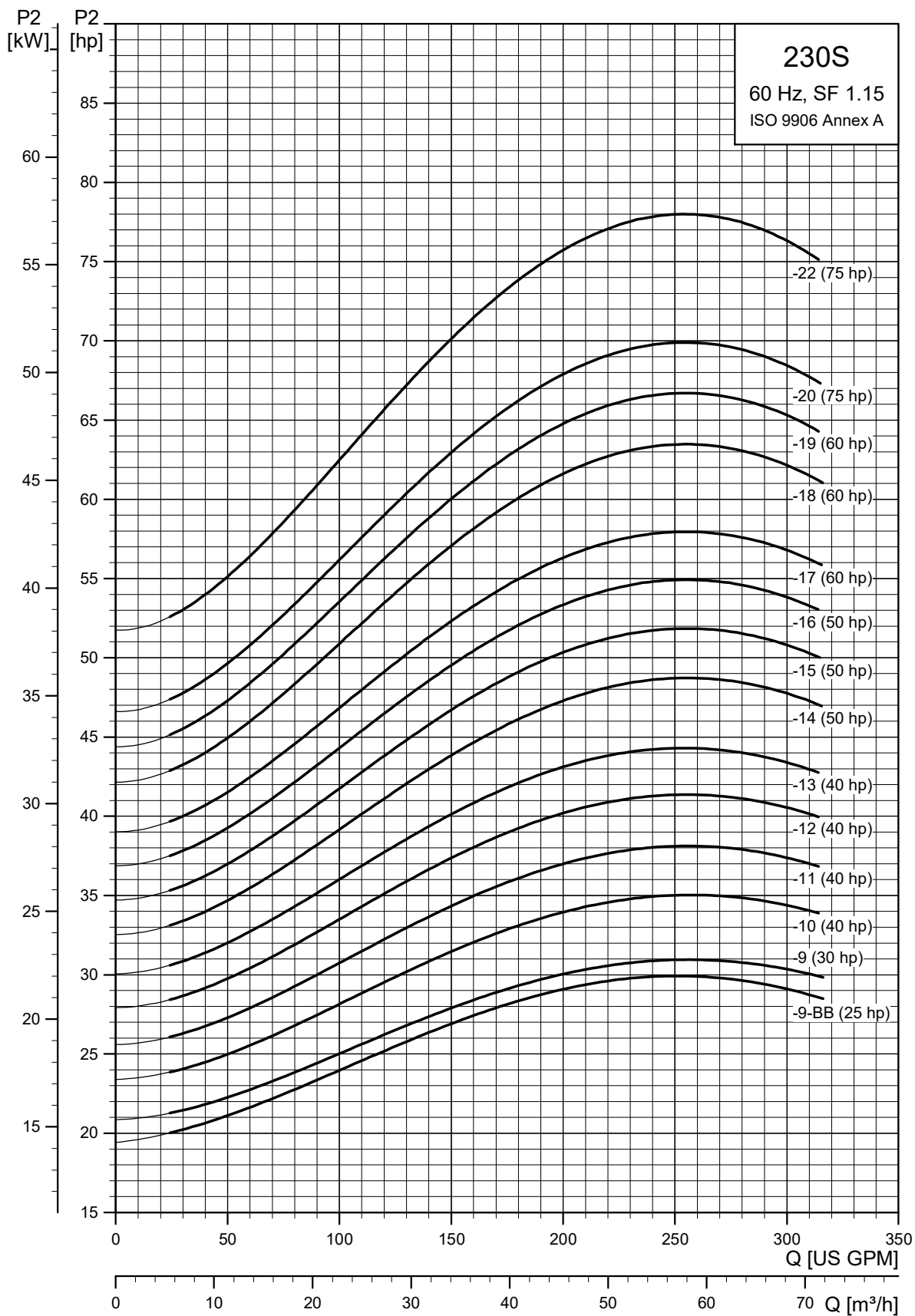

TM050246



**SP 230S (230 gpm) pump with 4", 6" motor**

Pump model	Nom. head [ft]	Ph	Motor			Dimensions [in (mm)]					Net weight (complete) [lb]	230S
			Volts [V]	[Hp]	[rpm]	A	B	C	D	E		
<b>230S - Motor diameter 4-inch, 3-wire motor, 60 Hz, rated flow rate 230 gpm (3" NPT)</b>												
230S20-1B	32	1	230	2	●	3434	34.45 (875)	19.57 (497)	14.89 (378)	3.75 (95)	5.75 (146)	49.5
	32	3	230	2	■	3432	30.12 (765)	15.24 (387)	14.89 (378)	3.75 (95)	5.75 (146)	49.5
	32	3	460	2	■	3432	30.12 (765)	15.24 (387)	14.89 (378)	3.75 (95)	5.75 (146)	49.5
230S30-1A	38	1	230	3	●	3459	37.60 (955)	22.72 (577)	14.89 (378)	3.75 (95)	5.75 (146)	49.5
	38	3	230	3	●	3460	32.84 (834)	17.96 (456)	14.89 (378)	3.75 (95)	5.75 (146)	49.5
	39	3	460	3	●	3489	32.84 (834)	17.96 (456)	14.89 (378)	3.75 (95)	5.75 (146)	49.5
230S50-1	46	1	230	5	●	3516	41.54 (1055)	26.66 (677)	14.89 (378)	3.75 (95)	5.75 (146)	49.5
	46	3	230	5	●	3528	37.56 (954)	22.68 (576)	14.89 (378)	3.75 (95)	5.75 (146)	49.5
	46	3	460	5	●	3527	37.56 (954)	22.68 (576)	14.89 (378)	3.75 (95)	5.75 (146)	49.5
230S50-2AB	71	1	230	5	●	3459	45.99 (1168)	26.66 (677)	19.34 (491)	3.75 (95)	5.75 (146)	49.5
	71	3	230	5	●	3487	42.01 (1067)	22.68 (576)	19.34 (491)	3.75 (95)	5.75 (146)	79.2
	71	3	460	5	●	3484	42.01 (1067)	22.68 (576)	19.34 (491)	3.75 (95)	5.75 (146)	79.2
230S75-2	86	3	230	7.5	●	3488	45.95 (1167)	26.62 (676)	19.34 (491)	3.75 (95)	5.75 (146)	79.2
	86	3	460	7.5	●	3488	45.95 (1167)	26.62 (676)	19.34 (491)	3.75 (95)	5.75 (146)	79.2
230S75-3BB	110	3	230	7.5	●	3468	50.40 (1280)	26.62 (676)	23.78 (604)	3.75 (95)	5.75 (146)	126.0
	110	3	460	7.5	●	3468	50.40 (1280)	26.62 (676)	23.78 (604)	3.75 (95)	5.75 (146)	126.0
230S100-3	129	3	460	10	●	3472	54.34 (1380)	30.56 (776)	23.78 (604)	3.75 (95)	5.75 (146)	126.0
230S100-4BC	141	3	460	10	●	3456	58.78 (1493)	30.56 (776)	28.23 (717)	3.75 (95)	5.75 (146)	144.9
<b>230S - Motor diameter 6 inch, 60 Hz, rated flow rate 230 gpm (3" NPT)</b>												
230S75-2	87	3	230	7.5	▲	3496	43.47 (1104)	23.51 (597)	19.97 (507)	5.52 (140)	5.79 (147)	111.6
	87	3	460	7.5	▲	3505	43.47 (1104)	23.51 (597)	19.97 (507)	5.52 (140)	5.79 (147)	111.6
230S75-3BB	111	3	230	7.5	▲	3477	47.92 (1217)	23.51 (597)	24.41 (620)	5.52 (140)	5.79 (147)	131.4
	111	3	460	7.5	▲	3488	47.92 (1217)	23.51 (597)	24.41 (620)	5.52 (140)	5.79 (147)	131.4
230S100-3	129	3	230	10	▲	3474	49.10 (1247)	24.69 (627)	24.41 (620)	5.52 (140)	5.79 (147)	126.0
	130	3	460	10	▲	3486	49.10 (1247)	24.69 (627)	24.41 (620)	5.52 (140)	5.79 (147)	126.0
230S100-4BC	141	3	230	10	▲	3457	53.55 (1360)	24.69 (627)	28.86 (733)	5.52 (140)	5.79 (147)	144.9
	143	3	460	10	▲	3472	53.55 (1360)	24.69 (627)	28.86 (733)	5.52 (140)	5.79 (147)	144.9
230S150-4	176	3	230	15	▲	3491	55.91 (1420)	27.05 (687)	28.86 (733)	5.52 (140)	5.79 (147)	144.9
	176	3	460	15	▲	3495	55.91 (1420)	27.05 (687)	28.86 (733)	5.52 (140)	5.79 (147)	144.9
230S150-5B	202	3	230	15	▲	3470	60.36 (1533)	27.05 (687)	33.31 (846)	5.52 (140)	5.79 (147)	161.1
	202	3	460	15	▲	3476	60.36 (1533)	27.05 (687)	33.31 (846)	5.52 (140)	5.79 (147)	161.1
230S200-5	222	3	230	20	▲	3499	62.92 (1598)	29.61 (752)	33.31 (846)	5.52 (140)	5.79 (147)	161.1
	224	3	460	20	▲	3508	62.92 (1598)	29.61 (752)	33.31 (846)	5.52 (140)	5.79 (147)	161.1
230S200-6	248	3	230	20	▲	3476	67.37 (1711)	29.61 (752)	37.76 (959)	5.52 (140)	5.79 (147)	167.4
	252	3	460	20	▲	3488	67.37 (1711)	29.61 (752)	37.76 (959)	5.52 (140)	5.79 (147)	167.4
230S200-7C	288	3	230	20	▲	3462	71.82 (1824)	29.61 (752)	42.21 (1072)	5.52 (140)	5.79 (147)	181.8
	291	3	460	20	▲	3475	71.82 (1824)	29.61 (752)	42.21 (1072)	5.52 (140)	5.79 (147)	181.8

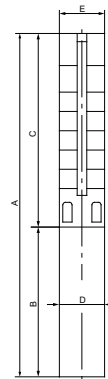

E = Maximum diameter of pump including cable guard and motor

**Notes:**

Control box is required for 3-wire, single-phase applications. Data does not include control box.  
 Performance conforms to ISO 9906. 1999 (E) Annex A. Minimum submergence is 8 ft (2.4 m).

■	MS402 motor
●	MS4000C motor
▲	MS6000C motor

**SP 230S (230 gpm) pump with 6", 8" motor**

Pump model	Nom. head [ft]	Ph	Motor			Dimensions [in (mm)]					Net weight (complete) [lb]	230S
			Volts [V]	[Hp]	[rpm]	A	B	C	D	E		
<b>230S - Motor diameter 6 inch, 60 Hz, rated flow rate 230 gpm (3" NPT)</b>												
230S250-7	291	3	230	25	▲	3487	73.98 (1879)	31.78 (807)	42.21 (1072)	5.52 (140)	5.79 (147)	149.9
	294	3	460	25	▲	3497	73.98 (1879)	31.78 (807)	42.21 (1072)	5.52 (140)	5.79 (147)	181.8
230S250-8B	315	3	230	25	▲	3476	78.43 (1992)	31.78 (807)	46.66 (1185)	5.52 (140)	5.79 (147)	188.1
	316	3	460	25	▲	3487	78.43 (1992)	31.78 (807)	46.66 (1185)	5.52 (140)	5.79 (147)	188.1
230S250-8	329	3	230	25	▲	3469	78.43 (1992)	31.78 (807)	46.66 (1185)	5.52 (140)	5.79 (147)	188.1
	332	3	460	25	▲	3482	78.43 (1992)	31.78 (807)	46.66 (1185)	5.52 (140)	5.79 (147)	188.1
230S250-9BB	363	3	230	25	▲	3463	82.88 (2105)	31.78 (807)	51.11 (1298)	5.52 (140)	5.79 (147)	205.2
	366	3	460	25	▲	3476	82.88 (2105)	31.78 (807)	51.11 (1298)	5.52 (140)	5.79 (147)	205.2
230S300-9	368	3	230	30	▲	3468	85.24 (2165)	34.14 (867)	51.11 (1298)	5.52 (140)	5.79 (147)	205.2
	374	3	460	30	▲	3481	85.24 (2165)	34.14 (867)	51.11 (1298)	5.52 (140)	5.79 (147)	205.2
230S400-10	414	3	460	40	▲	3476	94.81 (2408)	39.26 (997)	55.56 (1411)	5.52 (140)	5.79 (147)	241.2
230S400-11	457	3	460	40	▲	3493	99.26 (2521)	39.26 (997)	60.00 (1524)	5.52 (140)	5.79 (147)	245.7
230S400-12	495	3	460	40	▲	3482	103.71 (2634)	39.26 (997)	64.45 (1637)	5.52 (140)	5.79 (147)	251.1
230S400-13	533	3	460	40	▲	3472	108.15 (2747)	39.26 (997)	68.90 (1750)	5.52 (140)	5.79 (147)	255.6
230S500-14	577	3	460	50	☼	3481	129.45 (3288)	56.11 (1425)	73.35 (1863)	5.67 (144)	5.79 (147)	356.0
230S500-15	615	3	460	50	☼	3471	133.90 (3401)	56.11 (1425)	77.80 (1976)	5.67 (144)	5.79 (147)	360.5
230S500-16	653	3	460	50	☼	3462	138.35 (3514)	56.11 (1425)	82.25 (2089)	5.67 (144)	5.79 (147)	365.0
230S600-17	700	3	460	60	☼	3460	142.81 (3647)	56.11 (1425)	86.70 (2202)	5.67 (144)	5.79 (147)	381.0
230S600-18	742	3	460	60	☼	3452	147.26 (3740)	56.11 (1425)	91.15 (2315)	5.67 (144)	5.79 (147)	386.0
230S600-19	783	3	460	60	☼	3444	151.71 (3853)	56.11 (1425)	95.60 (2428)	5.67 (144)	5.79 (147)	391.0
<b>230S - Motor diameter 8 inch, 60 Hz, rated flow rate 230 gpm (3" NPT)</b>												
230S600-17	700	3	460	60	*	3460	138.47 (3517)	50.00 (1270)	88.47 (2247)	7.56 (192)	7.56 (192)	546.0
230S600-18	741	3	460	60	*	3452	142.92 (3630)	50.00 (1270)	92.92 (2360)	7.56 (192)	7.56 (192)	568.5
230S600-19	783	3	460	60	*	3444	147.37 (3743)	50.00 (1270)	97.37 (2473)	7.56 (192)	7.56 (192)	591.0
230S750-20DS	850	3	460	75	*	3526	164.69 (4183)	53.15 (1350)	111.54 (2833)	7.56 (192)	7.56 (192)	549.9
230S750-22DS	931	3	460	75	*	3519	173.59 (4409)	53.15 (1350)	120.44 (3059)	7.56 (192)	7.56 (192)	620.4

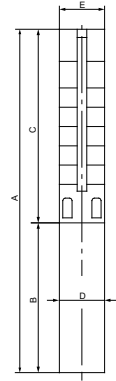

E = Maximum diameter of pump including cable guard and motor

**Notes:**

Control box is required for 3-wire, single-phase applications. Data does not include control box.  
 DS designation = Built into sleeve, 3" NPT, 8" minimum well diameter.  
 Performance conforms to ISO 9906. 1999 (E) Annex A. Minimum submergence is 8 ft (2.4 m).

▲	MS6000C motor
☼	Takes MMS6 motor; not available as complete.
*	Takes MMS8000 motor; not available as complete.

SP 300S (300 gpm)

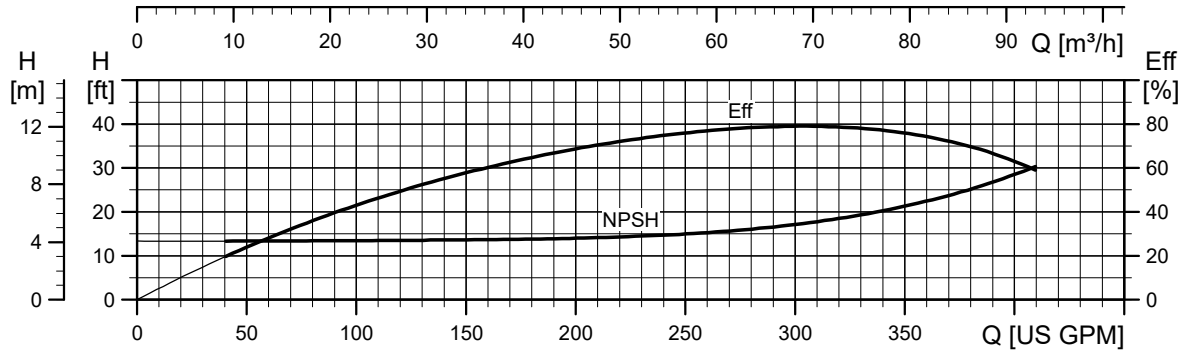
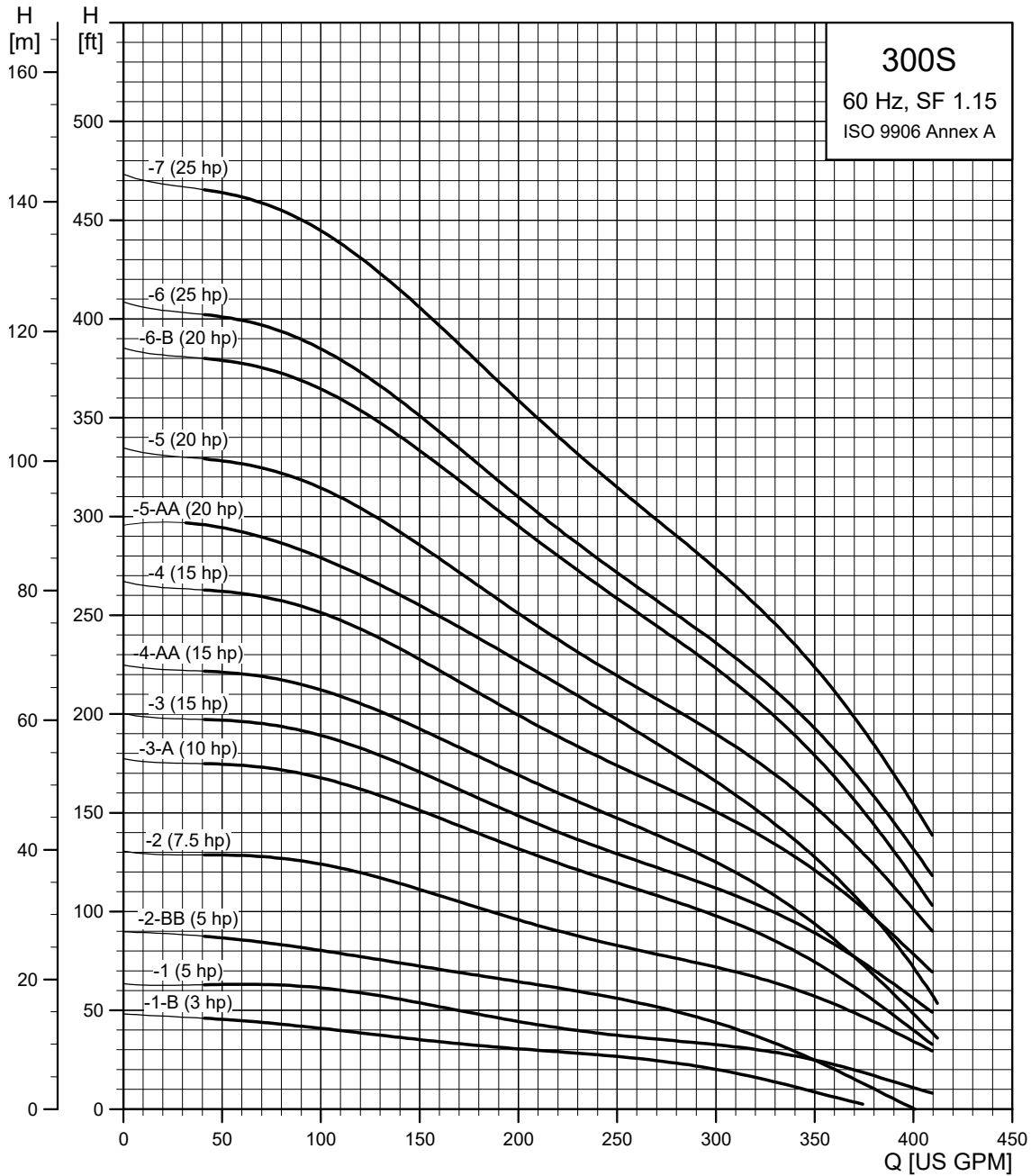

TM050247

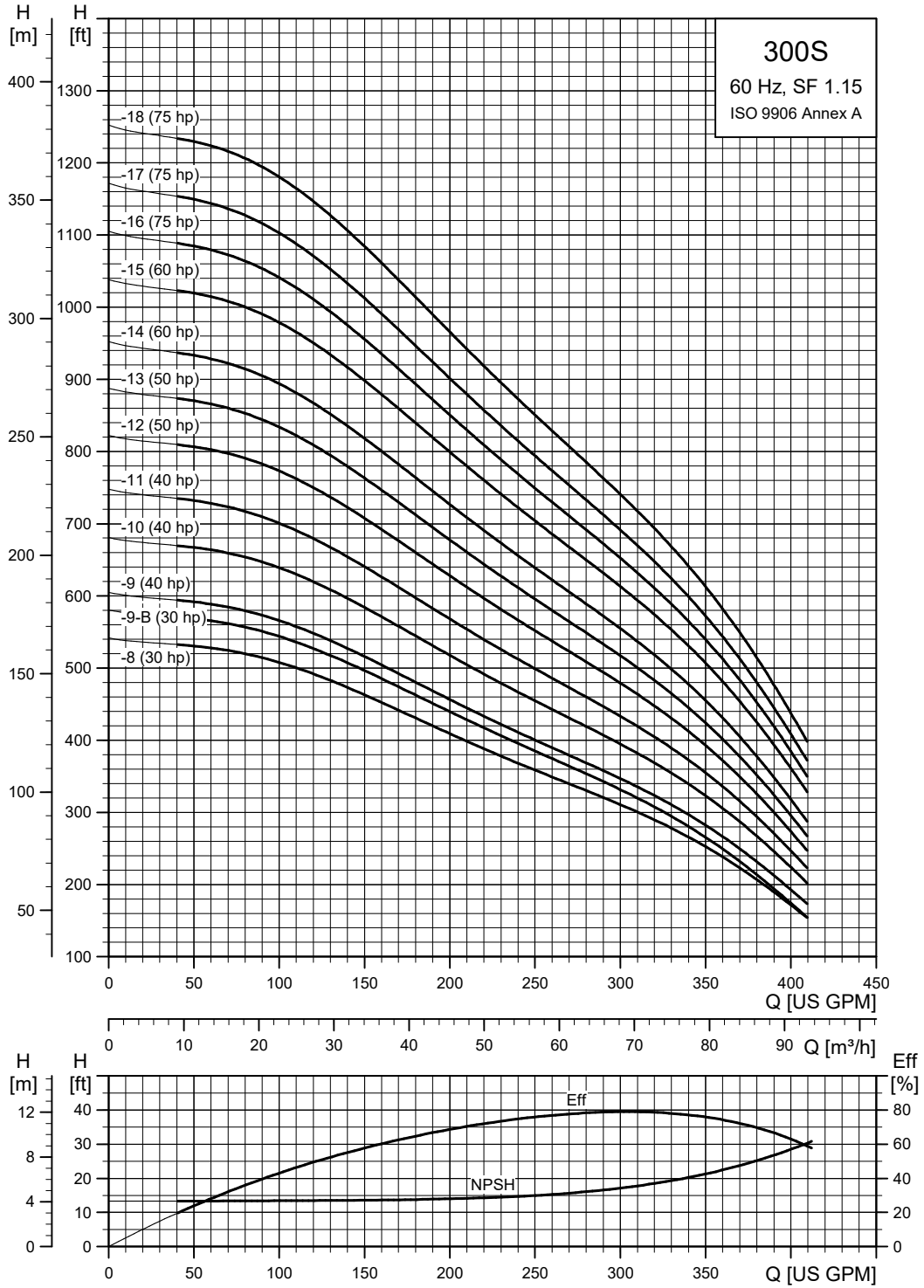

TM050248

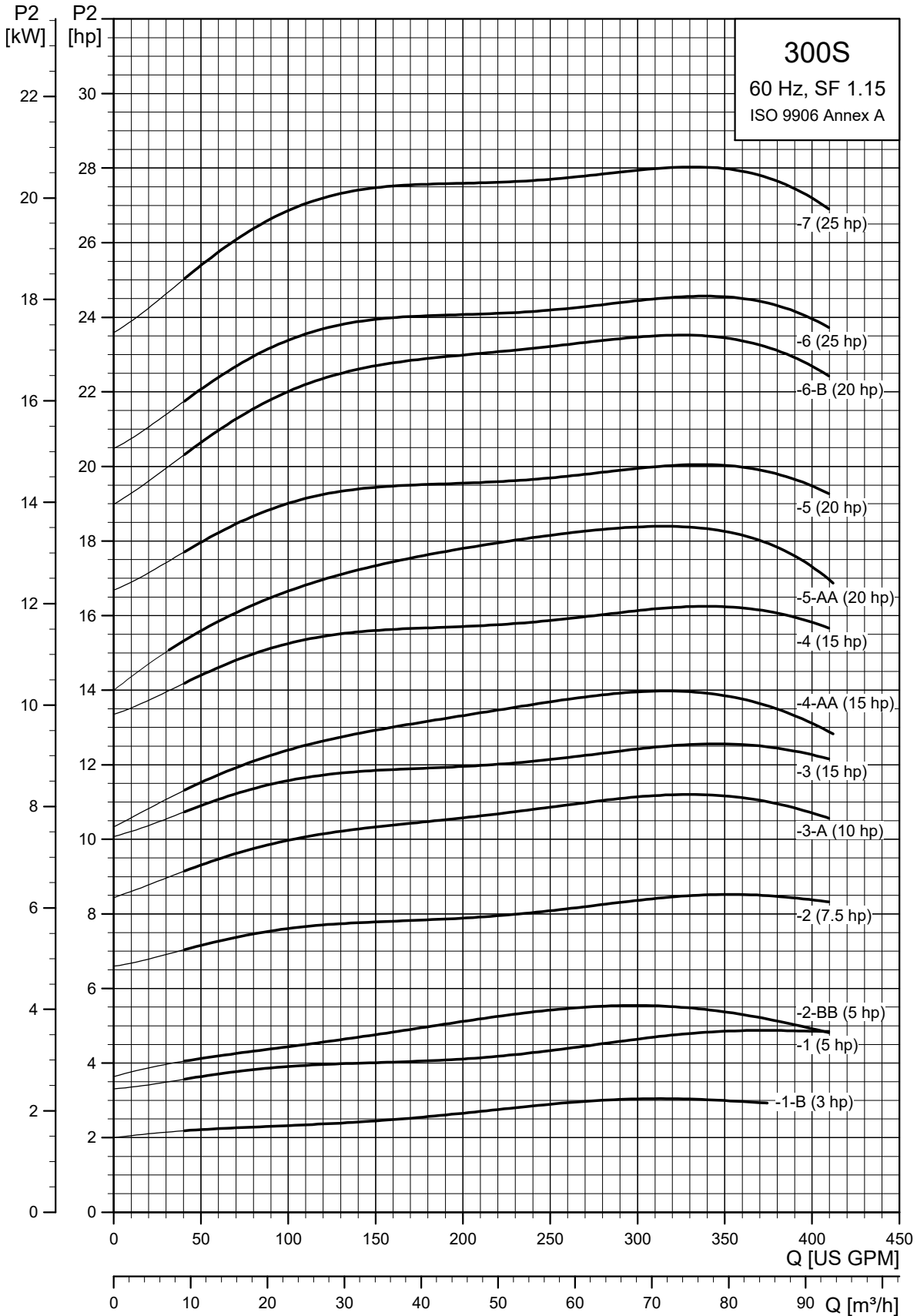

TM050249

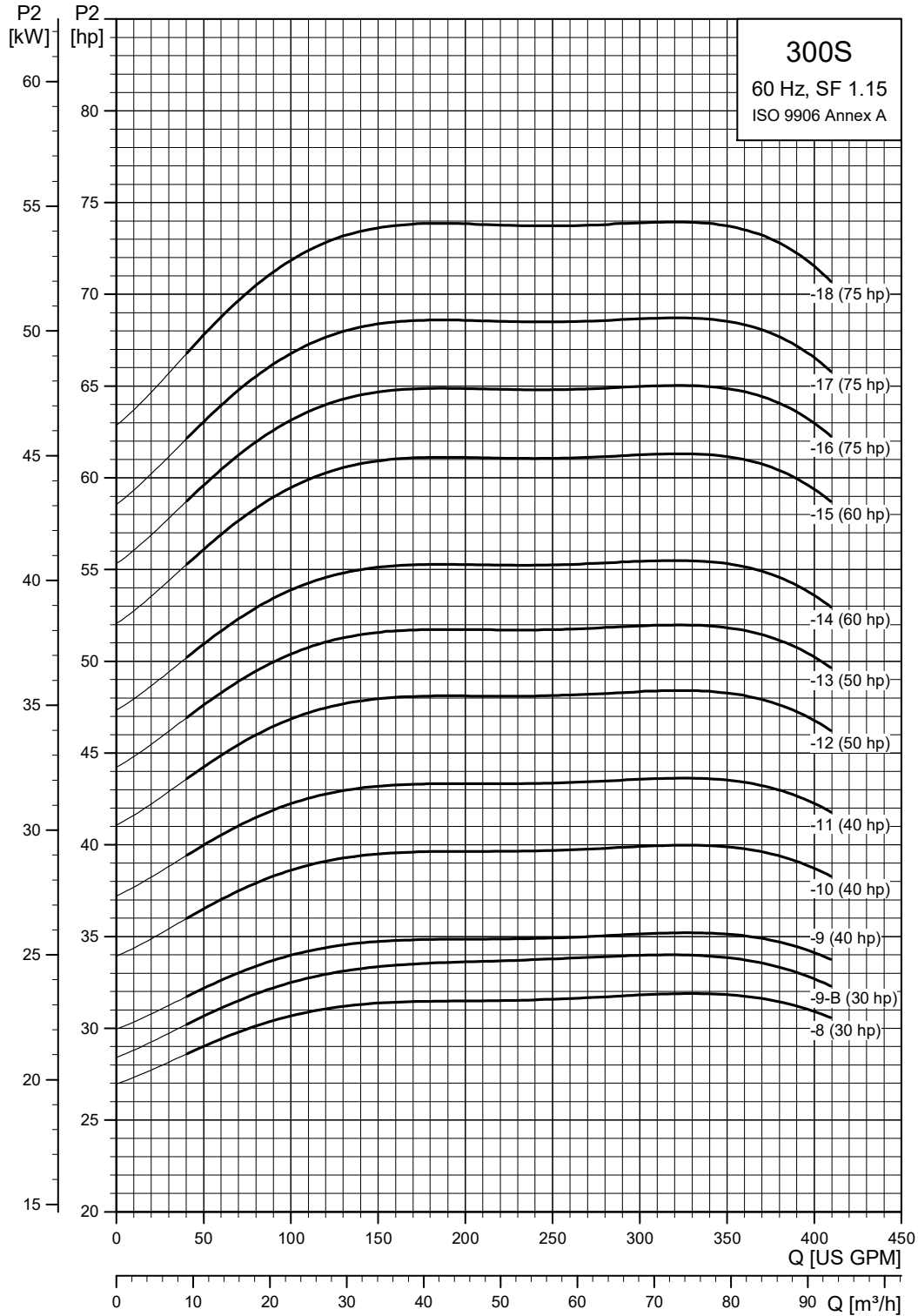

TM050250

**SP 300S (300 gpm) pump with 4", 6" motor**

Pump model	Nom. head [ft]	Motor				Dimensions [in (mm)]					Net weight (complete) [lb]	300S
		Ph	Volts [V]	[Hp]	[rpm]	A	B	C	D	E		
<b>300S - Motor diameter 4-inch, 3-wire motor, 60 Hz, rated flow rate 300 gpm (3" NPT)</b>												
300S30-1B	29	1	230	3	●	3470	37.60 (955)	22.72 (577)	14.89 (378)	3.75 (95)	5.75 (146)	72.0
	30	3	230	3	●	3466	32.84 (834)	17.96 (456)	14.89 (378)	3.75 (95)	5.75 (146)	72.0
	30	3	460	3	●	3494	32.84 (834)	17.96 (456)	14.89 (378)	3.75 (95)	5.75 (146)	72.0
300S50-1	38	1	230	5	●	3490	41.54 (1055)	26.66 (677)	14.89 (378)	3.75 (95)	5.75 (146)	74.7
	38	3	230	5	●	3508	37.56 (954)	22.68 (576)	14.89 (378)	3.75 (95)	5.75 (146)	74.7
	38	3	460	5	●	3506	37.56 (954)	22.68 (576)	14.89 (378)	3.75 (95)	5.75 (146)	74.7
300S50-2BB	57	1	230	5	●	3443	45.99 (1168)	26.66 (677)	19.34 (491)	3.75 (95)	5.75 (146)	135.0
	57	3	230	5	●	3480	42.01 (1067)	22.68 (576)	19.34 (491)	3.75 (95)	5.75 (146)	135.0
	57	3	460	5	●	3477	42.01 (1067)	22.68 (576)	19.34 (491)	3.75 (95)	5.75 (146)	135.0
300S75-2	77	3	230	7.5	●	3463	45.95 (1167)	26.62 (676)	19.34 (491)	3.75 (95)	5.75 (146)	101.7
	77	3	460	7.5	●	3463	45.95 (1167)	26.62 (676)	19.34 (491)	3.75 (95)	5.75 (146)	101.7
300S100-3A	107	3	460	10	●	3461	54.34 (1380)	30.56 (776)	23.78 (604)	3.75 (95)	5.75 (146)	145.8
<b>300S - Motor diameter 6 inch, 60 Hz, rated flow rate 300 gpm (3" NPT)</b>												
300S75-2	77	3	230	7.5	▲	3472	43.47 (1104)	23.51 (597)	19.97 (507)	5.52 (140)	5.79 (147)	167.4
	78	3	460	7.5	▲	3484	43.47 (1104)	23.51 (597)	19.97 (507)	5.52 (140)	5.79 (147)	167.4
300S100-3A	107	3	230	10	▲	3461	49.10 (1247)	24.69 (627)	24.41 (620)	5.52 (140)	5.79 (147)	216.0
	107	3	460	10	▲	3475	49.10 (1247)	24.69 (627)	24.41 (620)	5.52 (140)	5.79 (147)	216.0
300S150-3	119	3	230	15	▲	3503	51.46 (1307)	27.05 (687)	24.41 (620)	5.52 (140)	5.79 (147)	216.0
	119	3	460	15	▲	3506	51.46 (1307)	27.05 (687)	24.41 (620)	5.52 (140)	5.79 (147)	216.0
300S150-4AA	138	3	230	15	▲	3488	55.91 (1420)	27.05 (687)	28.86 (733)	5.52 (140)	5.79 (147)	222.3
	139	3	460	15	▲	3492	55.91 (1420)	27.05 (687)	28.86 (733)	5.52 (140)	5.79 (147)	222.3
300S150-4	157	3	230	15	▲	3469	55.91 (1420)	27.05 (687)	28.86 (733)	5.52 (140)	5.79 (147)	222.3
	158	3	460	15	▲	3474	55.91 (1420)	27.05 (687)	28.86 (733)	5.52 (140)	5.79 (147)	222.3
300S200-5AA	179	3	230	20	▲	3493	62.92 (1598)	29.61 (752)	33.31 (846)	5.52 (140)	5.79 (147)	194.4
	180	3	460	20	▲	3503	62.92 (1598)	29.61 (752)	33.31 (846)	5.52 (140)	5.79 (147)	194.4
300S200-5	200	3	230	20	▲	3479	62.92 (1598)	29.61 (752)	33.31 (846)	5.52 (140)	5.79 (147)	194.4
	201	3	460	20	▲	3491	62.92 (1598)	29.61 (752)	33.31 (846)	5.52 (140)	5.79 (147)	194.4
300S200-6B	222	3	230	20	▲	3462	67.37 (1711)	29.61 (752)	37.76 (959)	5.52 (140)	5.79 (147)	198.0
	224	3	460	20	▲	3476	67.37 (1711)	29.61 (752)	37.76 (959)	5.52 (140)	5.79 (147)	198.0
300S250-6	243	3	230	25	▲	3487	69.53 (1766)	31.78 (807)	37.76 (959)	5.52 (140)	5.79 (147)	198.0
	244	3	460	25	▲	3497	69.53 (1766)	31.78 (807)	37.76 (959)	5.52 (140)	5.79 (147)	198.0

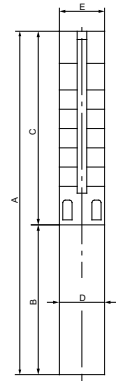

E = Maximum diameter of pump including cable guard and motor

**Notes:**

Performance conforms to ISO 9906, 1999 (E) Annex A. Minimum submergence is 8 ft (2.4 m).

- MS4000C motor
- ▲ MS6000C motor

## SP 300S (300 gpm) pump with 6", 8" motor

Pump model	Nom. head [ft]	Ph	Motor			Dimensions [in (mm)]					Net weight (complete) [lb]	300S
			Volts [V]	[Hp]	[rpm]	A	B	C	D	E		
<b>300S - Motor diameter 6 inch, 60 Hz, rated flow rate 300 gpm (4" NPT)</b>												
300S250-7AA	260	3	230	25	▲	3478	73.98 (1879)	31.78 (807)	42.21 (1072)	5.52 (140)	5.79 (147)	217.8
	262	3	460	25	▲	3489	73.98 (1879)	31.78 (807)	42.21 (1072)	5.52 (140)	5.79 (147)	217.8
300S300-7	283	3	230	30	▲	3482	76.34 (1939)	34.14 (867)	42.21 (1072)	5.52 (140)	5.79 (147)	217.8
	285	3	460	30	▲	3493	76.34 (1939)	34.14 (867)	42.21 (1072)	5.52 (140)	5.79 (147)	217.8
300S300-8	321	3	230	30	▲	3463	80.79 (2052)	34.14 (867)	46.66 (1185)	5.52 (140)	5.79 (147)	224.1
	324	3	460	30	▲	3477	80.79 (2052)	34.14 (867)	46.66 (1185)	5.52 (140)	5.79 (147)	224.1
300S300-9B	343	3	230	30	▲	3450	85.24 (2165)	34.14 (867)	51.11 (1298)	5.52 (140)	5.79 (147)	261.0
	346	3	460	30	▲	3466	85.24 (2165)	34.14 (867)	51.11 (1298)	5.52 (140)	5.79 (147)	261.0
300S400-9	370	3	460	40	▲	3499	90.36 (2295)	39.26 (997)	51.11 (1298)	5.52 (140)	5.79 (147)	296.0
300S400-10	409	3	460	40	▲	3487	94.81 (2408)	39.26 (997)	55.56 (1411)	5.52 (140)	5.79 (147)	300.5
300S400-11	442	3	460	40	☼	3443	99.26 (2521)	39.26 (997)	60.00 (1524)	5.52 (140)	5.79 (147)	352.0
300S500-12	491	3	460	50	☼	3482	120.56 (3062)	56.11 (1425)	64.45 (1637)	5.67 (144)	5.79 (147)	348.8
300S500-13	529	3	460	50	☼	3471	125.00 (3175)	56.11 (1425)	68.90 (1750)	5.67 (144)	5.79 (147)	355.1
300S600-14	594	3	460	60	☼	3456	129.46 (3288)	56.11 (1425)	73.35 (1863)	5.67 (144)	5.79 (147)	371.0
300S600-15	606	3	460	60	☼	3458	133.91 (3401)	56.11 (1425)	77.80 (1976)	5.67 (144)	5.79 (147)	378.0
<b>SP 300S - Motor diameter 8 inch, 60 Hz, rated flow rate 230 gpm (4" NPT)</b>												
300S600-14	594	3	460	60	*	3456	125.12 (3178)	50.00 (1270)	75.12 (1908)	7.56 (192)	7.56 (192)	479.4
300S600-15	629	3	460	60	*	3515	129.57 (3291)	50.00 (1270)	79.57 (2021)	7.56 (192)	7.56 (192)	519.4
300S750-16	678	3	460	75	*	3532	137.17 (3484)	53.15 (1350)	84.02 (2134)	7.56 (192)	7.56 (192)	569.1
300S750-17	719	3	460	75	*	3528	141.62 (3597)	53.15 (1350)	88.47 (2247)	7.56 (192)	7.56 (192)	575.4
300S750-18	760	3	460	75	*	3523	146.07 (3710)	53.15 (1350)	92.92 (2360)	7.56 (192)	7.56 (192)	581.7

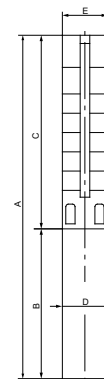

E = Maximum diameter of pump including cable guard and motor

**Notes:**

Performance conforms to ISO 9906 Annex A. Minimum submergence is 8 ft (2.4 m).

▲	MS6000C motor
☼	Takes MMS6 motor; not available as complete.
*	Takes MMS8000 motor; not available as complete.



8" and larger wells  
 SP 385S (385 gpm)

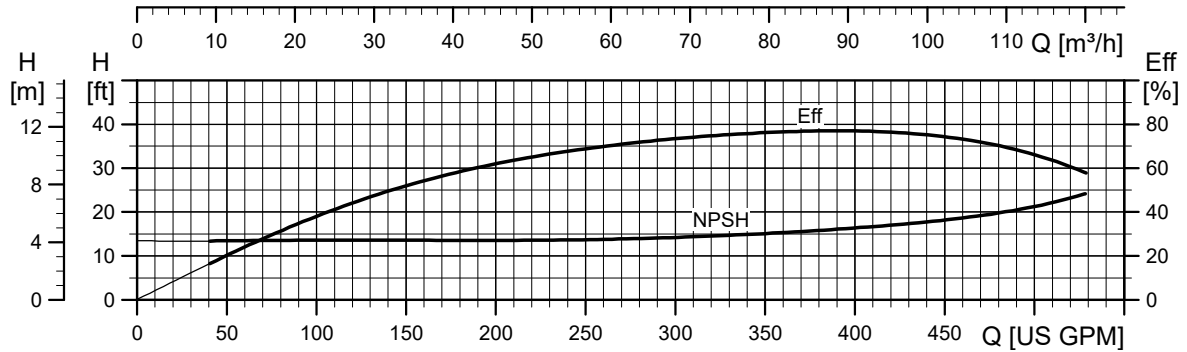
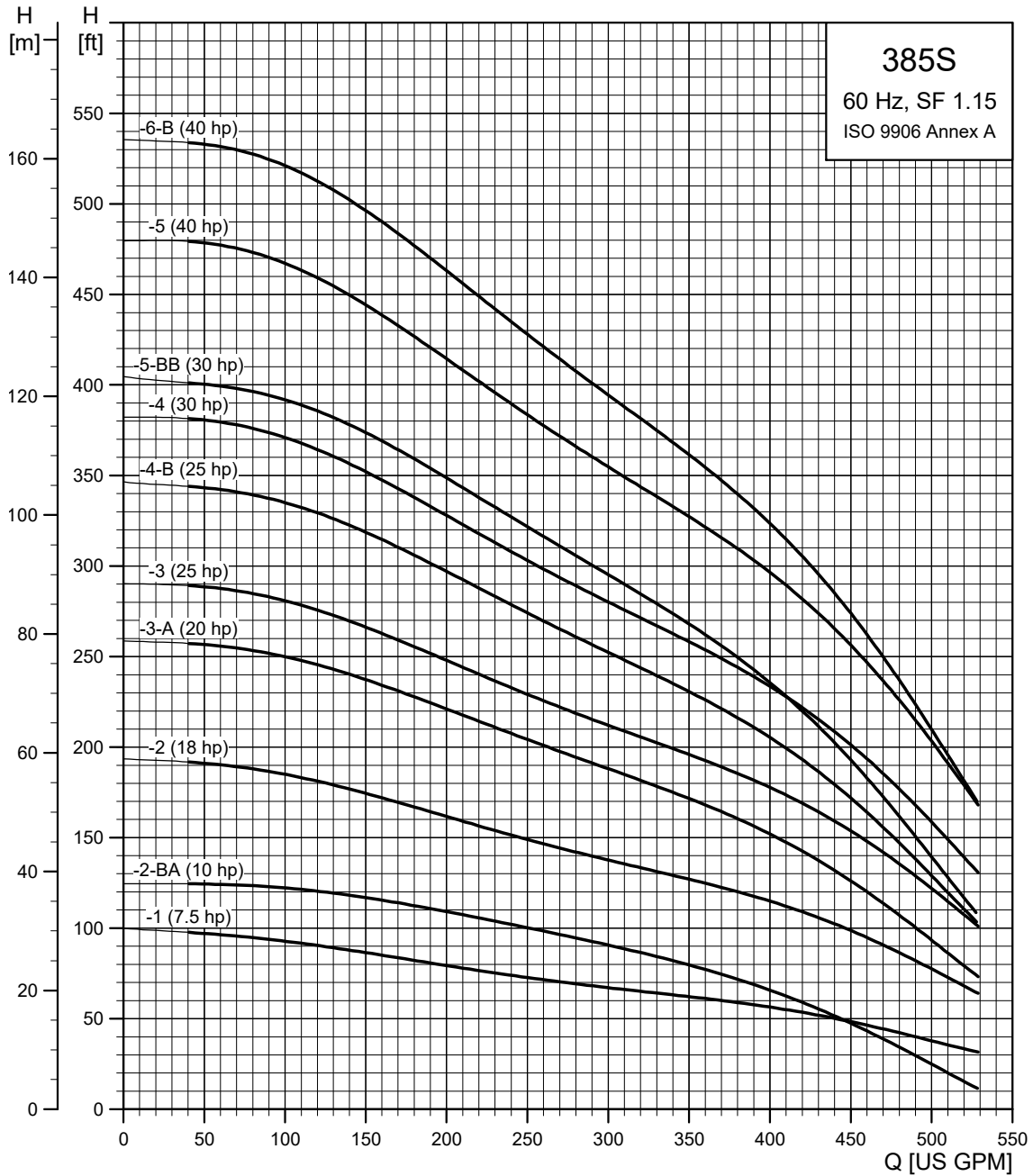

TM050251

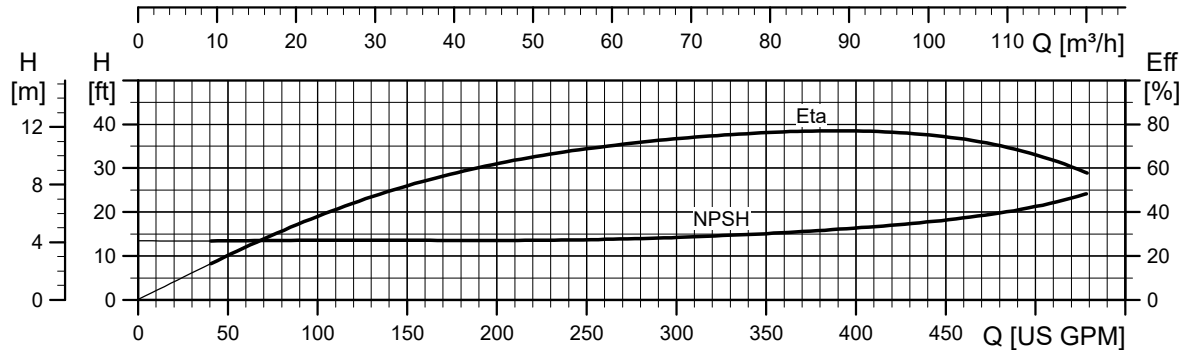
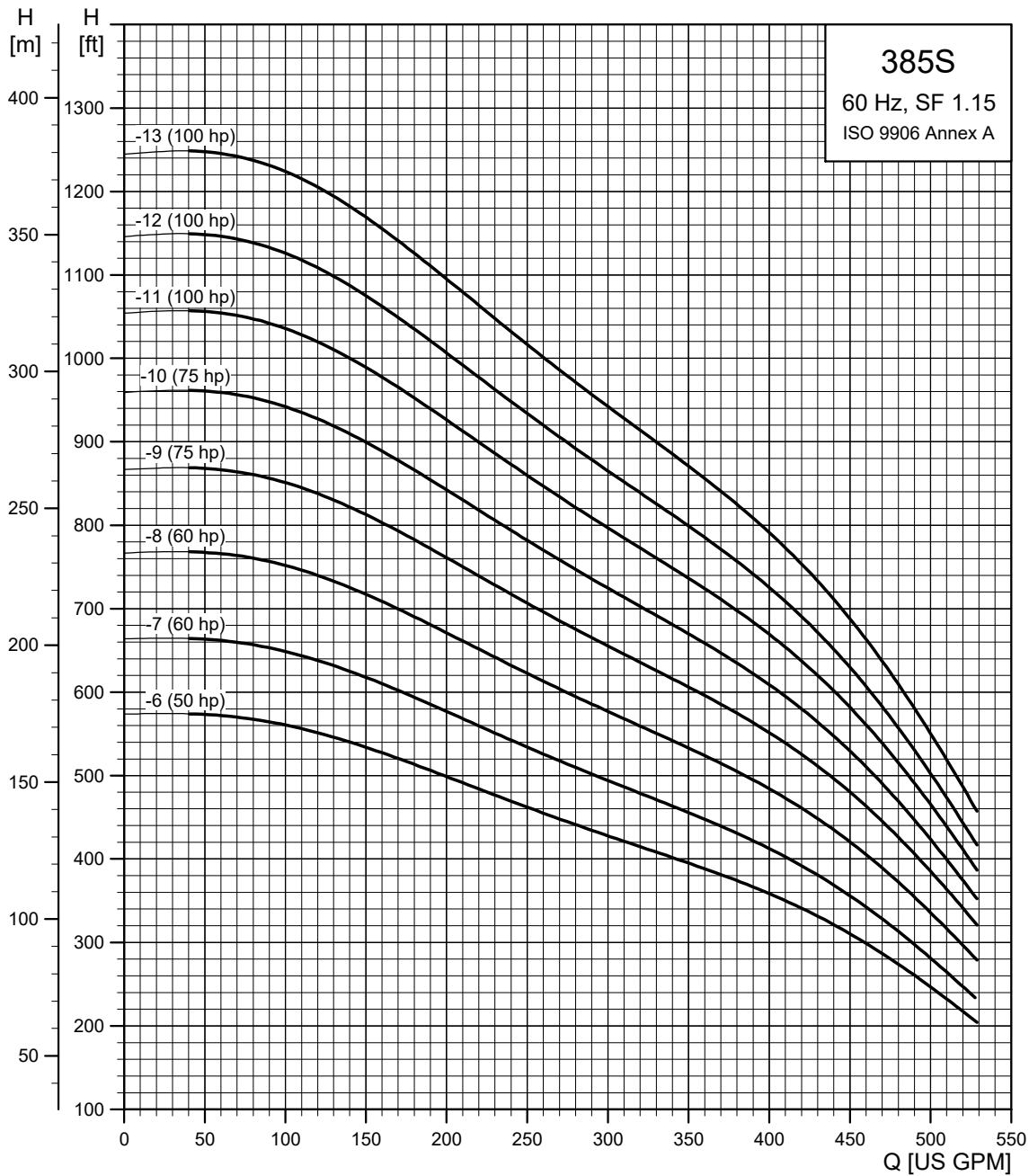

TM050252

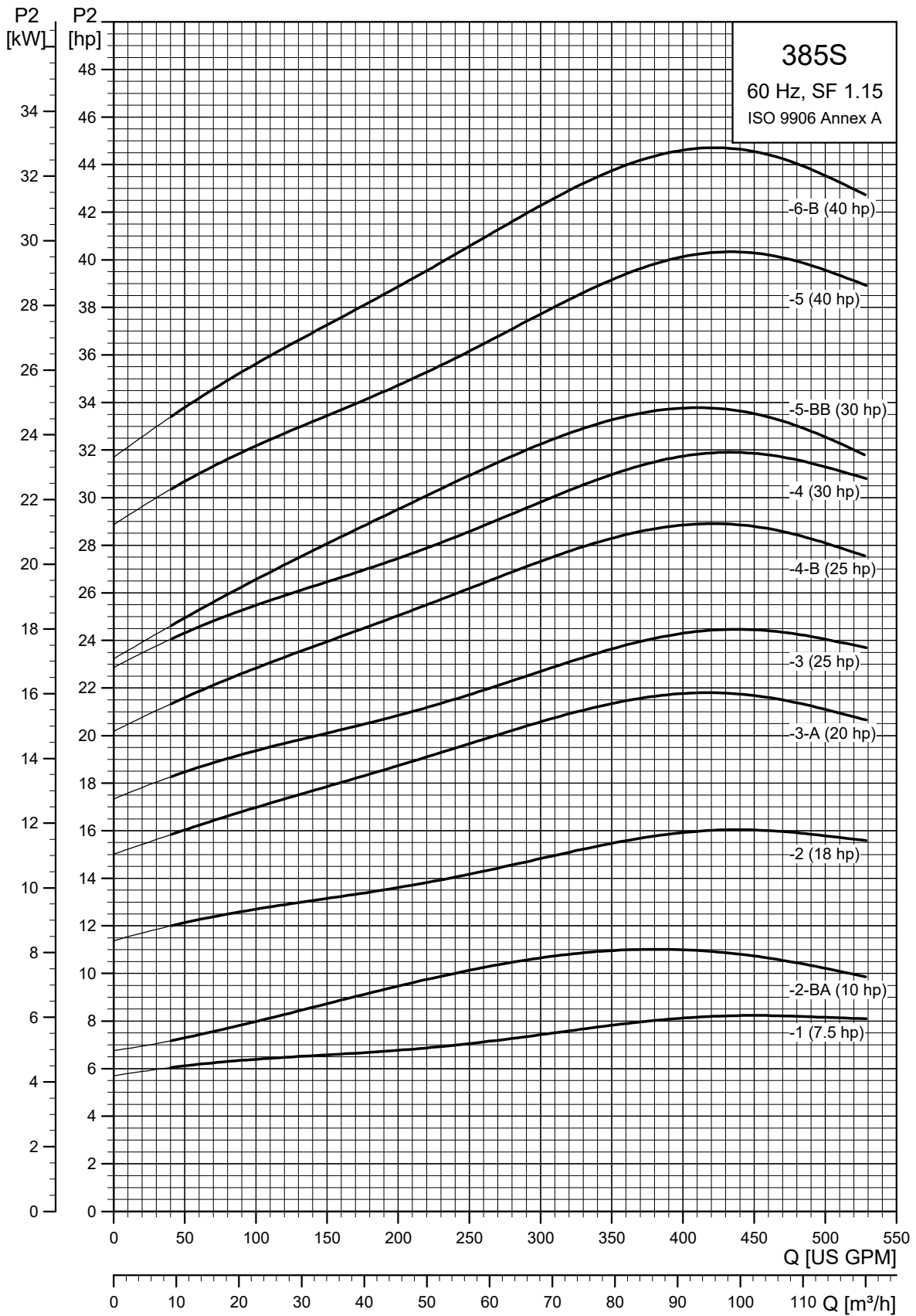

TM050253

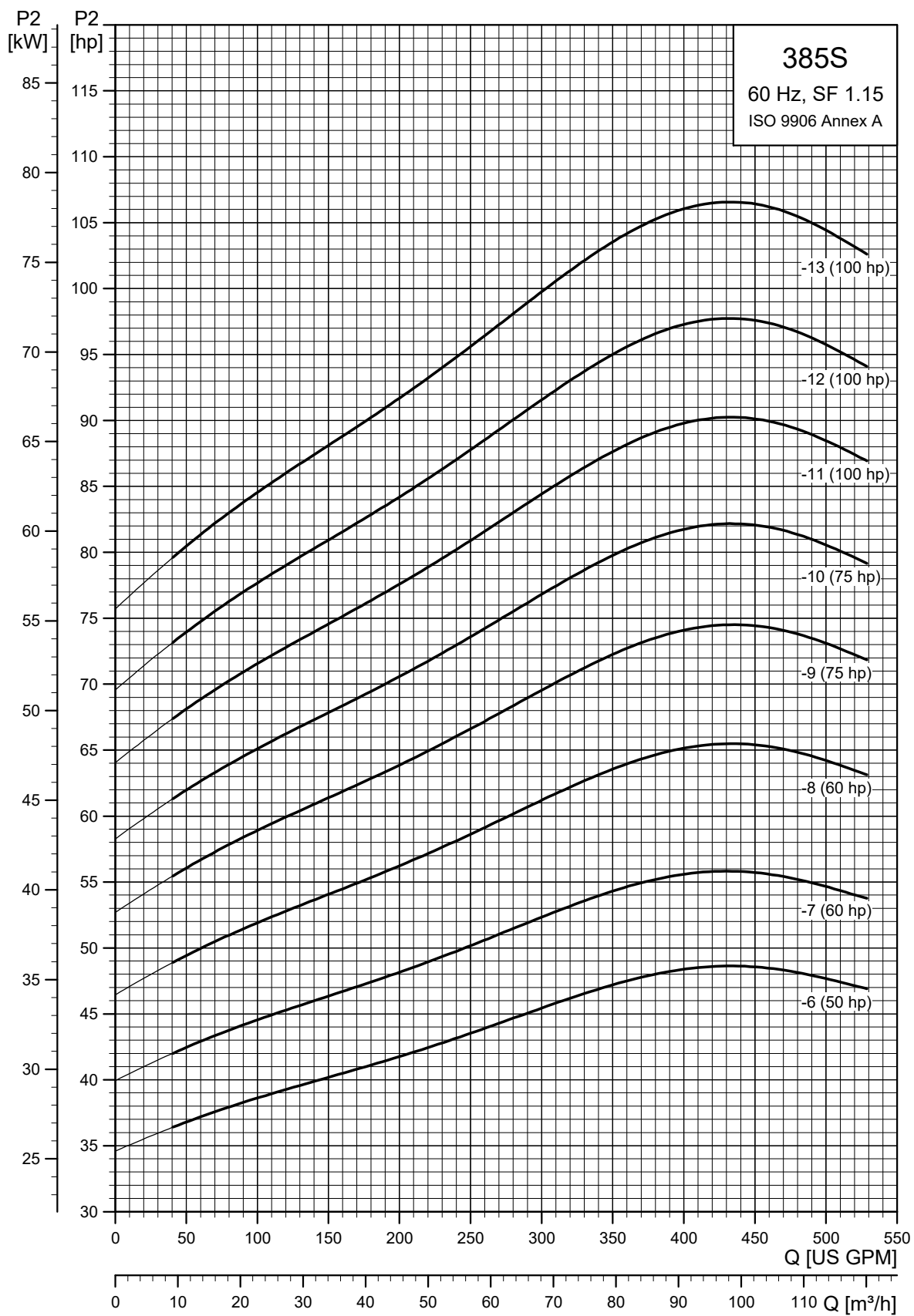

TM050254

**SP 385S (385 gpm) pump with 6", 8" motor**

Pump model	Nom. head [ft]	Ph	Motor			Dimensions [in (mm)]					Net weight (complete) [lb]	385S
			Volts [V]	[Hp]	[rpm]	A	B	C	D	E		
<b>385S - Motor diameter 6 inch, 60 Hz, rated flow rate 385 gpm (4" NPT)</b>												
385S75-1	60	3	230	7.5 ▲	3478	46.58 (1183)	22.25 (565)	24.34 (618)	5.63 (143)	7.01 (178)	135.9	
	61	3	460	7.5 ▲	3489	46.58 (1183)	22.25 (565)	24.34 (618)	5.63 (143)	7.01 (178)	135.9	
385S100-2AB	87	3	230	10 ▲	3467	52.6 (1336)	23.23 (590)	29.38 (746)	5.63 (143)	7.01 (178)	169.2	
	87	3	460	10 ▲	3482	52.6 (1336)	23.23 (590)	29.38 (746)	5.63 (143)	7.01 (178)	169.2	
385S150-2	123	3	230	15 ▲	3472	57.25 (1454)	27.88 (708)	29.38 (746)	5.63 (143)	7.01 (178)	169.2	
	123	3	460	15 ▲	3477	57.25 (1454)	27.88 (708)	29.38 (746)	5.63 (143)	7.01 (178)	169.2	
385S200-3A	163	3	230	20 ▲	3469	65.24 (1657)	30.83 (783)	34.41 (874)	5.63 (143)	7.01 (178)	188.1	
	165	3	460	20 ▲	3482	65.24 (1657)	30.83 (783)	34.41 (874)	5.63 (143)	7.01 (178)	188.1	
385S250-3	187	3	230	25 ▲	3489	67.41 (1712)	33.00 (838)	34.41 (874)	5.63 (143)	7.01 (178)	188.1	
	189	3	460	25 ▲	3499	67.41 (1712)	33.00 (838)	34.41 (874)	5.63 (143)	7.01 (178)	188.1	
385S250-4B	220	3	230	25 ▲	3461	72.45 (1840)	33.00 (838)	39.45 (1002)	5.63 (143)	7.01 (178)	239.4	
	222	3	460	25 ▲	3475	72.45 (1840)	33.00 (838)	39.45 (1002)	5.63 (143)	7.01 (178)	239.4	
385S300-4	234	3	230	30 ▲	3463	75.00 (1905)	35.56 (903)	39.45 (1002)	5.63 (143)	7.01 (178)	239.4	
	249	3	460	30 ▲	3478	75.00 (1905)	35.56 (903)	39.45 (1002)	5.63 (143)	7.01 (178)	239.4	
385S300-5BB	254	3	230	30 ▲	3452	80.04 (2033)	35.56 (903)	44.49 (1130)	5.63 (143)	7.01 (178)	247.5	
	257	3	460	30 ▲	3467	80.04 (2033)	35.56 (903)	44.49 (1130)	5.63 (143)	7.01 (178)	247.5	
385S400-5	314	3	460	40 ▲	3488	84.77 (2153)	40.28 (1023)	44.49 (1130)	5.63 (143)	7.01 (178)	247.5	
385S400-6B	347	3	460	40 ▲	3471	89.81 (2281)	40.28 (1023)	49.53 (1258)	5.63 (143)	7.01 (178)	252.0	
385S500-6	375	3	460	50 ☼	3447	110.99 (2825)	56.11 (1425)	54.88 (1394)	5.67 (144)	7.88 (200)	376.0	
385S500-7A	414	3	460	50 ☼	3467	110.99 (2825)	56.11 (1425)	54.88 (1394)	5.67 (144)	7.88 (200)	407.0	
385S600-7	449	3	460	60 ☼	3414	111.23 (2825)	56.11 (1425)	55.12 (1400)	5.67 (144)	7.88 (200)	385.0	
385S600-8	494	3	460	60 ☼	3449	111.23 (2825)	56.11 (1425)	55.12 (1400)	5.67 (144)	7.88 (200)	385.0	
<b>385S - Motor diameter 8 inch, 60 Hz, rated flow rate 385 gpm (4" NPT)</b>												
385S400-6B	351	3	460	40 *	3490	93.78 (2382)	43.71 (1110)	50.08 (1272)	7.56 (192)	7.88 (200)	428.3	
385S500-6	375	3	460	50 *	3481	95.75 (2432)	45.67 (1160)	50.08 (1272)	7.56 (192)	7.88 (200)	451.2	
385S500-7A	420	3	460	50 *	3492	100.79 (2560)	45.67 (1160)	55.12 (1400)	7.56 (192)	7.88 (200)	461.1	
385S600-7	449	3	460	60 *	3459	105.12 (2670)	50.00 (1270)	55.12 (1400)	7.56 (192)	7.88 (200)	507.3	
385S600-8	511	3	460	60 *	3510	110.16 (2798)	50.00 (1270)	60.16 (1528)	7.56 (192)	7.88 (200)	517.2	
385S750-9	582	3	460	75 *	3508	118.35 (3006)	53.15 (1350)	65.2 (1656)	7.56 (192)	7.88 (200)	558.7	
385S750-10	643	3	460	75 *	3498	123.39 (3134)	53.15 (1350)	70.24 (1784)	7.56 (192)	7.88 (200)	568.6	
385S1000-11	711	3	460	100 *	3512	137.88 (3502)	62.60 (1590)	75.28 (1912)	7.56 (192)	7.88 (200)	677.5	
385S1000-12	771	3	460	100 *	3505	142.92 (3630)	62.60 (1590)	80.32 (2040)	7.56 (192)	7.88 (200)	687.4	
385S1000-13	831	3	460	100 *	3497	147.96 (3758)	62.60 (1590)	85.36 (2168)	7.56 (192)	7.88 (200)	697.3	

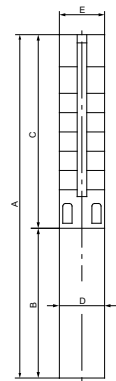

E = Maximum diameter of pump including cable guard and motor

**Notes:**

Performance conforms to ISO 9906 Annex A. Minimum submergence is 8 ft (2.4 m).

▲	MS6000C motor
☼	Takes MMS6 motor; not available as complete.
*	Takes MMS8000 motor; not available as complete.

**SP 475S (475 gpm)**

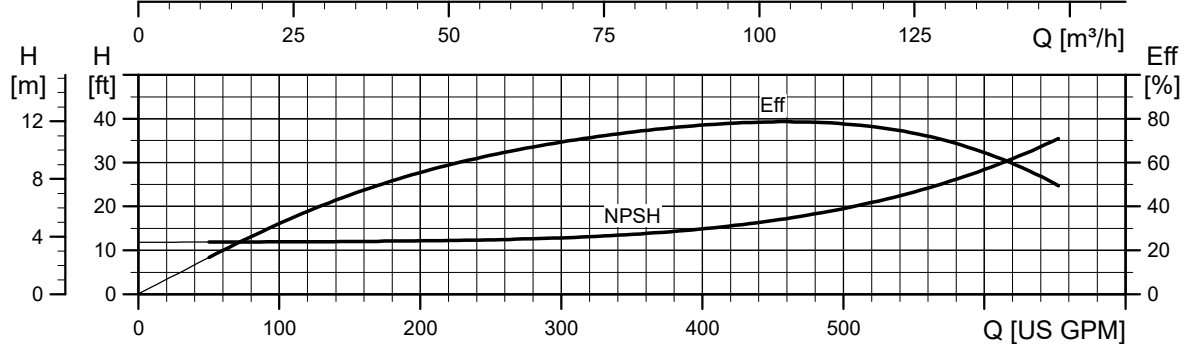
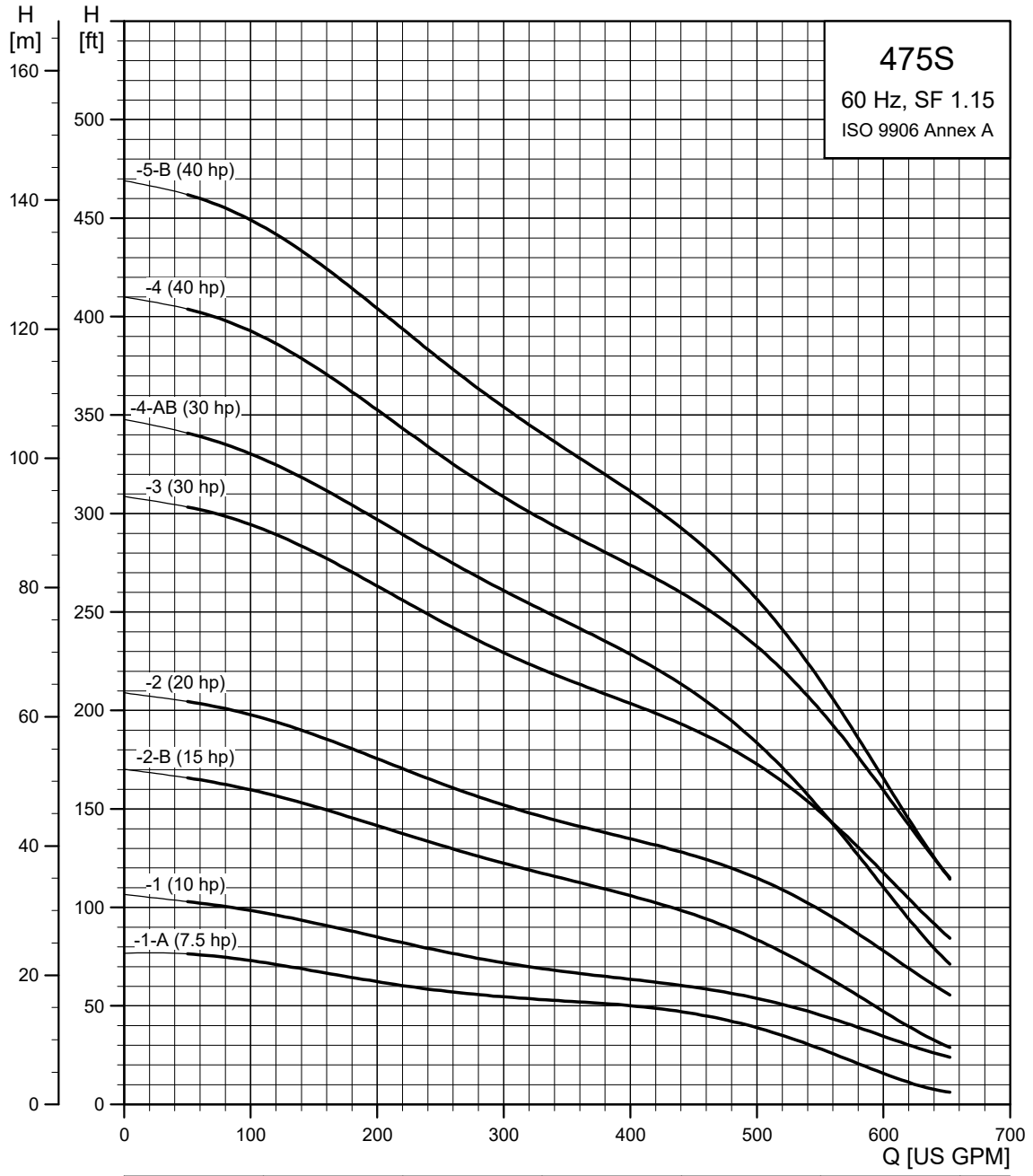

TM050255

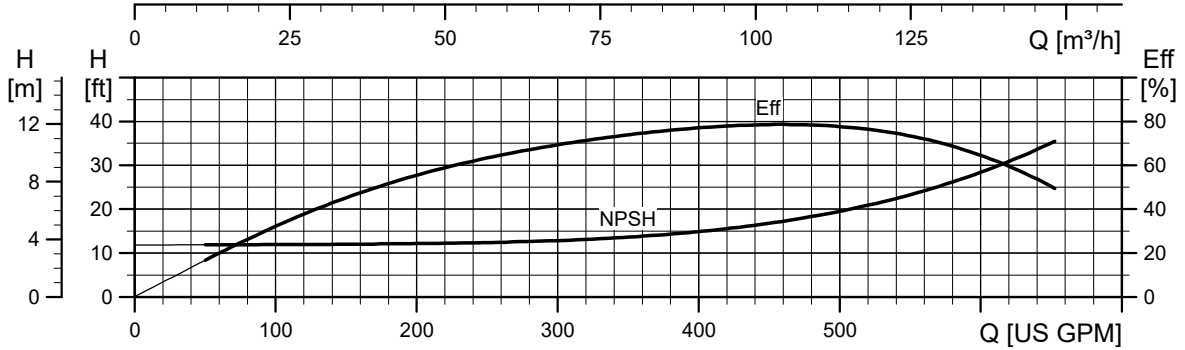
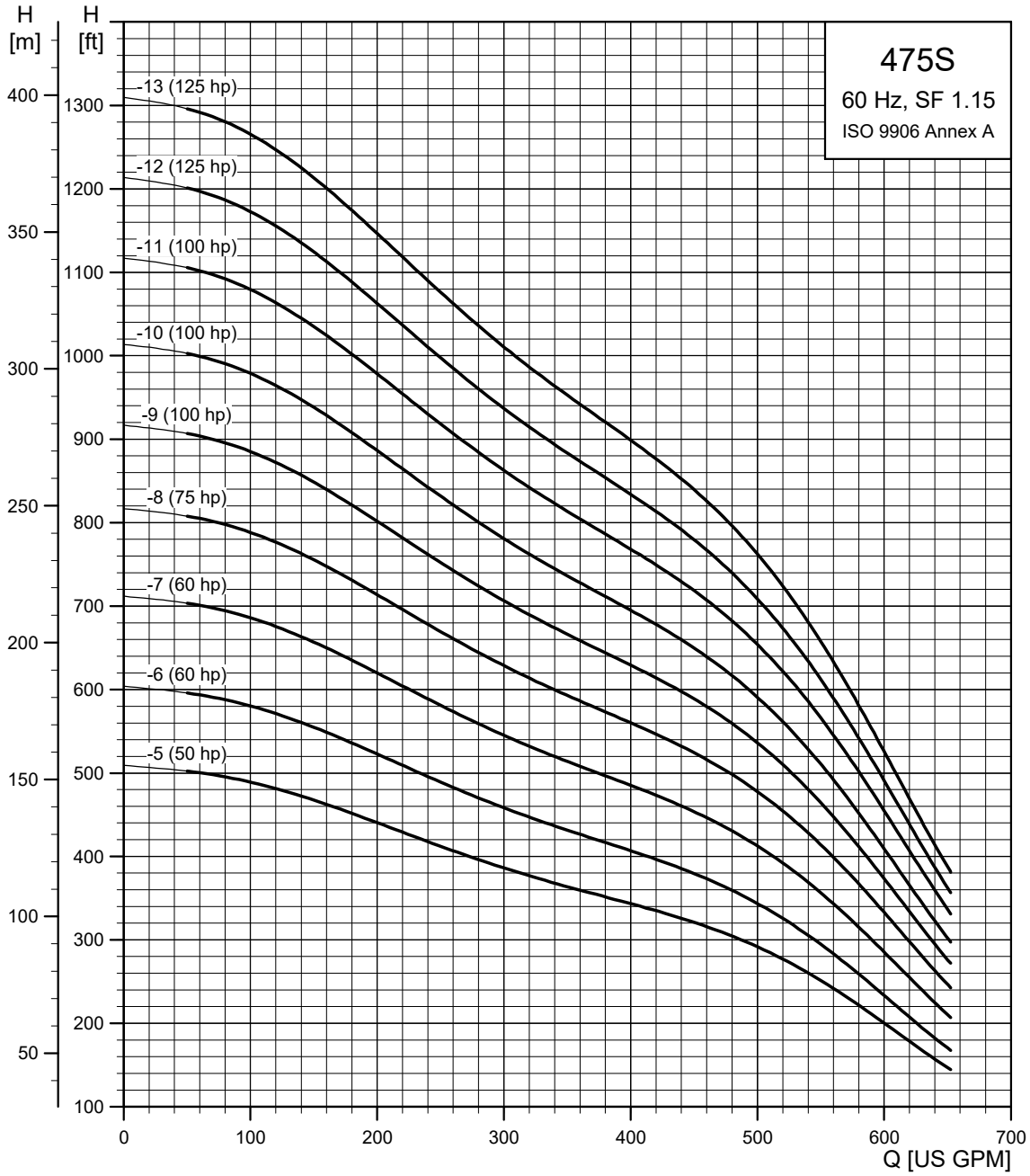

TM050256

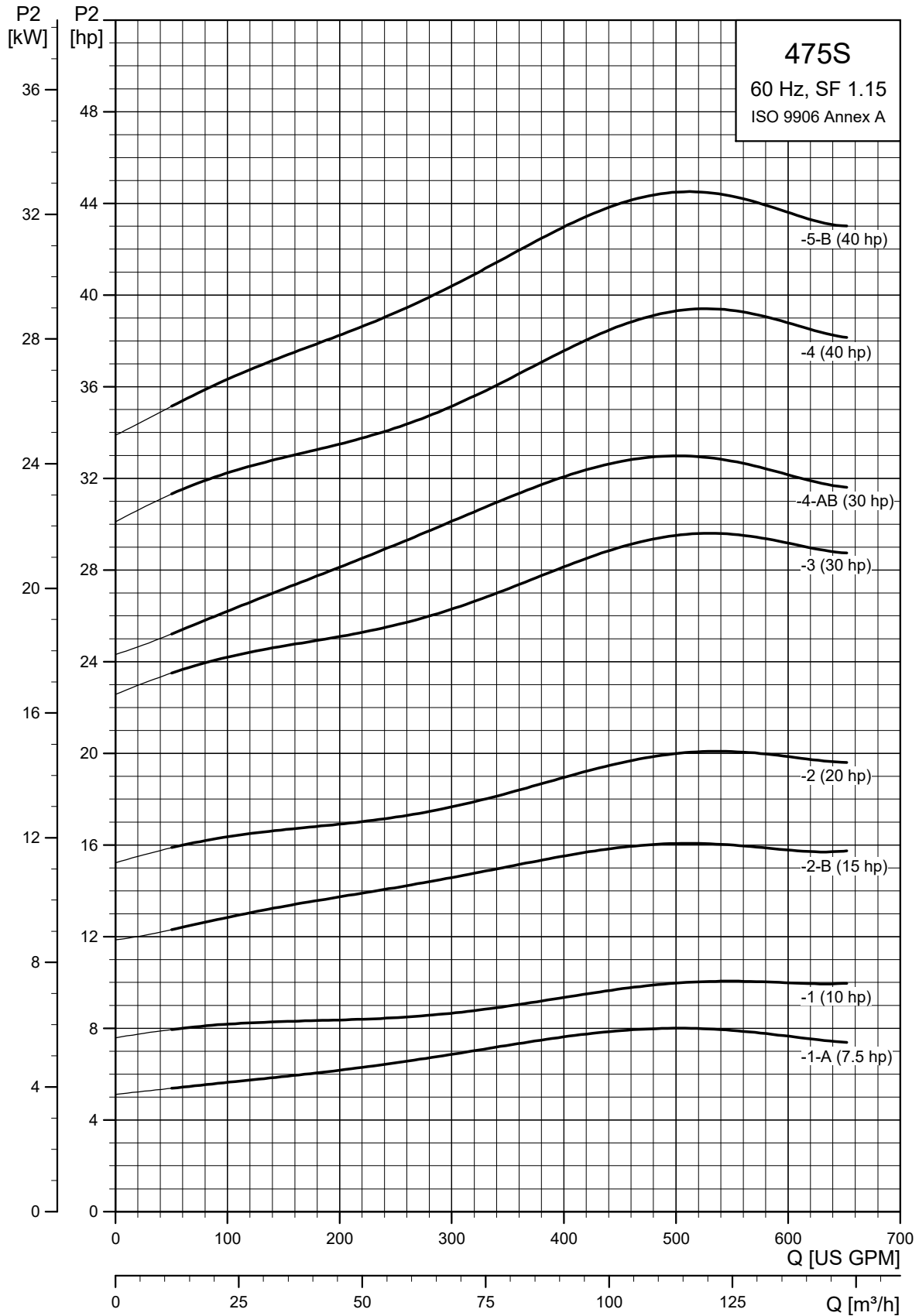

TM050257



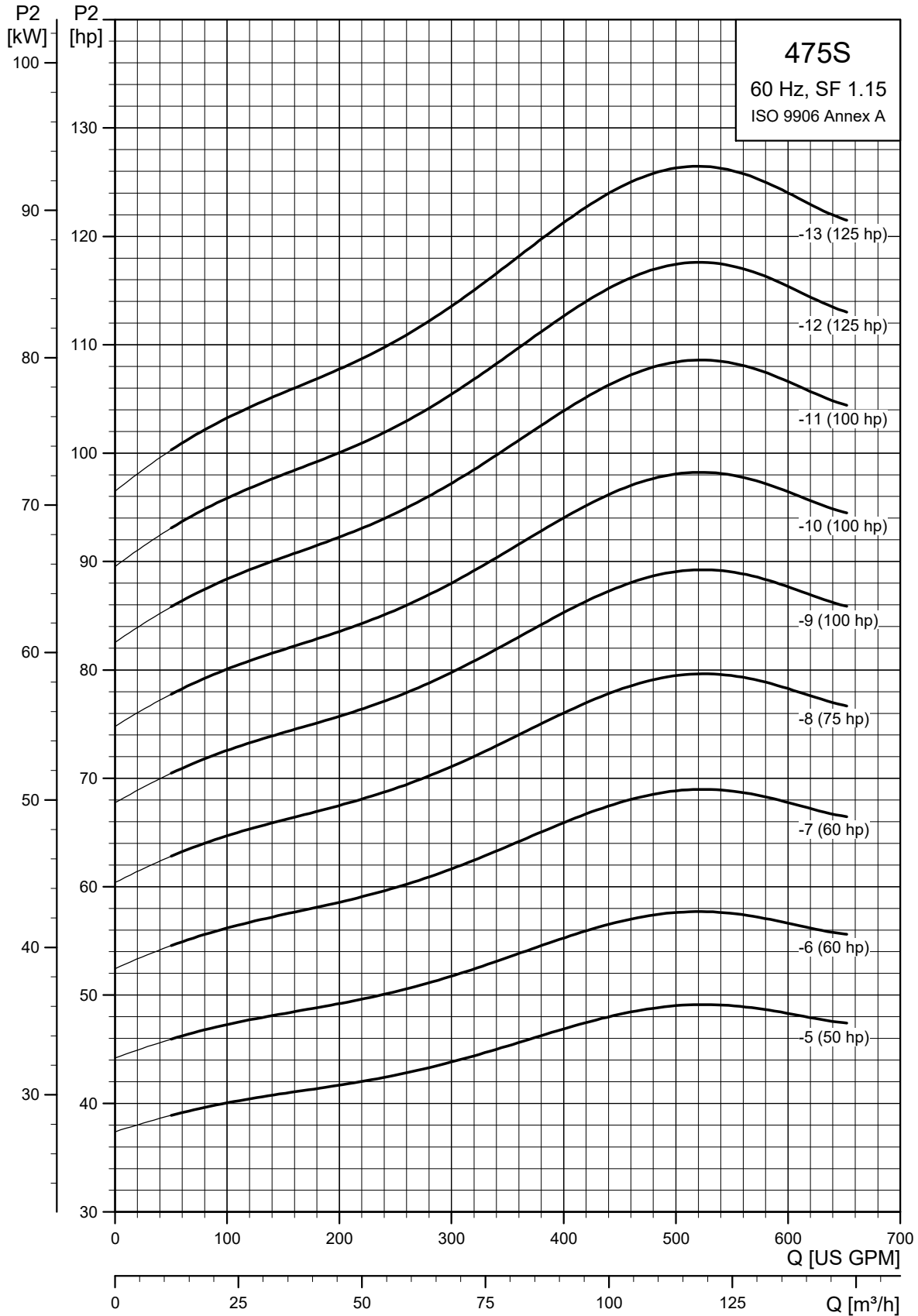

TM050258

**SP 475S (475 gpm) pump with 6", 8" motors**

Pump model	Nom. head [ft]	Motor				Dimensions [in (mm)]					Net weight (complete) [lb]	475S
		Ph	Volts [V]	[Hp]	[rpm]	A	B	C	D	E		
<b>475S - Motor diameter 6 inch, 60 Hz, rated flow rate 475 gpm (6" NPT)</b>												
475S75-1A	51	3	230	7.5	▲	3484	46.58 (1183)	22.25 (565)	24.34 (618)	5.63 (143)	7.05 (179)	132.3
	51	3	460	7.5	▲	3495	46.58 (1183)	22.25 (565)	24.34 (618)	5.63 (143)	7.05 (179)	132.3
475S100-1	61	3	230	10	▲	3478	47.56 (1208)	23.23 (590)	24.34 (618)	5.63 (143)	7.05 (179)	132.3
	61	3	460	10	▲	3490	47.56 (1208)	23.23 (590)	24.34 (618)	5.63 (143)	7.05 (179)	132.3
475S150-2B	108	3	230	15	▲	3474	57.25 (1454)	27.88 (708)	29.38 (746)	5.63 (143)	7.05 (179)	170.1
	108	3	460	15	▲	3480	57.25 (1454)	27.88 (708)	29.38 (746)	5.63 (143)	7.05 (179)	170.1
475S200-2	124	3	230	20	▲	3484	60.20 (1529)	30.83 (783)	29.38 (746)	5.63 (143)	7.05 (179)	198.7
	124	3	460	20	▲	3494	60.20 (1529)	30.83 (783)	29.38 (746)	5.63 (143)	7.05 (179)	198.7
475S250-3A	172	3	230	25	▲	3471	67.41 (1712)	33.00 (838)	34.41 (874)	5.63 (143)	7.05 (179)	218.2
	173	3	460	25	▲	3484	67.41 (1712)	33.00 (838)	34.41 (874)	5.63 (143)	7.05 (179)	218.2
475S300-3	186	3	230	30	▲	3477	69.97 (1777)	35.56 (903)	34.41 (874)	5.63 (143)	7.05 (179)	233.6
	187	3	460	30	▲	3489	69.97 (1777)	35.56 (903)	34.41 (874)	5.63 (143)	7.05 (179)	233.6
475S300-4AB	210	3	230	30	▲	3457	75.00 (1905)	35.56 (903)	39.45 (1002)	5.63 (143)	7.05 (179)	239.9
	212	3	460	30	▲	3472	75.00 (1905)	35.56 (903)	39.45 (1002)	5.63 (143)	7.05 (179)	239.9
475S400-4	251	3	460	40	▲	3491	79.73 (2025)	40.28 (1023)	39.45 (1002)	5.63 (143)	7.05 (179)	268.5
475S400-5B	284	3	460	40	▲	3460	84.77 (2153)	40.28 (1023)	44.49 (1130)	5.63 (143)	7.05 (179)	356.0
475S500-5	313	3	460	50	☼	3460	100.6 (2555)	56.11 (1425)	44.49 (1130)	5.67 (144)	7.05 (179)	384.0
475S500-6A	357	3	460	50	☼	3460	105.63 (2683)	56.11 (1425)	49.53 (1258)	5.67 (144)	7.05 (179)	385.0
475S600-6	375	3	460	60	☼	3456	106.19 (2697)	56.11 (1425)	50.08 (1272)	5.67 (144)	7.05 (179)	436.0
475S600-7	449	3	460	60	☼	3433	111.23 (2825)	56.11 (1425)	55.12 (1400)	5.67 (144)	7.05 (179)	446.0
<b>475S - Motor diameter 8 inch, 60 Hz, rated flow rate 475 gpm (6" NPT)</b>												
475S400-4	245	3	460	40	*	3462	83.71 (2126)	43.71 (1110)	40.00 (1016)	7.56 (192)	8.08 (205)	406.5
475S400-5B	284	3	460	40	*	3441	88.75 (2254)	43.71 (1110)	45.04 (1144)	7.56 (192)	8.08 (205)	444.0
475S500-5	317	3	460	50	*	3480	90.71 (2304)	45.67 (1160)	45.04 (1144)	7.56 (192)	8.08 (205)	420.4
475S500-6A	363	3	460	50	*	3480	95.75 (2432)	45.67 (1160)	50.08 (1272)	7.56 (192)	8.08 (205)	422.0
475S600-6	375	3	460	60	*	3519	100.08 (2542)	50.00 (1270)	50.08 (1272)	7.56 (192)	8.08 (205)	476.0
475S600-7	449	3	460	60	*	3505	105.12 (2670)	50.00 (1270)	55.12 (1400)	7.56 (192)	8.08 (205)	482.6
475S750-8	513	3	460	75	*	3518	113.31 (2878)	53.15 (1350)	60.16 (1528)	7.56 (192)	8.08 (205)	524.4
475S1000-9	582	3	460	100	*	3529	127.8 (3246)	62.60 (1590)	65.20 (1656)	7.56 (192)	8.08 (205)	631.0
475S1000-10	643	3	460	100	*	3512	132.84 (3374)	62.60 (1590)	70.24 (1784)	7.56 (192)	8.08 (205)	637.6
475S1000-11	711	3	460	100	*	3512	137.88 (3502)	62.60 (1590)	75.28 (1912)	7.56 (192)	8.08 (205)	644.3
475S1250-12	771	3	460	125	*	3505	152.37 (3870)	72.05 (1830)	80.32 (2040)	7.56 (192)	8.08 (205)	754.1
475S1250-13	831	3	460	125	*	3497	157.41 (3998)	72.05 (1830)	85.36 (2168)	7.56 (192)	8.08 (205)	760.7

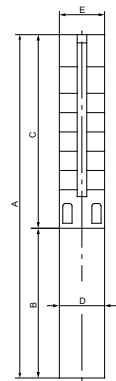

E = Maximum diameter of pump including cable guard and motor

**Notes:**

Performance conforms to ISO 9906. 1999 (E) Annex A. Minimum submergence is 8 ft (2.4 m).

▲	MS6000C motor
☼	Takes MMS6 motor; not available as complete.
*	Takes MMS8000 motor; not available as complete.

**10" and larger wells  
SP 625S (625 gpm)**

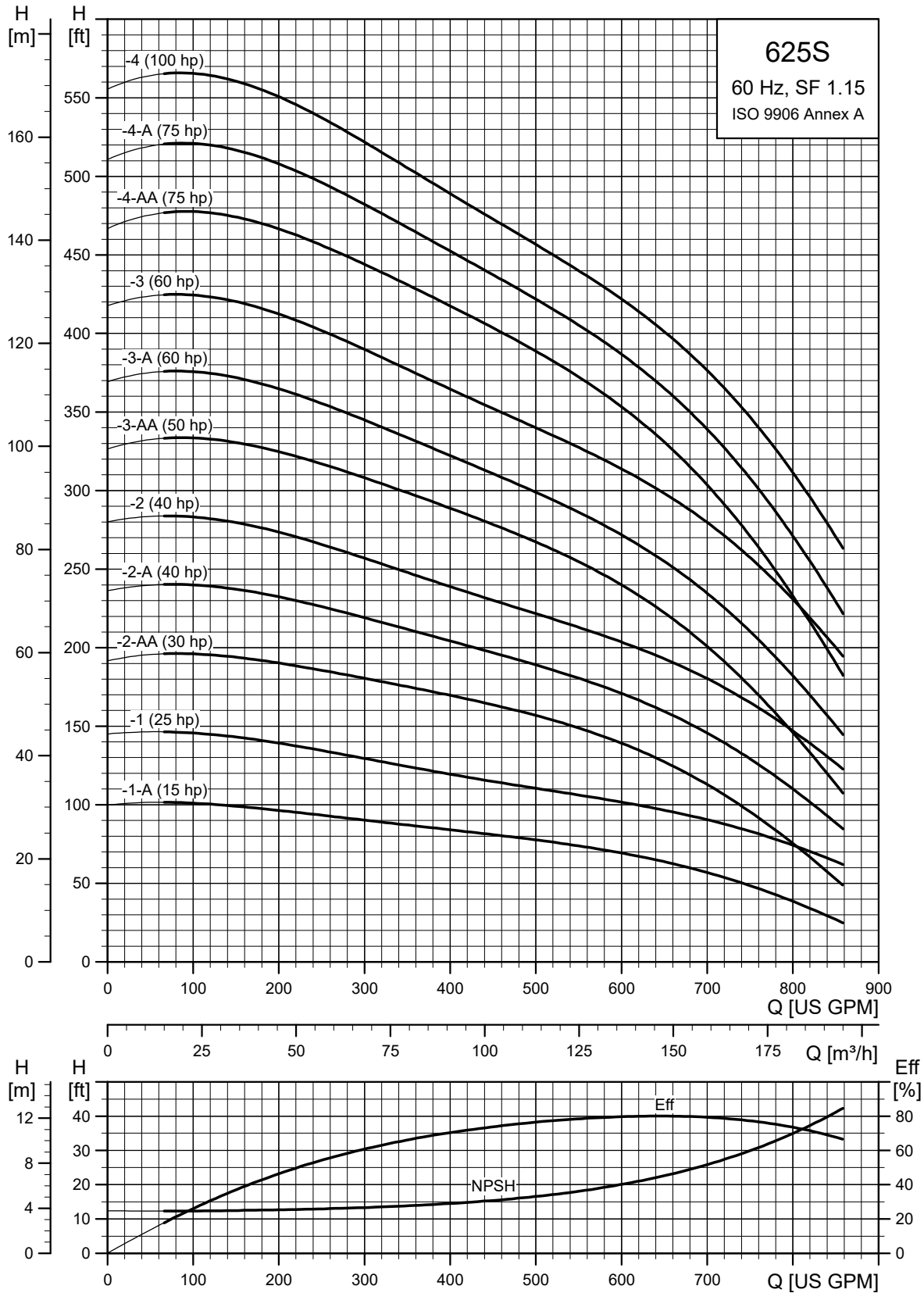

TM050259

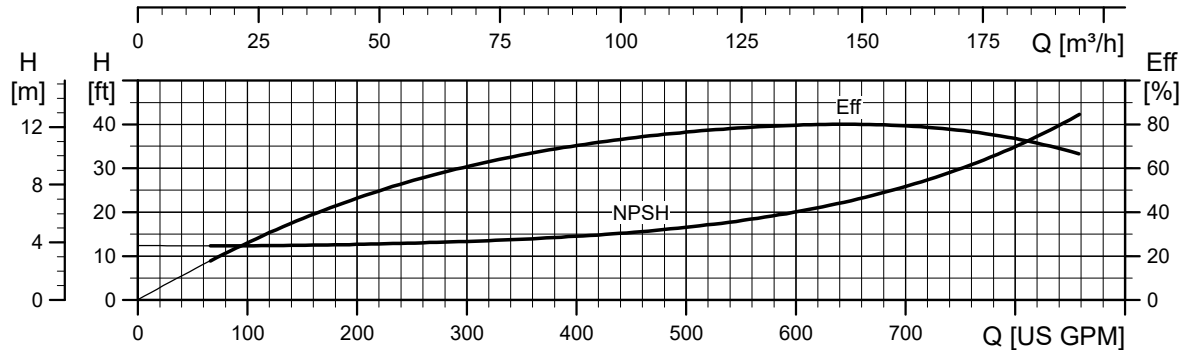
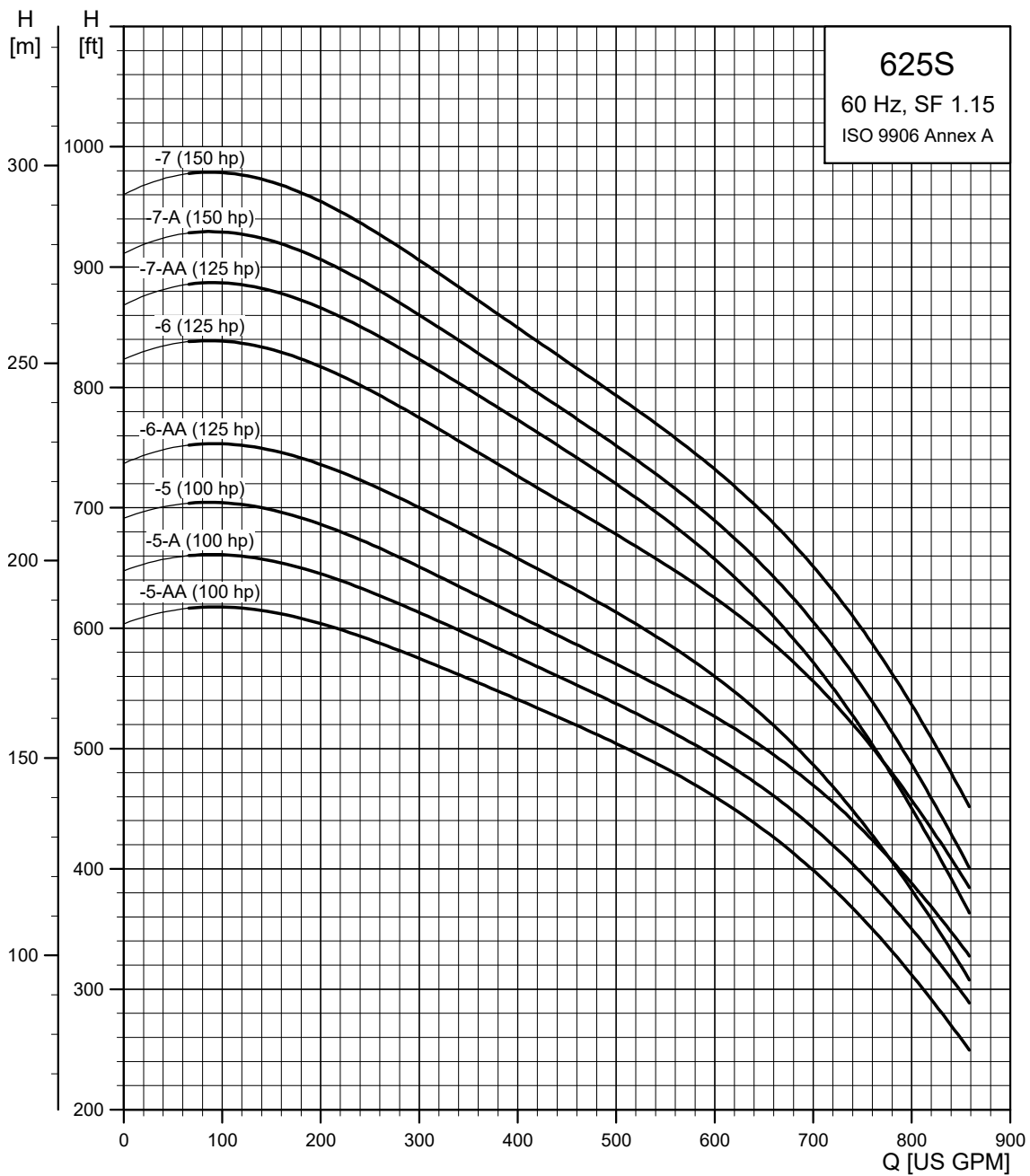

TM050260

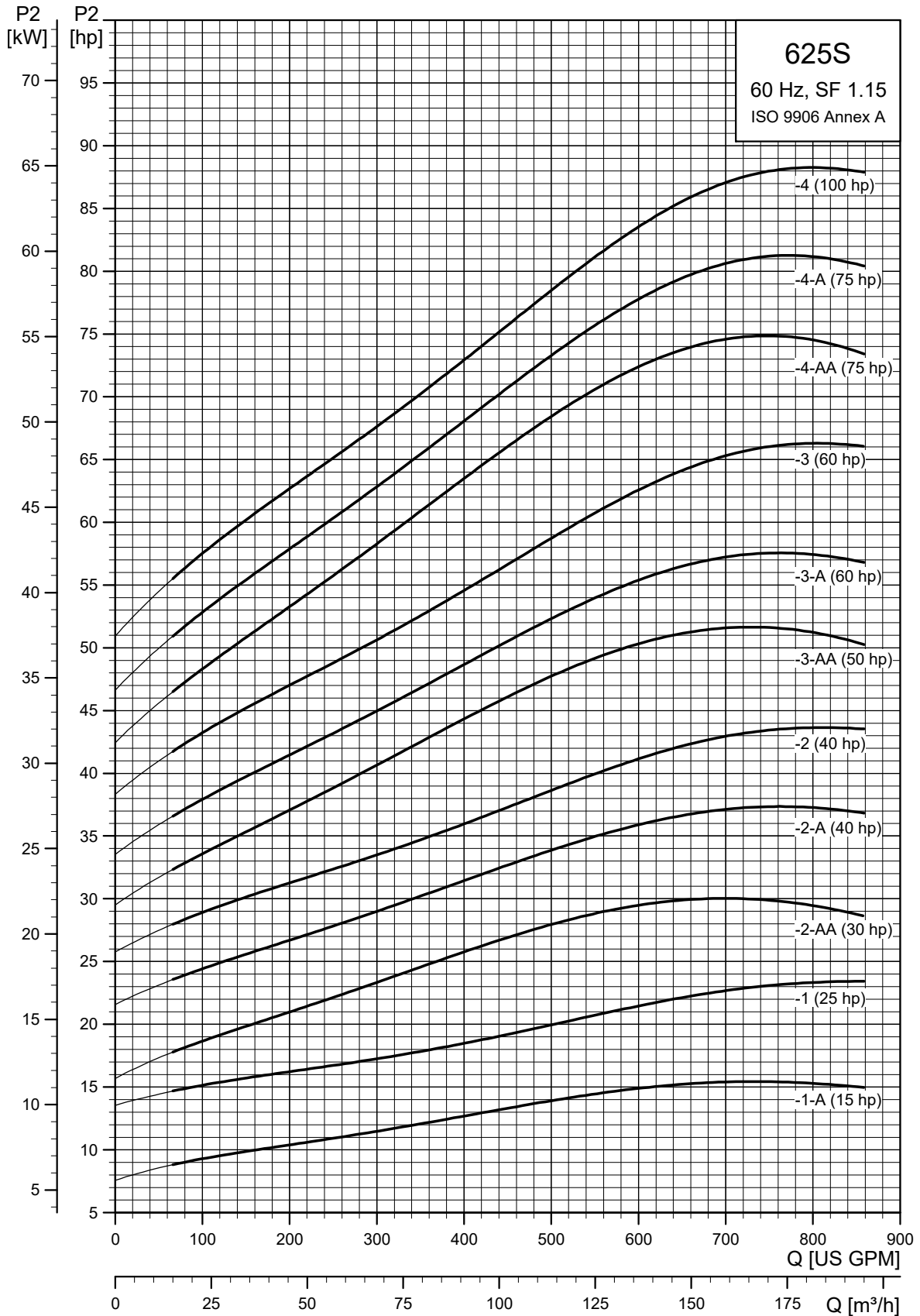

TM050261

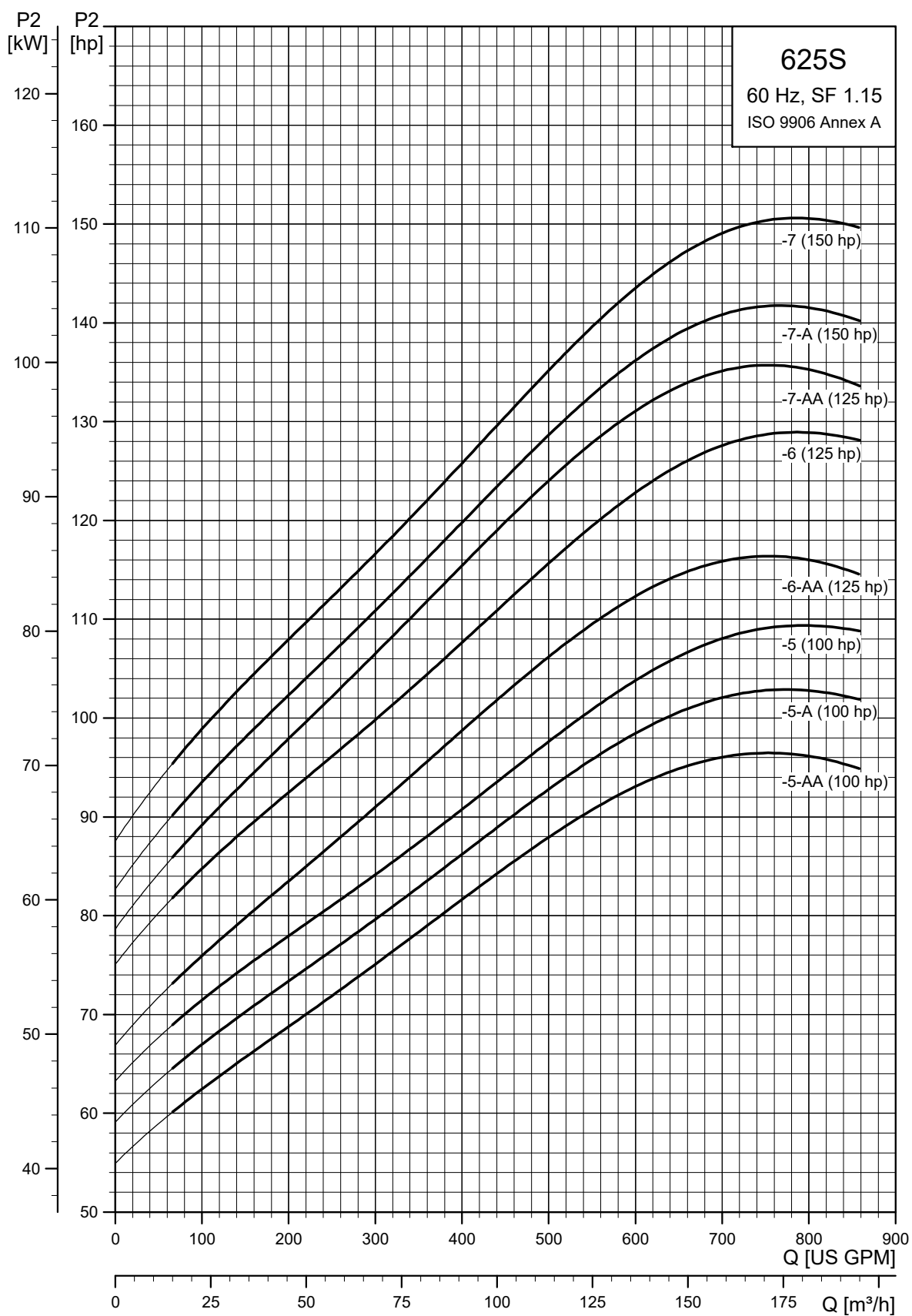

TM050262

**SP 625S (625 gpm) pump with 6", 8" motors**

Pump model	Nom. head [ft]	Motor				Dimensions [in (mm)]					Net weight (complete) [lb]	625S
		Ph	Volts [V]	[Hp]	[rpm]	A	B	C	D	E		
<b>625S - Motor diameter 6 inch, 60 Hz, rated flow rate 625 gpm (6" NPT)</b>												
625S150-1A	76	3	230	15	▲	3486	53.51 (1359)	27.88 (708)	25.63 (651)	5.63 (143)	8.31 (211)	193.0
		3	460	15	▲	3491	53.51 (1359)	27.88 (708)	25.63 (651)	5.63 (143)	8.31 (211)	193.0
625S250-1	101	3	230	25	▲	3502	58.63 (1489)	33.00 (838)	25.63 (651)	5.63 (143)	8.31 (211)	189.9
		3	460	25	▲	3511	58.63 (1489)	33.00 (838)	25.63 (651)	5.63 (143)	8.31 (211)	198.9
625S300-2AA	143	3	230	30	▲	3476	67.33 (1710)	35.56 (903)	31.78 (807)	5.63 (143)	8.31 (211)	213.0
	144	3	460	30	▲	3488	67.33 (1710)	35.56 (903)	31.78 (807)	5.63 (143)	8.31 (211)	222.3
625S400-2A	171	3	460	40	▲	3499	72.05 (1830)	40.28 (1023)	31.78 (807)	5.63 (143)	8.31 (211)	333.8
625S400-2	203	3	460	40	▲	3482	72.05 (1830)	40.28 (1023)	31.78 (807)	5.63 (143)	8.31 (211)	333.8
625S500-3AA	240	3	460	50	☼	3475	94.02 (2388)	56.11 (1425)	37.94 (963)	5.63 (143)	8.31 (211)	376.4
625S600-3A	267	3	460	60	☼	3467	94.03 (2388)	56.11 (1425)	37.92 (963)	5.63 (143)	8.31 (211)	382.0
625S600-3	301	3	460	60	☼	3453	94.03 (2388)	56.11 (1425)	37.92 (963)	5.63 (143)	8.31 (211)	382.0
<b>625S - Motor diameter 8 inch, 60 Hz, rated flow rate 625 gpm (6" NPT)</b>												
625S400-2	205	3	460	40	*	3498	76.03 (1931)	43.71 (1110)	32.33 (821)	7.56 (192)	8.39 (213)	409.4
625S500-3AA	243	3	460	50	*	3498	83.59 (2123)	45.67 (1160)	37.92 (963)	7.56 (192)	8.39 (213)	444.6
625S600-3A	278	3	460	60	*	3520	87.92 (2233)	50.00 (1270)	37.92 (963)	7.56 (192)	8.39 (213)	490.8
625S600-3	299	3	460	60	*	3510	87.92 (2233)	50.00 (1270)	37.92 (963)	7.56 (192)	8.39 (213)	490.8
625S750-4AA	350	3	460	75	*	3524	97.21 (2469)	53.15 (1350)	44.06 (1119)	7.56 (192)	8.39 (213)	534.8
625S750-4A	384	3	460	75	*	3518	97.21 (2469)	53.15 (1350)	44.06 (1119)	7.56 (192)	8.39 (213)	534.8
625S1000-4	402	3	460	100	*	3529	106.66 (2709)	62.60 (1590)	44.06 (1119)	7.56 (192)	8.39 (213)	633.8
625S1000-5AA	460	3	460	100	*	3524	112.76 (2864)	62.60 (1590)	50.16 (1274)	7.56 (192)	8.39 (213)	649.3
625S1000-5A	490	3	460	100	*	3519	112.76 (2864)	62.60 (1590)	50.16 (1274)	7.56 (192)	8.39 (213)	649.3
625S1000-5	500	3	460	100	*	3513	112.76 (2864)	62.60 (1590)	50.16 (1274)	7.56 (192)	8.39 (213)	649.3
625S1250-6AA	557	3	460	125	*	3507	128.31 (3259)	72.05 (1830)	56.26 (1429)	7.56 (192)	8.39 (213)	761.5
625S1250-6	590	3	460	125	*	3495	128.31 (3259)	72.05 (1830)	56.26 (1429)	7.56 (192)	8.39 (213)	761.5
625S1250-7AA	655	3	460	125	*	3490	134.45 (3415)	72.05 (1830)	62.41 (1585)	7.56 (192)	8.39 (213)	774.7
625S1500-7A	696	3	460	150	*	3505	143.51 (3645)	81.11 (2060)	62.41 (1585)	7.56 (192)	8.39 (213)	884.7
625S1500-7	690	3	460	150	*	3499	143.51 (3645)	81.11 (2060)	62.41 (1585)	7.56 (192)	8.39 (213)	884.7

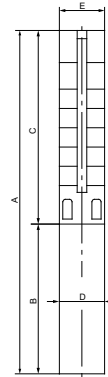

E = Maximum diameter of pump including cable guard and motor

**Notes:**

Performance conforms to ISO 9906. 1999 (E) Annex A. Minimum submergence is 10 ft (3 m).

▲	MS6000C motor
☼	Takes MMS6 motor; not available as complete.
*	Takes MMS8000 motor; not available as complete.

### SP 800S (800 gpm)

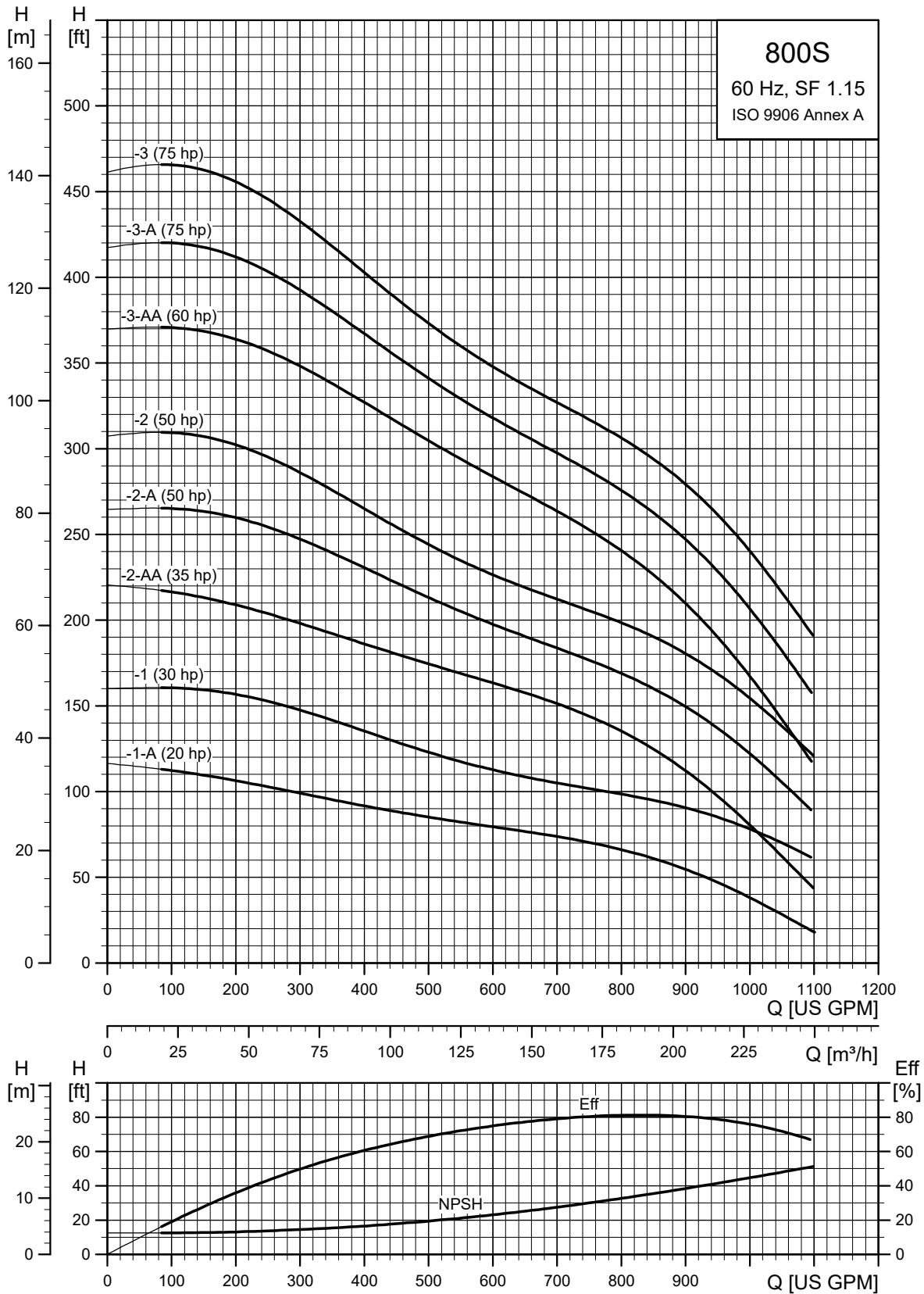

TM050263



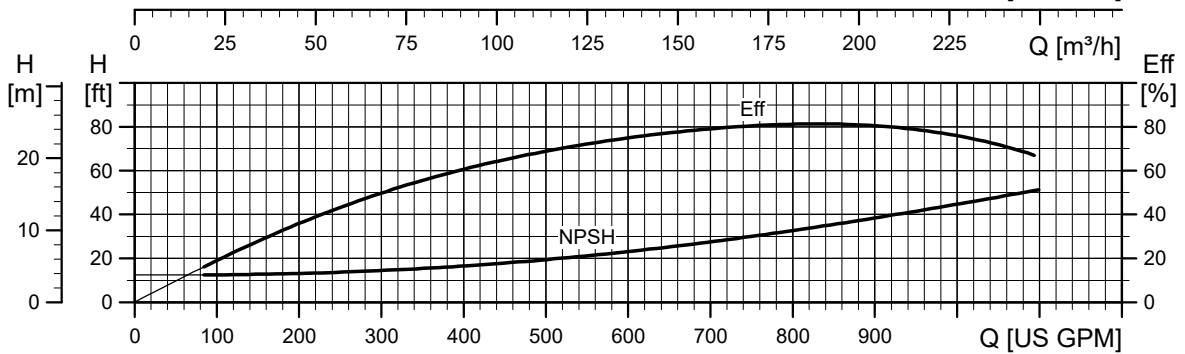
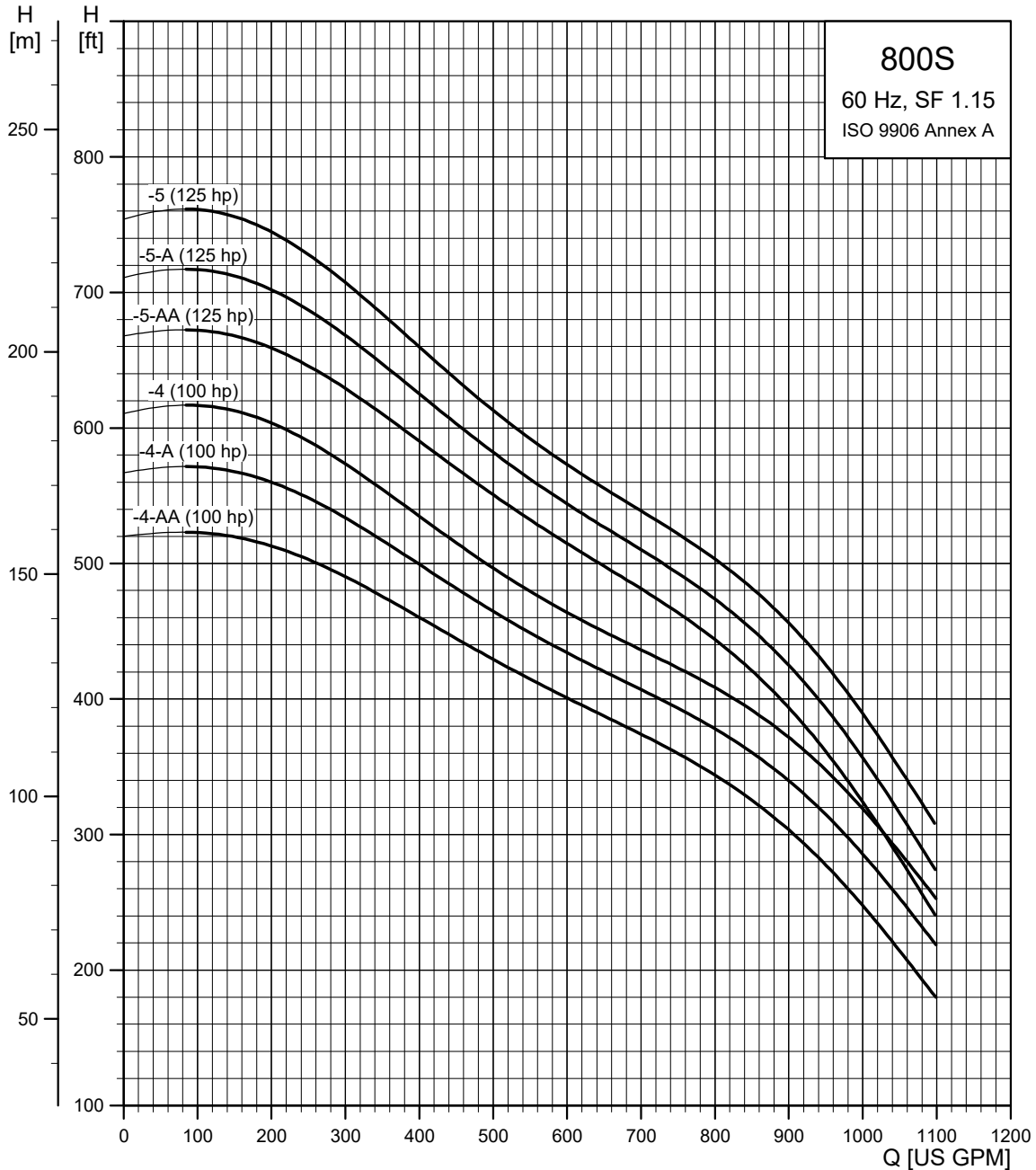

TM050264

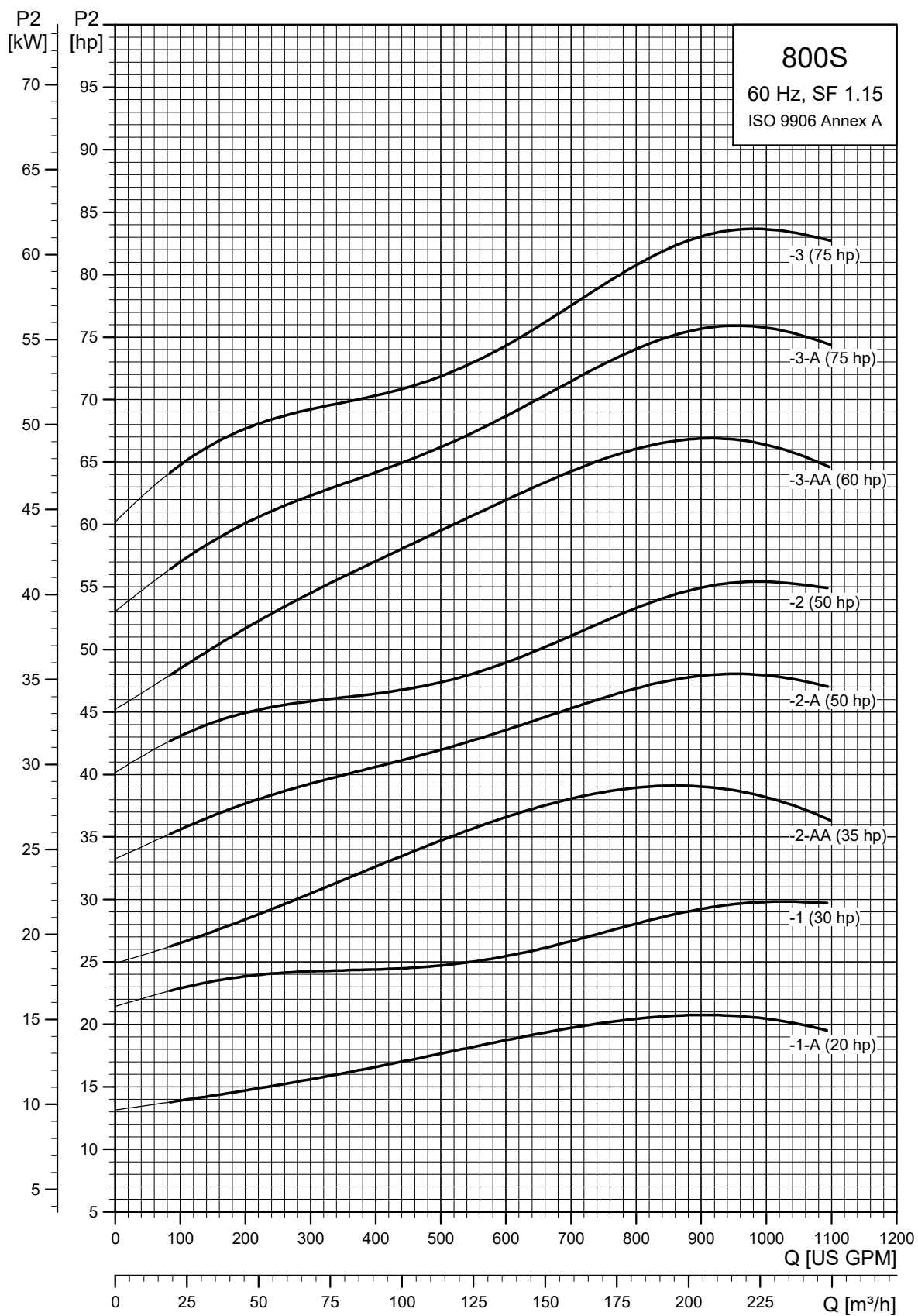

TM050265

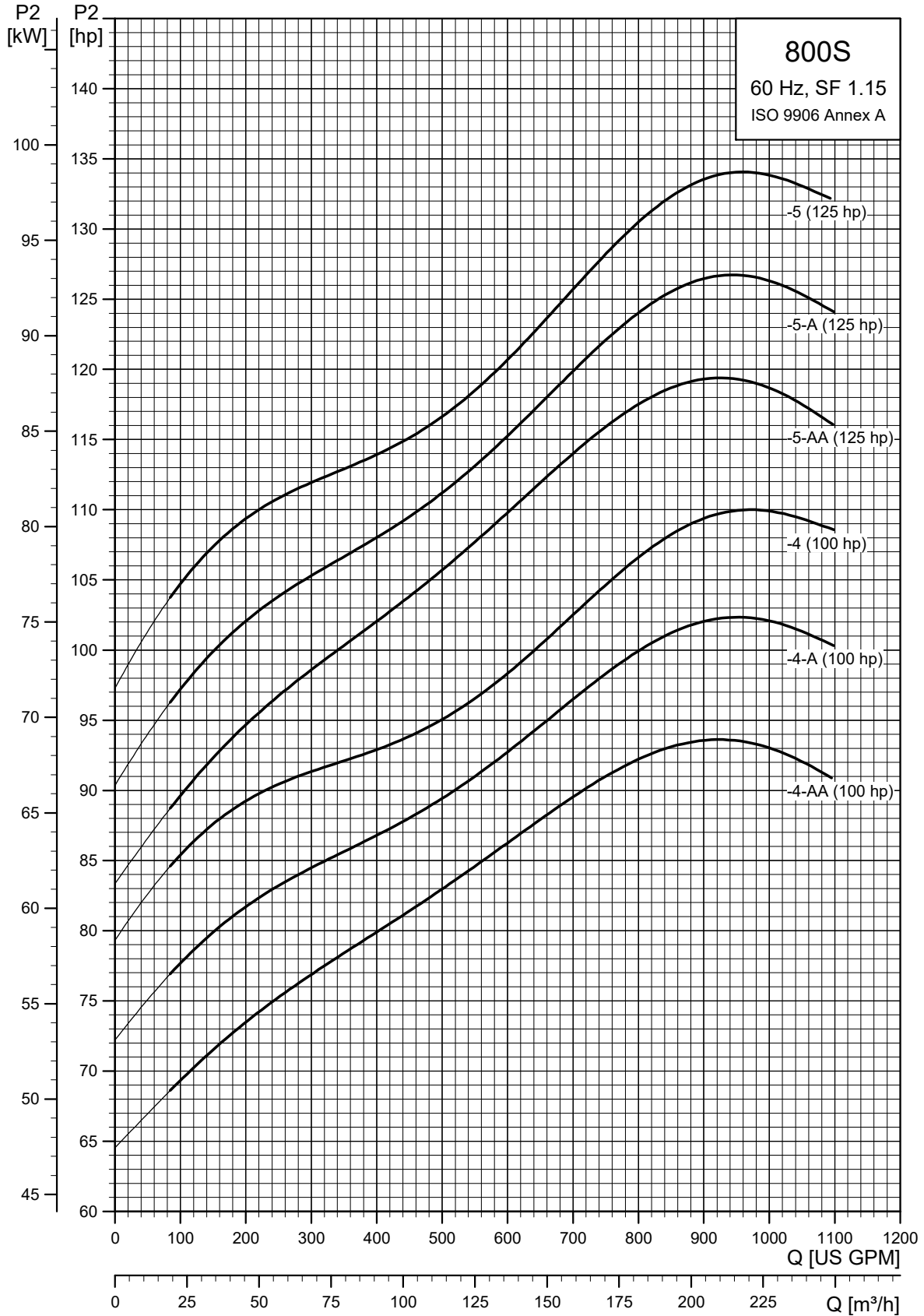

TM050266

**SP 800S (800 gpm) pump with 6", 8" motors**

Pump model	Nom. head [ft]	Motor					Dimensions [in (mm)]					Net weight (complete) [lb]	800S
		Ph	Volts [V]	[Hp]	[rpm]	A	B	C	D	E			
<b>800S - Motor diameter 6 inch, 60 Hz, rated flow rate 800 gpm (6" NPT)</b>													
800S200-1A	72	3	230	20	▲	3481	56.50 (1435)	30.83 (783)	25.67 (652)	5.63 (143)	8.31 (211)	180.0	
	72	3	460	20	▲	3492	56.50 (1435)	30.83 (783)	25.67 (652)	5.63 (143)	8.31 (211)	180.0	
800S300-1	95	3	230	30	▲	3479	61.23 (1555)	35.56 (903)	25.67 (652)	5.63 (143)	8.31 (211)	202.5	
	96	3	460	30	▲	3491	61.23 (1555)	35.56 (903)	25.67 (652)	5.63 (143)	8.31 (211)	202.5	
800S400-2AA	143	3	460	40	▲	3490	72.05 (1830)	40.28 (1023)	31.78 (807)	5.63 (143)	8.31 (211)	257.4	
800S500-2A	172	3	460	50	☼	3486	88.00 (2235)	56.11 (1425)	31.87 (810)	5.63 (143)	8.39 (213)	363.2	
800S500-2	189	3	460	50	☼	3463	88.00 (2235)	56.11 (1425)	31.87 (810)	5.63 (143)	8.39 (213)	363.2	
800S600-3AA	239	3	460	60	☼	3446	94.03 (2388)	56.11 (1425)	37.92 (963)	5.63 (143)	8.39 (213)	381.4	
<b>800S - Motor diameter 8 inch, 60 Hz, rated flow rate 800 gpm (6" NPT)</b>													
800S400-2AA	141	3	460	40	*	3462	75.48 (1917)	43.71 (1110)	31.78 (807)	7.56 (192)	8.39 (213)	409.4	
800S500-2A	174	3	460	50	*	3507	77.45 (1967)	45.67 (1160)	31.78 (807)	7.56 (192)	8.39 (213)	431.4	
800S500-2	192	3	460	50	*	3489	77.45 (1967)	45.67 (1160)	31.78 (807)	7.56 (192)	8.39 (213)	438.0	
800S600-3AA	247	3	460	60	*	3508	87.92 (2233)	50.00 (1270)	37.92 (963)	7.56 (192)	8.39 (213)	490.8	
800S750-3A	281	3	460	75	*	3523	91.07 (2313)	53.15 (1350)	37.92 (963)	7.56 (192)	8.39 (213)	523.8	
800S750-3	293	3	460	75	*	3514	91.07 (2313)	53.15 (1350)	37.92 (963)	7.56 (192)	8.39 (213)	523.8	
800S1000-4AA	354	3	460	100	*	3524	106.62 (2708)	62.60 (1590)	44.02 (1118)	7.56 (192)	8.39 (213)	633.8	
800S1000-4A	385	3	460	100	*	3519	106.62 (2708)	62.60 (1590)	44.02 (1118)	7.56 (192)	8.39 (213)	633.8	
800S1000-4	390	3	460	100	*	3511	106.62 (2708)	62.60 (1590)	44.02 (1118)	7.56 (192)	8.39 (213)	633.8	
800S1250-5AA	454	3	460	125	*	3503	122.21 (3104)	72.05 (1830)	50.16 (1274)	7.56 (192)	8.39 (213)	748.3	
800S1250-5A	457	3	460	125	*	3496	122.21 (3104)	72.05 (1830)	50.16 (1274)	7.56 (192)	8.39 (213)	748.3	
800S1250-5	479	3	460	125	*	3489	122.21 (3104)	72.05 (1830)	50.16 (1274)	7.56 (192)	8.39 (213)	746.6	

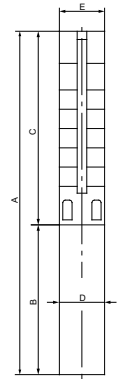

E = Maximum diameter of pump including cable guard and motor

**Notes:**

Performance conforms to ISO 9906. 1999 (E) Annex A. Minimum submergence is 25 ft (7.6 m).

▲	MS6000C motor
☼	Takes MMS6 motor; not available as complete.
*	Takes MMS8000 motor; not available as complete.

SP 1100S (1100 gpm)

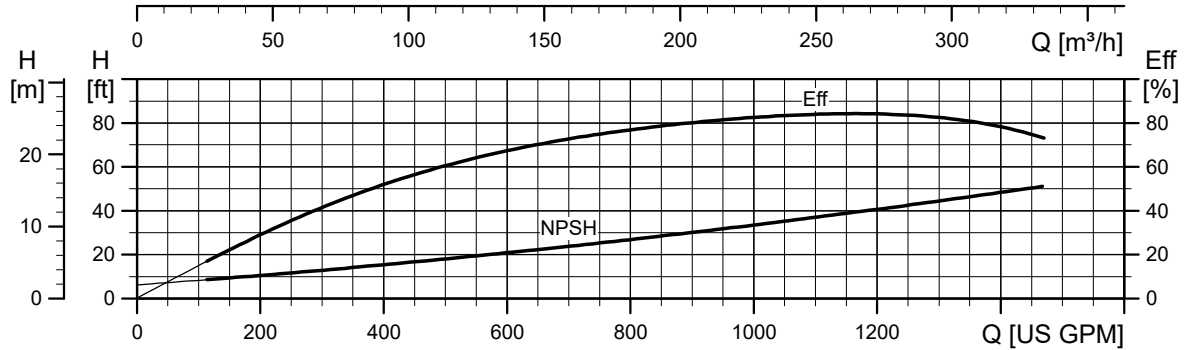
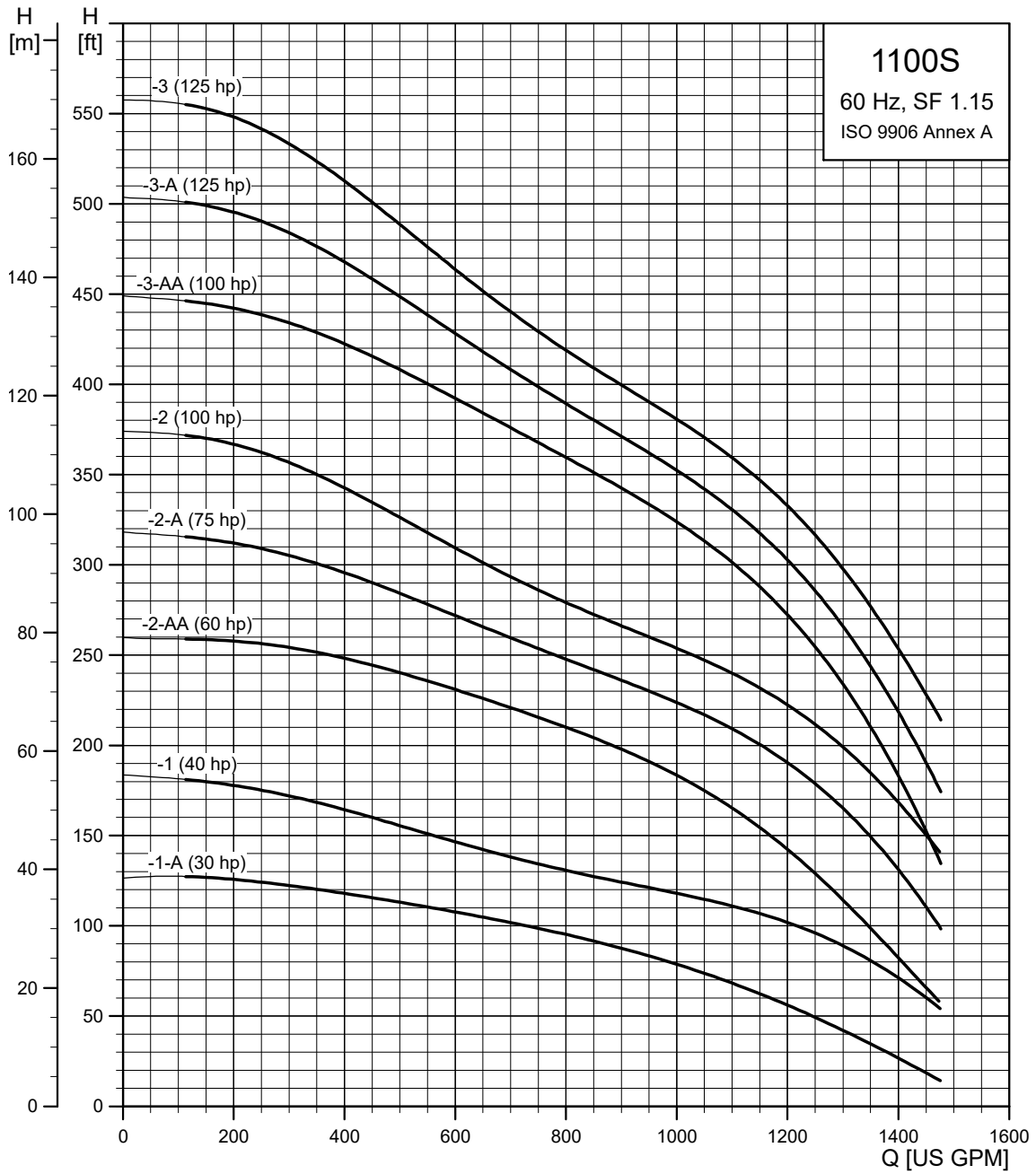

TM050267

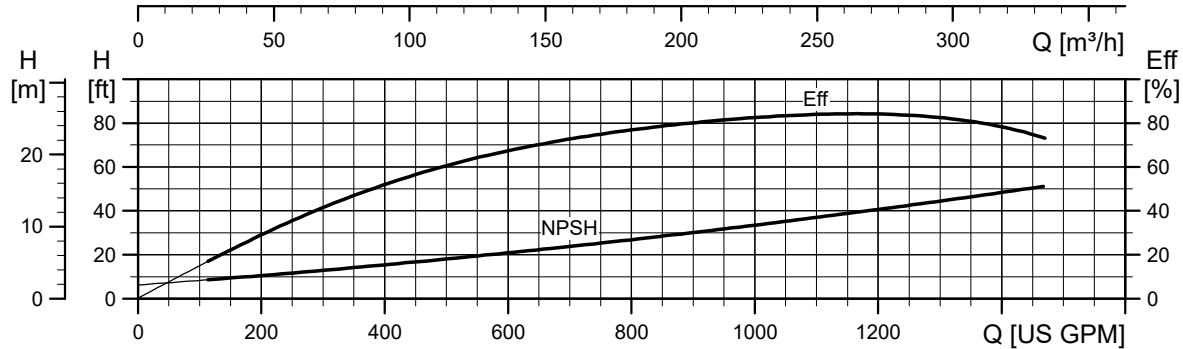
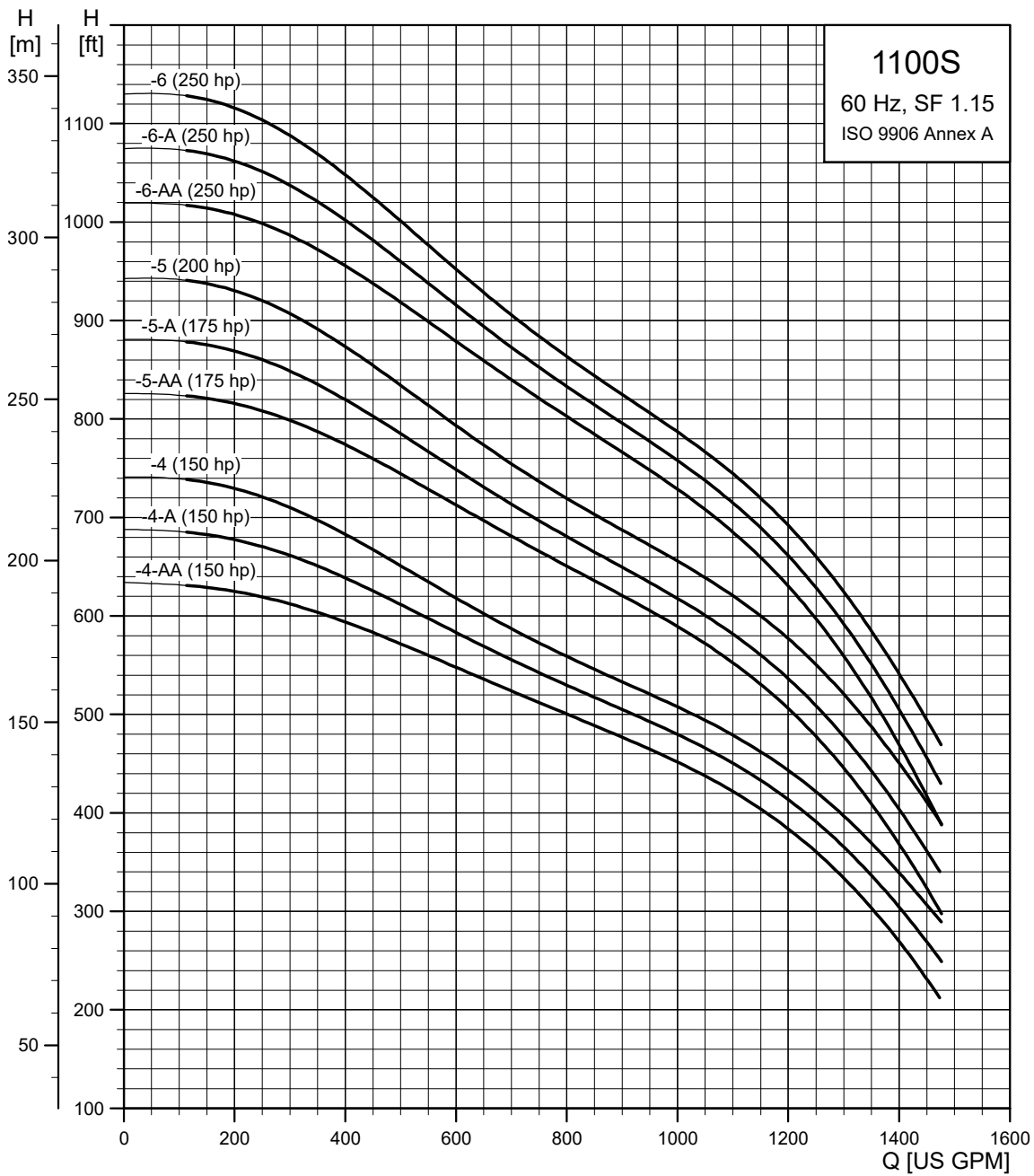

TM050268

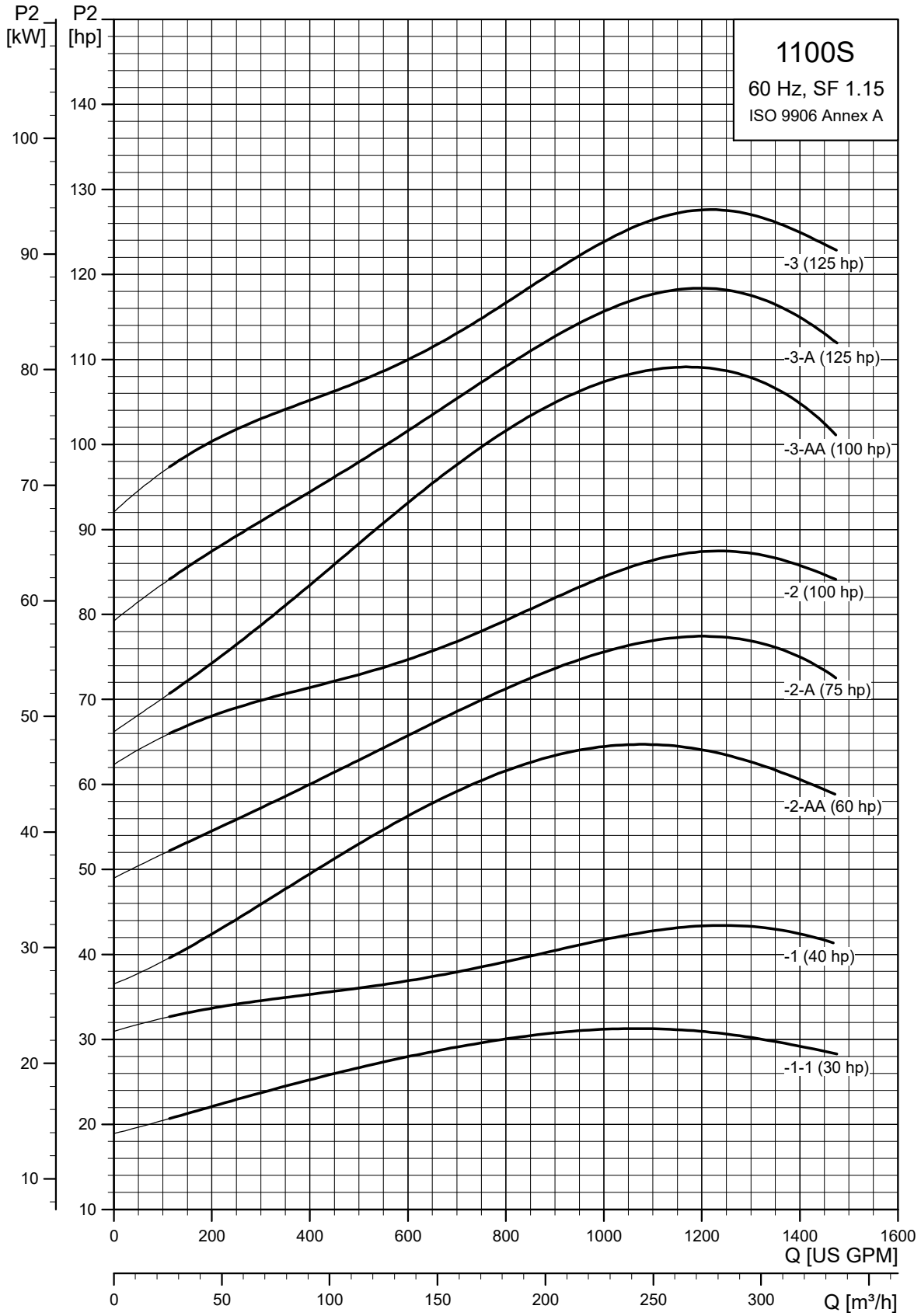

TM050269

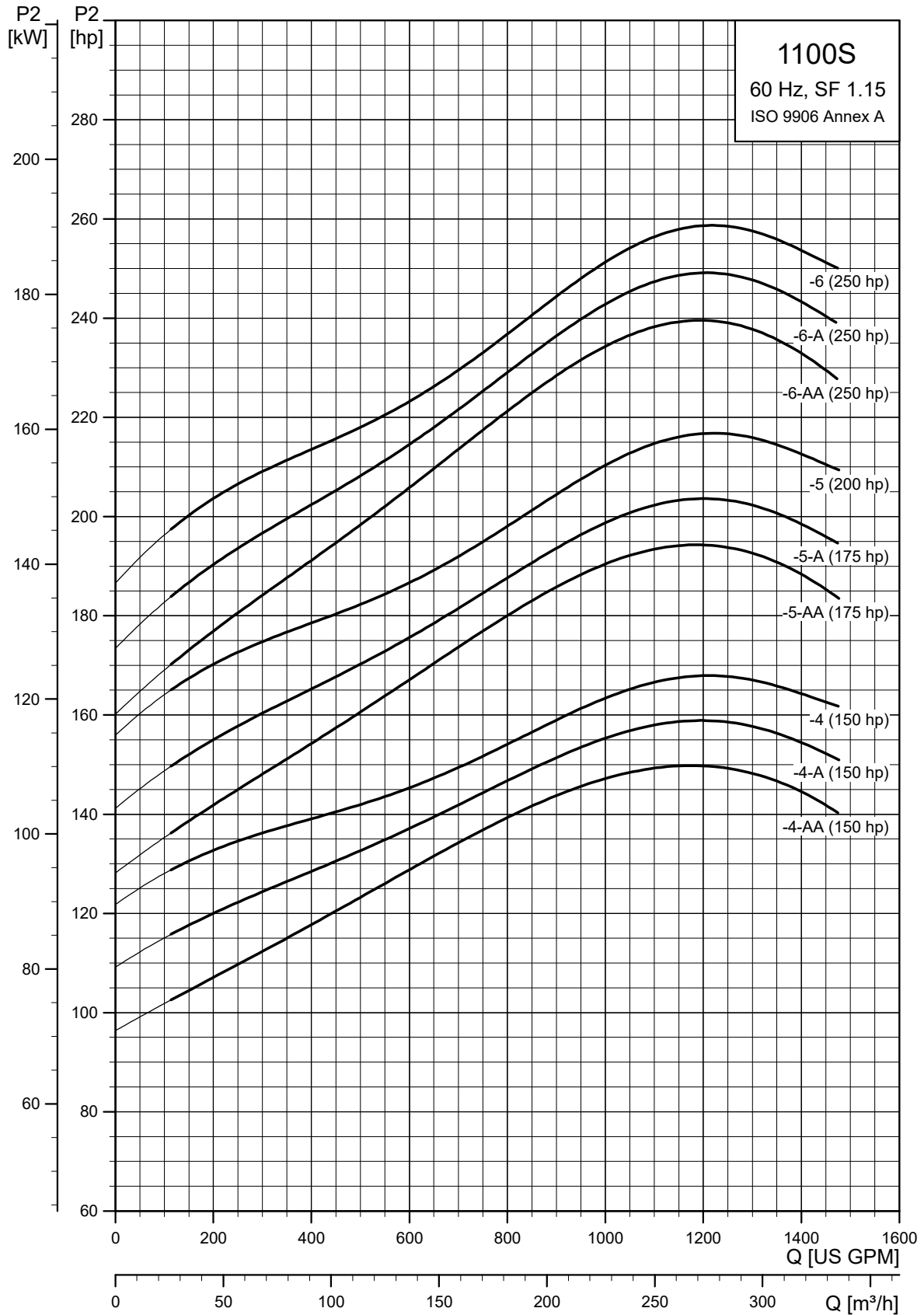

TM050270



**SP 1100S (1100 gpm) pump with 6", 8", 10" motors**

Pump model	Nom. head [ft]	Ph	Motor			Dimensions [in (mm)]					Net weight (complete) [lb]	1100S
			Volts [V]	[Hp]	[rpm]	A	B	C	D	E		
<b>100S - Motor diameter 6 inch, 60 Hz, rated flow rate 1100 gpm (6" NPT)</b>												
1100S300-1A	77	3	230	30 ▲	3449	66.66 (1693)	35.56 (903)	31.11 (790)	5.63 (143)	9.30 (236)	261.0	
	89	3	460	30 ▲	3481	66.66 (1693)	35.56 (903)	31.11 (790)	5.63 (143)	9.30 (236)	261.0	
1100S400-1	109	3	460	40 ▲	3476	71.38 (1813)	40.28 (1023)	31.11 (790)	5.63 (143)	9.30 (236)	290.6	
1100S600-2AA	178	3	460	60 ☼	3455	94.15 (2391)	56.11 (1425)	38.04 (966)	5.63 (143)	9.30 (236)	389.8	
<b>1100S - Motor diameter 8 inch, 60 Hz, rated flow rate 1100 gpm (6" NPT)</b>												
1100S400-1	110	3	460	40 *	3493	74.81 (1900)	43.71 (1110)	31.11 (790)	7.56 (192)	9.41 (239)	407.2	
1100S600-2AA	180	3	460	60 *	3510	88.04 (2236)	50.00 (1270)	38.04 (966)	7.56 (192)	9.41 (239)	501.8	
1100S750-2A	217	3	460	75 *	3521	91.19 (2316)	53.15 (1350)	38.04 (966)	7.56 (192)	9.41 (239)	534.8	
1100S1000-2	230	3	460	100 *	3529	100.63 (2556)	62.60 (1590)	38.04 (966)	7.56 (192)	9.41 (239)	633.8	
1100S1000-3AA	314	3	460	100 *	3511	107.56 (2732)	62.60 (1590)	44.97 (1142)	7.56 (192)	9.41 (239)	655.9	
1100S1250-3A	319	3	460	125 *	3503	117.01 (2972)	72.05 (1830)	44.97 (1142)	7.56 (192)	9.41 (239)	757.1	
1100S1250-3	340	3	460	125 *	3495	117.01 (2972)	72.05 (1830)	44.97 (1142)	7.56 (192)	9.41 (239)	757.1	
1100S1500-4AA	411	3	460	150 *	3498	133.00 (3378)	81.11 (2060)	51.89 (1318)	7.56 (192)	9.41 (239)	889.1	
1100S1500-4A	431	3	460	150 *	3485	133.00 (3378)	81.11 (2060)	51.89 (1318)	7.56 (192)	9.41 (239)	889.1	
1100S1500-4	450	3	460	150 *	3491	133.00 (3378)	81.11 (2060)	51.89 (1318)	7.56 (192)	9.41 (239)	889.1	
<b>1100S - Motor diameter 10 inch, 60 Hz, rated flow rate 1100 gpm (6" NPT)</b>												
1100S1750-5AA	524	3	460	175 †	3510	132.45 (3364)	73.63 (1870)	58.82 (1494)	9.34 (237)	9.85 (250)	1142.2	
1100S1750-5A	559	3	460	175 †	3446	132.45 (3364)	73.63 (1870)	58.82 (1494)	9.34 (237)	9.85 (250)	1137.0	
1100S2000-5	577	3	460	200 †	3522	140.32 (3564)	81.5 (2070)	58.82 (1494)	9.34 (237)	9.85 (250)	1285.2	
1100S2600-6AA	658	3	460	250 †	3520	160.24 (4070)	94.49 (2400)	65.75 (1670)	9.34 (237)	9.85 (250)	1478.0	
1100S2600-6A	673	3	460	250 †	3520	160.24 (4070)	94.49 (2400)	65.75 (1670)	9.34 (237)	9.85 (250)	1483.2	
1100S2600-6	703	3	460	250 †	3520	160.24 (4070)	94.49 (2400)	65.75 (1670)	9.34 (237)	9.85 (250)	1483.2	

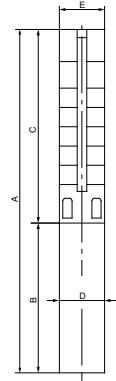

E = Maximum diameter of pump including cable guard and motor

**Notes:**

Performance conforms to ISO 9906. 1999 (E) Annex A. Minimum submergence is 30 ft (9.1 m).

▲	MS6000C motor
☼	Takes MMS6 motor; not available as complete.
*	Takes MMS8000 motor; not available as complete.
†	Takes MMS10000 motor; not available as complete.

# 7. Electrical data

Motor type	Hp	kW	Volt [V]	Service factor	Full load				Service factor (max. load)				Locked rotor [A] <sup>6)</sup>	KVA code	Max. thrust	rpm
					[A]	[W] <sup>5)</sup>	Power factor	Eff. [%]	[A]	[W] <sup>5)</sup>	Power factor	Eff. [%]				
<b>4" 2-wire single phase motors - control box not required</b>																
MS402	.5	0.37	115	1.60	9.5	675	0.67	55.0	12.0	1076	0.78	62	82.8	R	900	3450
	.5	0.37	230	1.60	4.5	646	0.63	57.7	6.0	1049	0.76	62	37.2	R	900	3450
	.75	0.55	230	1.50	6.9	994	0.63	56.3	8.4	1449	0.75	62	51.2	N	900	3450
	1	0.75	230	1.40	8.8	1260	0.67	59.7	9.8	1848	0.82	63	55.9	M	900	3450
	1.5	1.10	230	1.30	11.6	1760	0.70	62.7	13.1	2561	0.85	64	81.2	L	900	3450
<b>4" 3-wire single phase motors - control box required</b>																
MS402	.5	0.37	115	1.60	10.0	992	0.74	37.6	12.0	1049	0.73	61	44.4	L	900	3450
	.5	0.37	230	1.60	5.6	968	0.75	38.2	6.0	1049	0.76	62	24.6	L	900	3450
	.75	0.55	230	1.50	8.4	1410	0.76	39.7	8.4	1449	0.75	62	34.4	L	900	3450
	1	0.75	230	1.40	9.0	1662	0.81	44.9	9.8	1848	0.82	63	42.1	K	900	3450
	1.5	1.10	230	1.30	10.7	2169	0.89	51.6	11.6	2375	0.89	69	58.0	H	900	3450
MS4000C	2	1.50	230	1.25	13.1	2582	0.86	57.8	13.2	2611	0.86	72	55.4	G	1500	3450
	3	2.20	230	1.15	16.8	3601	0.93	62.1	17.0	3636	0.93	74	103.7	F	1500	3450
	5	3.70	230	1.15	25.7	5645	0.96	66.0	27.5	5819	0.92	77	110.0	F	1500	3450
<b>4" three phase 60 Hz motors</b>																
MS402	.5	0.37	208	1.60	3.3	623	0.53	59.4	3.5	908	0.72	67	16.1	N	900	3450
			230	1.60	3.0	625	0.53	59.2	3.2	904	0.72	67	14.5	N	900	3450
			460	1.60	1.5	625	0.53	59.2	1.6	918	0.72	67	7.4	N	900	3450
			575	1.60	1.2	618	0.53	59.5	1.3	896	0.72	67	5.8	N	900	3450
	.75	0.55	208	1.50	4.6	878	0.53	62.7	5.1	1286	0.70	69	23.5	N	900	3450
			230	1.50	4.2	883	0.53	62.3	4.6	1283	0.70	69	21.2	N	900	3450
			460	1.50	2.1	878	0.53	62.6	2.3	1283	0.70	69	10.6	N	900	3450
			575	1.50	1.7	881	0.53	62.4	1.9	1290	0.70	69	8.5	N	900	3450
	1	0.75	208	1.40	4.9	1105	0.63	67.4	6.0	1578	0.73	70	28.8	M	900	3450
			230	1.40	4.6	1129	0.62	66.3	5.4	1570	0.73	70	25.9	M	900	3450
			460	1.40	2.3	1131	0.62	66.3	2.7	1570	0.73	70	13.0	M	900	3450
			575	1.40	1.8	1130	0.62	66.3	2.2	1563	0.73	70	10.3	M	900	3450
	1.5	1.10	208	1.30	6.6	1581	0.67	70.1	8.1	2101	0.72	75	40.5	M	900	3450
			230	1.30	5.8	1571	0.68	70.8	7.3	2094	0.72	75	37.2	M	900	3450
			460	1.30	2.9	1559	0.67	71.0	3.7	2094	0.72	75	18.6	M	900	3450
			575	1.30	2.3	1560	0.69	70.7	2.9	2080	0.72	75	14.5	M	900	3450
	2	1.50	208	1.25	8.1	2043	0.70	73.2	9.6	2594	0.75	76	51.8	L	900	3450
			230	1.25	7.5	2062	0.69	72.8	8.7	2599	0.75	76	47.0	L	900	3450
			460	1.25	3.7	2056	0.69	72.7	4.4	2599	0.75	76	23.5	L	900	3450
			575	1.25	3.1	2071	0.68	72.7	3.5	2614	0.75	76	19.3	L	900	3450

Motor type	Hp	kW	Volt [V]	Service factor	Full load				Service factor (max. load)				Locked rotor [A] <sup>6)</sup>	KVA code	Max. thrust	rpm
					[A]	[W] <sup>5)</sup>	Power factor	Eff. [%]	[A]	[W] <sup>5)</sup>	Power factor	Eff. [%]				
<b>4" 2-wire single phase motors - control box not required</b>																
MS4000C	3	2.20	208	1.15	9.9	2996	0.84	72.6	11.9	3644	0.85	73	61.9	J	1500	3415
			230	1.15	10.4	3054	0.74	71.6	11.6	3466	0.75	73	60.3	J	1500	3460
			440	1.15	5.0	3010	0.79	73.6	5.7	3531	0.82	73	28.8	J	1500	3440
			460	1.15	5.2	3042	0.74	72.7	5.8	3604	0.78	73	30.7	J	1500	3460
			575	1.15	3.9	3014	0.77	73.5	4.7	3520	0.76	73	24.2	J	1500	3470
	5	3.70	208	1.15	15.7	4864	0.86	76.0	18.6	5830	0.87	77	106.0	K	1500	3425
			230	1.15	15.0	4840	0.81	76.7	17.4	5407	0.78	77	102.7	K	1500	3470
			440	1.15	7.5	4820	0.84	76.5	8.7	5472	0.83	77	47.6	J	1500	3460
			460	1.15	7.5	4814	0.81	76.6	8.7	5513	0.80	77	51.0	J	1500	3470
			575	1.15	6.1	4617	0.76	80.5	6.9	5498	0.80	77	40.7	J	1500	3470
	7.5	5.50	208	1.15	22.8	7146	0.87	76.8	27.0	8657	0.89	81	137.7	I	1500	3415
			230	1.15	21.5	7023	0.82	78.0	25.0	8167	0.82	81	155.0	I	1500	3460
			440	1.15	10.8	6996	0.85	78.0	12.8	8487	0.87	81	73.0	I	1500	3440
			460	1.15	10.6	6925	0.82	78.3	12.6	8232	0.82	81	78.1	I	1500	3460
			575	1.15	8.7	6876	0.79	81.4	10.0	8167	0.82	81	62.0	I	1500	3460
	10	7.50	440	1.15	15.1	9667	0.84	78.0	18.0	11386	0.83	81	108.0	J	1500	3420
			460	1.15	15.0	9561	0.80	78.0	18.6	11856	0.80	81	119.0	J	1500	3460
			575	1.15	12.5	9212	0.74	81.0	14.4	11330	0.79	81	90.7	J	1500	3440

5) Calculated value (voltage × current × Cos F)

6) Calculated value (full load current × locked rotor current %)

Motor type	Hp	kW	Volt [V]	Service factor	Full load				Service factor (max. load)				Locked rotor [A] <sup>6)</sup>	KVA code	Max. thrust	rpm
					[A]	[W] <sup>5)</sup>	Power factor	Eff. [%]	[A]	[W] <sup>5)</sup>	Power factor	Eff. [%]				
<b>6" three phase 60 Hz motors</b>																
MS6000C	5	3.70	208	1.15	16.9	4932	0.81	79.3	19.0	5681	0.83	79.3	95.0	H	6070	3480
			230	1.15	16.2	4969	0.77	79.2	17.8	5673	0.80	79.9	105.0	H	6070	3510
			460	1.15	8.0	4908	0.77	79.4	8.8	5609	0.80	80.2	51.3	H	6070	3500
	7.5	5.50	208	1.15	24.2	7149	0.82	80.2	27.5	8223	0.83	79.4	114.0	H	6070	3450
			230	1.15	23.4	7178	0.77	80.6	26.0	8286	0.80	80.8	130.0	H	6070	3480
			440	1.15	11.6	7161	0.81	80.6	13.2	8249	0.82	80.4	61.0	J	6070	3470
			460	1.15	11.6	7117	0.77	80.6	13.0	8286	0.80	80.8	64.5	J	6070	3480
			480	1.15	12.0	7283	0.73	80.2	13.0	8322	0.77	80.7	68.0	J	6070	3490
	10	7.50	575	1.15	9.3	7186	0.78	80.6	10.2	8228	0.81	80.8	51.0	H	6070	3480
			208	1.15	32.0	9684	0.84	80.5	37.5	11483	0.85	79.2	126.0	G	6070	3420
			230	1.15	30.0	9680	0.81	81.7	33.5	11077	0.83	81.5	142.0	G	6070	3470
			440	1.15	15.2	9615	0.83	81.5	17.4	11139	0.84	81.1	67.5	G	6070	3450
			460	1.15	15.0	9680	0.81	81.8	16.8	11110	0.83	81.7	71.0	G	6070	3470
	15	11.00	480	1.15	15.0	9602	0.77	81.8	16.6	11041	0.80	82.0	75.0	G	6070	3480
			575	1.15	12.0	9680	0.81	81.4	13.4	11077	0.83	81.2	56.5	G	6070	3470
			208	1.15	46.5	14072	0.84	82.1	53.5	16383	0.85	81.1	198.0	G	6070	3430
			230	1.15	44.5	14005	0.79	83.0	49.5	16170	0.82	82.9	224.0	G	6070	3470
			440	1.15	22.0	13916	0.83	82.8	25.0	16004	0.84	82.1	100.0	H	6070	3450
			460	1.15	21.6	13940	0.81	83.1	24.4	16136	0.83	82.8	106.0	H	6070	3470
			480	1.15	21.6	13828	0.77	83.1	24.0	15963	0.80	83.2	112.0	H	6070	3480
575	1.15	17.2	13875	0.81	83.0	19.4	16036	0.83	82.7	84.0	G	6070	3460			

Motor type	Hp	kW	Volt [V]	Service factor	Full load				Service factor (max. load)				Locked rotor [A] <sup>6)</sup>	KVA code	Max. thrust	rpm		
					[A]	[W] <sup>5)</sup>	Power factor	Eff. [%]	[A]	[W] <sup>5)</sup>	Power factor	Eff. [%]						
<b>6" three phase 60 Hz motors</b>																		
	20	15.00	208	1.15	61.5	19054	0.86	82.7	71.5	22153	0.86	81.5	310.0	H	6070	3430		
			230	1.15	57.5	18783	0.82	84.0	65.0	21751	0.84	83.7	350.0	H	6070	3470		
			440	1.15	29.0	18565	0.84	83.7	33.5	21701	0.85	82.9	166.0	J	6070	3450		
			460	1.15	29.0	18947	0.82	84.0	32.5	21751	0.84	83.7	176.0	J	6070	3470		
			480	1.15	29.0	18806	0.78	83.9	32.0	21549	0.81	83.9	186.0	J	6070	3480		
			575	1.15	23.4	18877	0.81	83.8	26.0	21492	0.83	83.5	144.0	J	6070	3480		
	25	18.50	208	1.15	75.0	23237	0.86	83.4	87.0	26955	0.86	82.3	395.0	J	6070	3430		
			230	1.15	71.0	22910	0.81	84.6	80.0	26452	0.83	84.3	445.0	J	6070	3480		
			440	1.15	36.0	23046	0.84	84.3	41.0	26559	0.85	83.6	212.0	J	6070	3460		
			460	1.15	35.5	22910	0.81	84.6	40.0	26452	0.83	84.3	224.0	J	6070	3480		
			480	1.15	36.0	23046	0.77	84.3	39.5	26272	0.80	84.4	236.0	J	6070	3490		
			575	1.15	28.5	23275	0.82	84.0	32.0	26452	0.83	83.7	180.0	J	6070	3480		
	30	22.00	208	1.15	88.0	27582	0.87	83.3	104.0	32597	0.87	81.8	445.0	H	6070	3420		
			230	1.15	81.0	27105	0.84	85.1	92.0	31153	0.85	84.4	500.0	H	6070	3470		
			440	1.15	41.5	27199	0.86	84.5	48.0	31825	0.87	83.5	238.0	J	6070	3450		
			460	1.15	40.5	27105	0.84	85.1	46.0	31153	0.85	84.4	250.0	J	6070	3470		
			480	1.15	40.0	26937	0.81	85.2	45.0	31052	0.83	85.0	265.0	J	6070	3480		
			575	1.15	32.0	27089	0.85	84.8	37.0	31690	0.86	84.0	194.0	H	6070	3460		
	40	30.00	440	1.15	56.0	37130	0.87	84.7	65.0	43592	0.88	83.6	290.0	H	6070	3440		
			460	1.15	54.5	36909	0.85	85.2	62.0	42482	0.86	84.7	310.0	H	6070	3460		
			480	1.15	54.5	37155	0.82	85.3	61.0	42600	0.84	85.1	330.0	H	6070	3480		
			575	1.15	43.5	36824	0.85	85.2	49.5	42890	0.87	84.7	250.0	G	6070	3470		
<b>6" three phase 60 Hz motors</b>																		
MMS6	50	37.00	460	1.15	73.0	47111	0.81	83.2	82.0	54226	0.83	82.6	405	H	6000	3450		
MMS6	60	45.00	460	1.15	86.3	57070	0.83	85.0	97.0	66464	0.86	86.0	525	G	6000	3455		
<b>8" three phase 60 Hz motors</b>																		
			40	30.00	460	1.15	53.3	36096	0.85	82.5	64.0	43853	0.86	83.0	371	K	13000	3490
			50	37.00	460	1.15	65.6	44426	0.85	83.7	78.0	53446	0.86	84.0	429	J	13000	3480
			60	45.00	460	1.15	77.5	52485	0.85	85.4	92.5	64118	0.87	86.0	592	K	13000	3500
			75	55.00	460	1.15	101.0	65182	0.81	85.8	112.0	77635	0.87	86.0	650	J	13000	3500
			100	75.00	460	1.15	126.0	86335	0.86	86.6	150.0	105170	0.88	87.0	855	J	13000	3500
			125	92.00	460	1.15	155.5	107787	0.87	86.9	184.0	129009	0.88	87.0	1104	J	13000	3480
			150	110.00	460	1.15	186.2	129068	0.87	86.6	220.0	154250	0.88	86.0	1276	J	13000	3480
			MMS8000			40	30.0	575	1.15	43.3	37086	0.86	81.0	49.0	42456	0.87	85.0	202
50	37.0	575	1.15			55.5	46983	0.85	79.0	62.2	53274	0.86	84.0	257	G	13000	3500	
60	45.0	575	1.15			62.0	53720	0.87	84.0	71.0	62226	0.88	85.0	465	J	13000	3500	
75	55.0	575	1.15			79.1	67749	0.86	81.0	89.4	78352	0.88	85.0	586	L	13000	3485	
100	75.0	575	1.15			104.0	91147	0.88	82.0	118.0	104592	0.89	86.0	786	N	13000	3470	
125	92.0	575	1.15			118.4	104947	0.89	88.0	144.0	127638	0.89	86.0	1007	R	13000	3470	
150	110.0	575	1.15			156.0	127399	0.82	86.0	176.0	147238	0.84	89.0	1230	H	13000	3470	
<b>10" three phase 60 Hz motors</b>																		
MMS10000			175	132.00	460	1.15	226.2	151388	0.84	86.5	265.0	181578	0.86	88.0	1511	J	13000	3510
			200	147.00	460	1.15	266.4	171924	0.81	86.6	305.0	204126	0.84	87.0	1891	K	13000	3520
			250	190.00	460	1.15	339.8	213879	0.79	86.7	405.0	264598	0.82	87.0	2471	K	13000	3520

## 8. Approvals

Product	Approval		
SP 4"			
SP 4" pump end (5S - 77S)	 <b>WATER QUALITY</b> <b>Drinking Water System Component</b> <b>NSF/ANSI 61 MH26400</b> <b>NSF/ANSI 372</b>		
MS6000C motor		 <b>Submersible Motor NSF/</b> <b>ANSI 372 MH26400</b>	
MS4000C motor		IAPMO File 6591 0.25 % lead	
MS402 motor			IAPMO File 6591 0.25 % lead

Grundfos SP pumps are certified when driven by a certified motor provided with suitable overheating protection.

## 9. Accessories

### Grundfos RSI (Renewable Solar Inverter)

Grundfos RSI is an off-grid solar inverter that converts the DC power output from a solar panel to AC power supply for pump operation.

RSI is designed for continuous as well as intermittent operation. The system is suitable for various water supply systems including irrigation.

The RSI can be used in existing systems with submersible pumps or dry-installed pumps, thus providing a very wide range of applications allowing you to leverage renewable energy sources with the ability to back up the system with grid or generator power.

RSI features:

- weatherproof (enclosure class IP66)
- setup wizard
- can operate without the detachable, magnetic control panel
- AC/DC<sup>7)</sup> compatibility for connecting to the grid or use as a generator as back-up power during solar panel disruptions
- maximum power point tracking (MPPT) optimizes available solar irradiation and environmental conditions
- overvoltage and undervoltage protection
- overload protection
- overcurrent protection
- overtemperature protection<sup>8)</sup>
- no-load protection
- operating history memory.

<sup>7)</sup> Solar power (DC) and AC power must never be connected at the same time.

<sup>8)</sup> The inverter does not detect motor temperature or protect the motor against overtemperature.



TM068226

*Grundfos RSI*

### System components

An RSI system consists of a three-phase Grundfos motor, an RSI solar inverter, and other components such as:

- circuit breaker, AC (optional)
- circuit breaker, DC
- surge protection, DC
- solar panel
- dry-running switch
- level switch (optional)
- sine-wave filter (optional)
- combiner box (junction box).

### Pump requirements:

- 50 or 60 Hz
- 3 × 380-440 VAC or 3 × 220 VAC.

As standard, Grundfos three-phase pumps can only be operated through an AC voltage supply. Therefore, the solar panels must not be connected directly to the pump but must be connected through an RSI.

## Example

Voltage			3 × 208-240 V	3 × 380-440 V
Installation environment	Minimum ambient temperature	[°F (°C)]	14 (-10)	14 (-10)
	Maximum ambient temperature	[°F (°C)]	140 (60)	140 (60)
	Maximum relative humidity	[%]	100	100
Electrical data	DC minimum MPP voltage	[VDC]	230	400
	DC recommended MPP voltage	[VDC]	290-336	530-615
	DC maximum input voltage	[VDC]	380	800
	AC input voltage	[VAC]	208-240	380-460
	AC rated output voltage	[VAC]	220	380-440
	Minimum frequency	[Hz]	5	5
	Maximum frequency	[Hz]	60	60
	Phases		3	3
	Enclosure class		IP66	IP66

## Low voltage range (3 × 208-240 V)

Power [kW]	Product number	Electrical data			Frame size
		Max. P2 [Hp]	Max. P2 [kW]	Rated output current [Amps]	
1.5	99090622	2	1.5	8	A
2.2	99090633	3	2.2	11	A
3	99090634	4	3.0	12.5	A
4	99090635	5	4.0	18	B
5.5	99090636	7.5	5.5	24.2	B
7.5	99090637	10	7.5	31	B
11	99090638	15	11	48	C
15	99090639	20	15	62	C

## High voltage range (3 × 380-440 V)

Power [kW]	Product number	Electrical data			Frame size
		Max. P2 [Hp]	Max. P2 [kW]	Rated output current [Amps]	
2.2	99044348	3	2.2	5.6	A
3.0	99044349	4	3.0	8	A
4.0	99044350	5	4.0	9.6	A
5.5	99044351	7.5	5.5	12	A
7.5	99044352	10	7.5	16	B
11	99044363	15	11	23	B
15	99044364	20	15	31	B
18.5	99044365	25	18.5	38	C
22	99044366	30	22	46	C
30	99044367	40	30	61	C
37	99044368	50	37	72	C

## SmartFlo variable frequency drive

Description	Product number
Combiner box (junction box) components kit, DC	98298572
Circuit breaker, DC	98341686
Surge protection, DC	98341687

### SmartFlo constant pressure drive kits (with sensor)

Enclosure type	NEMA	Hp	Input Ph	Input volts	Product number	Approximate ship wt. [lb]
Indoor	Type 12	2	1	200-240	98370277	60
		3	1	200-240	98370280	60
		5	1	200-240	98370304	60
Outdoor	Type 4X	2	1	200-240	98370279	60
		3	1	200-240	98370301	60
		5	1	200-240	98370305	60



SmartFlo variable frequency drive and sensor

TM055801

## Features

### User interface

The user interface offers these possibilities:

- Local operation via a operating panel with graphic display where the menu structure is based on the well-known system from Grundfos E-pumps.
- Monitoring of operating status via indicator lights and signal relays.
- Display of alarm or warning and logging of the last five alarms and warnings.

## Functions

### Control mode: Constant pressure

SmartFlo has only one control mode, Constant pressure. The pressure is kept constant, independently of the flow rate.

### Startup guide

SmartFlo has a startup guide, which is launched at the first power up. Parameters are set manually on the basis of the installation. The startup guide can be repeated, if necessary. Thanks to the startup guide, the installer can quickly set a few parameters and put SmartFlo into operation.

### Direction of rotation test

During startup, SmartFlo automatically tests and sets the correct direction of rotation without changing the cable connections. The direction of rotation test can be performed manually if it fails for any reason.

### Dry-running protection

To protect the pump, SmartFlo automatically sets up dry-running protection so that water shortage can be detected. The dry-running alarm automatically resets 30 minutes after the alarm is declared.

### Low-flow stop function

The low-flow stop function is used for changing between on/off operation at low flow rate and continuous operation at high flow rate.

The low-flow stop function protects the pump and saves energy.

### Example

For 4" or larger wells. Main applications:

- Domestic and light commercial water supply
- irrigation
- livestock watering
- water transfer.

## System components

- Compact, efficient, and reliable variable frequency drive
- rugged stainless steel pump end and proven, reliable, three-phase motor
- pressure sensor
- diaphragm tank (sold separately).



## SmartFlo identification

### Example

SmartFlo is identified by the nameplate. An example is shown below.

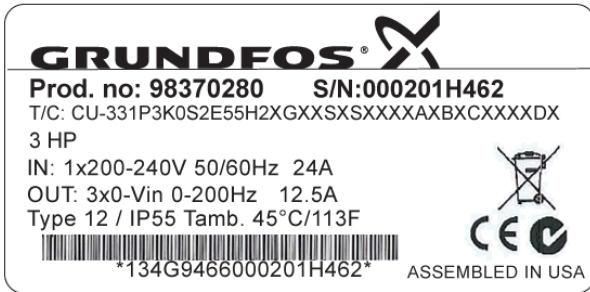

### Example of nameplate

Key	
Text	Description
T/C:	CU-331 (product name)
Prod. no:	Product number (98370280)
S/N:	Serial number (000201H462) The last four digits indicate the production date. In this case, 46 is the week and 2 is the year 2012.
3.0 hp	Typical shaft power on the motor
IN:	Supply voltage, frequency and maximum input current
OUT:	Motor voltage, frequency and maximum output current The maximum output frequency usually depends on the pump type.
Type 12 / IP55	Enclosure class
Tamb.	Maximum ambient temperature

## SmartFlo sizing

### Step 1

Calculate maximum head requirements at rated flow rate conditions:

$$H_{\max} = \text{dynamic head} + \text{system psi (in feet)} + \text{friction loss} + \text{above grade elevation}$$

### Step 2

Select pump from performance curves as follows:

Select a model in which the calculated value of  $H_{\max}$  is within the maximum performance curve of the pump. Refer to sections SmartFlo 2 hp, SmartFlo 3hp and SmartFlo 5 hp.

### Step 3

Select the SmartFlo that corresponds to the correct motor Hp and enclosure type.

### Related information

[SmartFlo, 2 Hp](#)

[SmartFlo, 3 Hp](#)

[SmartFlo, 5 Hp](#)

## SmartFlo product range

Enclosure type	NEMA	Hp	Input Ph	Input volts
Indoor	Type 12	2	1	200-240
		3	1	200-240
		5	1	200-240
Outdoor	Type 4X	2	1	200-240
		3	1	200-240
		5	1	200-240

## SmartFlo performance range

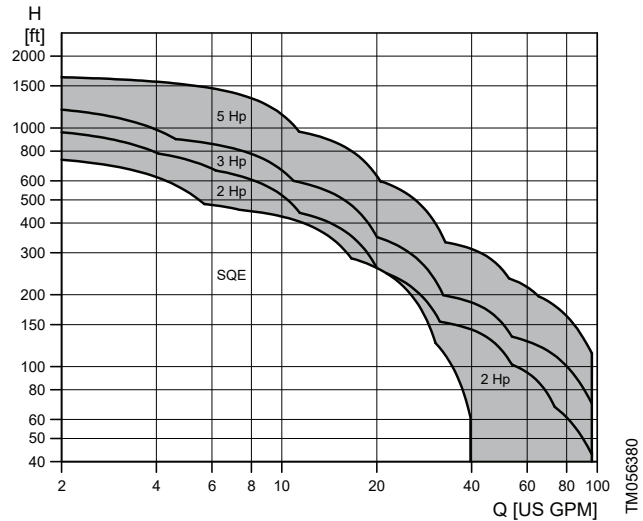

## SmartFlo operation

### Menu structure

SmartFlo has a startup guide, which is launched at the first power up. After the startup guide, SmartFlo has a menu structure divided into four main menus:

- 0. GENERAL** gives access to the startup guide for the general setting of SmartFlo.
- 1. OPERATION** enables the setting of setpoint and resetting of alarms. It is also possible to see the latest five warnings and alarms.
- 2. STATUS** shows the status of SmartFlo and the pump. It is not possible to change or set values.
- 3. INSTALLATION** gives access to available parameters.

# SmartFlo menu overview

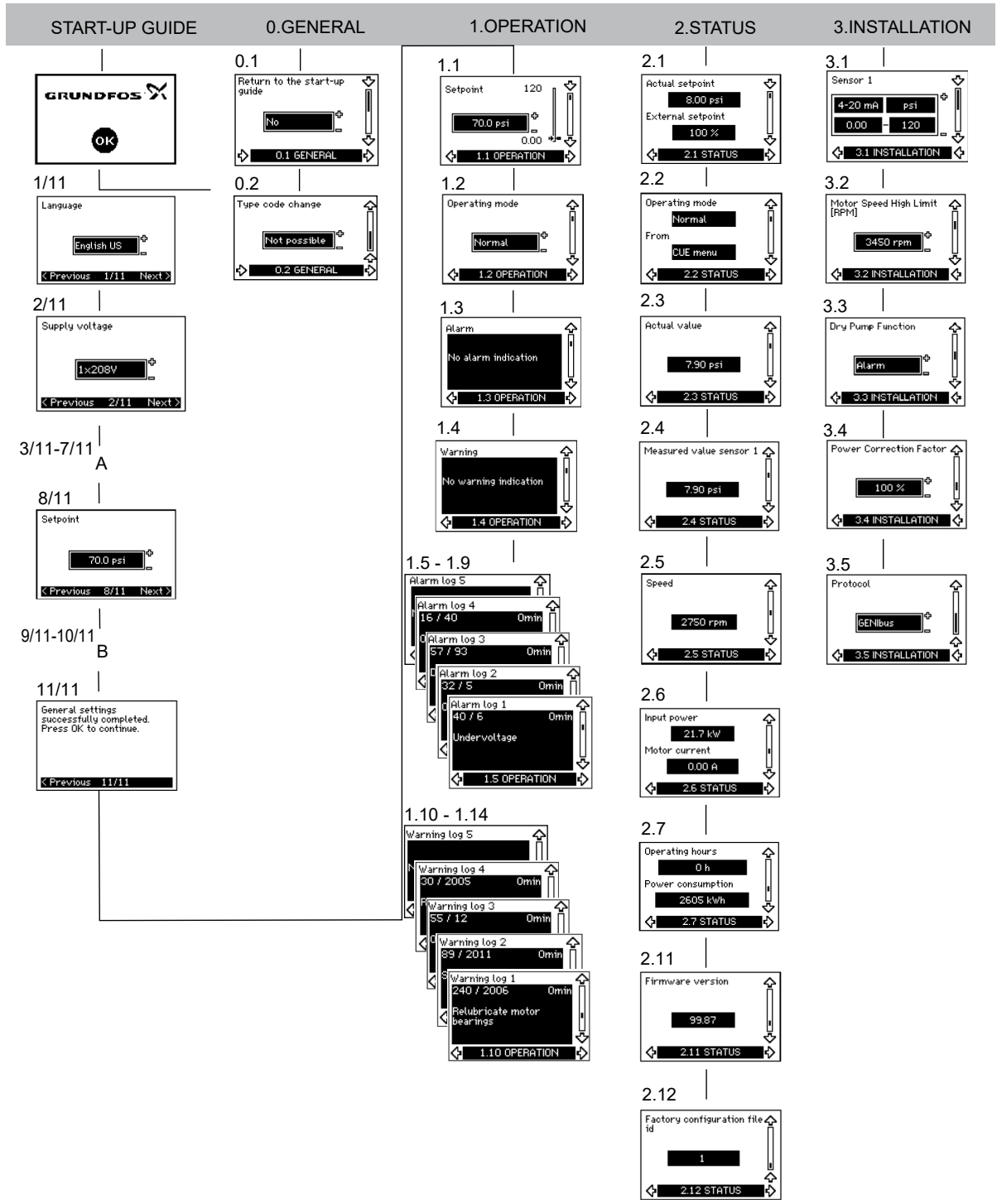

Menu overview

TM080072

## Operating modes

These operating modes can be selected with SmartFlo:

- Normal
- stop
- minimum
- maximum.

You can set the operating modes without changing the setpoint setting.

### Normal

The pump operates in constant pressure mode.

### Stop

The pump is stopped by the user.

### Minimum curve

The pump is running at a set minimum speed value. See the figure below.

For instance, this operating mode can be used during periods with a very small flow requirement.

### Related information

[Maximum curve](#)

### Maximum curve

The pump is running at a set maximum speed value.

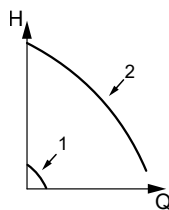

TM038813

Minimum and maximum curves

Pos.	Description
1	Min.
2	Max.

### Control mode

SmartFlo has been developed specifically to operate submersible pumps in constant pressure mode. This closed-loop control mode uses an analog pressure transducer to provide pressure feedback to the drive.

## Constant pressure with stop function

The outlet pressure is kept constant at high flow rate ( $Q > Q_{\min}$ ). On/off operation at low flow rate. See the figure below.

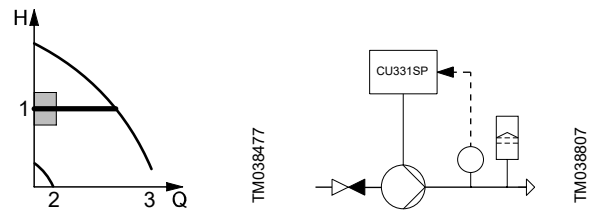

TM038477

TM038807

Constant pressure with stop function

Pos.	Description
1	Hset
2	$Q_{\min}$
3	$Q_{\max}$

The pump is controlled according to a constant pressure measured after the pump. This means that the pump offers a constant pressure in the Q-range of  $Q_{\min}$  to  $Q_{\max}$ , represented by the horizontal line in the QH diagram.

### Setting the setpoint through the "OPERATION" menu

The setpoint can be set or changed during operation using the setpoint display in the "OPERATION" menu shown below. It is not necessary to run the startup guide to change the setpoint.

### Low flow and stop functions

The pump checks the flow regularly by reducing the speed for a short time. If there is no or only a small change in pressure, this means that there is low flow.

The speed is increased until the stop pressure (actual setpoint +  $0.5 \times \Delta H$ ) is reached and the pump stops after a few moments. The pump restarts at the latest when the pressure has fallen to the start pressure (actual setpoint -  $0.5 \times \Delta H$ ).

## Operating conditions for the stop function

It is only possible to use the stop function if the system incorporates a pressure sensor, a check valve and a diaphragm tank.

The check valve must always be installed before the pressure sensor.

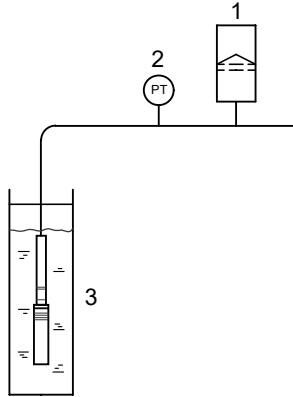

TM055804

Position of the pressure sensor and diaphragm tank

Pos.	Description
1	Diaphragm tank
2	Pressure sensor
3	Pump with non return valve

## Diaphragm tank

The stop function requires a diaphragm tank of a certain minimum size. The tank must be installed as close as possible after the pump and the precharge pressure must be  $0.7 \times$  actual setpoint.

Recommended diaphragm tank size:

Rated flow rate of pump [gpm (m <sup>3</sup> /h)]	Minimum diaphragm tank size [gal (l)]
0-26 (0-6)	2 (8)
27-105 (7-24)	4.4 (18)
106-176 (25-40)	14 (50)
177-308 (41-70)	34 (120)
309-440 (71-100)	62 (180)

If a diaphragm tank of the above size is installed in the system, the factory setting of  $\Delta H$  is the correct setting.

If the tank installed is too small, the pump starts and stops too often.

## Setting the direction of rotation

The startup guide is started the first time SmartFlo is connected to supply voltage. Then while going through the startup guide, SmartFlo tests and sets the correct direction of rotation without changing the cable connections to the motor.

The correct direction of rotation can be set in these ways:

- automatic setting
- manual setting when the direction of rotation is not visible.

### Automatic setting

SmartFlo automatically tests and sets the correct direction of rotation without changing the cable connections.

Automatic setting requires a sensor.

This test is not suitable for all pump types and will in certain cases not be able to determine for certainty the correct direction of rotation. In these cases, SmartFlo changes over to manual setting where the direction of rotation is determined on the basis of the installer's observations.

### Manual setting when the direction of rotation is not visible

The correct direction of rotation is set manually without changing the cable connections. This requires that it is possible to observe the head or flow rate.

### Status functions

SmartFlo shows the following data:

- power consumption
- operating hours
- measured value
- speed
- input power
- motor current.

The status information can be shown in the display.

### Power consumption

The value of the power consumption is an accumulated value calculated from the pump's startup date and cannot be reset. No additional sensor is required.

### Operating hours

The value of operating hours is an accumulated value calculated from the pump's startup date and cannot be reset. No additional sensor is required.

### Measured value

The sensor display shows the actual pressure as received from the pressure transducer.

### Speed

The display shows the motor speed in rpm's (calculated).

### Input power

The display shows the power consumption in kW.

### Motor current

The display shows the actual motor current being used.

### Logging functions

#### Alarm and warning log

The latest five alarms and five warnings are logged with a timestamp corresponding to the power-on time after the fault has occurred. The alarm and warning log can be shown directly on the display.

See section Warning and alarm list.

#### Related information

[Warning and alarm list](#)

### Signal relays

The table shows the function of the signal relays.

Type	Function
Relay 1	Pump running
Relay 2	Alarm

See also the figure below.

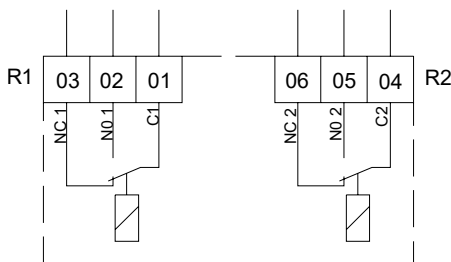

TM038801

Terminals for signal relays (normal state, not activated)

Terminal	Function
C1      C2	Common
NO 1    NO 2	Normally open contact
NC1     NC2	Normally closed contact
R1	Relay 1
R2	Relay2

## SmartFlo installation

### Mechanical installation

The individual SmartFlo cabinet sizes are characterized by their enclosures. The table in section Enclosure shows the relationship of enclosure class and enclosure type.

#### Related information

[Enclosure](#)

### Reception and storage

Check on receipt that the packaging is intact, and the unit is complete. In case of damage during transport, contact the transport company to file a claim.

Note that SmartFlo is delivered in a packaging which is not suitable for outdoor storage.

### Transportation and unpacking

SmartFlo must only be unpacked at the installation site to prevent damage during the transport to the site.

The packaging contains accessory bag(s), documentation and the unit itself. See the figure below.



TM055990

SmartFlo packaging

Pos.	Description
1	Accessory bag

### Space requirements and air circulation

SmartFlo units can be mounted side by side, but these requirements must be met as a sufficient air circulation is required for cooling:

- sufficient free space above and below SmartFlo
- ambient temperature up to 122 °F (50 °C)
- hang SmartFlo directly on the wall, or fit it with a back plate. See the figure below.

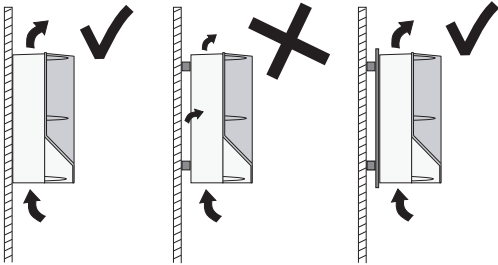

SmartFlo hung directly on the wall or fitted with a back plate

Required free space above and below SmartFlo:

Enclosure	Space [in (mm)]
B1	7.9 (200)

For information about enclosure, see section Enclosure.

### Related information

[Enclosure](#)

### Mounting

SmartFlo must be mounted securely on a firm surface. Ensure that screws are sized appropriately for the weight of SmartFlo (approximately 60 lbs) and anchored securely to the mounting surface.

1. Mark and drill holes. See the figure below; also see section Main dimensions and weight.
2. Fit the screws but leave loose. Mount SmartFlo and tighten the four screws.

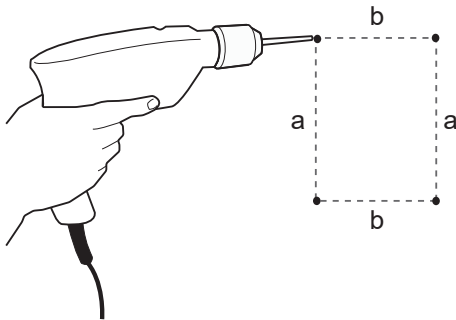

Drilling holes for mounting

### Related information

[Main dimensions and weight](#)

### SmartFlo electrical connection

Ensure the correct grounding and protection procedures are used for the installation. Before the electrical installation, ensure that the power supply and other voltage inputs are switched off.

### Electrical protection

#### Protection against electric shock, indirect contact

The leakage current to ground exceeds 3.5 mA, and a reinforced ground connection is required.

Protective conductors must always have a yellow and green (PE) or yellow and green and blue (PEN) color marking.

Instructions according to EN IEC 61800-5-1:

- SmartFlo must be stationary, installed permanently and connected permanently to the mains supply.
- The ground connection must be carried out with duplicate protective conductors or with a single reinforced protective conductor with a cross-section of minimum AWG 7 (10 mm<sup>2</sup>).

#### Protection against short-circuit, fuses

SmartFlo and the supply system must be protected against short-circuit.

Grundfos requires that the backup fuses are used for protection against short-circuit.

SmartFlo offers complete short-circuit protection in case of a short-circuit on the motor output.

#### Additional protection

The leakage current to ground exceeds 3.5 mA.

During startup and in asymmetrical supply systems, the leakage current can be higher than normal and may cause the GFCI to trip.

If the SmartFlo is connected to an electrical installation where an earth leakage circuit breaker (ELCB) is used as additional protection, the circuit breaker must be of a type marked with the following symbols:



#### Circuit breaker type B

The total leakage current of all the electrical equipment in the installation must be taken into account.

During start and in asymmetrical supply systems, the leakage current can be higher than normal and may cause the ELCB to trip.

TM038859

TM079803

TM038860

## Motor protection

The motor requires no external motor protection. SmartFlo protects the motor against thermal overloading and blocking.

## Protection against overcurrent

SmartFlo has an internal overcurrent protection for overload protection on the motor output.

## Protection against mains voltage transients

SmartFlo is protected against mains voltage transients.

## Mains and motor connection

The supply voltage and frequency are marked on the SmartFlo nameplate. Make sure that SmartFlo is suitable for the power supply of the installation site.

The maximum output voltage of SmartFlo is equal to the input.

Example: if the supply voltage is rated at 208V choose a 208V motor for operation.

## Main switch

A main switch can be installed before SmartFlo according to local regulations. See fig. SmartFlo wiring diagram.

## Related information

[Wiring diagram](#)

## Wiring diagram

The wires in the terminal box must be as short as possible. Exempted from this is the ground wire, which must be so long that it is the last one to be disconnected in case the cable is inadvertently pulled out of the cable entry.

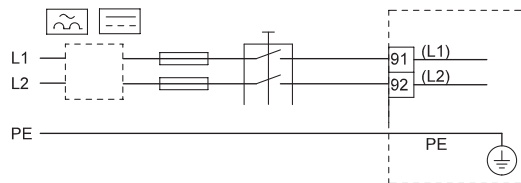

TM055867

SmartFlo wiring diagram

Terminal	Function
91 (L1)	Single-phase supply
92 (L2)	
95/99 (PE)	Ground connection

For single-phase connection, use L1 and L2.

## Mains connection

Check that mains voltage and frequency correspond to the values on the nameplate of SmartFlo and the motor.

1. Connect the ground wire to terminal 95 (PE). See the figure below.
2. Connect the power leads to the terminals 91 (L1), 92 (L2).
3. Fix the mains cable with a cable clamp.

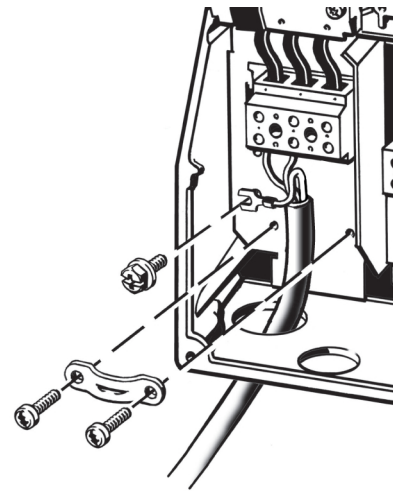

TM039019

## Mains connection

SmartFlo drive is usable with three-phase input power by connecting leads to 91 (L1), 92 (L2), and 93 (L3).

## Motor connection

The motor cable must be screened for SmartFlo to meet EMC requirements.

1. Connect the ground wire to terminal 99 (PE). See the figure below.
2. Connect the motor leads to the terminals 96 (U), 97 (V), 98 (W).
3. Fix the screened cable with a cable clamp.

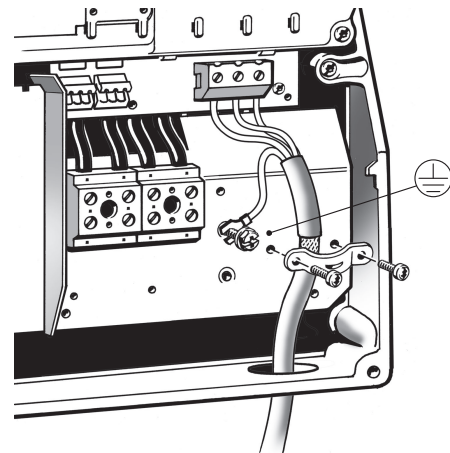

TM039020

## Motor connection

The cable screen must be exposed and in physical contact with the mounting plate and clamp.

### Connecting the signal terminals

As a precaution, signal cables must be separated from other groups by reinforced insulation in their entire lengths. If no external on/off switch is connected, short-circuit terminals 18 and 20 using a short wire.

Connect the signal cables according to the guidelines for good practice to ensure EMC-correct installation. See section EMC-correct installation.

- Use screened signal cables with a conductor cross-section of minimum AWG 20 (0.5 mm<sup>2</sup>) and maximum AWG 16 (1.5 mm<sup>2</sup>).
- Use a 3-conductor screened bus cable in new systems.

#### Related information

[EMC-correct installation](#)

#### Minimum connection, signal terminal

Operation is only possible when the terminals 18 and 20 are connected, for instance by an external on/off switch or a short wire.

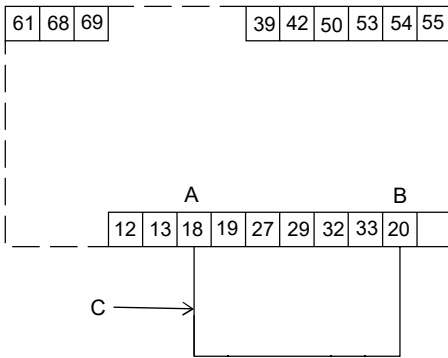

TM039057

Required minimum connection, signal terminal

Pos.	Description
A	Start/stop
B	GND
C	Jumper wire

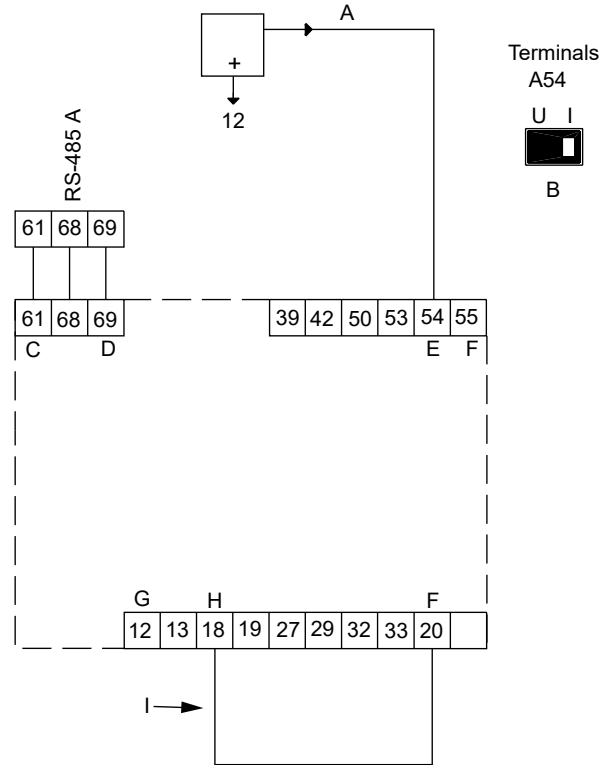

TM055802

Wiring diagram for SmartFlo

Pos.	Description
A	Jumper wire
B	Switch position must be changed to "I" prior to startup
C	RS-485 GND Y
D	RS-485 B
E	Sensor 1
F	GND
G	+24 V out
H	Start/Stop
I	Jumper wire

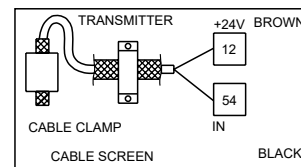

TM056776

Sensor wiring diagram



### Setting the analog input 54

The contact A54 is positioned behind the control panel and is used for setting the signal type of the analog input. The factory setting of the inputs is voltage signal "U". This setting must be changed to "I" prior to starting SmartFlo. Be sure the power supply is switched off. Remove the control panel to set the contact. See the figure below.

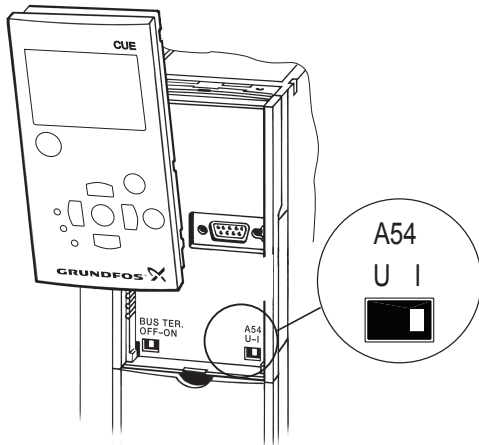

TM055803

Setting contact A54 to current signal "I"

### Terminal key

Terminal	Type	Function
12	+24 V out	Supply to sensor
18	DI 1	Digital input, start/stop
20	GND	Common frame for digital inputs
55	GND	Common frame for analog inputs
54	AI 2	Sensor input, sensor 1, 0/4-20 mA
61	RS-485 GND Y	GENIbus, frame
68	RS-485 A	GENIbus, signal A (+)
69	RS-485 B	GENIbus, signal B (-)

The RS-485 screen must be connected to frame.

### Access to signal terminals

All signal terminals are behind the terminal cover of SmartFlo front. Remove the terminal cover as shown in the figure below.

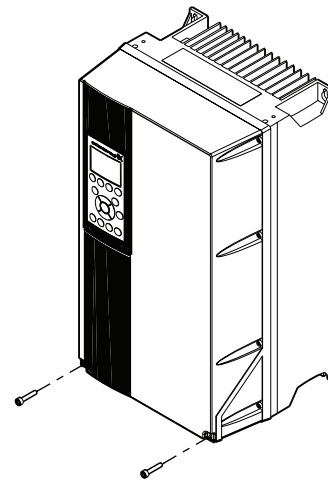

TM039004

Access to signal terminals

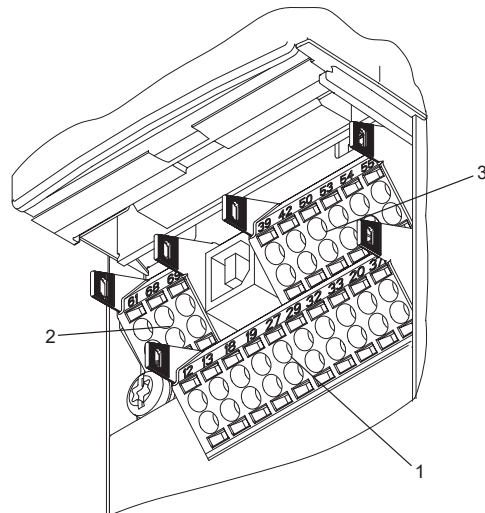

TM039025

Signal terminals

### Fitting the conductor

1. Remove the insulation at a length of 0.35 to 0.40 inches (9 to 10 mm).
2. Insert a screwdriver with a tip of maximum 0.015 × 0.1 in (0.4 × 2.5 mm) into the square hole.
3. Insert the conductor into the corresponding round hole. Remove the screwdriver. The conductor is now fixed in the terminal.

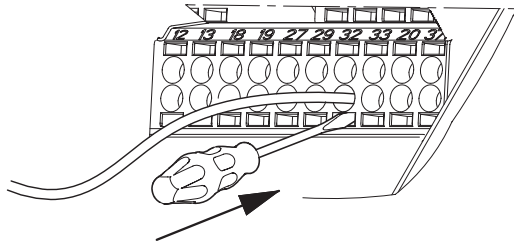

Fitting the conductor into the signal terminal

TM039026

### Connecting the signal relays

As a precaution, signal cables must be separated from other groups by reinforced insulation in their entire lengths.

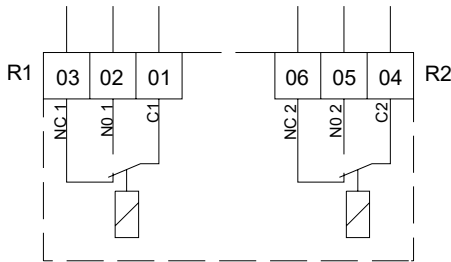

TM038801

Terminals for signal relays (normal state, not activated)

Terminal	Function
C 1    C 2	Common
NO 1    NO 2	Normally open contact
NC 1    NC 2	Normally closed contact
R1	Relay 1
R2	Relay 2

### Signal relay

The signal relays on SmartFlo are predefined as follows:

- Relay 1: Pump running
- Relay 2: Alarm

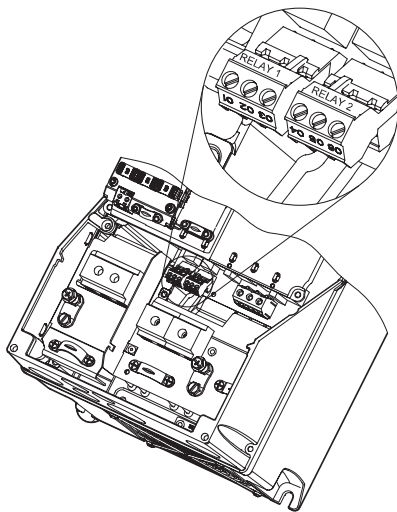

Terminals for relay connection

TM039008

### EMC-correct installation

This section gives guidelines for good practice when installing SmartFlo. Follow these guidelines to meet EN 61800-3, first environment.

- Use only motor and signal cables with a braided metal screen in applications without output filter.
- There are no special requirements to supply cables, apart from local requirements.
- Leave the screen as close to the connecting terminals as possible. See fig. Example of stripped cable with screen.
- Avoid terminating the screen by twisting the ends. See fig. Do not twist the screen ends. Use cable clamps or EMC screwed cable entries instead.
- Connect the screen to frame at both ends for both motor and signal cables. If the controller has no cable clamps, connect only the screen to SmartFlo.
- Avoid unscreened motor and signal cables in electrical cabinets with variable frequency drives.
- Make the motor cable as short as possible in applications without output filter to limit the noise level and minimize leakage currents.
- Screws for frame connections must always be tightened whether a cable is connected or not.
- Keep main cables, motor cables and signal cables separated in the installation, if possible.

Other installation methods may give similar EMC results if the above guidelines for good practice are followed.

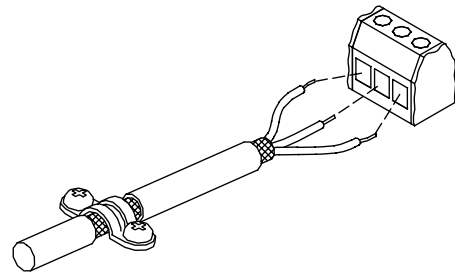

Example of stripped cable with screen

TM021325

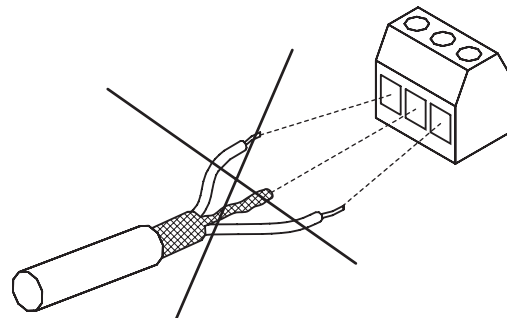

Do not twist the screen ends

TM038812

### Line disturbance and transient protection

To protect itself from AC line voltage disturbances, SmartFlo monitors the input power supply and interrupts drive operation in the event of phase loss or imbalance. Transients on the AC line are suppressed by MOVs as well as zener diodes for extreme transients. SmartFlo meets VDE 0160 (European standard - 2.3 × line voltage for 1.3 msec) for transient protection.

### RFI filters

To meet the EMC requirements, SmartFlo comes with the following types of built-in radio frequency interference filter (RFI).

Voltage	Typical shaft power P2	RFI filter type
1 × 200-240 V <sup>9)</sup>	1.5 - 10 hp	C1

<sup>9)</sup> Single-phase input - three-phase output

### Description of RFI filter types

C1: For use in domestic areas.

RFI filter types are according to EN61800-3.

### Control panel

The on/off button on the control panel does not disconnect SmartFlo from the power supply and must therefore not be used as a safety switch.



The On/Off button has the highest priority. In "Off" condition, pump operation is not possible.

The control panel is used for local setting of SmartFlo. The functions available are preset in SmartFlo.

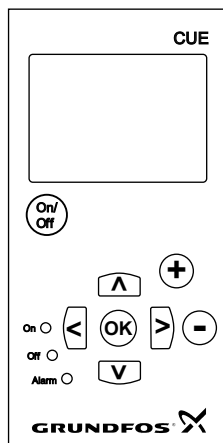

TM038719

Control panel of SmartFlo

### Editing buttons

Button	Function
	This button starts and stops the pump and makes it ready for operation.
	This button saves changed values, resets alarms and expands the value field.
	These buttons change values in the value field.

### Navigating buttons

Button	Function
	These buttons navigate from one menu to another. When the menu is changed, the display shown always the top display of the new menu.
	These buttons navigate up and down in the individual menu.

### Adjusting the display contrast

Press OK and + for darker display.  
Press OK and - for brighter display.

### Button lock

To lock the buttons on the panel press and hold the up and down arrows simultaneously.

### Indicator lights

The operating condition of the pump is indicated by the indicator lights on the front of the control panel. See fig. Control panel of SmartFlo.

The table shows the function of the indicator lights.

Indicator light	Function
<b>On (green)</b>	The pump is running or has been stopped by a stop function. If flashing, the pump has been stopped by the user (SmartFlo menu), external start/stop or bus.
<b>Off (orange)</b>	The pump has been stopped with the on/off button.
<b>Alarm (red)</b>	Indicates an alarm or a warning.

### Related information

[Control panel](#)

### Displays, general terms

Figures Example of display in the startup guide and Example of display in the user menu show the general terms of the display.

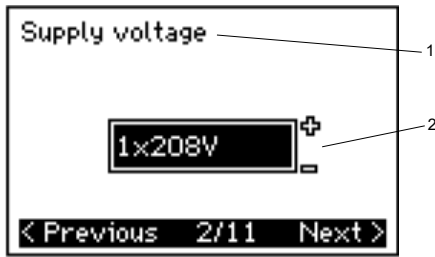

TM080016

Example of display in the startup guide

Pos.	Description
1	Display name
2	Current display / total number
3	Value field

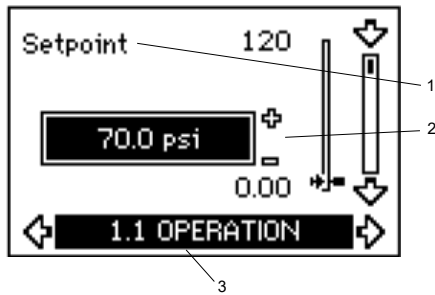

TM080017

Example of display in the user menu

Pos.	Description
1	Display name
2	Display number, menu name
3	Value field

### Warning and alarm list

Code and display text	Status			Operating mode	Resetting
	Warning	Alarm	Locked alarm		
1 Too high leakage current			•	Stop	Man.
2 Mains phase failure		•		Stop	Aut.
3 External fault		•		Stop	Man.
16 Other fault		•		Stop	Aut.
			•	Stop	Man.
32 Overvoltage	•			-	Aut.
		•		Stop	Aut.
40 Undervoltage	•			-	Aut.
		•		Stop	Aut.
48 Overload		•		Stop	Aut.
			•	Stop	Man.
49 Overload		•		Stop	Aut.
	•			-	Aut.
55 Overload		•		Stop	Aut.
57 Dry running		•		Stop	Aut.
64 Too high SmartFlo temperature		•		Stop	Aut.
89 Sensor 1 outside range		•		10)	Aut.
96 Setpoint signal outside range		•		10)	Aut.
155 Inrush fault		•		Stop	Aut.
	•			-	Aut.
241 Motor phase failure		•		Stop	Aut.

<sup>10)</sup> In case of an alarm, SmartFlo changes the operating mode depending on the pump type. Warning is reset in display 3.20.

## SmartFlo technical data

### Enclosure

All SmartFlo enclosures are size B1.

The enclosure rating can be either IP 55 / TYPE 12 or IP 66 / TYPE 4X.

### Main dimensions and weight

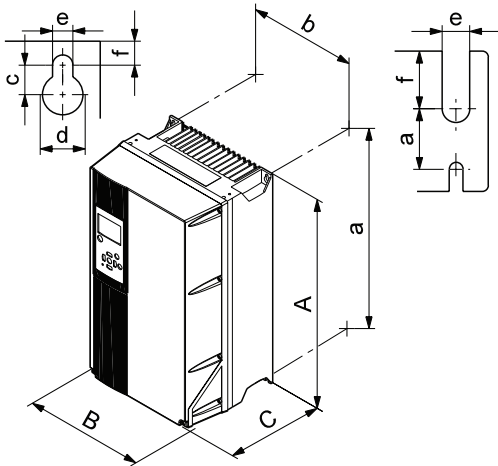

TM039002

Enclosure B1

**Note:** The dimensions shown for SmartFlo enclosures are maximum height, width and depth.

Enclosure	Height [in]		Width [in]		Depth [in]
	A	a	B	b	
B1	18.9	17.9	9.5	8.3	10.2
	Screw holes [in]				Weight [lbs]
	c	d	e	f	
	0.47	0.75	0.35	0.35	50.7

### Surroundings

Relative humidity	5-95 % RH
Ambient temperature	Max. 122 °F (50 °C)
Average ambient temperature over 24 hours	Max. 113 °F (45 °C)
Minimum ambient temperature at full operation	32 °F (0 °C)
Minimum ambient temperature at reduced operation	14 °F (-10 °C)
Temperature during storage and transportation	-13 to 150 °F (-25 to 65 °C)
Storage duration	Max. 6 months
Maximum altitude above sea level without performance reduction	3280 ft (1000 m)
Maximum altitude above sea level with performance reduction	9840 ft (3000 m)

SmartFlo comes in a packaging which is not suitable for outdoor storage.

### Terminal tightening torques

Enclosure	Tightening torque [ft-lb]			
	Mains	Motor	Earth	Relay
B1	1.3	1.3	2.2	0.4

### Cable length

Maximum length, screened motor cable	500 ft (152 m)
Maximum length, unscreened motor cable	1000 ft (305 m)
Maximum length, signal cable	1000 ft (305 m)

### Fuses and cable cross-section

Always comply with national and local regulations as to cable cross-sections.

#### Cable cross-section to signal terminals

Maximum cable cross-section to signal terminals, rigid conductor	AWG 14
Maximum cable cross-section to signal terminals, flexible conductor	AWG 18
Minimum cable cross-section to signal terminals	AWG 20

#### Non-UL fuses and conductor cross-section to mains and motor

Typical shaft power P2 [Hp]	Maximum fuse size [A]	Fuse type	Maximum conductor cross section <sup>1)</sup>	
			[AWG]	[mm <sup>2</sup> ]
2	40	gG	7	10
3	40	gG	7	10
5	80	gG	7	10

<sup>1)</sup> Screened motor cable, unscreened supply cable.

## UL fuses and conductor cross-section to mains and motor

Typical shaft power P2 [Hp]	Maximum fuse size [A]	Bussmann RK1	Maximum conductor cross section <sup>12)</sup> [AWG]
2	40	KTN-R40	7
3	40	KTN-R40	7
5	80	KTN-R80	7

<sup>12)</sup> Screened motor cable, unshielded supply cable.

## Inputs and outputs

### Mains supply (L1, L2)

Supply voltage	200-240 V ± 10 %
Supply frequency	60 Hz
Maximum temporary imbalance between phases	3 % of rated value
Leakage current to earth	> 3.5 mA
Number of cut-ins	Max. 1 time/min.

Do not use the power supply for switching SmartFlo on and off.

### Motor output (U, V, W)

Output voltage	0-100 % <sup>13)</sup>
Output frequency	0-60 Hz
Switching on output	Not recommended

<sup>13)</sup> Output voltage in % of supply voltage.

### RS-485 GENibus connection

Terminal number	68 (A), 69 (B), 61 GND (Y)
-----------------	----------------------------

The RS-485 circuit is functionally separated from other central circuits and galvanically separated from the supply voltage (PELV).

### Digital inputs

Terminal number	18
Voltage level	0-24 VDC
Voltage level, open contact	> 19 VDC
Voltage level, closed contact	< 14 VDC
Maximum voltage on input	28 VDC
Input resistance, R <sub>i</sub>	Approx. 4 kΩ

All digital inputs are galvanically separated from the supply voltage (PELV) and other high-voltage terminals.

## Signal relays

Relay 01, terminal number	1 (C), 2 (NO), 3 (NC)
Relay 02, terminal number	4 (C), 5 (NO), 6 (NC)
Maximum terminal load (AC-1) <sup>14)</sup>	240 VAC, 2 A
Maximum terminal load (AC-15) <sup>14)</sup>	240 VAC, 0.2 A
Maximum terminal load (DC-1) <sup>14)</sup>	50 VDC, 1 A
Minimum terminal load	24 V DC 10 mA 24 V AC 20 mA

<sup>14)</sup> IEC 60947, parts 4 and 5.

C	Common
NO	Normally open
NC	Normally closed

The relay contacts are galvanically separated from other circuits by reinforced insulation (PELV).

### Analog input

Terminal number	54
Current signal	A54 = "I" <sup>15)</sup>
Current range	0-20, 4-20 mA
Input resistance, R <sub>i</sub>	Approx. 200 Ω
Maximum current	30 mA
Maximum fault, terminals 53, 54	0.5 % of full scale

<sup>15)</sup> The factory setting is voltage signal "U".

All analog inputs are galvanically separated from the supply voltage (PELV) and other high-voltage terminals.

### Sound pressure level

The sound pressure of SmartFlo is maximum 70 dB(A).

The sound pressure level of a motor controlled by a variable frequency drive may be higher than that of a corresponding motor which is not controlled by a variable frequency drive.

SmartFlo curve charts  
SmartFlo, 2 Hp

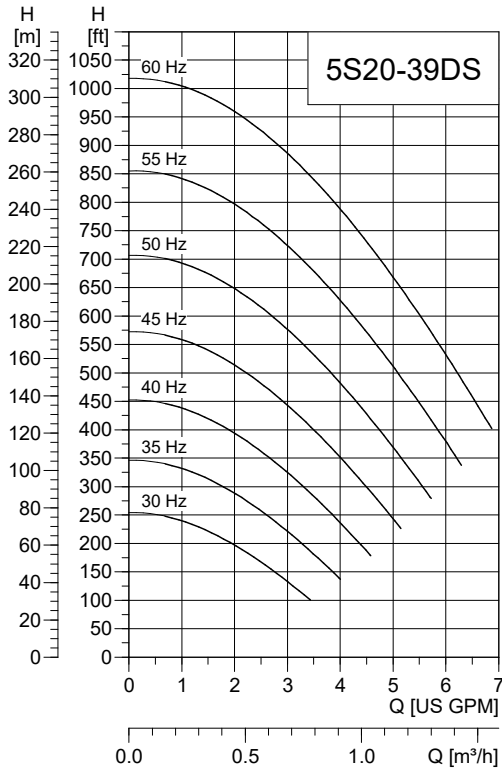

TM056410

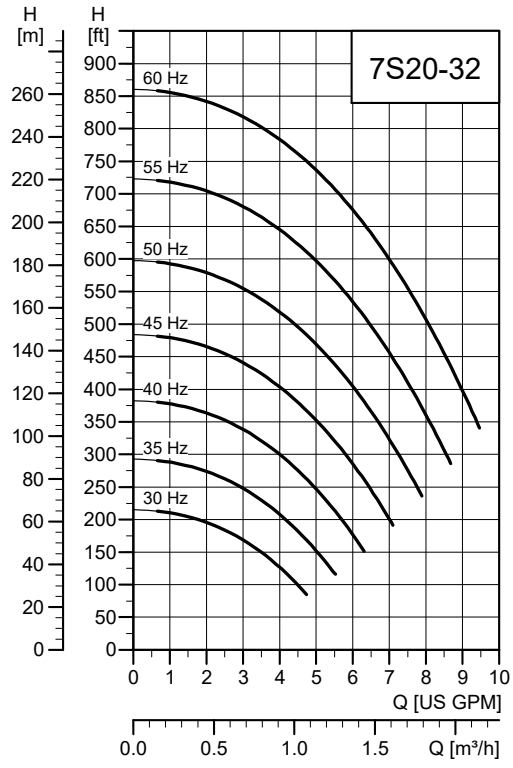

TM056411

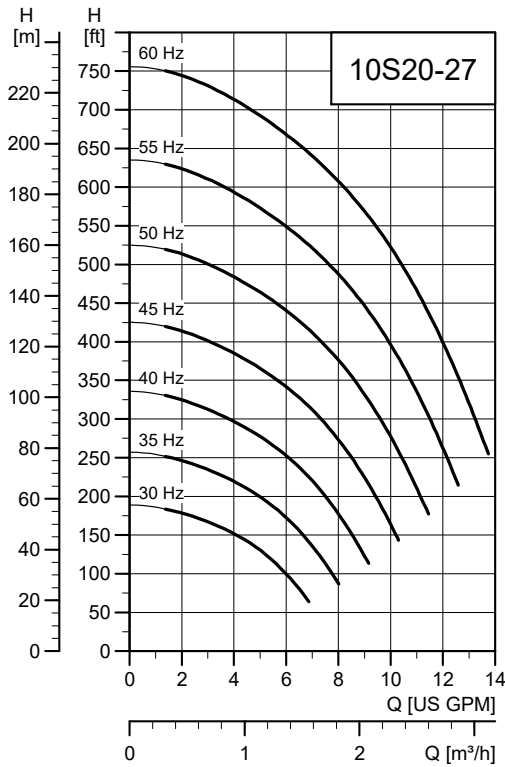

TM056412

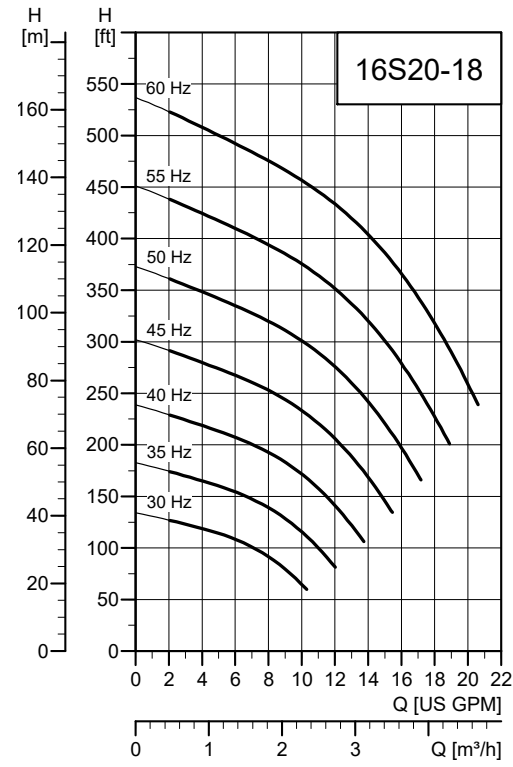

TM056413

SmartFlo, 2 Hp, continued

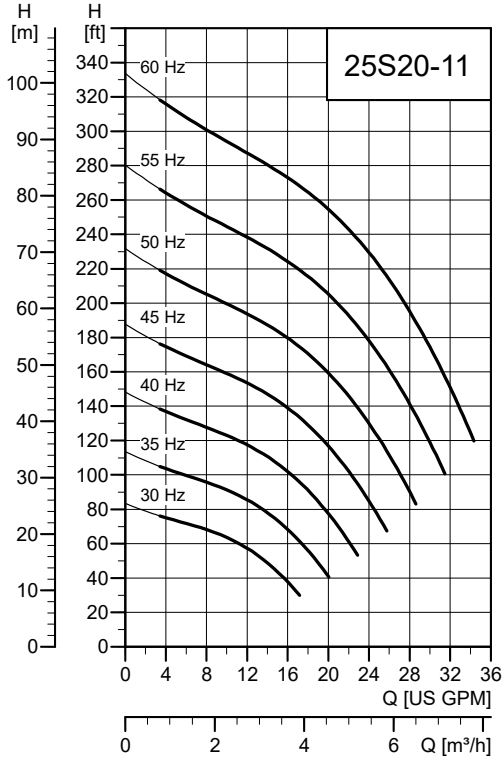

TM066414

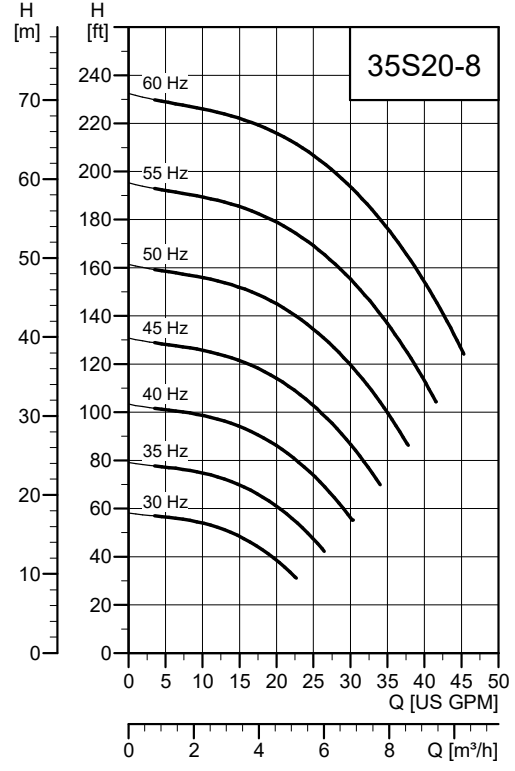

TM069747

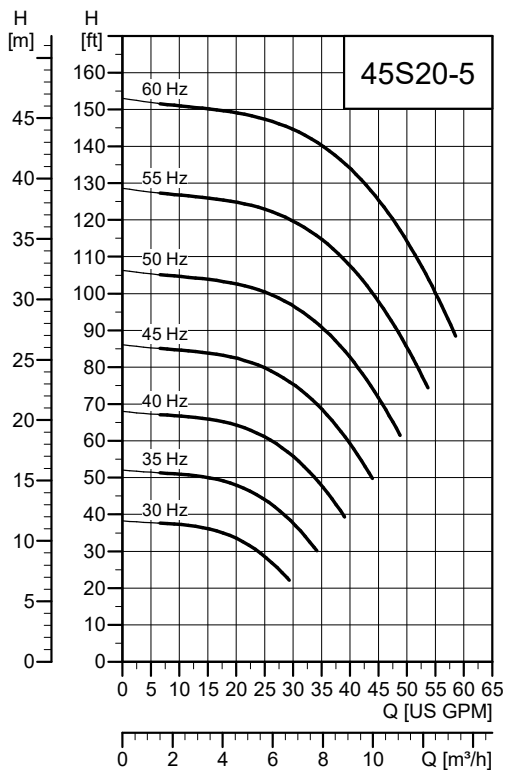

TM069751

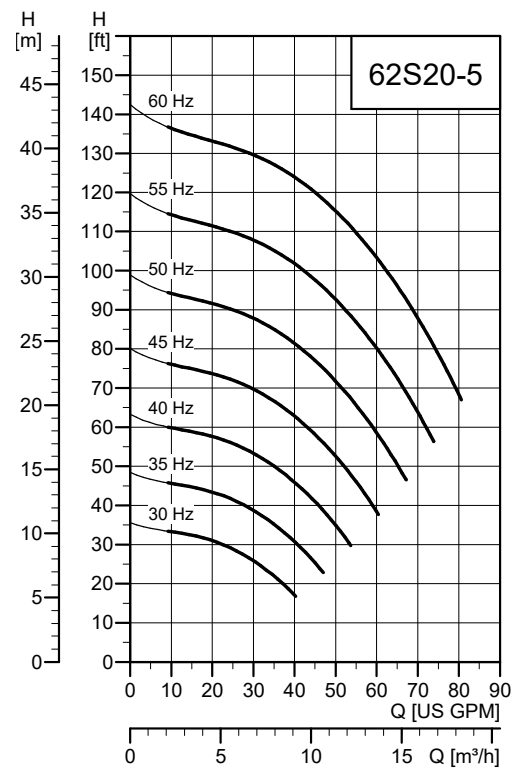

TM069759



SmartFlo, 2 Hp, continued

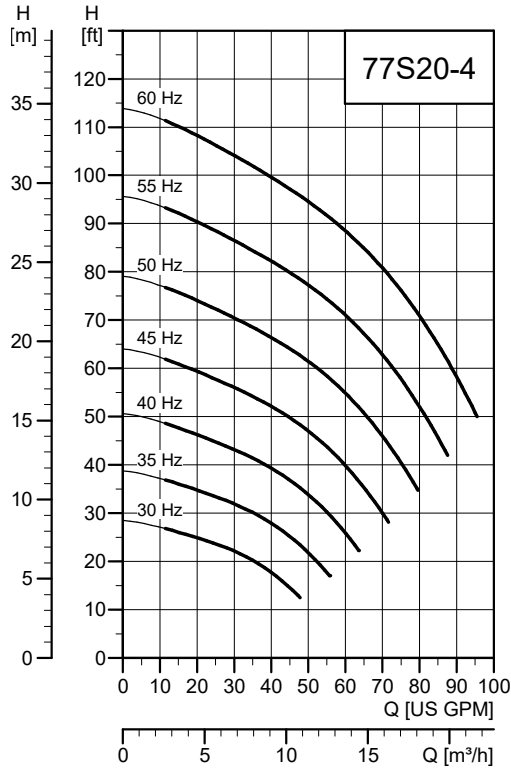

TM069755

SmartFlo, 3 Hp

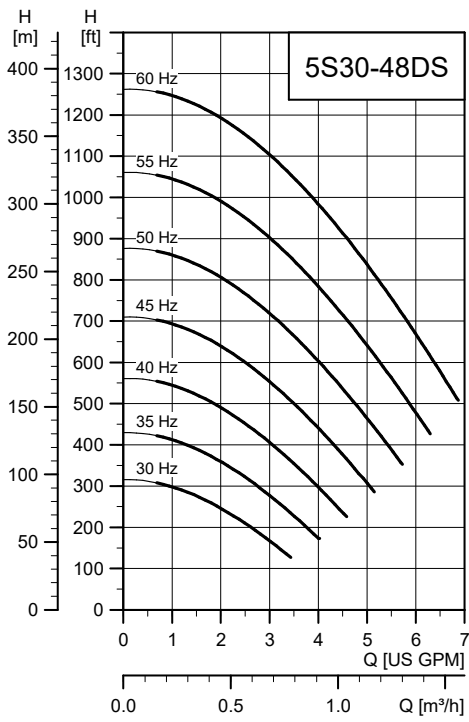

TM056418

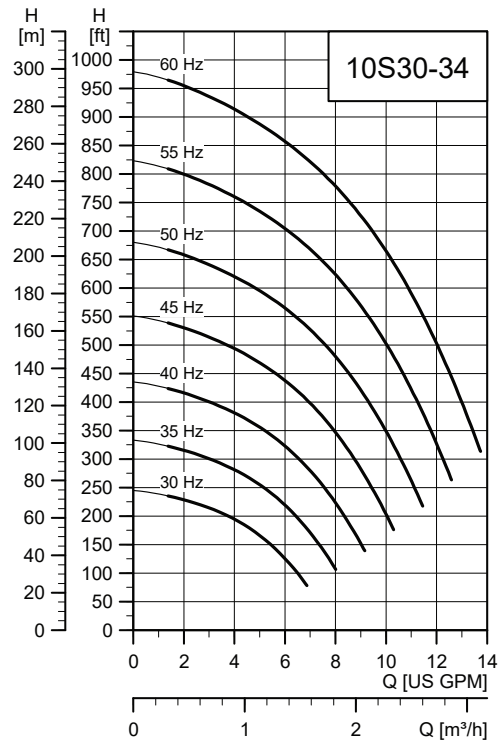

TM056419

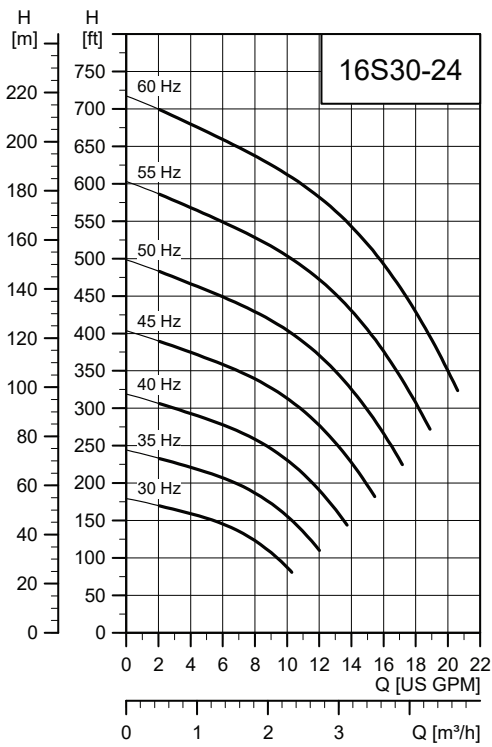

TM056420

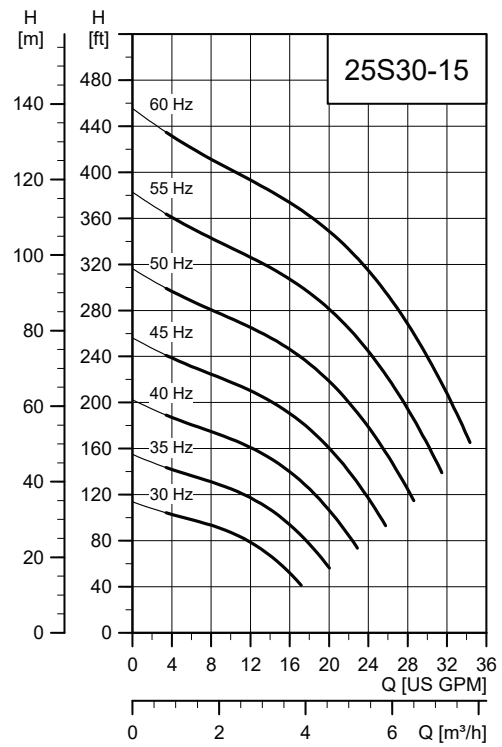

TM056421

SmartFlo, 3 Hp, continued

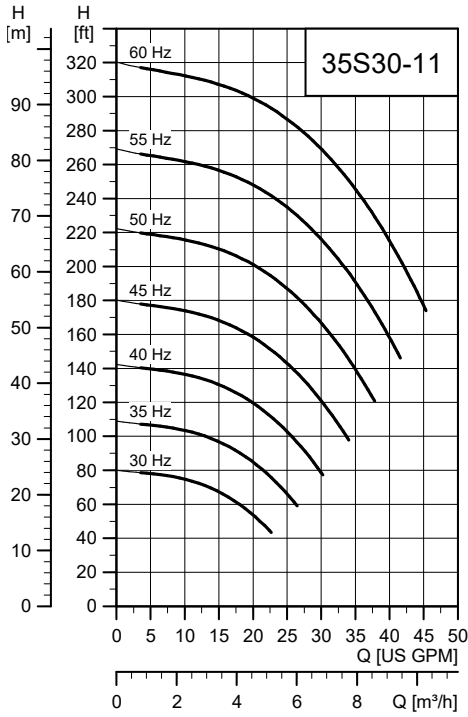

TM069748

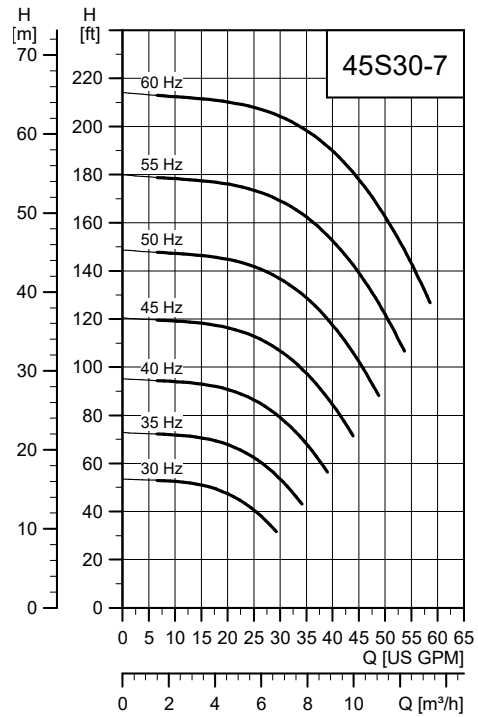

TM069752

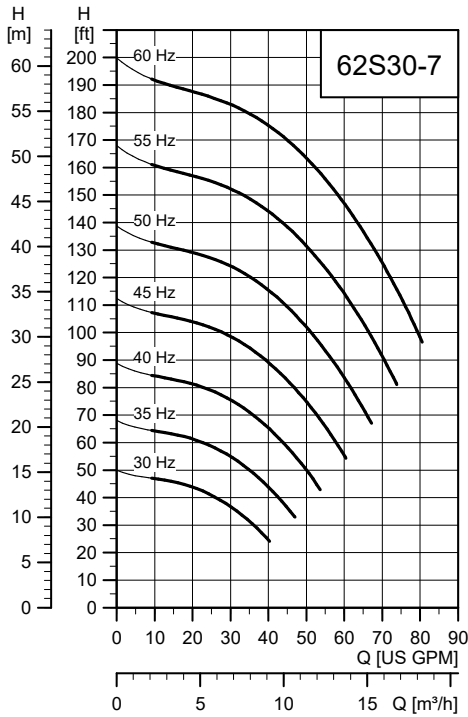

TM069760

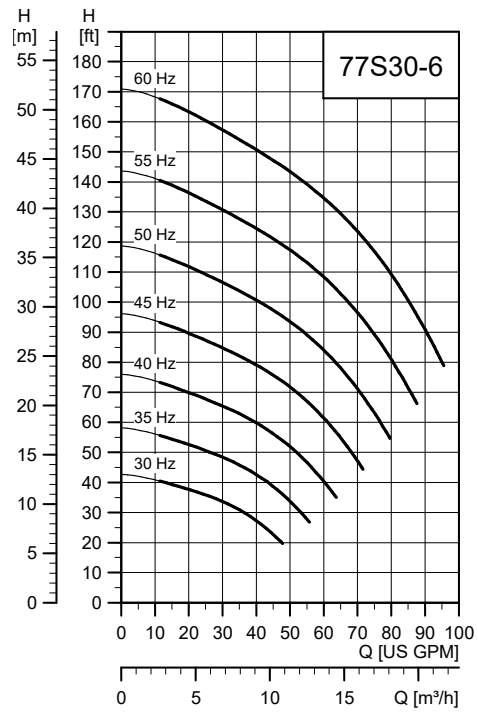

TM069756

SmartFlo, 5 Hp

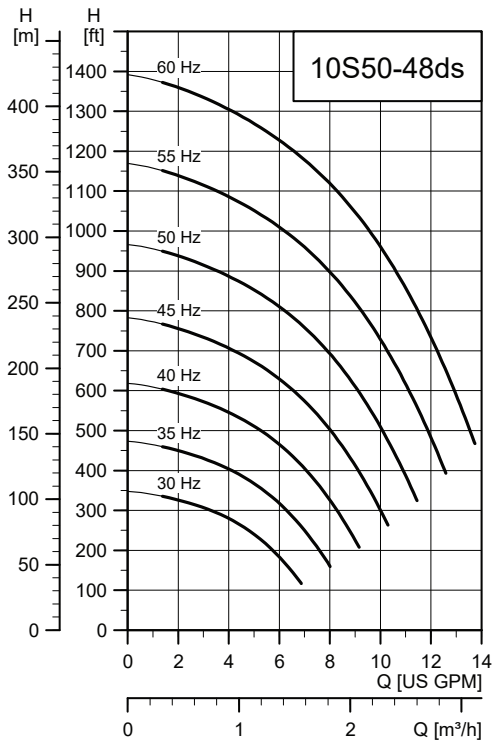

TM056425

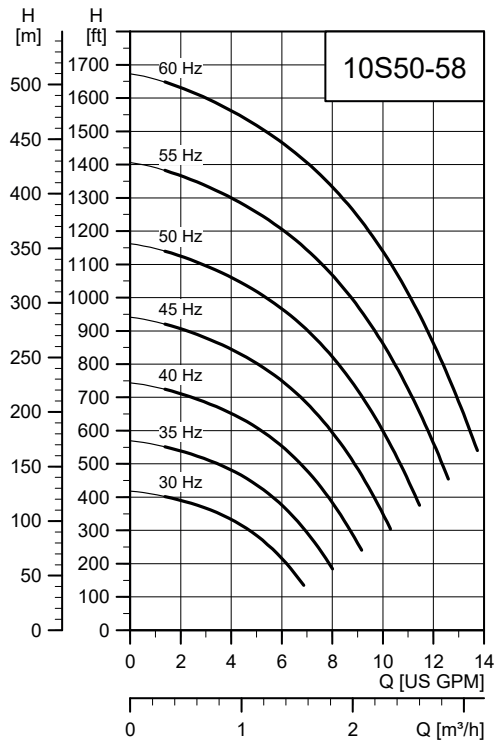

TM056426

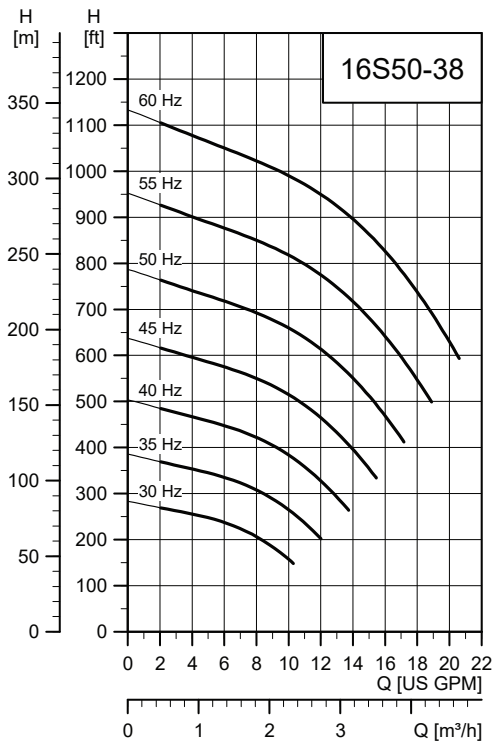

TM056427

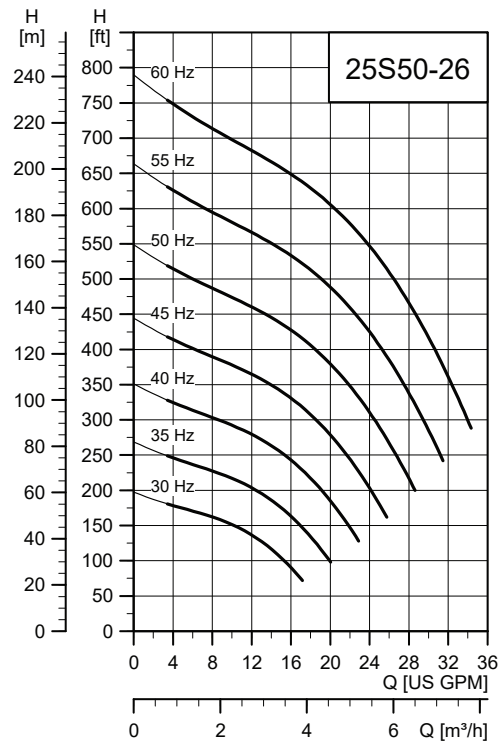

TM056428

SmartFlo, 5 Hp, continued

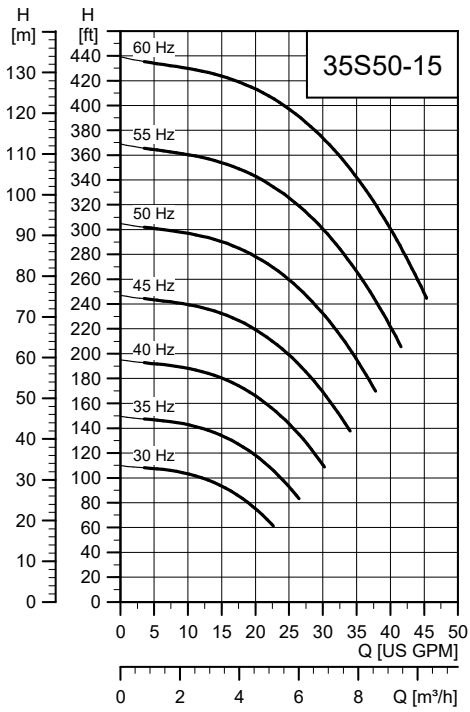

TM069749

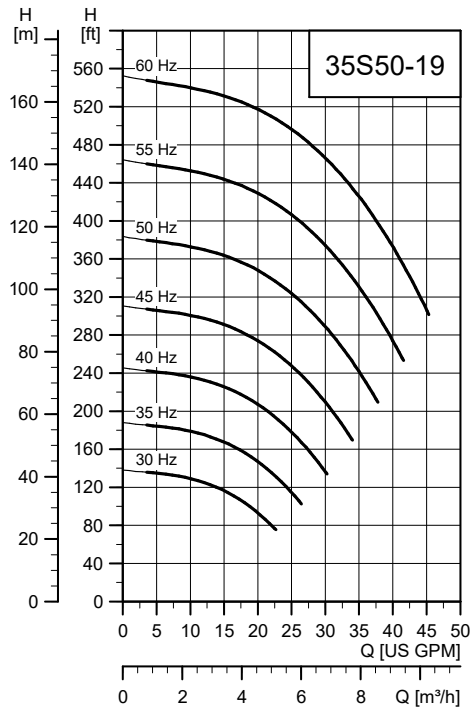

TM069750

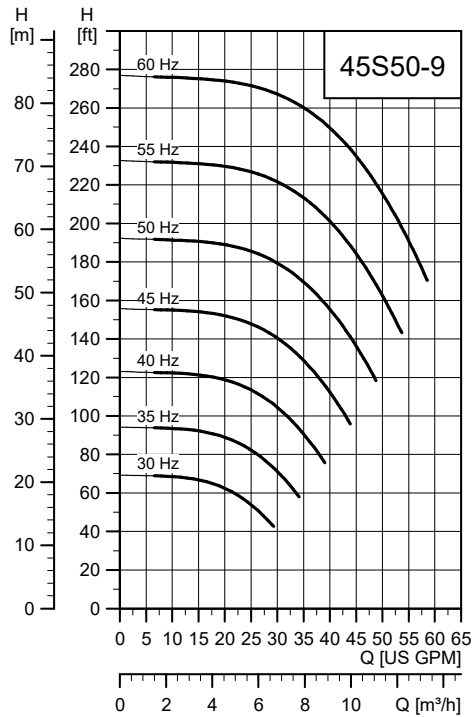

TM069753

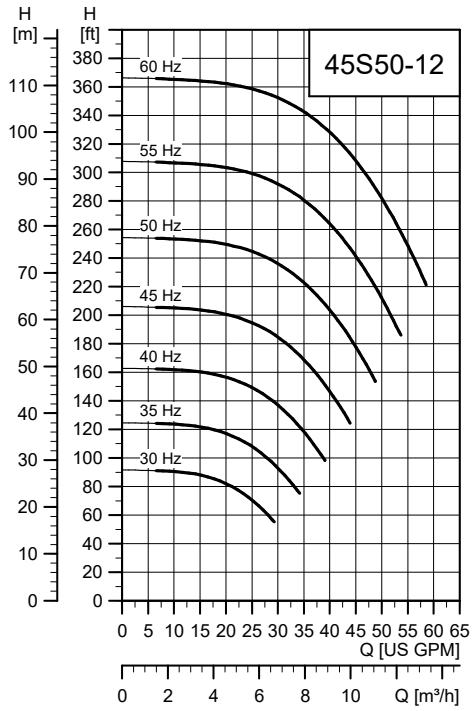

TM069754

SmartFlo, 5 Hp, continued

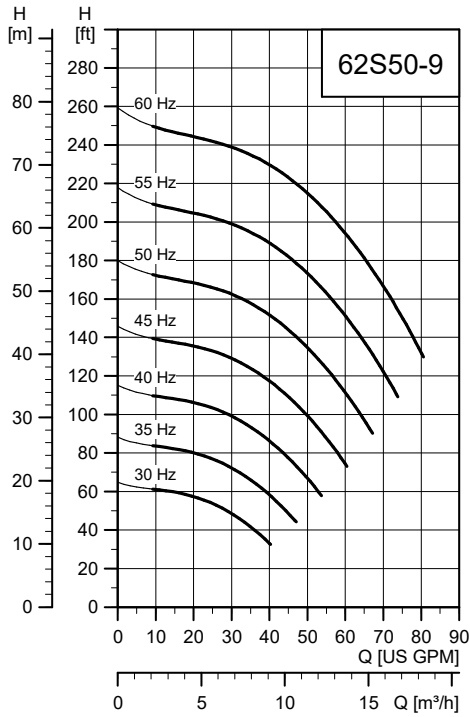

TM069761

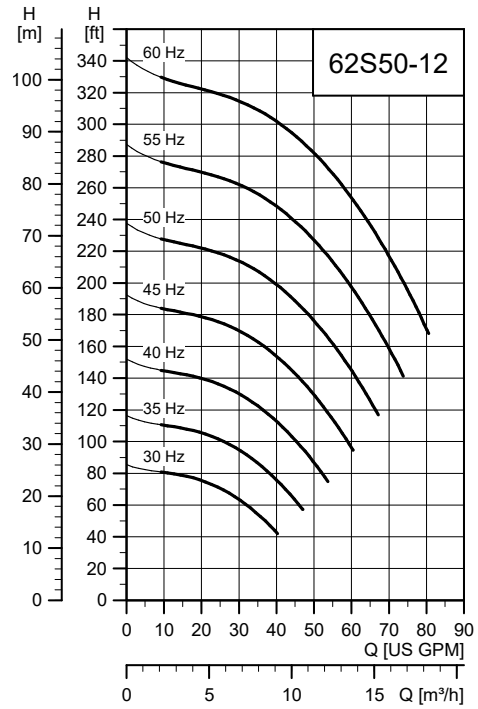

TM069762

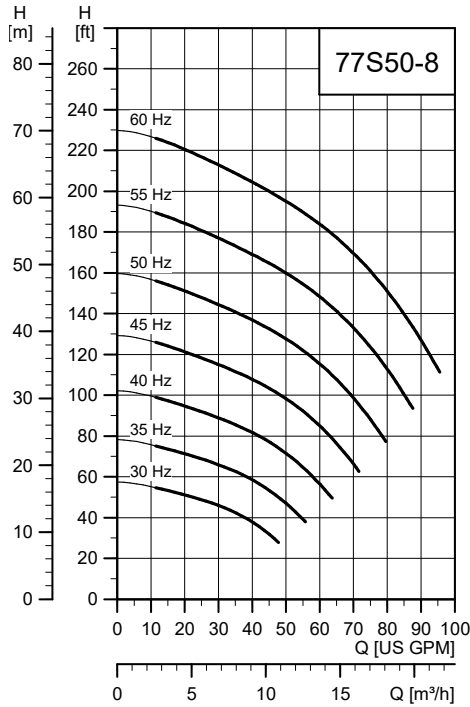

TM069757

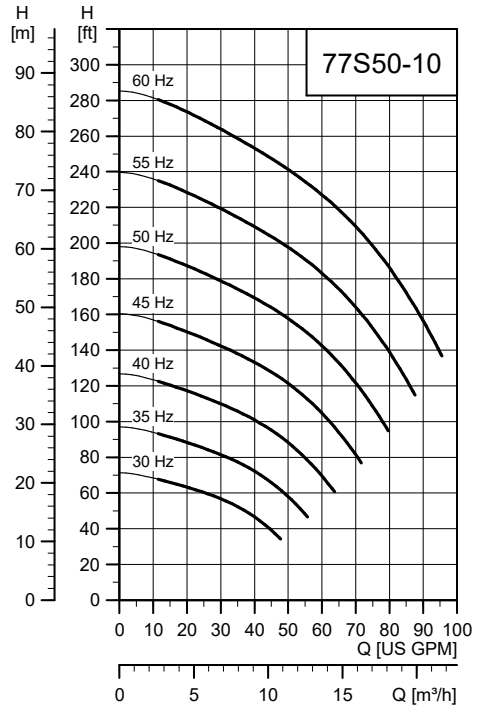

TM069758

## CUE variable frequency drive



GRA4404

### The CUE range

Grundfos CUE is a series of external variable frequency drive designed for speed control of a wide range of Grundfos pumps.

CUE offers quick and easy setup and commissioning compared to a standard variable frequency drive because of the startup guide. Simply key in application-specific variables such as motor data, pump family, control function (for example constant pressure), sensor type and setpoint, and CUE automatically sets all necessary parameters.

CUE enables gentle pumping and thereby protects the water reservoir and the rest of the distribution system, as water hammer can be avoided by adjusting ramp times up and down.

When a CUE is installed, the motor requires no further overload protection. Pt100/1000 together with the MCB 114 provides overload protection of the motor windings, if needed.

**Note:** If the motor has a built-in Tempcon sensor, this sensor is disconnected when it is exposed to the variable frequency drive. An internal fuse in the motor blows and it cannot be replaced. The motor works without the sensor, but it is not possible to restore the functionality of the Tempcon sensor.

CUE is available in two enclosure classes:

- Nema 1 (IP20/21)
- Nema 12 (IP54/55).

### RFI filters

To meet the EMC requirements, CUE comes with the following types of built-in radio frequency interference filter (RFI).

### Functions

CUE has a wide range of pump-specific functions, such as the following:

- constant pressure
- constant level
- constant flow rate
- constant temperature
- constant curve.

### Features

- Startup guide CUE incorporates an innovative startup guide for the general setting of CUE including the setting of the correct direction of rotation. The startup guide is started the first time CUE is connected to the power supply.
- check of direction of rotation
- duty/standby operation
- dry-running protection
- low-flow stop function.

### Accessories

Grundfos offers various accessories for CUE.

#### MCB 114 sensor input module

MCB 114 offers additional analog inputs for CUE:

- 1 analog input, 0/4-20 mA
- 2 inputs for Pt100/Pt1000 temperature sensors.

#### Output filters

Output filters are used primarily to protect the motor against overvoltage and increased operating temperature. However, output filters can also be used to reduce acoustic noise from the motor.

Grundfos offers sine-wave filters as an CUE accessory.

#### Sensors

The following sensors can be used in connection with CUE. All sensors are with 4-20 mA output signal.

- Pressure sensors, up to 362 psi (25 bar)
- temperature sensors
- differential-pressure sensors
- differential-temperature sensors
- flowmeters
- potentiometer box for external setpoint setting.

### Installation

#### Use of output filters

The table below shows in which cases an output filter is required and which type to use.

The selection depends on these factors:

- pump type
- motor cable length
- the required reduction of acoustic noise from the motor.

Pump type	Typical shaft power, P2	Sine-wave filter
SP with 380 V motor and up	All sizes	0-984 ft (0-300 m)

The lengths stated apply to the motor cable.

#### Cables used in CUE installations

**Note:** When CUE is installed in connection with SP pumps, we distinguish between two types of installation:

- installation in EMC-insensitive sites. See the figure below.
- installation in EMC-sensitive sites. See the figure below.

The two types of installation are different when it comes to the use of screened cable.

**Note:** Drop cables are always unscreened.

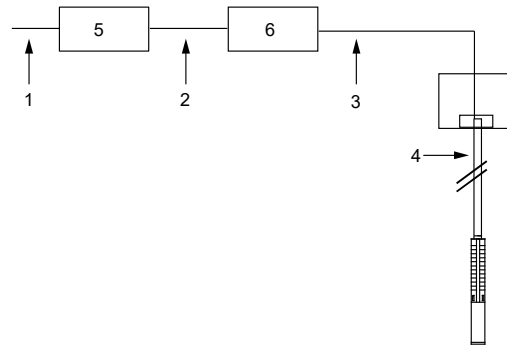

TM085636

Example of installation in EMC-insensitive sites

Pos.	Description
1	Mains cable, unscreened
2	Screened cable
3	Screened cable
4	Drop cable, unscreened
5	CUE
6	Sine-wave filter

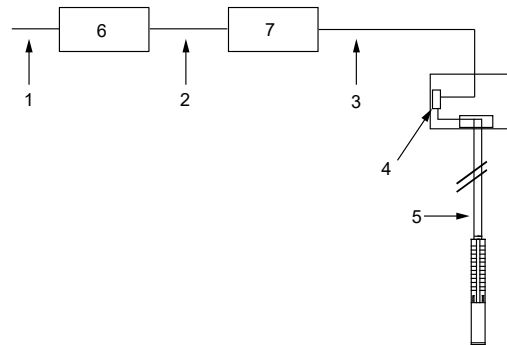

TM085638

Example of installation in EMC-sensitive sites

Pos.	Description
1	Mains cable, unscreened
2	Screened cable
3	Screened cable
4	Connection box
5	Drop cable, unscreened
6	CUE
7	Sine-wave filter

Screened cables are required in those parts of the installation where the surroundings must be protected against EMC.

CUE is the right choice of variable frequency drive in SP installations as it meets all basic issues.

CUE has a pre-installed startup guide which takes the installer through all the necessary settings.

For more information about the CUE variable frequency drive, see the CUE Data booklet, part number 9886424 or visit Grundfos Product Center at [www.grundfos.us](http://www.grundfos.us).



## MP 204

MP 204 is an electronic motor protector, designed for the protection of an asynchronous motor or a pump.

The motor protector consists of:

- a cabinet incorporating transformers and electronics
- a control panel with operating buttons and display for reading of data.

MP 204 operates with two sets of limits:

- a set of warning limits and
- a set of trip limits.

If one or more of the warning limits are exceeded, the motor continues to run, but the warnings appear in the MP 204 display.

Some values only have a warning limit.

The warning can also be read out from Grundfos GO.

If one of the trip limits is exceeded, the trip relay stops the motor. At the same time, the signal relay is operating to indicate that the limit has been exceeded.

### Example

MP 204 can be used as a stand-alone motor protector.

MP 204 can be monitored through Grundfos GENibus.

The power supply to MP 204 is in parallel with the supply to the motor. Motor currents up to 120 A are passed directly through MP 204. MP 204 protects the motor primarily by measuring the motor current with a true RMS measurement. MP 204 disconnects the contactor if, for example, the current exceeds the preset value.

Secondarily, the motor is protected through temperature measuring by a Tempcon sensor, a Pt100/Pt1000 sensor and a PTC sensor/thermal switch.

MP 204 is designed for single- and three-phase motors. In single-phase motors, the starting and run capacitors are also measured.  $\cos \varphi$  is measured in both single- and three-phase systems.

### Benefits

MP 204 offers these benefits:

- Suitable for both single- and three-phase motors
- dry-running protection
- overload protection
- very high accuracy
- made for submersible pumps.

## Several monitoring options

MP 204 monitors the following parameters:

- Insulation resistance before startup
- temperature (Tempcon, Pt sensor and PTC/thermal switch)
- overload and underload
- overvoltage and undervoltage
- phase sequence
- phase failure
- power factor
- power consumption
- harmonic distortion
- operating hours and number of starts.



TM031471

MP 204

Five sizes of single-turn transformers, 120-999 A.

**Note:** Monitoring of motor temperature with Tempcon sensor is not possible when single-turn transformers are used.

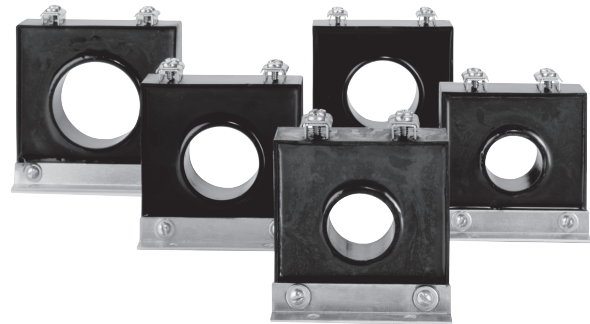

TM032033

Single-turn transformers

## Product numbers

Product	Product number
MP 204	96079927
Single-turn transformers	
Current transformer ratio: 200:5, $I_{max.} = 120$ A	96095274
Current transformer ratio: 300:5, $I_{max.} = 300$ A	96095275
Current transformer ratio: 500:5, $I_{max.} = 500$ A	96095276
Current transformer ratio: 750:5, $I_{max.} = 750$ A	96095277
Current transformer ratio: 1000:5, $I_{max.} = 1000$ A	96095278

## Functions

- Phase-sequence monitoring
- indication of current or temperature (user selection)
- indication of temperature in °F or °C (user selection)
- 4-digit, 7-segment display
- setting and status reading with Grundfos GO
- setting and status reading via GENIbus.

## Tripping conditions

- Overload
- underload (dry running)
- temperature (Tempcon sensor, PTC/thermal switch and Pt sensor)
- phase failure
- phase sequence
- overvoltage
- undervoltage
- power factor ( $\cos \varphi$ )
- current unbalance.

## Warnings

- Overload
- underload
- temperature (Tempcon and Pt sensor)
- overvoltage
- undervoltage
- power factor ( $\cos \varphi$ ) **Note:** In connection with single- and three-phase connection
- run capacitor (single-phase operation)
- starting capacitor (single-phase operation)
- loss of communication in network
- harmonic distortion.

## Learning function

- Phase sequence (three-phase operation)
- run capacitor (single-phase operation)
- starting capacitor (single-phase operation)
- identification and measurement of Pt100/Pt1000 sensor circuit.

## External current transformers

When fitted with external current transformers, the MP 204 unit can handle currents from 120 to 999 A. Grundfos can supply approved current transformers from stock (200/5A, 300/5A, 500/5A, 750/5A, 1000/5A).

## Grundfos GO

Grundfos GO allows for wireless infrared remote control of your MP 204 unit.

With Grundfos GO, you get access to a full range of options such as factory setting adjustment, service and fault finding.

## Ready for bus communication

MP 204 allows for monitoring and communication through GENIbus, a Grundfos-designed bus for exchange of pump data, alarms, status information, and setpoints. This enables users to connect MP 204 to, for instance, SCADA systems.

## Technical data - MP 204

Enclosure class	IP20
Ambient temperature	-4 °F to +140 °F (-20 °C to +60 °C)
Relative humidity	99 %
Voltage range	100-480 VAC
Current range	3-999 A
Frequency	50 to 60 Hz
IEC trip class	1-45
Special Grundfos trip class	0.1 to 30 s
Voltage variation	- 25 % / +15 % of nominal voltage
Approvals	EN 60947, EN 60335, UL/CSA 508
Marking	CE, cUL, C-tick
Consumption	Maximum 5 W
Plastic type	Black PC / ABS

	Measuring range	Accuracy	Resolution
Current without external current transformers	3-120 A	± 1 %	0.1 A
Current with external current transformers	120-999 A	± 1 %	1 A
Phase-to-phase voltage	80-610 VAC	± 1 %	1 V
Frequency	47-63 Hz	± 1 %	0.5 Hz
Power	0-1 MW	± 2 %	1 W
Power factor	0 - 0.99	± 2 %	0.01
Energy consumption	0-4 × 10 <sup>9</sup> kWh	± 5 %	1 kWh

This table describes the protection provided by MP 204.

Control parameters	Function	Problem	Advantages
Temperature	<b>MS</b> The motor temperature is measured by the built-in Tempcon temperature transmitter and a signal is sent to MP 204 through the phase leads. In MP 204, the measured temperature is compared with the factory-set value of 167 °F (75 °C).	Overload, frequent starts/stops, operation against blocked outlet pipe, insufficient flow velocity past the motor	Longer motor life, safe operating conditions, service indication
	<b>MMS</b> The motor temperature is measured by Pt100/Pt1000. The signal is sent to MP 204 where the measured temperature is compared with the factory-set value. Temperature protection requires a submersible motor with a Pt100/Pt1000. The motor temperature must be monitored during variable frequency drive operation.		
Overvoltage/undervoltage	If the set trip value is exceeded, the motor stops.	The installation is close to a transformer. The mains do not absorb load variations.	Important installation parameter, possibility of improving operating conditions
Overload	The motor power input is measured on each of the three phases. The registered power input is an average of these three values. If the factory-set value is exceeded, the motor stops.	Incorrect sizing of pump/motor, voltage supply failure, defective cable, blocking, wear or corrosion	Longer pump life, safe operating conditions, service indication
Underload (dry running)	The motor power input is measured on each of the three phases. The registered power input is an average of these three values. If the average value is lower than the factory-set value, the motor stops.	Pump exposed to dry running or underload, for example caused by wear	Traditional dry-running protection is no longer necessary, no extra cables
Current unbalance	The power input of the motor is measured on each of the three phases.	Mains load is uneven, incipient motor defect, phase voltages diverging.	Motor protection against overload, service indication
Phase sequence	MP 204 and motor are installed so that the phase sequence corresponds to correct direction of rotation. MP 204 monitors changes in the phase sequence.	Two phases are wrongly connected.	Ensures correct pump performance
Phase failure	MP 204 checks the phases connected, phase failure causes an alarm.	Phase failure	Indication of phase failure, and alarm

## Grundfos GO remote app

The Grundfos GO remote app offers easy access to the setting options, status information, control and fault finding of the MP 204 in your Android or iOS-based device.

### MI 301

The Grundfos MI 301 mobile interface is required to connect the MP 204 with you Android or iOS-based device via a Bluetooth connection. The MI 301 has rechargeable Li-ion battery and must be charged separately. Currently Grundfos supports Android devices using Android 5.0 and later and Apple devices using iOS 6.1.2 and later, but cannot guarantee operation on all devices in the market.



TM053890

### MI 301

The following are supplied with the product:

- Grundfos MI 301
- For PN 98046408, a charger is included; P/N 98761178 is without charger.

- Sleeve
- Quick guide.

## Connecting pieces

The tables below show the range of connecting pieces for connection of thread-to-flange and thread-to-thread.

### Thread-to-thread

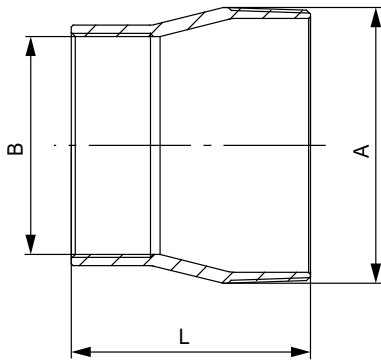

TM012397



GRA2555

Dimensional sketch and photo of connecting piece thread-to-thread

Type	Connecting piece	Dimensions			Product number	
		Thread-to-thread		L [in (mm)]	304 stainless steel	316 stainless steel
		A	B			
385S	NPT 5 → NPT 4	NPT 5	NPT 4	4.76 (121)	190064	190586
475S	NPT 5 → NPT 6	NPT 5	NPT 6	5.91 (150)	190070	190592
625S	NPT 6 → NPT 5	NPT 6	NPT 5	5.91 (150)	200135	200645
800S						
1100S						

## Zinc anodes

### Application

Cathodic protection by zinc can be used for corrosion protection of SP pumps in chloride-containing liquids, such as brackish water and seawater.

Sacrificial anodes are placed on the outside of the pump and motor as protection against corrosion. See the figure below.

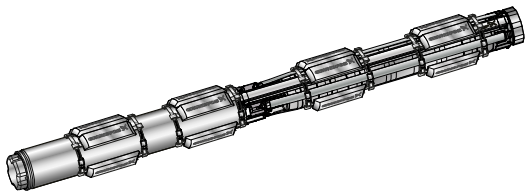

TM078808

Submersible motor fitted with anode strings

More information about zinc anode and product numbers are available in **SP accessories data booklet**.

## SA-SPM 6 control boxes

### Application

SA-SPM 6 control boxes are used as starting units for single-phase, 3-wire motors ranging from 0.5 Hp to 5 Hp (.37 kW to 3.7 kW).

SA-SPM 6 from 1.5 Hp to 5 Hp (1.1 kW to 3.7 kW) is available in two versions, Standard (STD) and Deluxe (DLX).

The standard version incorporates a motor-protective circuit breaker and thus protects the motor against overload.

The deluxe version is identical to the standard version with the addition of a motor contactor for connection and disconnection of the power supply.

### Example

Technical data	
Enclosure class	IP42
Ambient temperature	-4 °F to +140 °F (-20 °C to +60 °C)
Relative humidity	Maximum 95 %, normal non-aggressive atmosphere



TM038150

SA-SPM 6 control box

### SA-SPM 6 control box part numbers

Control box for 4-inch, 3-wire, single phase motors						
Type	Hp	Volts	Approximate ship wt (lb)	Product number (Order in multiples of 1)	Product number (Order in multiples of 10)	Reference product number only <sup>16)</sup>
STD	1/2 <sup>17)</sup>	115	2	-	98821580	98315240
STD	1/2 <sup>17)</sup>	230	2	-	98821631	98315251
STD	3/4 <sup>17)</sup>	230	2	-	98821632	98315252
STD	1 <sup>17)</sup>	230	2	-	98821633	98315253
STD	1-1/2	230	2	98315254	-	-
DLX	1-1/2	230	3	98315255	-	-
STD	2	230	6	98315256	-	-
DLX	2	230	6	98315257	-	-
STD	3	230	6	98315258	-	-
DLX	3	230	7	99053534	-	-
STD	5	230	7	98315260	-	-
DLX	5	230	8	99053535	-	-
DLX	7	230	14	99053536	-	-
DLX	10	230	15	99053537	-	-
DLX	15	230	17	99053538	-	-

<sup>16)</sup> Old control box material numbers that Grundfos sold in single units.

<sup>17)</sup> The 1/2 hp, 3/4 hp and 1 hp control boxes are now sold by Grundfos in multiple quantities (10-pack) only.

DLX (Deluxe Control Box): Includes magnetic starter in addition to Standard Control Box (STD).

## Pt100/Pt1000

The Pt100/Pt1000 sensor offers these features:

- Continuous monitoring of the motor temperature
- protection against too high motor temperature.

Protecting the motor against too high motor temperature is the simplest and cheapest way of avoiding that motor lifetime is reduced. Pt100/Pt1000 ensures that the operating conditions are not exceeded and indicates when it is time for service of the motor.

Monitoring and protection by means of Pt100/Pt1000 require the following parts:

- Pt100/Pt1000 sensor
- relay, type PR 5714
- cable.

The PR 5714 relay is fitted with a Pt100/Pt1000 module. For both relays the following temperature limits are preset on delivery:

- 140 °F (60 °C) warning limit
- 167 °F (75 °C) stop limit.

**Example**

	<b>Relay type</b>
	<b>PR 5714</b>
Enclosure class	IP65 (mounted in a control panel)
Ambient temperature	-4 °F to +140 °F (-20 °C to +60 °C)
Relative humidity	95 % (condensating)
Voltage variation	1 × 24-230 VAC ± 10 %, 50-60 Hz 24-250 VDC ± 20 %
Approvals	UL, DNV
Mark	CE

PR 5714 relay	Voltage	Product number
	24-230 VAC, 50/60 Hz / 24-250 VDC	96621274





GRA3186

PR 5714 relay	Voltage	Product number
	24-230 VAC, 50/60 Hz / 24-250 VDC	96913234

GRA3186

Pt100 sensor, including cable for standard-, N- and R-versions	Cable length [ft (m)]	
	65.6 (20)	For product number, see Grundfos Price Book or call Grundfos.
	131.2 (40)	
	196.9 (60)	
	262.5 (80)	
	100 (328.1)	

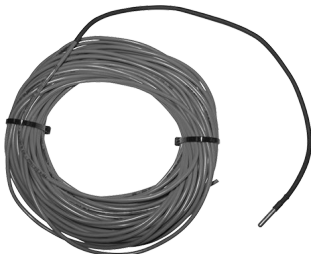
GRA3190

Staybolt kits for Pt100 in MS 6000	Description
	<p>Staybolt kit for Pt100/Pt1000 Material: AISI 316 (EN 1.4401)</p> <p>For product number, see Grundfos Price Book or call Grundfos.</p>
	<p>GRA3191</p> <p>Staybolt kit for Pt100 Material: AISI 904L (EN 1.4539)</p>
Insertion probe for MMS 10000	Description
	<p>Insertion probe for Pt100/Pt1000 in MMS10000 Material: 316 (EN 1.4401) (N-version)</p> <p>For product number, see Grundfos Price Book or call Grundfos.</p> <p>Insertion probe for Pt100/Pt1000 in MMS10000 Material: AISI 904L (EN 1.4539) (R-version)</p>
	<p>TM043560</p> <p>TM043563</p>
Pt1000 sensor, including cable	Cable length [ft (m)]
	<p>65.6 (20)</p> <p>131.2 (40)</p> <p>196.9 (60)</p> <p>262.5 (80)</p> <p>100 (328.1)</p>
	<p>For product number, see Grundfos Price Book or call Grundfos.</p>
	<p>TM043563</p>
Staybolt kits for Pt1000 in MS 402 and MS 400C	Description
	<p>Staybolt kit for Pt1000 Material: AISI 316 (EN 1.4401)</p> <p>For product number, see Grundfos Price Book or call Grundfos.</p> <p>Staybolt kit for Pt1000 Material: AISI 904 (EN 1.4539)</p>
	<p>TM053694</p>



## 10. Energy consumption

### Energy consumption of submersible pumps

The percentage distribution of service life costs of a submersible pump for water supply is:

- 5 % initial costs (pump)
- 85 % operating energy costs
- 10 % maintenance costs.

The highest savings can be achieved within energy consumption.

The annual energy consumption, E, of a submersible pump can be calculated as follows:

$$E = c \times h \times P_1 \text{ (USD)}$$

c = specific energy price (USD/kWh)

h = operating hours/year (hours)

P<sub>1</sub> = power input of the submersible pump (Hp).

**Example:** Calculation of the annual energy consumption of the submersible pump, type 625S-3.

625S-3 with MMS8000, 60 Hp, 3 × 460 V, 60 Hz

#### Duty point:

Flow rate:	Q = 528 gpm
Total head:	H = 335 ft
Specific energy price:	c = USD 0.15/kWh (consisting of day and night rate)
Operating hours/year:	h = 3200

$$P_1 = \frac{Q \times H \times \rho}{367 \times \eta_{\text{pump}} \times \eta_{\text{motor}}} \text{ in kW}$$

Q	= gpm
H	= ft
Density ρ	= lb/ft <sup>3</sup> (assumed 1)
367	= conversion factor
η <sub>motor</sub>	= (example 84.5 %, in equation 0.845)
η <sub>pump</sub>	= (not to be confused with the stage efficiency curve)

By showing the P<sub>2</sub>/Q curve, it is easier to calculate the energy consumption.

$$P_1 = \frac{P_2}{\eta_{\text{motor}}}$$

P<sub>2</sub> = 35 Hp (power requirement of 625S-3 pump at 88 gpm, from curve P<sub>2</sub>/Q).

#### Calculation of motor efficiency at duty point

As standard, the SP 625S-3 is equipped with a 60 Hp (45 kW for P<sub>1</sub>) MS 6000C motor.

At duty point (Q = 528 gpm) the pump requires 59 Hp (44 kW for P<sub>1</sub>), thus:

a motor load of 87 % (44 kw / 45 kw) and a power reserve of 2 %.

From table SP 35S (35 gpm) pump power requirement (P<sub>2</sub>) the motor efficiency can be read as:

84.6 % at a load of 75 %. (η<sub>75</sub> %)

85.6 % at a load of 100 %. (η<sub>100</sub> %)

The interpolated value in this example is

$$\eta_{\text{motor}} = 85.1 \%, \eta_{\text{motor}} = 0.851.$$

$$P_1 = \frac{44}{0.851} = 51.7 \text{ kW}$$

$$E = 0.15 \text{ USD/kWh} \times 3200 \text{ h} \times 51.7 \text{ kW}$$

The annual energy costs amount to USD 24816.

The pay-off time, A, (months) is calculated as follows:

$$A = \frac{\text{Purchase price of energy - efficiency pump}}{\text{Energy savings / year}} \times 12$$

#### Cable sizing

To obtain an economical duty of the pump the voltage drop must be low.

Large water works already size cables for a maximum voltage drop of 1 %.

The hydraulic resistance in the outlet pipe must be as low as possible.

# 11. Cables

## Cable sizing charts

### 115 V and 230 V, 1 ph 60 Hz

		Maximum submersible power cable length (maximum cable length in feet - starter to motor)															
Motor rating [Hp]	[Hp]	AWG copper wire size										MCM copper wire size					
		[ft (m)]										250	300	350			
		14	12	10	8	6	4	3	2	1	0	00	000	0000	250	300	350
115 V 1 ph 60 Hz	.33	130 (40)	210 (64)	340 (104)	540 (165)	840 (256)	1300 (396)	1610 (491)	1960 (597)	2390 (728)	2910 (887)	3540 (1079)	4210 (1283)	5060 (1542)	5680 (1731)	6390 (1948)	7110 (2167)
	.5	100 (30)	160 (49)	250 (76)	390 (119)	620 (189)	960 (293)	1190 (363)	1460 (445)	1780 (543)	2160 (658)	2630 (802)	3140 (957)	3770 (1149)	4240 (1292)	4770 (1454)	5320 (1622)
230 V 1 ph 60 Hz	.33	550 (168)	880 (268)	1390 (424)	2190 (668)	3400 (1036)	5250 (1600)	6520 (1987)	7960 (2426)	9690 (2954)	11770 (3587)	14320 (4365)	17050 (5197)	20460 (6236)	22980 (7004)	25850 (7879)	28750 (8763)
	.5	400 (122)	650 (198)	1020 (311)	1610 (491)	2510 (765)	3880 (1183)	4810 (1466)	5880 (1792)	7170 (2185)	8720 (2658)	10620 (3237)	12660 (3859)	15210 (4636)	17100 (5212)	19260 (5870)	21440 (6535)
	.75	300 (91)	480 (146)	760 (232)	1200 (366)	1870 (570)	2890 (881)	3580 (1091)	4370 (1332)	5330 (1625)	6470 (1972)	7870 (2399)	9380 (2859)	11250 (3429)	12640 (3853)	14220 (4334)	15810 (4819)
	1	250 (76)	400 (122)	630 (192)	990 (302)	1540 (469)	2380 (725)	2960 (902)	3610 (1100)	4410 (1344)	5360 (1634)	6520 (1987)	7780 (2371)	9350 (2850)	10510 (3203)	11840 (3609)	13180 (4017)
	1.5	190 (58)	310 (94)	480 (146)	770 (235)	1200 (366)	1870 (570)	2320 (707)	2850 (869)	3500 (1067)	4280 (1305)	5240 (1597)	6300 (1920)	7620 (2323)	8630 (2630)	9810 (2990)	10980 (3347)
	2	150 (46)	250 (76)	390 (119)	620 (189)	970 (296)	1530 (466)	1910 (582)	2360 (719)	2930 (893)	3620 (1103)	4480 (1366)	5470 (1667)	6700 (2042)	770 (235)	8890 (2710)	10080 (3072)
	3	120 (37)	190 (58)	300 (91)	470 (143)	750 (229)	1190 (363)	1490 (454)	1850 (564)	2320 (707)	2890 (881)	3610 (1100)	4470 (1362)	5550 (1692)	6450 (1966)	7580 (2310)	8690 (2649)
	5	-	110 <sup>18)</sup> (34 <sup>18)</sup> )	180 (55)	280 (85)	450 (137)	710 (216)	890 (271)	1110 (338)	1390 (424)	1740 (530)	2170 (661)	2680 (817)	3330 (1015)	3870 (1180)	4550 (1387)	5210 (1588)
	7.5	-	-	120 <sup>18)</sup> (37 <sup>18)</sup> )	200 (61)	310 (94)	490 (149)	610 (186)	750 (229)	930 (283)	1140 (347)	1410 (430)	1720 (524)	2100 (640)	2400 (732)	2790 (850)	3120 (951)
	10	-	-	-	160 <sup>18)</sup> (49 <sup>18)</sup> )	250 (76)	390 (119)	490 (149)	600 (183)	750 (229)	930 (283)	1160 (354)	1430 (436)	1760 (536)	2030 (619)	2370 (723)	2700 (823)
15	-	-	-	-	170 <sup>18)</sup> (52 <sup>18)</sup> )	270 (82)	340 (104)	430 (131)	530 (162)	660 (201)	820 (250)	1020 (311)	1260 (384)	1460 (445)	1700 (518)	1940 (591)	

<sup>18)</sup> Indicates single conductor only (not jacketed).

**Note:**

No asterisk indicates both jacketed cable and single conductor cables.

1. The table is based on copper wire. If aluminum wire is used, multiply lengths by 0.5.

The maximum permissible length of aluminum is considerably shorter than copper wire of same size.

2. Make sure that the portion of the total cable which is between the service entrance and a motor starter/controller does not exceed 25 % of the total maximum length to ensure reliable starter operation. Single-phase control boxes may be connected at any point of the total cable length.

3. The table is based on a maintaining motor terminal voltage at 95 % of service entrance voltage, running at maximum nameplate amperes. In general, a voltage drop must be maintained at 3 V / 100 ft or less.

4. 1 foot = 0.305 meter (1 meter = 3.28 feet).

200-208 V, 3 Ph 60 Hz

		Maximum submersible power cable length (maximum cable length in feet - starter to motor)															
Motor rating [Hp]	AWG copper wire size										MCM copper wire size						
	14	12	10	8	6	4	3	2	1	0	00	000	0000	250	300	350	
200-208 V 3 ph 60 Hz	.5	710 (216)	1140 (347)	1800 (549)	2840 (866)	4420 (1347)	-	-	-	-	-	-	-	-	-	-	-
	.75	510 (155)	810 (245)	1280 (390)	2030 (619)	3160 (963)	-	-	-	-	-	-	-	-	-	-	-
	1	430 (131)	690 (210)	1080 (329)	1710 (521)	2670 (814)	4140 (1262)	5140 (1567)	-	-	-	-	-	-	-	-	-
	1.5	310 (94)	500 (152)	790 (241)	1260 (384)	1960 (597)	3050 (930)	3780 (1152)	-	-	-	-	-	-	-	-	-
	2	240 (73)	390 (119)	610 (186)	970 (296)	1520 (463)	2360 (719)	2940 (896)	3610 (1100)	4430 (1350)	5420 (1652)	-	-	-	-	-	-
	3	180 (55)	290 (88)	470 (143)	740 (226)	1160 (354)	1810 (552)	2250 (686)	2760 (841)	3390 (1033)	4130 (1259)	-	-	-	-	-	-
	5	110* (34*)	170 (52)	280 (85)	440 (134)	690 (210)	1080 (329)	1350 (411)	1660 (506)	2040 (622)	2490 (759)	3050 (930)	3670 (1119)	4440 (1353)	5030 (1533)	-	-
	7.5	-	-	200 (61)	310 (94)	490 (149)	770 (235)	960 (293)	1180 (360)	1450 (442)	1770 (539)	2170 (661)	2600 (792)	3150 (960)	3560 (1085)	-	-
	10	-	-	-	230 <sup>19)</sup> (70 <sup>19)</sup>	370 (113)	570 (174)	720 (219)	880 (268)	1090 (332)	1330 (405)	1640 (500)	1970 (600)	2390 (728)	2720 (829)	3100 (945)	3480 (1061)
	15	-	-	-	160 <sup>19)</sup> (49 <sup>19)</sup>	250 <sup>19)</sup> (76 <sup>19)</sup>	390 (119)	490 (149)	600 (183)	740 (226)	910 (277)	1110 (338)	1340 (408)	1630 (497)	1850 (564)	2100 (640)	2350 (716)
	20	-	-	-	-	190 <sup>19)</sup> (58 <sup>19)</sup>	300 <sup>19)</sup> (91 <sup>19)</sup>	380 (116)	460 (140)	570 (174)	700 (213)	860 (262)	1050 (320)	1270 (387)	1440 (439)	1650 (503)	1850 (564)
	25	-	-	-	-	-	240 <sup>19)</sup> (73 <sup>19)</sup>	300 <sup>19)</sup> (91 <sup>19)</sup>	370 <sup>19)</sup> (113 <sup>19)</sup>	460 (140)	570 (174)	700 (213)	840 (256)	1030 (314)	1170 (357)	1330 (405)	1500 (457)
	30	-	-	-	-	-	-	250 <sup>19)</sup> (76* <sup>19)</sup>	310 <sup>19)</sup> (94 <sup>19)</sup>	380 <sup>19)</sup> (116 <sup>19)</sup>	470 (143)	580 (177)	700 (213)	850 (259)	970 (296)	1110 (338)	1250 (381)

<sup>19)</sup> Indicates single conductor only (not jacketed).

**Note:**

No asterisk indicates both jacketed cable and single conductor cables.

1. The table is based on copper wire. If aluminum wire is used, multiply lengths by 0.5.

The maximum permissible length of aluminum is considerably shorter than copper wire of same size.

2. Make sure that the portion of the total cable which is between the service entrance and a motor starter/controller does not exceed 25 % of the total maximum length to ensure reliable starter operation. Single-phase control boxes may be connected at any point of the total cable length.

3. The table is based on a maintaining motor terminal voltage at 95 % of service entrance voltage, running at maximum nameplate amperes. In general, a voltage drop must be maintained at 3 V / 100 ft or less.

4. 1 foot = 0.305 meter (1 meter = 3.28 feet).

230 V, three-phase, 60 Hz

Maximum submersible power cable length (maximum cable length in feet, starter to motor)																		
Motor rating	[Hp]	AWG copper wire size											MCM copper wire size					
		[ft (m)]																
		14	12	10	8	6	4	3	2	1	0	00	000	0000	250	300	350	400
230 V 3-ph 60 Hz	.5	930 (283)	1490 (454)	2350 (716)	3700 (1128)	5760 (1756)	8910 (2716)	-	-	-	-	-	-	-	-	-	-	-
	.75	670 (204)	1080 (329)	1700 (518)	2580 (786)	4190 (1277)	6490 (1978)	8060 (2457)	9860 (3005)	-	-	-	-	-	-	-	-	-
	1	560 (171)	910 (277)	1430 (436)	2260 (689)	3520 (1073)	5460 (1664)	6780 (2067)	8290 (2527)	-	-	-	-	-	-	-	-	-
	1.5	420 (128)	670 (204)	1060 (323)	1670 (509)	2610 (796)	4050 (1234)	5030 (1533)	6160 (1878)	7530 (2295)	9170 (2795)	-	-	-	-	-	-	-
	2	320 (98)	510 (155)	810 (247)	1280 (390)	2010 (613)	3130 (954)	3890 (1186)	4770 (1454)	5860 (1786)	7170 (2185)	8780 (2676)	-	-	-	-	-	-
	3	240 (73)	390 (119)	620 (189)	990 (302)	1540 (469)	2400 (732)	2980 (908)	3660 (1116)	4480 (1366)	5470 (1667)	6690 (2039)	8020 (2444)	9680 (2950)	-	-	-	-
	5	140 <sup>20)</sup> (43 <sup>20)</sup> )	230 (70)	370 (113)	590 (180)	920 (280)	1430 (436)	1790 (546)	2190 (668)	2690 (820)	3290 (1003)	4030 (1228)	4850 (1478)	5870 (1789)	6650 (2027)	7560 (2304)	8460 (2579)	9220 (2810)
	7.5	-	160 <sup>20)</sup> (49 <sup>20)</sup> )	260 (79)	420 (128)	650 (198)	1020 (311)	1270 (387)	1560 (475)	1920 (585)	2340 (713)	2870 (875)	3440 (1049)	4160 (1268)	4710 (1436)	5340 (1628)	5970 (1820)	6500 (1981)
	10	-	-	190 <sup>20)</sup> (58 <sup>20)</sup> )	310 (94)	490 (149)	760 (232)	950 (290)	1170 (357)	1440 (439)	1760 (536)	2160 (658)	2610 (796)	3160 (963)	3590 (1094)	4100 (1250)	4600 (1402)	5020 (1530)
	15	-	-	-	210 <sup>20)</sup> (64 <sup>20)</sup> )	330 (101)	520 (158)	650 (198)	800 (244)	980 (299)	1200 (366)	1470 (448)	1780 (543)	2150 (655)	2440 (744)	2780 (847)	3110 (948)	3400 (1036)
20	-	-	-	-	250 <sup>20)</sup> (76 <sup>20)</sup> )	400 (122)	500 (152)	610 (186)	760 (232)	930 (283)	1140 (347)	1380 (421)	1680 (512)	1910 (582)	2180 (664)	2450 (747)	2680 (817)	
25	-	-	-	-	-	320 <sup>20)</sup> (98 <sup>20)</sup> )	400 (122)	500 (152)	610 (186)	750 (229)	920 (280)	1120 (341)	1360 (415)	1540 (469)	1760 (536)	1980 (604)	2160 (658)	
30	-	-	-	-	-	260 <sup>20)</sup> (79 <sup>20)</sup> )	330 <sup>20)</sup> (101 <sup>20)</sup> )	410 <sup>20)</sup> (125 <sup>20)</sup> )	510 (155)	620 (189)	760 (232)	930 (283)	1130 (344)	1280 (390)	1470 (448)	1650 (503)	1800 (549)	

<sup>20)</sup> Indicates single conductor only (not jacketed)

**Note:**

No asterisk indicates both jacketed cable and single-conductor cables.

1. The table is based on copper wire. If aluminum wire is used, multiply lengths by 0.5.

The maximum permissible length of aluminum is considerably shorter than copper wire of same size.

2. Make sure that the portion of the total cable which is between the service entrance and a motor starter/controller does not exceed 25 % of the total maximum length to ensure reliable starter operation. Single-phase control boxes may be connected at any point of the total cable length.

3. The table is based on maintaining motor terminal voltage at 95 % of service entrance voltage, running at maximum nameplate amperes. In general, a voltage drop must be maintained at 3 V / 100 ft or less.

4. 1 foot = 0.305 meter (1 meter = 3.28 feet).

460 V, 3 ph 60 Hz

		Maximum submersible power cable length (maximum cable length in feet - starter to motor)																
Motor rating [Hp]		AWG copper wire size										MCM copper wire size						
		[ft (m)]										250	300	350				
		14	12	10	8	6	4	3	2	1	0	00	000	0000	250	300	350	
460 V 3 ph 60 Hz	.5	3770 (1149)	6020 (1835)	9460 (2883)	-	-	-	-	-	-	-	-	-	-	-	-	-	
	.75	2730 (832)	4350 (1326)	6850 (2088)	-	-	-	-	-	-	-	-	-	-	-	-	-	
	1	2300 (701)	3670 (1119)	5770 (1759)	9070 (2765)	-	-	-	-	-	-	-	-	-	-	-	-	
	1.5	1700 (518)	2710 (826)	4270 (1301)	6730 (2051)	-	-	-	-	-	-	-	-	-	-	-	-	
	2	1300 (396)	2070 (631)	3270 (997)	5150 (1570)	8050 (2454)	-	-	-	-	-	-	-	-	-	-	-	
	3	1000 (305)	1600 (488)	2520 (768)	3970 (1210)	6200 (1890)	-	-	-	-	-	-	-	-	-	-	-	
	5	590 (180)	950 (290)	1500 (457)	2360 (719)	3700 (1128)	5750 (1753)	-	-	-	-	-	-	-	-	-	-	
	7.5	420 (128)	680 (207)	1070 (326)	1690 (515)	2640 (805)	4100 (1250)	5100 (1554)	6260 (1908)	7680 (2341)	-	-	-	-	-	-	-	
	10	310 (94)	500 (152)	790 (241)	1250 (381)	1960 (597)	3050 (930)	3800 (1158)	4680 (1426)	5750 (1753)	7050 (2149)	-	-	-	-	-	-	
	15	-	340 <sup>21)</sup> (104 <sup>21)</sup> )	540 (165)	850 (259)	1340 (408)	2090 (637)	2600 (792)	3200 (975)	3930 (1198)	4810 (1466)	5900 (1798)	7110 (2167)	-	-	-	-	
	20	-	-	410 (125)	650 (198)	1030 (314)	1610 (491)	2000 (610)	2470 (753)	3040 (927)	3730 (1137)	4580 (1396)	5530 (1686)	-	-	-	-	
	25	-	-	330 <sup>21)</sup> (101 <sup>21)</sup> )	530 (162)	830 (253)	1300 (396)	1620 (494)	1990 (607)	2450 (747)	3010 (917)	3700 (1128)	4470 (1362)	5430 (1655)	-	-	-	
	30	-	-	270 <sup>21)</sup> (82 <sup>21)</sup> )	430 (131)	680 (207)	1070 (326)	1330 (405)	1640 (500)	2030 (619)	2490 (759)	3060 (933)	3700 (1128)	4500 (1372)	5130 (1564)	5860 (1786)	-	
	40	-	-	-	320 <sup>21)</sup> (98 <sup>21)</sup> )	500 <sup>21)</sup> (152 <sup>21)</sup> )	790 (241)	980 (299)	1210 (369)	1490 (454)	1830 (558)	2250 (686)	2710 (826)	3290 (1003)	3730 (1137)	4250 (1295)	-	
	50	-	-	-	-	410 <sup>21)</sup> (125 <sup>21)</sup> )	640 (195)	800 (244)	980 (299)	1210 (369)	1480 (451)	1810 (552)	2190 (668)	2650 (808)	3010 (917)	3420 (1042)	3830 (1167)	
	60	-	-	-	-	-	540 <sup>21)</sup> (165 <sup>21)</sup> )	670 <sup>21)</sup> (204 <sup>21)</sup> )	830 (253)	1020 (311)	1250 (381)	1540 (469)	1850 (564)	2240 (683)	2540 (774)	2890 (881)	3240 (988)	
	75	-	-	-	-	-	-	440 <sup>21)</sup> (134 <sup>21)</sup> )	550 <sup>21)</sup> (168 <sup>21)</sup> )	680 <sup>21)</sup> (207 <sup>21)</sup> )	840 (256)	1030 (314)	1260 (384)	1520 (463)	1850 (564)	2100 (640)	2400 (732)	2700 (823)
	100	-	-	-	-	-	-	-	500 <sup>21)</sup> (152 <sup>21)</sup> )	620 <sup>21)</sup> (189 <sup>21)</sup> )	760 <sup>21)</sup> (232 <sup>21)</sup> )	940 (287)	1130 (344)	1380 (421)	1560 (475)	1790 (546)	2010 (613)	
	125	-	-	-	-	-	-	-	-	-	600 <sup>21)</sup> (183 <sup>21)</sup> )	740 <sup>21)</sup> (226 <sup>21)</sup> )	890 <sup>21)</sup> (271 <sup>21)</sup> )	1000 (305)	1220 (372)	1390 (424)	1560 (475)	
	150	-	-	-	-	-	-	-	-	-	-	630 <sup>21)</sup> (192 <sup>21)</sup> )	760 <sup>21)</sup> (232 <sup>21)</sup> )	920 <sup>21)</sup> (280 <sup>21)</sup> )	1050 (320)	1190 (363)	1340 (408)	
175	-	-	-	-	-	-	-	-	-	-	-	670 <sup>21)</sup> (204 <sup>21)</sup> )	810 <sup>21)</sup> (247 <sup>21)</sup> )	930 <sup>21)</sup> (283 <sup>21)</sup> )	1060 (323)	1190 (363)		
200	-	-	-	-	-	-	-	-	-	-	-	-	590 <sup>21)</sup> (180 <sup>21)</sup> )	710 <sup>21)</sup> (216 <sup>21)</sup> )	810 <sup>21)</sup> (247 <sup>21)</sup> )	920 <sup>21)</sup> (280 <sup>21)</sup> )	1030 (314)	

<sup>21)</sup> Indicates single conductor only (not jacketed).

**Note:**

No asterisk indicates both jacketed cable and single-conductor cables.

1. The table is based on copper wire. If aluminum wire is used, multiply lengths by 0.5.

The maximum permissible length of aluminum is considerably shorter than copper wire of same size.

2. Make sure that the portion of the total cable which is between the service entrance and a motor starter/controller does not exceed 25 % of the total maximum length to ensure reliable starter operation. Single-phase control boxes may be connected at any point of the total cable length.

3. The table is based on a maintaining motor terminal voltage at 95 % of service entrance voltage, running at maximum nameplate amperes. In general, a voltage drop must be maintained at 3 V / 100 ft or less.

4. 1 foot = 0.305 meter (1 meter = 3.28 feet).

575 V, 3 ph 60 Hz

		Maximum submersible power cable length (maximum cable length in feet - starter to motor)															
Motor rating [Hp]		AWG copper wire size [ft (m)]										MCM copper wire size					
		14	12	10	8	6	4	3	2	1	0	00	000	0000	250	300	350
575 V 3 ph 60 Hz	.5	5900 (1798)	9410 (2868)	-	-	-	-	-	-	-	-	-	-	-	-	-	-
	.75	4270 (1301)	6810 (2076)	-	-	-	-	-	-	-	-	-	-	-	-	-	-
	1	3630 (1106)	5800 (1768)	9120 (2780)	-	-	-	-	-	-	-	-	-	-	-	-	-
	1.5	2620 (799)	4180 (1274)	6580 (2006)	-	-	-	-	-	-	-	-	-	-	-	-	-
	2	2030 (619)	3250 (991)	5110 (1558)	8060 (2457)	-	-	-	-	-	-	-	-	-	-	-	-
	3	1580 (482)	2530 (771)	3980 (1213)	6270 (1911)	-	-	-	-	-	-	-	-	-	-	-	-
	5	920 (280)	1480 (451)	2330 (710)	3680 (1122)	5750 (1753)	-	-	-	-	-	-	-	-	-	-	-
	7.5	660 (201)	1060 (323)	1680 (512)	2650 (808)	4150 (1265)	-	-	-	-	-	-	-	-	-	-	-
	10	490 (149)	780 (238)	1240 (378)	1950 (594)	3060 (933)	4770 (1454)	5940 (1811)	-	-	-	-	-	-	-	-	-
	15	330 <sup>22)</sup> (101 <sup>22)</sup> )	530 (162)	850 (259)	1340 (408)	2090 (637)	3260 (994)	4060 (1237)	-	-	-	-	-	-	-	-	-
	20	-	410 <sup>22)</sup> (125 <sup>22)</sup> )	650 (198)	1030 (314)	1610 (491)	2520 (768)	3140 (957)	3860 (1177)	4760 (1451)	5830 (1777)	-	-	-	-	-	-
	25	-	-	520 (158)	830 (253)	1300 (396)	2030 (619)	2530 (771)	3110 (948)	3840 (1170)	4710 (1436)	-	-	-	-	-	-
	30	-	-	430 <sup>22)</sup> (131 <sup>22)</sup> )	680 (207)	1070 (326)	1670 (509)	2080 (634)	2560 (780)	3160 (963)	3880 (1183)	4770 (1454)	5780 (1762)	7030 (2143)	8000 (2438)	-	-
	40	-	-	-	500 <sup>22)</sup> (152 <sup>22)</sup> )	790 (241)	1240 (378)	1540 (469)	1900 (579)	2330 (710)	2860 (872)	3510 (1070)	4230 (1289)	5140 (1567)	5830 (1777)	-	-
	50	-	-	-	410 <sup>22)</sup> (125 <sup>22)</sup> )	640 <sup>22)</sup> (195 <sup>22)</sup> )	1000 (305)	1250 (381)	1540 (469)	1890 (576)	2310 (704)	2840 (866)	3420 (1042)	4140 (1262)	4700 (1433)	5340 (1628)	5990 (1826)
	60	-	-	-	-	540 <sup>22)</sup> (165 <sup>22)</sup> )	850 (259)	1060 (323)	1300 (396)	1600 (488)	1960 (597)	2400 (732)	2890 (881)	3500 (1067)	3970 (1210)	4520 (1378)	5070 (1545)
	75	-	-	-	-	-	690 <sup>22)</sup> (210 <sup>22)</sup> )	860 (262)	1060 (323)	1310 (399)	1600 (488)	1970 (600)	2380 (725)	2890 (881)	3290 (1003)	3750 (1143)	4220 (1286)
	100	-	-	-	-	-	-	640 <sup>22)</sup> (195 <sup>22)</sup> )	790 <sup>22)</sup> (241 <sup>22)</sup> )	970 (296)	1190 (363)	1460 (445)	1770 (539)	2150 (655)	2440 (744)	2790 (850)	3140 (957)
	125	-	-	-	-	-	-	-	630 <sup>22)</sup> (192 <sup>22)</sup> )	770 <sup>22)</sup> (235 <sup>22)</sup> )	950 (290)	1160 (354)	1400 (427)	1690 (515)	1920 (585)	2180 (664)	2440 (744)
	150	-	-	-	-	-	-	-	-	660 <sup>22)</sup> (202 <sup>22)</sup> )	800 <sup>22)</sup> (244 <sup>22)</sup> )	990 <sup>22)</sup> (302 <sup>22)</sup> )	1190 (363)	1440 (439)	1630 (497)	1860 (567)	2080 (634)
175	-	-	-	-	-	-	-	-	-	700 <sup>22)</sup> (214 <sup>22)</sup> )	870 <sup>22)</sup> (265 <sup>22)</sup> )	1050 <sup>22)</sup> (320 <sup>22)</sup> )	1270 (387)	1450 (442)	1650 (503)	1860 (567)	
200	-	-	-	-	-	-	-	-	-	-	760* (232*)	920 <sup>22)</sup> (280 <sup>22)</sup> )	1110 <sup>22)</sup> (338 <sup>22)</sup> )	1260 (384)	1440 (439)	1620 (494)	

<sup>22)</sup> Indicates single conductor only (not jacketed).

**Note:**

No asterisk indicates both jacketed cable and single conductor cables.

1. The table is based on copper wire. If aluminum wire is used, multiply lengths by 0.5.

The maximum permissible length of aluminum is considerably shorter than copper wire of same size.

2. Make sure that the portion of the total cable which is between the service entrance and a motor starter/controller does not exceed 25 % of the total maximum length to ensure reliable starter operation. Single-phase control boxes may be connected at any point of the total cable length.

3. The table is based on a maintaining motor terminal voltage at 95 % of service entrance voltage, running at maximum nameplate amperes. In general, a voltage drop must be maintained at 3 V / 100 ft or less.

4. 1 foot = 0.305 meter (1 meter = 3.28 feet).

## 12. Friction loss tables

		Friction loss table - SCH 40 steel pipe								
		.5"	.75"	1"	1.25"	1.5"	2"	2.5"	3"	4"
[US gpm]	[US gph]	ID 0.622"	ID 0.824"	ID 1.049"	ID 1.380"	ID 1.610"	ID 2.067"	ID 2.469"	ID 3.068"	ID 4.026"
Friction loss in feet of head per 100 feet of pipe										
2	120	4.8								
3	180	10.0	2.5							
4	240	17.1	4.2							
5	300	25.8	6.3	1.9						
6	360	36.5	8.9	2.7						
7	420	48.7	11.8	3.6						
8	480	62.7	15.0	4.5						
9	540	78.3	18.8	5.7						
10	600	95.9	23.0	6.9						
12	720		32.6	9.6	2.5	1.2				
14	840		43.5	12.8	3.3	1.5				
16	960		56.3	16.5	4.2	2.0				
20	1,200		86.1	25.1	6.3	2.9				
25	1,500			38.7	9.6	4.5	1.3			
30	1,800			54.6	13.6	6.3	1.8			
35	2,100			73.3	18.2	8.4	2.4			
40	2,400			95.0	23.5	10.8	3.1	1.3		
45	2,700				29.4	13.5	3.9	1.6		
50	3,000				36.0	16.4	4.7	1.9		
60	3,600				51.0	23.2	6.6	2.7		
70	4,200				68.8	31.3	8.9	3.6	1.2	
80	4,800				89.2	40.5	11.4	4.6	1.6	
90	5,400					51.0	14.2	5.8	2.0	
100	6,000					62.2	17.4	7.1	2.4	
120	7,200						24.7	10.1	3.4	
140	8,400						33.2	13.5	4.5	1.2
160	9,600						43.0	17.5	5.8	1.5
200	12,000						66.3	27.0	8.9	2.3
260	15,600							45.0	14.8	3.7
300	18,000							59.6	19.5	4.9

		Friction loss table - SCH 40 PVC pipe								
[US gpm]	[US gph]	.5"	.75"	1"	1.25"	1.5"	2"	2.5"	3"	4"
		ID 0.622"	ID 0.824"	ID 1.049"	ID 1.380"	ID 1.610"	ID 2.067"	ID 2.469"	ID 3.068"	ID 4.026"
Friction loss in feet of head per 100 feet of pipe										
2	120	4.1								
3	180	8.7	2.2							
4	240	14.8	3.7							
5	300	22.2	5.7	1.8						
6	360	31.2	8.0	2.5						
7	420	41.5	10.6	3.3						
8	480	53.0	13.5	4.2						
9	540	66.0	16.8	5.2						
10	600	80.5	20.4	6.3	1.7					
12	720		28.6	8.9	2.3	1.1				
14	840		38.0	11.8	3.1	1.4				
16	960		48.6	15.1	4.0	1.9				
20	1,200		60.5	22.8	6.0	2.8				
25	1,500			38.7	9.1	4.3	1.3			
30	1,800				12.7	6.0	1.8			
35	2,100				16.9	8.0	2.4			
40	2,400				21.6	10.2	3.0	1.1		
45	2,700				28.0	12.5	3.8	1.4		
50	3,000					15.4	4.6	1.7		
60	3,600					21.6	6.4	2.3		
70	4,200					28.7	8.5	3.0	1.2	
80	4,800					36.8	10.9	3.8	1.4	
90	5,400					45.7	13.6	4.8	1.8	
100	6,000					56.6	16.5	5.7	2.2	
120	7,200						23.1	8.0	3.0	
140	8,400						30.6	10.5	4.0	1.1
160	9,600						39.3	13.4	5.0	1.4
200	12,000						66.3	20.1	7.6	2.1
260	15,600							32.4	12.2	3.4
300	18,000							42.1	15.8	4.4



Type of fitting and application	Pipe and fitting	Nominal size of fitting and pipe						
		1/2"	3/4"	1"	1.25"	1.5"	2"	2.5"
<b>Friction loss in equivalent length of straight pipe in feet</b>								
Insert coupling	Plastic	3	3	3	3	3	3	3
Threaded adapter (plastic to thread)	Plastic	3	3	3	3	3	3	3
90° standard elbow	Steel	2	2	3	4	4	5	6
	Plastic	2	2	3	4	4	5	6
Standard tee (flow through run)	Steel	1	2	2	3	3	4	4
	Plastic	1	2	2	3	3	4	4
Standard tee (flow through side)	Steel	4	5	6	7	8	11	13
	Plastic	4	5	6	7	8	11	13
Gate valve <sup>23)</sup>	Steel	1	1	1	1	2	2	2
Swing check valve <sup>23)</sup>	Steel	5	7	9	12	13	17	21

<sup>23)</sup> Friction loss figures are for screwed valves and are based on equivalent lengths of steel pipe.

**Notes:**

Based on Schedule 40 steel and plastic fittings.

Friction loss figures are for screwed valves and are based on equivalent lengths of steel pipe.

## 13. Grundfos Product Center

Online search and sizing tool to help you make the right choice.

From the international view, you can select your specific country to view the product range available to you.

International view: <http://product-selection.grundfos.com>

### All the information you need in one place

Performance curves, technical specifications, pictures, dimensional drawings, motor curves, wiring diagrams, spare parts, service kits, 3D drawings, documents, system parts. The Product Center displays any recent and saved items - including complete projects - right on the main page.

### Downloads

On the product pages, you can download installation and operating instructions, data booklets, service instructions, etc., in PDF format.

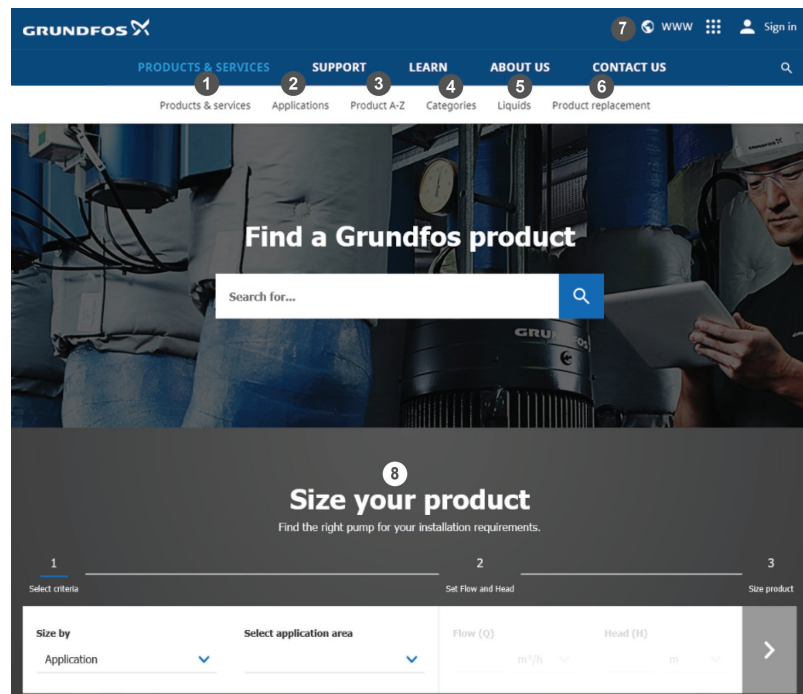
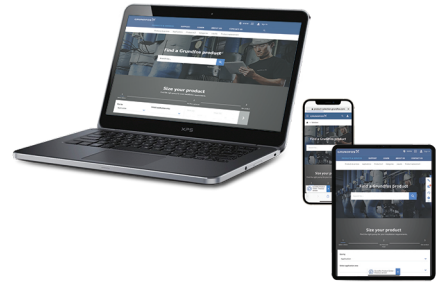

When you select your country, you will see the menus below. Note that some menus may not be available depending on the country.

Example: <https://product-selection.grundfos.com/uk>

Pos.	Description
1	<b>Products &amp; services</b> enables you to find products and documents by typing a product number or name into the search field.
2	<b>Applications</b> enables you to choose an application to see how Grundfos can help you design and optimize your system.
3	<b>Products A-Z</b> enables you to look through a list of all the Grundfos products.
4	<b>Categories</b> enables you to look for a product category.
5	<b>Liquids</b> enables you to find pumps designed for aggressive, flammable or other special liquids.
6	<b>Product replacement</b> enables you to find a suitable replacement.
7	<b>WWW</b> enables you to select the country, which changes the language, the available product range and the structure of the website.
8	<b>Sizing</b> enables you to size a product based on your application and operating conditions.

## 14. Document quality feedback

To provide feedback about this document, scan the QR-code using your phone's camera or a QR code app.



FEEDBACK98992402

[Click here to submit your feedback](#)

98992402 12.2024

ECM: 1390390

**GRUNDFOS Holding A/S**  
Poul Due Jensens Vej 7  
DK-8850 Bjerringbro  
Tel: +45 87 50 14 00  
[www.grundfos.com](http://www.grundfos.com)

**GRUNDFOS** 