

BM, BMB

Booster modules 4", 6", and 8"
60 Hz and 50 Hz

Technical data

Flow, Q: 60 Hz max. 1475 gpm
(335 m³/h)

50 Hz max. 1233 gpm
(280 m³/h)

Head, H: max. 1595 ft (486 m)

Liquid temp.: +32°F to +104°F
(0°C to +40°C)

BM working press.: max. 1160 psi (80 bar)

BMB working press.: max. 870 psi (60 bar)

Applications

Suitable for pressure boosting in:

- Reverse osmosis systems
- Water supply systems
- Water treatment systems
- Industrial plants
- High pressure washing

Features and benefits

- Low noise
- Handles high pressures/high heads
- Simple installation
- Compact, modular design
- Sealless
- Low maintenance

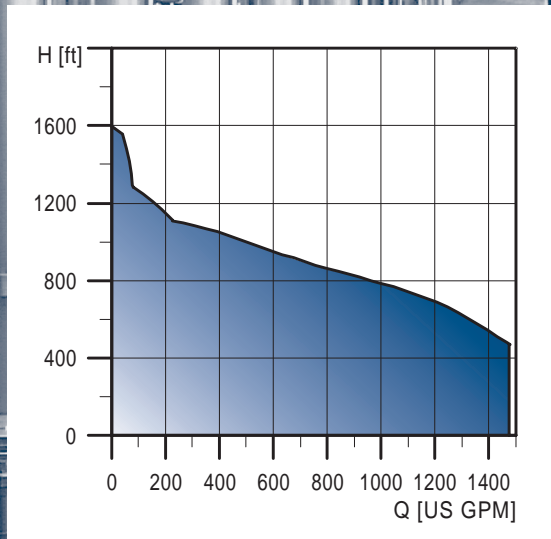
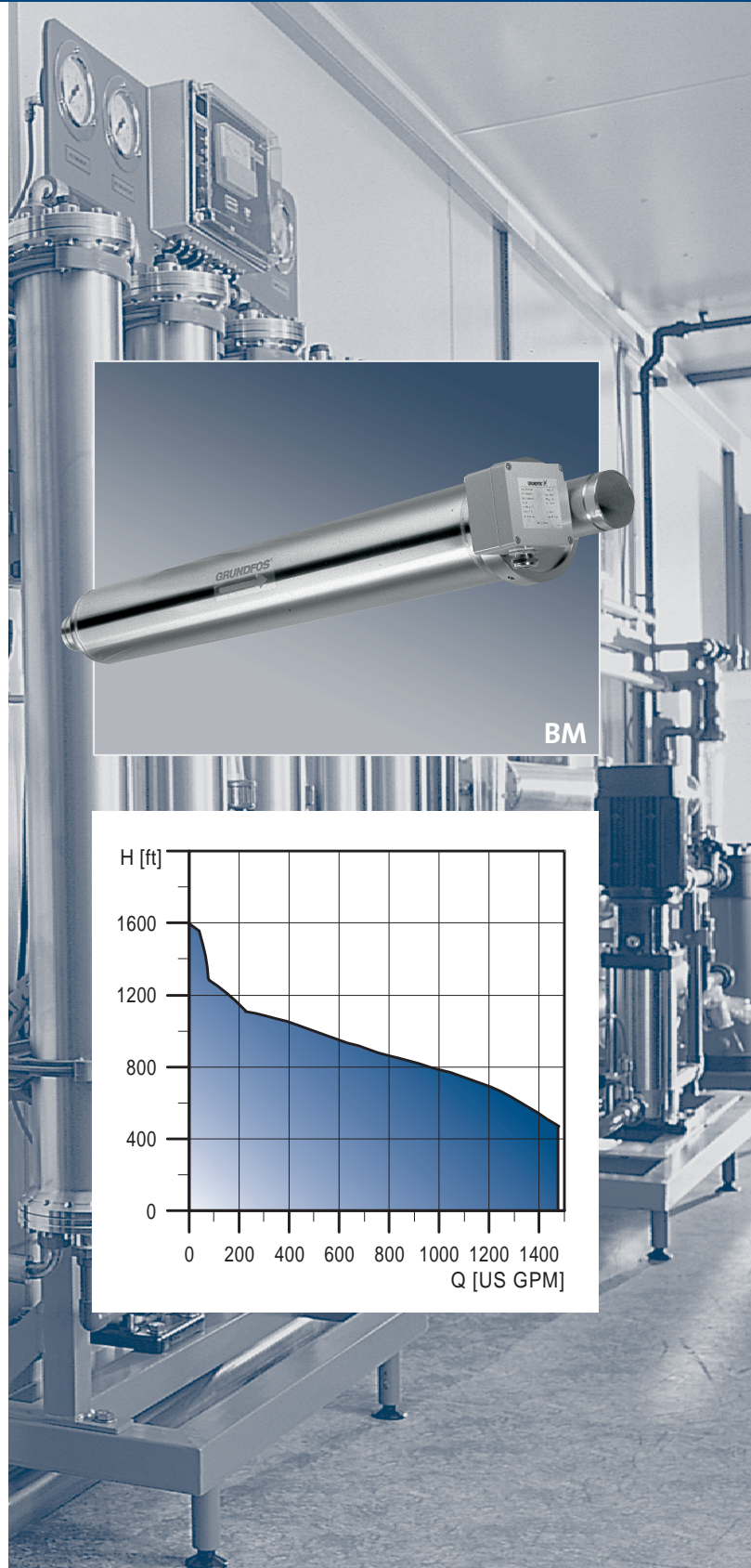

BM, BMB

Booster modules 4", 6", and 8" 60 Hz and 50 Hz

Construction

Grundfos modified standard submersible pumps are used for BM and BMB booster modules. Pump and motor are centered in a stainless steel sleeve. Both sleeve ends can be connected to the piping by means of victaulic couplings.

Sleeve of 4", 6", and 8" modules is supplied with straight pipe inlet and outlet. The 4" size is also available with 90° bends at the suction and discharge ends.

BM and BMB pumps have an asynchronous submersible squirrel-cage motor of the canned type with water-lubricated bearings.

Connections

Size	Model type	Victaulic coupling Style 77
BM 4"	BM 3A - BM 8A	1 1/4" / ø42 mm
BMB 4"	BMB 3A - BMB 8A	1 1/4" / ø42 mm
BM 6"	BM 17 - BM 60	3" / ø89 mm
BMB 6"	BMB 17 - BMB 60	3" / ø89 mm
BM 8"	BM 30 - BM 46	3" / ø89 mm
BMB 8"	BMB 30 - BMB 46	3" / ø89 mm
BM 8"	BM 60	4" / ø114 mm
BMB 8"	BMB 60	4" / ø114 mm
BM 8"	BM 77 - 95	5" / ø139 mm
BMB 8"	BMB 77 - 95	5" / ø139 mm
BM 8"	BM 125	6" / ø168 mm
BMB 8"	BMB 125	6" / ø168 mm

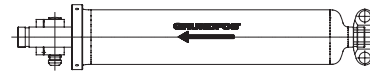

BM 4" straight version



BM 4" elbow version

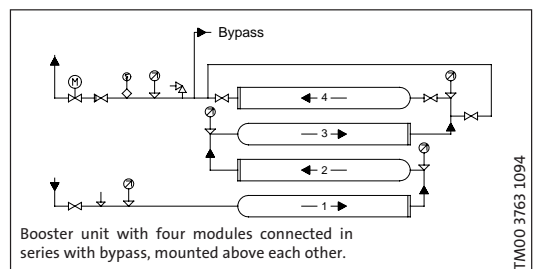
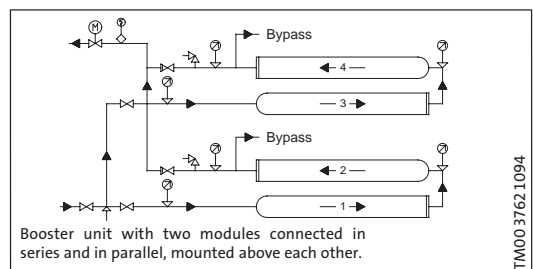
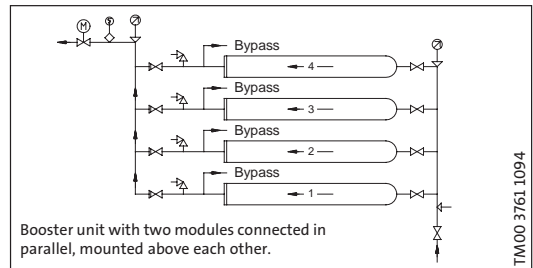
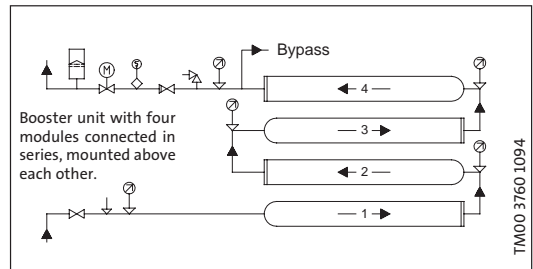

L-BM-PG-004 4/03
 PRINTED IN USA

Subject to alterations.