

Dell EMC PowerEdge R550

Installation and Service Manual

Notes, cautions, and warnings

 **NOTE:** A NOTE indicates important information that helps you make better use of your product.

 **CAUTION:** A CAUTION indicates either potential damage to hardware or loss of data and tells you how to avoid the problem.

 **WARNING:** A WARNING indicates a potential for property damage, personal injury, or death.

Chapter 1: About this document	7
Chapter 2: System overview	8
Front view of the system.....	8
Left control panel view.....	11
Right control panel view.....	12
Rear view of the system.....	13
Inside the system	14
Locating the Express Service Code and Service Tag.....	15
System information label.....	15
Rail sizing and rack compatibility matrix.....	21
Chapter 3: Initial system setup and configuration	22
Setting up the system.....	22
iDRAC configuration.....	22
Options to set up iDRAC IP address.....	22
Options to log in to iDRAC.....	23
Resources to install operating system.....	24
Options to download firmware	24
Options to download and install OS drivers	25
Downloading drivers and firmware.....	25
Chapter 4: Minimum to POST and system management configuration validation	26
Minimum configuration to POST	26
Configuration validation.....	26
Error messages.....	27
Chapter 5: Installing and removing system components	28
Safety instructions.....	28
Before working inside your system.....	29
After working inside your system.....	29
Recommended tools.....	29
Optional front bezel.....	30
Removing the front bezel.....	30
Installing the front bezel.....	31
System cover.....	32
Removing the system cover.....	32
Installing the system cover.....	33
Drive backplane cover.....	34
Removing the drive backplane cover.....	34
Installing the drive backplane cover.....	35
Air shroud.....	37
Removing the air shroud.....	37
Installing the air shroud.....	37

Cooling fans.....	38
Removing the cooling fan cage assembly.....	38
Installing the cooling fan cage assembly.....	39
Removing a cooling fan.....	40
Installing a cooling fan.....	41
Side wall brackets.....	42
Removing the side wall bracket.....	42
Installing the side wall bracket.....	43
Intrusion switch module.....	44
Removing the intrusion switch module.....	44
Installing the intrusion switch module.....	45
Optional serial COM port.....	46
Removing the optional serial COM port.....	46
Installing the optional serial COM port	47
Drives.....	48
Removing a drive blank.....	48
Installing a drive blank.....	49
Removing the drive carrier.....	49
Installing the drive carrier.....	50
Removing the drive from the drive carrier.....	51
Installing the drive into the drive carrier.....	52
Drive backplane.....	53
Drive backplane.....	53
Removing the drive backplane	54
Installing the drive backplane.....	55
Cable routing.....	57
System memory.....	60
System memory guidelines.....	60
General memory module installation guidelines.....	61
Removing a memory module.....	62
Installing a memory module.....	63
Processor and heat sink module.....	64
Removing processor and heat sink module.....	64
Removing the processor from the processor and heat sink module.....	66
Installing the processor into a processor and heat sink module.....	68
Installing the processor heat sink module.....	72
Expansion cards.....	74
Expansion card installation guidelines.....	75
Removing the expansion card.....	78
Installing the expansion card.....	79
Optional IDSDM module.....	81
Removing the IDSDM module.....	81
Installing the IDSDM module.....	81
Optional BOSS S2 card.....	82
Removing the BOSS S2 module.....	82
Installing the BOSS S2 module.....	85
Front mounting front PERC module.....	88
Removing the front mounting front PERC module.....	88
Installing the front mounting front PERC module.....	89
Optional OCP card.....	90

Removing the OCP shroud.....	90
Installing the OCP shroud.....	91
Removing the OCP card.....	92
Installing the OCP card.....	93
System battery	94
Replacing the system battery.....	94
Optional internal USB card.....	96
Removing the internal USB card.....	96
Installing the internal USB card.....	97
MicroSD card.....	97
Removing the MicroSD card.....	97
Installing the MicroSD card.....	98
Power supply unit.....	99
Hot spare feature.....	99
Removing a power supply unit blank.....	100
Installing a power supply unit blank.....	100
Removing a power supply unit.....	101
Installing a power supply unit.....	101
Power interposer board.....	102
Removing the power interposer board.....	102
Installing the power interposer board.....	103
Cooling fan cage board.....	104
Removing the cooling fan cage board.....	104
Installing the cooling fan cage board.....	105
System board.....	106
Removing the system board.....	106
Installing the system board.....	107
Restoring the system using Easy Restore.....	109
Trusted Platform Module.....	109
Upgrading the Trusted Platform Module.....	109
Initializing TPM for users.....	110
Initializing the TPM 1.2 for users.....	110
Initializing the TPM 2.0 for users.....	110
Control panel.....	111
Removing the left control panel.....	111
Installing the left control panel.....	112
Removing the right control panel.....	112
Installing the right control panel.....	113
Optional optical drive.....	115
Removing the optical disk drive.....	115
Installing the optical disk drive	115
Chapter 6: Jumpers and connectors.....	117
System board connectors.....	117
System board jumper settings.....	118
Disabling a forgotten password.....	119
Chapter 7: System diagnostics and indicator codes.....	120
Status LED indicators.....	120

System health and system ID indicator codes.....	121
iDRAC Quick Sync 2 indicator codes.....	122
iDRAC Direct LED indicator codes.....	122
LCD panel.....	123
Viewing Home screen.....	124
Setup menu.....	124
View menu.....	124
NIC indicator codes.....	125
Power supply unit indicator codes.....	125
Drive indicator codes.....	127
Using system diagnostics.....	128
Dell Embedded System Diagnostics.....	128
Chapter 8: Getting help.....	130
Recycling or End-of-Life service information.....	130
Contacting Dell Technologies.....	130
Accessing system information by using QRL.....	130
Quick Resource Locator for PowerEdge R550 system.....	131
Receiving automated support with SupportAssist	131
Chapter 9: Documentation resources.....	132

About this document

This document provides an overview about the system, information about installing and replacing components, diagnostic tools, and guidelines to be followed while installing certain components.

System overview

The PowerEdge R550 system is a dual socket, 2U rack system that supports:

- Up to two 3rd Generation Intel Xeon Scalable processors with up to 24 cores per processor.
- 16 DDR4 DIMM slots
- Two redundant AC or DC power supply units
- 8 x 2.5-inch SAS/ SATA drives
- 16 x 2.5-inch SAS/ SATA drives
- 8 x 3.5-inch SAS/ SATA drives

i NOTE: All instances of SAS, SATA drives are referred to as drives in this document, unless specified otherwise.

i NOTE: For more information, see the *Dell EMC PowerEdge R550 Technical Specifications* on the product documentation page.

Topics:

- [Front view of the system](#)
- [Rear view of the system](#)
- [Inside the system](#)
- [Locating the Express Service Code and Service Tag](#)
- [System information label](#)
- [Rail sizing and rack compatibility matrix](#)

Front view of the system



Figure 1. Front view of the 16 x 2.5-inch drive system

Table 1. Features available on the front of the system

Item	Ports, panels, and slots	Icon	Description
1	Left control panel	N/A	<p>Contains the system health, system ID, status LED and the iDRAC Quick Sync 2 (wireless) indicator.</p> <p>i NOTE: The iDRAC Quick Sync 2 indicator is available only on certain configurations.</p> <ul style="list-style-type: none"> • Status LED: Enables you to identify any failed hardware components. There are up to five status LEDs and an overall system health LED (Chassis health and system ID) bar. For more information, see the Status LED indicators section.

Table 1. Features available on the front of the system (continued)

Item	Ports, panels, and slots	Icon	Description
			<ul style="list-style-type: none"> Quick Sync 2 (wireless): Indicates a Quick Sync enabled system. The Quick Sync feature is optional. This feature allows management of the system by using mobile devices called as OpenManage Mobile (OMM) feature. Using iDRAC Quick Sync 2 with OpenManage Mobile (OMM) aggregates hardware or firmware inventory and various system level diagnostic and error information that can be used in troubleshooting the system. For more information, see the <i>Integrated Dell Remote Access Controller User's Guide</i> available at https://www.dell.com/idracmanuals
2	Drive	N/A	Enables you to install drives that are supported on your system.
3	Right control panel and VGA port		Contains the power button, USB port, iDRAC Direct micro port, and the iDRAC Direct status LED. VGA port enables you to connect a display device to the system.
4	Information tag	N/A	The Information tag is a slide-out label panel that contains system information such as Service Tag, NIC, MAC address, and so on. If you have opted for the secure default access to iDRAC, the Information tag also contains the iDRAC secure default password.

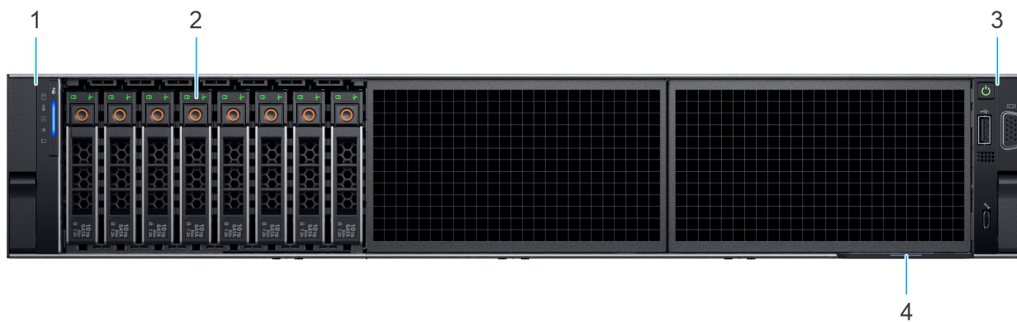



Figure 2. Front view of the 8 x 2.5-inch drive system

Table 2. Features available on the front of the system

Item	Ports, panels, and slots	Icon	Description
1	Left control panel	N/A	<p>Contains the system health, system ID, status LED and the iDRAC Quick Sync 2 (wireless) indicator.</p> <p>i NOTE: The iDRAC Quick Sync 2 indicator is available only on certain configurations.</p> <ul style="list-style-type: none"> Status LED: Enables you to identify any failed hardware components. There are up to five status LEDs and an overall system health LED (Chassis health and system ID) bar. For more information, see the Status LED indicators section. Quick Sync 2 (wireless): Indicates a Quick Sync enabled system. The Quick Sync feature is optional. This feature allows management of the system by using mobile devices called as OpenManage Mobile (OMM) feature. Using iDRAC Quick Sync 2 with OpenManage Mobile (OMM) aggregates hardware or firmware inventory and various system level diagnostic and error information that can be used in troubleshooting the system. For more information, see the <i>Integrated Dell Remote Access Controller User's Guide</i> available at https://www.dell.com/idracmanuals

Table 2. Features available on the front of the system (continued)

Item	Ports, panels, and slots	Icon	Description
2	Drive	N/A	Enables you to install drives that are supported on your system.
3	Right control panel and VGA port		Contains the power button, USB port, iDRAC Direct micro port, and the iDRAC Direct status LED. VGA port enables you to connect a display device to the system.
4	Information tag	N/A	The Information tag is a slide-out label panel that contains system information such as Service Tag, NIC, MAC address, and so on. If you have opted for the secure default access to iDRAC, the Information tag also contains the iDRAC secure default password.

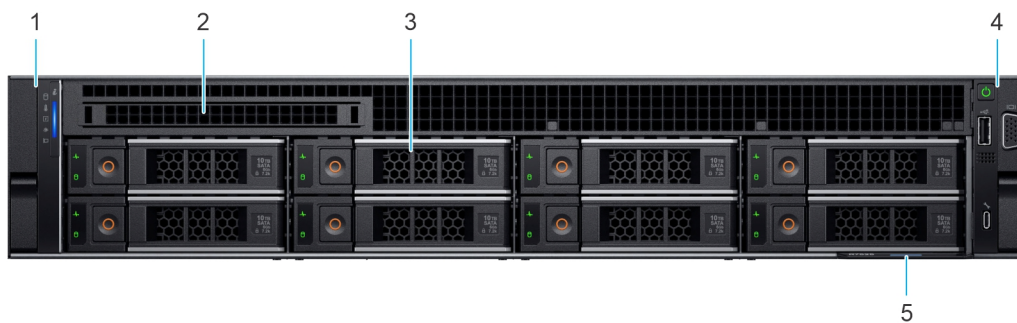

Figure 3. Front view of the 8 x 3.5-inch drive system

Table 3. Features available on the front of the system

Item	Ports, panels, and slots	Icon	Description
1	Left control panel	N/A	<p>Contains the system health, system ID, status LED and the iDRAC Quick Sync 2 (wireless) indicator.</p> <p>NOTE: The iDRAC Quick Sync 2 indicator is available only on certain configurations.</p> <ul style="list-style-type: none"> Status LED: Enables you to identify any failed hardware components. There are up to five status LEDs and an overall system health LED (Chassis health and system ID) bar. For more information, see the Status LED indicators section. Quick Sync 2 (wireless): Indicates a Quick Sync enabled system. The Quick Sync feature is optional. This feature allows management of the system by using mobile devices called as OpenManage Mobile (OMM) feature. Using iDRAC Quick Sync 2 with OpenManage Mobile (OMM) aggregates hardware or firmware inventory and various system level diagnostic and error information that can be used in troubleshooting the system. For more information, see the <i>Integrated Dell Remote Access Controller User's Guide</i> available at https://www.dell.com/idracmanuals
2	Optical drive blank	N/A	For the 8 x 3.5-inch drive system, a optical drive bay blank is installed.
3	Drive	N/A	Enables you to install drives that are supported on your system.
4	Right control panel and VGA port		Contains the power button, USB port, iDRAC Direct micro port, and the iDRAC Direct status LED. VGA port enables you to connect a display device to the system.
5	Information tag	N/A	The Information tag is a slide-out label panel that contains system information such as Service Tag, NIC, MAC address,

Table 3. Features available on the front of the system (continued)

Item	Ports, panels, and slots	Icon	Description
			and so on. If you have opted for the secure default access to iDRAC, the Information tag also contains the iDRAC secure default password.

NOTE: For more information, see the *Dell EMC PowerEdge R550 Technical Specifications* on the product documentation page.

Left control panel view

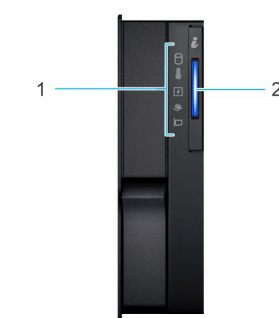

Figure 4. Left control panel without optional iDRAC Quick Sync 2 indicator

Table 4. Left control panel without optional iDRAC Quick Sync 2 indicator

Item	Indicator, button, or connector	Icon	Description
1	Status LED indicators	N/A	Indicates the status of the system. For more information, see the Status LED indicators section.
2	System health and system ID indicator		Indicates the system health. For more information, see the System health and system ID indicator codes section.

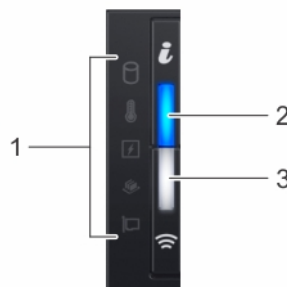

Figure 5. Left control panel with optional iDRAC Quick Sync 2 indicator

Table 5. Left control panel with optional iDRAC Quick Sync 2 indicator

Item	Indicator, button, or connector	Icon	Description
1	Status LED indicators	N/A	Indicates the status of the system. For more information, see the Status LED indicators section.
2	System health and system ID indicator		Indicates the system health. For more information, see the System health and system ID indicator codes section.

Table 5. Left control panel with optional iDRAC Quick Sync 2 indicator (continued)

Item	Indicator, button, or connector	Icon	Description
3	iDRAC Quick Sync 2 wireless indicator (optional)	☰	Indicates if the iDRAC Quick Sync 2 wireless option is activated. The Quick Sync 2 feature allows management of the system using mobile devices. This feature aggregates hardware/firmware inventory and various system level diagnostic/error information that can be used in troubleshooting the system. You can access system inventory, Dell Lifecycle Controller logs or system logs, system health status, and also configure iDRAC, BIOS, and networking parameters. You can also launch the virtual Keyboard, Video, and Mouse (KVM) viewer and virtual Kernel-based Virtual Machine (KVM), on a supported mobile device. For more information, see the Integrated Dell Remote Access Controller User's Guide at www.dell.com/poweredge manuals .

NOTE: For more information about the indicator codes, see the [System diagnostics and indicator codes](#) section.

Right control panel view



Figure 6. Right control panel view

Table 6. Right control panel

Item	Indicator or button	Icon	Description
1	Power button	⏻	Indicates if the system is powered on or off. Press the power button to manually power on or off the system. NOTE: Press the power button to gracefully shut down the ACPI-compliant operating system.
2	USB 2.0-compliant port	🔌	The USB port is a 4-pin connector and 2.0-compliant. This port enables you to connect USB devices to the system.
3	iDRAC Direct port (Micro-AB USB)	🔌	The iDRAC Direct port (Micro-AB USB) enables you to access the iDRAC Direct Micro-AB features. For more information, see the <i>Integrated Dell Remote Access Controller User's Guide</i> available at https://www.dell.com/idracmanuals . NOTE: You can configure iDRAC Direct by using a USB to micro USB (type AB) cable, which you can connect to your laptop or tablet. Cable length should not exceed 3 feet (0.91 meters). Performance could be affected by cable quality.
4	VGA port	📺	Enables you to connect a display device to the system.

NOTE: For more information, see the *Dell EMC PowerEdge R550 Technical Specifications* on the product documentation page.

Rear view of the system

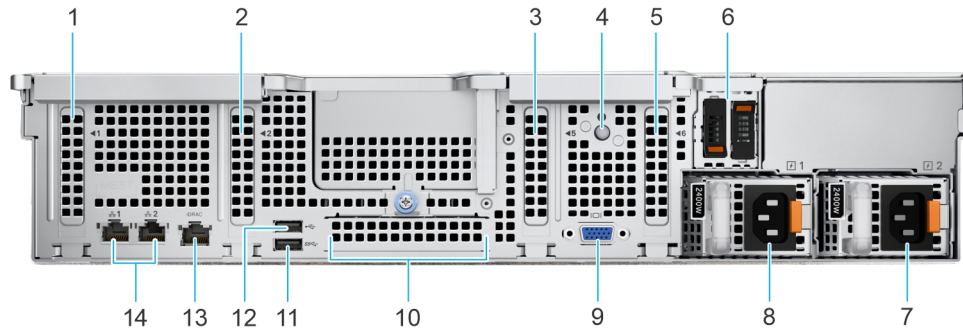



Figure 7. Rear view of the system

Table 7. Rear view of the system

Item	Ports, panels, or slots	Icon	Description
1	PCIe expansion card slot 1	N/A	Enables you to connect PCI Express expansion cards.
2	PCIe expansion card slot 2	N/A	Enables you to connect PCI Express expansion cards.
3	PCIe expansion card slot 5	N/A	Enables you to connect PCI Express expansion cards.
4	System identification button		<p>Press the system ID button:</p> <ul style="list-style-type: none"> To locate a particular system within a rack. To turn the system ID on or off. <p>To reset iDRAC, press and hold the button for more than 16 seconds.</p> <p>NOTE:</p> <ul style="list-style-type: none"> To reset iDRAC using system ID, ensure that the system ID button is enabled in the iDRAC setup. If the system stops responding during POST, press and hold the system ID button (for more than 5 seconds) to enter the BIOS progress mode.
5	PCIe expansion card slot 6	N/A	Enables you to connect PCI Express expansion cards.
6	BOSS S2 module	N/A	Enables you to connect BOSS S2 module.
7	Power supply unit (PSU 2)		Indicates the PSU 2.
8	Power supply unit (PSU 1)		Indicates the PSU 1.
9	VGA port		Enables you to connect a display device to the system.
10	OCP NIC port (optional)	N/A	This port supports OCP 3.0. The NIC ports are integrated on the OCP card which is connected to the system board.
11	USB 3.0 port		This port is USB 3.0-compliant.
12	USB 2.0 port		This port is USB 2.0-compliant.

Table 7. Rear view of the system (continued)

Item	Ports, panels, or slots	Icon	Description
13	iDRAC dedicated port		Enables you to remotely access iDRAC. For more information, see the iDRAC User's Guide at www.dell.com/poweredgemanuals
14	NIC ports (1, 2)		The NIC ports are embedded on the LOM card that is connected to the system board to provide network connectivity. These NIC ports can also be shared with iDRAC when iDRAC network settings is set to shared mode.

NOTE: For more information, see the *Dell EMC PowerEdge R550 Technical Specifications* on the product documentation page.

Inside the system

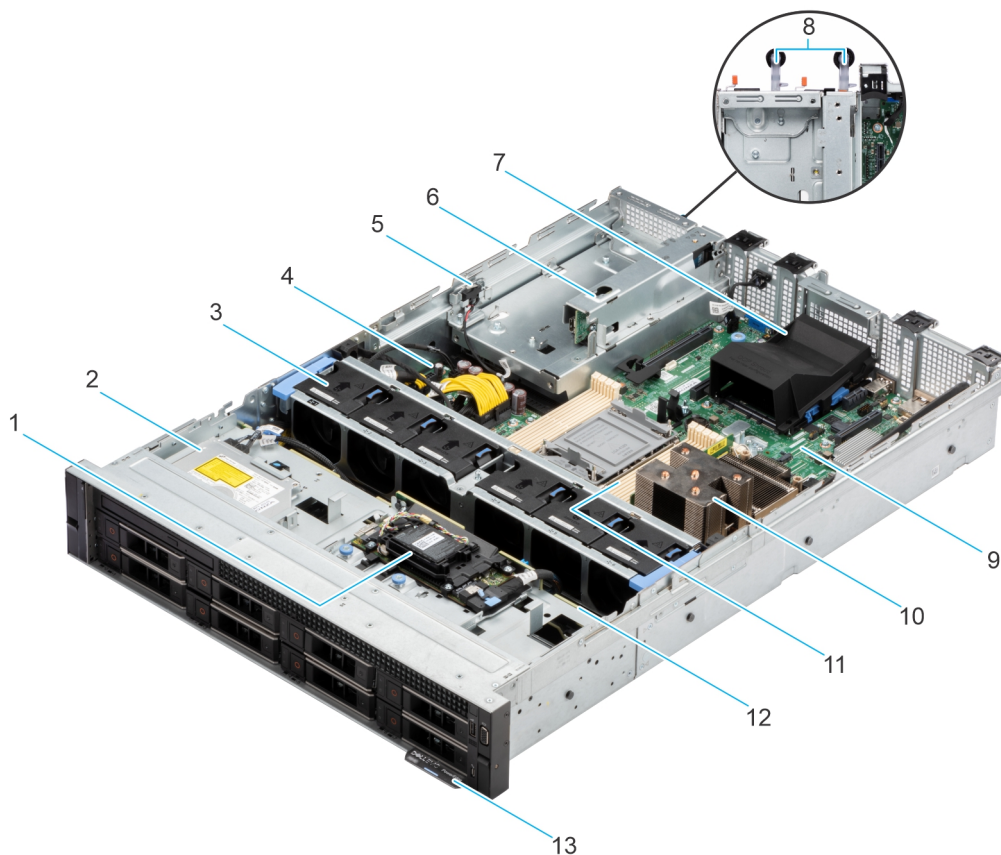

Figure 8. Inside the system

- | | |
|-------------------------|------------------------------------|
| 1. Front PERC | 2. Optical disk drive (ODD) |
| 3. Cooling fan | 4. Power interposer board |
| 5. Intrusion switch | 6. BOSS module tray |
| 7. OCP | 8. PSU 1 and PSU 2 |
| 9. System board | 10. Processor and heat sink module |
| 11. Memory module slots | 12. Backplane |
| 13. Information tag | |

Locating the Express Service Code and Service Tag

The unique Express Service Code and Service Tag are used to identify the system.

The information tag is located on the front of the system that includes system information such as the Service Tag, Express Service Code, Manufacture date, NIC, MAC address, QRL label, and so on. If you have opted for the secure default access to iDRAC, the Information tag also contains the iDRAC secure default password. If you have opted for iDRAC Quick Sync 2, the Information tag also contains the OpenManage Mobile (OMM) label, where administrators can configure, monitor, and troubleshoot the PowerEdge servers.

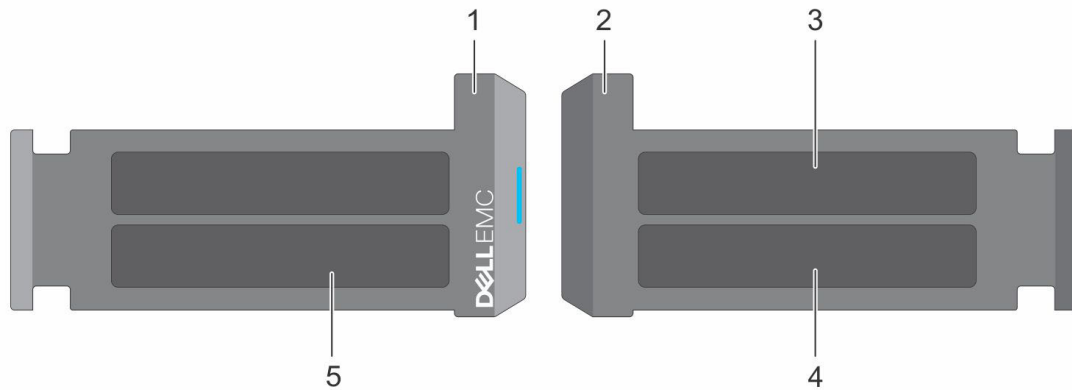

Figure 9. Locating the Express Service Code and Service tag

1. Information tag (front view)
2. Information tag (back view)
3. OpenManage Mobile (OMM) label
4. iDRAC MAC address and iDRAC secure password label
5. Service Tag, Express Service Code, QRL label

The Mini Enterprise Service Tag (MEST) label is located on the rear of the system that includes the Service Tag (ST), Express Service Code (Exp Svc Code), and Manufacture Date (Mfg. Date). The Exp Svc Code is used by Dell EMC to route support calls to the appropriate personnel.

Alternatively, the Service Tag information is located on a label on the left wall of the chassis.

System information label

The system information label is located on back of the system cover.

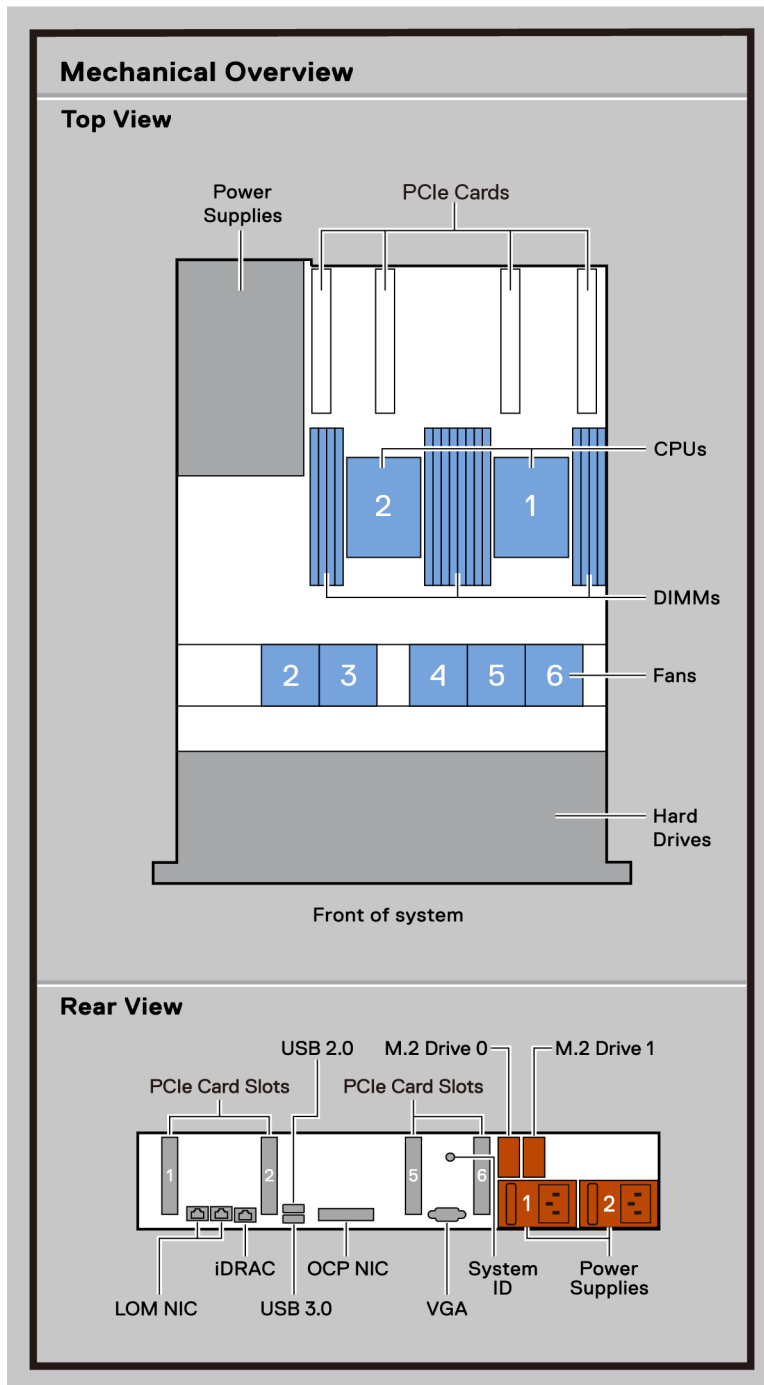

Figure 10. Service information

Service Information

Electrical Overview

System Board Connections

- | | | | |
|--|---|---|------------------------------------|
| 1 System ID Connector | 11 TPM Connector | 21 Right Control Panel | 30 System Power Connector 1 |
| 2 OCP NIC 3.0 Connector | 12 Coin Cell Battery | 22 PCIe Connector 3 (SL3_CPU1_PB2) | 31 PCIe Slot 6 (CPU 2) |
| 3 IDSDM / Internal USB Connector | 13 PCIe Connector 10 (SL10_PCH_PA5) | 23 System Power Connector 2 | 32 PCIe Slot 5 (CPU 2) |
| 4 Serial Port Connector | 14 ODD | 24 Left Control Panel | |
| 5 PCIe Slot 2 (PCH) | 15 DIMMs for CPU 2 Channels E, F, G, H | 25 Fan Signal 1 | |
| 6 Front VGA | 16 CPU2 | 26 Fan Signal 2 | |
| 7 PCH | 17 DIMMs for CPU 2 Channels A, B, C, D | 27 PIB Signal 1 | |
| 8 Jumper | 18 DIMMs for CPU 1 Channels E, F, G, H | 28 PIB Signal 2 | |
| 9 PCIe Slot 1 (CPU 1) | 19 CPU1 | 29 Intrusion Switch Connector | |
| 10 SATA Connector 9 (SL9_PCH_SA1) | 20 DIMMs for CPU 1 Channels A, B, C, D | | |

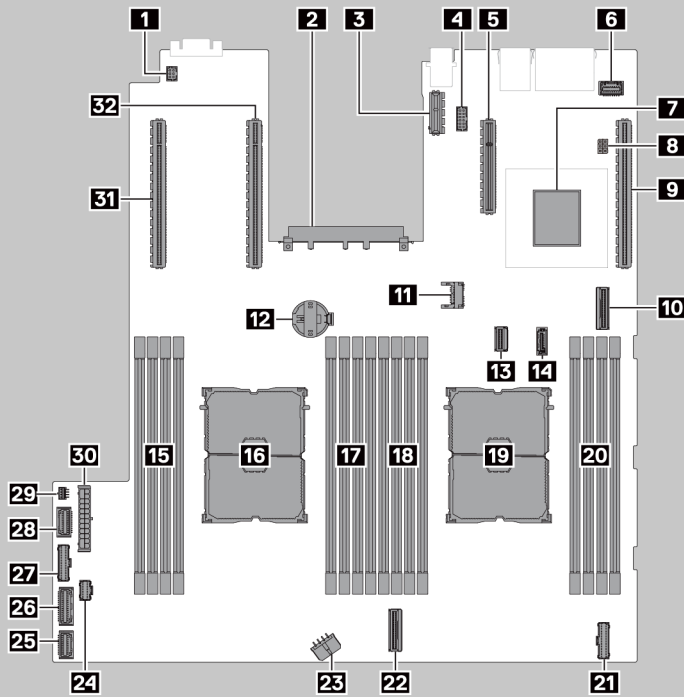

Jumper Settings





Jumper	Setting	Description
PWRD_EN ↓ 	 (default)	BIOS password is enabled.
		BIOS password is disabled. iDRAC local access is unlocked at next AC power cycle. iDRAC password reset is enabled in F2 iDRAC settings menu.
↑ NVRAM_CLR	 (default)	BIOS configuration settings retained at system boot.
		BIOS configuration settings cleared at system boot.

Figure 11. Service information

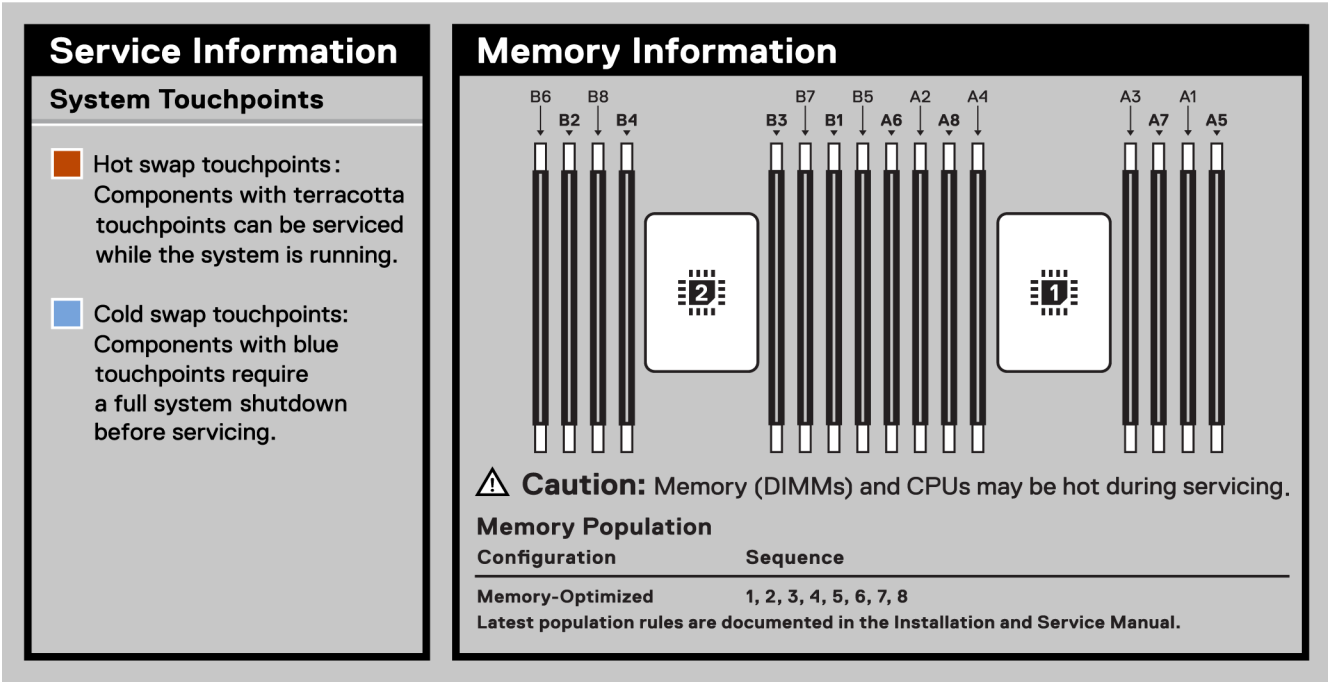

Figure 12. Memory information

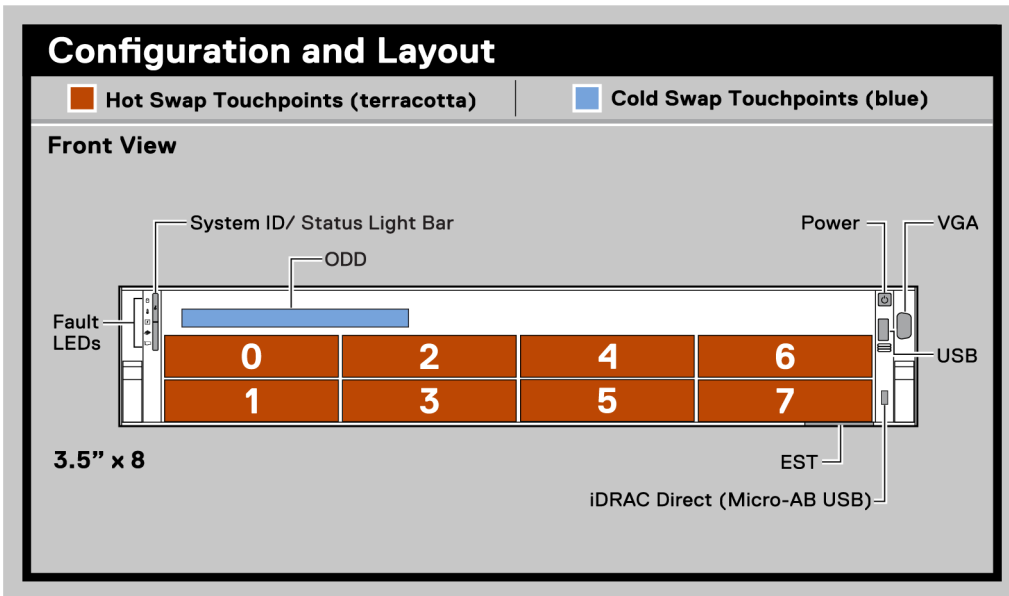

Figure 13. Configuration and layout

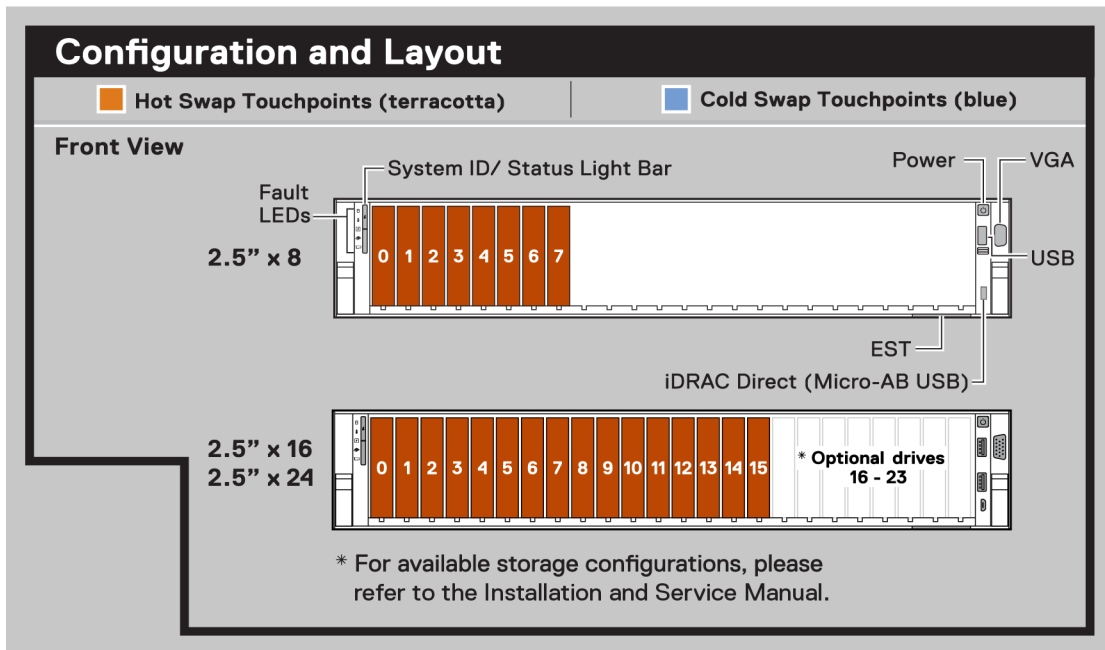

Figure 14. Configuration and layout

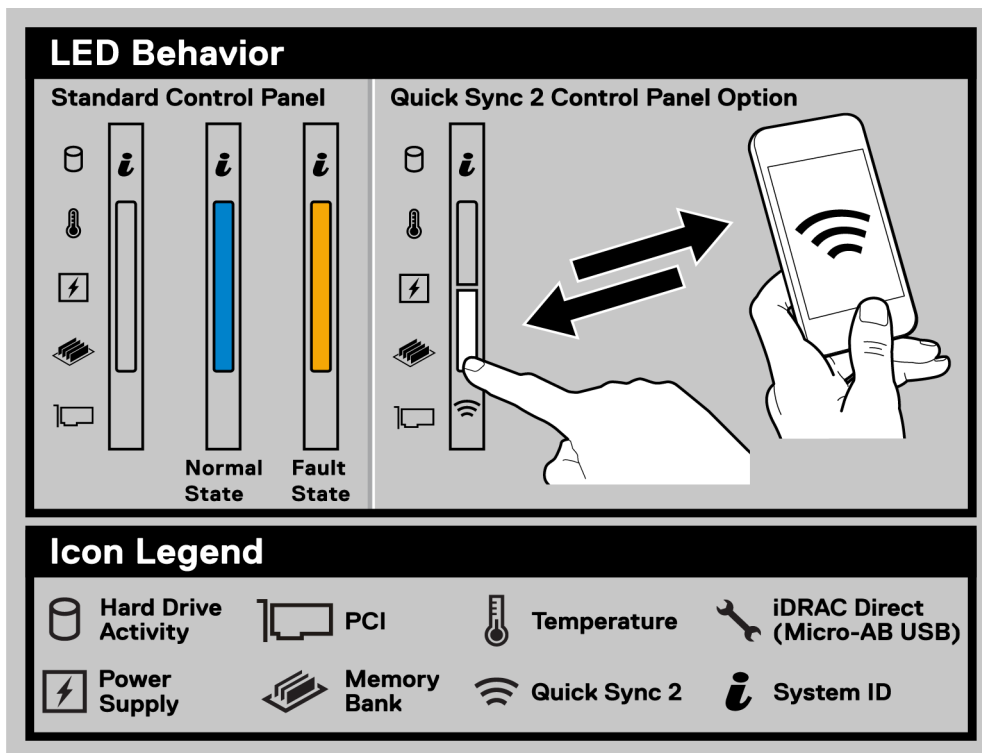

Figure 15. LED behavior

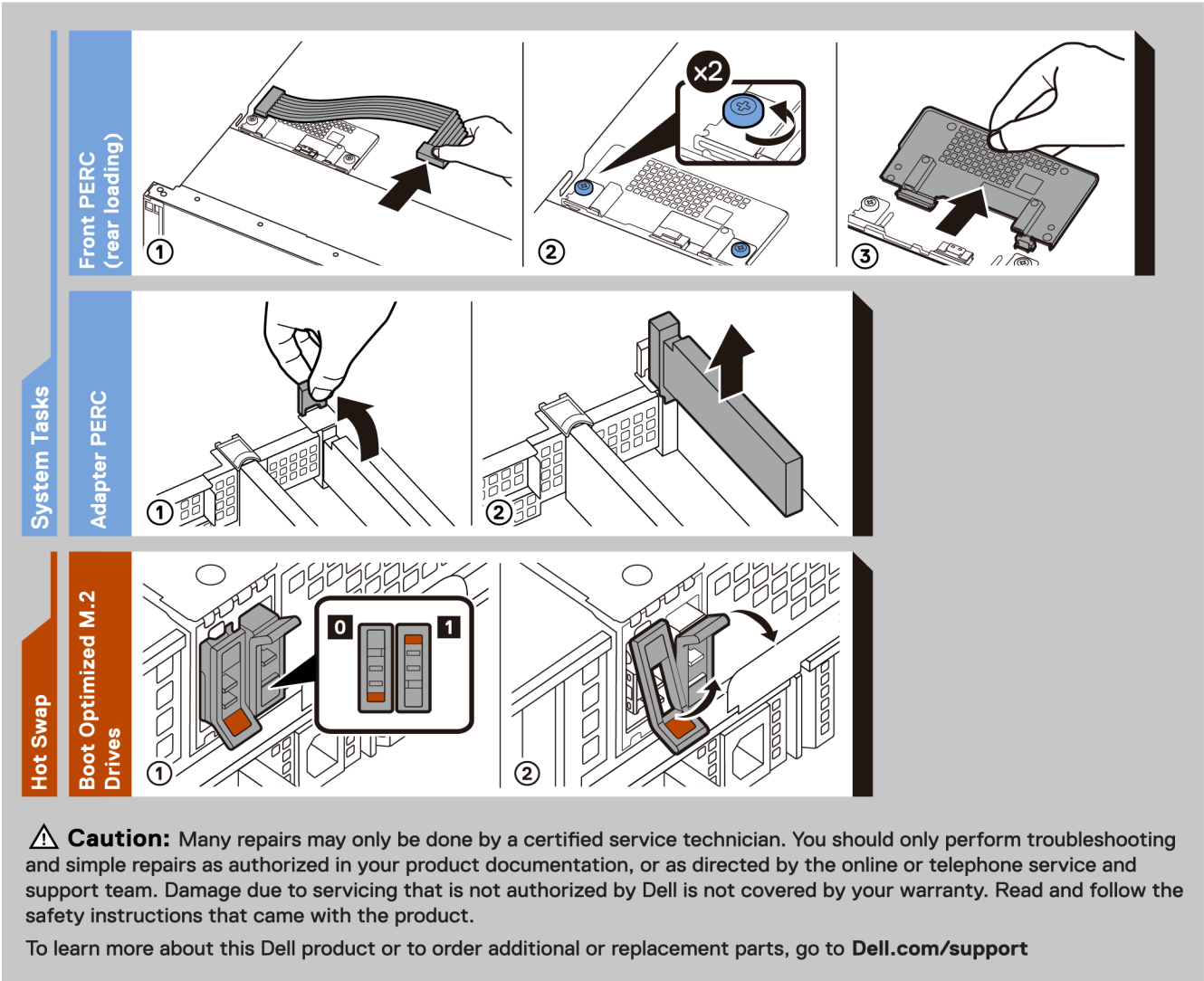

Figure 16. System tasks

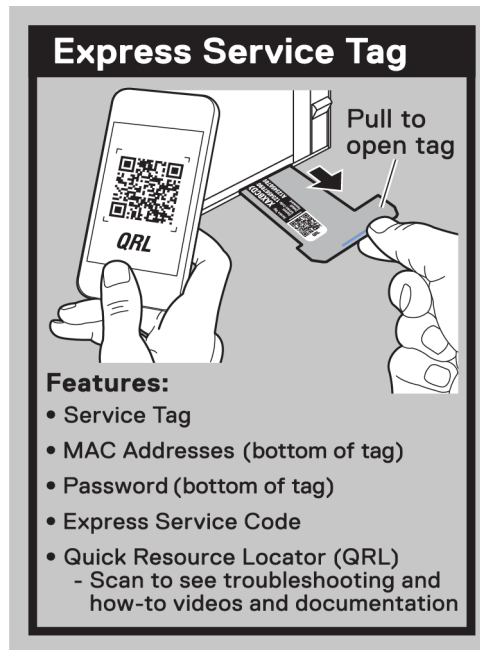

Figure 17. Express service tag

Rail sizing and rack compatibility matrix

For specific information about the rail solutions compatible with your system, see the *Dell EMC Enterprise Systems Rail Sizing and Rack Compatibility Matrix* available at https://i.dell.com/sites/csdocuments/Business_solutions_engineering-Docs_Documents/en/rail-rack-matrix.pdf.

The document provides the information that is listed below:

- Specific details about rail types and their functionalities.
- Rail adjustability range for various types of rack mounting flanges.
- Rail depth with and without cable management accessories.
- Types of racks supported for various types of rack mounting flanges.

Initial system setup and configuration

This section describes the tasks for initial setup and configuration of the Dell EMC system. The section also provides general steps to set up the system and the reference guides for detailed information.

Topics:

- [Setting up the system](#)
- [iDRAC configuration](#)
- [Resources to install operating system](#)

Setting up the system

Perform the following steps to set up the system:

Steps

1. Unpack the system.
2. Install the system into the rack. For more information, see the rail installation and cable management accessory guides relevant to your rail and cable management solution at www.dell.com/poweredgemanuals.
3. Connect the peripherals to the system and the system to the electrical outlet.
4. Power on the system.

For more information about setting up the system, see the *Getting Started Guide* that is shipped with your system.

 **NOTE:** For information about managing the basic settings and features of the system, see the *Dell EMC PowerEdge R550 BIOS and UEFI Reference Guide* on the product documentation page.

iDRAC configuration

The Integrated Dell Remote Access Controller (iDRAC) is designed to make you more productive as a system administrator and improve the overall availability of Dell EMC servers. iDRAC alerts you to system issues, helps you to perform remote management, and reduces the need for physical access to the system.

Options to set up iDRAC IP address

To enable communication between your system and iDRAC, you must first configure the network settings based on your network infrastructure. The network settings option is set to **DHCP**, by default.

 **NOTE:** For static IP configuration, you must request for the settings at the time of purchase.

You can set up the iDRAC IP address using one of the interfaces in the table below. For information about setting up iDRAC IP address, see the documentation links provided in the table below.

Table 8. Interfaces to set up iDRAC IP address

Interface	Documentation links
iDRAC Settings utility	<i>Integrated Dell Remote Access Controller User's Guide</i> at https://www.dell.com/idracmanuals or for system specific <i>Integrated Dell Remote Access Controller User's Guide</i> , go to https://www.dell.com/poweredgemanuals > Product Support page of your system > Documentation .

Table 8. Interfaces to set up iDRAC IP address (continued)

Interface	Documentation links
	<p>i NOTE: To determine the most recent iDRAC release for your platform and for latest documentation version, see KB article https://www.dell.com/support/article/sln308699.</p>
OpenManage Deployment Toolkit	<p><i>Dell EMC OpenManage Deployment Toolkit User's Guide</i> available at https://www.dell.com/openmanagemanuals > Open Manage Deployment Toolkit.</p>
iDRAC Direct	<p><i>Integrated Dell Remote Access Controller User's Guide</i> at https://www.dell.com/idracmanuals or for system specific <i>Integrated Dell Remote Access Controller User's Guide</i>, go to https://www.dell.com/poweredgemanuals > Product Support page of your system > Documentation.</p> <p>i NOTE: To determine the most recent iDRAC release for your platform and for latest documentation version, see KB article https://www.dell.com/support/article/sln308699.</p>
Lifecycle Controller	<p><i>Dell Lifecycle Controller User's Guide</i> at https://www.dell.com/idracmanuals or for system specific <i>Dell Lifecycle Controller User's Guide</i>, go to https://www.dell.com/poweredgemanuals > Product Support page of your system > Documentation.</p> <p>i NOTE: To determine the most recent iDRAC release for your platform and for latest documentation version, see KB article https://www.dell.com/support/article/sln308699.</p>
Server LCD panel	<p>LCD panel section.</p>
iDRAC Direct and Quick Sync 2 (optional)	<p><i>Integrated Dell Remote Access Controller User's Guide</i> at https://www.dell.com/idracmanuals or for system specific <i>Integrated Dell Remote Access Controller User's Guide</i>, go to https://www.dell.com/poweredgemanuals > Product Support page of your system > Documentation.</p> <p>i NOTE: To determine the most recent iDRAC release for your platform and for latest documentation version, see KB article https://www.dell.com/support/article/sln308699.</p>

i **NOTE:** To access iDRAC, ensure that you connect the ethernet cable to the iDRAC dedicated network port or use the iDRAC Direct port by using the USB cable. You can also access iDRAC through the shared LOM mode, if you have opted for a system that has the shared LOM mode enabled.

Options to log in to iDRAC

To log in to the iDRAC Web User Interface, open a browser and enter the IP address.

You can log in to iDRAC as:

- iDRAC user
- Microsoft Active Directory user
- Lightweight Directory Access Protocol (LDAP) user

In the login screen displayed, if you have opted for secure default access to iDRAC, enter the iDRAC secure default password available on back of the Information Tag. If you have not opted for secure default access to iDRAC, enter the default user name and password – `root` and `calvin`. You can also log in by using your Single Sign-On or Smart Card.

NOTE: Ensure that you change the default username and password after setting up the iDRAC IP address.

For more information about logging in to the iDRAC and iDRAC licenses, see the latest *Integrated Dell Remote Access Controller User's Guide* at www.dell.com/idracmanuals.

NOTE: To determine the most recent iDRAC release for your platform and for latest documentation version, see KB article <https://www.dell.com/support/article/sln308699>.

You can also access iDRAC using command-line protocol - RACADM. For more information, see the *Integrated Dell Remote Access Controller RACADM CLI Guide* available at <https://www.dell.com/idracmanuals>.

You can also access iDRAC using automation tool - Redfish API. For more information, see the *Integrated Dell Remote Access Controller User's Guide Redfish API Guide* available at <https://developer.dell.com>.

Resources to install operating system

If the system is shipped without an operating system, you can install a supported operating system by using one of the resources provided in the table below. For information about how to install the operating system, see the documentation links provided in the table below.

Table 9. Resources to install the operating system

Resource	Documentation links
iDRAC	<i>Integrated Dell Remote Access Controller User's Guide</i> at https://www.dell.com/idracmanuals or for system specific <i>Integrated Dell Remote Access Controller User's Guide</i> , go to https://www.dell.com/poweredgemanuals > Product Support page of your system > Documentation . NOTE: To determine the most recent iDRAC release for your platform and for latest documentation version, see KB article at https://www.dell.com/support/article/sln308699 .
Lifecycle Controller	<i>Dell Lifecycle Controller User's Guide</i> at https://www.dell.com/idracmanuals or for system specific <i>Dell Lifecycle Controller User's Guide</i> , go to https://www.dell.com/poweredgemanuals > Product Support page of your system > Documentation . Dell recommends using Lifecycle Controller to install the OS, since all required drivers are installed on the system. NOTE: To determine the most recent iDRAC release for your platform and for latest documentation version, see KB article at https://www.dell.com/support/article/sln308699 .
OpenManage Deployment Toolkit	www.dell.com/openmanagemanuals > OpenManage Deployment Toolkit
Dell certified VMware ESXi	www.dell.com/virtualizationsolutions

NOTE: For more information about installation and how-to videos for operating systems supported on PowerEdge systems, see [Supported Operating Systems for Dell EMC PowerEdge systems](#).

Options to download firmware

You can download firmware from the Dell support site. For information about downloading firmware, see the [Downloading drivers and firmware](#) section.

You can also choose any one of the following options to download the firmware. For information about how to download the firmware, see the documentation links provided in the table below.

Table 10. Options to download firmware

Option	Documentation link
Using Integrated Dell Remote Access Controller Lifecycle Controller (iDRAC with LC)	www.dell.com/idracmanuals
Using Dell Repository Manager (DRM)	www.dell.com/openmanagemanuals > Repository Manager
Using Dell Server Update Utility (SUU)	www.dell.com/openmanagemanuals > Server Update Utility

Table 10. Options to download firmware (continued)

Option	Documentation link
Using Dell OpenManage Deployment Toolkit (DTK)	www.dell.com/openmanagemanuals > OpenManage Deployment Toolkit
Using iDRAC virtual media	www.dell.com/idracmanuals

Options to download and install OS drivers

You can choose any one of the following options to download and install OS drivers. For information about how to download or install OS drivers, see the documentation links provided in the table below.

Table 11. Options to download and install OS drivers

Option	Documentation
Dell EMC support site	Downloading drivers and firmware section.
iDRAC virtual media	<i>Integrated Dell Remote Access Controller User's Guide</i> at https://www.dell.com/idracmanuals or for system specific <i>Integrated Dell Remote Access Controller User's Guide</i> , go to https://www.dell.com/poweredgemanuals > Product Support page of your system > Documentation .  NOTE: To determine the most recent iDRAC release for your platform and for latest documentation version, see https://www.dell.com/support/article/sln308699 .

Downloading drivers and firmware

It is recommended that you download and install the latest BIOS, drivers, and systems management firmware on the system.

Prerequisites

Ensure that you clear the web browser cache before downloading the drivers and firmware.

Steps

1. Go to www.dell.com/support/drivers.
2. Enter the Service Tag of the system in the **Enter a Dell Service Tag, Dell EMC Product ID or Model** field, and then press Enter.

 **NOTE:** If you do not have the Service Tag, click **Browse all products**, and navigate to your product.

3. On the displayed product page, click **Drivers & Downloads**.
On the **Drivers & Downloads** page, all drivers that are applicable to the system are displayed.
4. Download the drivers to a USB drive, CD, or DVD.

Minimum to POST and system management configuration validation

This section describes the minimum to POST system requirement and system management configuration validation of the Dell EMC system.

Topics:

- [Minimum configuration to POST](#)
- [Configuration validation](#)

Minimum configuration to POST

The components listed below are the minimum configuration to POST:

- One power supply unit
- System board
- One processor in socket processor 1
- Power Interposer Board (PIB) and cables
- One memory module (DIMM) installed in the socket A1

Configuration validation

The new generation of PowerEdge systems have added interconnect flexibility and advanced iDRAC management features to collect precise system configuration information and report configuration errors.

When the system is powered on, information about installed cables, backplanes, floating card (fPERCl like BOSS), and processor is obtained from the CPLD and backplane memory maps is analyzed. This information forms a unique configuration, which is compared with one of the qualified configurations stored in a table maintained by iDRAC.

One or more sensors are assigned to each of the configuration elements. During POST, any configuration validation error is logged in the System Event Log (SEL)/LifeCycle (LC) log. The reported events are categorized in the configuration validation error table.

Table 12. Configuration validation error

Error	Description	Possible cause and recommendations	Example
Config Error	A configuration element within the closest match contains something that is unexpected and does not match any Dell qualified configuration.	Wrong configuration	Config Error: Backplane cable CTRS_SRC_SA1 and BP-DST_SA1
		The element reported in HWC8010 errors are assembled incorrectly. Verify element (cable, etc) placement in the system.	Config Error : SL Cable PLANAR_SL7 and CTRL_DST_PA1
Config Missing	iDRAC found a configuration element missing within the closest match detected.	Missing or damaged cable, device, or part	Config Missing: Float card front PERC/HBA
		Missing element or cable is reported in HWC8010 error logs. Install the	Config Missing : SL cable PLANAR_SL8 and CTRL_DST_PA1

Table 12. Configuration validation error (continued)

Error	Description	Possible cause and recommendations	Example
		missing element (cable, etc).	
Comm Error	A configuration element is not responding to iDRAC using the management interface while running an inventory check.	System management sideband communication Unplug AC Power, reseal the element and replace the element if the problem persists.	Comm Error: Backplane 2

Error messages

This section describes the error messages displayed on the screen during POST or captured in the system event log (SEL)/ LifeCycle (LC) log.

Table 13. Error message HWC8010

Error code	HWC8010
Message	The System Configuration Check operation resulted in the following issue involving the indicated component type
Arguments	Riser, floating card (fPERClike BOSS), backplane, processor, cable, or other components
Detailed Description	The issue identified in the message is observed in the System Configuration Check operation.
Recommended Response Action	Do the following and retry the operation: <ol style="list-style-type: none"> 1. Disconnect the input power. 2. Check for proper cable connection and component placement. If the issue persists, contact the service provider.
Category	System Health (HWC = Hardware Config)
Severity	Critical
Trap/EventID	2329

Table 14. Error message HWC8011

Error code	HWC8011
Message	The System Configuration Check operation resulted in multiple issues involving the indicated component type
Arguments	Riser, floating card (fPERClike BOSS), backplane, processor, cable, or other components
Detailed Description	Multiple issues are observed in the System Configuration Check operation.
Recommended Response Action	Do the following and retry the operation: <ol style="list-style-type: none"> 1. Disconnect the input power. 2. Check for proper cable connection and component placement. If the issue persists, contact the service provider.
Category	System Health (HWC = Hardware Config)
Severity	Critical

Installing and removing system components

Topics:

- Safety instructions
- Before working inside your system
- After working inside your system
- Recommended tools
- Optional front bezel
- System cover
- Drive backplane cover
- Air shroud
- Cooling fans
- Side wall brackets
- Intrusion switch module
- Optional serial COM port
- Drives
- Drive backplane
- Cable routing
- System memory
- Processor and heat sink module
- Expansion cards
- Optional IDSDM module
- Optional BOSS S2 card
- Front mounting front PERC module
- Optional OCP card
- System battery
- Optional internal USB card
- MicroSD card
- Power supply unit
- Power interposer board
- Cooling fan cage board
- System board
- Trusted Platform Module
- Control panel
- Optional optical drive

Safety instructions

 **NOTE:** Whenever you need to lift the system, get others to assist you. To avoid injury, do not attempt to lift the system by yourself.

 **CAUTION:** Ensure that two or more people lift the system horizontally from the box and place it on a flat surface, rack lift, or into the rails.

 **WARNING:** Opening or removing the system cover while the system is powered on may expose you to a risk of electric shock.

 **WARNING:** Do not operate the system without the cover for a duration exceeding five minutes. Operating the system without the system cover can result in component damage.

CAUTION: Many repairs may only be done by a certified service technician. You should only perform troubleshooting and simple repairs as authorized in your product documentation, or as directed by the online or telephone service and support team. Damage due to servicing that is not authorized by Dell is not covered by your warranty. Read and follow the safety instructions that are shipped with your product.

NOTE: It is recommended that you always use an antistatic mat and antistatic strap while working on components inside the system.

CAUTION: To ensure proper operation and cooling, all system bays and fans must always be populated with a component or a blank.

NOTE: While replacing the hot swappable PSU, after next server boot; the new PSU automatically updates to the same firmware and configuration of the replaced one. For updating to the latest firmware and changing the configuration, see the *Lifecycle Controller User's Guide* at <https://www.dell.com/idracmanuals>.

NOTE: While replacing faulty storage controller, FC, or NIC card with the same type of card, after you power on the system; the new card automatically updates to the same firmware and configuration of the faulty one. For updating to the latest firmware and changing the configuration, see the *Lifecycle Controller User's Guide* at <https://www.dell.com/idracmanuals>.

CAUTION: Do not install GPUs, network cards, or other PCIe devices on your system that are not validated and tested by Dell. Damage caused by unauthorized and invalidated hardware installation will null and void the system warranty.

Before working inside your system

Prerequisites

Follow the safety guidelines listed in the [Safety instructions](#).

Steps

1. Power off the system and all attached peripherals.
2. Disconnect the system from the electrical outlet, and disconnect the peripherals.
3. If applicable, remove the system from the rack.
For more information, see the *Rail Installation Guide* relevant to your rail solutions at www.dell.com/poweredge manuals.
4. Remove the system cover.

After working inside your system

Prerequisites

Follow the safety guidelines listed in [Safety instructions](#).

Steps

1. Replace the system cover.
2. If applicable, install the system into the rack.
For more information, see the *Rail Installation Guide* relevant to your system at www.dell.com/poweredge manuals.
3. Reconnect the peripherals and connect the system to the electrical outlet, and then power on the system.

Recommended tools

You may need any or combination of the following tools to perform the removal and installation procedures:

- Key to the bezel lock. The key is required only if your system includes a bezel.
- Phillips 1 screwdriver

- Phillips 2 screwdriver
- Torx T30 screwdriver
- 5 mm hex nut screwdriver
- Plastic scribe
- 1/4-inch flat blade screwdriver
- Wrist grounding strap connected to the ground
- ESD mat
- Needle-nose pliers

You need the following tools to assemble the cables for a DC power supply unit:

- AMP 90871-1 hand-crimping tool or equivalent
- Tyco Electronics 58433-3 or equivalent
- Wire-stripper pliers to remove insulation from size 10 AWG solid or stranded, insulated copper wire

 **NOTE:** Use alpha wire part number 3080 or equivalent (65/30 stranding).

Optional front bezel

 **NOTE:** LCD panel is optional on the front bezel. If the front bezel has an LCD panel, see [LCD panel](#) section.

Removing the front bezel

The procedure to remove the front bezel with and without the LCD panel is the same.

Prerequisites

1. Follow the safety guidelines listed in the [Safety instructions](#).
2. Keep the bezel key handy.

 **NOTE:** The bezel key is part of the LCD bezel package.

Steps

1. Unlock the front bezel.
2. Press the release button, and disengage the left end of the bezel.
3. Unhook the right end, and remove the bezel.



Figure 18. Removing the front bezel with the LCD panel

Next steps

Replace the front bezel.

Installing the front bezel

The procedure to install the front bezel with and without the LCD panel is the same.

Prerequisites

1. Follow the safety guidelines listed in the [Safety instructions](#).
2. Locate and remove the bezel key.

NOTE: The bezel key is part of the LCD bezel package.

Steps

1. Align and insert the tabs on the bezel into the slots on the system.
2. Press the bezel until the release button clicks in place.
3. Lock the front bezel.

Figure 19. Installing the front bezel with the LCD panel

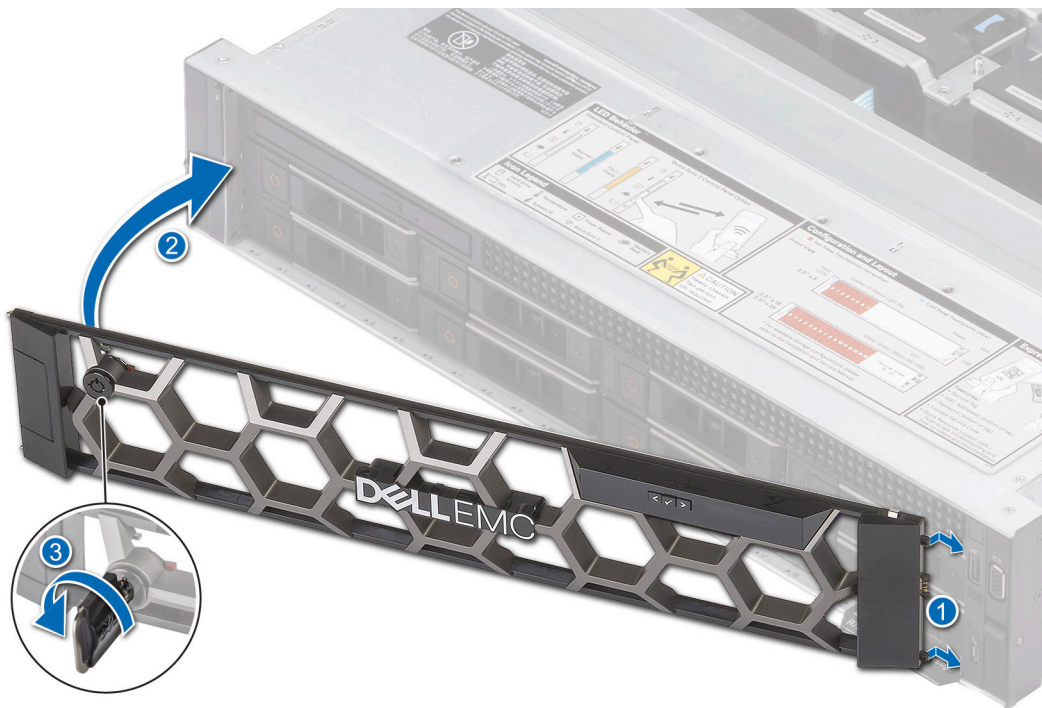

System cover

Removing the system cover

Prerequisites

1. Follow the safety guidelines listed in the [Safety instructions](#).
2. Power off the system, and any attached peripherals.
3. Disconnect the system from the electrical outlet and peripherals.

Steps

1. Using a 1/4-inch flat head or Phillips #2 screwdriver, rotate the lock counterclockwise to the unlock position.
2. Lift the release latch until the system cover slides back.
3. Lift the cover from the system.



Figure 20. Removing the system cover

Next steps

Replace the system cover.

Installing the system cover

Prerequisites

1. Follow the safety guidelines listed in the [Safety instructions](#).
2. Follow the procedure listed in [Before working inside your system](#).
3. Ensure that all internal cables are connected and routed properly, and no tools or extra parts are left inside the system.

Steps

1. Align the tabs on the system cover with the guide slots on the system.
2. Close the system cover release latch.
3. Using a 1/4-inch flat head or Phillips #2 screwdriver, rotate the lock clockwise to the lock position.



Figure 21. Installing the system cover

Next steps

Follow the procedure listed in [After working inside your system](#).

Drive backplane cover

Removing the drive backplane cover

Prerequisites

1. Follow the safety guidelines listed in the [Safety instructions](#).
2. Follow the procedure listed in the [Before working inside your system](#).

Steps

1. Slide the drive backplane cover in the direction of the arrows marked on the drive backplane cover.
2. Lift the drive backplane cover from the system.

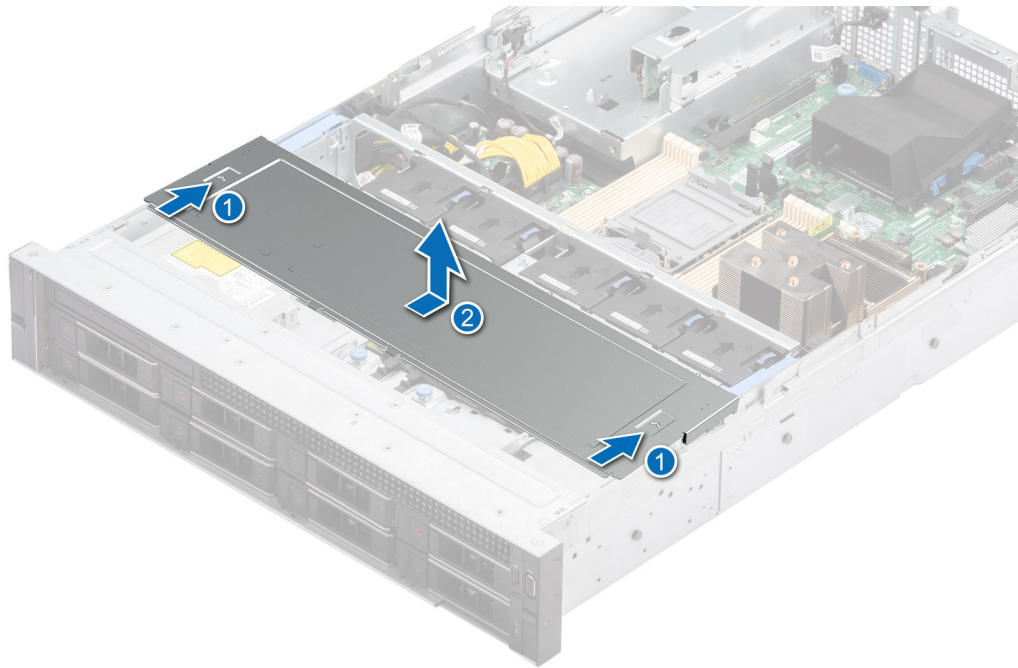

Figure 22. Removing the drive backplane cover

Next steps

Replace the drive backplane cover.

Installing the drive backplane cover

Prerequisites

1. Follow the safety guidelines listed in the [Safety instructions](#).
2. Follow the procedure listed in the [Before working inside your system](#).

Steps

1. Align the drive backplane cover with the guide slots on the system.
2. Slide the drive backplane cover toward the front of the system until the drive backplane cover fits into place.

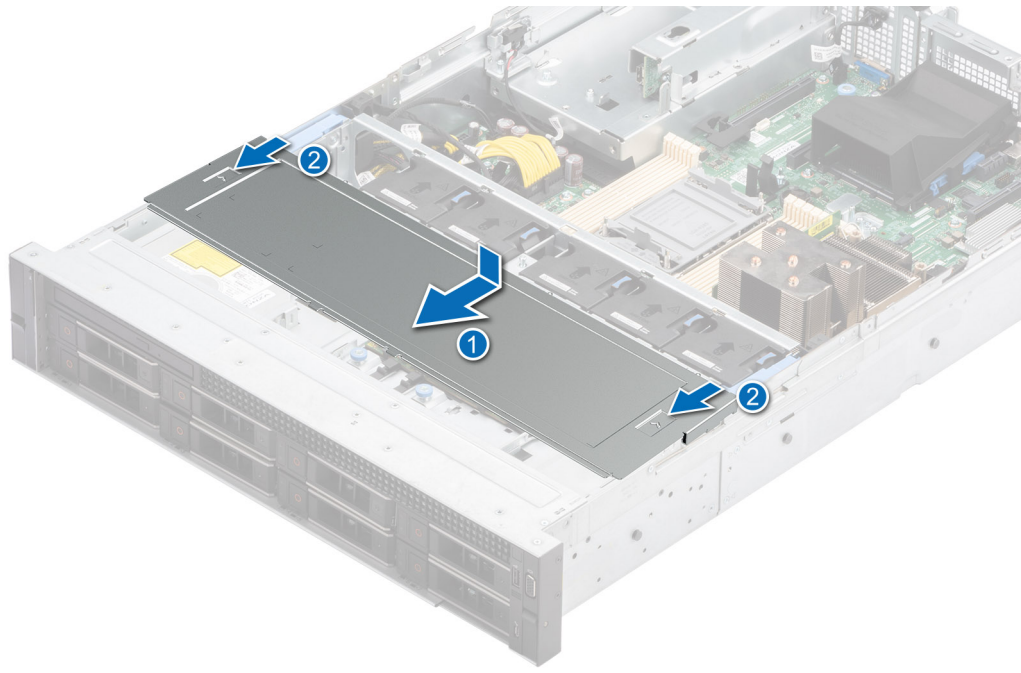

Figure 23. Installing the drive backplane cover

Next steps

Follow the procedure listed in [After working inside your system.](#)

Air shroud

Removing the air shroud

Prerequisites

CAUTION: Never operate your system with the air shroud removed. The system may get overheated quickly, resulting in shutdown of the system and loss of data.

1. Follow the safety guidelines listed in the [Safety instructions](#).
2. Follow the procedure listed in the [Before working inside your system](#).

Steps

Hold the air shroud at both ends and lift the air shroud out of the system.

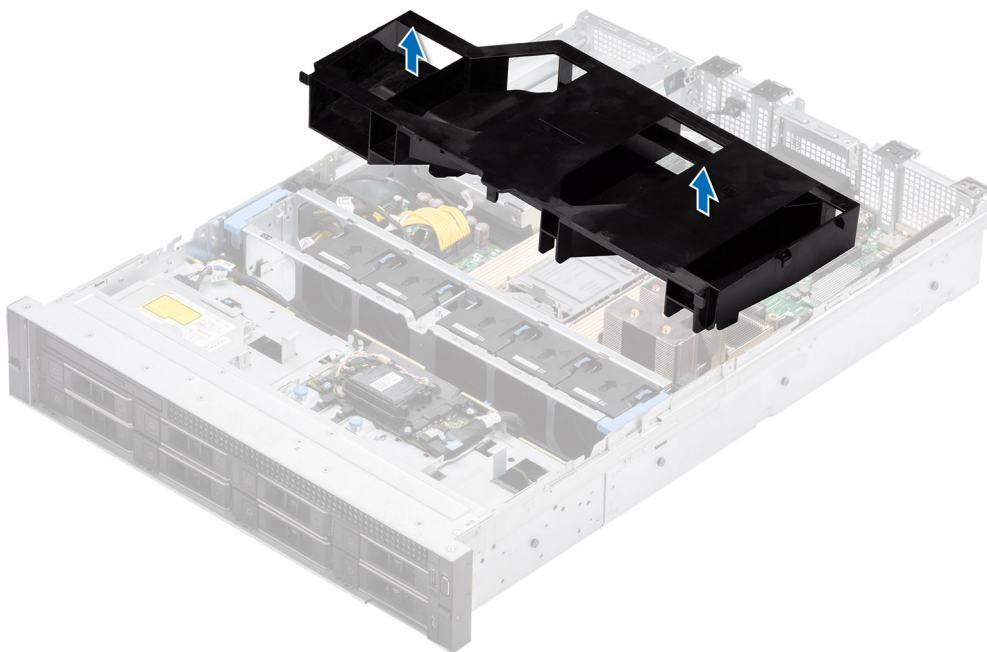

Figure 24. Removing the air shroud

Next steps

Replace the air shroud.

Installing the air shroud

Prerequisites

1. Follow the safety guidelines listed in the [Safety instructions](#).
2. Follow the procedure listed in the [Before working inside your system](#).

Steps

1. Align the slot on the air shroud with the standoff on the system.
2. Lower the air shroud into the system until it is firmly seated.

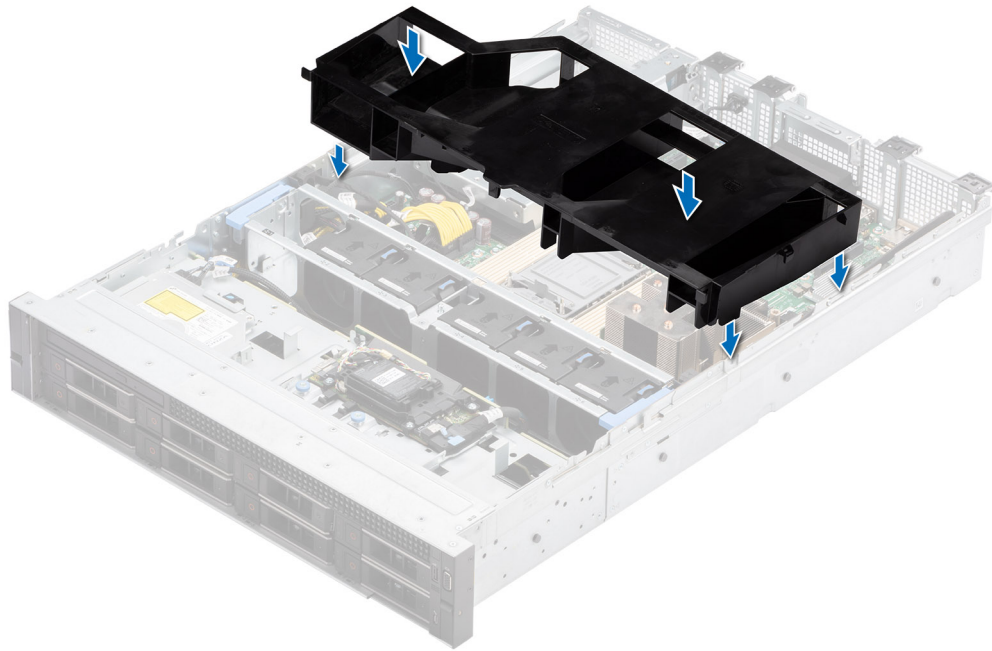

Figure 25. Installing the air shroud

Next steps

Follow the procedure listed in [After working inside your system](#).

Cooling fans

Removing the cooling fan cage assembly

Prerequisites

1. Follow the safety guidelines listed in the [Safety instructions](#).
2. Follow the procedure listed in the [Before working inside your system](#).
3. If installed, [remove the air shroud](#).

Steps

1. Lift the blue release levers to unlock the cooling fan cage from the system.
2. Hold the release levers, and lift the cooling fan cage away from the system.

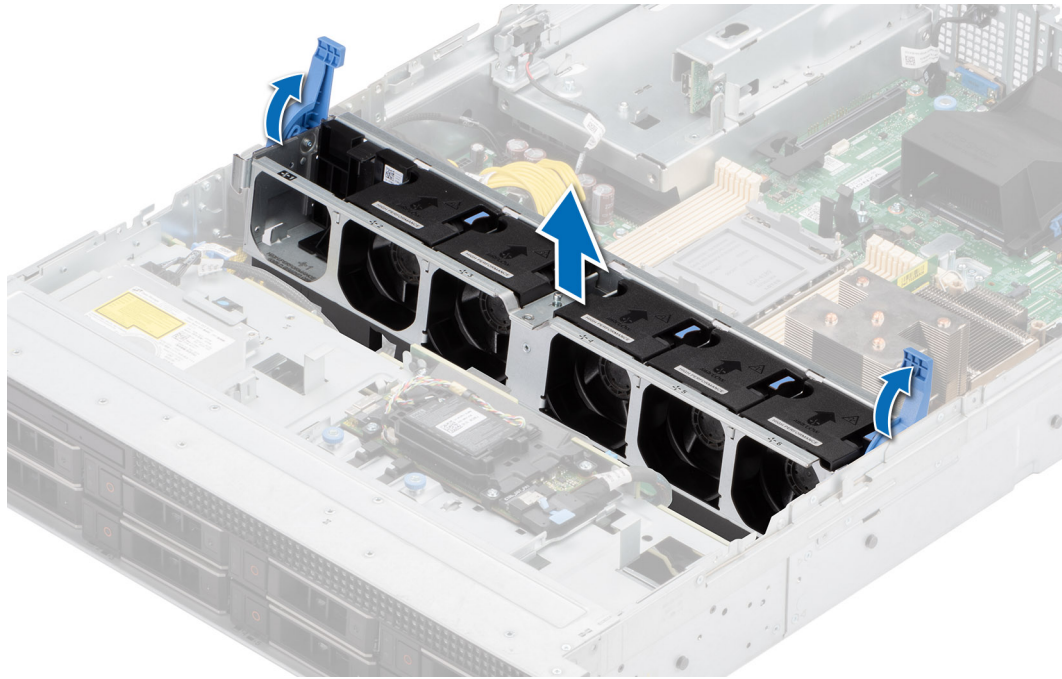

Figure 26. Removing the cooling fan cage assembly

Next steps

1. [Replace the cooling fan cage.](#)

Installing the cooling fan cage assembly

Prerequisites

1. Follow the safety guidelines listed in the [Safety instructions](#).



CAUTION: Ensure that the cables inside the system are correctly installed and retained by the cable retention bracket before installing the cooling fan cage assembly. Incorrectly installed cables may get damaged.

2. Follow the procedure listed in [Before working inside your system](#).
3. If installed, [remove the air shroud](#).

Steps

1. Align the guide rails on the cooling fan cage with the standoffs on the system.
2. Lower the cooling fan cage into the system.
3. Lower the blue release levers to lock the cooling fan cage into the system.

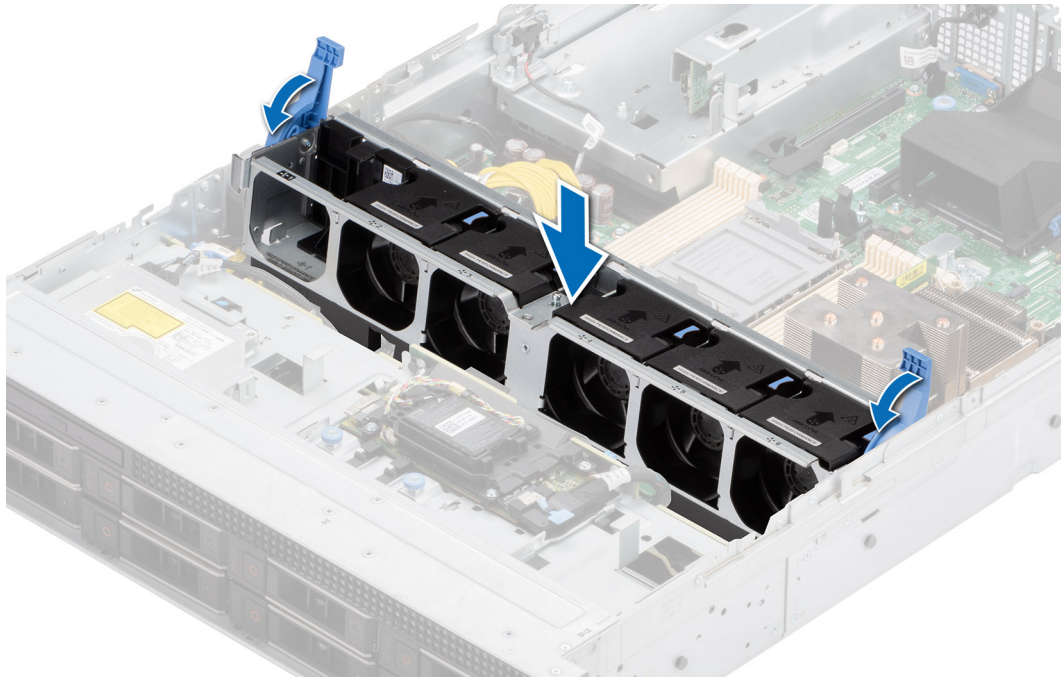

Figure 27. Installing the cooling fan cage assembly

Next steps

1. If removed, [Install the air shroud](#).
2. Follow the procedure listed in [After working inside your system](#).

Removing a cooling fan

Prerequisites

1. Follow the safety guidelines listed in the [Safety instructions](#).
2. Follow the procedure listed in the [Before working inside your system](#).

Steps

Press the blue release tab and lift the cooling fan to disconnect the fan from the connector on the cooling fan cage board.

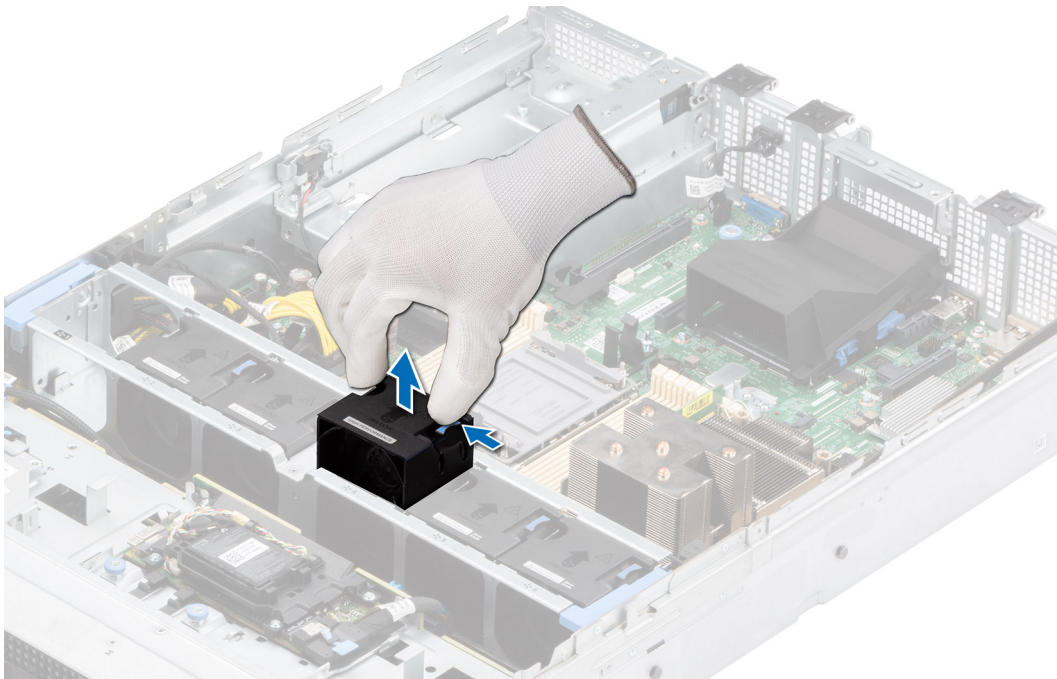

Figure 28. Removing a cooling fan

Next steps

Replace the cooling fan.

Installing a cooling fan

Prerequisites

1. Follow the safety guidelines listed in the [Safety instructions](#).
2. Follow the procedure listed in the [Before working inside your system](#).

Steps

Align and slide the cooling fan into the cooling fan cage until the fan clicks into place.

NOTE: Cooling fan is not installed in slot 1 of cooling fan cage assembly.

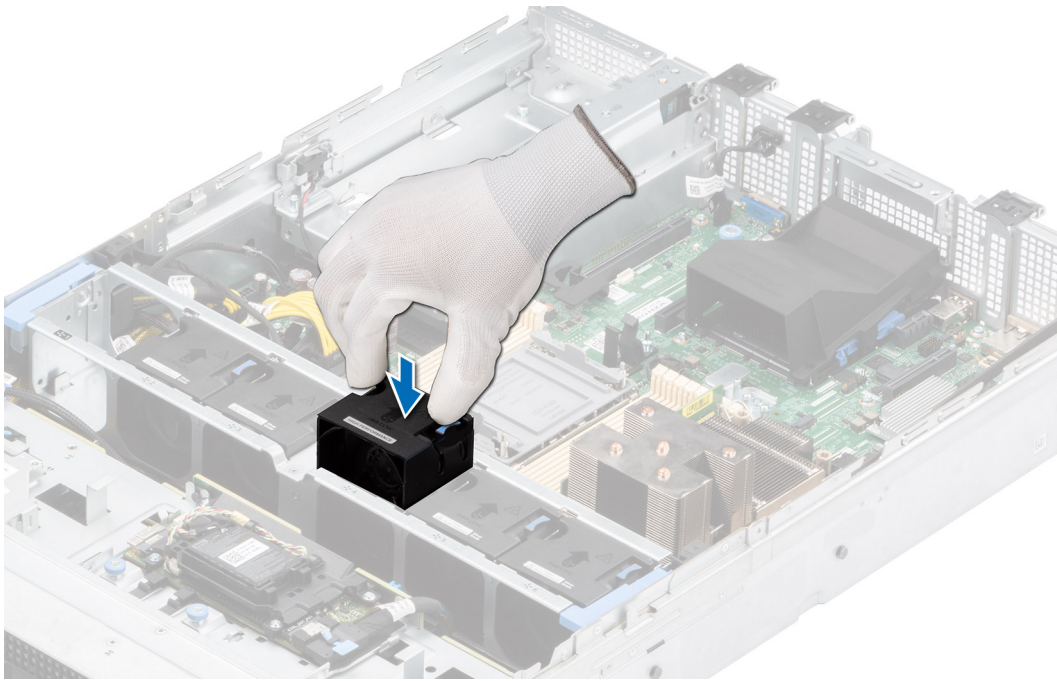

Figure 29. Installing a cooling fan

Next steps

Follow the procedure listed in [After working inside your system](#).

Side wall brackets

Removing the side wall bracket

There are two side wall brackets on either side of the system. The procedure to remove is similar.

Prerequisites

1. Follow the safety guidelines listed in the [Safety instructions](#).
2. Follow the procedure listed in the [Before working inside your system](#).
3. [Remove the air shroud](#).
4. [Remove the cooling fan cage assembly](#).

i **NOTE:** Ensure that you note the routing of the cables as you remove them from the system board. Route the cable properly when you replace it to prevent the cable from being pinched or crimped.

Steps

1. Press the tab to release the side wall bracket cover.
i **NOTE:** Unroute the cables to release them from the side wall bracket.
2. Release the bracket from the chassis, and lift it away from the system.

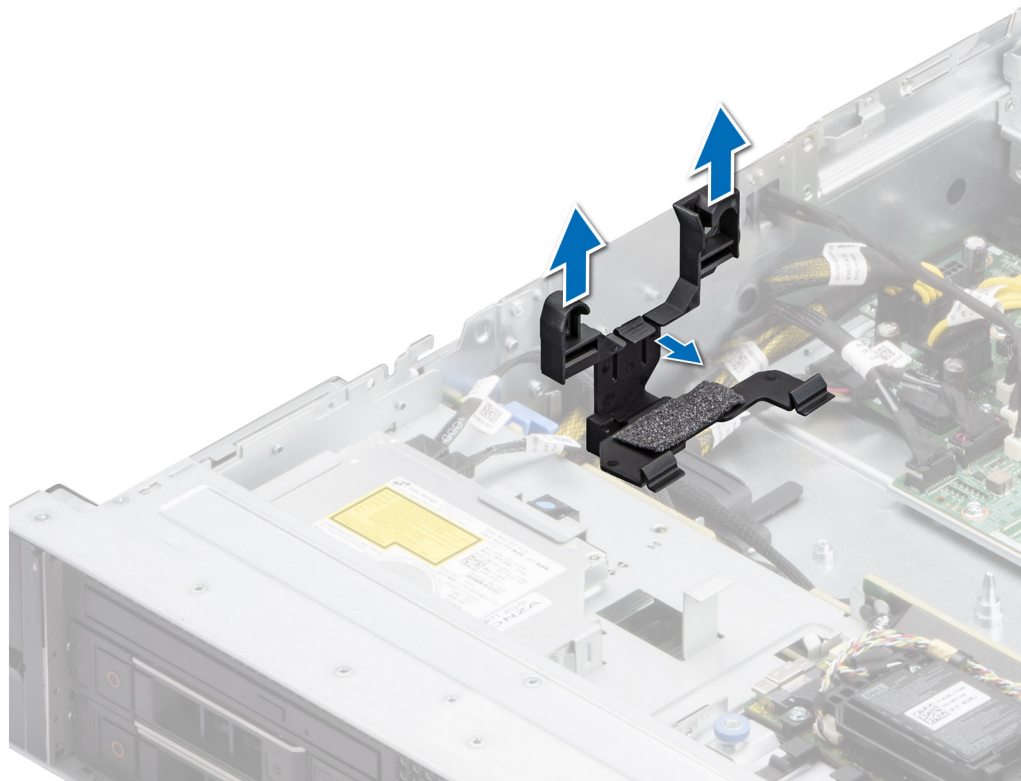

Figure 30. Removing the side wall bracket

Next steps

Replace the side wall bracket.

Installing the side wall bracket

There are two side wall brackets on either side of the system. The procedure to install is similar.

Prerequisites

1. Follow the safety guidelines listed in the [Safety instructions](#).
2. Follow the procedure listed in the [Before working inside your system](#).
3. If installed, [remove the air shroud](#).
4. [Remove the cooling fan cage assembly](#).

i **NOTE:** Ensure that you note the routing of the cables as you remove them from the system board. Route the cable properly when you replace it to prevent the cable from being pinched or crimped.

Steps

1. Align the side wall bracket with the tabs on the chassis.
2. Press the side wall bracket with your thumbs until the bracket firmly clicks into place.

i **NOTE:** Route the cables through the side wall bracket.

3. Close the side wall bracket cover with your thumbs until the cover firmly clicks into place.

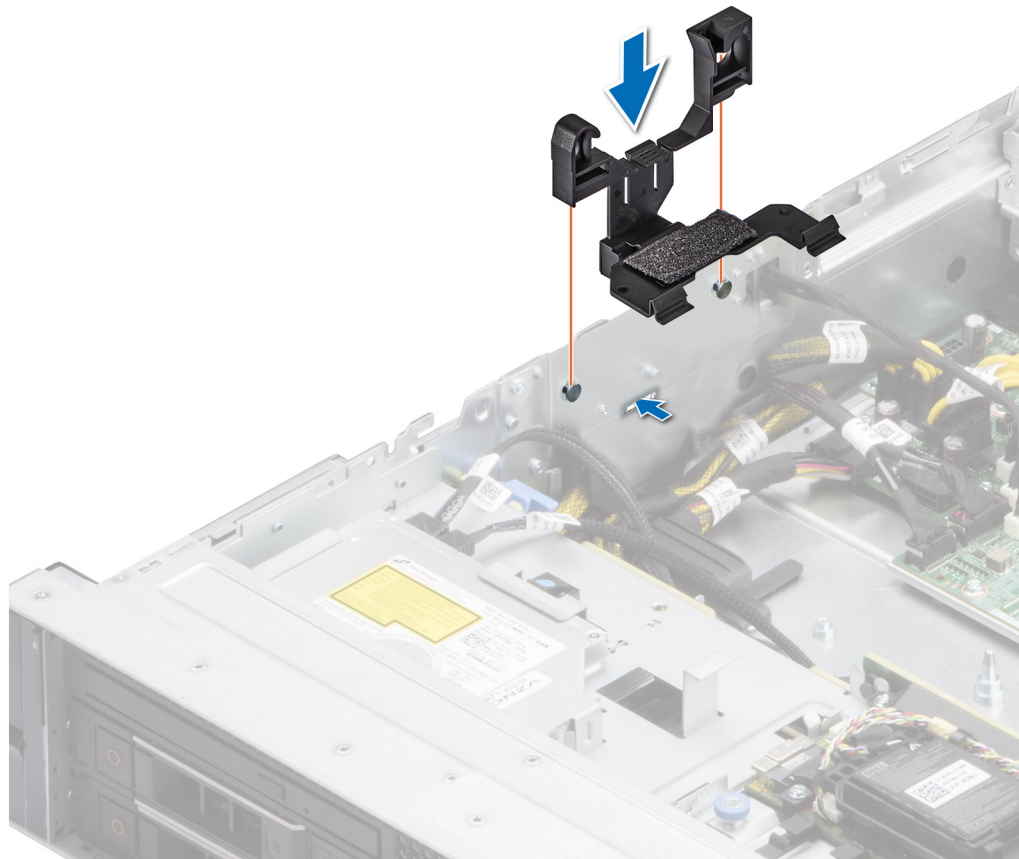

Figure 31. Installing the side wall bracket

Next steps

1. Install the air shroud.
2. Install the cooling fan cage assembly .
3. Follow the procedure listed in the [After working inside your system.](#)

Intrusion switch module

This is a service technician replaceable part only.

Removing the intrusion switch module

Prerequisites

1. Follow the safety guidelines listed in the [Safety instructions.](#)
2. Follow the procedure listed in the [Before working inside your system.](#)
3. [Remove the air shroud.](#)
4. Disconnect the system power cable from the system board.

Steps

1. Disconnect the intrusion switch cable from the connector on the system board.
i **NOTE:** Observe the routing of the cable as you remove it from the system.
2. Using the Phillips #1 screwdriver, remove the screw securing the intrusion switch module.

3. Lift the intrusion switch module out of the system.

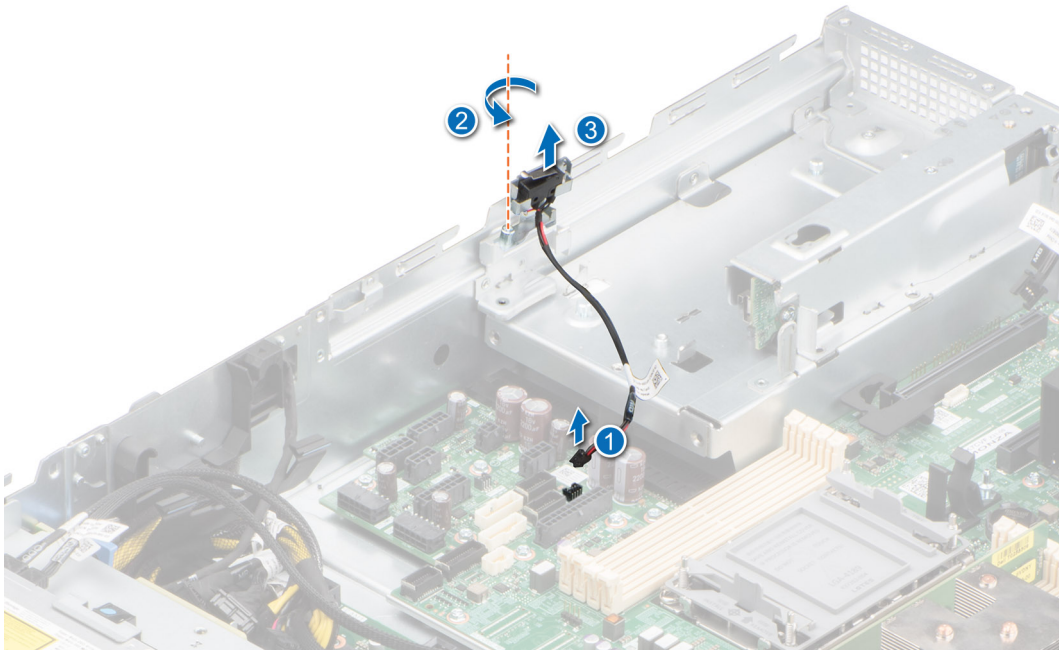

Figure 32. Removing the intrusion switch module

Next steps

Replace the intrusion switch module.

Installing the intrusion switch module

Prerequisites

1. Follow the safety guidelines listed in the [Safety instructions](#).
2. Follow the procedure listed in [Before working inside your system](#).
3. [Remove the air shroud](#).
4. Disconnect the system power cable from the system board.

Steps

1. Align and insert the intrusion switch module into the slot on the system until firmly seated.
2. Using the Phillips #1 screwdriver, tighten the screw securing the intrusion switch module.
3. Connect the intrusion switch cable to the connector on the system board.

NOTE: Route the cable properly when you replace it to prevent the cable from being pinched or crimped.

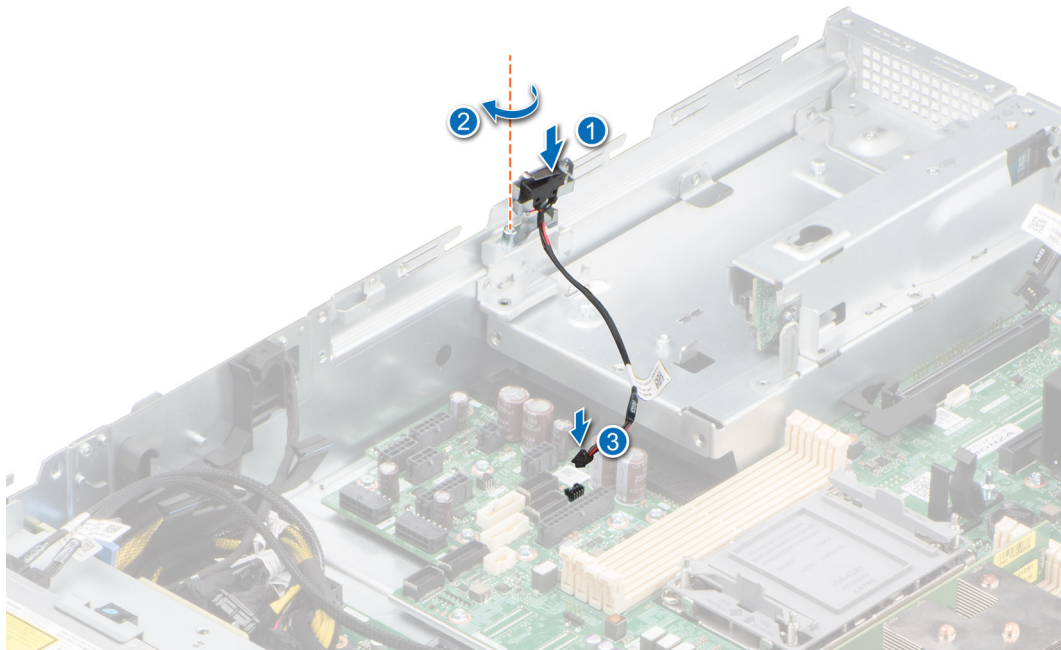

Figure 33. Installing the intrusion switch

Next steps

1. Connect the system power cable to the system board.
2. [Install the air shroud.](#)
3. Follow the procedure listed in [After working inside your system.](#)

Optional serial COM port

This is a service technician replaceable part only.

Removing the optional serial COM port

Prerequisites

1. Follow the safety guidelines listed in the [Safety instructions.](#)
2. Follow the procedure listed in the [Before working inside your system.](#)

Steps

1. Disconnect the serial COM port cable from the connector on the system board.
NOTE: Observe the routing of the cable as you remove it from the system.
2. Open the card holder and lift the serial COM port out of the system.

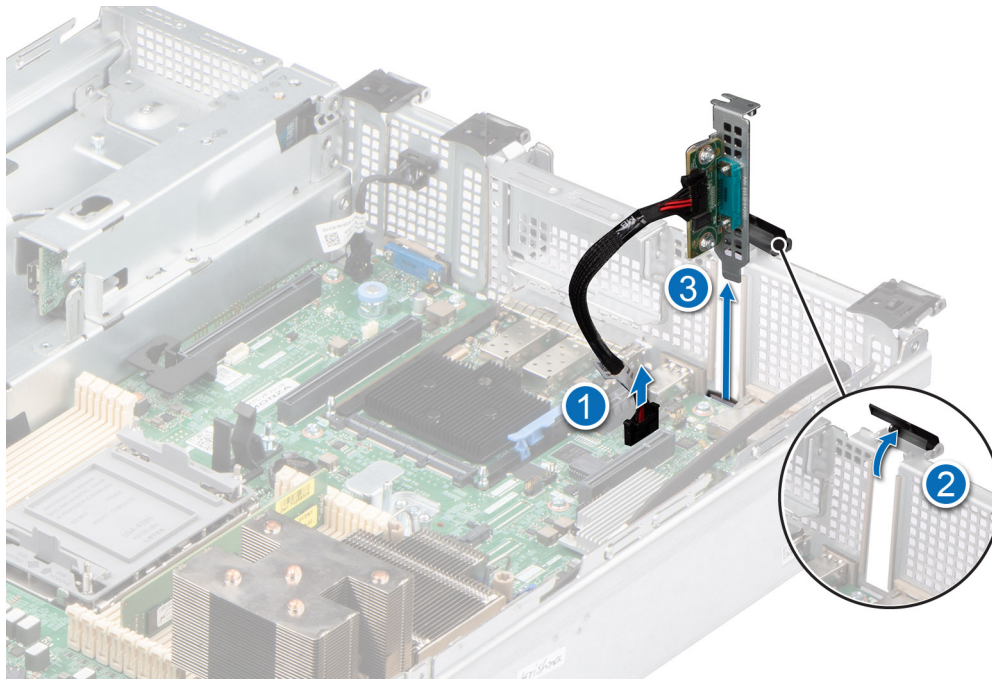

Figure 34. Removing the Serial COM port

3. Install the filler bracket if not replacing the serial COM port.

Next steps

Replace the serial COM port.

Installing the optional serial COM port

Prerequisites

1. Follow the safety guidelines listed in the [Safety instructions](#).
2. Follow the procedure listed in the [Before working inside your system](#).

Steps

1. Open the card holder and lift the metal filler bracket from the system.
2. Align and insert the serial COM port into the slot on the system until firmly seated and close the card holder.
3. Connect the serial COM port cable to the connector on the system board.

NOTE: Route the cable properly to prevent the cable from being pinched or crimped.

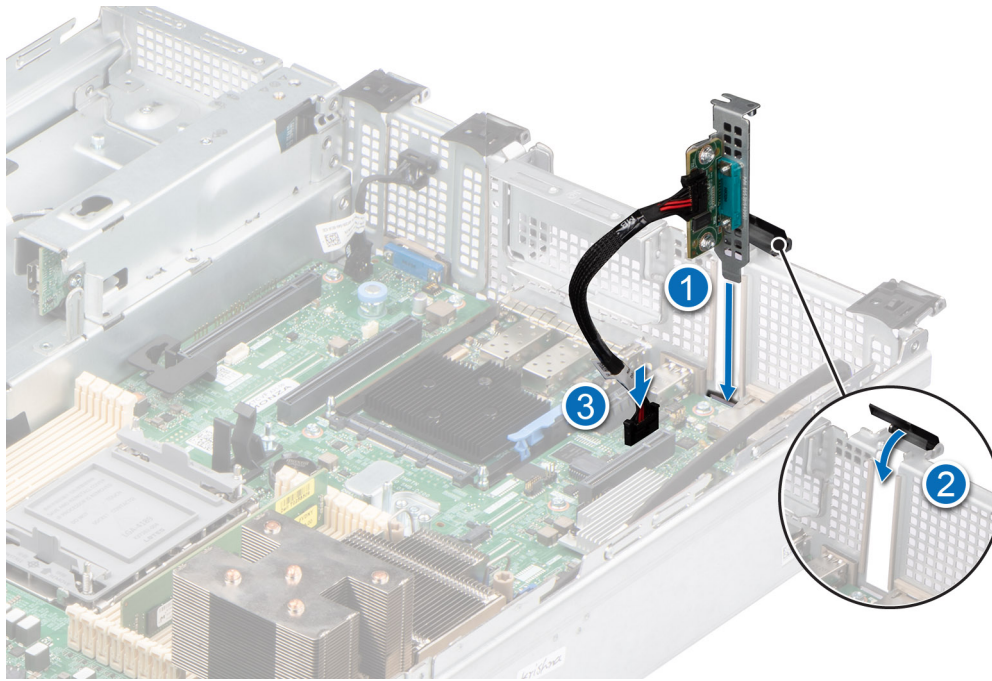

Figure 35. Installing the Serial COM port

Next steps

1. Follow the procedure listed in [After working inside your system](#).

Drives

Removing a drive blank

Prerequisites

1. Follow the safety guidelines listed in the [Safety instructions](#).
2. If installed, [remove the front bezel](#).

CAUTION: To maintain proper system cooling, drive blanks must be installed in all empty drive slots.

Steps

Press the release button, and slide the drive blank out of the drive slot.

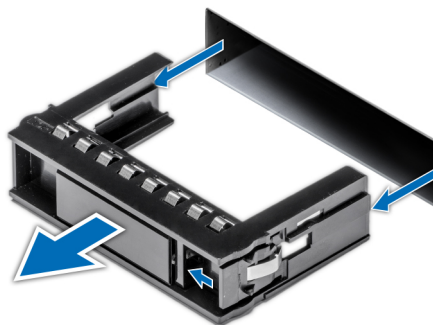

Figure 36. Removing a drive blank

Next steps

Installing a drive or replace the drive blank.

Installing a drive blank

Prerequisites

1. Follow the safety guidelines listed in the [Safety instructions](#).
2. If installed, [remove the front bezel](#).

Steps

Insert the drive blank into the drive slot until the release button clicks into place.

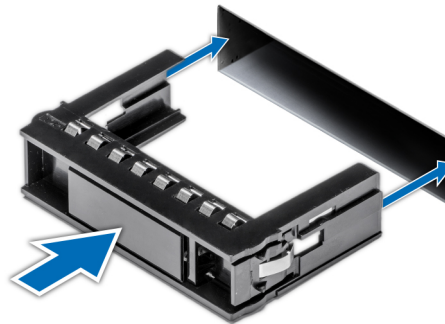

Figure 37. Installing a drive blank

Next steps

If removed, [install the front bezel](#).

Removing the drive carrier

Prerequisites

1. Follow the safety guidelines listed in the [Safety instructions](#).
2. If installed, [remove the front bezel](#).
3. Using the management software, prepare the drive for removal. If the drive is online, the green activity or fault indicator blinks while the drive is powering off. When the drive indicators are off, the drive is ready for removal. For more information, see the documentation for the storage controller.

CAUTION: Before attempting to remove or install a drive while the system is running, see the documentation for the storage controller card to ensure that the host adapter is configured correctly to support drive removal and insertion.

CAUTION: To prevent data loss, ensure that your operating system supports drive installation. See the documentation supplied with your operating system.

Steps

1. Press the release button to open the drive carrier release handle.
2. Holding the drive carrier release handle, slide the drive carrier out of the drive slot.



Figure 38. Removing a drive carrier

Next steps

Install a drive carrier or install a drive blank.

Installing the drive carrier

Prerequisites

- ⚠ **CAUTION:** Before removing or installing a drive while the system is running, see the documentation for the storage controller card to ensure that the host adapter is configured correctly to support drive removal and insertion.
 - ⚠ **CAUTION:** Combining SAS and SATA drives in the same RAID volume is not supported.
 - ⚠ **CAUTION:** When installing a drive, ensure that the adjacent drives are fully installed. Inserting a drive carrier and attempting to lock its handle next to a partially installed carrier can damage the partially installed carrier's shield spring and make it unusable.
 - ⚠ **CAUTION:** To prevent data loss, ensure that your operating system supports hot-swap drive installation. See the documentation supplied with your operating system.
 - ℹ **NOTE:** When a replacement hot swappable drive is installed while the system is powered on, the drive automatically begins to rebuild. Ensure that the replacement drive is blank. Any data on the replacement drive is immediately lost once the drive is installed
 - ℹ **NOTE:** Ensure that the drive carrier's release handle is in the open position before inserting the carrier into the slot.
1. Follow the safety guidelines listed in the [Safety instructions](#).
 2. If installed, [remove the front bezel](#).
 3. Remove the drive carrier or remove the drive blank when you want to assemble the drives in to the system.

Steps

1. Slide the drive carrier into the drive slot.
2. Close the drive carrier release handle to lock the drive in place.



Figure 39. Installing a drive carrier

Next steps

If removed, [install the front bezel](#).

Removing the drive from the drive carrier

Prerequisites

1. Follow the safety guidelines listed in the [Safety instructions](#).
2. [Remove the drive carrier](#)

Steps

1. Using a Phillips #1 screwdriver, remove the screws from the slide rails on the drive carrier.

NOTE: If the drive or SSD carrier has Torx screw, use Torx 6 (for 2.5-inch drive) or Torx 8 (for 3.5-inch drive) screwdriver to remove the drive. 

2. Lift the drive out of the drive carrier.

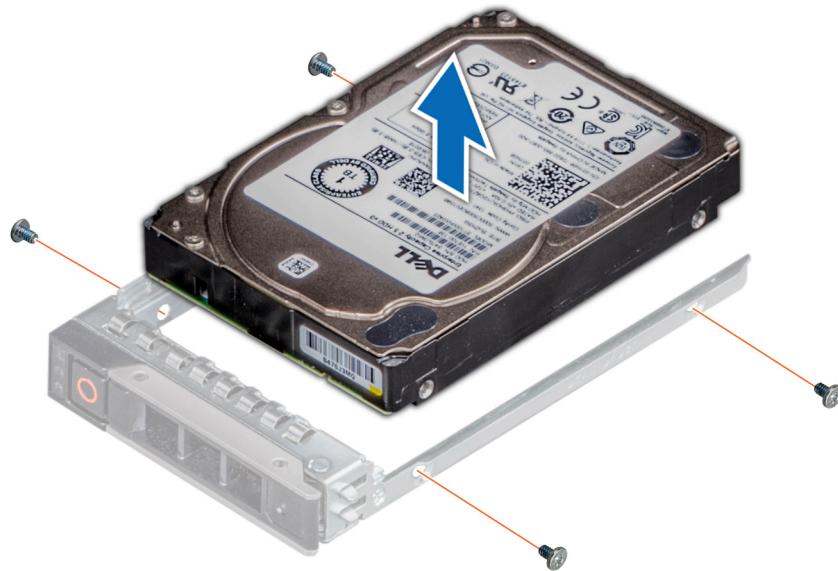

Figure 40. Removing the drive from the drive carrier

Next steps

Install the drive into the drive carrier.

Installing the drive into the drive carrier

Prerequisites

1. Follow the safety guidelines listed in the [Safety instructions](#).
2. [Remove the drive carrier](#)

Steps

1. Insert the drive into the drive carrier with the drive connector facing towards the rear of the carrier.
2. Align the screw holes on the drive with the screws holes on the drive carrier.
3. Using a Phillips #1 screwdriver, secure the drive to the drive carrier with the screws.

i **NOTE:** If the drive or SSD carrier has Torx screw, use Torx 6 (for 2.5-inch drive) or Torx 8 (for 3.5-inch drive) screwdriver to install the drive. 



Figure 41. Installing a drive into the drive carrier

Next steps

1. [Install the drive carrier.](#)

Drive backplane

This is a service technician replaceable part only.

Drive backplane

Depending on your system configuration, the drive backplanes supported are listed here:

Table 15. Supported backplane options

System	Supported drives options
PowerEdge R550	16 x 2.5-inch SAS/SATA backplane
	8 x 2.5-inch SAS/SATA backplane
	8 x 3.5-inch SAS/SATA backplane

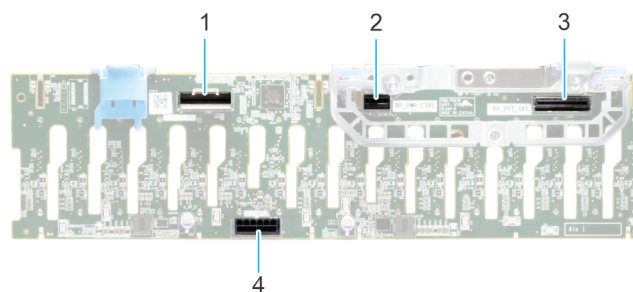

Figure 42. 16x 2.5-inch SAS/SATA backplane

1. BP_DST_SB1
2. BP_PWR_CTRL (backplane power and signal cable to system board)
3. BP_DST_SB1

4. BP_PWR_1 (backplane power to system board)

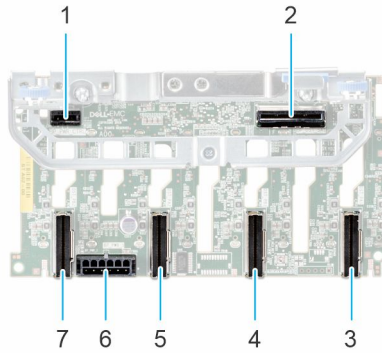

Figure 43. 8 x 2.5-inch drive backplane

- | | |
|--------------------------------|--|
| 1. BP_PWR_CTRL | 2. BP_DST_SA1 (PERC to backplane) |
| 3. BP_DST_PA1 (PCIe connector) | 4. BP_DST_PB1 (PCIe connector) |
| 5. BP_DST_PA2 (PCIe connector) | 6. BP_PWR_1 (backplane power and signal cable to system board) |
| 7. BP_DST_PB2 (PCIe connector) | |

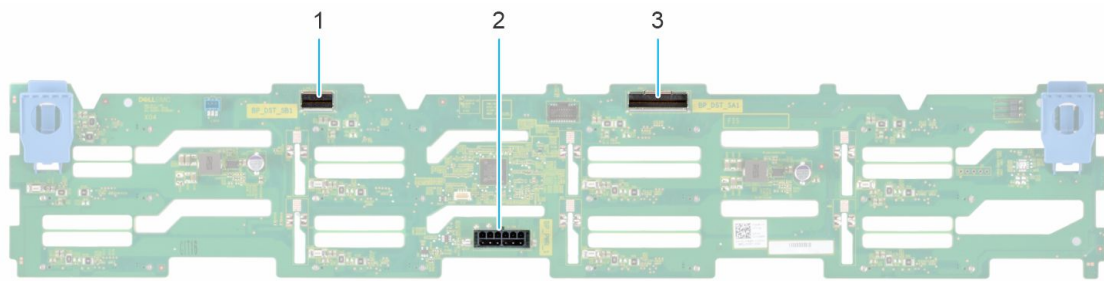

Figure 44. 8 x 3.5-inch drive backplane

- | |
|--|
| 1. BP_DST_SB1 |
| 2. BP_PWR_1 (backplane power and signal cable to system board) |
| 3. BP_DST_SA1 |

Removing the drive backplane

Prerequisites

CAUTION: To prevent damage to the drives and backplane, remove the drives from the system before removing the backplane.

CAUTION: Note the number of each drive and temporarily label them before you remove the drive so that you can reinstall them in the same location.

NOTE: The procedure to remove the backplane is similar for all backplane configurations.

1. Follow the safety guidelines listed in the [Safety instructions](#).
2. Follow the procedure listed in the [Before working inside your system](#).
3. [Remove the air shroud](#).
4. [Remove the drive backplane cover](#).
5. [Remove the cooling fan cage assembly](#).
6. [Remove the PERC card](#).
7. [Remove the drives](#).
8. If installed, disconnect the optical drive signal and power cables from the system.
9. Disconnect the drive backplane cables from the connectors on the system board.

Steps

1. Press the blue release tabs to disengage the drive backplane from the hooks on the system.
2. Lift the drive backplane out of the system.

NOTE: To avoid damaging the backplane, ensure that you move the control panel cables from the cable routing clips before removing the backplane.

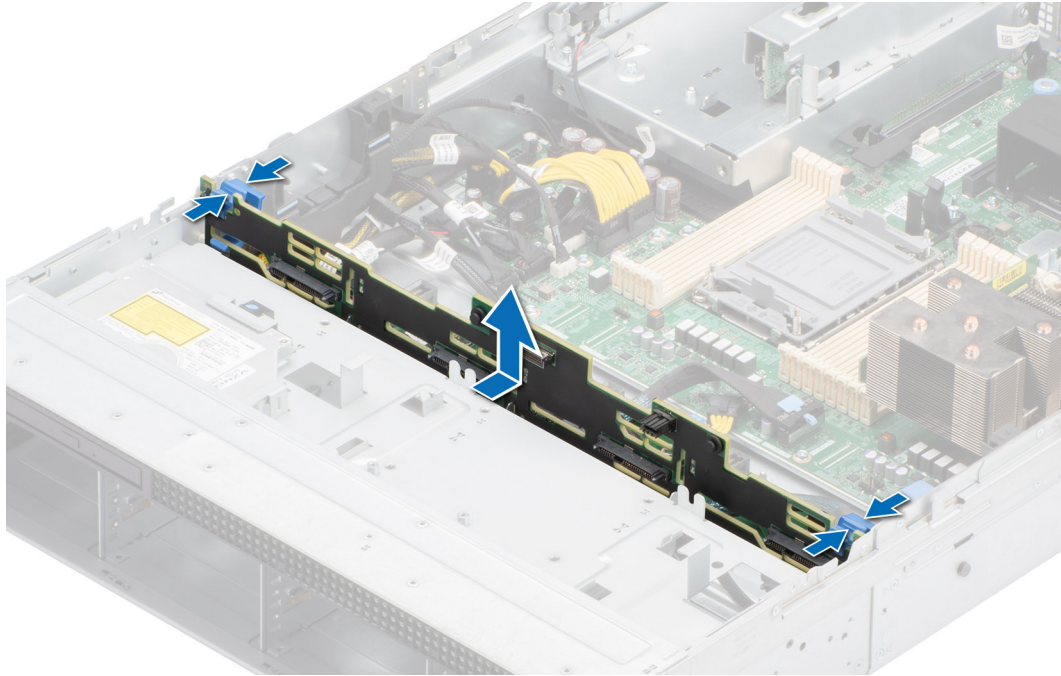

Figure 45. Removing the drive backplane

Next steps

Replace the drive backplane.

Installing the drive backplane

Prerequisites

1. Follow the safety guidelines listed in the [Safety instructions](#).
2. Follow the procedure listed in the [Before working inside your system](#).
3. [Remove the air shroud](#).
4. [Remove the drive backplane cover](#).
5. [Remove the cooling fan cage assembly](#).
6. [Remove the PERC card](#).
7. [Remove the drives](#).

NOTE: To avoid damaging the backplane, ensure to move the control panel cables from the cable routing clips before removing the backplane.

NOTE: Route the cable properly when you replace it to prevent the cable from being pinched or crimped.

Steps

1. Use the hooks on the system as guides to align the slots on the backplane with the guides on the system.
2. Slide the drive backplane into the guides and lower the backplane until the blue release tabs click into place.

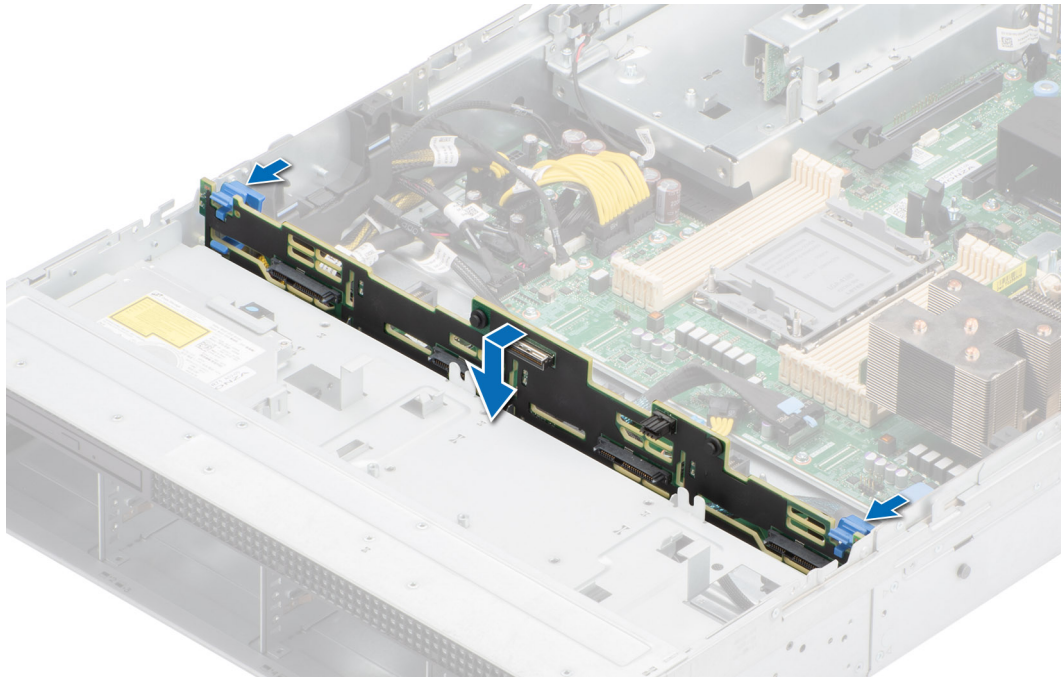

Figure 46. Installing the drive backplane

Next steps

1. If removed, connect the optical drive signal and power cables to the system.
2. Connect the drive backplane cables to the connectors on the system board.
3. [Install the drives.](#)
4. [Install the PERC card.](#)
5. [Install the cooling fan cage assembly.](#)
6. [Install the drive backplane cover.](#)
7. [Install the air shroud.](#)
8. Follow the procedure listed in [After working inside your system.](#)

Cable routing

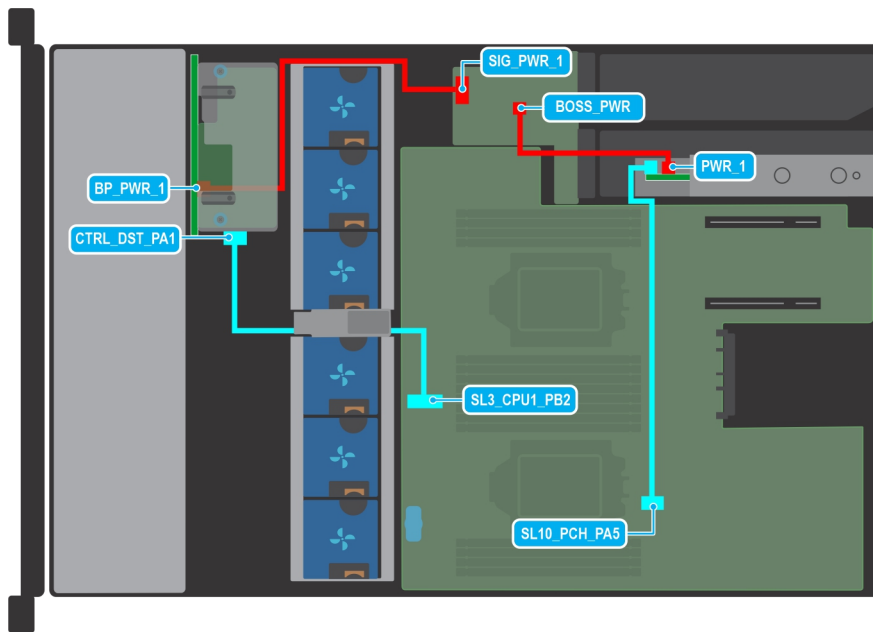

Figure 47. 8 x 2.5-inch SAS/SATA

Table 16. 8 x 2.5-inch SAS/SATA

From	To
CTRL_DST_PA1 (Signal connector on the front PERC)	SL3_CPU1_PB2 (Signal connector on system board)
BP_PWR_1 (Power connector on backplane)	SIG_PWR_3 (Power connector on system board)
BOSS_PWR (BOSS card power connector)	BOSS_PWR (Power connector for BOSS card on system board)
SL10_PCH_PA5 (BOSS signal connector on system board)	BOSS signal on BOSS S2 card module

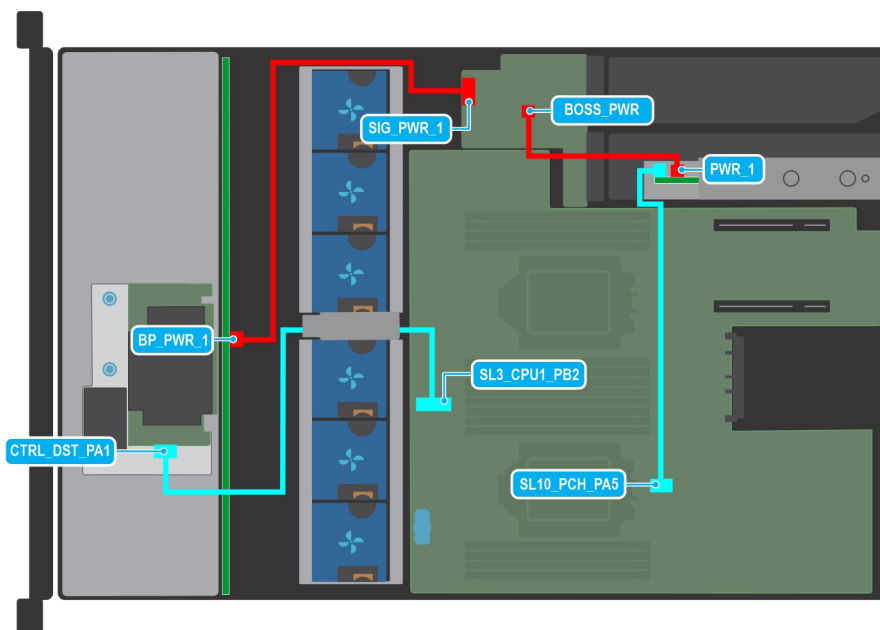

Figure 48. 8 x 3.5-inch SAS/SATA

Table 17. 8 x 3.5-inch SAS/SATA

From	To
CTRL_DST_PA1 (Signal connector on the front PERC)	SL3_CPU1_PB2 (Signal connector on system board)
BP_PWR_1 (Power connector on backplane)	SIG_PWR_3 (Power connector on system board)
BOSS_PWR (BOSS card power connector)	BOSS_PWR (Power connector for BOSS card on system board)
SL10_PCH_PA5 (BOSS signal connector on system board)	BOSS signal on BOSS S2 card module

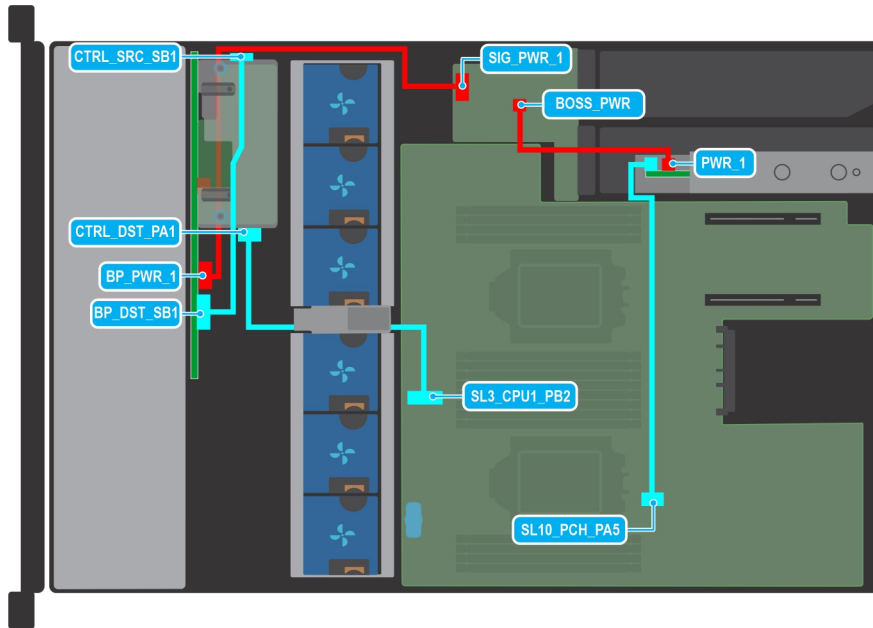

Figure 49. 16 x 2.5-inch SAS/SATA

Table 18. 16 x 2.5-inch SAS/SATA

From	To
CTRL_SRC_SB1 (Signal connector on the front PERC)	BP_DST_SB1 (Signal connector on backplane)
CTRL_DST_PA1 (Signal connector on the front PERC)	SL3_CPU1_PB2 (Signal connector on system board)
BP_PWR_1 (Power connector on backplane)	SIG_PWR_3 (Power connector on system board)
BOSS_PWR (BOSS card power connector)	BOSS_PWR (Power connector for BOSS card on system board)
SL10_PCH_PA5 (BOSS signal connector on system board)	BOSS signal on BOSS S2 card module

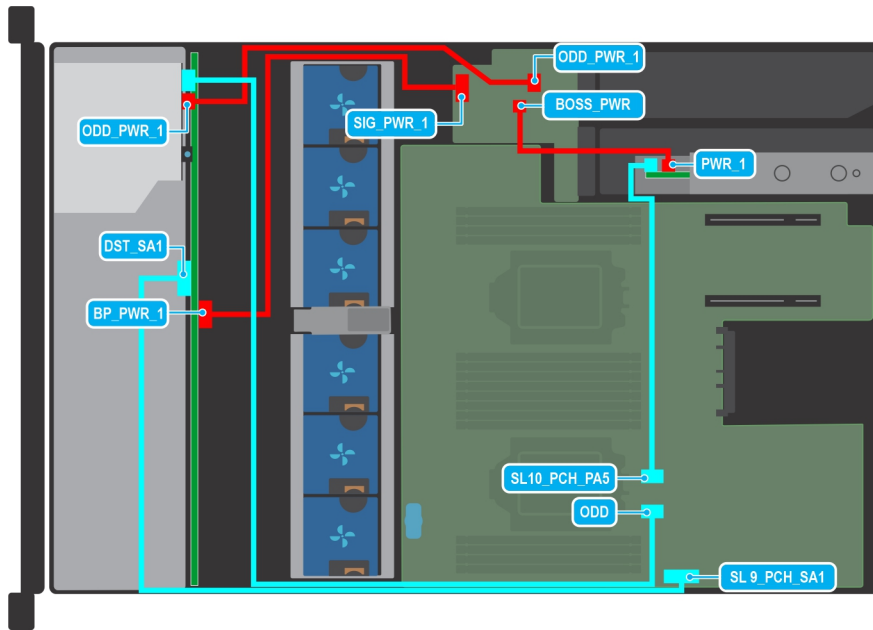

Figure 50. ODD and no PERC configuration

Table 19. ODD and no PERC configuration

From	To
CTRL_SRC_SB1 (Signal connector on the front PERC)	BP_DST_SB1 (Signal connector on backplane)
CTRL_DST_SA1 (Signal connector on the drive backplane)	SL9_PCH_SA1 (Signal connector on system board)
ODD (Optical Disk Drive connector on system board)	ODD (Optical Disk Drive)
ODD_PWR_1 (ODD card power connector)	SIG_PWR_3 (Power connector on system board)
BP_PWR_1 (Power connector on backplane)	SIG_PWR_3 (Power connector on system board)
BOSS_PWR (BOSS card power connector)	BOSS_PWR (Power connector for BOSS card on system board)
SL10_PCH_PA5 (BOSS signal connector on system board)	BOSS signal on BOSS S2 card module

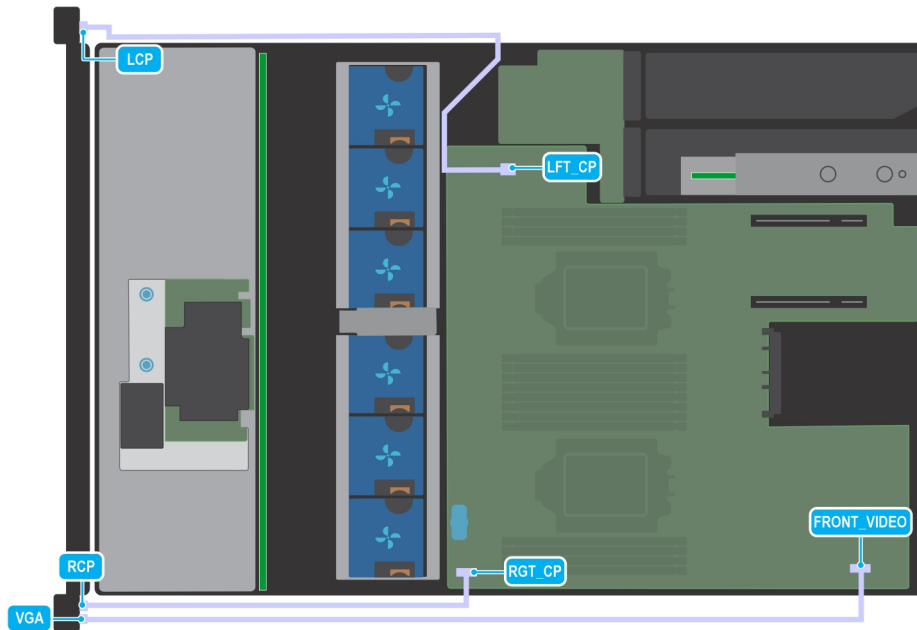

Figure 51. VGA and Control Panel

Table 20. VGA and Control Panel

From	To
LEFT_CP (Left control panel connector)	Left control panel (LCP)
RGT_CP (Right control panel connector)	Right control panel (RCP)
FRONT_VIDEO (Front VGA connector)	VGA on RCP

System memory

System memory guidelines

The PowerEdge R550 system supports DDR4 registered DIMMs (RDIMMs). System memory holds the instructions that are executed by the processor.

Your system contains 16 memory sockets organized into 8 channels per processor.

Memory channels are organized as follows:

Table 21. Memory channels

Processor	Channel A	Channel B	Channel C	Channel D	Channel E	Channel F	Channel G	Channel H
Processor 1	A1	A5	A3	A7	A2	A6	A4	A8
Processor 2	B1	B5	B3	B7	B2	B6	B4	B8

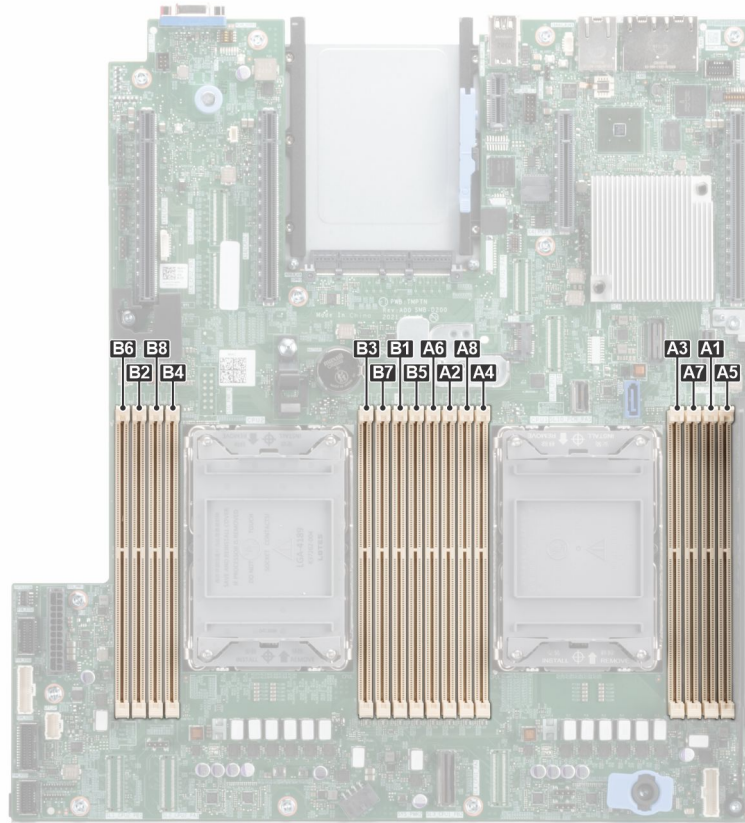

Figure 52. Memory channels

Table 22. Supported memory matrix

DIMM type	Rank	Capacity	DIMM rated voltage and speed	Operating speed for DIMMs per Channel (DPC)
RDIMM	1R	8 GB	DDR4 (1.2V), 3200 MT/s	2933 MT/s
	2R	16 GB, 32 GB, 64 GB	DDR4 (1.2V), 3200 MT/s	2933 MT/s

General memory module installation guidelines

To ensure optimal performance of your system, observe the following general guidelines when configuring your system memory. If your system's memory configurations fail to observe these guidelines, your system might not boot, stop responding during memory configuration, or operate with reduced memory.

The memory bus may operate at speeds of 2933 MT/s depending on the following factors:

- System profile selected (for example, Performance Optimized, or Custom [can be run at high speed or lower])
- Maximum supported DIMM speed of the processors
- Maximum supported speed of the DIMMs

NOTE: MT/s indicates DIMM speed in MegaTransfers per second.

The system supports Flexible Memory Configuration, enabling the system to be configured and run in any valid chipset architectural configuration. The following are the recommended guidelines for installing memory modules:

- All DIMMs must be DDR4.
- x4 and x8 DRAM based memory modules can be mixed.
- If memory modules with different speeds are installed, they operate at the speed of the slowest installed memory module(s).
- Populate memory module sockets only if a processor is installed.
 - For single-processor systems, sockets A1 to A8 are available.
 - For dual-processor systems, sockets A1 to A8 and sockets B1 to B8 are available.

- In **Optimizer Mode**, the DRAM controllers operate independently in the 64-bit mode and provide optimized memory performance.

Table 23. Memory population rules

Processor	Configuration	Memory population	Memory population information
Single processor	Optimizer (Independent channel) population order	A{1}, A{2}, A{3}, A{4}, A{5}, A{6}, A{7}, A{8}	1, 2, 3, 4 DIMMs are allowed.
Dual processor (Start with processor1. Processor 1 and processor 2 population should match)	Optimizer (Independent channel) population order	A{1}, B{1}, A{2}, B{2}, A{3}, B{3}, A{4}, B{4}, A{5}, B{5}, A{6}, B{6}, A{7}, B{7}, A{8}, B{8}	1, 2, 3, 4, 5, 6, 7, 8 DIMMs are supported per system . NOTE: Optimizer population order is not traditional for 8 and 16 DIMMs installations for dual processor.

- Memory modules of different capacities can be mixed provided other memory population rules are followed.
- Mixing of more than two memory module capacities in a system is not supported.
- Unbalanced or odd memory configuration results in a performance loss and system may not identify the memory modules being installed, so always populate memory channels identically with equal DIMMs for best performance.
- Supported RDIMM / LRDIMM configurations are 1, 2, 4, 6, 8 DIMMs per processor.
- Populate eight equal memory modules per processor (one DIMM per channel) at a time to maximize performance.

NOTE: Equal memory modules refer to DIMMs with identical electrical specification and capacity that may be from different vendors.

Removing a memory module

Prerequisites

- Follow the safety guidelines listed in the [Safety instructions](#).
- Follow the procedure listed in the [Before working inside your system](#).
- [Remove the air shroud](#).

WARNING: The memory modules are hot to touch for some time after the system has been powered off. Allow the memory modules to cool before handling them.

Steps

- Locate the appropriate memory module socket.
- To release the memory module from the socket, simultaneously press the ejectors on both ends of the memory module socket to fully open.

CAUTION: Handle each memory module only by the card edges, ensuring not to touch the middle of the memory module or metallic contacts.

- Lift the memory module away from the system.

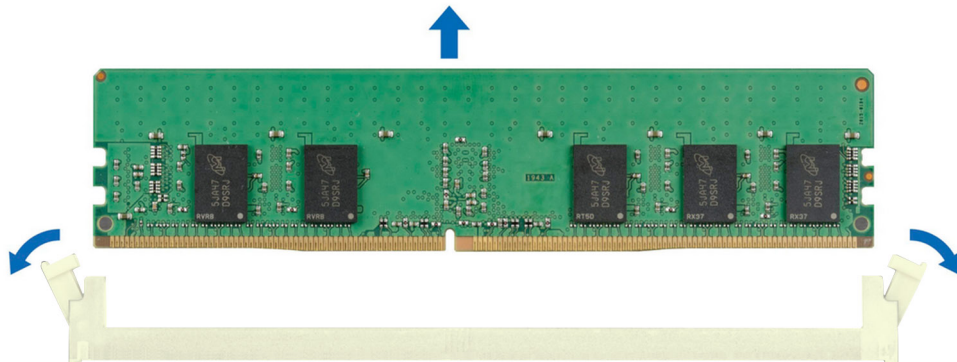

Figure 53. Removing a memory module

Next steps

Replace the memory module.

Installing a memory module

Prerequisites

1. Follow the safety guidelines listed in the [Safety instructions](#).
2. Follow the procedure listed in the [Before working inside your system](#).
3. [Remove the air shroud](#).

Steps

1. Locate the appropriate memory module socket.

CAUTION: Handle each memory module only by the card edges, ensuring not to touch the middle of the memory module or metallic contacts.

2. If a memory module blank is installed in the socket, remove it.

NOTE: Ensure the socket ejector latches are fully open, before installing the memory module.

3. Align the edge connector of the memory module with the alignment key of the memory module socket, and insert the memory module in the socket.

CAUTION: To prevent damage to the memory module or the memory module socket during installation, do not bend or flex the memory module; insert both ends of the memory module simultaneously.

NOTE: The memory module socket has an alignment key that enables you to install the memory module in the socket in only one orientation.

CAUTION: Do not apply pressure at the center of the memory module; apply pressure at both ends of the memory module evenly.

4. Press the memory module with your thumbs until the ejectors firmly click into place. When the memory module is properly seated in the socket, the levers on the memory module socket align with the levers on the other sockets that have memory modules installed.

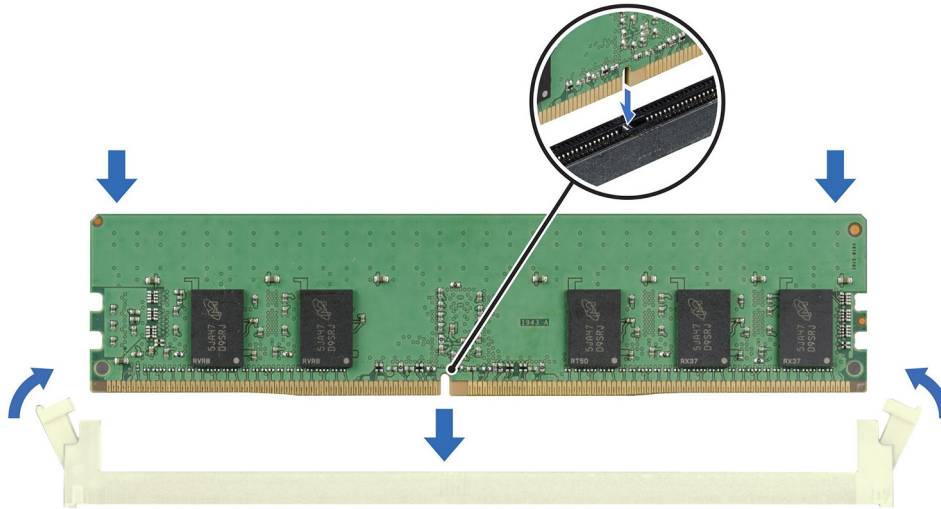

Figure 54. Installing a memory module

Next steps

1. [Install the air shroud.](#)
2. Follow the procedure listed in [After working inside your system.](#)
3. To verify if the memory module has been installed properly, press F2 and navigate to **System Setup Main Menu > System BIOS > Memory Settings**. In the **Memory Settings** screen, the System Memory Size must reflect the updated capacity of the installed memory.
4. If the System Memory Size is incorrect, one or more of the memory modules may not be installed properly. Ensure that the memory modules are firmly seated in their sockets.
5. Run the system memory test in system diagnostics.

Processor and heat sink module

This is a service technician replaceable part only.

Removing processor and heat sink module

Prerequisites

1. Follow the safety guidelines listed in the [Safety instructions](#).
2. Follow the procedure listed in the [Before working inside your system](#).
3. [Remove the air shroud.](#)
NOTE: The heat sink and processor are too hot to touch for some time after the system has been powered down. Allow the heat sink and processor to cool down before handling them.

Steps

1. Ensure all four anti-tilt wires are in the locked position (outward position), and then using a Torx #T30 tool, loosen the captive nuts on the processor heat sink module (PHM) in the order that is mentioned below:

- a. Loosen the first nut three turns.
 - b. Loosen the nut diagonally opposite to the nut you loosened first.
 - c. Repeat the procedure for the remaining two nuts.
 - d. Return to the first nut to loosen it completely.
2. Set all the anti-tilt wires to unlocked position (inward position).

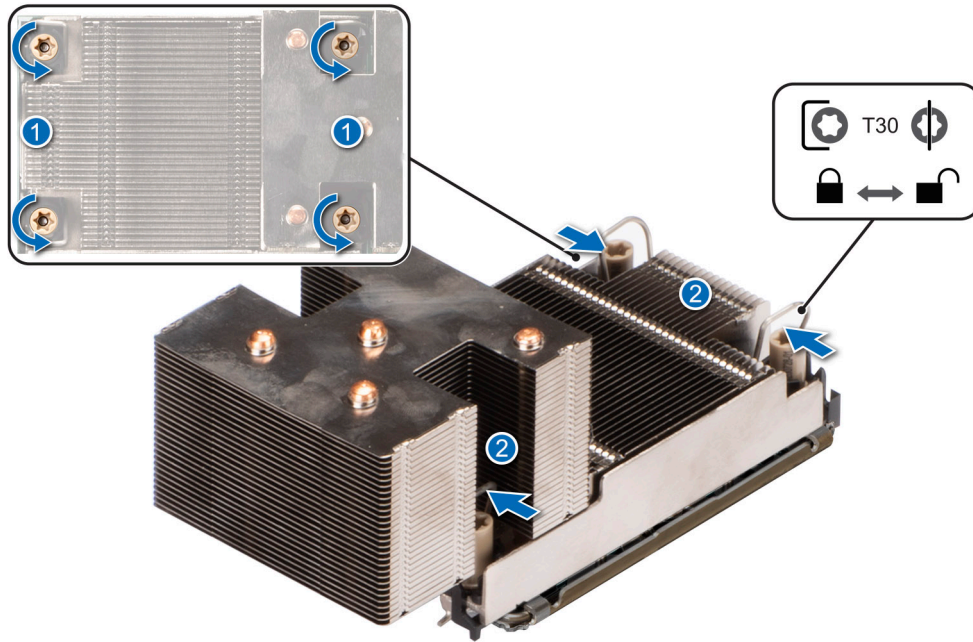

Figure 55. Loosening the nuts and setting the anti-tilt wires to the unlock position

3. Lift the PHM from the system and set the PHM aside with the processor side facing up.

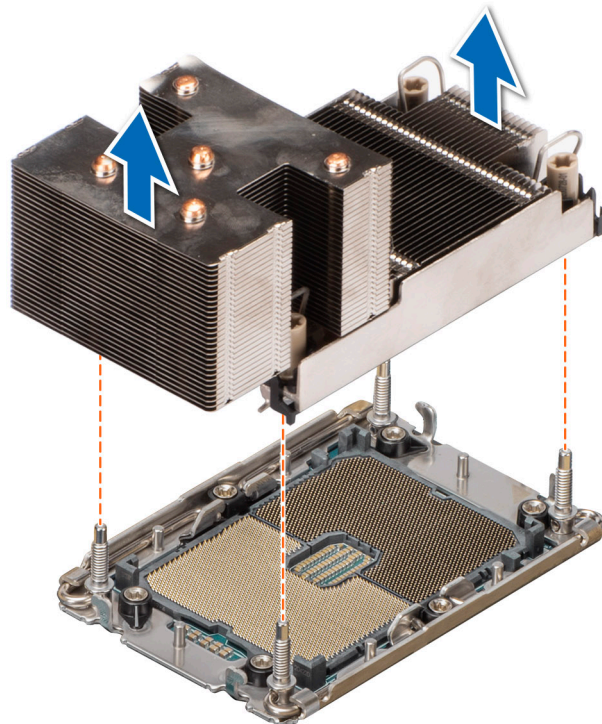

Figure 56. Removing a processor heat sink

Next steps

If you are removing a faulty heat sink, [replace the heat sink](#), if not, [remove the processor](#).

Removing the processor from the processor and heat sink module

Prerequisites

⚠ WARNING: The heat sink may be hot to touch for some time after the system has been powered off. Allow the heat sink to cool before removing it.

1. Follow the safety guidelines listed in the [Safety instructions](#).
2. Follow the procedure listed in the [Before working inside your system](#).
3. [Remove the air shroud](#).
4. [Remove the processor heat sink module](#).

⚠ CAUTION: You may find the CMOS battery loss or CMOS checksum error displayed during the first instance of powering on the system after the processor or system board replacement which is expected. To fix this, simply go to setup option to configure the system settings.

Steps

1. Place the heat sink with the processor side facing up.
2. Using your thumb, lift the thermal interface material (TIM) break lever to release the processor from the TIM and retaining clip.
3. Holding the processor by the edges, lift the processor away from the retaining clip.

i NOTE: Ensure to hold the retaining clip to the heat sink as you lift the TIM break lever.

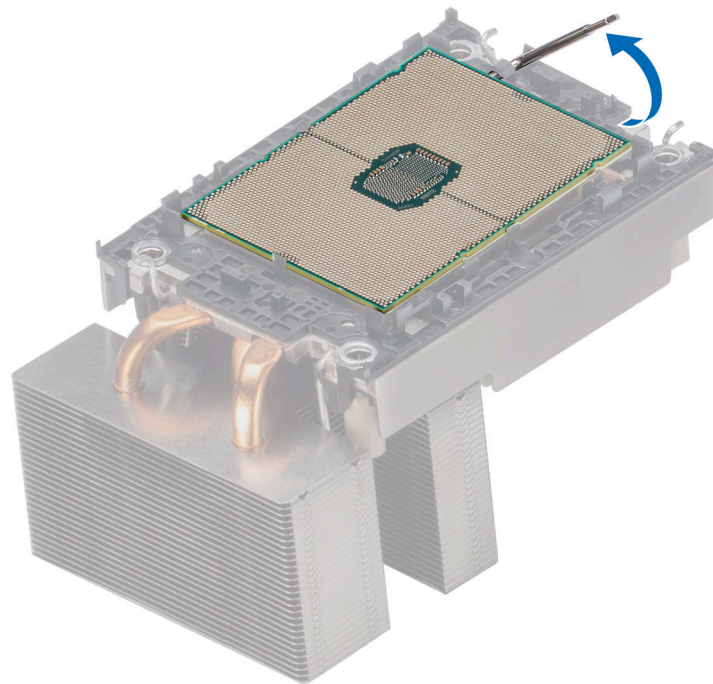

Figure 57. Lift up the TIM break lever

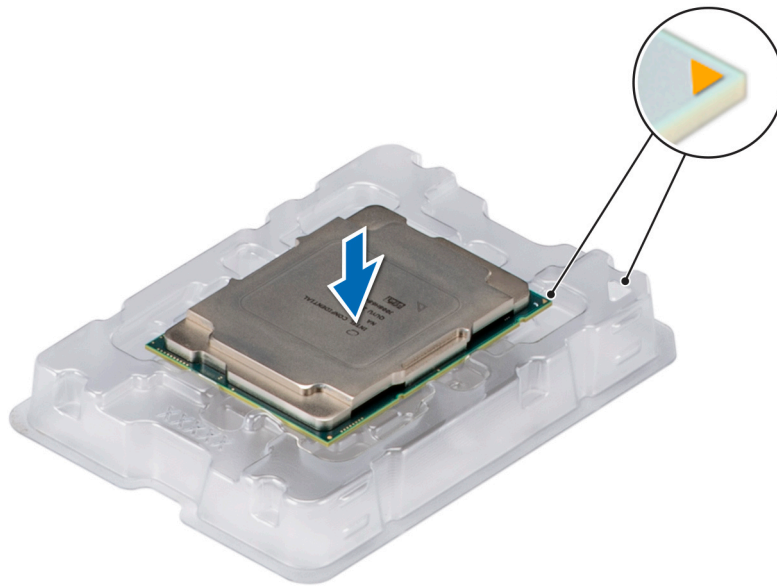

Figure 58. Aligning pin 1 marks of processor with tray

i **NOTE:** Ensure to return the TIM break lever back to original position.

4. Using your thumb and index finger, first hold the retaining clip release tab at the pin 1 connector, pull out the tip of the retaining clip release tab, and then lift the retaining clip partially from the heat sink.
5. Repeat the procedure at the remaining three corners of the retaining clip.
6. After all the corners are released from the heat sink, lift the retaining clip from the pin 1 corner of the heat sink.

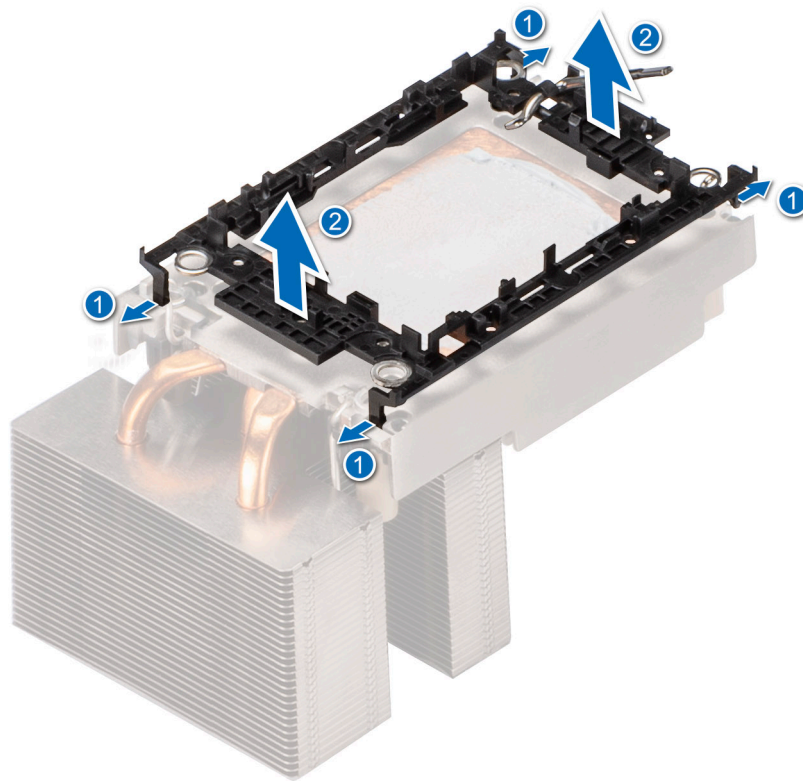

Figure 59. Removing the retaining clip

Next steps

Replace the processor into a processor and heat sink module (PHM).

Installing the processor into a processor and heat sink module

Prerequisites

1. Follow the safety guidelines listed in the [Safety instructions](#).
2. Follow the procedure listed in the [Before working inside your system](#).
3. [Remove the air shroud](#).
4. [Remove the processor heat sink module](#).

Steps

1. Place the processor in the processor tray with the connector side facing down.

NOTE: Ensure that the pin 1 indicator on the processor tray is aligned with the pin 1 indicator on the processor.

2. Place the retaining clip on top of the processor in the processor tray aligning pin 1 indicator on the processor.

NOTE: Ensure the pin 1 indicator on the retaining clip is aligned with the pin 1 indicator on the processor before placing the retaining clip on the processor

NOTE: Before you install the heat sink, ensure to place the processor and retaining clip in the tray

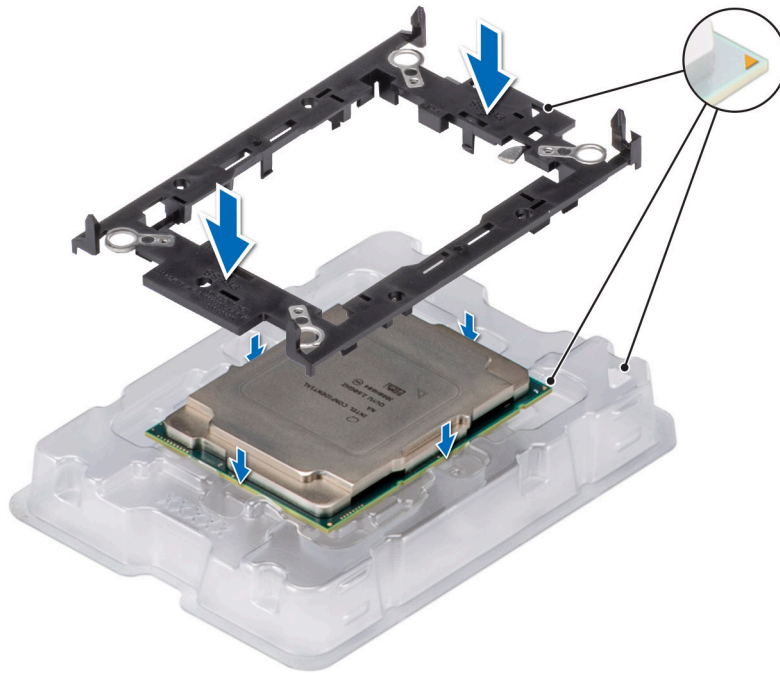

Figure 60. Installing the processor bracket

3. Align the processor with retaining clip, by using the fingers press the retaining clip on all the four sides until it clicks into place.

i **NOTE:** Ensure the processor is securely latched to the retaining clip.

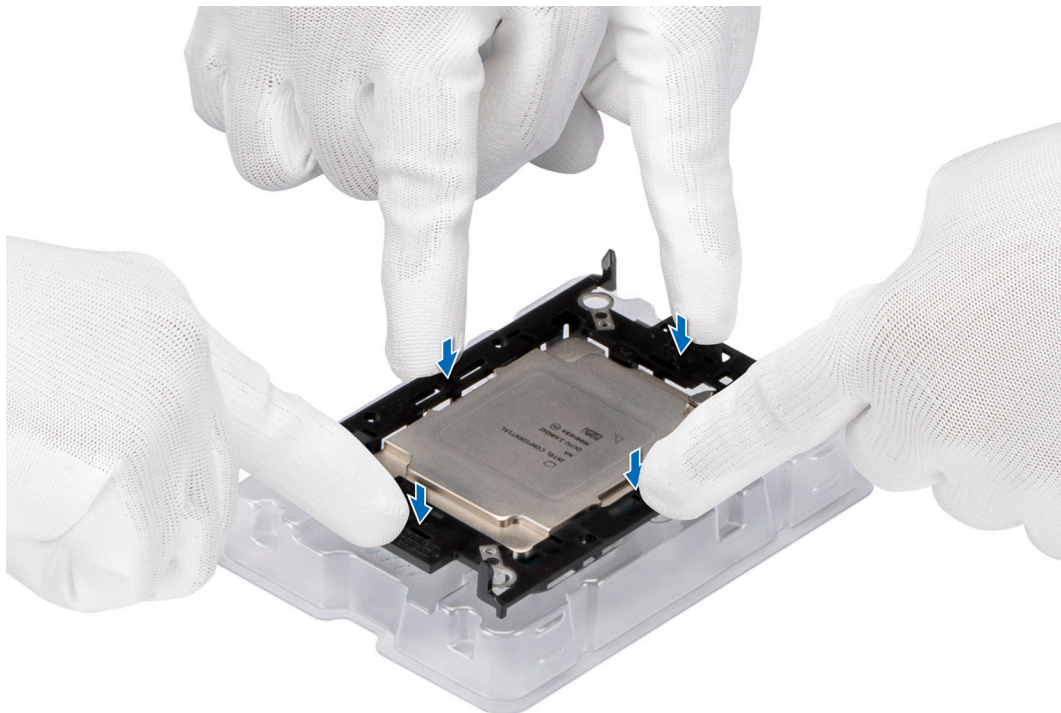

Figure 61. Press the retaining clip on the four sides

4. If you are using an existing heat sink, remove the thermal grease from the heat sink by using a clean lint-free cloth.
5. Use the thermal grease syringe included with your processor kit to apply the grease in a thin spiral on the bottom of the heat sink.

CAUTION: Applying too much thermal grease can result in excess grease coming in contact with and contaminating the processor socket.

NOTE: The thermal grease syringe is intended for single use only. Dispose the syringe after you use it.

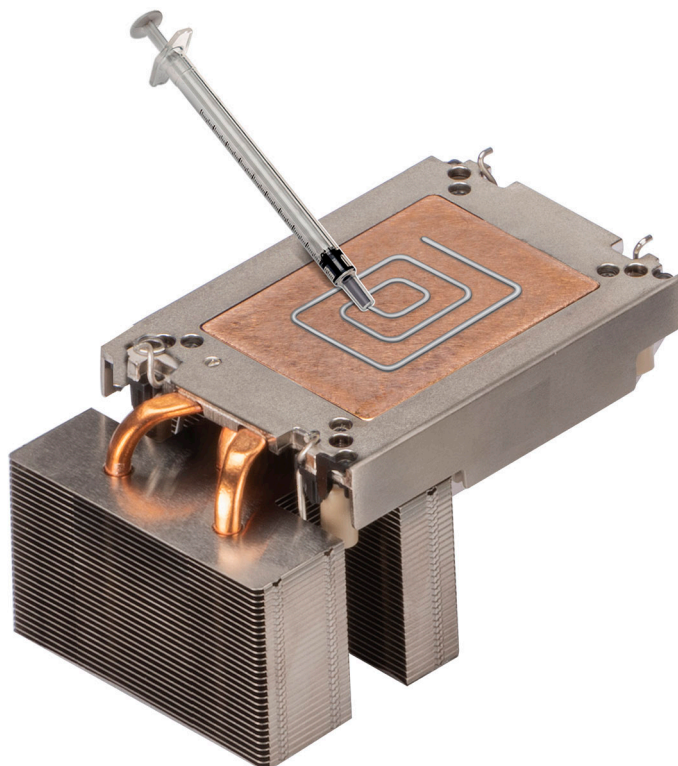

Figure 62. Applying thermal grease

6. For new heat sink, remove the Thermal Interface Material (TIM) protective film from the base of heat sink.



Figure 63. Remove the Thermal Interface Material (TIM) protective film

7. Place the heat sink on the processor and press the base of the heat sink until the retaining clip locks onto the heat sink at all the four corners.

CAUTION: To avoid damaging the fins on the heat sink, do not press down on the heat sink fins.

NOTE:

- Ensure latching features on retaining clip and heat sink are aligned during assembly.
- Ensure that the pin 1 indicator on the heat sink is aligned with the pin 1 indicator on the retaining clip before placing the heat sink onto the retaining clip.

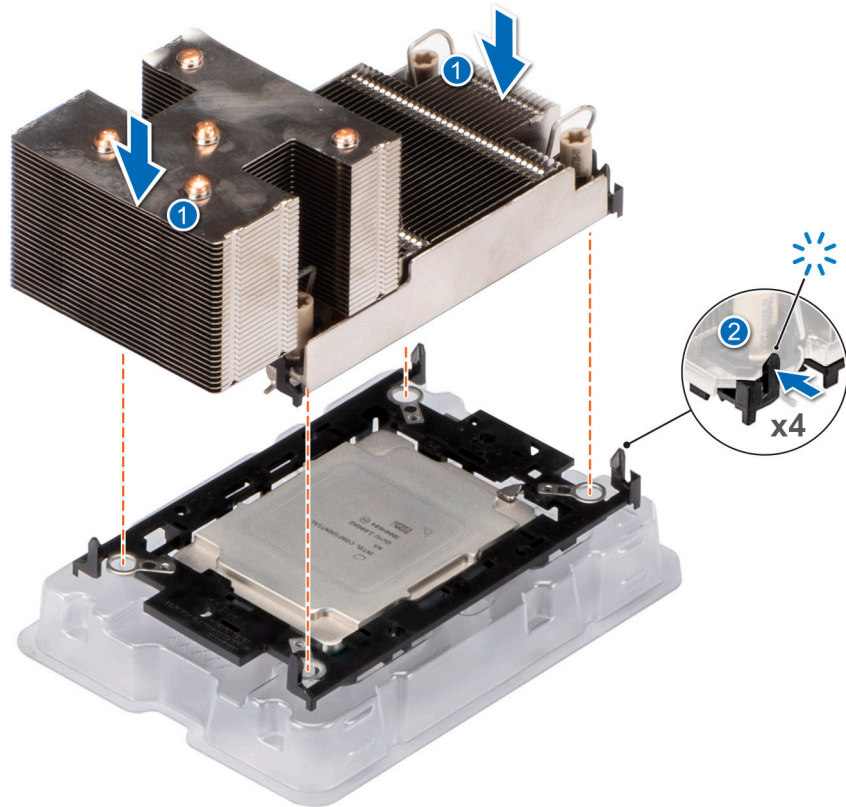

Figure 64. Installing the heat sink onto the processor

Next steps

1. Install the processor and heat sink module.
2. Install the air shroud.
3. Follow the procedure listed in [After working inside your system](#).

Installing the processor heat sink module

Prerequisites

Never remove the heat sink from a processor unless you intend to replace the processor or system board. The heat sink is necessary to maintain proper thermal conditions.

1. Follow the safety guidelines listed in the [Safety instructions](#).
2. Follow the procedure listed in the [Before working inside your system](#).
3. [Remove the air shroud](#).
4. If installed, remove the processor dust cover.

Steps

1. Set the anti-tilt wires to the unlocked position on the heat sink (inward position).
2. Align the pin 1 indicator of the processor heat sink module (PHM) to the system board, and then place the PHM on the processor socket.

CAUTION: To avoid damaging the fins on the heat sink, do not press down on the heat sink fins.

NOTE: Ensure that the PHM is held parallel to the system board to prevent damaging the components.

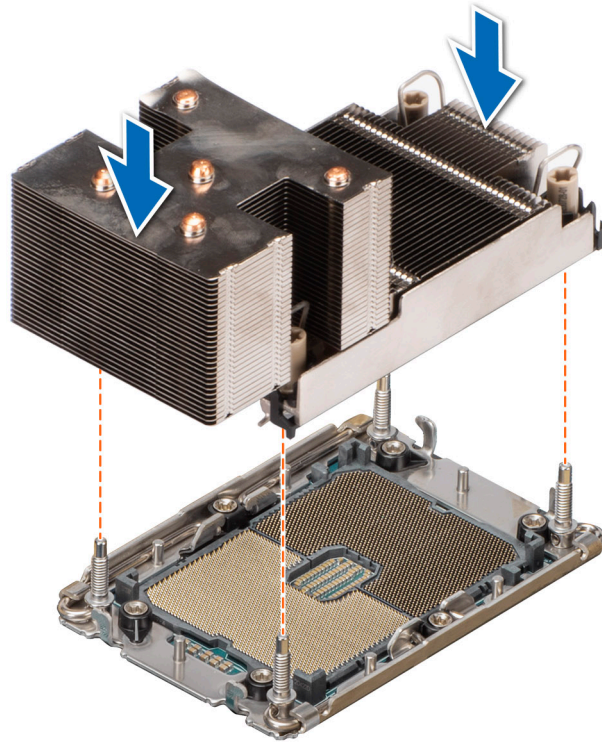

Figure 65. Installing the processor heat sink module

3. Set the anti-tilt wires to the locked position (outward position), and then using the Torx #T30 tool, tighten the captive nuts (8 in-lbf) on the PHM in the order below:
 - a. In a random order, tighten the first nut three turns.
 - b. Tighten the nut diagonally opposite to the nut you tighten first.
 - c. Repeat the procedure for the remaining two nuts.
 - d. Return to the first nut to tighten it completely.
 - e. Check all the nuts to ensure they are firmly secured.

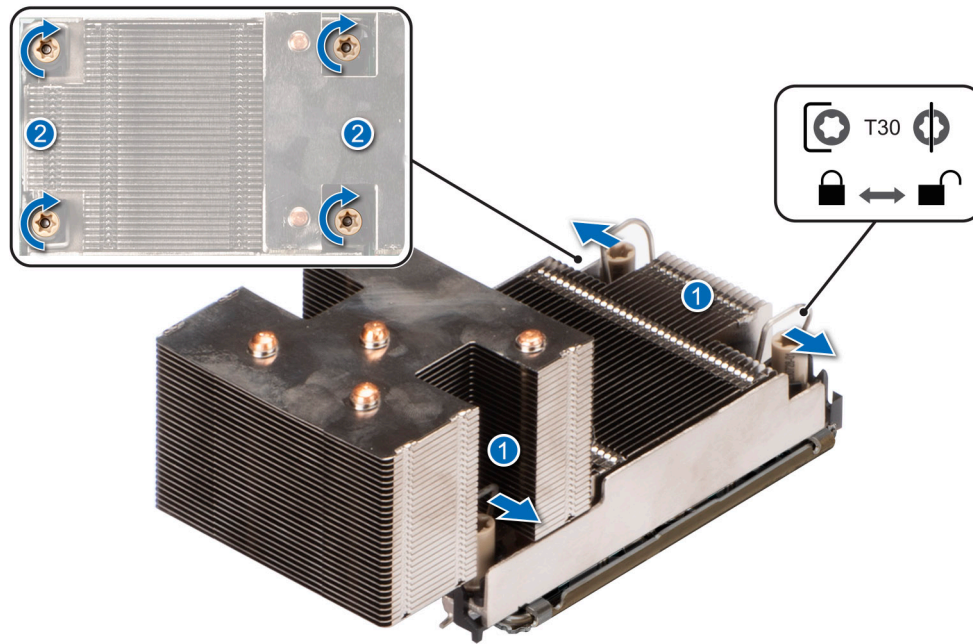

Figure 66. Setting the anti-tilt wires to the locked position and tighten the nuts

Next steps

1. [Install the air shroud.](#)
2. Follow the procedure listed in the [After working inside your system.](#)

Expansion cards

NOTE: When an expansion card is not supported or missing, the iDRAC and Lifecycle Controller logs an event. This does not prevent your system from booting. However, if a F1/F2 pause occurs with an error message, see *Troubleshooting expansion cards* section in the *Dell EMC PowerEdge Servers Troubleshooting Guide* at www.dell.com/poweredgemanuals.

Expansion card installation guidelines

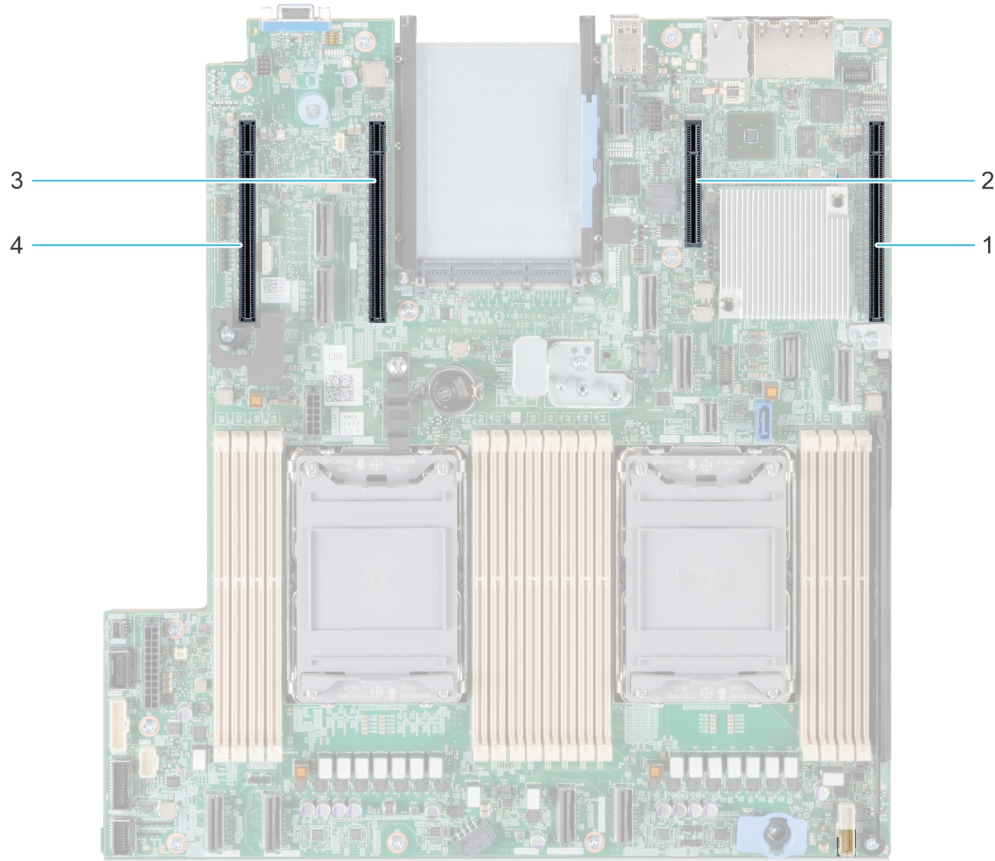

Figure 67. Expansion card slot connectors

1. Slot 1
2. Slot 2
3. Slot 5
4. Slot 6

The following table describes the expansion card configurations:

Table 24. Supported configurations

Configurations	Expansion card risers	PCIe Slots	Controlling processor	Height	Length	Slot width
Config 0	N/A	1	Processor 1	Low profile	Half length	x16
		2	PCH	Low profile	Half length	x4
		5	Processor 2	Low profile	Half length	x16
		6	Processor 2	Low profile	Half length	x16
Config 0-1	N/A	1	Processor 1	Low profile	Half length	x16
		2	PCH	Low profile	Half length	x4

NOTE: The expansion-card slots are not hot-swappable.

The following table provides guidelines for installing expansion cards to ensure proper cooling and mechanical fit. The expansion cards with the highest priority should be installed first using the slot priority indicated. All the other expansion cards should be installed in the card priority and slot priority order.

Table 25. Configuration 0

Card type	Slot priority	Maximum number of cards
Dell Serial port module (LP)	1	1
fPERC	Integrated slot	1
Internal PERC adapter	1	1
fPERC11 H355, Front	Integrated slot	1
12Gbps SAS HBA	1	1
Intel (NIC: 100Gb)	5, 6, 1	3
Mellanox (NIC: 100Gb)	5, 6, 1	3
Broadcom (NIC: 25Gb)	5, 6, 1, 2	1
Intel (NIC: 25Gb)	5, 6, 1, 2	1
Mellanox (NIC: 25Gb)	Not supported	N/a
Mellanox (NIC: 25Gb, LP)	1, 6, 5	3
Qlogic (NIC: 25Gb)	5, 6, 1, 2	1
SolarFlare (NIC: 25Gb)	5, 6, 1, 2	4
Broadcom (NIC: 10Gb)	5, 6, 1, 2	4
Intel (NIC: 10Gb)	5, 6, 1, 2	4
Qlogic (NIC: 10Gb)	5, 6, 1, 2	4
Broadcom (NIC: 1Gb)	5, 6, 1, 2	4
Intel (NIC: 1Gb)	5, 6, 1, 2	4
Mellanox (NIC: HDR100 VPI)	Not supported	N/a
Mellanox (NIC: HDR VPI)	Not supported	N/a
Broadcom (OCP: 25Gb)	Integrated slot	1
Mellanox (OCP 3: 25Gb)	Integrated slot	1
Intel (OCP: 25Gb)	Integrated slot	1
Marvell (OCP: 25Gb)	Integrated slot	1
Mellanox (OCP: 25Gb)	Integrated slot	1
SolarFlare (OCP: 25Gb)	Integrated slot	1
Broadcom (OCP: 10Gb)	Integrated slot	1
Marvell (OCP: 10Gb)	Integrated slot	1
Intel (OCP: 10Gb)	Integrated slot	1
Broadcom (OCP: 1Gb)	Integrated slot	1
Intel (OCP: 1Gb)	Integrated slot	1
Dell External PERC Adapter	5, 6, 1, 2	4
Dell BOSS S1 Module	Integrated slot	1
Samsung (PCIe SSD AIC)	5, 6, 1, 2	4
Intel (PCIe SSD)	Not supported	N/a

Table 26. Configuration0-1

Card type	Slot priority	Maximum number of cards
Dell Serial port module (LP)	1	1
fPERC	Integrated slot	1
Internal PERC adapter	1	1
fPERC11 H355, Front	Integrated slot	1
12Gbps SAS HBA	1	1
Intel (NIC: 100Gb)	1	1
Mellanox (NIC: 100Gb)	1	1
Broadcom (NIC: 25Gb)	1, 2	1
Intel (NIC: 25Gb)	1, 2	1
Mellanox (NIC: 25Gb)	Not supported	N/a
Mellanox (NIC: 25Gb, LP)	1	1
Qlogic (NIC: 25Gb)	1, 2	1
SolarFlare (NIC: 25Gb)	1, 2	4
Broadcom (NIC: 10Gb)	1, 2	4
Intel (NIC: 10Gb)	1, 2	4
Qlogic (NIC: 10Gb)	1, 2	4
Broadcom (NIC: 1Gb)	1, 2	4
Intel (NIC: 1Gb)	1, 2	4
Mellanox (NIC: HDR100 VPI)	Not supported	N/a
Mellanox (NIC: HDR VPI)	Not supported	N/a
Broadcom (OCP: 25Gb)	Integrated slot	1
Intel (OCP: 25Gb)	Integrated slot	1
Marvell (OCP: 25Gb)	Integrated slot	1
Mellanox (OCP: 25Gb)	Integrated slot	1
Mellanox (OCP 3: 25Gb)	Integrated slot	1
SolarFlare (OCP: 25Gb)	Integrated slot	1
Broadcom (OCP: 10Gb)	Integrated slot	1
Marvell (OCP: 10Gb)	Integrated slot	1
Intel (OCP: 10Gb)	Integrated slot	1
Broadcom (OCP: 1Gb)	Integrated slot	1
Intel (OCP: 1Gb)	Integrated slot	1
Dell External PERC Adapter	1, 2	4
Dell BOSS S1 Module	Integrated slot	1
Samsung (PCIe SSD AIC)	1, 2	4
Intel (PCIe SSD)	Not supported	N/a

Removing the expansion card

Prerequisites

1. Follow the safety guidelines listed in the [Safety instructions](#).
2. Follow the procedure listed in the [Before working inside your system](#).
3. If required, [remove the air shroud](#).

Steps

1. Rotate to open the PCIe card holder.
2. Disconnect the cables form the expansion card.
3. By holding the edges lift the expansion card from the PCIe slot on the system board

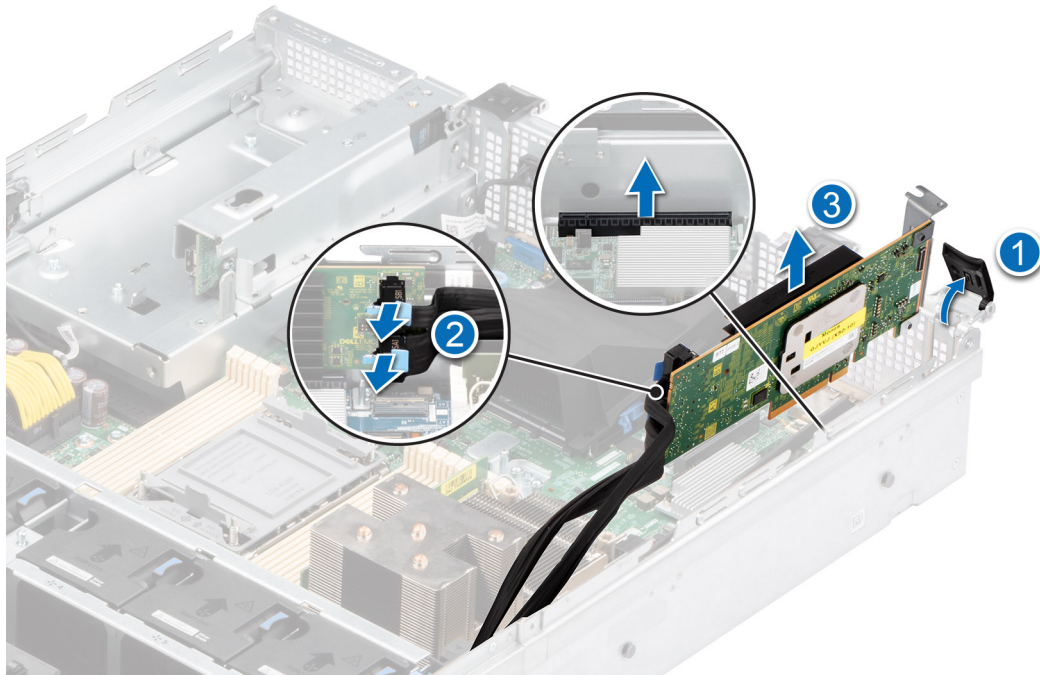

Figure 68. Removing the expansion card

4. Install the metal filler bracket if not replacing the expansion card.

NOTE: The numbers on the image do not depict the exact steps. The numbers are for representation of sequence.

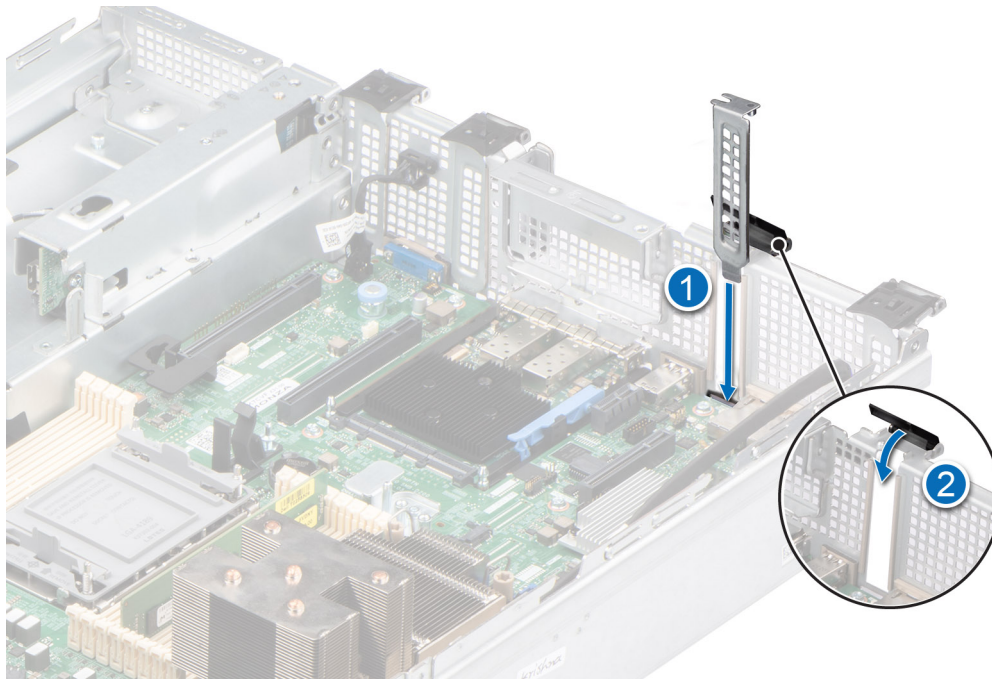

Figure 69. Installing the filler bracket

Next steps

Replace the expansion card.

Installing the expansion card

Prerequisites

1. Follow the safety guidelines listed in the [Safety instructions](#).
2. Follow the procedure listed in the [Before working inside your system](#).
3. If required, [remove the air shroud](#).

Steps

1. Rotate to open the PCIe card holder.
2. If Installed, lift the metal filler bracket from the system.

NOTE: Store the riser blanks for future use. Filler brackets must be installed in empty expansion card slots to maintain Federal Communications Commission (FCC) certification of the system. The brackets also keep dust and dirt out of the system and aid in proper cooling and airflow inside the system.

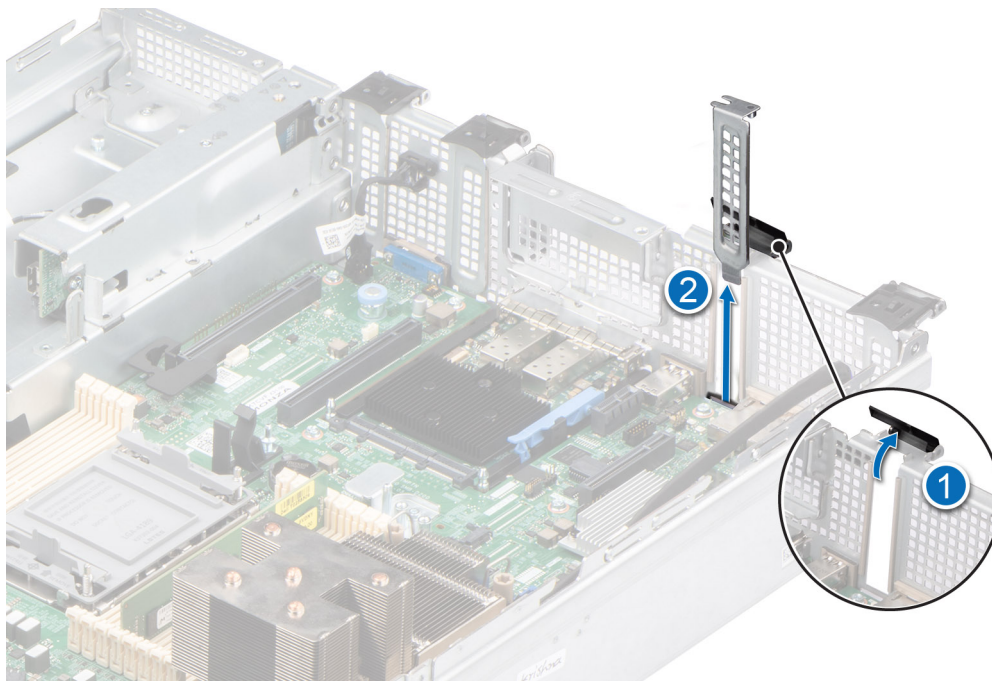

Figure 70. Removing the filler bracket

3. Holding the edges, align the expansion card with the slot on the system.
4. Lower the expansion card into the place and press until the expansion card is fully seated on the PCIe slot.

i **NOTE:** The numbers on the image do not depict the exact steps. The numbers are for representation of sequence.

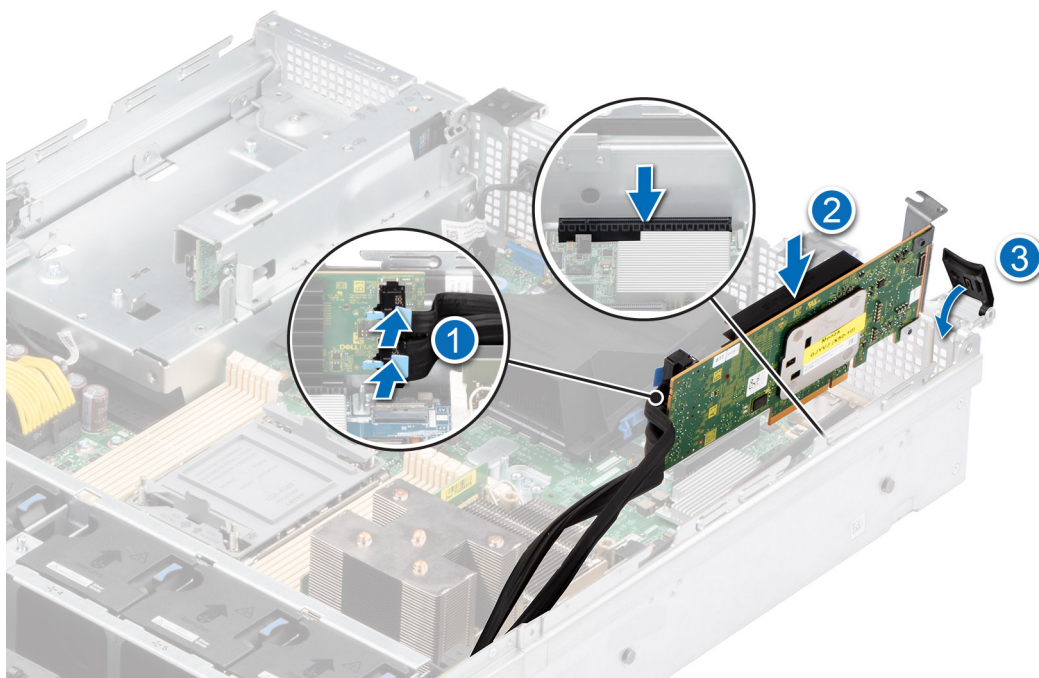

Figure 71. Installing the expansion card

Next steps

1. If removed, [install the air shroud](#).
2. Follow the procedure listed in [After working inside your system](#).

Optional IDSDM module

Removing the IDSDM module

Prerequisites

1. Follow the safety guidelines listed in the [Safety instructions](#).
 2. Follow the procedure listed in the [Before working inside your system](#).
 3. If you are replacing the IDSDM card, [remove the MicroSD cards](#).
- NOTE:** Temporarily label each SD card with its corresponding slot number before removal. Reinstall the SD cards into the corresponding slots.

Steps

Holding the blue pull tab, lift the IDSDM card out of the system.

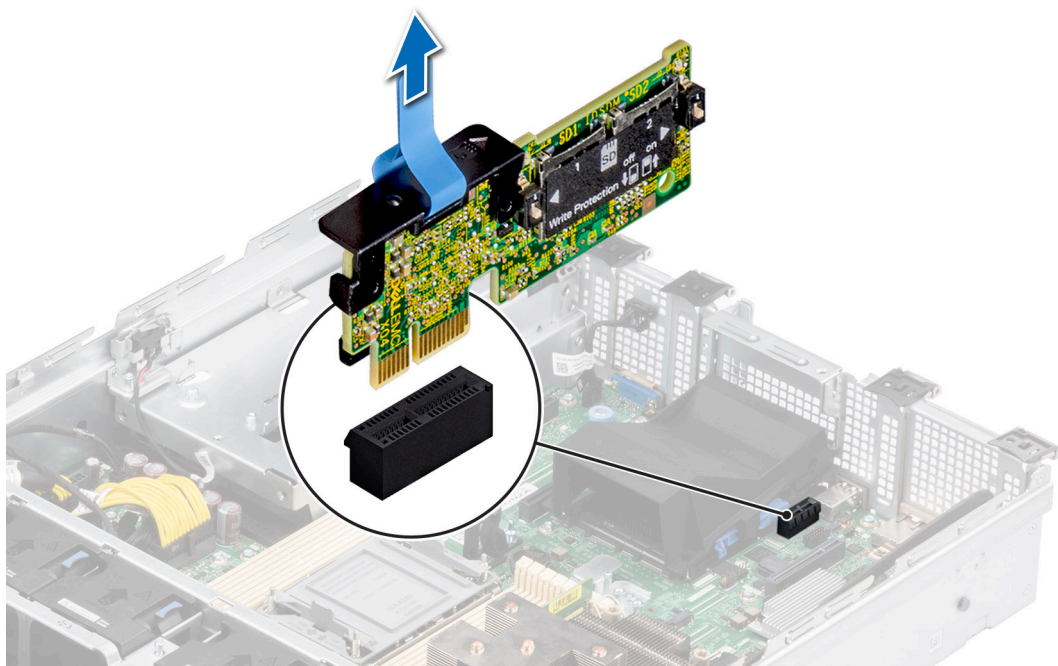

Figure 72. Removing the IDSDM module

Next steps

Replace the IDSDM module.

Installing the IDSDM module

Prerequisites

1. Follow the safety guidelines listed in the [Safety instructions](#).
2. Follow the procedure listed in the [Before working inside your system](#).

Steps

1. Locate the IDSDM connector on the system board.
To locate IDSDM, see the [System board jumpers and connectors section](#).
2. Align IDSDM module with the connector on the system board.

3. Press the IDSDM module, until firmly seated on the system board connector.

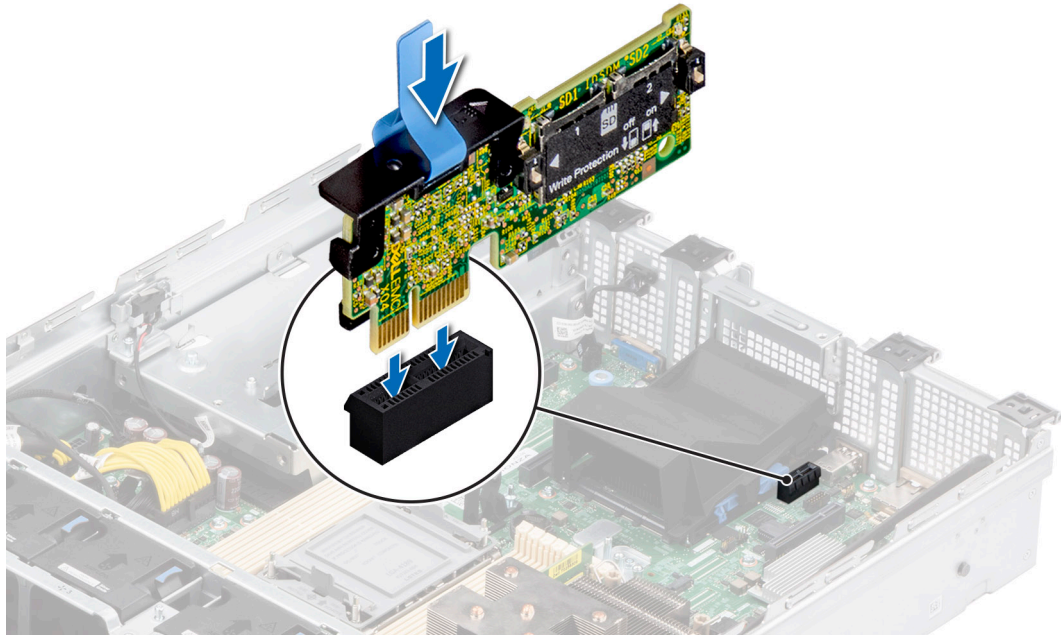

Figure 73. Installing the IDSDM module

Next steps

1. Install the MicroSD cards.

NOTE: Reinstall the MicroSD cards into the same slots based on the labels you had marked on the cards during removal.

2. Follow the procedure listed in the [After working inside your system](#).

Optional BOSS S2 card

Removing the BOSS S2 module

Prerequisites

1. Follow the safety guidelines listed in the [Safety instructions](#).
2. Follow the procedure listed in the [Before working inside your system](#).
3. If required, [remove the air shroud](#).

Steps

1. Pull and lift the BOSS S2 card carrier retention latch lock to open.
2. Slide the BOSS S2 card carrier out.

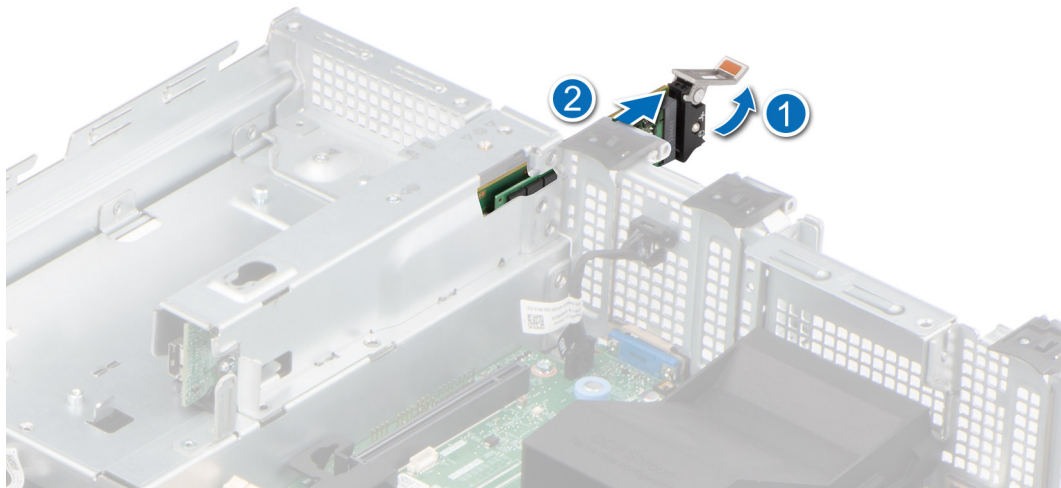

Figure 74. Removing the BOSS S2 card carrier

3. Using the Phillips #1 screwdriver remove the M3 x 0.5 x 4.5 mm screw that secures the M.2 SSD to the BOSS S2 card carrier.
4. Slide the M.2 SSD out from the BOSS S2 card carrier.

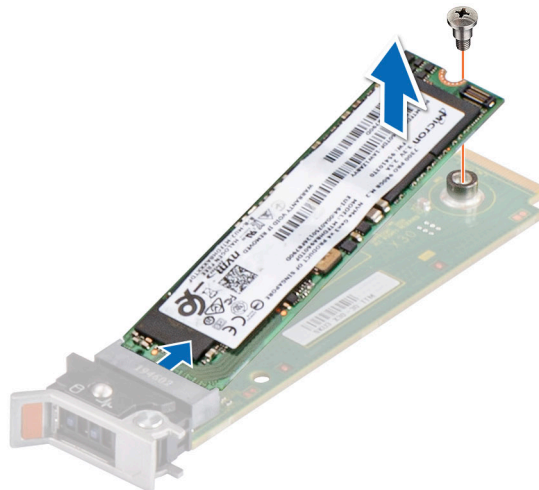

Figure 75. Removing the M.2 SSD

5. Disconnect the BOSS power cable from the PIB and the BOSS signal cable from the motherboard.

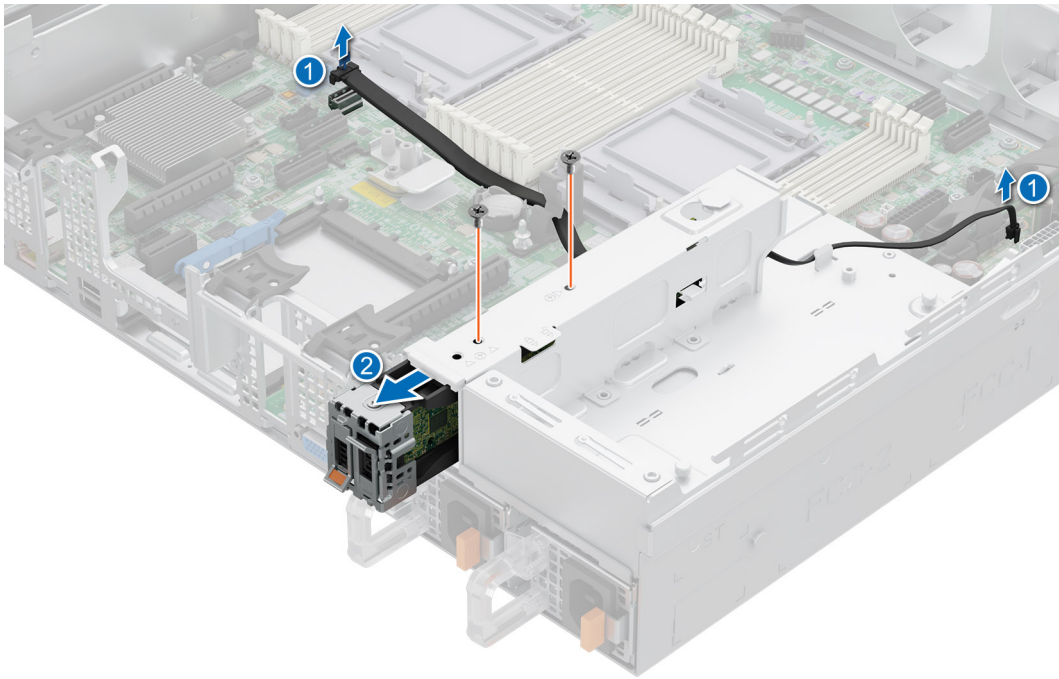

Figure 76. Disconnecting the BOSS power cable and signal cable

6. Using the Phillips #1 screwdriver remove the two M3 x 0.5 x 4.5 mm screws that secure the BOSS S2 module on the BOSS module bay.
7. Slide out the BOSS S2 module from the BOSS module bay.

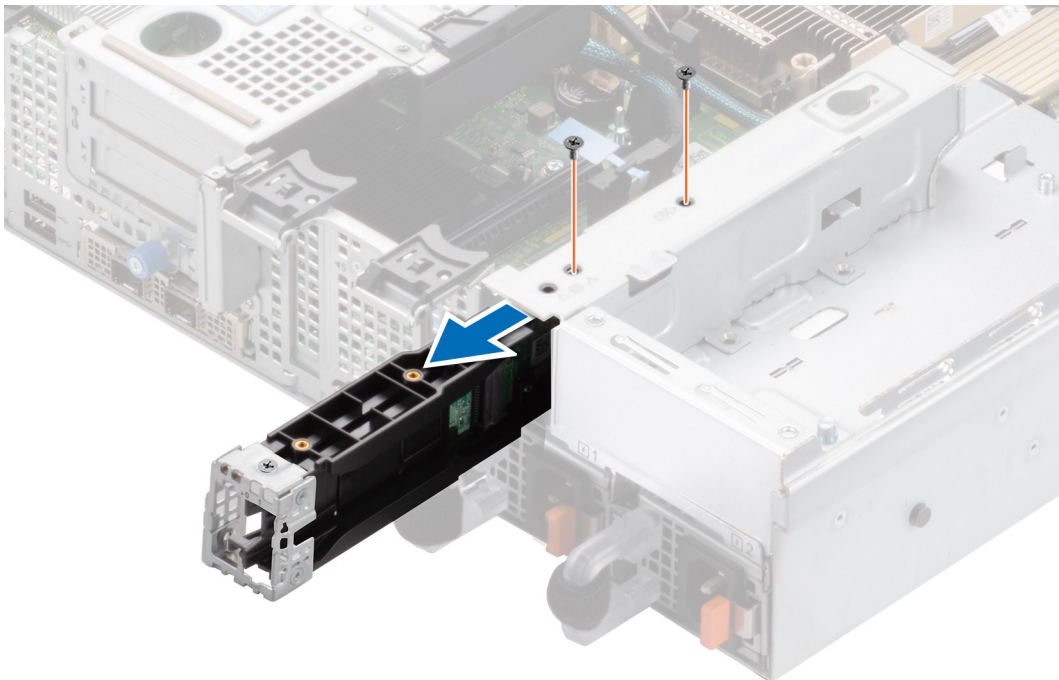
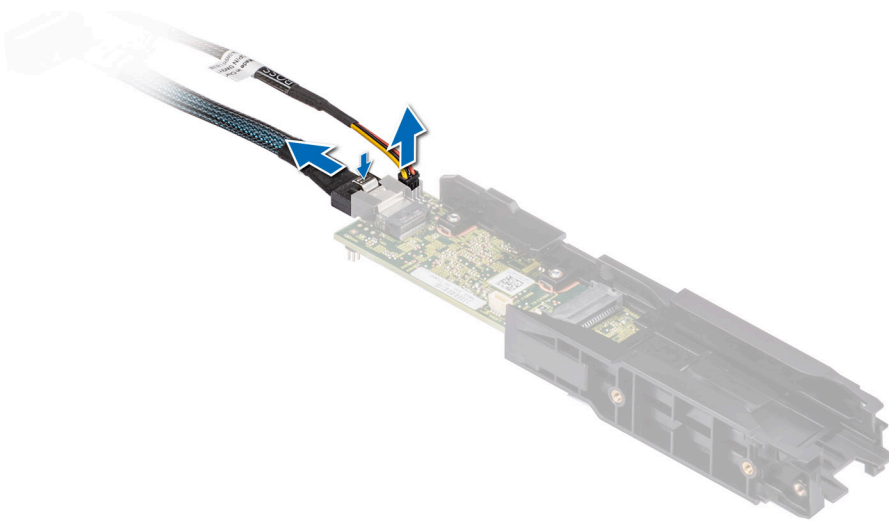

Figure 77. Removing the BOSS S2 module

8. Remove the BOSS power cable and BOSS signal cable from the BOSS S2 controller card module.

Figure 78. Removing the BOSS power cable and BOSS signal cable



9. Using the Phillips #1 screwdriver, remove the M3 x 0.5 x 4.5 mm screw that secures the BOSS cover on the BOSS S2 module. Slide the BOSS cover out from the BOSS S2 module.

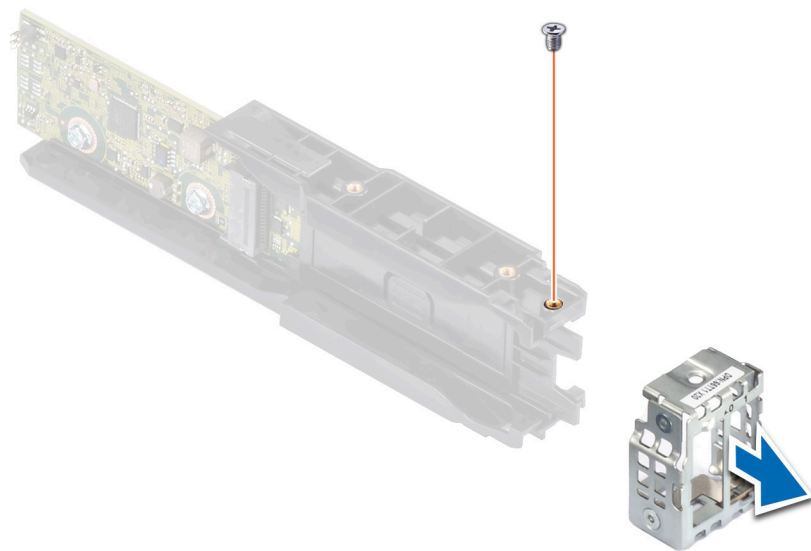

Figure 79. Removing the BOSS cover

Next steps

1. [Replace the BOSS S2 module.](#)

Installing the BOSS S2 module

Prerequisites

1. Follow the safety guidelines listed in the [Safety instructions](#).
2. Follow the procedure listed in the [Before working inside your system](#).
3. If required, [remove the air shroud](#).

Steps

1. Slide the BOSS cover on the BOSS S2 module. Using the Phillips #1 screwdriver, secure the BOSS cover on the BOSS S2 module with the M3 x 0.5 x 4.5 mm screw.

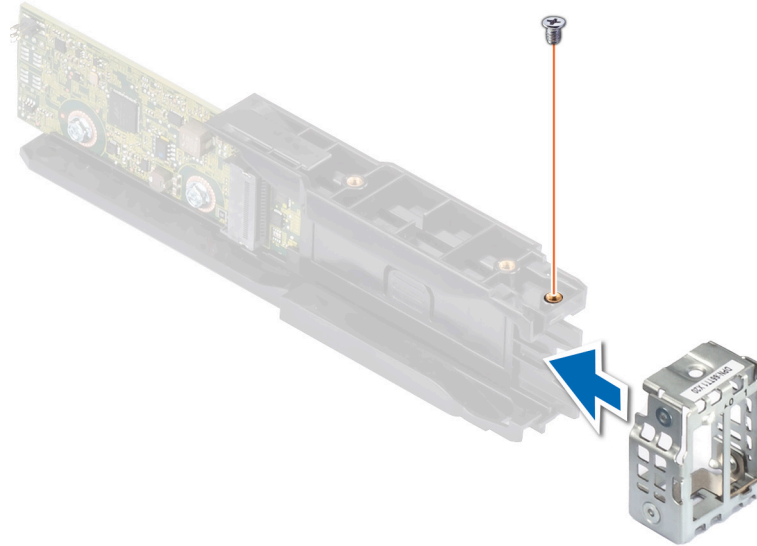

Figure 80. Installing the BOSS cover

2. Connect the BOSS power cable and BOSS signal cable to the BOSS S2 module.

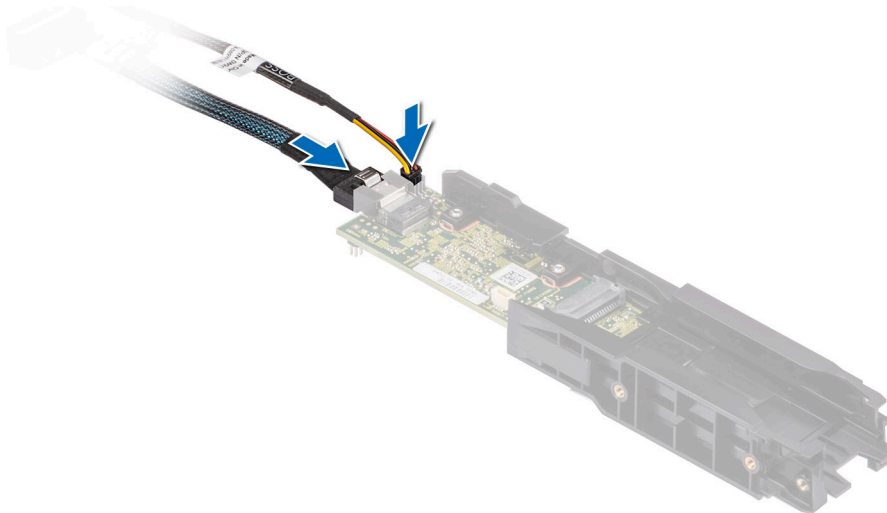

Figure 81. Connecting the BOSS power cable and BOSS Signal cable to the BOSS S2 module

3. Slide the BOSS S2 module into the BOSS module bay until it is firmly seated.
4. Using the Phillips #1 screwdriver, secure the BOSS S2 module on the BOSS module bay with the two M3 x 0.5 x 4.5 mm screws.

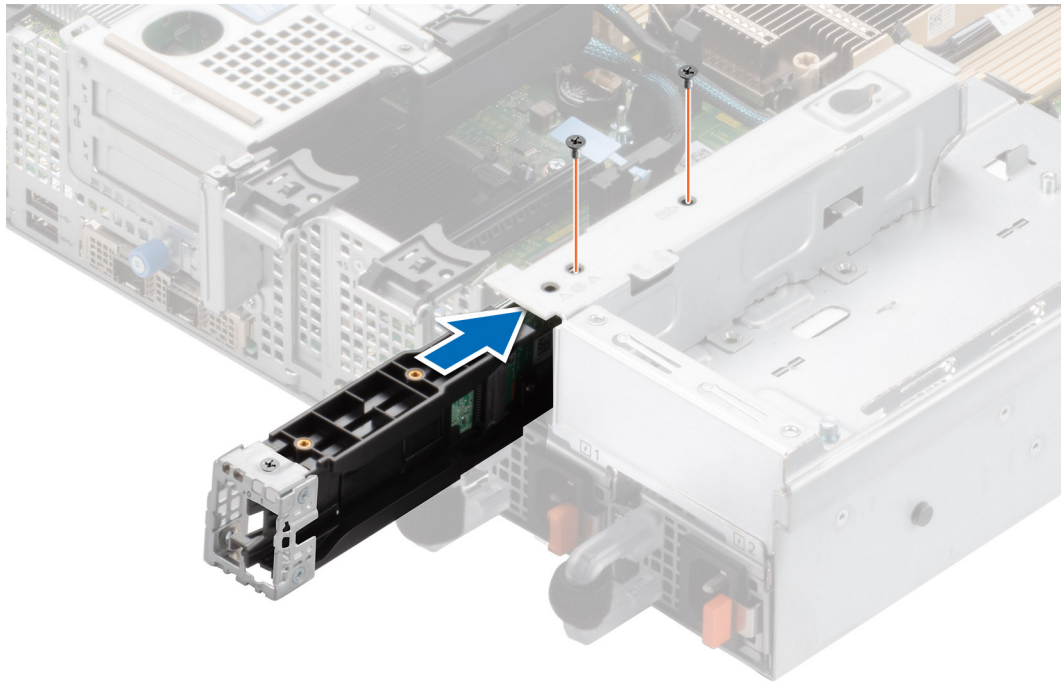

Figure 82. Installing the BOSS S2 module

5. Connect the BOSS power cable to the PIB and the BOSS signal cable to the motherboard.

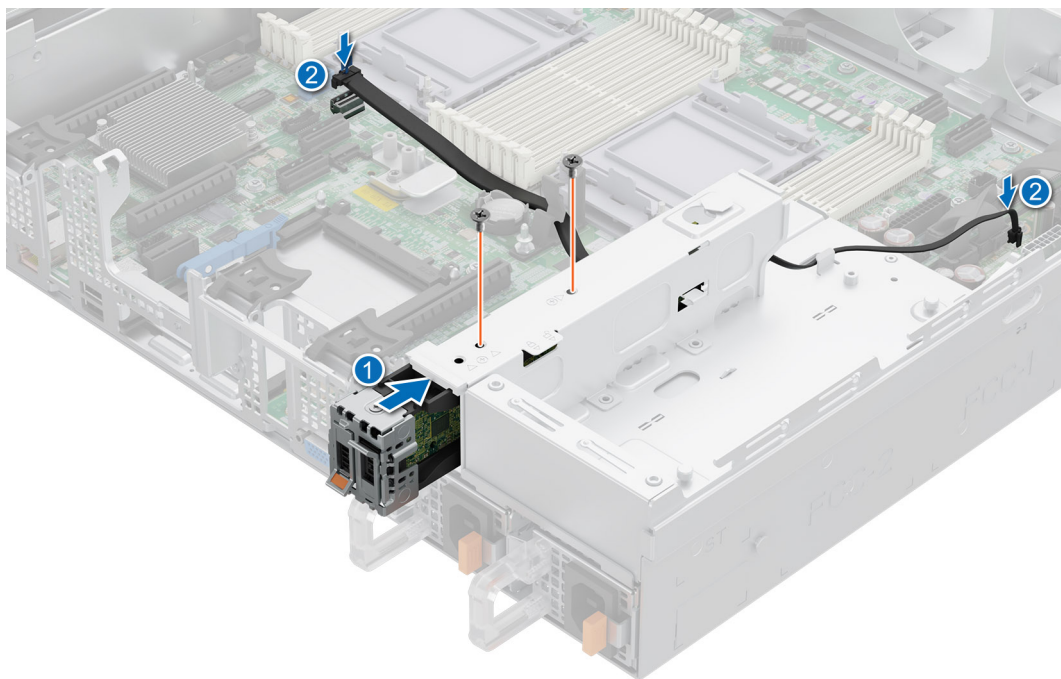

Figure 83. Connecting the BOSS power cable and signal cable

6. Align the M.2 SSD at an angle with the BOSS S2 card carrier.
7. Insert the M.2 SSD until it is firmly seated in the BOSS S2 card carrier.
8. Using the Phillips #1 screwdriver, secure the M.2 SSD on the BOSS S2 card carrier with the M3 x 0.5 x 4.5 mm screw.

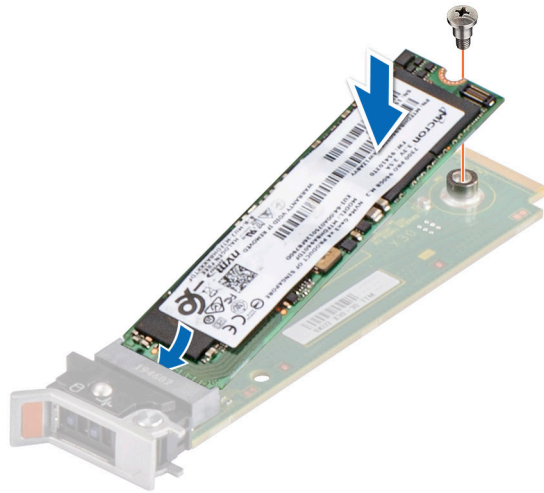

Figure 84. Installing the M.2 SSD

9. Slide the BOSS S2 card carrier into the BOSS S2 module slot.
10. Close the BOSS S2 card carrier release latch to lock the carrier in place.

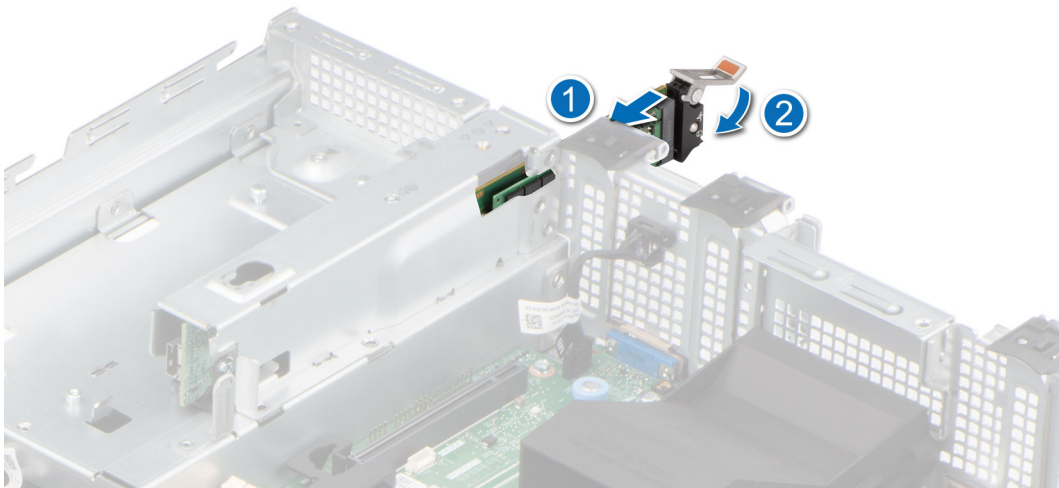

Figure 85. Installing the BOSS S2 card carrier

Next steps

1. If removed, [install the air shroud](#).
2. Follow the procedure listed in the [After working inside your system](#).

Front mounting front PERC module

This is a service technician replaceable part only.

Removing the front mounting front PERC module

Prerequisites

1. Follow the safety guidelines listed in the [Safety instructions](#).

2. Follow the procedure listed in the [Before working inside your system](#).
3. [Remove the air shroud](#).
4. [Remove the drive backplane cover](#).
5. [Remove the cooling fan cage assembly](#).
6. Disconnect the PERC cable from the system board connector, observe the cable routing.

Steps

1. Using a Phillips #2 screwdriver, loosen the captive screws on the front PERC module.
2. Pull the front PERC module to disengage from the connector on the drive backplane.
3. Lift the front PERC module out of the system.

 **NOTE:** The numbers on the image do not depict the exact steps. The numbers are for representation of sequence.

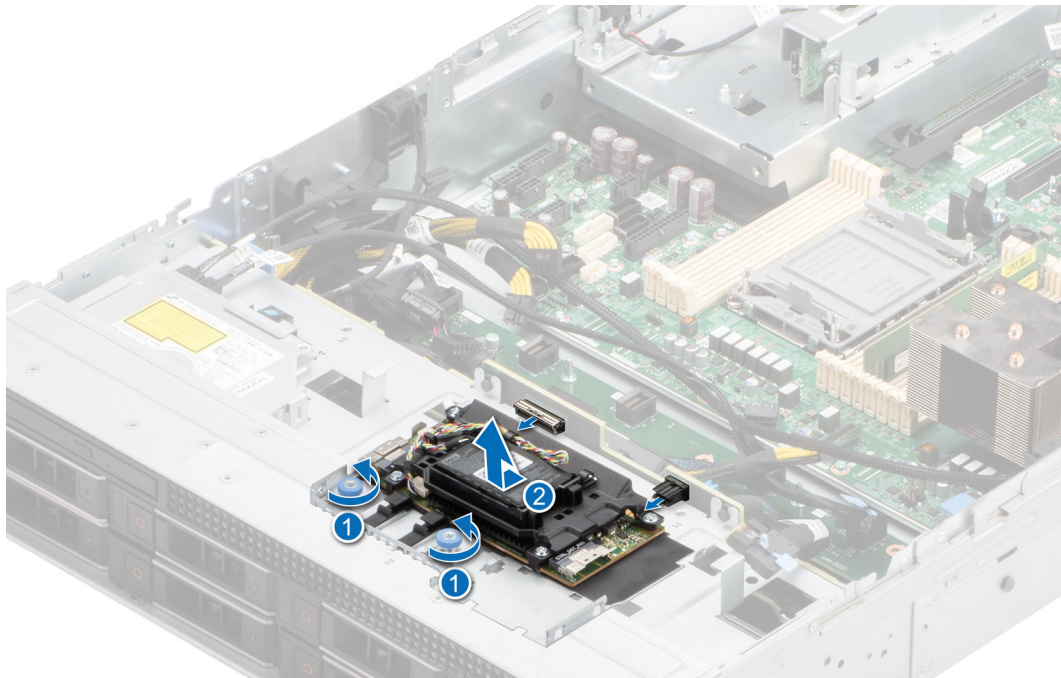

Figure 86. Removing the front mounting front PERC module

Next steps

1. [Replace the front mounting front PERC module](#).

Installing the front mounting front PERC module

Prerequisites

1. Follow the safety guidelines listed in the [Safety instructions](#).
2. Follow the procedure listed in the [Before working inside your system](#).
3. [Remove the air shroud](#).
4. [Remove the drive backplane cover](#).
5. [Remove the cooling fan cage assembly](#).
6. Route the cable properly to prevent the cable from being pinched or crimped.

Steps

1. Align the front PERC module at an angle until the tray touches the slot in the system.
2. Press the front PERC module connector with the connector on the drive backplane until firmly seated.
3. Using a Phillips #2 screwdriver, tighten the captive screws on the front PERC module.

NOTE: The numbers on the image do not depict the exact steps. The numbers are for representation of sequence.

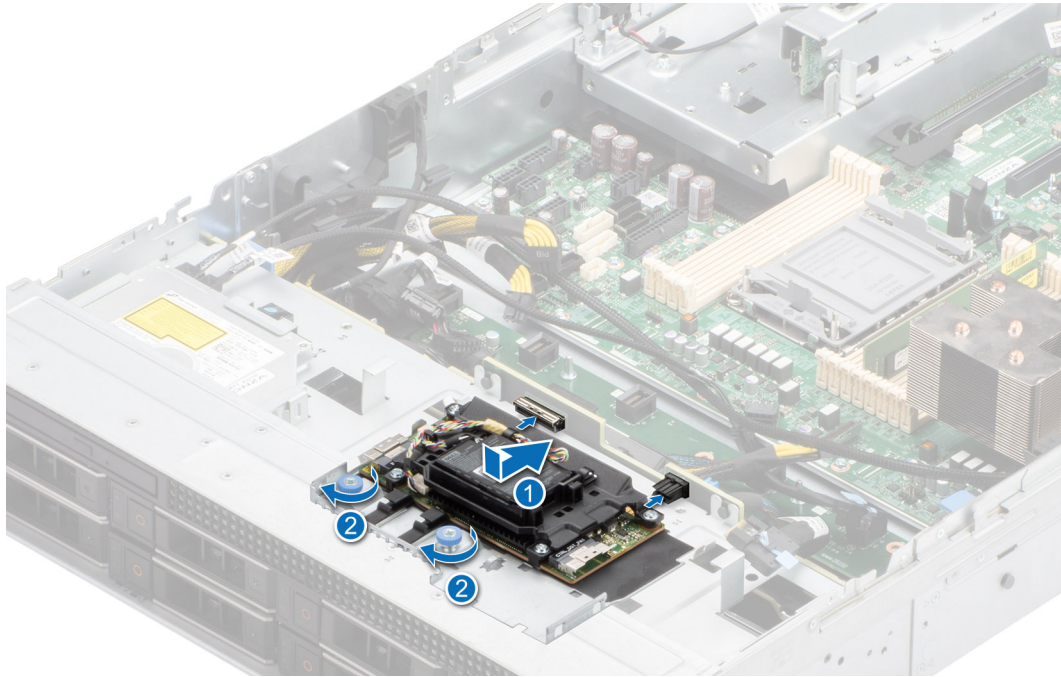

Figure 87. Installing the front mounting front PERC module

Next steps

1. Connect the PERC cables to the backplane and system board connectors.
2. [Install the cooling fan cage assembly.](#)
3. [Install the drive backplane cover.](#)
4. [Install the air shroud.](#)
5. Follow the procedure listed in [After working inside your system.](#)

Optional OCP card

Removing the OCP shroud

Prerequisites

1. Follow the safety guidelines listed in the [Safety instructions.](#)
2. Follow the procedure listed in the [Before working inside your system.](#)

Steps

Hold the edges of the OCP shroud and lift the shroud at an angle out of the system.

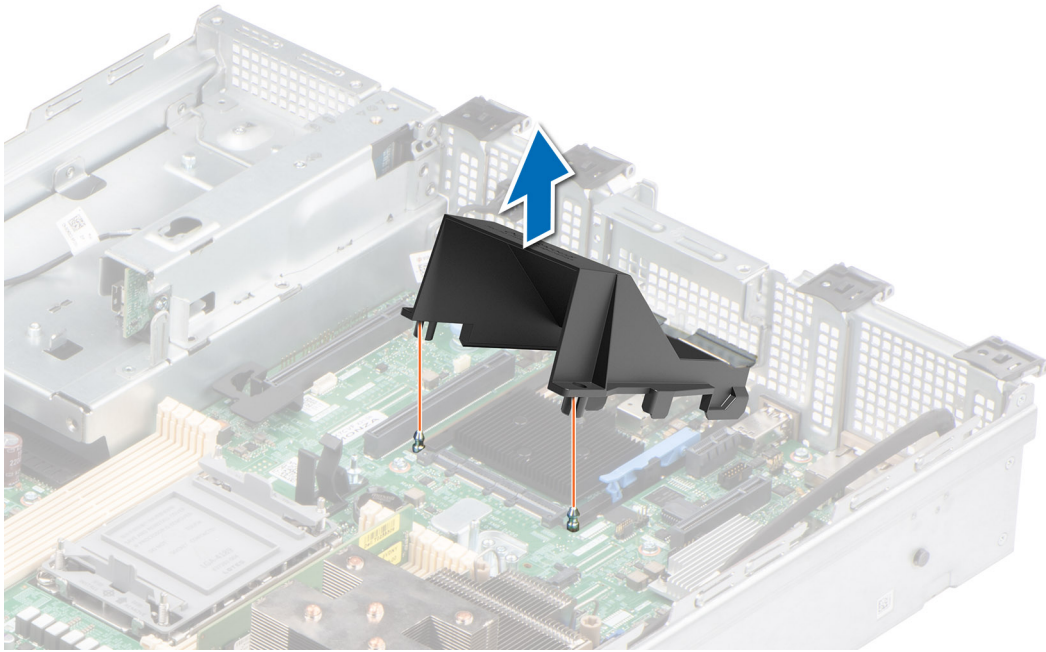

Figure 88. Removing the OCP shroud

Next steps

Replace the OCP shroud.

Installing the OCP shroud

Prerequisites

1. Follow the safety guidelines listed in the [Safety instructions](#).
2. Follow the procedure listed in the [Before working inside your system](#).

Steps

1. Place the OCP shroud at an angle and align the slot on the OCP shroud with the standoff on the system.
2. Lower and press the OCP shroud until it clicks into place.

Figure 89. Installing the OCP shroud

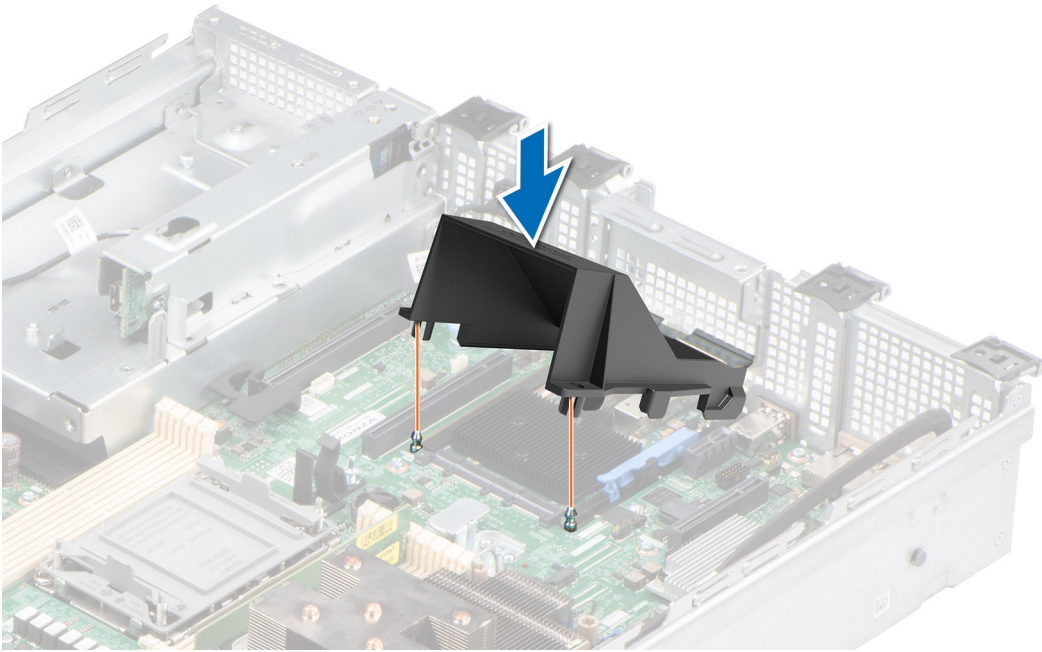

Next steps

1. Follow the procedure listed in [After working inside your system.](#)

Removing the OCP card

Prerequisites

1. Follow the safety guidelines listed in the [Safety instructions.](#)
2. Follow the procedure listed in the [Before working inside your system.](#)
3. [Remove the OCP shroud.](#)

Steps

1. Open the blue latch to disengage the OCP card.
2. Push the OCP card towards the rear end of the system to disconnect from the connector on the system board.
3. Slide the OCP card out of the slot on the system.

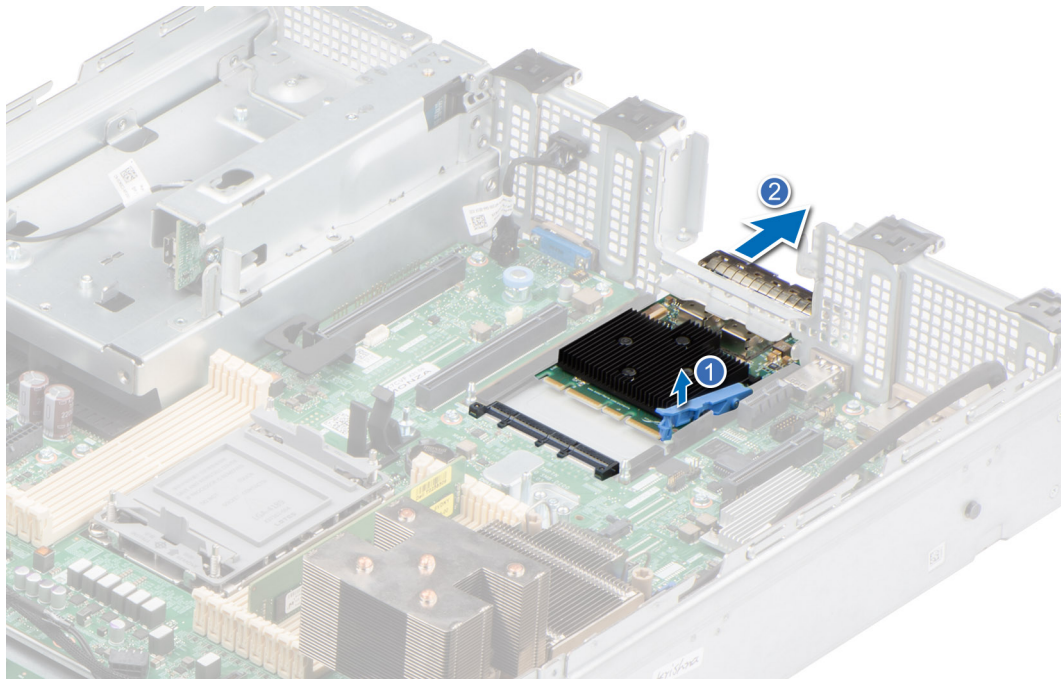

Figure 90. Removing the OCP card

4. If the OCP card is not going to be replaced, install a filler bracket.

Next steps

Replace the OCP card.

Installing the OCP card

Prerequisites

1. Follow the safety guidelines listed in the [Safety instructions](#).
2. Follow the procedure listed in the [Before working inside your system](#).
3. [Remove the OCP shroud](#).

Steps

1. If installed, remove the filler bracket.
2. Open the blue latch on the system board.
3. Slide the OCP card into the slot in the system.
4. Push until the OCP card is connected to the connector on the system board.
5. Close the blue latch to lock the OCP card to the system.

Figure 91. Installing the OCP card

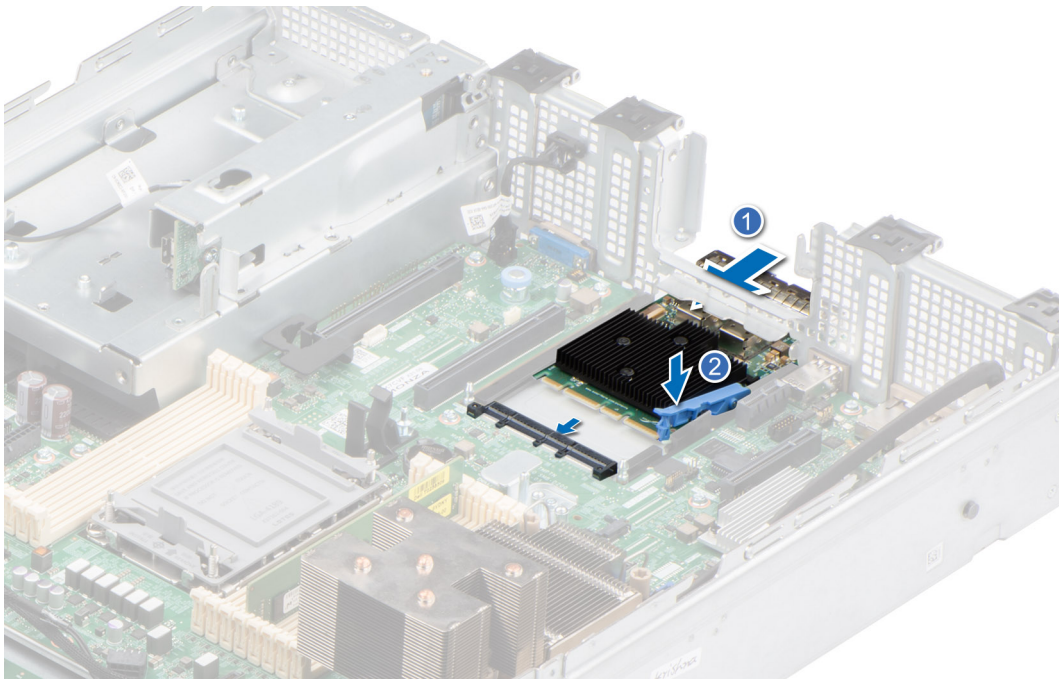

Next steps

1. [Install the OCP shroud.](#)
2. Follow the procedure listed in [After working inside your system.](#)

System battery

This is a service technician replaceable part only.

Replacing the system battery

Prerequisites

⚠ WARNING: There is a danger of a new battery exploding if it is incorrectly installed. Replace the battery only with the same or equivalent type recommended by the manufacturer. Discard used batteries according to the manufacturer's instructions. See the Safety instructions that came with your system for more information.

1. Follow the safety guidelines listed in the [Safety instructions.](#)
2. Follow the procedure listed in the [Before working inside your system.](#)
3. If required, move aside the cable that pass over the battery.

Steps

1. To remove the battery:
 - a. Use a plastic scribe to pry out the system battery.

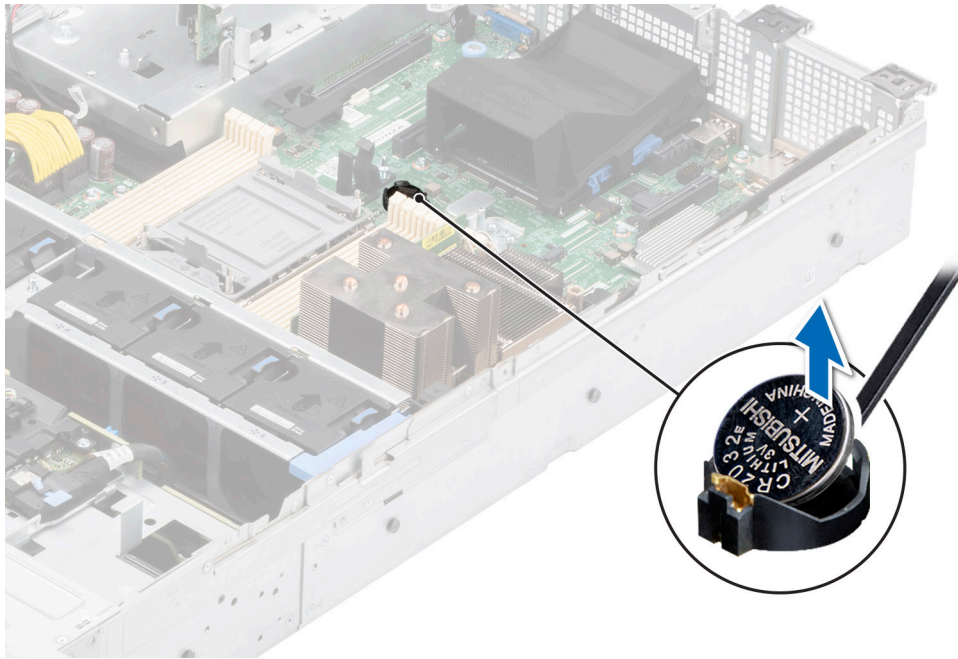

Figure 92. Removing the system battery

CAUTION: To avoid damage to the battery connector, you must firmly support the connector while installing or removing a battery.

2. To install a new system battery:
 - a. Hold the battery with the positive side facing up and slide it under the securing tabs.
 - b. Press the battery into the connector until it snaps into place.

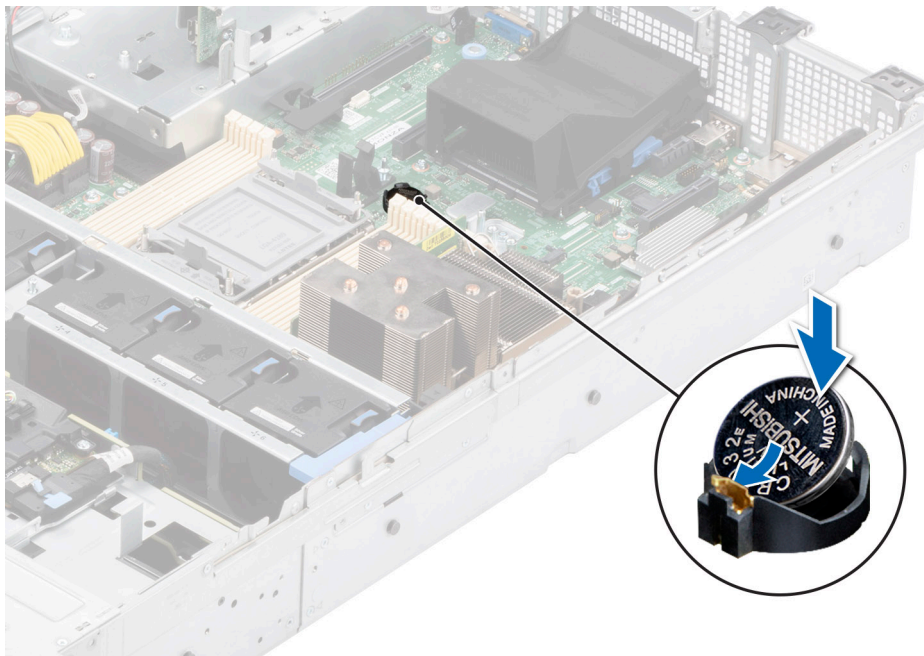

Figure 93. Installing the system battery

Next steps

1. Follow the procedure listed in the [After working inside your system](#).
2. Confirm that the battery is operating properly, by performing the following steps:

- a. Enter the System Setup, while booting, by pressing F2.
- b. Enter the correct time and date in the System Setup **Time** and **Date** fields.
- c. **Exit** the System Setup.
- d. To test the newly installed battery, remove the system from the enclosure for at least an hour.
- e. Reinstall the system into the enclosure after an hour.
- f. Enter the System Setup and if the time and date are still incorrect, see [Getting help](#) section.

Optional internal USB card

NOTE: To locate the internal USB port on the system board, see the [System board jumpers and connectors](#) section.

Removing the internal USB card

Prerequisites

CAUTION: To avoid interference with other components in the server, the maximum permissible dimensions of the USB memory key are 15.9 mm width x 57.15 mm length x 7.9 mm height.

1. Follow the safety guidelines listed in the [Safety instructions](#).
2. Follow the procedure listed in the [Before working inside your system](#).

Steps

1. Holding the blue tag, lift the internal USB card to disconnect from the connector on the system board.
2. Remove the USB memory key from the internal USB card.

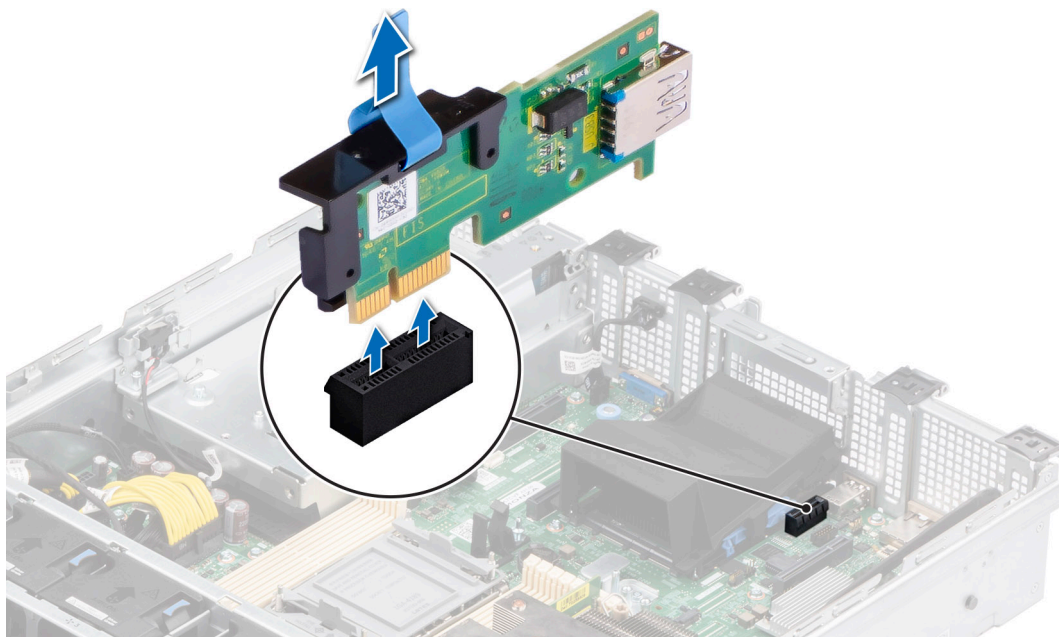

Figure 94. Removing the internal USB card

Next steps

Replace the internal USB card.

Installing the internal USB card

Prerequisites

1. Follow the safety guidelines listed in the [Safety instructions](#).
2. Follow the procedure listed in the [Before working inside your system](#).

Steps

1. Connect the USB key to the internal USB card.

NOTE: For information on the exact location of USB on system board, see [System board jumpers and connectors](#) section

2. Align the internal USB card with the connector on the system board and press firmly until the internal USB card is seated.

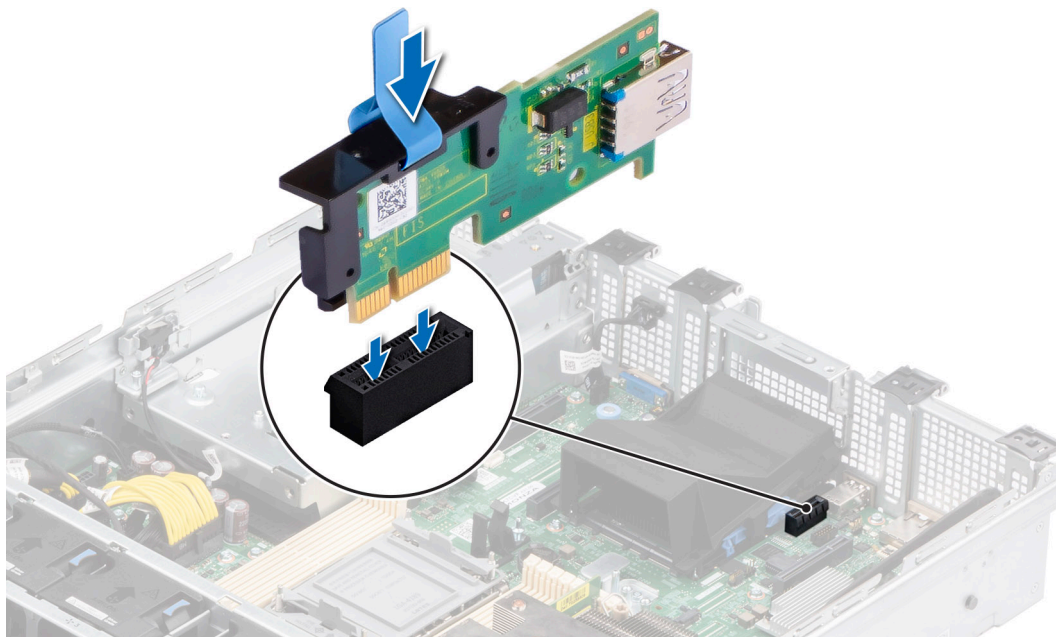

Figure 95. Installing the internal USB card

Next steps

1. Follow the procedure listed in [After working inside your system](#).
2. While booting, press F2 to enter **System Setup** and verify that the system detects the USB memory key.

MicroSD card

Removing the MicroSD card

Prerequisites

1. Follow the safety guidelines listed in the [Safety instructions](#).
2. Follow the procedure listed in the [Before working inside your system](#).
3. [Remove the IDSDM module](#).

Steps

1. Locate the MicroSD card slot on the IDSDM module, and press the card to partially release it from the slot. For more information on the slot location, see [System board jumpers and connectors section](#).
2. Hold the MicroSD card and remove it from the slot.

NOTE: Temporarily label each MicroSD card with its corresponding slot number after removal.

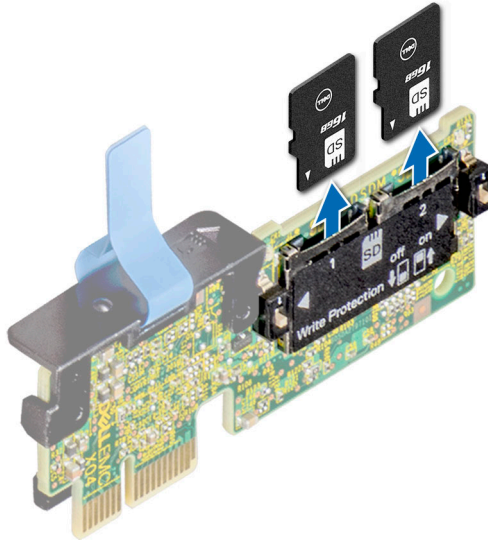

Figure 96. Removing the MicroSD card

Next steps

Replace the MicroSD cards.

Installing the MicroSD card

Prerequisites

1. Follow the safety guidelines listed in the [Safety instructions](#).
2. Follow the procedure listed in [Before working inside your system](#).

NOTE: To use an MicroSD card with your system, ensure that the **Internal SD Card Port** is enabled in System Setup.

NOTE: Ensure that you install the MicroSD cards into the same slots based on the labels you had marked on the cards during removal.

Steps

1. Locate the MicroSD card slot on the IDSDM module. Orient the MicroSD card appropriately and insert the contact-pin end of the card into the slot. To locate IDSDM, see the [System board jumpers and connectors section](#).

NOTE: The slot is keyed to ensure correct insertion of the card.

2. Press the card into the slot to lock it into place.

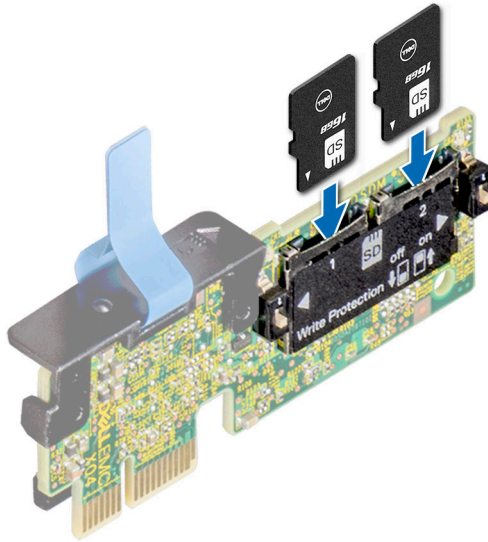

Figure 97. Installing the MicroSD card

Next steps

1. [Install the IDSDM module.](#)
2. Follow the procedure listed in the [After working inside your system.](#)

Power supply unit

NOTE: While replacing the hot swappable PSU, after next server boot; the new PSU automatically updates to the same firmware and configuration of the replaced one. For updating to the latest firmware and changing the configuration, see the *Lifecycle Controller User's Guide* at <https://www.dell.com/idracmanuals>.

NOTE: For information about DC PSU cabling instructions, see the *Cabling instructions for – (48 – 60) V DC power supply* Tech sheet that is shipped with your DC PSU.

Hot spare feature

Your system supports the hot spare feature that significantly reduces the power overhead associated with the power supply unit (PSU) redundancy.

When the hot spare feature is enabled, one of the redundant PSUs is switched to the sleep state. The active PSU supports 100 percent of the system load, thus operating at higher efficiency. The PSU in the sleep state monitors output voltage of the active PSU. If the output voltage of the active PSU drops, the PSU in the sleep state returns to an active output state.

If having both PSUs active is more efficient than having one PSU in the sleep state, the active PSU can also activate the sleeping PSU.

The default PSU settings are as follows:

- If the load on the active PSU is more than 50 percent of PSU rated power wattage, then the redundant PSU is switched to the active state.
- If the load on the active PSU falls below 20 percent of PSU rated power wattage, then the redundant PSU is switched to the sleep state.

You can configure the hot spare feature by using the iDRAC settings. For more information, see the *iDRAC User's Guide* available at www.dell.com/poweredgemanuals.

Removing a power supply unit blank

Prerequisites

Follow the safety guidelines listed in the [Safety instructions](#).

Steps

Pull the blank out of the system.

CAUTION: To ensure proper system cooling, the PSU blank must be installed in the second PSU bay in a non-redundant configuration. Remove the PSU blank only if you are installing a second PSU.

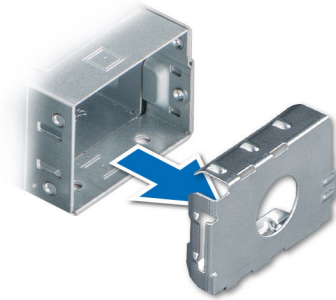

Figure 98. Removing a power supply unit blank

Next steps

Replace the PSU blank or install the PSU.

Installing a power supply unit blank

Prerequisites

1. Follow the safety guidelines listed in the [Safety instructions](#).
NOTE: Install the power supply unit (PSU) blank only in the second PSU bay.
2. Remove the PSU.

Steps

Align the PSU blank with the PSU bay and push it into the PSU bay until it clicks into place.

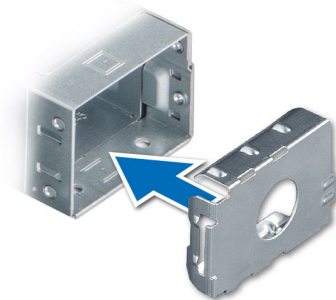

Figure 99. Installing a power supply unit blank

Removing a power supply unit

Prerequisites

CAUTION: The system requires one power supply unit (PSU) for normal operation. On power-redundant systems, remove and replace only one PSU at a time in a system that is powered on.

1. Follow the safety guidelines listed in the [Safety instructions](#).
2. Disconnect the power cable from the power outlet and from the Power Supply Unit (PSU) you intend to remove.
3. Remove the cable from the strap on the PSU handle.
4. Unlatch and lift the optional cable management arm if it interferes with the PSU removal.

For information about the cable management arm, see the system's rack documentation at <https://www.dell.com/poweredgemanuals>.

Steps

Press the orange release latch, and holding the PSU handle slide the PSU out of the PSU bay.

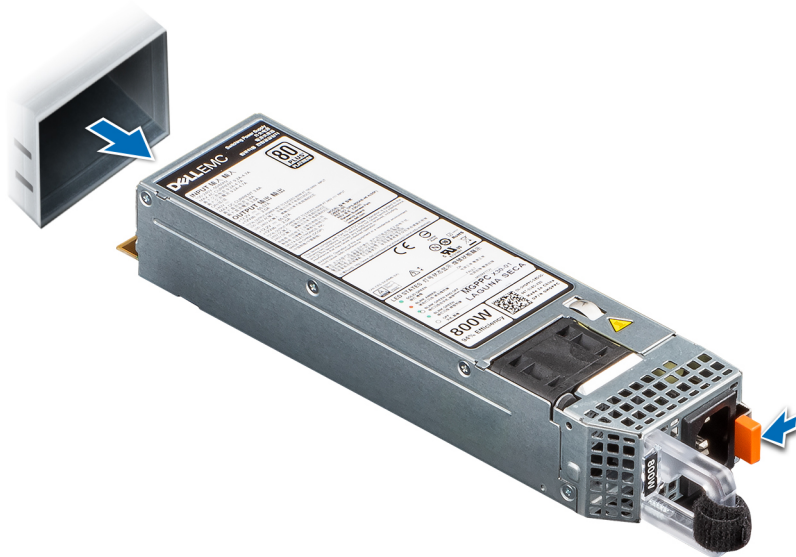

Figure 100. Removing a power supply unit

Next steps

Replace the PSU or install the PSU blank.

Installing a power supply unit

Prerequisites

1. Follow the safety guidelines listed in the [Safety instructions](#).
2. For systems that support redundant Power Supply Units (PSUs), ensure that both the PSUs are of the same type and have the same maximum output power.
 - NOTE:** The maximum output power (shown in watts) is listed on the PSU label.
3. Remove the PSU blank.

Steps

Slide the PSU into the PSU bay until the release latch snaps into place.

NOTE: The numbers on the image do not depict the exact steps. The numbers are for representation of sequence.



Figure 101. Installing a power supply unit

Next steps

1. If you have unlatched the cable management arm, relatch it. For information about the cable management arm, see the system's rack documentation at <https://www.dell.com/poweredge/manuals>.
2. Connect the power cable to the PSU, and plug the cable into a power outlet.

CAUTION: When connecting the power cable to the PSU, secure the cable to the PSU with the strap.

NOTE: When installing, hot swapping, or hot adding a new PSU, wait for 15 seconds for the system to recognize the PSU and determine its status. The PSU redundancy may not occur until discovery is complete. The PSU status indicator turns green to indicate that the PSU is functioning properly.

NOTE: For certain premium configurations with high power consumption, system PSU might stay with 2+0 mode only, 1+1 redundant mode is not available.

NOTE: While replacing the hot swappable PSU, after next server boot; the new PSU automatically updates to the same firmware and configuration of the replaced one. For more information about the Part replacement configuration, see the *Lifecycle Controller User's Guide* at <https://www.dell.com/idrac/manuals>

Power interposer board

This is a service technician replaceable part only.

Removing the power interposer board

Prerequisites

1. Follow the safety guidelines listed in the [Safety instructions](#).
2. Follow the procedure listed in the [Before working inside your system](#).
3. [Remove the air shroud](#).
4. [Remove the PSU](#).
5. Disconnect the cables that are connected to power interposer board (PIB) and observe the cable routing.

Steps

1. Using a Phillips #2 screwdriver, remove the screws securing the PIB to the system.
2. Lift the PIB away from the system.

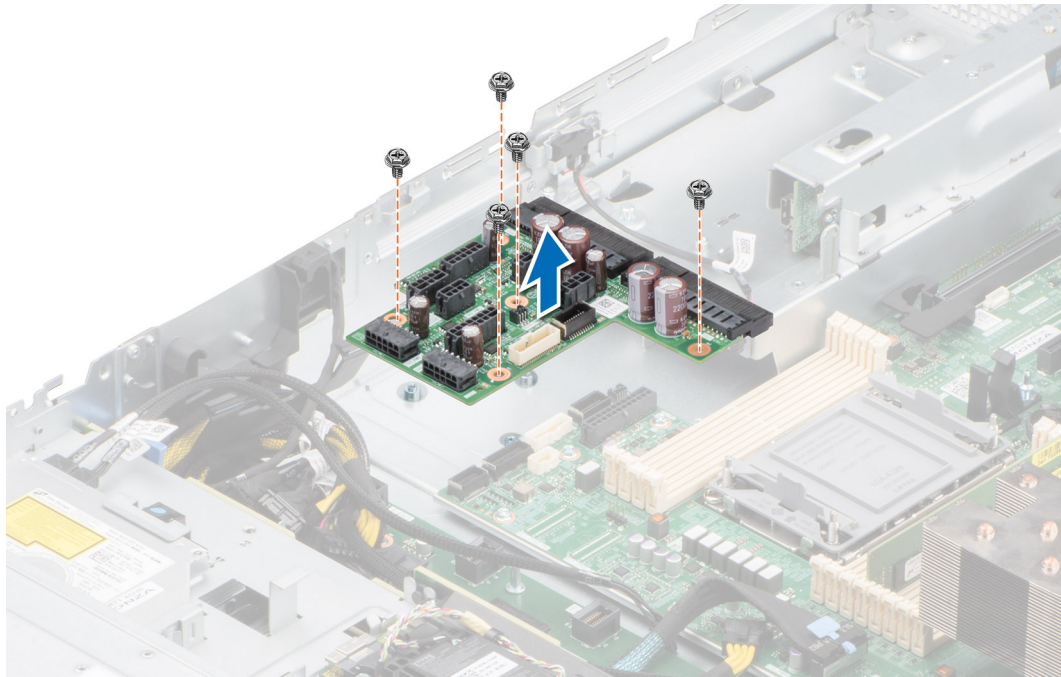

Figure 102. Removing the power interposer board

Next steps

Replace the power interposer board.

Installing the power interposer board

Prerequisites

1. Follow the safety guidelines listed in the [Safety instructions](#).
2. Follow the procedure listed in the [Before working inside your system](#).
3. [Remove the air shroud](#).
4. [Remove the PSU](#).
5. Disconnect the cables that are connected to power interposer board (PIB) and observe the cable routing.

Steps

1. Align the slots on the power interposer board (PIB) with the hook on the system and lower it into place.
2. Using Phillips #2 screwdriver, tighten the screws to secure the PIB to the system.

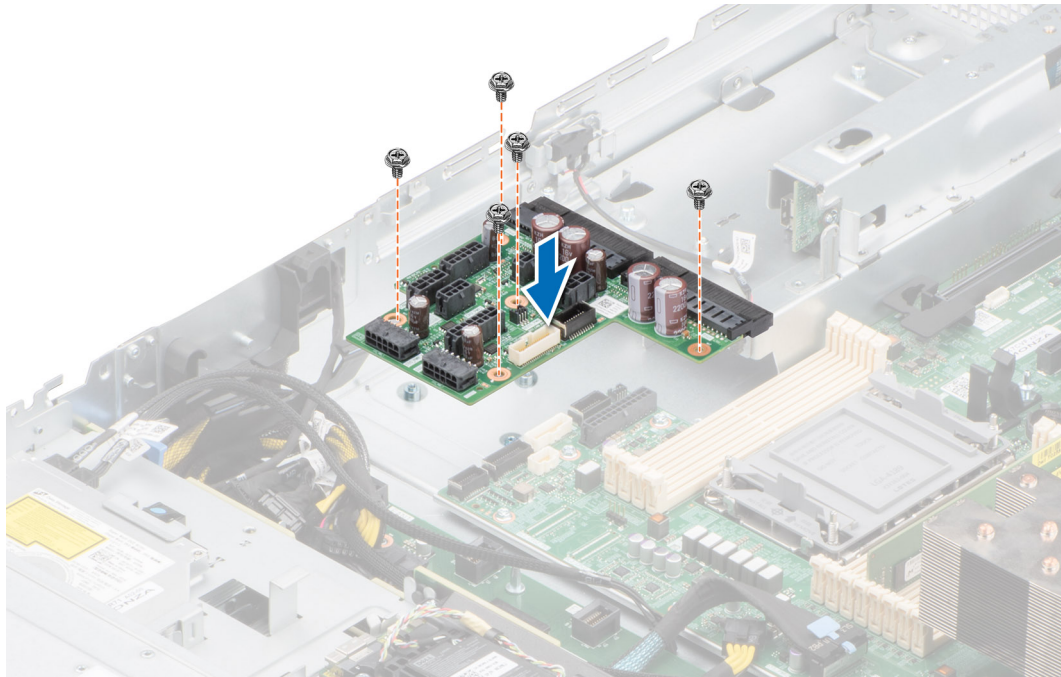

Figure 103. Installing the power interposer board

Next steps

1. Connect the cables to the PIB and route them properly.
2. [Install the PSU.](#)
3. [Install the air shroud.](#)
4. Follow the procedure listed in [After working inside your system.](#)

Cooling fan cage board

Removing the cooling fan cage board

Prerequisites

1. Follow the safety guidelines listed in the [Safety instructions.](#)
2. Follow the procedure listed in the [Before working inside your system.](#)
3. Remove the following components:
 - a. [Air shroud](#)
 - b. [Cooling fan cage assembly](#)
4. Disconnect cables from the fan board.

Steps

1. Using a Phillips #2 screwdriver, remove the screws that secures the fan board to the system.
2. Holding the edges lift the fan board out of the system.

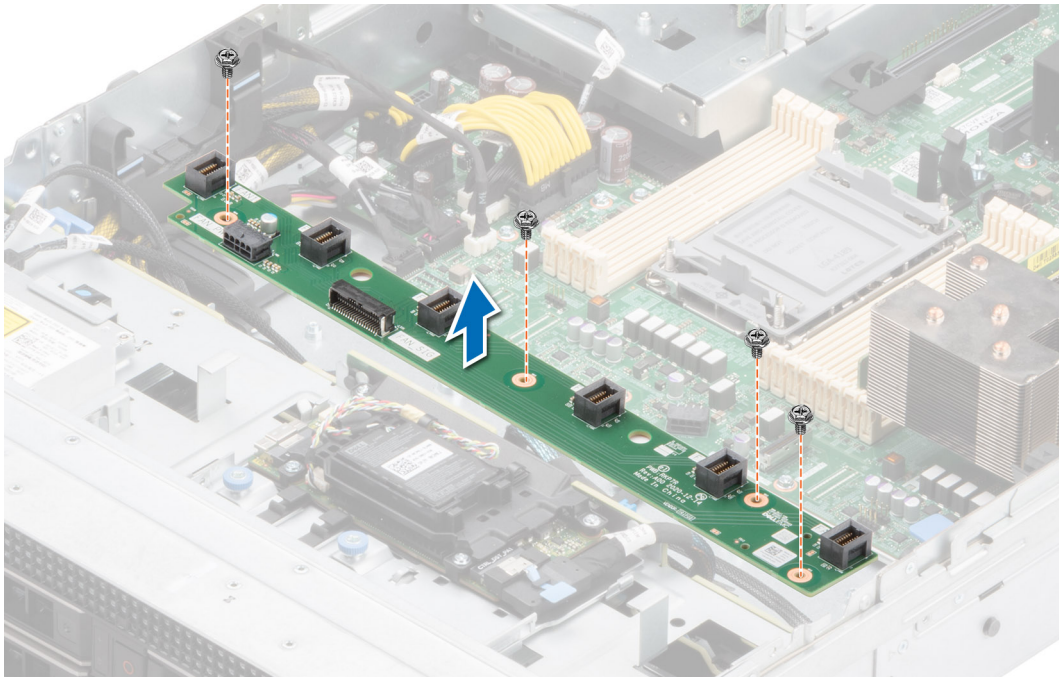

Figure 104. Removing the cooling fan cage board.

Next steps

Replace the cooling fan cage board.

Installing the cooling fan cage board

Prerequisites

1. Follow the safety guidelines listed in the [Safety instructions](#).
2. Follow the procedure listed in [Before working inside your system](#).
3. Remove the following components:
 - a. [Air shroud](#)
 - b. [Cooling fan cage assembly](#)
4. Disconnect cables from the fan board.

Steps

1. Align and lower the fan board with the screw holes in the system.
2. Using a Phillips #2 screwdriver, tighten the screws that secures the fan board to the system

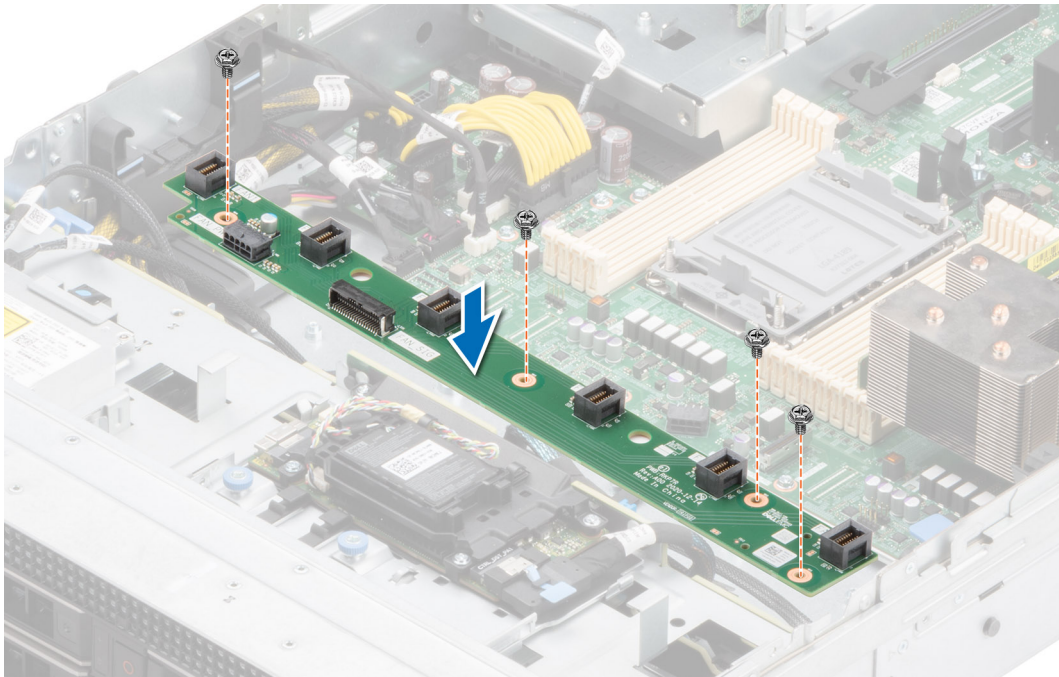

Figure 105. Installing the cooling fan cage board

Next steps

1. Connect cables to the fan board.
2. Replace the following components:
 - a. [Cooling fan cage assembly](#)
 - b. [Air shroud](#)
3. Follow the procedure listed in [After working inside your system](#).

System board

This is a service technician replaceable part only.

Removing the system board

Prerequisites

CAUTION: If you are using the Trusted Platform Module (TPM) with an encryption key, you may be prompted to create a recovery key during program or System Setup. Be sure to create and safely store this recovery key. If you replace this system board, you must supply the recovery key when you restart your system or program before you can access the encrypted data on your drives.

1. Follow the safety guidelines listed in the [Safety instructions](#).
2. Follow the procedure listed in the [Before working inside your system](#).
3. Remove the following components:
 - a. [Air shroud](#)
 - b. [Cooling fan cage assembly](#)
 - c. [Expansion cards](#)
 - d. [IDSDM module \(if installed\)](#)
 - e. [Internal USB key \(if installed\)](#)
 - f. [Processor and heat sink module](#)
 - g. [Memory modules](#)
 - h. [OCP \(if installed\)](#)

- i. OCP shroud
- j. Disconnect all cables from the system board.

 **CAUTION:** Take care not to damage the system identification button while removing the system board from the system.

Steps

1. Using the system board holder and plunger, slide the system board toward the front of the chassis.
2. By using holder and plunger that is located on system board and lift the system board out of the chassis, leaning at an angle.

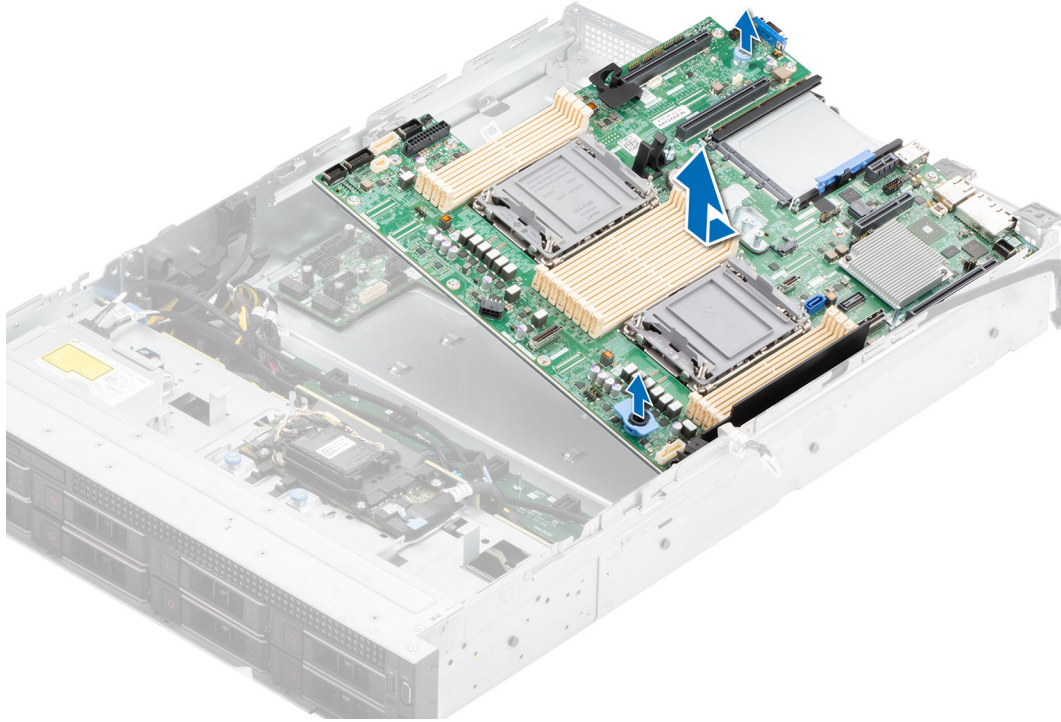



Figure 106. Removing the system board

Next steps

Replace the system board.

Installing the system board

Prerequisites

 **NOTE:** Before replacing the system board, replace the old iDRAC MAC address label in the Information tag with the iDRAC MAC address label of the replacement system board

1. Follow the safety guidelines listed in the [Safety instructions](#).
2. Follow the procedure listed in [Before working inside your system](#).
3. If you are replacing the system board, remove all the components that are listed in the [removing the system board](#) section.

Steps

1. Unpack the new system board assembly.

 **CAUTION:** Do not lift the system board by holding a memory module, processor, or other components.

CAUTION: Take care not to damage the system identification button while placing the system board into the chassis.

2. Using the system board holder and plunger, lower the system board leaning at an angle into the system.
3. Slide the system board towards the rear of the chassis until the connectors are firmly seated in the slots.

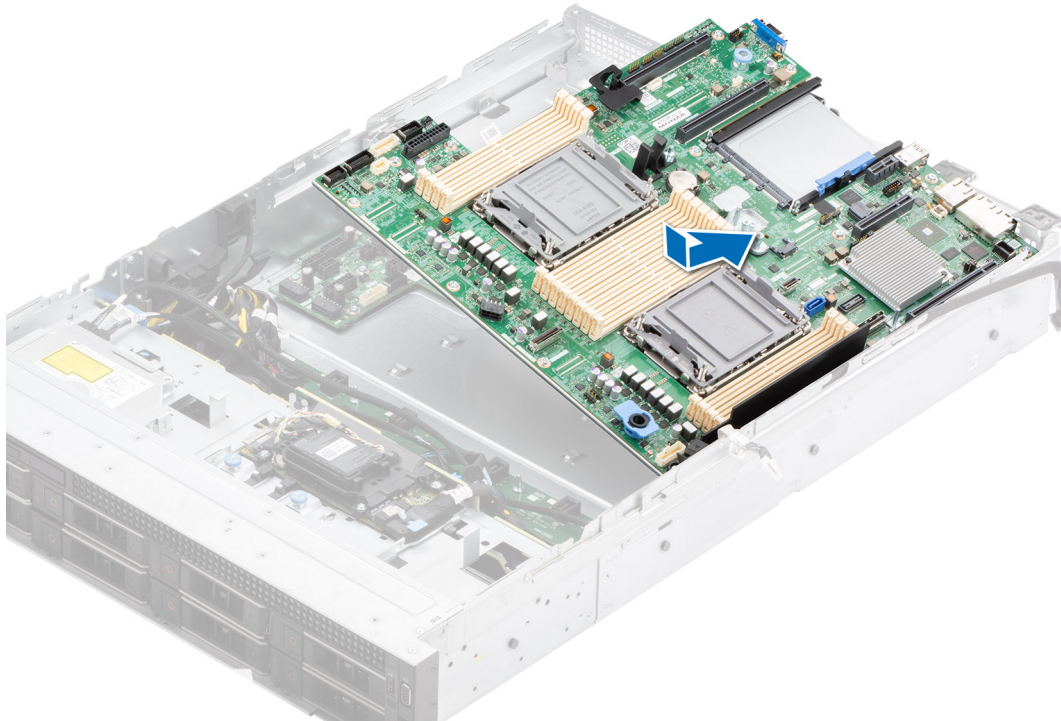

Figure 107. Installing the system board

Next steps

1. Replace the following components:
 - a. [Trusted Platform Module \(TPM\)](#)
i **NOTE:** The TPM Module must be replaced only while installing new system board.
 - b. [IDSDM module \(if removed\)](#)
 - c. [Internal USB key \(if removed\)](#)
 - d. [Expansion cards](#)
 - e. [Cooling fan cage assembly](#)
 - f. [Processor and heat sink module](#)
 - g. [Memory modules](#)
 - h. [OCP \(if removed\)](#)
 - i. [OCP shroud](#)
 - j. [Air shroud](#)
2. Reconnect all cables to the system board.
i **NOTE:** Ensure that the cables inside the system are routed along the chassis wall and secured using the cable securing bracket.
3. Ensure that you perform the following steps:
 - a. Use the Easy Restore feature to restore the Service Tag. See the [Restoring the system by using the Easy Restore feature](#) section.
 - b. If the service tag is not backed up in the backup flash device, enter the system service tag manually. See the [Manually update the Service Tag by using System Setup](#) section.
 - c. Update the BIOS and iDRAC versions.
Re-enable the Trusted Platform Module (TPM). See the [Upgrading the Trusted Platform Module](#) section.



4. If you are not using Easy restore, import your new or existing iDRAC Enterprise license. For more information, see the *Integrated Dell Remote Access Controller User's Guide* available at <https://www.dell.com/idracmanuals>.
5. Follow the procedure listed in [After working inside your system](#).

Restoring the system using Easy Restore

The Easy Restore feature enables you to restore your service tag, license, UEFI configuration, and the system configuration data after replacing the system board. All data is backed up in a backup flash device automatically. If BIOS detects a new system board, and the service tag in the backup flash device, BIOS prompts the user to restore the backup information.

About this task

Below is a list of options/steps available:

- Restore the service tag, license, and diagnostics information, press **Y**
- Navigate to the Lifecycle Controller based restore options, press **N**
- Restore data from a previously created **Hardware Server Profile**, press **F10**
 **NOTE:** When the restore process is complete, BIOS prompts to restore the system configuration data.
- Restore data from a previously created **Hardware Server Profile**, press **F10**
- To restore the system configuration data, press **Y**
- To use the default configuration settings, press **N**
-  **NOTE:** After the restore process is complete, system reboots.

Trusted Platform Module

This is a service technician replaceable part only.

Upgrading the Trusted Platform Module

Removing the TPM

Prerequisites

-  **NOTE:**
- Ensure the operating system is compatible with the TPM version you are installing.
 - Ensure that you download and install the latest BIOS firmware on your system.
 - Ensure that the BIOS is configured to enable UEFI boot mode.

 **CAUTION:** The TPM plug-in module is cryptographically bound to that particular system board after it is installed. When the system is powered on, any attempt to remove an installed TPM plug-in module breaks the cryptographic binding, and the removed TPM cannot be installed on another system board. Ensure any keys you have stored on the TPM have been securely transferred.

Steps

1. Locate the TPM connector on the system board. For more information, see [System board connectors](#).
2. Press to hold the module down and remove the screw using the security Torx 8-bit shipped with the TPM module.
3. Slide the TPM module out from its connector.
4. Push the plastic rivet away from the TPM connector and rotate it 90° counterclockwise to release it from the system board.
5. Pull the plastic rivet out of its slot on the system board.

Installing the TPM

Steps

1. To install the TPM, align the edge connectors on the TPM with the slot on the TPM connector.
2. Insert the TPM into the TPM connector such that the plastic rivet aligns with the slot on the system board.
3. Press the plastic rivet until the rivet snaps into place.
4. Replace the screw that secures the TPM to the system board.

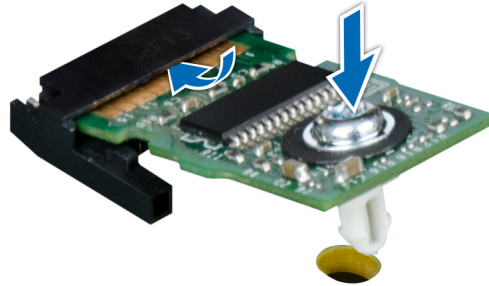

Figure 108. Installing the TPM

Initializing TPM for users

Steps

1. Initialize the TPM.
For more information, see [Initializing the TPM for users](#).
2. The **TPM Status** changes to **Enabled, Activated**.

Initializing the TPM 1.2 for users

Steps

1. While booting your system, press F2 to enter System Setup.
2. On the **System Setup Main Menu** screen, click **System BIOS > System Security Settings**.
3. From the **TPM Security** option, select **On with Preboot Measurements**.
4. From the **TPM Command** option, select **Activate**.
5. Save the settings.
6. Restart your system.

Initializing the TPM 2.0 for users

Steps

1. While booting your system, press F2 to enter System Setup.
2. On the **System Setup Main Menu** screen, click **System BIOS > System Security Settings**.
3. From the **TPM Security** option, select **On**.
4. Save the settings.
5. Restart your system.

Control panel

This is a service technician replaceable part only.

Removing the left control panel

Prerequisites

1. Follow the safety guidelines listed in the [Safety instructions](#).
2. Follow the procedure listed in the [Before working inside your system](#).
3. [Remove the air shroud](#).
4. [Remove the drive backplane cover](#).
5. [Remove the cooling fan cage assembly](#).

Steps

1. Disconnect the control panel cable from the system board connector.

NOTE: Observe the routing of the cable as you remove it from the system.

2. Using the Phillips #1 screwdriver, remove the screws that secure the cable cover and left control panel assembly to the system.
3. Remove the cable cover away the system.
4. Holding the left control panel assembly , remove the control panel along with the cable from the system.

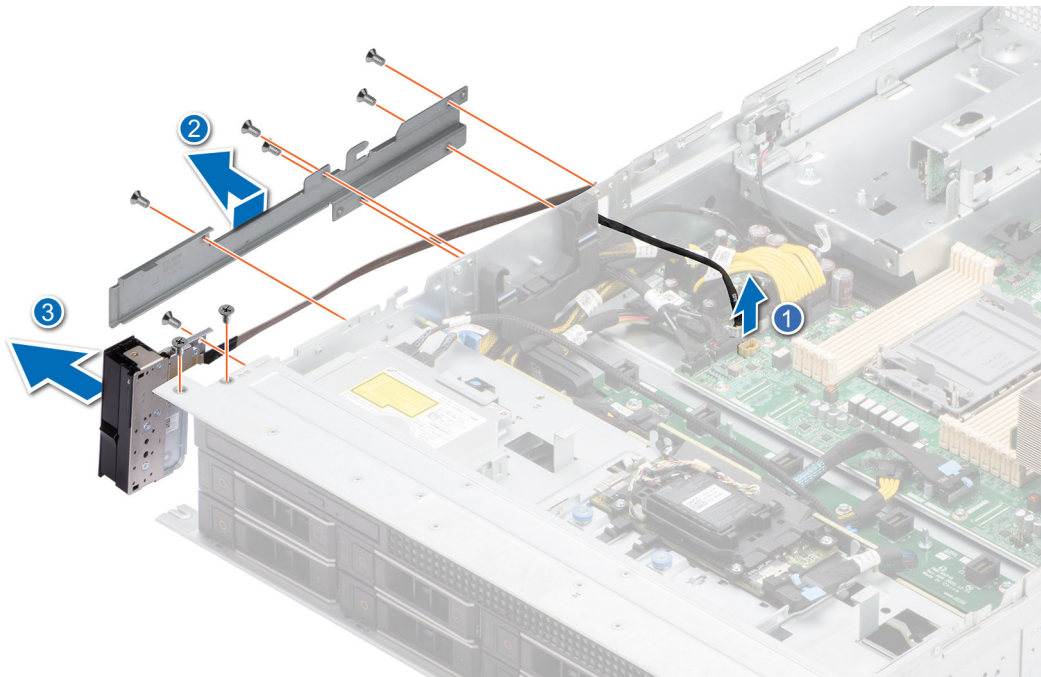

Figure 109. Removing the left control panel

Next steps

[Replace the left control panel.](#)

Installing the left control panel

Prerequisites

1. Follow the safety guidelines listed in the [Safety instructions](#).
2. Follow the procedure listed in the [Before working inside your system](#).

Steps

1. Align and slide the left control panel assembly in the slot on the system.
 2. Route the left control panel cable through the side wall of the system.
 3. Align and slide the left control panel cable cover in the slot on the system.
- NOTE:** Route the cable properly to prevent the cable from being pinched or crimped.
4. Connect the left control panel cable to the connector on the system board .
 5. Using the Phillips #1 screwdriver, tighten the screws to secures the left control panel and the cable cover to the system.

NOTE: The numbers on the image do not depict the exact steps. The numbers are for representation of sequence.

Figure 110. Installing the left control panel

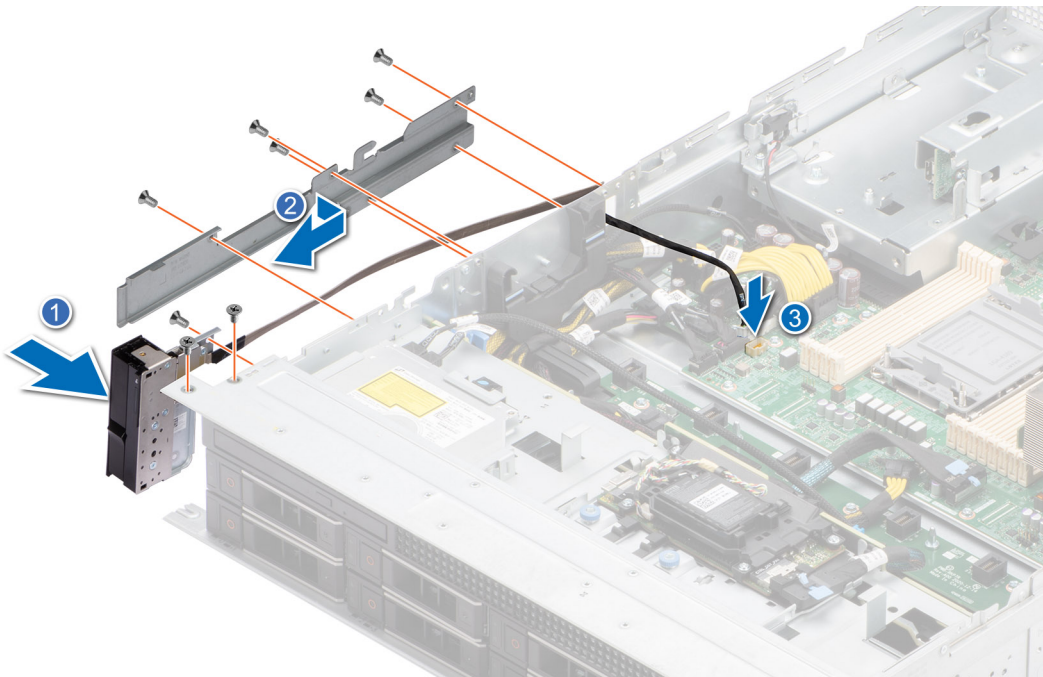

Next steps

1. [Install the cooling fan cage assembly](#).
2. [Install the drive backplane cover](#).
3. [Install the air shroud](#).
4. Follow the procedure listed in the [After working inside your system](#).

Removing the right control panel

Prerequisites

1. Follow the safety guidelines listed in the [Safety instructions](#).
2. Follow the procedure listed in the [Before working inside your system](#).
3. [Remove the air shroud](#).

4. Remove the drive backplane cover.
5. Remove the cooling fan cage assembly.

Steps

1. Disconnect the right control panel cable and the VGA cable from the connectors on the system board.

NOTE: Observe the routing of the cable as you remove it from the system.

2. Remove the cable from cable clip.
3. Using the Phillips #1 screwdriver, remove the screws that secures the right control panel and cable cover to the system.
4. Holding the right control panel assembly, remove the control panel along with the cable from the system.

NOTE: The numbers on the image do not depict the exact steps. The numbers are for representation of sequence.

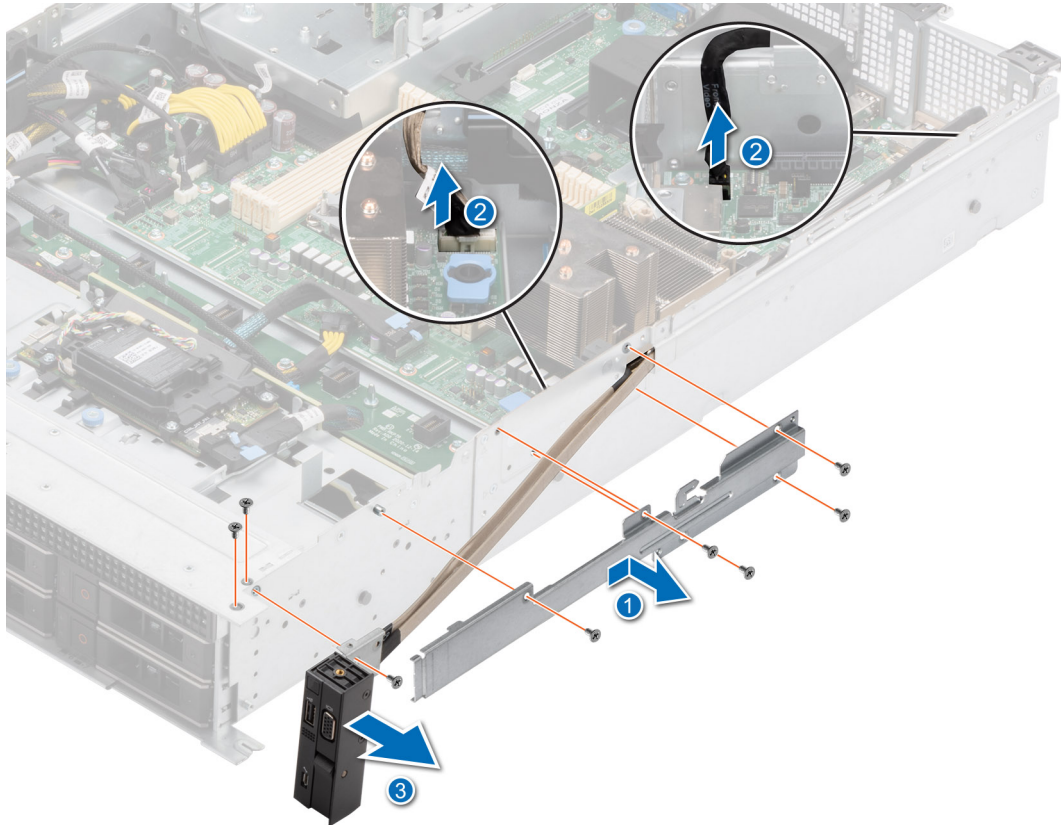

Figure 111. Removing the right control panel

Next steps

Replace the right control panel.

Installing the right control panel

Prerequisites

1. Follow the safety guidelines listed in the [Safety instructions](#).
2. Follow the procedure listed in the [Before working inside your system](#).
3. [Remove the air shroud](#).
4. [Remove the drive backplane cover](#).
5. [Remove the cooling fan cage assembly](#).

Steps

1. Align and slide the right control panel assembly in the slot on the system.
 2. Route the right control panel cable through the side wall of the system.
 3. Align and slide the right control panel cable cover in the slot on the system.
- NOTE:** Route the cable properly to prevent the cable from being pinched or crimped.
4. Connect the right control panel cable and VGA cable to the connectors on the system board.
 5. Using the Phillips #1 screwdriver, tighten the screws that secures the right control panel and the cable cover to the system.

NOTE: The numbers on the image do not depict the exact steps. The numbers are for representation of sequence.

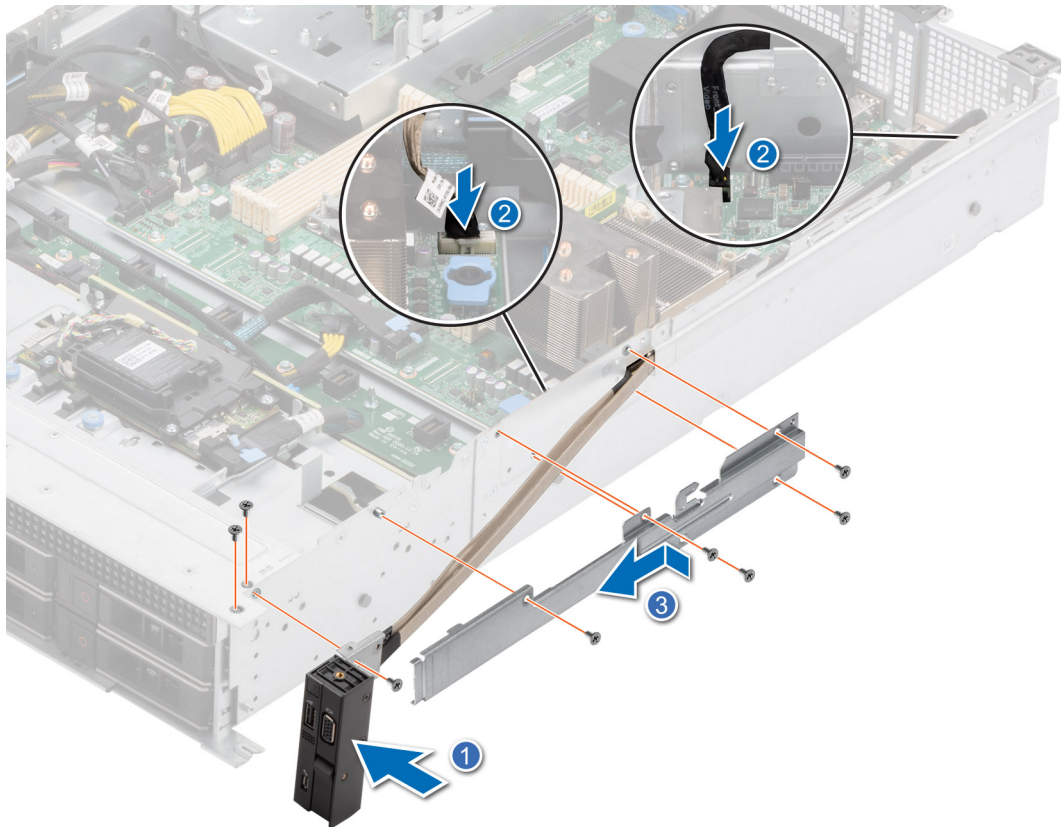

Figure 112. Installing the right control panel

Next steps

1. Install the cooling fan cage assembly.
2. Install the drive backplane cover.
3. Install the air shroud.
4. Follow the procedure listed in the [After working inside your system](#).

Optional optical drive

This is a service technician replaceable part only.

Removing the optical disk drive

Prerequisites

1. Follow the safety guidelines listed in the [Safety instructions](#).
2. Follow the procedure listed in the [Before working inside your system](#).
3. [Remove the air shroud](#).
4. [Remove the drive backplane cover](#).
5. Disconnect the power and signal cables from the optical disk drive (ODD) and observe the cable routing.

Steps

Press the blue latch to disengage the ODD from the system and slide out the ODD.

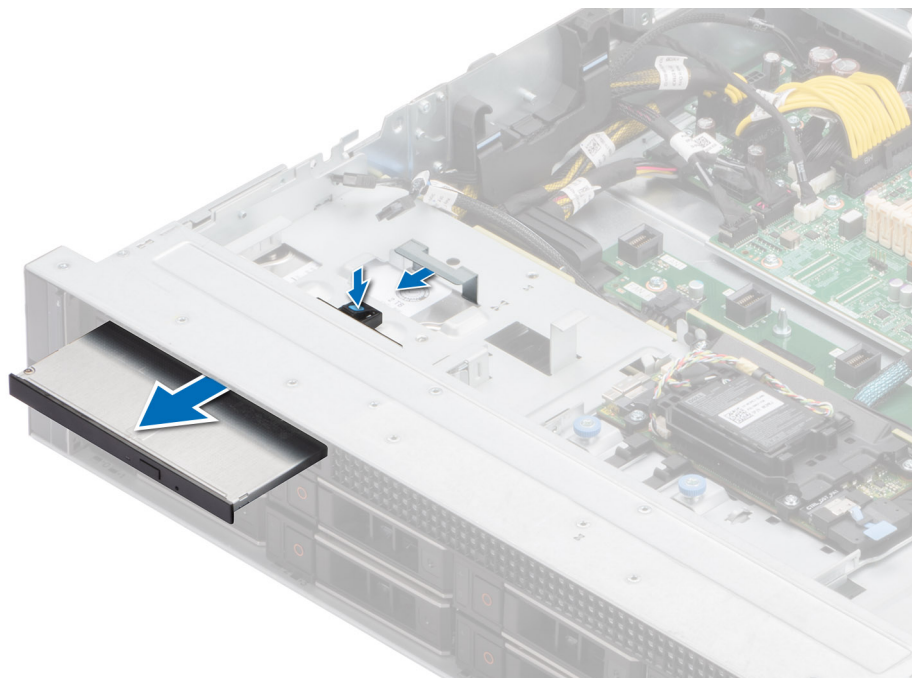

Figure 113. Removing the ODD

Next steps

[Replace the ODD](#).

Installing the optical disk drive

Prerequisites

1. Follow the safety guidelines listed in the [Safety instructions](#).
2. Follow the procedure listed in the [Before working inside your system](#).
3. [Remove the air shroud](#).
4. [Remove the drive backplane cover](#).

Steps

Slide the optical disk drive (ODD), until the latch is seated firmly into the system slot.

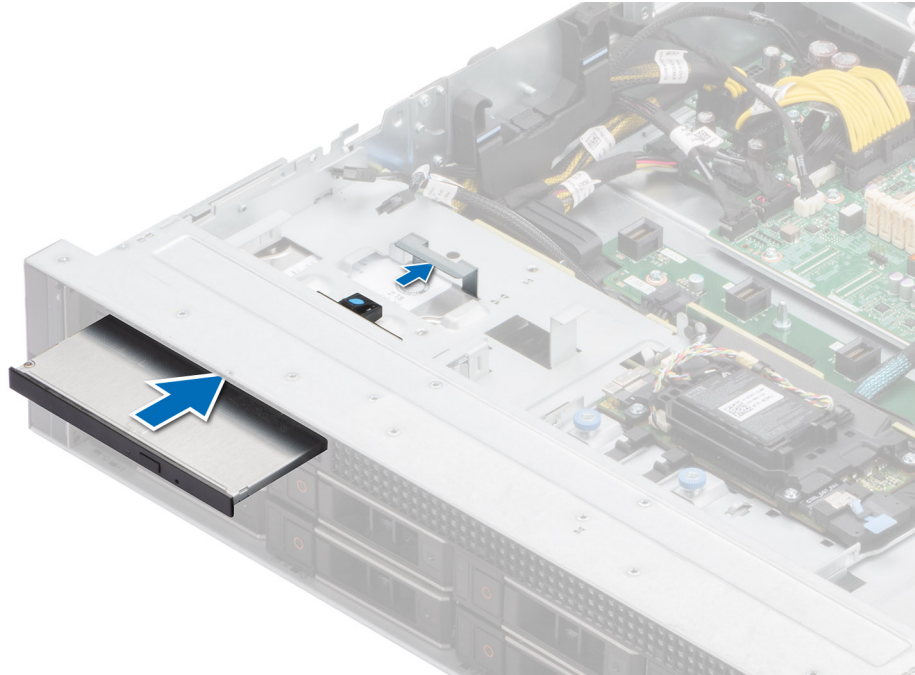

Figure 114. Installing the ODD

Next steps

1. Connect the power and signal cables to the ODD and system board connector. Route the cables through the side wall bracket.
2. [Install the drive backplane cover.](#)
3. [Install the air shroud.](#)
4. Follow the procedure listed in [After working inside your system.](#)

Jumpers and connectors

This section provides essential and specific information about jumpers and switches. It also describes the connectors on the various boards in the system. Jumpers on the system board help to disable the system and reset the passwords. To install components and cables correctly, you must be able to identify the connectors on the system board.

Topics:

- System board connectors
- System board jumper settings
- Disabling a forgotten password

System board connectors

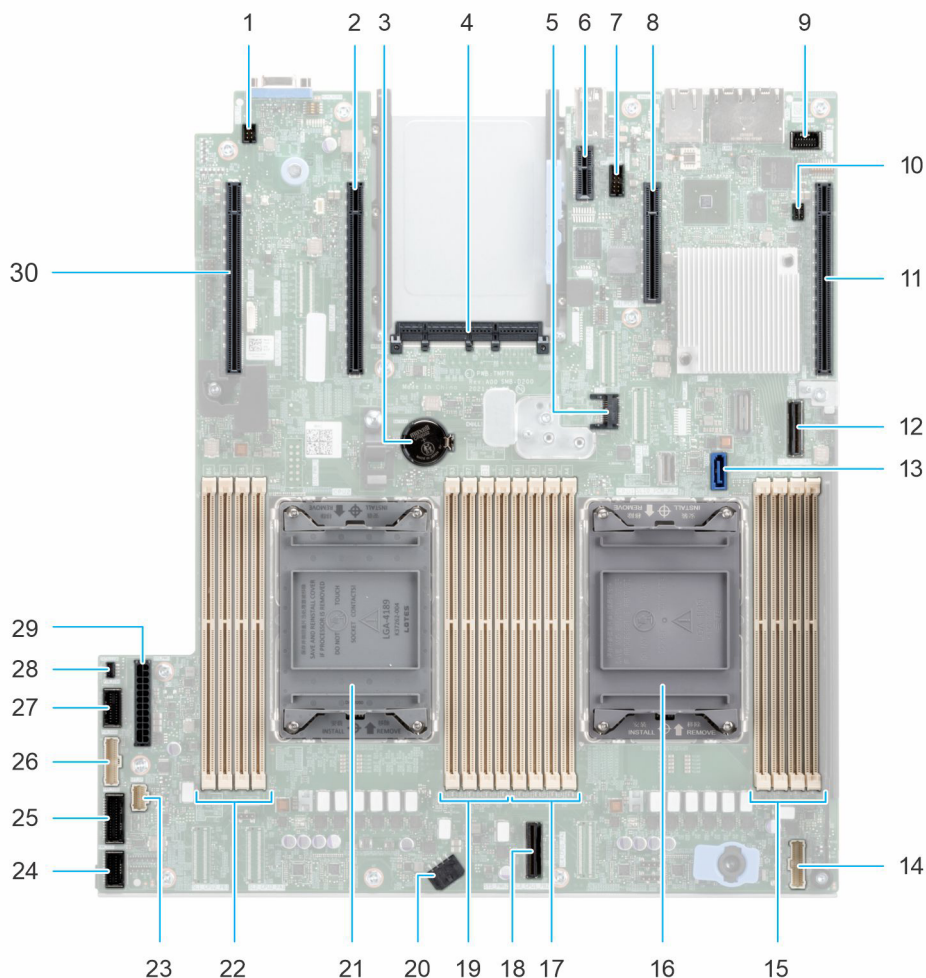

Figure 115. System board jumpers and connectors

Table 27. System board jumpers and connectors

Item	Connector	Description
1.	SYS_ID	System ID Connector





Table 27. System board jumpers and connectors (continued)

Item	Connector	Description
2.	x16 (CPU2)	PCIe slot 5 (Processor 2)
3.	Coin cell battery	Coin cell battery
4.	OCP 3.0 x16	OCP NIC 3.0 Connector
5.	J_TPM	TPM Connector
6.	IDSDM/Internal USB connector	IDSDM/Internal USB connector
7.	REAR_SERIAL	Serial Port Connector
8.	x4 (PCH)	x4 PCIe slot 2 (PCH) / BOSS signal connector (PCH)
9.	FRONT_VIDEO	Front VGA
10.	PWRD_EN / NVRAM_CLR	PWRD_EN / NVRAM_CLR (Jumpers)
11.	x16 (CPU1)	x16 PCIe slot 1 (Processor 1)
12.	SL9_PCH_SA1	SATA Connector S9 (PCH)
13.	ODD	Optical disk drive connector
14.	RGT_CP	Right Control Panel
15.	A3, A7, A1, A5	DIMMs for processor 1 Channels A, B, C, D
16.	CPU 1	Processor 1
17.	A6, A2, A8, A4	DIMMs for processor 1 Channels E, F, G, H
18.	SL3_CPU1_PB2	PCIe cable connector 3 (Processor 1)
19.	B6, B2, B8, B4	DIMMs for processor 2 Channels E, F, G, H
20.	SYS_PWR2	System Power Connector 2
21.	CPU 2	Processor 2
22.	B3, B7, B1, B5	DIMM for processor 2 channels A, B, C, D
23.	LFT_CP	Left Control Panel
24.	FAN_SIG1	Fan Signal 1
25.	FAN_SIG2	Fan Signal 2
26.	PIB_SIG1	PIB Signal 1
27.	PIB_SIG2	PIB Signal 2
28.	INTRUSION	Intrusion Switch Connector
29.	SYS_PWR1	System Power Connector 1
30.	x16 (CPU2)	PCIe slot 6 (Processor 2)

System board jumper settings

For information about resetting the password jumper to disable a password, see the [Disabling a forgotten password](#) section.

Table 28. System board jumper settings

Jumper	Setting	Description
PWRD_EN	 2 4 6 (default)	The BIOS password feature is enabled.
	 2 4 6	The BIOS password feature is disabled. The BIOS password is now disabled and you are not allowed to set a new password.
NVRAM_CLR	 1 3 5 (default)	The BIOS configuration settings are retained at system boot.
	 1 3 5	The BIOS configuration settings are cleared at system boot.

CAUTION: You should be cautious when changing the BIOS settings. The BIOS interface is designed for advanced users. Any changes in the setting might prevent your system from starting correctly and may even result in data loss.

Disabling a forgotten password

The software security features of the system include a system password and a setup password. The password jumper enables or disables password features and clears any password(s) currently in use.

Prerequisites

CAUTION: Many repairs may only be done by a certified service technician. You should only perform troubleshooting and simple repairs as authorized in your product documentation, or as directed by the online or telephone service and support team. Damage due to servicing that is not authorized by Dell is not covered by your warranty. Read and follow the safety instructions that are shipped with your product.

Steps

1. Power off the system and all attached peripherals. Disconnect the system from the electrical outlet, and disconnect the peripherals.
2. Remove the system cover.
3. Move the jumper on the system board from pins 2 and 4 to pins 4 and 6.
4. Replace the system cover.
 - NOTE:** The existing passwords are not disabled (erased) until the system boots with the jumper on pins 4 and 6. However, before you assign a new system and/or setup password, you must move the jumper back to pins 2 and 4.
 - NOTE:** If you assign a new system and/or setup password with the jumper on pins 4 and 6, the system disables the new password(s) the next time it boots.
5. Reconnect the peripherals and connect the system to the electrical outlet, and then power on the system.
6. Power off the system.
7. Remove the system cover.
8. Move the jumper on the system board from pins 4 and 6 to pins 2 and 4.
9. Replace the system cover.
10. Reconnect the peripherals and connect the system to the electrical outlet, and then power on the system.
11. Assign a new system and/or setup password.

System diagnostics and indicator codes

This section describes the diagnostic indicators on the system front panel that displays the system status during system startup.

Topics:

- Status LED indicators
- System health and system ID indicator codes
- iDRAC Quick Sync 2 indicator codes
- iDRAC Direct LED indicator codes
- LCD panel
- NIC indicator codes
- Power supply unit indicator codes
- Drive indicator codes
- Using system diagnostics

Status LED indicators

 **NOTE:** The indicators display solid amber if any error occurs.

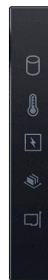

Figure 116. Status LED indicators

Table 29. Status LED indicators and descriptions





Icon	Description	Condition	Corrective action
	Drive indicator	The indicator turns solid amber if there is a drive error.	<ul style="list-style-type: none"> • Check the System Event Log to determine if the drive has an error. • Run the appropriate Online Diagnostics test. Restart the system and run embedded diagnostics (ePSA). • If the drives are configured in a RAID array, restart the system, and enter the host adapter configuration utility program.
	Temperature indicator	The indicator turns solid amber if the system experiences a thermal error (for example, the ambient temperature is out of range or there is a fan failure).	<p>Ensure that none of the following conditions exist:</p> <ul style="list-style-type: none"> • A cooling fan has been removed or has failed. • System cover, air shrouds, or back filler bracket has been removed. • Ambient temperature is too high. • External airflow is obstructed. <p>If the problem persists, see the Getting help section.</p>

Table 29. Status LED indicators and descriptions (continued)

Icon	Description	Condition	Corrective action
	Electrical indicator	The indicator turns solid amber if the system experiences an electrical error (for example, voltage out of range, or a failed power supply unit (PSU) or voltage regulator).	Check the System Event Log or system messages for the specific issue. If it is due to a problem with the PSU, check the LED on the PSU. Reseat the PSU. If the problem persists, see the Getting help section.
	Memory indicator	The indicator turns solid amber if a memory error occurs.	Check the System Event Log or system messages for the location of the failed memory. Reseat the memory module. If the problem persists, see the Getting help section.
	PCIe indicator	The indicator turns solid amber if a PCIe card experiences an error.	Restart the system. Update any required drivers for the PCIe card. Reinstall the card. If the problem persists, see the Getting help section.
			NOTE: For more information about the supported PCIe cards, see the Expansion card installation guidelines section.

System health and system ID indicator codes

The system health and system ID indicator is located on the left control panel of the system.



Figure 117. System health and system ID indicator

Table 30. System health and system ID indicator codes

System health and system ID indicator code	Condition
Solid blue	Indicates that the system is powered on, is healthy, and system ID mode is not active. Press the system health and system ID button to switch to system ID mode.
Blinking blue	Indicates that the system ID mode is active. Press the system health and system ID button to switch to system health mode.
Solid amber	Indicates that the system is in fail-safe mode. If the problem persists, see the Getting help section.
Blinking amber	Indicates that the system is experiencing a fault. Check the System Event Log for specific error messages. For information about the event and error messages generated by the system firmware and agents that monitor system components, go to qrl.dell.com > Look Up > Error Code , type the error code, and then click Look it up .

iDRAC Quick Sync 2 indicator codes

iDRAC Quick Sync 2 module (optional) is located on the left control panel of the system.



Table 31. iDRAC Quick Sync 2 indicators and descriptions

iDRAC Quick Sync 2 indicator code	Condition	Corrective action
Off (default state)	Indicates that the iDRAC Quick Sync 2 feature is powered off. Press the iDRAC Quick Sync 2 button to power on the iDRAC Quick Sync 2 feature.	If the LED fails to power on, reseal the left control panel flex cable and check. If the problem persists, see the Getting help section.
Solid white	Indicates that iDRAC Quick Sync 2 is ready to communicate. Press the iDRAC Quick Sync 2 button to power off.	If the LED fails to power off, restart the system. If the problem persists, see the Getting help section.
Blinks white rapidly	Indicates data transfer activity.	If the indicator continues to blink indefinitely, see the Getting help section.
Blinks white slowly	Indicates that firmware update is in progress.	If the indicator continues to blink indefinitely, see the Getting help section.
Blinks white five times rapidly and then powers off	Indicates that the iDRAC Quick Sync 2 feature is disabled.	Check if iDRAC Quick Sync 2 feature is configured to be disabled by iDRAC. If the problem persists, see the Getting help section. www.dell.com/poweredgemanuals or <i>Dell OpenManage Server Administrator User's Guide</i> at https://www.dell.com/openmanagemanuals .
Solid amber	Indicates that the system is in fail-safe mode.	Restart the system. If the problem persists, see the Getting help section.
Blinking amber	Indicates that the iDRAC Quick Sync 2 hardware is not responding properly.	Restart the system. If the problem persists, see the Getting help section.

iDRAC Direct LED indicator codes

The iDRAC Direct LED indicator lights up to indicate that the port is connected and is being used as a part of the iDRAC subsystem.

You can configure iDRAC Direct by using a USB to micro USB (type AB) cable, which you can connect to your laptop or tablet. Cable length should not exceed 3 feet (0.91 meters). Performance could be affected by cable quality. The following table describes iDRAC Direct activity when the iDRAC Direct port is active:

Table 32. iDRAC Direct LED indicator codes

iDRAC Direct LED indicator code	Condition
Solid green for two seconds	Indicates that the laptop or tablet is connected.
Blinking green (on for two seconds and off for two seconds)	Indicates that the laptop or tablet connected is recognized.

Table 32. iDRAC Direct LED indicator codes (continued)

iDRAC Direct LED indicator code	Condition
LED Indicator off	Indicates that the laptop or tablet is unplugged.

LCD panel

The LCD panel provides system information, status, and error messages to indicate if the system is functioning correctly or requires attention. The LCD panel is used to configure or view the iDRAC IP address of the system. For information about the event and error messages generated by the system firmware and agents that monitor system components, go to qrl.dell.com >

Look Up > Error Code, type the error code, and then click **Look it up**.

The LCD panel is available only on the optional front bezel. The optional front bezel is hot pluggable.

The status and conditions of the LCD panel are outlined here:

- The LCD backlight is white during normal operating conditions.
- If there is an issue, the LCD backlight turns amber and displays an error code followed by descriptive text.
 - ⓘ **NOTE:** If the system is connected to a power source and an error is detected, the LCD turns amber regardless of whether the system is powered on or off.
- When the system powers off and there are no errors, the LCD enters the standby mode after five minutes of inactivity. Press any button on the LCD to power it on.
- If the LCD panel stops responding, remove the bezel and reinstall it.
 - If the problem persists, see [Getting help](#).
- The LCD backlight remains off if LCD messaging is powered off using the iDRAC utility, the LCD panel, or other tools.

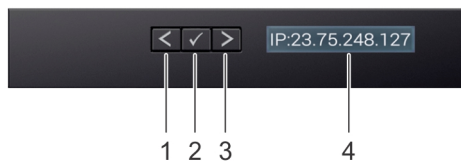

Figure 118. LCD panel features



Table 33. LCD panel features

Item	Button or display	Description
1	Left	Moves the cursor back in one-step increments.
2	Select	Selects the menu item highlighted by the cursor.
3	Right	Moves the cursor forward in one-step increments. During message scrolling: <ul style="list-style-type: none"> • Press and hold the right button to increase scrolling speed. • Release the button to stop. ⓘ NOTE: The display stops scrolling when the button is released. After 45 seconds of inactivity, the display starts scrolling.
4	LCD display	Displays the system information, status, and error messages or iDRAC IP address.

Viewing Home screen

The **Home** screen displays user-configurable information about the system. This screen is displayed during normal system operation when there are no status messages or errors. When the system turns off and there are no errors, LCD enters the standby mode after five minutes of inactivity. Press any button on the LCD to turn it on.

Steps

1. To view the **Home** screen, press one of the three navigation buttons (Select, Left, or Right).
2. To navigate to the **Home** screen from another menu, complete the following steps:
 - a. Press and hold the navigation button till the up arrow  is displayed.
 - b. Navigate to the **Home** icon  using the up arrow .
 - c. Select the **Home** icon.
 - d. On the **Home** screen, press the **Select** button to enter the main menu.

Setup menu

 **NOTE:** When you select an option in the Setup menu, you must confirm the option before proceeding to the next action.

Table 34. Setup menu

Option	Description
iDRAC	Select DHCP or Static IP to configure the network mode. If Static IP is selected, the available fields are IP , Subnet (Sub) , and Gateway (Gtw) . Select Setup DNS to enable DNS and to view domain addresses. Two separate DNS entries are available.
Set error	Select SEL to view LCD error messages in a format that matches the IPMI description in the SEL. This enables you to match an LCD message with an SEL entry. Select Simple to view LCD error messages in a simplified user-friendly description. For information about the event and error messages generated by the system firmware and agents that monitor system components, go to qrl.dell.com > Look Up > Error Code , type the error code, and then click Look it up ..
Set home	Select the default information to be displayed on the Home screen. See View menu section for the options and option items that can be set as the default on the Home screen.

View menu

 **NOTE:** When you select an option in the View menu, you must confirm the option before proceeding to the next action.

Table 35. View menu

Option	Description
iDRAC IP	Displays the IPv4 or IPv6 addresses for iDRAC9. Addresses include DNS (Primary and Secondary) , Gateway, IP , and Subnet (IPv6 does not have Subnet).
MAC	Displays the MAC addresses for iDRAC , iSCSI , or Network devices.
Name	Displays the name of the Host , Model , or User String for the system.
Number	Displays the Asset tag or the Service tag for the system.
Power	Displays the power output of the system in BTU/hr or Watts. The display format can be configured in the Set home submenu of the Setup menu.
Temperature	Displays the temperature of the system in Celsius or Fahrenheit. The display format can be configured in the Set home submenu of the Setup menu.

NIC indicator codes

Each NIC on the back of the system has indicators that provide information about the activity and link status. The activity LED indicator indicates if data is flowing through the NIC, and the link LED indicator indicates the speed of the connected network.

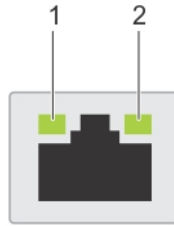

Figure 119. NIC indicator codes

- 1. Link LED indicator
- 2. Activity LED indicator

Table 36. NIC indicator codes

NIC indicator codes	Condition
Link and activity indicators are off.	Indicates that the NIC is not connected to the network.
Link indicator is green, and activity indicator is blinking green.	Indicates that the NIC is connected to a valid network at its maximum port speed, and data is being sent or received.
Link indicator is amber, and activity indicator is blinking green.	Indicates that the NIC is connected to a valid network at less than its maximum port speed, and data is being sent or received.
Link indicator is green, and activity indicator is off.	Indicates that the NIC is connected to a valid network at its maximum port speed, and data is not being sent or received.
Link indicator is amber, and activity indicator is off.	Indicates that the NIC is connected to a valid network at less than its maximum port speed, and data is not being sent or received.
Link indicator is blinking green, and activity is off.	Indicates that the NIC identity is enabled through the NIC configuration utility.

Power supply unit indicator codes

AC and DC power supply units (PSUs) have an illuminated translucent handle that serves as an indicator. The indicator shows if power is present or if a power fault has occurred.

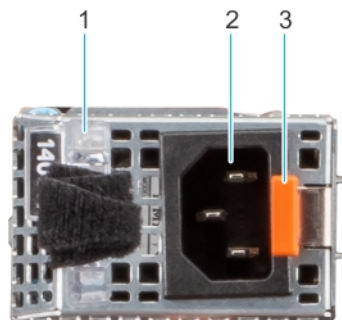

Figure 120. AC PSU status indicator

- 1. AC PSU handle
- 2. Socket
- 3. Release latch

Table 37. AC PSU status indicator codes

Power indicator codes	Condition
Green	Indicates that a valid power source is connected to the PSU and the PSU is operational.
Blinking amber	Indicates an issue with the PSU.
Not powered on	Indicates that the power is not connected to the PSU.
Blinking green	Indicates that the firmware of the PSU is being updated. ⚠ CAUTION: Do not disconnect the power cord or unplug the PSU when updating firmware. If firmware update is interrupted, the PSUs will not function.
Blinking green and powers off	When hot-plugging a PSU, it blinks green five times at a rate of 4 Hz and powers off. This indicates a PSU mismatch due to efficiency, feature set, health status, or supported voltage. ⚠ CAUTION: If two PSUs are installed, both the PSUs must have the same type of label; for example, Extended Power Performance (EPP) label. Mixing PSUs from previous generations of PowerEdge servers is not supported, even if the PSUs have the same power rating. This results in a PSU mismatch condition or failure to power on the system. ⚠ CAUTION: If two PSUs are used, they must be of the same type and have the same maximum output power. ⚠ CAUTION: When correcting a PSU mismatch, replace the PSU with the blinking indicator. Swapping the PSU to make a matched pair can result in an error condition and an unexpected system shutdown. To change from a high output configuration to a low output configuration or vice versa, you must power off the system. ⚠ CAUTION: AC PSUs support both 240 V and 120 V input voltages with the exception of Titanium PSUs, which support only 240 V. When two identical PSUs receive different input voltages, they can output different wattages, and trigger a mismatch.

Table 38. DC PSU status indicator codes

Power indicator codes	Condition
Green	Indicates that a valid power source is connected to the PSU, and the PSU is operational.
Blinking amber	Indicates an issue with the PSU.
Not powered on	Indicates that the power is not connected to the PSU.
Blinking green	When hot-plugging a PSU, it blinks green five times at a rate of 4 Hz and powers off. This indicates a PSU mismatch due to efficiency, feature set, health status, or supported voltage. ⚠ CAUTION: If two PSUs are installed, both the PSUs must have the same type of label; for example, Extended Power Performance (EPP) label. Mixing PSUs from previous generations of PowerEdge servers is not supported, even if the PSUs have the

Table 38. DC PSU status indicator codes (continued)

Power indicator codes	Condition
	<p>same power rating. This results in a PSU mismatch condition, or failure to power on the system.</p> <p>⚠ CAUTION: If two PSUs are used, they must be of the same type and have the same maximum output power.</p> <p>⚠ CAUTION: When correcting a PSU mismatch, replace the PSU with the blinking indicator. Swapping the PSU to make a matched pair can result in an error condition and an unexpected system shutdown. To change from a High Output configuration to a Low Output configuration or conversely, you must power off the system.</p> <p>⚠ CAUTION: Combining AC and DC PSUs is not supported.</p>

Drive indicator codes

The LEDs on the drive carrier indicate the state of each drive. Each drive carrier has two LEDs: an activity LED (green) and a status LED (bicolor, green/amber). The activity LED blinks whenever the drive is accessed.



Figure 121. Drive indicators on the drive and the mid drive tray backplane

1. Drive activity LED indicator
2. Drive status LED indicator
3. Drive capacity label

ⓘ **NOTE:** If the drive is in the Advanced Host Controller Interface (AHCI) mode, the status LED indicator does not power on.

ⓘ **NOTE:** Drive status indicator behavior is managed by Storage Spaces Direct. Not all drive status indicators may be used.

Table 39. Drive indicator codes

Drive status indicator code	Condition
Blinks green twice per second	Indicates that the drive is being identified or preparing for removal.
Off	Indicates that the drive is ready for removal.

Table 39. Drive indicator codes (continued)

Drive status indicator code	Condition
	 NOTE: The drive status indicator remains off until all drives are initialized after the system is powered on. Drives are not ready for removal during this time.
Blinks green, amber, and then powers off	Indicates that there is an unexpected drive failure.
Blinks amber four times per second	Indicates that the drive has failed.
Blinks green slowly	Indicates that the drive is rebuilding.
Solid green	Indicates that the drive is online.
Blinks green for three seconds, amber for three seconds, and then powers off after six seconds	Indicates that the rebuild has stopped.

Using system diagnostics

If you experience an issue with the system, run the system diagnostics before contacting Dell for technical assistance. The purpose of running system diagnostics is to test the system hardware without using additional equipment or risking data loss. If you are unable to fix the issue yourself, service and support personnel can use the diagnostics results to help you solve the issue.

Dell Embedded System Diagnostics

 **NOTE:** The Dell Embedded System Diagnostics is also known as Enhanced Pre-boot System Assessment (ePSA) diagnostics.

The Embedded System Diagnostics provide a set of options for particular device groups or devices allowing you to:

- Run tests automatically or in an interactive mode
- Repeat tests
- Display or save test results
- Run thorough tests to introduce additional test options to provide extra information about the failed device(s)
- View status messages that inform you if tests are completed successfully
- View error messages that inform you of issues encountered during testing

Running the Embedded System Diagnostics from the Dell Lifecycle Controller

Steps

1. When the system is booting, press F10.
2. Select **Hardware Diagnostics** → **Run Hardware Diagnostics**.
The **ePSA Pre-boot System Assessment** window is displayed, listing all devices detected in the system. The diagnostics start executing the tests on all the detected devices.

Running the Embedded System Diagnostics from Boot Manager

Run the Embedded System Diagnostics (ePSA) if your system does not boot.

Steps

1. When the system is booting, press F11.
2. Use the up arrow and down arrow keys to select **System Utilities** > **Launch Diagnostics**.
3. Alternatively, when the system is booting, press F10, select **Hardware Diagnostics** > **Run Hardware Diagnostics**.

The **ePSA Pre-boot System Assessment** window is displayed, listing all devices detected in the system. The diagnostics starts executing the tests on all the detected devices.

System diagnostic controls

Table 40. System diagnostic controls

Menu	Description
Configuration	Displays the configuration and status information of all detected devices.
Results	Displays the results of all tests that are run.
System health	Provides the current overview of the system performance.
Event log	Displays a time-stamped log of the results of all tests run on the system. This is displayed if at least one event description is recorded.

Getting help

Topics:

- [Recycling or End-of-Life service information](#)
- [Contacting Dell Technologies](#)
- [Accessing system information by using QRL](#)
- [Receiving automated support with SupportAssist](#)

Recycling or End-of-Life service information

Take back and recycling services are offered for this product in certain countries. If you want to dispose of system components, visit www.dell.com/recyclingworldwide and select the relevant country.

Contacting Dell Technologies

Dell provides online and telephone based support and service options. If you do not have an active internet connection, you can find Dell contact information on your purchase invoice, packing slip, bill or Dell product catalog. The availability of services varies depending on the country and product, and some services may not be available in your area. To contact Dell for sales, technical assistance, or customer service issues follow these steps:

Steps

1. Go to www.dell.com/support/home.
2. Select your country from the drop-down menu on the lower right corner of the page.
3. For customized support:
 - a. Enter the system Service Tag in the **Enter a Service Tag, Serial Number, Service Request, Model, or Keyword** field.
 - b. Click **Search**.
The support page that lists the various support categories is displayed.
4. For general support:
 - a. Select your product category.
 - b. Select your product segment.
 - c. Select your product.
The support page that lists the various support categories is displayed.
5. For contact details of Dell Global Technical Support:
 - a. Click [Contact Technical Support](#).
 - b. The **Contact Technical Support** page is displayed with details to call, chat, or e-mail the Dell Global Technical Support team.

Accessing system information by using QRL

You can use the Quick Resource Locator (QRL) located on the information tag in the front of the R550 system, to access information about Dell EMC PowerEdge R550. There is also another QRL for accessing product information located on the back of the system cover.

Prerequisites

Ensure that your smartphone or tablet has a QR code scanner installed.

The QRL includes the following information about your system:

- How-to videos
- Reference materials, including the Installation and Service Manual, LCD diagnostics, and mechanical overview
- The system service tag to quickly access the specific hardware configuration and warranty information
- A direct link to Dell to contact technical assistance and sales teams

Steps

1. Go to www.dell.com/qrl, and navigate to your specific product or
2. Use your smart phone or tablet to scan the model-specific Quick Resource (QR) code on your system or in the Quick Resource Locator section.

Quick Resource Locator for PowerEdge R550 system



Figure 122. Quick Resource Locator for PowerEdge R550 system

Receiving automated support with SupportAssist

Dell EMC SupportAssist is an optional Dell EMC Services offering that automates technical support for your Dell EMC server, storage, and networking devices. By installing and setting up a SupportAssist application in your IT environment, you can receive the following benefits:

- Automated issue detection — SupportAssist monitors your Dell EMC devices and automatically detects hardware issues, both proactively and predictively.
- Automated case creation — When an issue is detected, SupportAssist automatically opens a support case with Dell EMC Technical Support.
- Automated diagnostic collection — SupportAssist automatically collects system state information from your devices and uploads it securely to Dell EMC. This information is used by Dell EMC Technical Support to troubleshoot the issue.
- Proactive contact — A Dell EMC Technical Support agent contacts you about the support case and helps you resolve the issue.

The available benefits vary depending on the Dell EMC Service entitlement purchased for your device. For more information about SupportAssist, go to www.dell.com/supportassist.

Documentation resources

This section provides information about the documentation resources for your system.

To view the document that is listed in the documentation resources table:

- From the Dell EMC support site:
 1. Click the documentation link that is provided in the Location column in the table.
 2. Click the required product or product version.
-  **NOTE:** To locate the model number, see the front of your system.
- 3. On the Product Support page, click **Documentation**.
- Using search engines:
 - Type the name and version of the document in the search box.

Table 41. Additional documentation resources for your system

Task	Document	Location
Setting up your system	<p>For more information about installing and securing the system into a rack, see the Rail Installation Guide included with your rail solution.</p> <p>For information about setting up your system, see the <i>Getting Started Guide</i> document that is shipped with your system.</p>	www.dell.com/poweredgemanuals
Configuring your system	<p>For information about the iDRAC features, configuring and logging in to iDRAC, and managing your system remotely, see the Integrated Dell Remote Access Controller User's Guide.</p> <p>For information about understanding Remote Access Controller Admin (RACADM) subcommands and supported RACADM interfaces, see the RACADM CLI Guide for iDRAC.</p> <p>For information about Redfish and its protocol, supported schema, and Redfish Eventing implemented in iDRAC, see the Redfish API Guide.</p> <p>For information about iDRAC property database group and object descriptions, see the Attribute Registry Guide.</p> <p>For information about Intel QuickAssist Technology, see the Integrated Dell Remote Access Controller User's Guide.</p>	www.dell.com/poweredgemanuals
	<p>For information about earlier versions of the iDRAC documents.</p> <p>To identify the version of iDRAC available on your system, on the iDRAC web interface, click ? > About.</p>	www.dell.com/idracmanuals

Table 41. Additional documentation resources for your system (continued)

Task	Document	Location
	For information about installing the operating system, see the operating system documentation.	www.dell.com/operatingsystemmanuals
	For information about updating drivers and firmware, see the Methods to download firmware and drivers section in this document.	www.dell.com/support/drivers
Managing your system	For information about systems management software offered by Dell, see the Dell OpenManage Systems Management Overview Guide.	www.dell.com/poweredgemanuals
	For information about setting up, using, and troubleshooting OpenManage, see the Dell OpenManage Server Administrator User's Guide.	www.dell.com/openmanagemanuals > OpenManage Server Administrator
	For information about installing and using Dell SupportAssist, see the Dell EMC SupportAssist Enterprise User's Guide.	https://www.dell.com/serviceabilitytools
	For information about partner programs enterprise systems management, see the OpenManage Connections Enterprise Systems Management documents.	www.dell.com/openmanagemanuals
Working with the Dell PowerEdge RAID controllers	For information about understanding the features of the Dell PowerEdge RAID controllers (PERC), Software RAID controllers, or BOSS card and deploying the cards, see the Storage controller documentation.	www.dell.com/storagecontrollermanuals
Understanding event and error messages	For information about the event and error messages generated by the system firmware and agents that monitor system components, go to qrl.dell.com > Look Up > Error Code , type the error code, and then click Look it up .	www.dell.com/qrl
Troubleshooting your system	For information about identifying and troubleshooting the PowerEdge server issues, see the Server Troubleshooting Guide.	www.dell.com/poweredgemanuals