

TPE3, TPE3 D

In-line circulator pumps
60 Hz, North America



1. Pump data	4	13. Motors with built-in VFD	68
Introduction	4	Technical data, single-phase motors	68
Pump Energy Index	4	Technical data, three-phase motors	68
TPE3 pumps	5	Inputs and outputs	68
Identification	6	EMC, electromagnetic compatibility	69
		Maximum number of starts and stops	71
2. Performance range	8	Wiring diagrams	71
Performance range, TPE3 (D)	8	Connection terminals	71
Performance range, TPE3 D, twin-head operation	9	Identification of functional module	73
3. Product range	10	14. Electromagnetic compatibility, EMC	74
TPE3	10	Proper installation	74
TPE3 D	11		
4. Operating conditions	12	15. Curve charts	76
Maximum operating and test pressures	12	How to read the curve charts	76
Sound pressure level	12	Curve conditions	77
Ambient temperature	12		
Installation altitude	12	16. Performance curves and technical data	78
		TPE3, TPE3 D, class 125	78
5. Pumped liquids	13	17. Weights and shipping volume	88
Pumped liquids	13		
Liquid temperature	13	18. Accessories	89
List of pumped liquids	13	Base plates	89
Shaft seal for water-glycol mixture	15	Insulating kits	89
		Sensors	90
6. TPE3, TPE3 D	16	External Grundfos sensors	94
Technical data	16	Potentiometer	95
Construction	16	Grundfos GO	95
Materials	16	CIU communication interface units	96
Applications	17	CIM communication interface modules	96
		19. Minimum inlet pressure - NPSH	97
7. User interfaces for TPE pumps	20	20. Grundfos Product Center	99
Advanced control panel for TPE pumps	20	Grundfos GO	100
Grundfos GO	24		
Description of selected functions	27		
Priority of settings	57		
Grundfos Eye	58		
Indicator lights and signal relays	59		
8. Factory settings of E-pumps	61		
9. Communication	62		
10. Speed regulation	63		
Affinity equations	63		
11. Motor data	64		
Motors	64		
Electrical data, speed-controlled motors	64		
12. Installation	66		
Mechanical installation	66		

1. Pump data

Introduction

TP pumps are designed for applications such as:

- district heating systems
- heating systems
- air-conditioning systems
- district cooling systems
- water supply
- industrial processes
- industrial cooling.

The pumps are available with either standard motors (TP) or electronically speed-controlled motors (TPE, TPE3, TPE3 D).

This product guide covers TPE3 (D) speed-controlled pumps.

Please see Grundfos publication 99701219 for TP, uncontrolled standard pump, product range and details and 99701220 for TPE series 1000 and 2000 speed controlled pump, product range and details on [Grundfos Product Center](#).

The pumps are all single-stage, in-line centrifugal pumps with mechanical shaft seal. The pumps are of the close-coupled type, that is, the pump and the motor are separate units.

Pump Energy Index

Pump Energy Index (PEI) was established by the U.S. Department of Energy (DOE) and adopted by Canada as the standard metric used to evaluate pump efficiency. The value is the ratio of the pump efficiency rating (PER) divided by the calculated minimally complaint PER (PER_{STD}) for the pump type. This provides a representation of a pump's actual performance compared to the minimal standard performance required by regulation. The lower the PEI value, the more efficient a pump is at the tested operating points.

PER is determined by defined testing parameters required by the DOE. This includes testing a particular pump model at its best efficiency point (BEP).

For PEI values there are two different versions:

- PEI_{CL} (constant load): Applies to a bare-shaft pump, and a pump sold with a motor
- PEI_{VL} (variable load): Applies to pumps sold with a motor and controller (such as VFD, VSD)

The DOE has set the maximum PEI value as 1.00. Any pump, pump and motor, or pump, motor and controller that exceeds a PEI value of 1.00 can no longer be manufactured after January 26, 2020.

PEI is a generalized efficiency value. PEI cannot be used to determine the efficiency of a pump in a specific application.

Product type	PEI_{VL}
TPE3	See "TPE3" on page 10.
TPE3 D	See "TPE3 D" on page 11.

TPE3 pumps

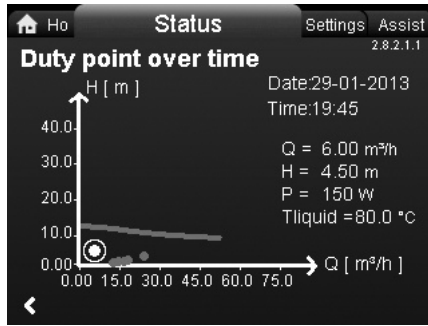

TM06 0883 1114

Fig. 1 Example of status display for TPE3 pumps

The pumps have a built-in differential-pressure sensor and temperature sensor.

The pumps are factory-set to $AUTO_{ADAPT}$ control.

The permanent-magnet motors of the pumps have a built-in frequency converter for continuous adjustment of the pressure to the flow rate. The hydraulic components have been specially designed for optimum efficiency.

The range is recognized as a preset solution for quick and safe installation. The pumps have a color display for easy and intuitive pump setup and with full access to all functions. The pumps incorporate the following advanced functions:

- $AUTO_{ADAPT}$
- $FLOW_{ADAPT}$
- automatic night setback
- $FLOW_{LIMIT}$
- heat energy monitor
- flow rate estimation
- proportional pressure
- constant pressure
- constant differential temperature control
- constant temperature control.

For further information, see page 16.

Why select a TPE pump

A pump with electronic speed control offers these benefits:

- energy savings
- increased comfort
- control and monitoring of pump performance
- communication with the pump.

High-efficiency motors, IE5

The pumps are fitted with Grundfos permanent-magnet MLE motors with motor efficiency class IE5 according to IEC 60034-30-2. The MLE has a combined, motor and drive, efficiency above NEMA Premium Efficiency resulting in additional energy savings of 7-10 %.

Identification

Type key for TPE3 (D)

Code	Example	TPE3	D	65	-150	S	-A	-G	-A	-BQQE	-G	C	B
	Pump range, electronically speed-controlled pump												
TPE3	Built-in differential-pressure and temperature sensor												
	Twin-head pump												
	Nominal diameter of inlet and outlet ports [mm]												
	Maximum head [decimeters (dm)]												
S	Built-in differential-pressure and temperature sensor												
	Code for pump version:												
A	Basic version												
X	Special version												
	Code for pipe connection:												
G	ANSI flange												
	Code for materials:												
A	Basic version												
I	Stainless steel CF8 (1.4308) pump housing and motor stool												
	Code for shaft seal including other plastic and rubber pump parts, except the neck ring												
	Code for NEMA motors [hp (kW)]:												
C	0.33 (0.25)												
D	0.5 (0.37)												
E	0.75 (0.55)												
F	1 (0.75)												
G	1.5 (1.1)												
H	2 (1.5)												
I	3 (2.2)												
	Code for phase & voltage and other information:												
A	1 x 200-240V												
B	3 x 200-240V												
C	3 x 440-480V												
D	3 x 380-500V												
Y	Out of DOE scope												
	Code for speed variant [rpm]:												
A	1450-2200												
B	2900-4000												
C	4000-5900												

Codes for shaft seal

Code	Example	B	Q	Q	E
	Grundfos type designation				
A	O-ring seal with fixed seal driver				
B	Rubber bellows seal				
D	O-ring seal, balanced				
G	Bellows seal with reduced seal faces				
R	O-ring seal with reduced seal faces				
	Material of rotating face				
A	Carbon, antimony-impregnated				
B	Carbon, resin-impregnated				
Q	Silicon carbide				
	Material of stationary seat				
B	Carbon, resin-impregnated				
Q	Silicon carbide				
U	Tungsten carbide				
	Material of secondary seal				
E	EPDM				
P	NBR rubber				
V	FKM				
F	FXM				

2. Performance range

Performance range, TPE3 (D)

See page 78 for performance curves.

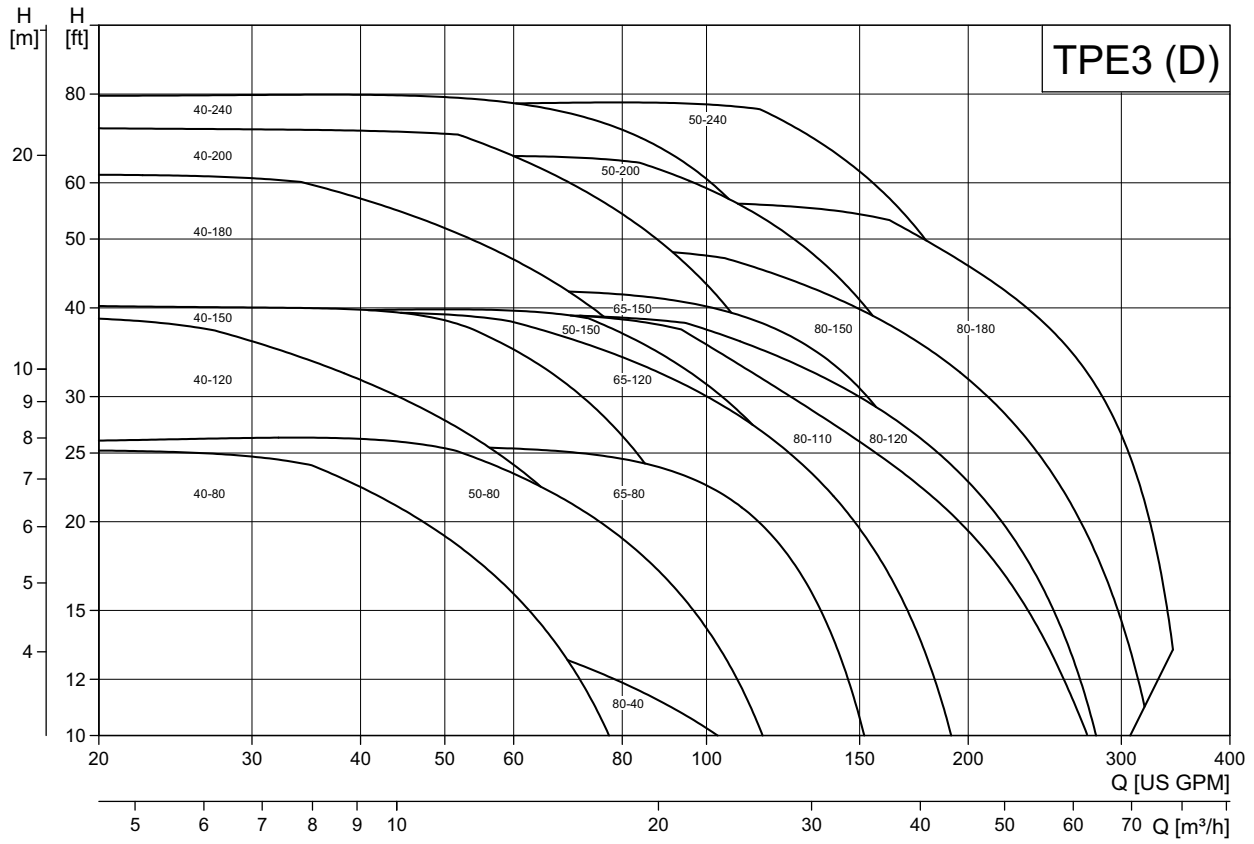

TM07 3024 3220

Performance range, TPE3 D, twin-head operation

See page 78 for performance curves.

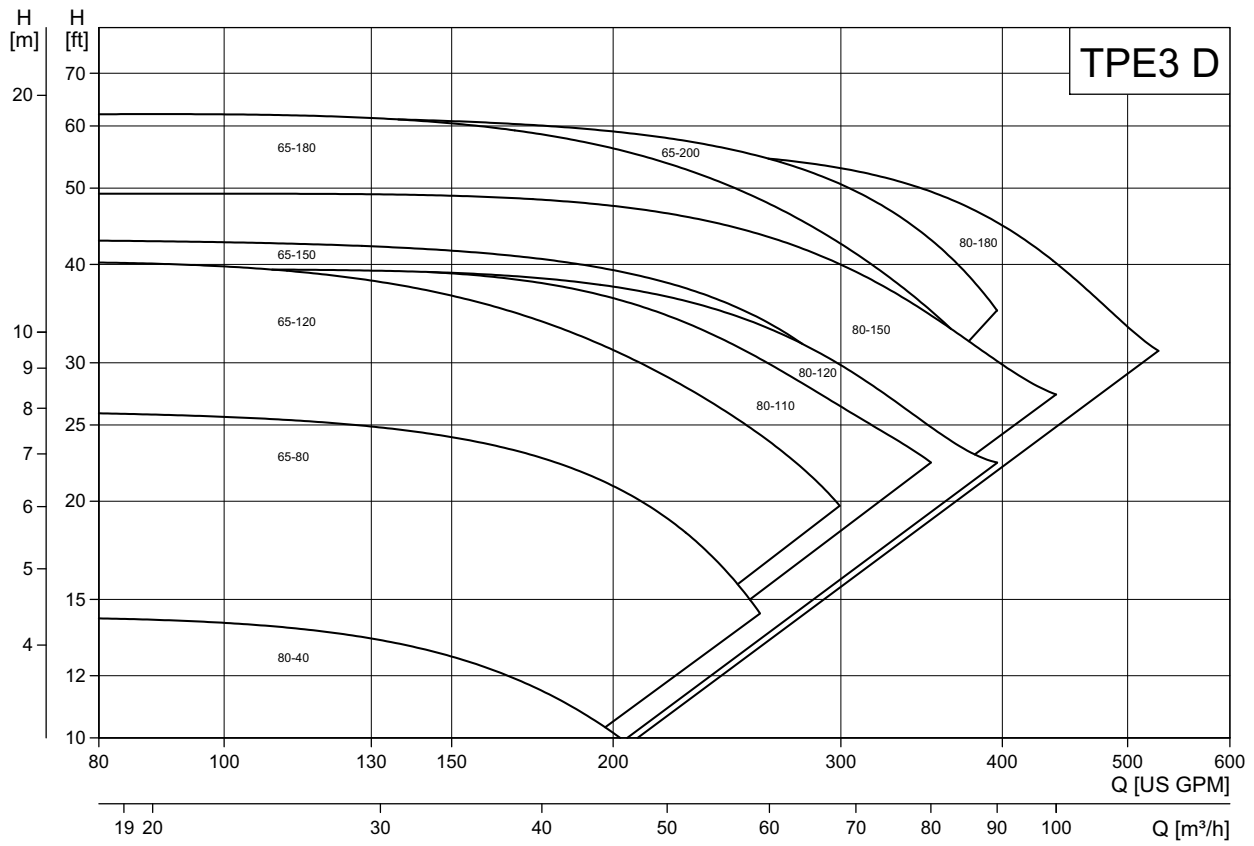

TM07 3025 3220

3. Product range

TPE3

TPE 3 with built-in differential-pressure and temperature sensor								
Pump type	Shaft seal	Cast iron product number	Stainless steel product number	Motor			PEI _{VL}	Impeller diameter [in (mm)]
				P2 [hp (kW)]	Phase	Voltage [V]		
TPE3 40-80	BQQE	98819499	98819518	0.33 (0.25)	1	200-240	*	2.91 (74)
		98819536	98819564	0.33 (0.25)	3	440-480	*	2.91 (74)
TPE3 40-120	BQQE	98819500	98819519	0.5 (0.37)	1	200-240	*	2.91 (74)
		98819537	98819565	0.5 (0.37)	3	440-480	*	2.91 (74)
TPE3 40-150	BQQE	98819501	98819520	0.75 (0.55)	1	200-240	*	2.91 (74)
		99836276	99884114	1.5 (1.1)	3	200-240	*	2.91 (74)
		98819538	98819566	0.75 (0.55)	3	440-480	*	2.91 (74)
TPE3 40-180	BQQE	98819502	98819521	1 (0.75)	1	200-240	*	2.91 (74)
		98819539	98819567	1 (0.75)	3	440-480	*	2.91 (74)
TPE3 40-200	BQQE	98819503	98819522	1.5 (1.1)	1	200-240	*	2.91 (74)
		98819540	98819568	1.5 (1.1)	3	440-480	*	2.91 (74)
TPE3 40-240	BQQE	98819504	98819523	2 (1.5)	1	200-240	*	2.91 (74)
		98819541	98819569	2 (1.5)	3	440-480	*	2.91 (74)
TPE3 50-80	BQQE	98819591	98819610	0.5 (0.37)	1	200-240	*	2.91 (74)
		98819626	98819647	0.5 (0.37)	3	440-480	*	2.91 (74)
		98819593	98819612	1 (0.75)	1	200-240	*	2.91 (74)
TPE3 50-150	BQQE	99836277	99884115	1.5 (1.1)	3	200-240	*	2.91 (74)
		98819628	98819649	1 (0.75)	3	440-480	*	2.91 (74)
TPE3 50-200	BQQE	98819595	98819614	2 (1.5)	1	200-240	*	2.91 (74)
		98819630	98819651	2 (1.5)	3	440-480	*	2.91 (74)
TPE3 50-240	BQQE	98819631	98819652	3 (2.2)	3	440-480	*	2.91 (74)
TPE3 65-80	BQQE	98819667	98819695	0.75 (0.55)	1	200-240	*	3.07 (78)
		98819710	98819729	0.75 (0.55)	3	440-480	*	3.07 (78)
TPE3 65-120	BQQE	98819668	98819696	1 (0.75)	1	200-240	0.39	3.07 (78)
		98819711	98819730	1 (0.75)	3	440-480	0.38	3.07 (78)
		98819682	98819697	1.5 (1.1)	1	200-240	0.36	3.07 (78)
TPE3 65-150	BQQE	99836278	99884116	1.5 (1.1)	3	200-240	0.36	3.07 (78)
		98819712	98819731	1.5 (1.1)	3	440-480	0.39	3.07 (78)
TPE3 80-40	BQQE	98819743	98819903	0.33 (0.25)	1	200-240	*	3.54 (90)
		98819748	98819908	0.33 (0.25)	3	440-480	*	3.54 (90)
TPE3 80-110	BQQE	99836279	99884117	1.5 (1.1)	3	200-240	0.40	3.54 (90)
TPE3 80-120	BQQE	98819749	98819909	1.5 (1.1)	3	440-480	0.42	3.54 (90)
		98819756	98819916	1.5 (1.1)	1	200-240	0.43	3.54 (90)
TPE3 80-150	BQQE	98819750	98819910	2 (1.5)	3	440-480	0.42	3.54 (90)
		99836280	99884118	2 (1.5)	3	200-240	0.40	3.54 (90)
		98819757	98819917	2 (1.5)	1	200-240	0.42	3.54 (90)
TPE3 80-180	BQQE	99836281	99884119	3 (2.2)	3	200-240	0.36	3.54 (90)
		98819751	98819911	3 (2.2)	3	440-480	0.38	3.54 (90)

*Note: Product does not have a PEI_{VL} because it is not in the DOE regulation.

TPE3 D

TPE 3 D with built-in differential-pressure and temperature sensor								
Pump type	Shaft seal	Cast iron product number	Stainless steel product number	Motor			PEI _{VL}	Impeller diameter [in (mm)]
				P2 [hp (kW)]	Phase	Voltage [V]		
TPE3 D 65-80	BQQE	98819795	-	0.75 (0.55)	1	200-240	*	3.07 (78)
		98819847	-	0.75 (0.55)	3	440-480	*	3.07 (78)
TPE3 D 65-120	BQQE	98819796	-	1 (0.75)	1	200-240	0.39	3.07 (78)
		98819848	-	1 (0.75)	3	440-480	0.38	3.07 (78)
TPE3 D 65-150	BQQE	98819797	-	1.5 (1.1)	1	200-240	0.36	3.07 (78)
		99849240	-	1.5 (1.1)	3	200-240	0.36	3.07 (78)
TPE3 D 65-180	BQQE	98819849	-	1.5 (1.1)	3	440-480	0.39	3.07 (78)
		98819798	-	2 (1.5)	1	200-240	0.39	3.07 (78)
TPE3 D 65-200	BQQE	98819850	-	2 (1.5)	3	440-480	0.36	3.07 (78)
		98819851	-	3 (2.2)	3	440-480	0.36	3.07 (78)
TPE3 D 80-40	BQQE	98819799	-	0.33 (0.25)	1	200-240	*	3.54 (90)
		98819852	-	0.33 (0.25)	3	440-480	*	3.54 (90)
TPE3 D 80-110	BQQE	99884124	-	1.5 (1.1)	3	200-240	0.40	3.54 (90)
TPE3 D 80-120	BQQE	98819800	-	1.5 (1.1)	1	200-240	0.43	3.54 (90)
		98819853	-	1.5 (1.1)	3	440-480	0.42	3.54 (90)
TPE3 D 80-150	BQQE	98819801	-	2 (1.5)	1	200-240	0.42	3.54 (90)
		99849735	-	2 (1.5)	3	200-240	0.40	3.54 (90)
TPE3 D 80-180	BQQE	98819854	-	2 (1.5)	3	440-480	0.42	3.54 (90)
		99849733	-	3 (2.2)	3	200-240	0.36	3.54 (90)
TPE3 D 80-180	BQQE	98819855	-	3 (2.2)	3	440-480	0.38	3.54 (90)

*Note: Product does not have a PEI_{VL} because it is not in the DOE regulation.

4. Operating conditions

Maximum operating and test pressures

Pressure	Maximum operating pressure		Test pressure	
	[bar]	[psi]	[bar]	[psi]
PN 16	16	232	24	348

Sound pressure level

The selection of TPE pumps will reduce the noise at partial load as the motor and, consequently, the motor fan run at a lower speed. Possible flow noise from control valves is also reduced at partial load in the case of the TPE3 pumps.

See "Sound pressure level" on page 70.

Ambient temperature

Ambient temperature during storage and transportation

Minimum: -22 °F (-30 °C).

Maximum: 140 °F (60 °C).

Ambient temperature during operation

	3 x 200-240 V	1 x 200-240 V 3 x 440-480 V
Minimum	-4 °F (-20 °C)	-4 °F (-20 °C)
Maximum	104 °F (40 °C)	122 °F (50 °C)

The motor can operate with the rated power output, P2, at 122 °F (50 °C), but continuous operation at higher temperatures reduces the expected product life. If the motor is to operate at ambient temperatures between 122 and 140 °F (50 and 60 °C), select an oversized motor. Contact Grundfos for further information.

Installation altitude

Pump with Grundfos MLE motor

Installation altitude is the height above sea level of the installation site.

Motors installed up to 3280 ft (1000 m) above sea level can be loaded 100 %.

The motors can be installed up to 6560 ft (2000 m) above sea level.

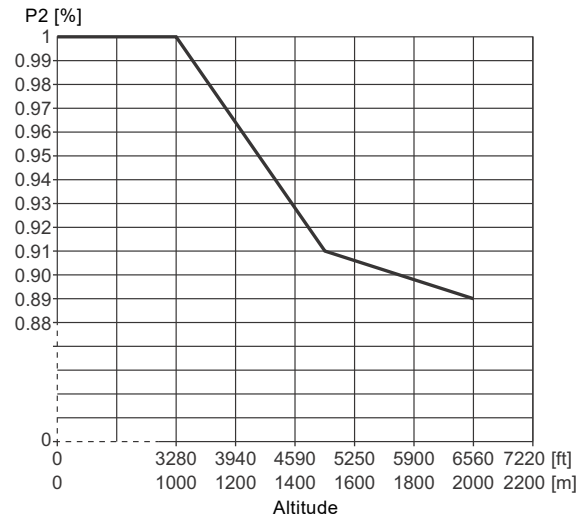

TM05 9217 3513

Fig. 2 Motor output power in relation to altitude

Note:

Motors installed more than 3280 ft (1000 m) above sea level must not be fully loaded due to the low density and consequent low cooling effect of the air.

5. Pumped liquids

Pumped liquids

The pump is suitable for thin, clean, non-aggressive and non-flammable liquids, not containing solid particles or fibres that may attack the pump mechanically or chemically. See [List of pumped liquids](#) on page 13.

Examples

- Central heating system water. The water must meet the requirements of accepted standards on water quality in heating systems:
- cooling liquids
- domestic hot water
- industrial liquids
- softened water.

If glycol or another antifreeze agent is added to the pumped liquid, the pump must have a shaft seal of the BQQE type. See [Shaft seal for water-glycol mixture](#) on page 15.

The pumping of liquids with density and/or kinematic viscosity higher than that of water will have the following effects:

- a considerable pressure drop
- a drop in hydraulic performance
- a rise in power consumption.

In such cases, fit the pump with a bigger motor. If in doubt, contact Grundfos.

If the water contains mineral or synthetic oils or chemicals, or if liquids other than water are pumped, choose the O-rings accordingly.

Liquid temperature

Liquid temperature: -13 to 248 °F (-25 to +120 °C).

Please note that shaft seals operating close to their maximum temperature will require regular maintenance or replacement.

Pump type	Shaft seal	Temperature
TPE3	BQQE	-13 to 248 °F (-25 to +120 °C)

Depending on the type of cast-iron version and the pump application, the maximum liquid temperature may be limited by local regulations and laws.

List of pumped liquids

TP pumps are designed for circulation systems with constant flow rate; TPE3, TPE3D, TPE pumps for systems with variable flow rate.

Thanks to their design, you can use these pumps in a wider liquid temperature range than pumps of the canned rotor type.

A number of typical liquids are listed below.

You can use other pump versions, but we consider the ones listed below to be the best choices.

The list is intended as a general guide only, and it cannot replace actual testing of the pumped liquids and pump materials under specific working conditions. Use the list with some caution as factors such as concentration of the pumped liquid, liquid temperature or pressure may affect the chemical resistance of a specific pump version.

Legend

A	May contain additives or impurities that can cause shaft seal problems.
B	The density and/or viscosity differ from those of water. Consider this when calculating motor and pump performance.
C	The liquid must be oxygen-free (anaerobic).
D	Risk of crystallization or precipitation in the shaft seal.
E	Insoluble in water.
F	The shaft seal rubber parts must be replaced with FKM rubber.
G	Bronze housing or impeller required.
H	Risk of ice formation on the standby pump. The risk only applies to TP, TPE Series 200 pumps.

Pumped liquids	Notes	Additional information	Shaft seal
			TPE3
Water			
Groundwater		< 248 °F (120 °C)	BQBE ²⁾ BQQE
		> 248 °F (120 °C)	
Boiler-feed water		< 248 °F (120 °C)	BQBE ²⁾ BQQE
District-heating water		< 248 °F (120 °C)	BQBE ²⁾ BQQE
Condensate		< 248 °F (120 °C)	BQBE BQQE
		> 248 °F (120 °C)	
Softened water	C	< 248 °F (120 °C)	BQBE ²⁾ BQQE
Brackish water	G	pH > 6.5, 104 °F (40 °C), 1000 ppm Cl ⁻	BQBE ²⁾ BQQE
Coolants			
Ethylene glycol	B, D, H	< 248 °F (120 °C)	BQQE
Glycerine (glycerol)	B, D, H	< 248 °F (120 °C)	BQQE
Potassium acetate	B, D, C, H	< 248 °F (120 °C)	BQQE
Potassium formate	B, D, C, H	< 248 °F (120 °C)	BQQE
Propylene glycol	B, D, H	< 248 °F (120 °C)	BQQE
Brine sodium chloride	B, D, C, H	< 41 °F (5 °C), 30 %	BQQE
Synthetic oils			
Silicone oil	B, E		BQBE ²⁾ BQQE
Vegetable oils			
Corn oil	B, F, E		BUBV ²⁾ + 3) BQQV ²⁾ + 3)
Olive oil	B, F, E	< 176 °F (80 °C)	BUBV ²⁾ + 3) BQQV ²⁾ + 3)
Peanut oil	B, F, E		BUBV ²⁾ + 3) BQQV ²⁾ + 3)
Rapeseed oil	D, B, F, E		BUBV ²⁾ + 3) BQQV ²⁾ + 3)
Soybean oil	B, F, E		BUBV ²⁾ + 3) BQQV ²⁾ + 3)

Pumped liquids	Notes	Additional information	Shaft seal
			TPE3
Cleaning agents			
Soap (salts of fatty acids)	A, E, (F)	< 176 °F (80 °C)	BQQE (BQQV) ²⁾
Alkaline degreasing agent	A, E, (F)	< 176 °F (80 °C)	BQQE (BQQV) ²⁾ + 3)
Oxidants			
Hydrogen peroxide		< 104 °F (40 °C), < 2 %	BQBE ²⁾ BQQE
Salts			
Ammonium bicarbonate	A	< 68 °F (20 °C), < 15 %	BQQE
Calcium acetate	A, B	< 68 °F (20 °C), < 30 %	BQQE
Potassium bicarbonate	A	< 68 °F (20 °C), < 20 %	BQQE
Potassium carbonate	A	< 68 °F (20 °C), < 20 %	BQQE
Potassium permanganate	A	< 68 °F (20 °C), < 10 %	BQQE
Potassium sulphate	A	< 68 °F (20 °C), < 20 %	BQQE
Sodium acetate	A	< 68 °F (20 °C), < 100 %	BQQE
Sodium bicarbonate	A	< 68 °F (20 °C), < 2 %	BQQE
Sodium carbonate	A	< 68 °F (20 °C), < 20 %	BQQE
Sodium nitrate	A	< 32 °F (0 °C), < 40 %	BQQE
Sodium nitrite	A	< 68 °F (20 °C), < 40 %	BQQE
Sodium phosphate (di)	A	< 212 °F (100 °C), < 30 %	BQQE
Sodium phosphate (tri)	A	< 194 °F (90 °C), < 20 %	BQQE
Sodium sulphate	A	< 68 °F (20 °C), < 20 %	BQQE
Sodium sulphite	A	< 68 °F (20 °C), < 1 %	BQQE
Alkalis			
Ammonium hydroxide		< 212 °F (100 °C), < 30 %	BQQE
Calcium hydroxide	A	< 212 °F (100 °C), < 10 %	BQQE
Potassium hydroxide	A	< 68 °F (20 °C), < 20 %	BQQE
Sodium hydroxide	A	< 104 °F (40 °C), < 20 %	BQQE

1) Do not use BAQE for potable water. For potable water, we recommend that you use a BBQE shaft seal.

2) The shaft seal is not standard, but is available on request.

3) Do not use for potable water.

Shaft seal for water-glycol mixture

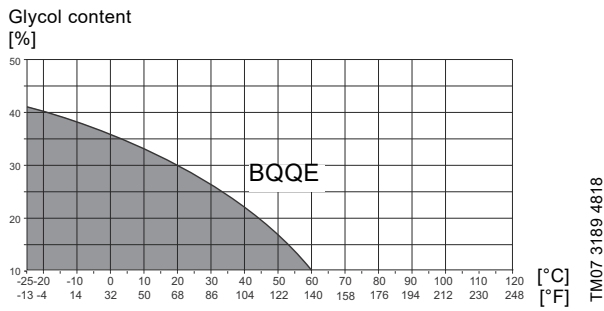

Fig. 3 Operating range of EPDM shaft seals

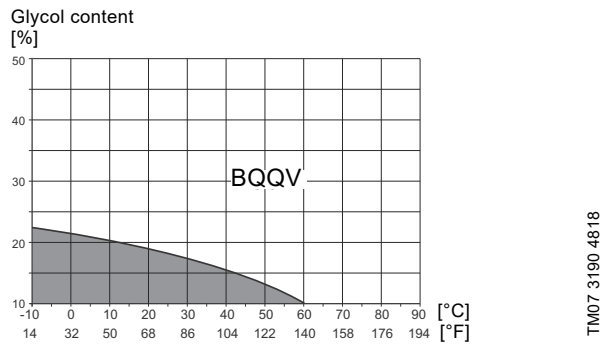

Fig. 4 Operating range of FKM shaft seals

6. TPE3, TPE3 D



Fig. 5 TPE3 and TPE3 D pumps

Technical data

Flow rate:	Up to 528 GPM (120 m ³ /h)
Head:	Up to 82 ft25 m
Liquid temperature:	-13 to 248 °F (-25 to +120 °C)
Maximum operating pressure:	232 psi (16 bar)
Motor sizes, single-phase:	0.33 to 2 hp (0.25 to 1.5 kW)
Motor sizes, three-phase:	0.33 to 3 hp (0.25 to 2.2 kW)

Construction

The pumps have built-in differential-pressure and temperature sensor.

The permanent-magnet motor has a built-in frequency converter for continuous adjustment of the pressure to the flow rate. All pumps are fitted with Grundfos permanent-magnet MLE motors that have motor efficiency class IE5 according to IEC 60034-30-2.

The range is a preset solution for quick and safe installation.

The pump has a color display for easy and intuitive pump setup and with full access to all functions.

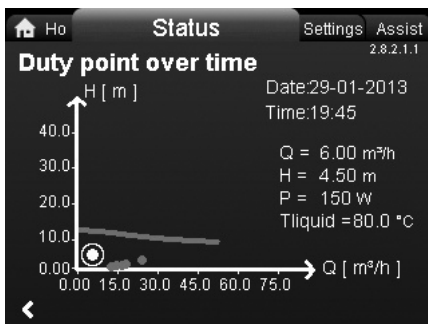

Fig. 6 Example of status display for TPE3 pumps

The pumps are available as single-head, TPE3, and twin-head, TPE3 D, pumps.

The pumps have Class 125 flanges.

The pumps are fitted with an unbalanced mechanical shaft seal.

The power head (motor, pump head and impeller) and pump housing are held together by a specially designed clamp. The clamp allows fast repositioning of the pump housing and fast service of the pump.

The twin-head pumps are designed with two parallel power heads. A flap valve in the common outlet port is opened by the flow of the pumped liquid and prevents backflow of liquid into the idle pump head.

As radial and axial forces are absorbed by the fixed bearing in the motor drive-end, the pump requires no bearing.

Pumps with stainless-steel pump housing, version I, are suitable for circulation of domestic hot water.

Materials

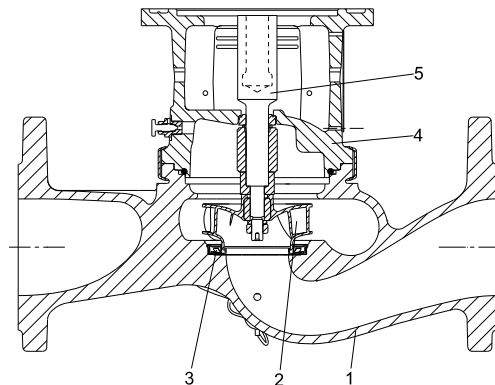

Fig. 7 Sectional drawing of a TPE3 pump

Material specification

Pos.	Component	Material	EN/DIN (ASTM/AISI)
1	Pump housing	Cast iron EN-GJL-250	EN1561 (ASTM A48 CL 40B)
		Stainless steel	EN 1.4308 (CF8)
2	Impeller	Composite PES-GF30	
3	Neck ring	Stainless steel	EN 1.4404 (316/316L)
4	Pump head/motor stool	Cast iron EN-GJL-250	EN1561 (ASTM A48 CL 40B)
		Stainless steel	EN 1.4308 (CF8)
	Secondary seals	EPDM	
	Rotating seal face	Silicon carbide	
	Stationary seat	Silicon carbide	
5	Stub shaft	Stainless steel	EN 1.4404 (316/316L)

TM07 3079 4518 - TM07 3080 4518

TM05 8200 2113

TM06 0883 1114

Applications

The pumps have integrated speed control for automatic adaptation of performance to current conditions.

The energy consumption is thus kept at a minimum.

The pumps can operate at any duty point within the range between minimum and maximum speed.

Depending on the application, the pumps offer energy savings, increased comfort or improved processing. The pumps are suitable for applications requiring pressure control.

AUTO_{ADAPT}

TPE3 pumps are factory-set to AUTO_{ADAPT} which continuously adapts the pump performance according to the actual system characteristic.

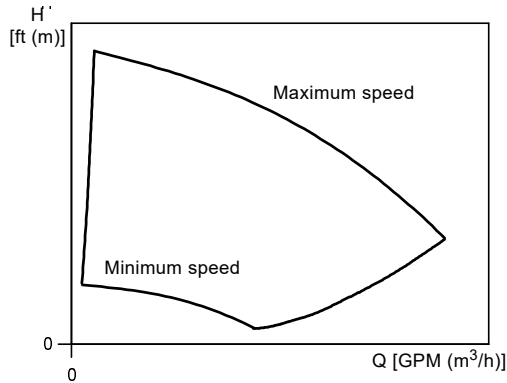
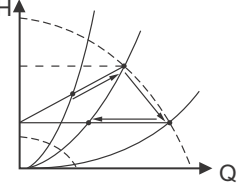
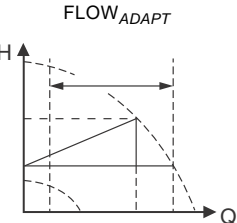
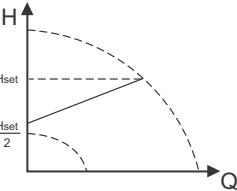
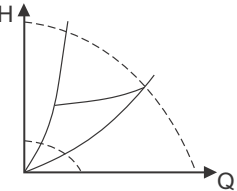

Fig. 8 Duty range of TPE3

System application	Select this control mode
<p>Recommended for most heating systems, especially in systems with relatively large pressure losses in the distribution pipes. See description under proportional pressure. In replacement situations where the proportional-pressure duty point is unknown. The duty point has to be within the "AUTO_{ADAPT}" operating range. During operation, the pump automatically makes the necessary adjustment to the actual system characteristics. This setting ensures minimum energy consumption and low noise level from the valves, and therefore reduces operating costs and increases comfort.</p>	<p>"AUTO_{ADAPT}"</p> 
<p>The FLOW_{ADAPT} control mode is a combination of AUTO_{ADAPT} and FLOW_{LIMIT}. This control mode is suitable for systems where a maximum flow rate limit, FLOW_{LIMIT}, is desired. The pump continuously monitors and adjusts the flow rate, thus ensuring that the selected FLOW_{LIMIT} is not exceeded. Main pumps in boiler applications where a steady flow through the boiler is required. No extra energy is used for pumping too much liquid into the system. In systems with mixing loops, the control mode can control the flow rate in each loop.</p> <p>Benefits:</p> <ul style="list-style-type: none"> • Enough water for all loops at peak load conditions if each loop has been set to the right maximum flow rate. • The dimensioned flow rate for each zone, required heat energy, is determined by the flow from the pump. This value can be set precisely in the FLOW_{ADAPT} control mode without the use of pump throttling valves. • When the flow rate is set lower than the balancing valve setting, the pump ramps down instead of losing energy by pumping against a balancing valve. • Cooling surfaces in air-conditioning systems operate at high pressure and low flow rate. 	<p>FLOW_{ADAPT}</p> 
<p>In systems with relatively large pressure losses in the distribution pipes and in air-conditioning and cooling systems.</p> <ul style="list-style-type: none"> • Two-pipe heating systems with thermostatic valves and the following: <ul style="list-style-type: none"> – very long distribution pipes – strongly throttled pipe balancing valves – differential-pressure regulators – large pressure losses in those parts of the system through which the total quantity of water flows, for example, boiler, heat exchanger and distribution pipe up to the first branching. • Primary circuit pumps in systems with large pressure losses in the primary circuit. • Air-conditioning systems with the following: <ul style="list-style-type: none"> – heat exchangers (fan coils) – cooling ceilings – cooling surfaces. 	<p>Proportional pressure</p> 
<p>In systems with relatively large pressure losses in the distribution pipes and in air-conditioning and cooling systems.</p> <ul style="list-style-type: none"> • Two-pipe heating systems with thermostatic valves and the following: <ul style="list-style-type: none"> – very long distribution pipes – strongly throttled pipe balancing valves – differential-pressure regulators – large pressure losses in those parts of the system through which the total quantity of water flows, for example, boiler, heat exchanger and distribution pipe up to the first branching. • Primary circuit pumps in systems with large pressure losses in the primary circuit. • Air-conditioning systems with the following: <ul style="list-style-type: none"> – heat exchangers (fan coils) – cooling ceilings – cooling surfaces. 	<p>Constant differential pressure with differential-pressure sensor located in the system</p> 

System application**Select this control mode**

In systems with relatively small pressure losses in the distribution pipes.

- Two-pipe heating systems with thermostatic valves and the following:
 - dimensioned for natural circulation
 - small pressure losses in those parts of the system through which the total quantity of water flows, for example, boiler, heat exchanger and distribution pipe up to the first branching or modified to a high differential temperature between flow pipe and return pipe, for example, district heating.
- Underfloor heating systems with thermostatic valves.
- One-pipe heating systems with thermostatic valves or pipe balancing valves.
- Primary circuit pumps in systems with small pressure losses in the primary circuit.

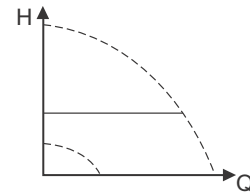
Constant differential pressure

In pressure boosting systems.

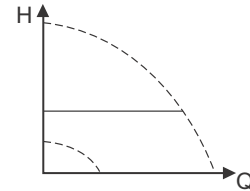
Constant pressure

In systems with a fixed system characteristic.

Examples:

- one-pipe heating systems
- boiler shunts
- systems with three-way valves
- domestic hot-water circulation.

You can use $FLOW_{LIMIT}$ to control the maximum circulation flow rate.

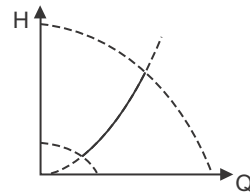
Constant temperature and constant differential temperature

In systems requiring a constant flow rate, independently of pressure drop.

Examples:

- chillers for air-conditioning
- heating surfaces
- cooling surfaces.

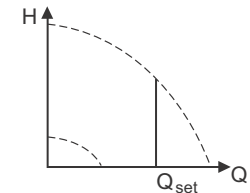
Constant flow rate

In systems requiring a constant tank level, independently of the flow rate.

Examples:

- process water tanks
- boiler condensate tanks.

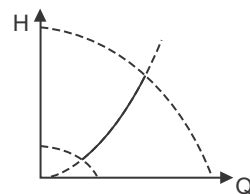
Constant level

In systems with pumps operating in parallel.

The multipump function enables the control of single-head pumps connected in parallel (two to four pumps) and twin-head pumps without the use of external controllers. The pumps in a multipump system communicate with each other via the wireless GENIair connection or the wired GENI connection.

**"Assist" menu
"Multipump setup"**

Multipump system

The multipump function enables the control of two pumps connected in parallel without the use of external controllers. The pumps in a multipump system communicate with each other via the wireless GENIair connection or the wired GENI connection.

A multipump system is set via a selected pump: the master pump, which is the first selected pump. If two pumps in the system are configured with an outlet-pressure sensor, both pumps can function as master pumps and take over the master pump function if the other fails. This provides additional redundancy in the multipump system.

The multipump functions are described in the following sections.

Alternating operation

Alternating operation functions as a duty-standby operating mode and is possible with two pumps of same size and type connected in parallel. The main purpose of the function is to ensure an even amount of running hours and to ensure that the standby pump takes over if the running pump stops due to an alarm. Each pump requires a non-return valve in series with the pump.

You can choose between two alternating operation modes:

- Alternating operation, time.
Pump changeover to the other is based on time.
- Alternating operation, energy.
Pump changeover to the other is based on energy consumption.
If the duty pump fails, the other pump takes over automatically.
Only one pump is operating at a time. The change from one pump to the other depends on time or energy. If a pump fails, the other pump takes over automatically.

Pump system:

- Twin-head pump.
- Two single-head pumps connected in parallel.
The pumps must be of the same type and size.
Each pump requires a non-return valve in series with the pump.

Backup operation

Backup operation is possible with two same size and type pumps connected in parallel. Each pump requires a non-return valve in series with the pump.

One pump is operating continuously. The backup pump is operated for a short time each day to prevent seizing up. If the duty pump stops due to a fault, the backup pump starts automatically.

Pump system:

- Twin-head pump.
- Two single-head pumps connected in parallel.
The pumps must be of the same type and size.
Each pump requires a non-return valve in series with the pump.

Cascade operation

Cascade operation ensures that the pump performance is automatically adapted to the consumption by switching pumps on or off. As a result, the system runs as energy-efficiently as possible with a constant pressure and a limited number of pumps. When a twin-head pump is running in constant-pressure control mode, the second pump head starts at 90 % and stops at 50 % performance. All pumps in operation run at equal speed. Pump changeover is automatic and depends on energy, operating hours and fault.

Pump system:

- Twin-head pump.
- Two to four single-head pumps connected in parallel.
The pumps must be of the same type and size.
Each pump requires a non-return valve in series with the pump.
Set the control mode to "Const. pressure" or "Const. curve".

Control options

Communication with the pumps is possible via the control panel, Grundfos GO or a central building management system.

The purpose of controlling the pumps is to monitor and control the pressure, temperature, flow rate of the system.

For further information on control options of the pumps, see page [62](#).

7. User interfaces for TPE pumps

Advanced control panel for TPE pumps

Pump variant	Fitted as standard	Option
TPE3, TPE3 D	•	-

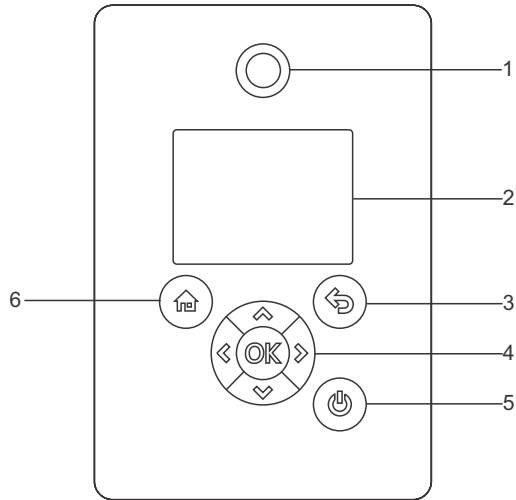
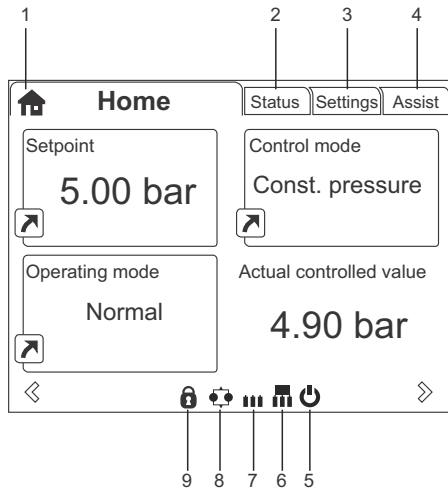

Fig. 9 Advanced control panel



Pos.	Symbol	Description
1		Grundfos Eye The indicator light shows the operating status of the pump. See Priority of settings on page 57 for further information.
2	-	Graphical color display.
3		Press the button to go one step back.
		Press the button to navigate between main menus, displays and digits. When you change the menu, the display always shows the top display of the new menu.
		Press the buttons to navigate between submenus or change value settings. Note: If you have disabled the possibility to make settings with the "Enable/disable settings" function, then you can enable it again temporarily by pressing these buttons simultaneously for at least 5 seconds. See "Buttons on product" ("Enable/disable settings") on page 50.
4		Press the button to save changed values, reset alarms and expand the value field. The button enables radio communication with Grundfos GO and other products of the same type. When you try to establish radio communication between the pump and Grundfos GO or another pump, the green indicator light in Grundfos Eye flashes. A note also appears in the pump display stating that a wireless device wants to connect to the pump. Press on the pump control panel to allow radio communication with Grundfos GO and other products of the same type.
5		Press the button to make the pump ready for operation and pump start and stop. Start: If you press the button when the pump is stopped, the pump will only start if no other functions with higher priority have been enabled. Stop: If you press the button when the pump is running, the pump is always stopped. When you stop the pump via this button, the icon appears in the bottom of the display.
6		Press the button to go to the "Home" menu.

"Home" display



TM06 4516 2415

Fig. 10 Example of "Home" display

Pos.	Symbol	Description
1		"Home" This menu shows up to four user-defined parameters. You can select parameters shown as shortcut icon  , and when pressing  you go directly to the "Settings" display for the selected parameter.
2	-	"Status" This menu shows the status of the pump and system as well as warnings and alarms.
3	-	"Settings" This menu gives access to all setting parameters. You can make detailed settings of the pump in this menu. See Description of selected functions on page 27.
4	-	"Assist" This menu enables "Assisted Pump Setup", provides a short description of the control modes and offers fault advice. See "Assist" on page 52.
5		This symbol indicates that the pump has been stopped via the  button.
6		This symbol indicates that the pump is functioning as master pump in a multipump system.
7		This symbol indicates that the pump is functioning as a slave pump in a multipump system.
8		This symbol indicates that the pump is operating in a multipump system. See "Multipump setup" ("Setup of multi-pump system") on page 53.
9		This symbol indicates that the possibility to make settings has been disabled for protective reasons. See "Buttons on product" ("Enable/disable settings") on page 50.

Startup guide

The pump incorporates a startup guide which is started at the first startup. See ["Run startup guide"](#) on page 51. After the startup guide, the main menus appear in the display.

Menu overview for advanced control panel

Main menus

Home	TPE3, TPE3 D	Multipump system		
	•	•		
Status	TPE3, TPE3 D	Multipump system	Section	Page
"Operating status"	•	•		
"Operating mode, from"	•	•		
"Control mode"	•	•		
"Pump performance"	•	•		
"Actual controlled value"	•	•		
"Max. curve and duty point"	•	•		
"Resulting setpoint"	•	•		
"Liquid temperature"	•	•		
"Speed"	•	•		
"Acc. flow, specific energy"	•	•		
"Power and energy consumption"	•	•		
"Measured values"	•	•		
"Analog input 1"	•	•		
"Analog input 2"	•	•		
"Analog input 3"	•	•		
"Pt100/1000 input 1"	•	•		
"Pt100/1000 input 2"	•	•		
"Analog output"	•	•		
"Warning and alarm"	•	•		
"Actual warning and alarm"	•	•		
"Warning log"	•	•		
"Alarm log"	•	•		
"Heat energy monitor"	•	•	"Heat energy monitor"	27
"Heat power"	•	•		
"Heat energy"	•	•		
"Flow rate"	•	•		
"Volume"	•	•		
"Hour counter"	•	•		
"Temperature 1"	•	•		
"Temperature 2"	•	•		
"Differential temp."	•	•		
"Operating log"	•	•		
"Operating hours"	•	•		
"Trend data"	•	•		
"Fitted modules"	•	•		
"Date and time"	•	•		
"Product identification"	•	•		
"Motor bearing monitoring"	•	•		
"Multipump system"		•		
"System operating status"		•		
"System performance"		•		
"System input power and energy"		•		
"Pump 1, multipump sys."		•		
"Pump 2, multipump sys."		•		
"Pump 3, multipump sys."		•		
• Available.				
Settings	TPE3, TPE3 D	Multipump system	Section	Page
"Setpoint"	•	•	"Setpoint"	27
"Operating mode"	•	•	"Operating mode"	27
"Set manual speed"	•	•	"Set manual speed"	28
"Set user-defined speed"	•	•	"Set user-defined speed"	28
"Control mode"	•	•	"Control mode"	28
"Flow limit"	•	•	"FLOW _{LIMIT} "	35
"Automatic night setback"	•	•	"Automatic night setback"	35

Settings	TPE3, TPE3 D	Multipump system	Section	Page
"Analog inputs"	•	•		
"Analog input 1, setup"	•	•	"Analog inputs"	35
"Analog input 2, setup"	•	•		
"Analog input 3, setup"	•	•		
"Built-in Grundfos sensor"	•	•	"Built-in Grundfos sensor"	37
"Pt100/1000 inputs"	•	•		
"Pt100/1000 input 1, setup"	•	•	"Pt100/1000 inputs"	38
"Pt100/1000 input 2, setup"	•	•		
"Digital inputs"	•	•		
"Digital input 1, setup"	•	•	"Digital inputs"	38
"Digital input 2, setup"	•	•		
"Digital inputs/outputs"	•	•		
"Digital input/output 3, setup"	•	•	"Digital inputs/outputs"	39
"Digital input/output 4, setup"	•	•		
"Relay outputs"	•	•		
"Relay output 1"	•	•	"Signal relays 1 and 2" ("Relay outputs")	39
"Relay output 2"	•	•		
"Analog output"	•	•		
"Output signal"	•	•	"Analog output"	40
"Function of analog output"	•	•		
"Controller settings"	•	•	"Controller" ("Controller settings")	41
"Operating range"	•	•	"Operating range"	42
"Setpoint influence"	•	•	"Setpoint influence"	43
"External setpoint function"	•	•	"External setpoint influence"	43
"Predefined setpoints"	•	•	"Predefined setpoints"	45
"Temperature influence"	•	•	"Temperature influence"	45
"Monitoring functions"	•	•		
"Motor bearing monitoring"	•	•	"Motor bearing monitoring"	48
"Motor bearing maintenance"	•	•	"Bearings replaced" ("Motor bearing maintenance")	48
"Limit-exceeded function"	•	•	"Limit-exceeded function"	46
"Special functions"	•	•	Special functions	47
"Pulse flowmeter setup"	•	•	"Pulse flowmeter setup"	47
"Ramps"	•	•	"Ramps"	47
"Standstill heating"	•	•	"Standstill heating"	48
"Communication"	•	•	Communication	49
"Pump number"	•	•	"Number" ("Pump number")	49
"Enable/disable radio communication"	•	•	"Radio communication" ("Enable/disable radio comm.")	49
"General settings"	•	•	General settings	49
"Language"	•	•	"Language"	49
"Set date and time"	•	•	"Date and time"	49
"Units"	•	•	"Unit configuration" ("Units")	49
"Enable/disable settings"	•	•	"Buttons on product" ("Enable/disable settings")	50
"Delete history"	•	•	"Delete history"	50
"Define Home display"	•	•	"Define Home display"	50
"Display settings"	•	•	"Display settings"	50
"Store actual settings"	•	•	"Store settings" ("Store actual settings")	50
"Recall stored settings"	•	•	"Recall settings" ("Recall stored settings")	50
"Run startup guide"	•	•	"Run startup guide"	51

• Available.

Assist	TPE3, TPE3 D	Multipump system	Section	Page
"Assisted pump setup"	•	•	"Assisted pump setup"	52
"Setup, analog input"	•	•	"Setup, analog input"	53
"Setting of date and time"	•	•	"Date and time"	49
"Multipump setup"	•	•	"Multipump setup" ("Setup of multi-pump system")	53
"Description of control mode"	•	•	"Description of control mode"	56
"Assisted fault advice"	•	•	"Assisted fault advice"	56

• Available.

Grundfos GO

The pump is designed for wireless radio or infrared communication with Grundfos GO.

Grundfos GO enables setting of functions and gives access to status overviews, technical product information and actual operating parameters.

Grundfos GO offers the following mobile interfaces, MI.

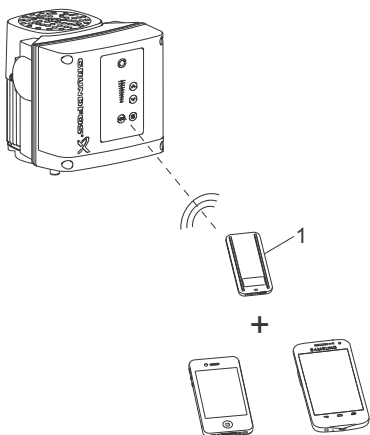

TM06 6256 09 16

Fig. 11 Grundfos GO communicating with the pump via radio or infrared connection, IR

Pos.	Description
1	Grundfos MI 301: Separate module enabling radio or infrared communication. You can use the module in conjunction with an Android or iOS-based smart device with Bluetooth connection.

Communication

When Grundfos GO initiates communication with the pump, the indicator light in the middle of Grundfos Eye flashes green. See [Grundfos Eye](#) on page 58.

Furthermore, on pumps fitted with an advanced control panel a text appears in the display saying that a wireless device is trying to establish connection. Press **OK** on the pump in order to establish connection with Grundfos GO or press **⏠** to reject connection.

Establish communication using one of these communication types:

- radio communication
- infrared communication.

Radio communication

Radio communication can take place at distances up to 98 feet. The first time Grundfos GO communicates with the pump, you must enable communication by pressing **☎** or **OK** on the pump control panel. Later when communication takes place, the pump is recognized by Grundfos GO, and you can select the pump from the "List" menu.

Infrared communication

When communicating via infrared light, Grundfos GO must be pointed at the pump control panel.

Menu overview for Grundfos GO

Main menus

Dashboard	TPE3, TPE3 D	Multipump system		
	•	•		
Status	TPE3, TPE3 D	Multipump system	Section	Page
"System mode"		•		
"Resulting setpoint"	•			
"Resulting system setpoint"		•		
"Actual controlled value"	•	•		
"Sensor value"				
"Motor speed (rpm. %)"	•			
"Power consumption"	•			
"Power consumption, system"		•		
"Energy consumption"	•			
"Energy consumption, system"		•		
"Acc. flow, specific energy"	•	•		
"Operating hours, system"		•		
"Operating hours"	•			
"Motor current"	•	•		
"Number of starts"	•	•		
"Liquid temperature"	•			
"Analog input 1"	•			
"Analog input 2"	•			
"Analog input 3"	•			
"Pt100/1000 input 1"	•			
"Pt100/1000 input 2"	•			
"Analog output"	•			
"Digital input 1"	•			
"Digital input 2"	•			
"Digital in/output 3"	•			
"Digital in/output 4"	•			
"Motor bearing service"	•	•		
"Fitted modules"	•			
"Trend data"	•			
"Heat energy monitor"	•		<i>"Heat energy monitor"</i>	27
"Pump1"		•		
"Pump2"		•		
"Pump3"		•		
"Pump4"		•		

- Available.

Settings	TPE3, TPE3 D	Multipump system	Section	Page
"Setpoint"	•	•	"Setpoint"	27
"Operating mode"	•	•	"Operating mode"	27
"Set user-defined speed"	•	•	"Set user-defined speed"	28
"Control mode"	•	•	"Control mode"	28
"Proportional-pressure setup"	•		"Proportional-pressure setup"	34
"Flow limit"	•		"FLOW _{LIMIT} "	35
"Automatic night setback"	•		"Automatic night setback"	35
"Temperature influence"	•		"Temperature influence"	45
"Buttons on product"	•	•	"Buttons on product" ("Enable/disable settings")	50
"Controller"	•	•	"Controller" ("Controller settings")	41
"Operating range"	•	•	"Operating range"	42
"Ramps"	•		"Ramps"	47
"Number"	•		"Number" ("Pump number")	49
"Radio communication"	•		"Radio communication" ("Enable/disable radio comm.")	49
"Analog input 1"	•			
"Analog input 2"	•		"Analog inputs"	35
"Analog input 3"	•			
"Built-in Grundfos sensor"	•		"Built-in Grundfos sensor"	37
"Pt100/1000 input 1"	•			
"Pt100/1000 input 2"	•		"Pt100/1000 inputs"	38
"Digital input 1"	•			
"Digital input 2"	•		"Digital inputs"	38
"Digital in/output 3"	•			
"Digital in/output 4"	•		"Digital inputs/outputs"	39
"Pulse flowmeter"	•		"Pulse flowmeter setup"	47
"Predefined setpoint"	•	•	"Predefined setpoints"	45
"Analog output"	•		"Analog output"	40
"External setpoint funct."	•		"External setpoint influence"	43
"Signal relay 1"	•			
"Signal relay 2"	•		"Signal relays 1 and 2" ("Relay outputs")	39
"Limit 1 exceeded"	•	•		
"Limit 2 exceeded"	•	•	"Limit-exceeded function"	46
"Alternating operation, time"		•		
"Time for pump change over"		•		
"Standstill heating"	•		"Standstill heating"	48
"Motor bearing monitoring"	•		"Motor bearing monitoring"	48
"Service"	•		"Service"	48
"Date and time"	•	•	"Date and time"	49
"Store settings"	•		"Store settings" ("Store actual settings")	50
"Recall settings"	•		"Recall settings" ("Recall stored settings")	50
"Undo"	•	•	"Undo"	50
"Pump name"	•	•	"Pump name"	51
"Connection code"	•	•	"Connection code"	51
"Unit configuration"	•	•	"Unit configuration" ("Units")	49
Alarms and warnings	TPE3, TPE3 D	Multipump system	Section	Page
"Alarm log"	•	•	"Alarm log"	52
"Warning log"	•	•	"Warning log"	52
"Reset alarm" button	•	•		
Assist	TPE3, TPE3 D	Multipump system	Section	Page
"Assisted pump setup"	•		"Assisted pump setup"	52
"Assisted fault advice"	•	•	"Setup, analog input"	53
"Multipump setup"	•	•	"Multipump setup" ("Setup of multi-pump system")	53

Description of selected functions

"Heat energy monitor"

Pump variant	"Heat energy monitor"
TPE3, TPE3 D	•

The heat energy monitor is a monitoring function that calculates the heat energy consumption within a system. The built-in flow estimation needed for the calculation has an inaccuracy of $\pm 10\%$ of the maximum flow rate in the area down to 10% flow and down to 12.5% of the maximum head. The calculations are based on water at a temperature of 68 °F (20 °C). Also, the temperature measurements needed for the calculation have some inaccuracy depending on the sensor type. Therefore, you cannot use the heat energy value for billing purposes. However, the value is perfect for optimization purposes in order to prevent excessive energy costs caused by system imbalances.

The heat energy monitor requires an additional temperature sensor installed in the flow pipe or return pipe depending on where the pump is installed.

Use the analog inputs and/or Pt100/1000 inputs for measuring the temperatures used for calculation by the heat energy monitor.

The used inputs must not be set to "Not active" and one of the measuring parameters must be set to "Temperature 2".

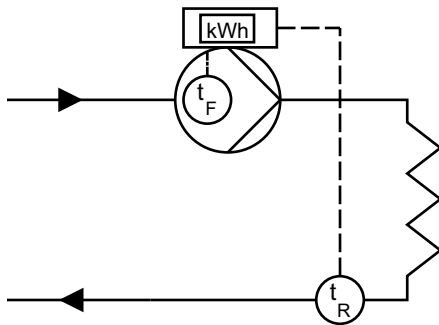

t_F : Flow-pipe temperature
 t_R : Return-pipe temperature

Fig. 12 Example: Pump installed in the flow pipe, and additional temperature sensor installed in the return pipe

TM06 1182 1814

"Setpoint"

Pump variant	"Setpoint"
TPE3, TPE3 D	•

You can set the setpoint for all control modes, except $AUTO_{ADAPT}$ and $FLOW_{ADAPT}$, in this submenu when you have selected the desired control mode. See "[Control mode](#)" on page 28.

Factory setting

See 8. [Factory settings of E-pumps](#) on page 61.

"Operating mode"

Pump variant	"Operating mode"
TPE3, TPE3 D	•

Possible operating modes:

- "Normal"
The pump runs according to the selected control mode.
- "Stop"
The pump stops.
- "Min."
Use the minimum-curve mode in periods where a minimum flow is required. This operating mode is, for instance, suitable for manual night setback if you do not want to use automatic night setback.
- "Max."
Use the maximum-curve mode in periods where a maximum flow is required. This operating mode is, for instance, suitable for hot-water priority.
- "Manual"
The pump is operating at a manually set speed. In "Manual" the setpoint via bus is overruled. See "[Set manual speed](#)" on page 28.
- "User-defined speed"
The motor is operating at a speed set by the user. See "[Set user-defined speed](#)" on page 28.

All operating modes are illustrated in the fig. 13.

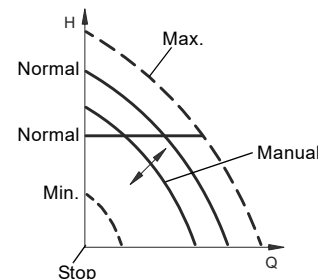

Fig. 13 Operating modes

Factory setting

See 8. [Factory settings of E-pumps](#) on page 61.

TM06 4024 1515

"Set manual speed"

Pump variant	"Set manual speed"
TPE3, TPE3 D	•

This menu is only available in the advanced control panel. With Grundfos GO, you set the speed via the "Setpoint" menu.

You can set the pump speed in % of the maximum speed. When you have set the operating mode to "Manual", the pump starts running at the set speed. The speed can then be changed manually via Grundfos GO or via the advanced control panel.

"Set user-defined speed"

You can set the motor speed in % of the maximum speed. When you have set the operating mode to "User-defined speed", the motor runs at the set speed.

"Control mode"

Pump variant	"Control mode"
TPE3, TPE3 D	•

Note: Not all control modes are available for all pump variants.

Possible control modes:

- "AUTO_{ADAPT}"
- "FLOW_{ADAPT}"
- "Prop. press." (proportional pressure)
- "Const. pressure" (constant pressure)
- "Const. temp." (constant temperature)
- "Con. diff. press." (constant differential pressure)
- "Con. diff. temp." (constant differential temperature)
- "Const. flow rate" (constant flow rate)
- "Const. level" (constant level)
- "Const. other val." (constant other value)
- "Const. curve" (constant curve).

You can change the setpoint for all control modes, except AUTO_{ADAPT} and FLOW_{ADAPT}, in the "Setpoint" submenu under "Settings" when you have selected the desired control mode.

Factory setting

See [8. Factory settings of E-pumps](#) on page 61.

"AUTO_{ADAPT}"

Pump variant	"AUTO _{ADAPT} "
TPE3, TPE3 D	•

The AUTO_{ADAPT} control mode continuously adapts the pump performance according to the actual system characteristic.

Manual setting of the setpoint is not possible.

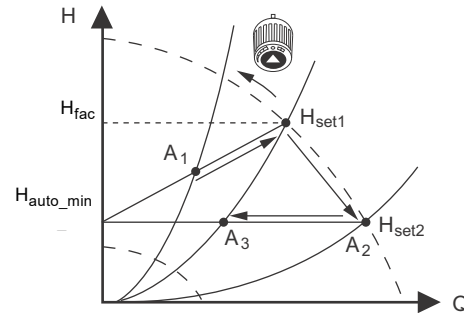

Fig. 14 AUTO_{ADAPT}

When the AUTO_{ADAPT} control mode has been enabled, the pump will start with the factory setting, H_{fac} is equal to H_{set1} , and then adjust its performance to A_1 . See fig. 14.

When the pump registers a lower head on the maximum curve, A_2 , the AUTO_{ADAPT} function automatically selects a correspondingly lower control curve, H_{set2} . If the valves in the system close, the pump adjusts its performance to A_3 .

- A_1 : Original duty point.
- A_2 : Lower registered head on the maximum curve.
- A_3 : New duty point after AUTO_{ADAPT} control.
- H_{set1} : Original setpoint setting.
- H_{set2} : New setpoint after AUTO_{ADAPT} control.
- H_{fac} : Factory setting.
- H_{auto_min} : A fixed value of 1.5 m.

The AUTO_{ADAPT} control mode is a form of proportional-pressure control where the control curves have a fixed origin, H_{auto_min} .

The AUTO_{ADAPT} control mode has been developed specifically for heating systems, and we do not recommend that you use it for air-conditioning and cooling systems.

"FLOW_{ADAPT}"

Pump variant	"FLOW _{ADAPT} "
TPE3, TPE3 D	•

When you select FLOW_{ADAPT}, the pump runs AUTO_{ADAPT} and ensures that the flow rate never exceeds the entered FLOW_{LIMIT} value.

The setting range for FLOW_{LIMIT} is 25 to 90 % of the maximum flow rate of the pump.

The factory setting of the FLOW_{LIMIT} is the flow rate where the AUTO_{ADAPT} factory setting meets the maximum curve. See fig. 15.

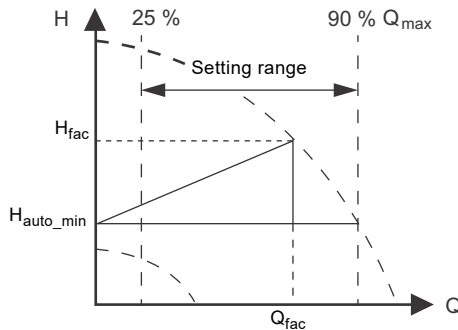

Fig. 15 FLOW_{ADAPT}

TM05 7912 1613

"Proportional pressure"

Pump variant	"Proportional pressure"
TPE3, TPE3 D	•

The head of the pump is reduced at decreasing water demand and increased at rising water demand. See fig. 16.

This control mode is especially suitable in systems with relatively large pressure losses in the distribution pipes. The head of the pump increases proportionally to the flow in the system to compensate for the large pressure losses in the distribution pipes.

You can set the setpoint with an accuracy of 0.1 m. The head against a closed valve is half the setpoint.

For more information about settings, see ["Proportional-pressure setup"](#) on page 34.

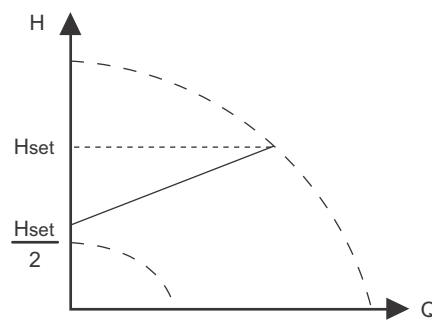

Fig. 16 "Proportional pressure"

TM05 7909 1613

Example

- Factory-fitted differential-pressure sensor.

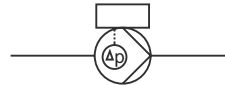

Fig. 17 "Proportional pressure"

Controller settings

For recommended controller settings, see ["Controller"](#) (["Controller settings"](#)) on page 41.

"Constant pressure"

Pump variant	"Constant pressure"
TPE3, TPE3 D	•

We recommend this control mode if the pump is to deliver a constant pressure, independently of the flow in the system. The pump maintains a constant pressure independently of the flow rate. See fig. 18.

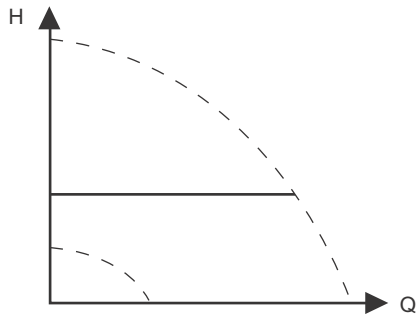

TM05 7901 1613

Fig. 18 "Constant pressure"

This control mode requires an external pressure sensor as shown in the examples below. You can set the pressure sensor in the "Assist" menu. See ["Assisted pump setup"](#) on page 52.

Examples

- One external pressure sensor.

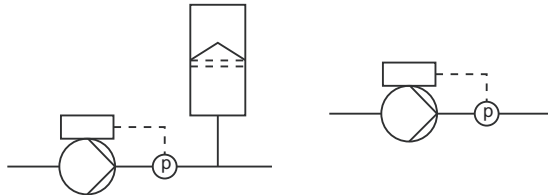

Fig. 19 "Constant pressure"

Controller settings

For recommended controller settings, see ["Controller"](#) (["Controller settings"](#)) on page 41.

"Constant temperature"

Pump variant	"Constant temperature"
TPE3, TPE3 D	•

This control mode ensures a constant temperature. Constant temperature is a comfort control mode that you can use in domestic hot-water systems to control the flow rate to maintain a fixed temperature in the system. See fig. 20.

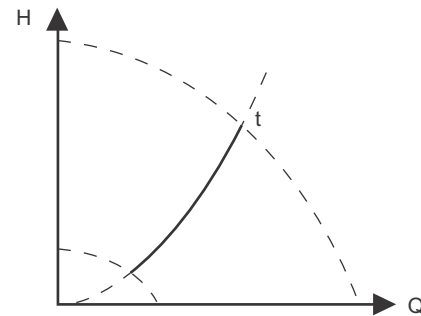

TM05 7900 1613

Fig. 20 "Constant temperature"

This control mode requires either an internal or external temperature sensor as shown in the examples below.

Examples

- Factory-fitted temperature sensor. Only TPE3, TPE3 D.

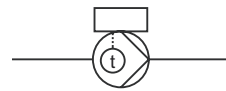

- One external temperature sensor.

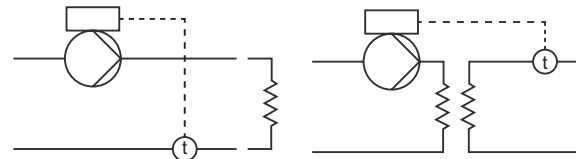

Fig. 21 "Constant temperature"

Controller settings

For recommended controller settings, see ["Controller"](#) (["Controller settings"](#)) on page 41.

"Constant differential pressure"

Pump variant	"Constant differential pressure"
TPE3, TPE3 D	•

The pump maintains a constant differential pressure, independently of the flow rate in the system. See fig. 22. This control mode is primarily suitable for systems with relatively small pressure losses.

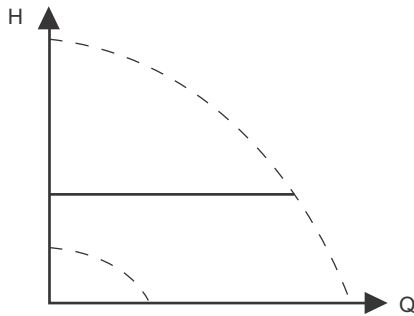

TM05 7901 1613

Fig. 22 "Constant differential pressure"

This control mode requires either an internal or external differential-pressure sensor or two external pressure sensors. See the examples below.

Examples

- Factory-fitted differential-pressure sensor, only TPE3, TPE3 D.

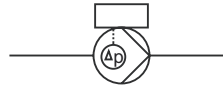

- One external differential-pressure sensor. The pump uses the input from the sensor to control the differential pressure. You can set the sensor manually or by using the "Assist" menu. See ["Assisted pump setup"](#) on page 52.

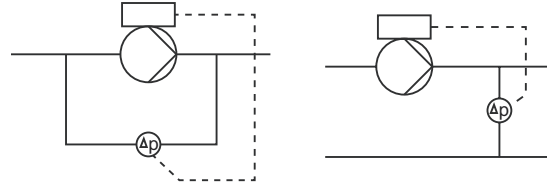

- Two external pressure sensors. Constant differential-pressure control is achievable with two pressure sensors. The pump uses the inputs from the two sensors and calculates the differential pressure. The sensors must have the same unit and must be set as feedback sensors. You can set the sensors manually, sensor by sensor, or by using the "Assist" menu. See ["Assisted pump setup"](#) on page 52.

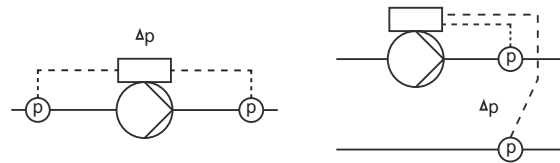

Fig. 23 "Constant differential pressure"

Controller settings

For recommended controller settings, see ["Controller"](#) (["Controller settings"](#)) on page 41.

"Constant differential temperature"

Pump variant	"Constant differential temperature"
TPE3, TPE3 D	•

The pump maintains a constant differential temperature in the system, and the pump performance is controlled according to this. See fig. 24.

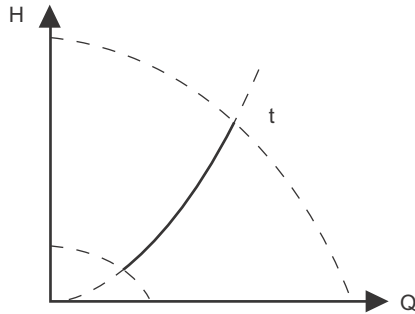

TM05 7954 1713

Fig. 24 "Constant differential temperature"

This control mode requires either two temperature sensors or one external differential-temperature sensor. See the examples below.

The temperature sensors can either be analog sensors connected to two of the analog inputs or two Pt100/Pt1000 sensors connected to the Pt100/1000 inputs, if these are available on the specific pump.

Set the sensor in the "Assist" menu under "Assisted pump setup". See "[Assisted pump setup](#)" on page 52.

Examples

- Factory-fitted temperature sensor and an external temperature sensor. Only TPE3, TPE3 D.

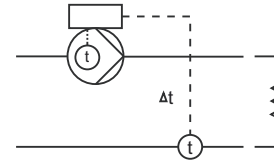

- Two external temperature sensors. Not available for TPE 15-22 kW 2-pole and 11 - 18.5 kW 4-pole. Constant differential-temperature control is achievable with two temperature sensors. The pump uses the inputs from the two sensors and calculates the differential temperature. The sensors must have the same unit and must be set as feedback sensors. You can set the sensors manually, sensor by sensor, or by using the "Assist" menu. See "[Assisted pump setup](#)" on page 52.

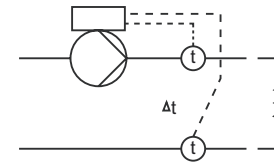

- One external differential-temperature sensor. The pump uses the input from the sensor to control the differential temperature. You can set the sensor manually or by using the "Assist" menu. See "[Assisted pump setup](#)" on page 52.

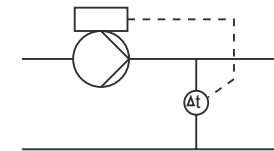

Fig. 25 Constant differential temperature

Controller settings

For recommended controller settings, see "[Controller](#)" ("[Controller settings](#)") on page 41.

"Constant flow rate"

Pump variant	"Constant flow rate"
TPE3, TPE3 D	•

The pump maintains a constant flow rate in the system, independently of the head. See fig. 26.

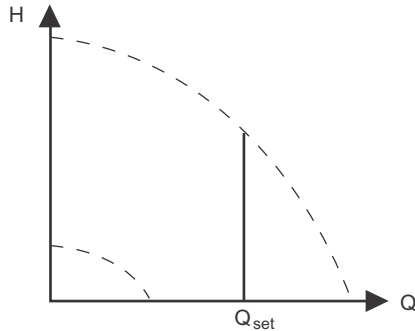

TM05 7965 1713

Fig. 26 Constant flow rate

This control mode requires an external flow sensor. See the example below.

Example

- One external flow sensor.

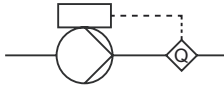

Fig. 27 Constant flow rate

Controller settings

For recommended controller settings, see "[Controller](#)" ("[Controller settings](#)") on page 41.

"Constant level"

Pump variant	"Constant level"
TPE3, TPE3 D	•

The pump maintains a constant level, independently of the flow rate. See fig. 28.

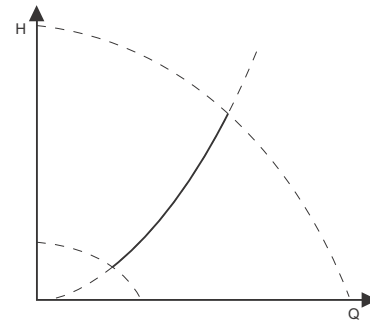

TM05 7941 1613

Fig. 28 "Constant level"

This control mode requires an external level sensor. The pump can control the level in a tank in two ways:

- As an emptying function where the pump draws the liquid from the tank.
- As a filling function where the pump pumps the liquid into the tank.

See fig. 29.

The type of level control function depends on the setting of the built-in controller. See "[Controller](#)" ("[Controller settings](#)") on page 41.

Examples

- One external level sensor.
 - emptying function.

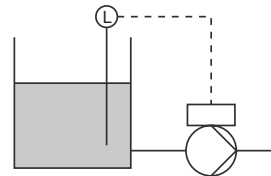

- One external level sensor.
 - filling function.

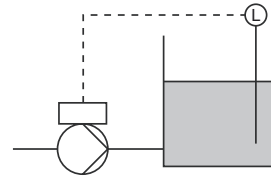

Fig. 29 Constant level

Controller settings

For recommended controller settings, see "[Controller](#)" ("[Controller settings](#)") on page 41.

"Constant other value"

Pump variant	"Constant other value"
TPE3, TPE3 D	•

Any other value is kept constant.

Use this control mode if you want to control a value which is not available in the "Control mode" menu. Connect a sensor measuring the controlled value to one of the analog inputs of the pump. The controlled value will be shown in percentage of sensor range.

Constant curve

Pump variant	"Constant curve"
TPE3, TPE3 D	•

You can set the pump to operate according to a constant curve, like an uncontrolled pump. See fig. 30. You can set the desired speed in % of maximum speed in the range from 13 to 100 %.

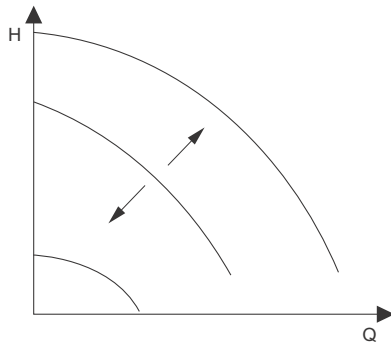

Fig. 30 Constant curve

TM05 7957 1713

Depending on the system characteristic and the duty point, the 100 % setting may be slightly smaller than the actual maximum curve of the pump even though the display shows 100 %. This is due to the power and pressure limitations built into the pump. The deviation varies according to pump type and pressure loss in the pipes.

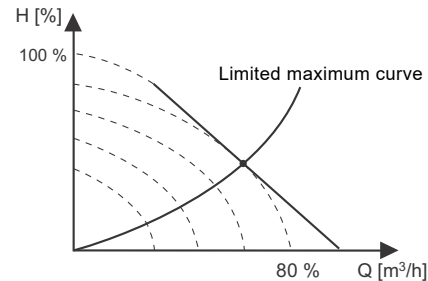

Fig. 31 Power and pressure limitations influencing the maximum curve

TM05 7913 1613

Controller settings

For recommended controller settings, see ["Controller"](#) (["Controller settings"](#)) on page 41.

"Proportional-pressure setup"

Pump variant	"Proportional-pressure setup"
TPE3, TPE3 D	•

"Control-curve function"

You can set the curve either to quadratic or linear.

"Zero-flow head"

You can set this value in % of the setpoint. With a setting of 100 %, the control mode is equal to constant differential pressure.

"FLOW_{LIMIT}"

Pump variant	"FLOW _{LIMIT} "
TPE3, TPE3 D	•

FLOW_{LIMIT}

- Enable the FLOW_{LIMIT} function.
- Set the FLOW_{LIMIT}.

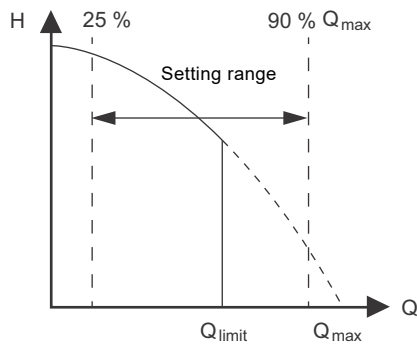

TM05 7908 1613

Fig. 32 "FLOW_{LIMIT}"

You can combine the FLOW_{LIMIT} function with the following control modes:

- Proportional pressure
- Constant differential pressure
- Constant differential temperature
- Constant temperature
- Constant curve.

A flow-limiting function ensures that the flow rate never exceeds the entered FLOW_{LIMIT} value.

The setting range for FLOW_{LIMIT} is 25 % to 90 % of the Q_{max} of the pump.

The factory setting of the FLOW_{LIMIT} is the flow rate where the AUTO_{ADAPT} factory setting meets the maximum curve. See fig. 15.

"Automatic night setback"

Pump variant	"Automatic night setback"
TPE3, TPE3 D	•

Once you have enabled automatic night setback, the pump automatically changes between normal duty and night setback, duty at low performance.

Changeover between normal duty and night setback depends on the flow-pipe temperature.

The pump automatically changes over to night setback when the built-in sensor registers a flow-pipe temperature drop of more than 10 to 15 °C within approximately two hours. The temperature drop must be at least 0.1 °C/min.

Changeover to normal duty takes place without a time lag when the temperature has increased by approximately 10 °C.

Note: You cannot enable automatic night setback when the pump is in constant-curve mode.

"Analog inputs"

Pump variant	"Analog inputs"
TPE3, TPE3 D	•

Function	Terminals*
"Analog input 1, setup"	4
"Analog input 2, setup"	7
"Analog input 3, setup"	14

* See [Connection terminals, advanced functional module, FM 300](#) on page 71.

Set the analog input for a feedback sensor via the "Assisted pump setup" menu. See ["Assisted pump setup"](#) on page 52.

If you want to set an analog input for other purposes, you can do this manually.

You can set the analog inputs via the "Setup, analog input" menu. See ["Setup, analog input"](#) on page 53.

If you perform the manual setting via Grundfos GO, you need to enter the menu for the analog input under the "Settings" menu.

Function

You can set the analog inputs to these functions:

- "Not active"
- "Feedback sensor"
- "Ext. setpoint infl."
 - See ["External setpoint influence"](#) on page 43.
- "Other function".

Measured parameter

Select one of the parameters: the parameter to be measured in the system by the sensor connected to the actual analog input. See fig. 33.

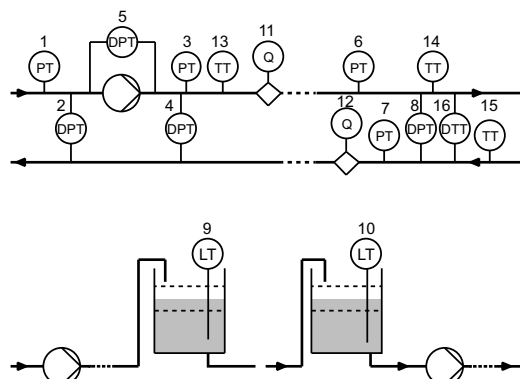

Fig. 33 Overview of sensor locations

Sensor function, measured parameter	Pos.
"Inlet pressure"	1
"Diff. press., inlet"	2
"Liquid temp."	3
"Diff. press.,outlet"	4
"Diff. press.,pump"	5
"Operating mode"	6
"Press. 2, external"	7
"Diff. press., ext."	8
"Storage tank level"	9
"Feed tank level"	10
"Pump flow"	11
"Flow, external"	12
"Liquid temp."	13
"Temperature 1"	14
"Temperature 2"	15
"Diff. temp., ext."	16
"Ambient temp."	Not shown
"Other parameter"	Not shown

"Unit"

Available measuring units:

Parameter	Possible measuring units
Pressure	bar, m, kPa, psi, ft
Level	m, ft, in
"Flow rate"	m ³ /h, l/s, yd ³ /h, gpm
"Liquid temp."	°C, °F
"Other parameter"	%

Electrical signal

Select signal type:

- "0.5 - 3.5 V"
- "0-5 V"
- "0-10 V"
- "0-20 mA"
- "4-20 mA".

Sensor range, minimum value

Set the minimum value of the connected sensor.

Sensor range, maximum value

Set the maximum value of the connected sensor.

Factory setting

See 8. *Factory settings of E-pumps* on page 61.

Setting two sensors for differential measurement

In order to measure the difference of a parameter between two points, set the corresponding sensors as follows:

Parameter	Analog input for sensor 1	Analog input for sensor 2
Pressure, option 1	Differential pressure, inlet	Differential pressure, outlet
Pressure, option 2	Pressure 1, external	Pressure 2, external
Flow	Pump flow	Flow, external
Temperature	Temperature 1	Temperature 2

If you want to use the control mode "constant differential pressure", you must choose the function "Feedback sensor" for the analog input of both sensors.

"Built-in Grundfos sensor"

Pump variant	"Built-in Grundfos sensor"
TPE3, TPE3 D	•

You can select the function of the built-in sensor in the "Built-in Grundfos sensor" menu.

Set the "Built-in Grundfos sensor" via the "Assisted pump setup" menu. See ["Assisted pump setup"](#) on page 52.

If you perform the setting manually in the advanced control panel, you must enter the "Analog inputs" menu under the "Settings" menu in order to access the "Built-in Grundfos sensor" menu.

If you perform the setting manually via Grundfos GO, you need to enter the menu for the "Built-in Grundfos sensor" under the "Settings" menu.

Function

You can set the built-in sensor to these functions:

- "Grundfos diff.-pressure sensor"
 - "Not active"
 - "Feedback sensor"
 - "Setpoint influence"
 - "Other function".
- "Grundfos temperature sensor"
 - "Not active"
 - "Feedback sensor"
 - "Setpoint influence"
 - "Other function".

Factory setting

See [8. Factory settings of E-pumps](#) on page 61.

"Pt100/1000 inputs"

Pump variant	"Pt100/1000 inputs"
TPE3, TPE3 D	•

Function	Terminals*
"Pt100/1000 input 1, setup"	17 and 18
"Pt100/1000 input 2, setup"	18 and 19

* See [Connection terminals, advanced functional module, FM 300](#) on page 71.

Set the Pt100/1000 input for a feedback sensor via the "Assisted pump setup" menu. See ["Assisted pump setup"](#) on page 52.

If you want to set a Pt100/1000 input for other purposes, you can do this manually.

You can set the analog inputs via the "Setup, analog input" menu. See ["Setup, analog input"](#) on page 53.

If you perform the manual setting via Grundfos GO, you need to enter the menu for the Pt100/1000 input under the "Settings" menu.

Function

You can set the Pt100/1000 inputs to these functions:

- "Not active"
- "Feedback sensor"
- "Ext. setpoint infl."
 - See ["External setpoint influence"](#) on page 43.
- "Other function".

Measured parameter

Select one of the parameters, such as the parameter to be measured in the system by the Pt100/1000 sensor connected to the actual Pt100/1000 input. See [fig. 34](#).

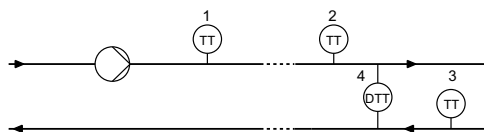

Fig. 34 Overview of Pt100/1000 sensor locations

Parameter	Pos.
"Liquid temp."	1
"Temperature 1"	2
"Temperature 2"	3
"Ambient temp."	Not shown

Measuring range

-50 to +204 °C.

Factory setting

See [8. Factory settings of E-pumps](#) on page 61.

"Digital inputs"

Pump variant	"Digital inputs"
TPE3, TPE3 D	•

Function	Terminals*
"Digital input 1, setup"	2 and 6
"Digital input 2, setup"	1 and 9

* See [Connection terminals, advanced functional module, FM 300](#) on page 71.

To set a digital input, make the settings below.

Function

Select one of these functions:

- "Not active"
 - When set to "Not active", the input has no function.
- "External stop"
 - When the input is deactivated, open circuit, the pump stops.
- "Min.", minimum speed
 - When the input is activated, the pump runs at the set minimum speed.
- "Max.", maximum speed
 - When the input is activated, the pump runs at the set maximum speed.
- "User-defined speed"
 - When the input is activated, the motor runs at a speed set by the user.
- "External fault"
 - When the input is activated, a timer starts. If the input is activated for more than 5 seconds, the pump stops and a fault is indicated. This function depends on input from external equipment.
- "Alarm resetting"
 - When the input is activated, a possible fault indication is reset.
- "Dry running"
 - When this function has been selected, lack of inlet pressure or water shortage can be detected. When lack of inlet pressure or water shortage, dry running, is detected, the pump stops. The pump cannot restart as long as the input is activated. This requires the use of an accessory, such as these:
 - a pressure switch installed on the inlet side of the pump
 - a float switch installed on the inlet side of the pump.

- "Accumulated flow"
When this function has been selected, the accumulated flow rate can be registered. This requires the use of a flowmeter which can give a feedback signal as a pulse per defined flow of water.
See ["Pulse flowmeter setup"](#) on page 47.
- "Predefined setpoint digit 1", applies only to digital input 2
When digital inputs are set to a predefined setpoint, the pump operates according to a setpoint based on the combination of the activated digital inputs.
See ["Predefined setpoints"](#) on page 45.

The priority of the selected functions in relation to each other appears from section [Priority of settings](#) on page 57.

A stop command always has the highest priority.

"Digital inputs/outputs"

Pump variant	"Digital inputs/outputs"
TPE3, TPE3 D	•

Function	Terminals*
"Digital input/output 3, setup"	10 and 16
"Digital input/output 4, setup"	11 and 18

* See [Connection terminals, advanced functional module, FM 300](#) on page 71.

You can select if the interface must be used as input or output. The output is an open collector, and you can connect it to, for example, an external relay or controller such as a PLC.

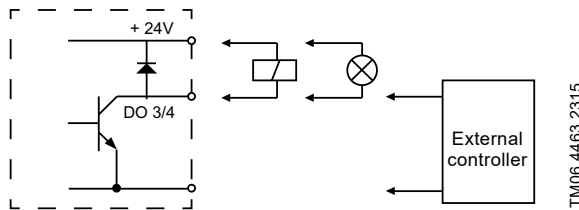

Fig. 35 Example of configurable digital inputs or outputs

TM06 4463 2315

To set a digital input or output, make the settings below.

Mode

You can set the digital input or output 3 and 4 to act as digital input or digital output:

- "Digital input"
- "Digital output".

Function

You can set the digital input or output 3 and 4 to the functions mentioned below.

Possible functions, digital input or output 3

"Function if input" See details in section "Digital inputs" on page 38	"Function if output" See details in section "Signal relays 1 and 2" ("Relay outputs") on page 39
<ul style="list-style-type: none"> • "Not active" • "External stop" • "Min." • "Max." • "User-defined speed" • "External fault" • "Alarm resetting" • "Dry running" • "Accumulated flow" • "Predefined setpoint 2" 	<ul style="list-style-type: none"> • "Not active" • "Ready" • "Alarm" • "Operation" • "Pump running" • "Warning" • "Limit 1 exceeded" • "Limit 2 exceeded"

Possible functions, digital input or output 4

"Function if input" See details in section "Digital inputs" on page 38	"Function if output" See details in section "Signal relays 1 and 2" ("Relay outputs") on page 39
<ul style="list-style-type: none"> • "Not active" • "External stop" • "Min." • "Max." • "User-defined speed" • "External fault" • "Alarm resetting" • "Dry running" • "Accumulated flow" • "Predefined setpoint 3" 	<ul style="list-style-type: none"> • "Not active" • "Ready" • "Alarm" • "Operation" • "Pump running" • "Warning" • "Limit 1 exceeded" • "Limit 2 exceeded"

"Signal relays 1 and 2" ("Relay outputs")

Pump variant	Relay outputs	
	Signal relay 1	Signal relay 2
TPE3, TPE3 D	•	•

Function	Terminals*
"Relay output 1"	NC, C1, NO
"Relay output 2"	NC, C2, NO

* See [Connection terminals, advanced functional module, FM 300](#) on page 71.

The pump incorporates two signal relays for potential-free signalling. For further information, see [Indicator lights and signal relays](#) on page 59.

Function

You can configure the signal relays to be activated by one of the following incidents:

- "Not active".
- "Ready"
The pump can be running or is ready to run and no alarms are present.
- "Alarm"
There is an active alarm and the pump is stopped.
- "Operating" ("Operation")
"Operating" equals "Running" but the pump is still in operation when it has been stopped due to a warning.
- "Running" ("Pump running")
- "Warning"
There is an active warning.
- "Limit 1 exceeded"
When the "Limit 1 exceeded" function is activated, the signal relay is activated. See ["Limit-exceeded function"](#) on page 46.
- "Limit 2 exceeded"
When the "Limit 2 exceeded" function is activated, the signal relay is activated. See ["Limit-exceeded function"](#) on page 46.
- "Relubricate"
- "External fan control" ("Control of external fan")
When you select "External fan control", the relay is activated if the internal temperature of the motor electronics reach a preset limit value.

Factory setting

See [8. Factory settings of E-pumps](#) on page 61.

"Analog output"

Pump variant	"Analog output"
TPE3, TPE3 D	•

Function	Terminals*
"Analog output"	12

* See [Connection terminals, advanced functional module, FM 300](#) on page 71.

The analog output enables the transfer of certain operating data to external control systems. To set the analog output, make the settings below.

"Output signal"

- "0-10 V"
- "0-20 mA"
- "4-20 mA".

"Function of analog output"

- "Actual speed"

Signal range [V, mA]	"Actual speed" [%]		
	0	100	200
"0-10 V"	0 V	5 V	10 V
"0-20 mA"	0 mA	10 mA	20 mA
"4-20 mA"	4 mA	12 mA	20 mA

The reading is a percentage of nominal speed.

- "Actual value"

Signal range [V, mA]	"Actual value"	
	Sensor _{min}	Sensor _{max}
"0-10 V"	0 V	10 V
"0-20 mA"	0 mA	20 mA
"4-20 mA"	4 mA	20 mA

The reading is a percentage of the range between sensor_{min} and sensor_{max}.

- "Resulting setpoint"

Signal range [V, mA]	"Resulting setpoint" [%]	
	0	100
"0-10 V"	0 V	10 V
"0-20 mA"	0 mA	20 mA
"4-20 mA"	4 mA	20 mA

The reading is a percentage of the external setpoint range.

- "Motor load"

Signal range [V, mA]	"Motor load" [%]	
	0	100
"0-10 V"	0 V	10 V
"0-20 mA"	0 mA	20 mA
"4-20 mA"	4 mA	20 mA

The reading is a percentage of the range between 0 and 200 % of the maximum permissible load at the actual speed.

- "Motor current"

Signal range [V, mA]	"Motor current" [%]		
	0	100	200
0-10 V	0 V	5 V	10 V
0-20 mA	0 mA	10 mA	20 mA
4-20 mA	4 mA	12 mA	20 mA

The reading is a percentage of the range between 0 and 200 % of the rated current.

- "Limit 1 exceeded" and "Limit 2 exceeded"

Signal range [V, mA]	"Limit-exceed function"	
	Output not active	Output active
"0-10 V"	0 V	10 V
"0-20 mA"	0 mA	20 mA
"4-20 mA"	4 mA	20 mA

The "Limit-exceeded function" is typically used for monitoring of secondary parameters in the system. If the limit is exceeded, an output, warning or alarm is activated.

- "Flow rate"

Signal range [V, mA]	"Flow rate" [%]		
	0	100	200
"0-10 V"	0 V	5 V	10 V
"0-20 mA"	0 mA	10 mA	20 mA
"4-20 mA"	4 mA	12 mA	20 mA

The reading is a percentage of the range between 0 and 200 % of the nominal flow.

Factory setting

See [8. Factory settings of E-pumps](#) on page 61.

"Controller" ("Controller settings")

Pump variant	"Controller settings"
TPE3, TPE3 D	•

The pumps have a factory default setting of gain, K_p , and integral time, T_i .

However, if the factory setting is not the optimum setting, you can change the gain and the integral time:

- Set the gain within the range from 0.1 to 20.
- Set the integral time within the range from 0.1 to 3600 seconds.

If you select 3600 seconds, the controller functions as a P controller.

Furthermore, you can set the controller to inverse control. This means that if the setpoint is increased, the speed is reduced. In the case of inverse control, set the gain within the range from -0.1 to -20.

Guidelines for setting of PI controller

The tables below show the recommended controller settings:

"Differential-pressure control"	K_p	T_i
	0.5	0.5
	0.5	L1 < 5 m: 0.5 L1 > 5 m: 3 L1 > 10 m: 5

L1: Distance in meters between pump and sensor.

"Temperature control"	K_p		T_i
	Heating system ¹⁾	Cooling system ²⁾	
	0.5	-0.5	$10 + 5L2$
	0.5	-0.5	$30 + 5L2$

- 1) In heating systems, an increase in pump performance results in a rise in temperature at the sensor.
 2) In cooling systems, an increase in pump performance results in a drop in temperature at the sensor.

L2: Distance in meters between heat exchanger and sensor.

"Differential-temperature control"	K_p	T_i
	-0.5	$10 + 5L2$

L2: Distance in meters between heat exchanger and sensor.

"Flow control"	K_p	T_i
	0.5	0.5

"Constant-pressure control"	K_p	T_i
	0.5	0.5
	0.1	0.5

"Level control"	K_p	T_i
	-2.5	100
	2.5	100

Rules of thumb

If the controller is too slow-reacting, increase the gain.
 If the controller is hunting or unstable, dampen the system by reducing the gain or increasing the integral time.

Factory setting

See [8. Factory settings of E-pumps](#) on page 61.

"Operating range"

Pump variant	"Operating range"
TPE3, TPE3 D	•

Set the operating range as follows:

- Set the minimum speed within the range from fixed minimum speed to user-set maximum speed.
- Set the maximum speed within the range from user-set minimum speed to fixed maximum speed.

The range between the user-set minimum and maximum speeds is the operating range. See [fig. 36](#).

Note: Speeds below 25 % may result in noise from the shaft seal.

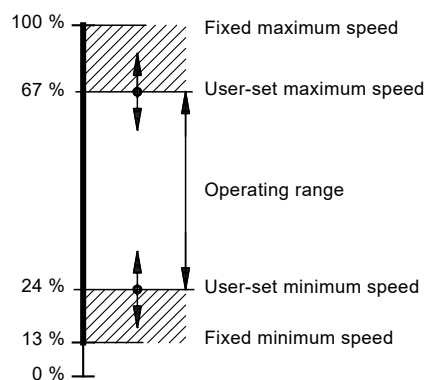

Fig. 36 Example of minimum and maximum settings

Factory setting

See [8. Factory settings of E-pumps](#) on page 61.

TM00 6785 5095

"External setpoint influence"

Pump variant	"External setpoint influence"
TPE3, TPE3 D	•

You can influence the setpoint by an external signal, either via one of the analog inputs or, if an advanced functional module is fitted, via one of the Pt100/1000 inputs.

Note: Before you can enable the "External setpoint function", set one of the analog inputs or Pt100/1000 inputs to "Setpoint influence".

See ["Analog inputs"](#) on page 35 and ["Pt100/1000 inputs"](#) on page 38.

If more than one input has been set to "Setpoint influence", the function selects the analog input with the lowest number, for example, "Analog input 2", and ignores the other inputs, for example, "Analog input 3" or "Pt100/1000 input 1".

Example with constant pressure with linear influence

Actual setpoint: actual input signal x (setpoint - sensor min.) + sensor min.

At a lower sensor value of 0 bar, a setpoint of 2 bar and an external setpoint of 60 %, the actual setpoint is $0.60 \times (2 - 0) + 0 = 1.2$ bar.

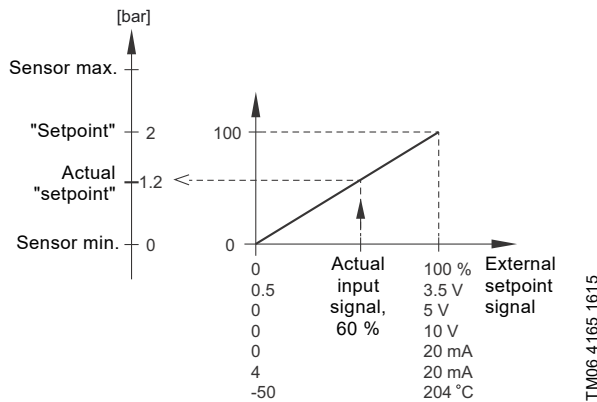

Fig. 37 Example of setpoint influence with sensor feedback

Example with constant curve with linear influence

Actual setpoint: actual input signal x (setpoint - user-set minimum speed) + user-set minimum speed.

At a user-set minimum speed of 25 %, a setpoint of 85 % and an external setpoint of 60 %, the actual setpoint is $0.60 \times (85 - 25) + 25 = 61$ %. See fig. 38.

In some cases, the maximum curve is limited to a lower speed. See fig. 38.

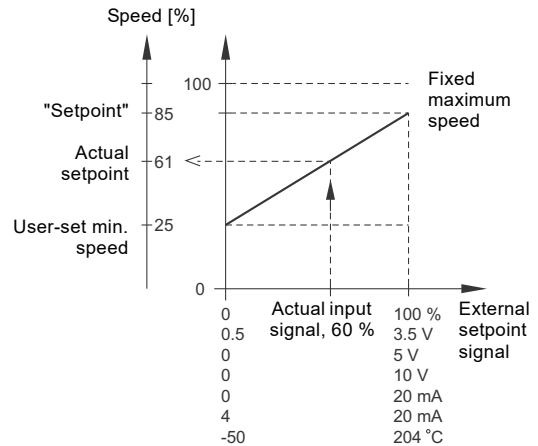

Fig. 38 Example of setpoint influence with constant curve

Factory setting

See [8. Factory settings of E-pumps](#) on page 61.

"Setpoint influence"

Pump variant	"Setpoint influence"
TPE3, TPE3 D	•

The table below gives an overview of the types of setpoint influence and the availability depending on pump type.

Type of setpoint influence	Pump type
	TPE3
"Not active"	•
"Linear function"	•
"Linear with Stop"	•
"Influence table"	•

You can select these functions:

- "Not active"
When set to "Not active", the setpoint is not influenced from any external function.
- "Linear function"
The setpoint is influenced linearly from 0 to 100 %.
See fig. 39.

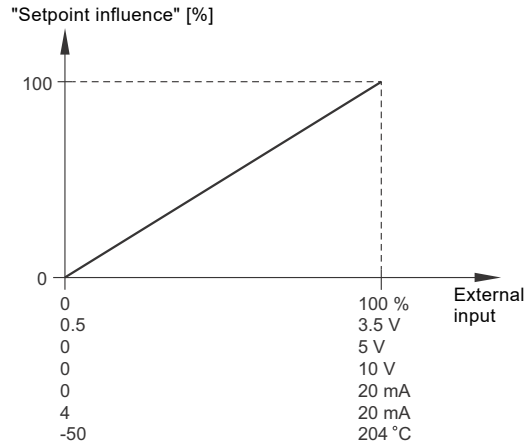

TM06 4166 1615

Fig. 39 "Linear function"

- "Linear with Stop"
In the input signal range from 20 to 100 %, the setpoint is influenced linearly.
If the input signal is below 10 %, the pump changes to operating mode "Stop".
If the input signal is increased above 15 %, the operating mode is changed back to "Normal". See fig. 40.

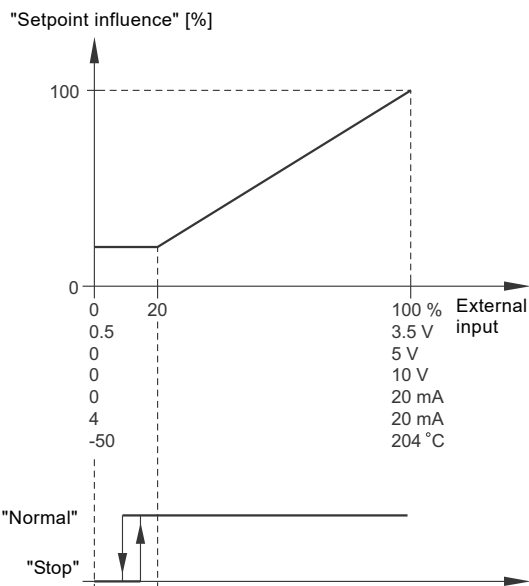

TM06 4167 1615

Fig. 40 "Linear with Stop"

- "Influence table"
The setpoint is influenced by a curve made out of two to eight points. There will be a straight line between the points and a horizontal line before the first point and after the last point.

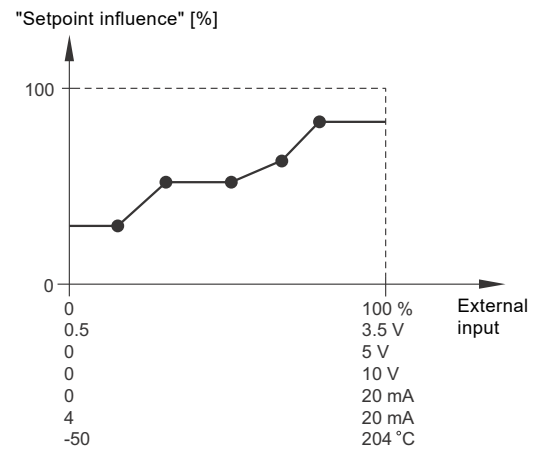

TM06 4170 1615

Fig. 41 "Influence table", example with five points

"Predefined setpoints"

Pump variant	"Predefined setpoints"
TPE3, TPE3 D	•

You can set and activate seven predefined setpoints by combining the input signals to digital inputs 2, 3 and 4 as shown in the table below.

Set the digital inputs 2, 3 and 4 to "Predefined setpoints" if all seven predefined setpoints are to be used. You can also set one or two of the digital inputs to "Predefined setpoints", but this will limit the number of predefined setpoints available.

"Digital inputs"			"Setpoint"
2	3	4	
0	0	0	Normal setpoint or stop
1	0	0	Predefined setpoint 1
0	1	0	Predefined setpoint 2
1	1	0	Predefined setpoint 3
0	0	1	Predefined setpoint 4
1	0	1	Predefined setpoint 5
0	1	1	Predefined setpoint 6
1	1	1	Predefined setpoint 7

0: Open contact
1: Closed contact

Example

Figure 42 shows how you can use the digital inputs to set seven predefined setpoints. Digital input 2 is open and digital inputs 3 and 4 are closed. If you compare with the table above, you can see that "Predefined setpoint 6" is activated.

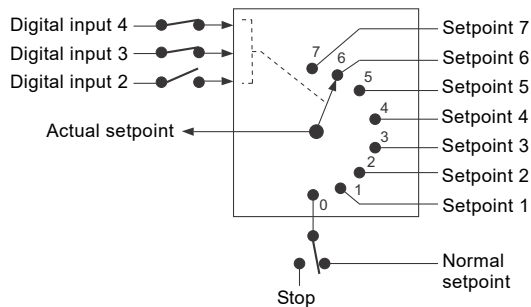

Fig. 42 Principle sketch showing how predefined setpoints function

If all digital inputs are open, the pump either stops or runs at the normal setpoint. Set the desired action with Grundfos GO or with the advanced control panel.

Factory setting

See 8. *Factory settings of E-pumps* on page 61.

"Temperature influence"

Pump variant	"Temperature influence"
TPE3, TPE3 D	•

When this function is enabled in proportional- or constant-pressure control mode, the setpoint for head is reduced according to the liquid temperature.

You can set the temperature influence to function at liquid temperatures below 176 or 122 °F (80 or 50 °C). These temperature limits are called T_{max} . The setpoint is reduced in relation to the head set which is equal to 100 % according to the characteristics below.

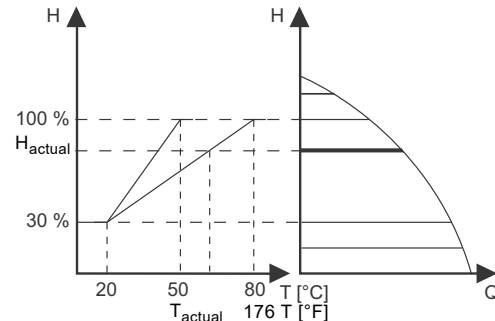

Fig. 43 "Temperature influence"

In the above example, T_{max} , which is equal to 122 °F (80 °C), has been selected. The actual liquid temperature, T_{actual} , causes the setpoint for head to be reduced from 100 % to H_{actual} .

The temperature influence function requires the following:

- proportional-pressure or constant-pressure control mode
- pump installed in flow pipe
- system with flow-pipe temperature control.

Temperature influence is suitable for the following systems:

- Systems with variable flows, for example two-pipe heating systems, in which the enabling of the temperature influence function ensures a further reduction of the pump performance in periods with small heating demands and consequently a reduced flow-pipe temperature.
- Systems with almost constant flows, for example one-pipe heating systems and underfloor heating systems, in which variable heating demands cannot be registered as changes in the head as it is the case with two-pipe heating systems. In such systems, you can only adjust the pump performance by enabling the temperature influence function.

Selection of the maximum temperature

In systems with a dimensioned flow-pipe temperature of:

- up to and including 131 °F (55 °C), select T_{max} equal to 122 °F (50 °C).
- above 131 °F (55 °C), select T_{max} equal to 176 °F (80 °C).

Note: You cannot use the temperature function in air-conditioning and cooling systems.

Factory setting

See [8. Factory settings of E-pumps](#) on page 61.

"Limit-exceeded function"

Pump variant	"Limit-exceeded function"
TPE3, TPE3 D	•

This function can monitor a measured parameter or one of the internal values such as speed, motor load or motor current. If a set limit is reached, a selected action can take place. You can set two limit-exceeded functions meaning that you can monitor two parameters or two limits of the same parameter simultaneously.

The function requires setting of the following:

Measured

Here you set the measured parameter to be monitored.

"Limit"

Here you set the limit which activates the function.

"Hysteresis band"

Here you set the hysteresis band.

"Limit exceeded when"

Here you can set if you want the function to be activated when the selected parameter exceeds or drops below the set limit.

- "Above limit"
The function is activated if the measured parameter exceeds the set limit.
- "Below limit"
The function is activated if the measured parameter drops below the set limit.

Action

If the value exceeds a limit, you can define an action. You can select the following actions:

- "No action"
The pump remains in its current state. Use this setting if you only want to have a relay output when the limit is reached. See ["Signal relays 1 and 2" \("Relay outputs"\)](#) on page 39.
- "Warning/alarm"
There is a warning.
- "Stop"
The pump stops.
- "Min."
The pump reduces speed to minimum.
- "Max."
The pump increases speed to maximum.
- "User-defined speed"
The pump runs at a speed set by the user.

"Detection delay"

You can set a detection delay which ensures that the monitored parameter stays above or below a set limit in a set time before the function is activated.

"Resetting delay"

The resetting delay is the time from which the measured parameter differs from the set limit including the set hysteresis band and until the function is reset.

Example

The function is to monitor the outlet pressure of a pump. If the pressure is below 5 bar for more than 5 seconds, a warning must be given. If the outlet pressure is above 7 bar for more than 8 seconds, you must reset the warning.

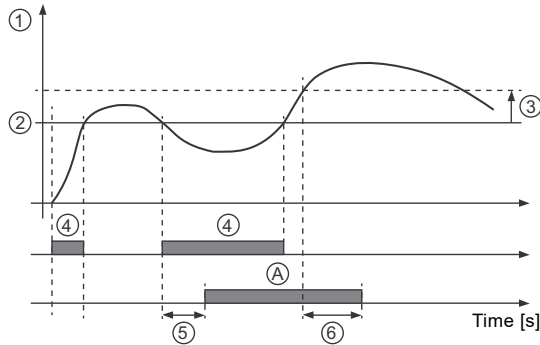

TM06 4603 2515

Fig. 44 Limit exceeded (example)

Pos.	Setting parameter	Setting
1	Measured	Outlet pressure
2	"Limit"	5 bar
3	"Hysteresis band"	2 bar
4	"Limit exceeded when"	Below limit
5	"Detection delay"	5 seconds
6	"Resetting delay"	8 seconds
A	Limit-exceeded function active	-
-	Action	Warning

Factory setting

See [8. Factory settings of E-pumps](#) on page 61.

Special functions

"Pulse flowmeter setup"

Pump variant	"Pulse flowmeter setup"
TPE3, TPE3 D	•

You can connect an external pulse flowmeter to one of the digital inputs in order to register the actual and accumulated flows. Based on this, you can also calculate the specific energy.

To enable a pulse flowmeter, set one of the digital inputs to "Accumulated flow" and set the pumped volume per pulse. See ["Digital inputs"](#) on page 38.

"Ramps"

Pump variant	"Ramps"
TPE3, TPE3 D	•

The ramps determine how quickly the motor can accelerate and decelerate during start-stop or setpoint changes.

You can set the following:

- acceleration time, 0.1 to 300 seconds
- deceleration time, 0.1 to 300 seconds.

The times apply to the acceleration from 0 rpm to fixed maximum speed and the deceleration from fixed maximum speed to 0 rpm.

At short deceleration times, the deceleration of the motor may depend on load and inertia as there is no possibility of actively braking the motor.

If the power supply is switched off, the deceleration of the motor only depends on load and inertia.

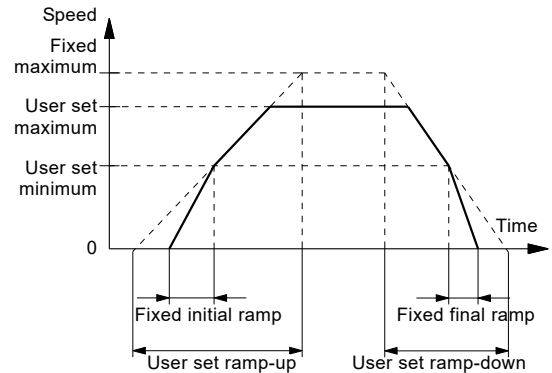

TM03 9439 0908

Fig. 45 Ramp-up and ramp-down

Factory setting

See [8. Factory settings of E-pumps](#) on page 61.

"Standstill heating"

Pump variant	"Standstill heating"
TPE3, TPE3 D	•

You can use this function to avoid condensation in humid environments. When you set the function to "Active" and the pump is in operating mode "Stop", a low AC voltage will be applied to the motor windings. The voltage is not high enough to make the motor rotate, but ensures that sufficient heat is generated to avoid condensation in the motor including the electronic parts in the drive.

Note: Remember to remove the drain plugs and fit a cover over the motors.

Factory setting

See [8. Factory settings of E-pumps](#) on page 61.

"Motor bearing monitoring"

Pump variant	"Motor bearing monitoring"
TPE3, TPE3 D	•

You can set the motor bearing monitoring function to these values:

- "Active"
- "Not active"

When the function is set to "Active", a counter in the controller will start counting the mileage of the bearings.

The counter continues counting even if the function is changed to "Not active", but a warning is not given when it is time for replacement or relubrication.

When the function is changed to "Active again", the accumulated mileage is again used to calculate the replacement or relubrication time.

Factory setting

See [8. Factory settings of E-pumps](#) on page 61.

"Service"

Pump variant	"Service"
TPE3, TPE3 D	•

"Motor bearing monitoring" must be activated in order for the motor to indicate that bearings must be replaced or relubricated. See ["Motor bearing monitoring"](#) on page 48.

For motors of 7.5 kW and below, it is not possible to relubricate the bearings.

Bearings on motors of 11 kW and above can be relubricated.

"Time until next service" ("Motor bearing service")

This display shows when to replace or relubricate the motor bearings. The controller monitors the operating pattern of the motor and calculates the period between bearing replacements or relubrications.

Displayable values:

- "in 2 years"
- "in 1 year"
- "in 6 months"
- "in 3 months"
- "in 1 month"
- "in 1 week"
- "Now".

"Bearing replacements"

This display shows the number of bearing replacements that have been done during the lifetime of the motor.

"Bearings replaced" ("Motor bearing maintenance")

When the bearing monitoring function is active, the controller gives a warning when the motor bearings are to be replaced.

When you have replaced the motor bearings, confirm this action by pressing [Bearings replaced].

"Bearing relubrications"

The following applies only for 11 kW motors.

This display shows the number of bearing relubrications that have been done since the last bearing replacement.

"Bearings relubricated" (Motor bearing maintenance)

The following applies only for 11 kW motors.

When the bearing monitoring function is active, the controller gives a warning when the motor bearings are due to be relubricated.

When you have relubricated the motor bearings, press [Bearings relubricated].

The factory-set interval between relubrications is stated on the bearing nameplate which is placed on the motor. The relubrication interval can be changed by a Grundfos service technician.

It is possible to relubricate the bearings five times according to the preset interval. When the preset interval has been reached after the fifth relubrication, a warning will be given to replace the bearings.

Communication

"Number" ("Pump number")

Pump variant	Number
TPE3, TPE3 D	•

You can allocate a unique number to the pump. This makes it possible to distinguish between pumps in connection with bus communication.

Factory setting

See [8. Factory settings of E-pumps](#) on page 61.

"Radio communication" ("Enable/disable radio comm.")

Pump variant	"Radio communication"
TPE3, TPE3 D	•

You can set the radio communication to either enabled or disabled. You can use this function in areas where radio communication is not allowed.

IR communication remains active.

Factory setting

See [8. Factory settings of E-pumps](#) on page 61.

General settings

"Language"

Pump variant	"Language"
TPE3, TPE3 D	•

This menu is only available in the advanced control panel.

In this menu you can select the desired language. A number of languages are available.

"Date and time"

Pump variant	"Date and time"
TPE3, TPE3 D	•

You can set date and time as well as how they are to be shown in the display:

- "Select date format"
"YYYY-MM-DD"
"DD-MM-YYYY"
"MM-DD-YYYY".
- "Select time format":
"HH:MM 24-hour clock"
"HH:MM am/pm 12-hour clock".
- "Set date"
- "Set time".

"Unit configuration" ("Units")

Pump variant	"Unit configuration"
TPE3, TPE3 D	•

In this menu you can select between SI and US units. The setting can be made generally for all parameters or customized for each parameter.

Factory setting

See [8. Factory settings of E-pumps](#) on page 61.

"Buttons on product" ("Enable/disable settings")

Pump variant	"Buttons on product"
TPE3, TPE3 D	•

In this display, you can disable the possibility of making settings.



Grundfos GO

If you set the buttons to "Not active", the buttons on the standard control panel are disabled. If you set the buttons to "Not active" on pumps with an advanced control panel, see below.

Advanced control panel

If you have disabled the settings, you can still use the buttons to navigate through the menus but you cannot make changes in the "Settings" menu.

When you have disabled the possibility to make settings, the  symbol appears in the display.

To unlock the pump and allow settings, press  and  simultaneously for at least 5 seconds.

Standard control panel

The  button always remains active but you can only unlock all other buttons on the pump with Grundfos GO.

"Delete history"

Pump variant	"Delete history"
TPE3, TPE3 D	•

This menu is only available in the advanced control panel.

In this menu, you can delete the following historic data:

- "Delete work log."
- "Delete heat energy data"
- "Delete energy consumption".

"Define Home display"

Pump variant	"Define Home display"
TPE3, TPE3 D	•

This menu is only available in the advanced control panel.

In this menu, you can set the "Home" display to show up to four user-set parameters.

"Display settings"

Pump variant	"Display settings"
TPE3, TPE3 D	•

This menu is only available in the advanced control panel.

In this menu you can adjust the display brightness and set whether or not the display is to turn off if no buttons have been activated for a period of time.

"Store settings" ("Store actual settings")

Pump variant	"Store settings"
TPE3, TPE3 D	•

Grundfos GO

In this menu, you can store the actual settings for later use in the same pump or in other pumps of the same type.

Advanced control panel

In this menu, you can store the actual settings for later use in the same pump.

"Recall settings" ("Recall stored settings")

Pump variant	"Recall settings"
TPE3, TPE3 D	•

Grundfos GO

In this menu, you can recall stored settings from a number of previously stored settings that the pump then uses.

Advanced control panel

In this menu, you can recall the last stored settings that the pump then uses.

"Undo"

Pump variant	"Undo"
TPE3, TPE3 D	•

This menu is only available in Grundfos GO.

In this display, you can undo all settings that have been made with Grundfos GO in the current communication session. You cannot undo a "Recall stored settings" action.

"Pump name"

Pump variant	"Pump name"
TPE3, TPE3 D	•

This menu is only available in Grundfos GO.

In this display, you can give the pump a name. In this way, you can easily identify the pump when connecting with Grundfos GO.

Factory setting

See [8. Factory settings of E-pumps](#) on page 61.

"Connection code"

Pump variant	"Connection code"
TPE3, TPE3 D	•

This menu is only available in Grundfos GO.

You can set a connection code to avoid having to press the connection button each time and to restrict remote access to the product.

Setting the code in the product using Grundfos GO

1. Connect Grundfos GO to the product.
2. In the product dashboard, select "Settings".
3. Choose "Connection code".
4. Enter the wanted code and press [OK].
The code must be a character string, ASCII. You can always modify the code. The old code is not needed.

Setting the code in Grundfos GO

You can set a default connection code in Grundfos GO so that it automatically attempts to connect to the selected product via this code.

When you select a product with the same connection code in Grundfos GO, Grundfos GO automatically connects to the product and you do not have to press the connection button on the module.

Set the default code in Grundfos GO in this way:

1. In the main menu, under "General", select "Settings".
2. Choose "Remote".
3. Enter the connection code in the field "Preset connection code". The field now says "Connection code set".

You can always modify the default connection code by pressing [Delete] and entering a new one.

If Grundfos GO fails to connect and ask you to press the connection button on the product, it means that the product has no connection code or has a different connection code. In this case, you can only establish connection via the connection button.

After setting a connection code, you must switch off the product until the light in Grundfos Eye turns off before you can use the new connection code.

Factory setting

See [8. Factory settings of E-pumps](#) on page 61.

"Run startup guide"

Pump variant	"Run startup guide"
TPE3, TPE3 D	•

This menu is only available in the advanced control panel.

The startup guide automatically starts when you start the pump for the first time.

You can always run the startup guide later via this menu.

The startup guide guides you through the general settings of the pump.

- "Language". See ["Language"](#) on page 49.
- "Select date format".*
See ["Date and time"](#) on page 49.
- "Set date".*
See ["Date and time"](#) on page 49.
- "Select time format".*
See ["Date and time"](#) on page 49.
- "Set time".*
See ["Date and time"](#) on page 49.
- "Setting of pump"
 - "Go to Home"
 - "Run with Constant curve" / "Run with Constant pressure".
See ["Control mode"](#) on page 28
 - "Go to Assisted pump setup".
See ["Assisted pump setup"](#) on page 52.
 - "Return to factory settings".

* Applies only for pumps with advanced functional module, FM 300. For further information, see [Identification of functional module](#) on page 73.

"Alarm log"

Pump variant	"Alarm log"
TPE3, TPE3 D	•

This menu contains a list of logged alarms from the product. The log shows the name of the alarm, when the alarm occurred and when it was reset.

"Warning log"

Pump variant	"Warning log"
TPE3, TPE3 D	•

This menu contains a list of logged warnings from the product. The log shows the name of the warning, when the warning occurred and when it was reset.

"Assist"

Pump variant	"Assist"
TPE3, TPE3 D	•

The menu consist of functions which take you through the steps needed to set the pump.

"Assisted pump setup"

Pump variant	"Assisted pump setup"
TPE3, TPE3 D	•

The menu guides you through the following:

Setting of pump

- Selection of control mode. See page 28.
- Configuration of feedback sensors.
- Adjusting the setpoint. See page 27.
- Controller settings. See page 41.
- Summary of settings.

Example of how to use the "Assisted pump setup" for setting up the pump to constant pressure:

Grundfos GO

1. Open the "Assist" menu.
2. Select "Assisted pump setup".
3. Select the control mode "Constant pressure".
4. Read the description of this control mode.
5. Select which analog input to use as sensor input.
6. Select sensor function according to where the sensor is installed in the system. See fig. 33.
7. Select electrical input signal according to the sensor specifications.
8. Select measuring unit according to the sensor specifications.
9. Set the minimum and maximum sensor values according to the sensor specifications.
10. Set the desired setpoint.
11. Set the controller settings K_p and T_i . See the recommendations in section "Controller" ("Controller settings") on page 41.
12. Type the pump name.
13. Check the summary of settings and confirm them.

Advanced control panel

1. Open the "Assist" menu.
2. Select "Assisted pump setup".
3. Select the control mode "Const. pressure".
4. Select which analog input to use as sensor input.
5. Select the measured parameter to be controlled. See fig. 33.
6. Select measuring unit according to the sensor specifications.
7. Set the minimum and maximum sensor values according to the sensor specifications.
8. Select electrical input signal according to the sensor specifications.
9. Set the setpoint.
10. Set the controller settings K_p and T_i . See recommendations in section "Controller" ("Controller settings") on page 41.
11. Check the summary of settings and confirm them by pressing [OK].

"Setup, analog input"

Pump variant	"Setup, analog input"
TPE3, TPE3 D	•

This menu is only available in the advanced control panel.

The menu guides you through the following:

"Setup, analog input"

- Analog inputs 1 to 3. See page 35.
- Pt100/1000 input 1 and 2. See page 38.
- Adjusting the setpoint. See page 27.
- Summary.

"Setting of date and time"

Pump variant	"Setting of date and time"
TPE3, TPE3 D	•

This menu guides you through the following:

- "Select date format". See ["Date and time"](#) on page 49.
- "Set date". See ["Date and time"](#) on page 49.
- "Select time format". See ["Date and time"](#) on page 49.
- "Set time". See ["Date and time"](#) on page 49.

"Multipump setup" ("Setup of multi-pump system")

Pump variant	"Multipump setup"
TPE3, TPE3 D	•

The multipump function enables the control of two pumps connected in parallel without the use of external controllers. The pumps in a multipump system communicate with each other via the wireless GENair connection or the wired GENI connection.

A multipump system is set via a selected pump: the master pump, which is the first selected pump.

If two pumps in the system are configured with an outlet-pressure sensor, both pumps can function as master pumps and take over the master pump function if the other fails. This provides additional redundancy in the multipump system.

The multipump functions are described in the following sections.

Alternating operation

Alternating operation functions as a duty-standby operating mode and is possible with two pumps of same size and type connected in parallel. The main purpose of the function is to ensure an even amount of running hours and that the standby pump takes over if the running pump stops due to an alarm.

Each pump requires a non-return valve in series with the pump.

You can choose between two alternating operation modes:

- Alternating operation, time
Pump changeover to the other is based on time.
- Alternating operation, energy
Pump changeover to the other is based on energy consumption.

If the duty pump fails, the other pump takes over automatically.

Backup operation

Backup operation is possible with two pumps of same size and type connected in parallel. Each pump requires a non-return valve in series with the pump.

One pump is operating continuously. The backup pump is operated for a short time each day to prevent seizing up. If the duty pump stops due to a fault, the backup pump starts automatically.

Cascade operation

Cascade operation ensures that the pump performance is automatically adapted to the consumption by switching pumps on or off. The system thus runs as energy-efficiently as possible with a constant pressure and a limited number of pumps.

When a twin-head pump is running in constant-pressure control mode, the second pump head starts at 90 % and stops at 50 % performance.

All pumps in operation run at equal speed. Pump changeover is automatic and depends on energy, operating hours and fault.

Pump system:

- Twin-head pump.
- Two or four single-head pumps connected in parallel.
The pumps must be of the same type and size. Each pump requires a non-return valve in series with the pump.

Set the control mode to "Const. pressure" or "Const. curve".

This function is available with up to 4 motors installed in parallel. The motors must be of the same size and the pumps must be of the same model.

- The performance is adjusted to the demand through cutting pumps in or out and through parallel control of the pumps in operation.
- The controller maintains a constant pressure through continuous adjustment of the speed of the pumps.
- Pump changeover is automatic and depends on load, operating hours and fault detection.
- All pumps in operation run at the same speed.
- The number of pumps in operation also depends on the energy consumption of the pumps. If only one pump is required, two pumps will run at a lower speed if this results in a lower energy consumption.
- If several motors in the system have a sensor, they can all function as master and take over the master function if the other fails.

Sensor to be used

Define the sensor to be used for controlling the pump system. If a sensor is placed in a way that it is able to measure the sensor output from all pumps in the system, for example, in the manifold, then select "Master pump sensor".

If a sensor is placed on, or across the individual pumps, for example, installed behind non-return valves and not able to measure the sensor output from all pumps, then select "Running pump sensor".

Setting a multipump system

You can set a multipump system in the following ways:

- [Grundfos GO and wireless pump connection](#)
- [Grundfos GO and wired pump connection](#)
- [Advanced control panel and wireless pump connection](#)
- [Advanced control panel and wired pump connection](#).

See step-by-step descriptions below.

Grundfos GO and wireless pump connection

1. Power on both pumps.
2. Establish contact to one of the pumps with Grundfos GO.
3. Set the needed analog and digital inputs via Grundfos GO according to the connected equipment and the required functionality. See ["Assisted pump setup"](#) on page 52.
4. Assign a pump name to the pump using Grundfos GO. See ["Pump name"](#) on page 51.
5. Disconnect Grundfos GO from the pump.
6. Establish contact to the other pump.
7. Set the needed analog and digital inputs via Grundfos GO according to the connected equipment and the required functionality. See ["Assisted pump setup"](#) on page 52.
8. Assign a pump name to the pump using Grundfos GO. See ["Pump name"](#) on page 51.
9. Select the "Assist" menu and "Multipump setup".
10. Select the desired multipump function. See ["Alternating operation"](#) on page 53, ["Backup operation"](#) on page 53 and ["Cascade operation"](#) on page 54.
11. Press [>] to continue.
12. Set the time for pump changeover such as the time at which the alternation between the two pumps is to take place. This step applies only if you have selected "Alternating operation, time" and if the pumps are fitted with FM 300.
13. Press [>] to continue.
14. Select "Radio" as the communication method to be used between the two pumps.
15. Press [>] to continue.
16. Press "Select pump 2".
17. Select the pump from the list.
Use the [OK] or  button to identify the pump.
18. Press [>] to continue.
19. Confirm the multipump setup by pressing [Send].
20. Press [Finish] in the "Setup complete" dialog box.
21. Wait for the green indicator light in the middle of Grundfos Eye to light up.

The multipump system has now been set.

Grundfos GO and wired pump connection

1. Connect the two pumps with each other with a 3-core screened cable between the GENIbus terminals A, Y, B.
2. Power on both pumps.
3. Establish contact to one of the pumps with Grundfos GO.
4. Set the needed analog and digital inputs via Grundfos GO according to the connected equipment and the required functionality. See ["Assisted pump setup"](#) on page 52.
5. Assign a pump name to the pump using Grundfos GO. See ["Pump name"](#) on page 51.
6. Assign pump number 1 to the pump. See ["Number" \("Pump number"\)](#) on page 49.
7. Disconnect Grundfos GO from the pump.
8. Establish contact to the other pump.
9. Set the needed analog and digital inputs via Grundfos GO according to the connected equipment and the required functionality. See ["Assisted pump setup"](#) on page 52.
10. Assign a pump name to the pump using Grundfos GO. See ["Pump name"](#) on page 51.
11. Assign pump number 2 to the pump. See ["Number" \("Pump number"\)](#) on page 49.
12. Select the "Assist" menu and choose "Multipump setup".
13. Select the desired multipump function. See ["Alternating operation"](#) on page 53, ["Backup operation"](#) on page 53 and ["Cascade operation"](#) on page 54.
14. Press [>] to continue.
15. Set the time for pump changeover such as the time at which the alternation between the two pumps is to take place. This step applies only if you have selected "Alternating operation, time" and if the pumps are fitted with FM 300.
16. Press [>] to continue.
17. Select "BUS cable" as the communication method to be used between the two pumps.
18. Press [>] to continue.
19. Press "Select pump 2".
20. Select the additional pump from the list.
Use the [OK] or  button to identify the additional pump.
21. Press [>] to continue.
22. Press [Send].
23. Press [Finish] in the "Setup complete" dialog box.
24. Wait for the green indicator light in the middle of Grundfos Eye to light up.

The multipump system has now been set.

Advanced control panel and wireless pump connection

1. Power on both pumps.
 2. On both pumps, set the needed analog and digital inputs according to the connected equipment and the required functionality. See ["Assisted pump setup"](#) on page 52.
 3. Select the "Assist" menu on one of the pumps and choose "Setup of multi-pump system".
 4. Press [>] to continue.
 5. Select "Wireless" as the communication method to be used between the two pumps.
 6. Press [>] to continue.
 7. Select the desired multipump function. See ["Alternating operation"](#) on page 53, ["Backup operation"](#) on page 53 and ["Cascade operation"](#) on page 54.
 8. Press [>] three times to continue.
 9. Press [OK] to search for other pumps.
The green indicator light in the middle of Grundfos Eye flashes on the other pumps.
 10. Press the connect button on the pump which is to be added to the multipump system.
 11. Press [>] to continue.
 12. Set the time for pump changeover i.e. the time at which the alternation between the two pumps is to take place. This step applies only if you have selected "Alternating operation, time" and if the pumps are fitted with FM 300.
 13. Press [>] to continue.
 14. Press [OK].
The multipump function icons appear in the bottom of the control panels.
- The multipump system has now been set.

Advanced control panel and wired pump connection

1. Connect the two pumps with each other with a 3-core screened cable between the GENIbus terminals A, Y, B.
 2. Set the needed analog and digital inputs according to the connected equipment and the required functionality. See "[Assisted pump setup](#)" on page 52.
 3. Assign pump number 1 to the first pump. See "[Number](#)" ("[Pump number](#)") on page 49.
 4. Assign pump number 2 to the other pump. See "[Number](#)" ("[Pump number](#)") on page 49.
 5. Select the "Assist" menu on one of the pumps and choose "Setup of multi-pump system".
 6. Press [>] to continue.
 7. Select "Wired GENIbus" as the communication method to be used between the two pumps.
 8. Press [>] twice to continue.
 9. Select the desired multipump function. See [Alternating operation](#) on page 53, [Backup operation](#) on page 53 and [Cascade operation](#) on page 54.
 10. Press [>] to continue.
 11. Press [OK] to search for other pumps.
 12. Select the additional pump from the list.
 13. Press [>] to continue.
 14. Set the time for pump changeover i.e. the time at which the alternation between the two pumps is to take place.
This step applies only if you have selected "Alternating operation, time" and if the pumps are fitted with FM 300.
 15. Press [>] to continue.
 16. Press [OK].
The multipump function icon appears in the bottom of the control panels.
- The multipump system has now been set.

Disabling the multipump function via Grundfos GO

1. Select the "Assist" menu.
2. Select "Multipump setup".
3. Select "Disable".
4. Press [>] to continue.
5. Confirm the multipump setup by pressing [Send].
6. Press [Finish].

The multipump function has now been disabled.

Disabling a multipump via advanced control panel

1. Select the "Assist" menu.
2. Select "Setup of multi-pump system".
3. Press [>] to continue.
4. Confirm "No multi-pump function" by pressing [OK].
5. Press [>] to continue.
6. Press [OK].

The multipump system has now been disabled.

"Description of control mode"

Pump variant	"Description of control mode"
TPE3, TPE3 D	•

This menu is only available in the advanced control panel.



This menu describes each of the possible control modes. See also section "[Control mode](#)" on page 28.

"Assisted fault advice"

Pump variant	"Assisted fault advice"
TPE3, TPE3 D	•

This menu gives guidance and corrective actions in case of pump failures.

Priority of settings

You can always set the pump to stop by pressing  on the pump control panel. When the pump is not in "Stop" mode, you can always stop the pump by continuously pressing . Furthermore, you can set the pump to maximum speed by continuously pressing . You can always set the pump to operation at maximum speed or to stop with Grundfos GO.

If two or more functions are enabled at the same time, the pump will operate according to the function with the highest priority.

Example

If you have set the pump to maximum speed via the digital input, the pump control panel or Grundfos GO can only set the pump to "Manual" or "Stop".

The priority of the settings appears from the table below.

Priority	Start-stop button	Grundfos GO or control panel on the motor	Digital input	Bus communication
1	"Stop"			
2		"Stop"*		
3		"Manual"		
4		"Max. speed"*/ "User-defined speed"		
5			"Stop"	
6			"User-defined speed"	
7				"Stop"
8				"Max. speed"
9				"Min. speed"
10				"Start"
11			"Max. speed"	
12		"Min. speed"		
13			"Min. speed"	
14			"Start"	
15		"Start"		

* "Stop" and "Max. speed" settings made with Grundfos GO or on the motor control panel can be overruled by another operating-mode command sent from a bus, for example "Start". If the bus communication is interrupted, the motor resumes its previous operating mode, for example "Stop", selected with Grundfos GO or on the motor control panel.

Grundfos Eye

The operating condition of the motor is indicated by Grundfos Eye on the control panel. See fig. 46 (1).

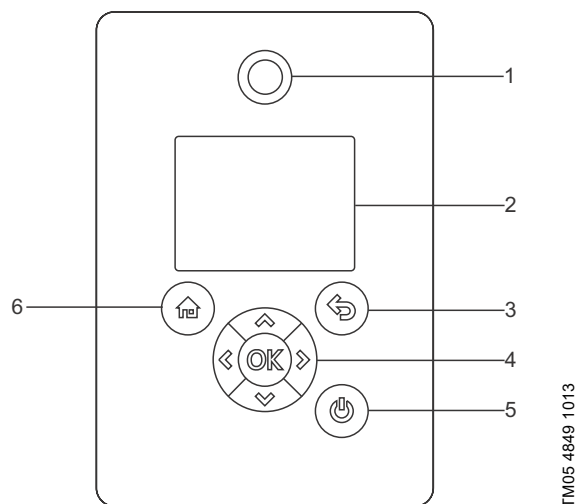

TM05 4849 1013

Fig. 46 Grundfos Eye











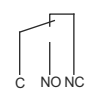
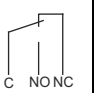
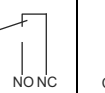
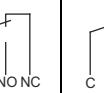





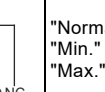

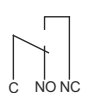
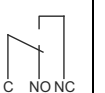
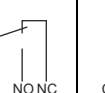
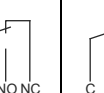
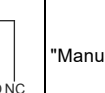

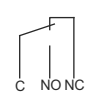
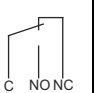
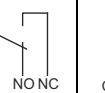
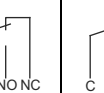
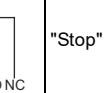

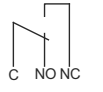
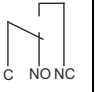
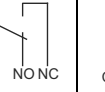
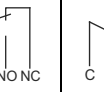
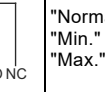

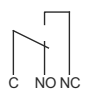
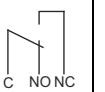
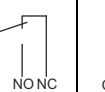
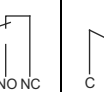
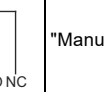
Grundfos Eye	Indication	Description
	No lights are on.	The power is off. The pump is not running.
	The two opposite green indicator lights are rotating in the direction of rotation of the pump when seen from the non-drive end.	The power is on. The pump is running.
	The two opposite green indicator lights are permanently on.	The power is on. The pump is not running.
	One yellow indicator light is rotating in the direction of rotation of the pump when seen from the non-drive end.	Warning. The pump is running.
	One yellow indicator light is permanently on.	Warning. The pump has stopped.
	The two opposite red indicator lights flash simultaneously.	Alarm. The pump has stopped.
	The green indicator light in the middle flashes quickly four times.	This is a feedback signal which the pump gives in order to ensure identification of itself.
	The green indicator light in the middle flashes continuously.	Grundfos GO or another pump is trying to communicate with the pump. Press on the pump control panel to allow communication.
	The green indicator light in the middle is permanently on.	Remote control with Grundfos GO via radio. The pump is communicating with Grundfos GO via radio connection.
	The green indicator light in the middle flashes quickly while Grundfos Go is exchanging data with the pump. It takes a few seconds.	Remote control with Grundfos GO via infrared light. The pump is receiving data from Grundfos GO via infrared communication.

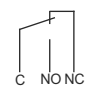
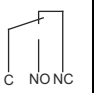
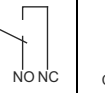
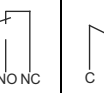
Indicator lights and signal relays

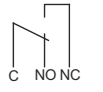
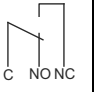
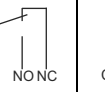
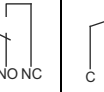
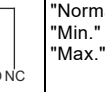
The pump has two outputs for potential-free signals via two internal relays.

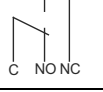
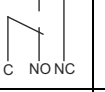
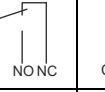
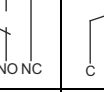
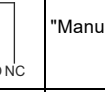
You can set the signal outputs to "Operation", "Pump running", "Ready", "Alarm" and "Warning".

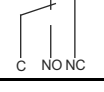
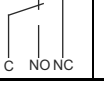
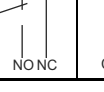
The functions of the two signal relays appear from the table below:

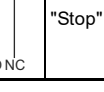
Description	Grundfos Eye	Contact position for signal relays when activated					"Operating mode"
		"Operation"	"Pump running"	"Ready"	"Alarm"	"Warning"	
The power is off.	 Off						-
The pump runs in "Normal" mode.	 Green, rotating						"Normal", "Min." or "Max."
The pump runs in "Manual" mode.	 Green, rotating						"Manual"
The pump is in operating mode "Stop".	 Green, steady						"Stop"
Warning, but the pump runs.	 Yellow, rotating						"Normal", "Min." or "Max."
Warning, but the pump runs in "Manual" mode.	 Yellow, rotating						"Manual"
Warning, but the pump was stopped via "Stop" command.	 Yellow, steady						"Stop"
Alarm, but the pump runs.	 Red, rotating						"Normal", "Min." or "Max."
Alarm, but the pump runs in "Manual" mode.	 Red, rotating						"Manual"
The pump has stopped due to an alarm.	 Red, flashing						"Stop"

The functions of the two indicator lights and the signal relay are as shown in the following table:

Indicator lights		Signal relay activated during:				Description
Fault red	Operation green	"Fault"/"Alarm", "Warning" and "Relubricate"	"Operating"	"Ready"	"Pump running"	
Off	Off					The power supply has been switched off.
Off	Permanently on					The pump runs.
Off	Flashing					The pump has been set to stop.
Permanently on	Off					The pump has stopped because of a "Fault" or "Alarm". Or the pump runs with a "Warning" or "Relubricate" indication. If the pump was stopped, restarting will be attempted. It may be necessary to restart the pump by resetting the "Fault" indication.
Permanently on	Permanently on					The pump runs, but it has or has had a "Fault" or "Alarm" allowing the pump to continue operation. Or the pump runs with a "Warning" or "Relubricate" indication. If the cause is "Sensor signal outside signal range", the pump continues to run according to the maximum curve, and you cannot reset the fault indication until the signal is inside the signal range. If the cause is "Setpoint signal outside signal range", the pump continues to run according to the minimum curve, and you cannot reset the fault indication until the signal is inside the signal range.
Permanently on	Flashing					The pump has been set to stop, but it has been stopped because of a "Fault".

Resetting of fault indication

You can reset a fault indication in one of the following ways:

- Briefly press or on the pump. This will not change the setting of the pump. A fault indication cannot be reset by means of or if the buttons have been locked.
- Switch off the power supply until the indicator lights are off.
- Switch the external start-stop input off and then on again.
- Use Grundfos GO.

8. Factory settings of E-pumps

- Function is enabled.
- ? Function is disabled.
- Function is not available.

Settings	TPE3, TPE3 D	Comments	Function description
"Setpoint"	Auto		Page 27
"Operating mode"	Normal		Page 27
"Control mode"	AutoAdapt		Page 28
"Date and time"	•		Page 49
"FLOW _{LIMIT} "	○		Page 35
"Automatic night setback"	○		Page 35
"Temperature influence"	○		Page 45
"Buttons on product"	•		
"Controller"			
"Kp"	1.0		Page 41
"Tj"	8.0		
"Operating range"			
"Min."	25 %		Page 42
"Max."	100 %		
"Ramps"	○		Page 47
"Pump number"	1		Page 49
"Radio communication"	•		Page 49
"Sensor type"	-		Page 35
"Analog input 1"	○		
"Analog input 2"	○		Page 35
"Analog input 3"	○		
"Built-in Grundfos sensor"	•		Page 37
"Pt100/1000 input 1"	○		Page 38
"Pt100/1000 input 2"	○		
"Digital input 1"	○		Page 38
"Digital input 2"	○		
"Digital in/output 3"	○		Page 39
"Digital in/output 4"	○		
"Pulse flowmeter"	○		Page 47
"Predefined setpoint"	○		Page 45
"Analog output" ¹⁾	○		Page 40
"External setpoint funct."	○		Page 43
"Signal relay 1"	○		Page 39
"Signal relay 2"	○		
"Limit 1 exceeded"	○		Page 46
"Limit 2 exceeded"	○		
"Standstill heating"	○		Page 48
"Motor bearing monitoring"	○		Page 48
"Pump name"	Grundfos		Page 51
"Connect code"	-		Page 51
"Unit configuration"	SI units		Page 49

Multipump factory setting for twin-pumps: Alternating operation on time.

9. Communication

Communication with TPE3 and TPE3 D pumps is possible via a central building management system, remote control, Grundfos GO, or control panel.

Central building management system

The operator can communicate with TPE3 and TPE3 D pumps at a distance. Communication can take place via a central building management system allowing the operator to monitor and change control modes and setpoint settings. See “CIM communication interface modules” on page 96.

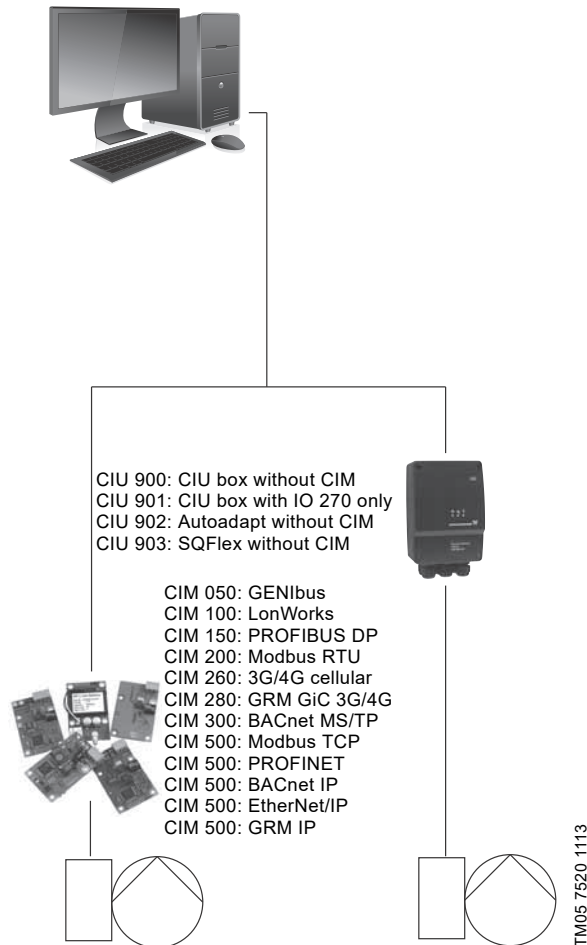

Fig. 47 Structure of a central building management system

Remote control

The operator can monitor and change control modes and settings of the pump with Grundfos GO. See [Grundfos GO](#) on page 24.

10. Speed regulation

Affinity equations

Normally, the pumps are used in applications characterised by a variable flow rate. Consequently, you cannot select a pump that is constantly operating at its optimum efficiency.

In order to achieve optimum operating economy, the duty point must be close to the optimum efficiency, η , for most operating hours.

Between the minimum and maximum performance curves, the pumps have an infinite number of performance curves each representing a specific speed. Therefore, you may not be able to select a duty point close to the maximum curve.

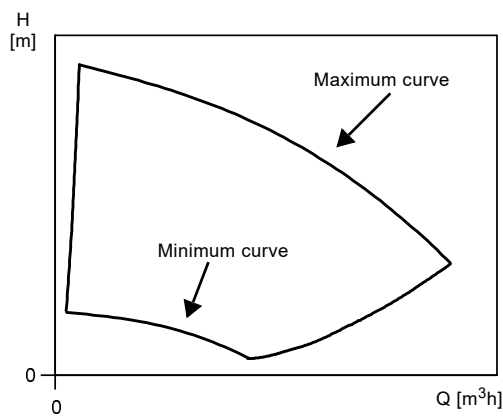

Fig. 48 Minimum and maximum performance curves

In situations where you can select a duty point close to the maximum curve, use the affinity equations below. The head, H, the flow rate, Q and the input power, P, are the appropriate variables you need for calculating the motor speed, n.

Note: The approximated formulas apply on condition that the system characteristic remains unchanged for the rated motor speed and the current motor speed, and that it is based on the following formula: H is equal to $k \times Q^2$ where k is a constant.

The power equation implies that the pump efficiency is unchanged at the two speeds. In practice, this is not quite correct.

Finally, it is worth noting that the efficiencies of the frequency converter and the motor must also be taken into account if you want a precise calculation of the power saving resulting from a reduction of the pump speed.

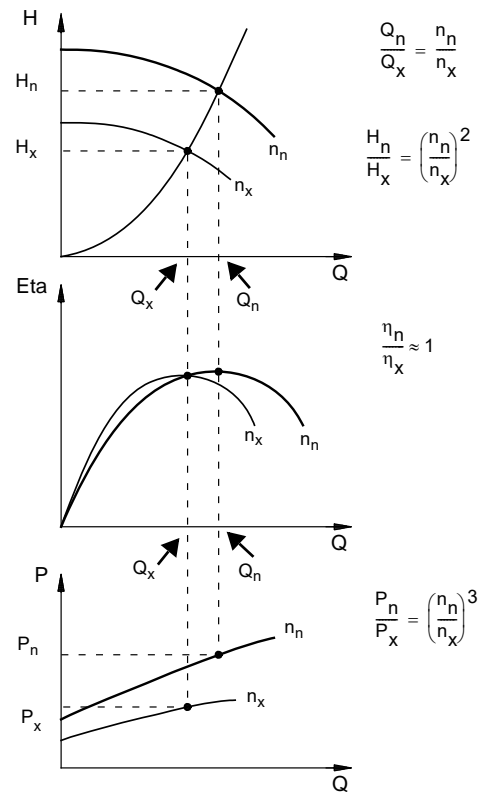

Fig. 49 Affinity equations

Legend

H_n	Rated head in metres
H_x	Current head in metres
Q_n	Rated flow rate in m^3/h
Q_x	Current flow rate in m^3/h
n_n	Rated motor speed in min^{-1}
n_x	Current motor speed in min^{-1}
η_n	Rated efficiency in %
η_x	Current efficiency in %
P_n	Rated power in kW
P_x	Current power in kW

Grundfos Product Center

Grundfos Product Center can help you select the right pump according to your requirements. See page 282.

TM01 4916 4803

TM00 8720 3496

11. Motor data

Motors

Mounting designation

Pump type	Mounting designation - NEMA
TPE (D) 3	56C
Relative humidity: Maximum 95 %	
Enclosure class: TEFC (IP55)	
Insulation class: F (IEC 85)	
Ambient temperature:	Maximum 122 °F (50 °C), MLE 1/60/200-240 and 3/60/440-480
	Maximum 104 °F (40 °C), MLE 3/60/200-240

If the pump is installed in humid locations, open the lowest drain hole in the motor. This reduces the motor enclosure class to IP44.

High-efficiency motors

TPE3, TPE3 D pumps are fitted with Grundfos permanent-magnet MLE motors that have motor efficiency class IE5 according to IEC 60034-30-2.

Electrical data, speed-controlled motors

Pump type	Motor power [hp]	Phase x voltage	Service factor	Efficiency	Full load current [A]	Service factor current [A]	Power factor	Full load speed [rpm]
TPE3 40-80	1/3	1 x 200-240 V	1	81.1 %	1.56	-	0.95	2970
		3 x 440-480 V	1.35	78.3 %	0.85	1.10	0.52	2970
TPE3 40-120	1/2	1 x 200-240 V	1	84.0 %	2.17	-	0.96	3390
		3 x 440-480 V	1.25	82.9 %	1.05	1.30	0.60	3390
TPE3 40-150	3/4	1 x 200-240 V	1	85.3 %	3.04	-	0.98	3900
	1 1/2	3 x 200-240 V	1.15	89.3 %	3.65	4.60	0.91	3900
	3/4	3 x 440-480 V	1.25	85.7 %	1.35	1.70	0.68	3900
TPE3 40-180	1	1 x 200-240 V	1	85.7 %	4.17	-	0.98	4350
		3 x 440-480 V	1.25	86.5 %	1.65	2.10	0.72	4350
TPE3 40-200	1 1/2	1 x 200-240 V	1	85.7 %	5.97	-	0.99	5000
		3 x 440-480 V	1.15	87.8 %	2.15	2.50	0.82	5000
TPE3 40-240	2	1 x 200-240 V	1	87.5 %	8.00	-	0.99	5500
		3 x 440-480 V	1.15	88.4 %	2.80	3.20	0.83	5500
TPE3 50-60	1/2	1 x 200-240 V	1	84.0 %	2.17	-	0.96	2500
		3 x 440-480 V	1.25	82.9 %	1.05	1.30	0.60	2500
TPE3 50-80	1/2	1 x 200-240 V	1	84.0 %	2.17	-	0.96	3000
		3 x 440-480 V	1.25	82.9 %	1.05	1.30	0.60	3000
TPE3 50-120	3/4	1 x 200-240 V	1	85.3 %	3.04	-	0.98	3430
		3 x 440-480 V	1.25	85.7 %	1.35	1.70	0.68	3430
TPE3 50-150	1	1 x 200-240 V	1	85.2 %	4.10	-	0.99	3800
	1 1/2	3 x 200-240 V	1.15	89.3 %	3.65	4.60	0.91	3800
	1	3 x 440-480 V	1.25	86.4 %	1.65	2.10	0.73	3800
TPE3 50-180	1 1/2	1 x 200-240 V	1	85.7 %	5.97	-	0.99	4360
		3 x 440-480 V	1.15	87.8 %	2.15	2.50	0.82	4360
TPE3 50-200	2	1 x 200-240 V	1	87.5 %	8.00	-	0.99	4800
		3 x 440-480 V	1.15	88.4 %	2.80	3.20	0.83	4800
TPE3 50-240	3	3 x 440-480 V	1.15	89.2 %	4.00	4.50	0.87	5500
TPE3 65-60	1/2	1 x 200-240 V	1	84.0 %	2.17	-	0.96	2400
		3 x 440-480 V	1.25	82.9 %	1.05	1.30	0.60	2400
TPE3 65-80	3/4	1 x 200-240 V	1	85.3 %	3.04	-	0.98	3000
		3 x 440-480 V	1.25	85.7 %	1.35	1.70	0.68	3000
TPE3 65-120	1	1 x 200-240 V	1	85.2 %	4.10	-	0.99	3530
		3 x 440-480 V	1.25	86.4 %	1.65	2.10	0.73	3530
TPE3 65-150	1 1/2	1 x 200-240 V	1	86.9 %	5.88	-	0.99	4000
		3 x 200-240 V	1.15	89.3 %	3.65	4.60	0.91	4000
		3 x 440-480 V	1.15	89.6 %	2.05	2.40	0.84	4000
TPE3 65-180	2	1 x 200-240 V	1	87.5 %	8.00	-	0.99	4470
		3 x 440-480 V	1.15	88.4 %	2.80	3.20	0.83	4470
TPE3 65-200	3	3 x 440-480 V	1.15	89.2 %	4.00	4.50	0.87	4800
TPE3 80-40	1/3	1 x 200-240 V	1	83.4 %	1.46	-	0.95	1860
		3 x 440-480 V	1.35	84.8 %	0.80	1.05	0.53	1860
TPE3 80-110	1 1/2	3 x 200-240 V	1.15	89.3 %	3.65	4.60	0.91	3000
TPE3 80-120	1 1/2	1 x 200-240 V	1	86.9 %	5.88	-	0.99	3000
		3 x 440-480 V	1.15	89.6 %	2.05	2.40	0.84	3000

Pump type	Motor power [hp]	Phase x voltage	Service factor	Efficiency	Full load current [A]	Service factor current [A]	Power factor	Full load speed [rpm]
TPE3 80-150	2	1 x 200-240 V	1	87.4 %	7.97	-	0.99	3400
		3 x 200-240 V	1	88.9 %	4.80	-	0.92	3400
		3 x 440-480 V	1.15	89.4 %	2.65	3.00	0.87	3400
TPE3 80-180	3	3 x 200-240 V	1.15	88.7 %	6.92	9.10	0.94	3900
		3 x 440-480 V	1.15	90.7 %	3.80	4.30	0.89	3900
TPE3 100-40	1/3	1 x 200-240 V	1	83.4 %	1.46	-	0.95	1860
		3 x 440-480 V	1.35	84.8 %	0.80	1.05	0.53	1860
TPE3 100-120	1 1/2	1 x 200-240 V	1	86.9 %	5.88	-	0.99	3000
		3 x 440-480 V	1.15	89.6 %	2.05	2.40	0.84	3000
TPE3 100-150	2	1 x 200-240 V	1	87.4 %	7.97	-	0.99	3410
		3 x 440-480 V	1.15	89.4 %	2.65	3.00	0.87	3410
TPE3 100-180	3	3 x 440-480 V	1.15	90.7 %	3.80	4.30	0.89	3890
TPE3 D 65-80	3/4	1 x 200-240 V	1	85.3 %	3.04	-	0.98	3000
		3 x 440-480 V	1.25	85.7 %	1.35	1.70	0.68	3000
TPE3 D 65-120	1	1 x 200-240 V	1	85.2 %	4.10	-	0.99	3530
		3 x 440-480 V	1.25	86.4 %	1.65	2.10	0.73	3530
TPE3 D 65-150	1 1/2	1 x 200-240 V	1	86.9 %	5.88	-	0.99	4000
		3 x 200-240 V	1.15	89.3 %	3.65	4.60	0.91	4000
		3 x 440-480 V	1.15	89.6 %	2.05	2.40	0.84	4000
TPE3 D 65-180	2	1 x 200-240 V	1	87.5 %	8.00	-	0.99	4470
		3 x 440-480 V	1.15	88.4 %	2.80	3.20	0.83	4470
TPE3 D 65-200	3	3 x 440-480 V	1.15	89.2 %	4.00	4.50	0.87	4800
TPE3 D 80-40	1/3	1 x 200-240 V	1	83.4 %	1.46	-	0.95	1860
		3 x 440-480 V	1.35	84.8 %	0.80	1.05	0.53	1860
TPE3 D 80-110	1 1/2	3 x 200-240 V	1.15	89.3 %	3.65	4.60	0.91	3000
TPE3 D 80-120	1 1/2	1 x 200-240 V	1	86.9 %	5.88	-	0.99	3000
		3 x 440-480 V	1.15	89.6 %	2.05	2.40	0.84	3000
TPE3 D 80-150	2	1 x 200-240 V	1	87.4 %	7.97	-	0.99	3400
		3 x 200-240 V	1	88.9 %	4.80	-	0.92	3400
		3 x 440-480 V	1.15	89.4 %	2.65	3.00	0.87	3400
TPE3 D 80-180	3	3 x 200-240 V	1.15	88.7 %	6.92	9.10	0.94	3900
		3 x 440-480 V	1.15	90.7 %	3.80	4.30	0.89	3900

12. Installation

Mechanical installation

You can install TPE3, TPE3 D pumps in horizontal or vertical pipes.

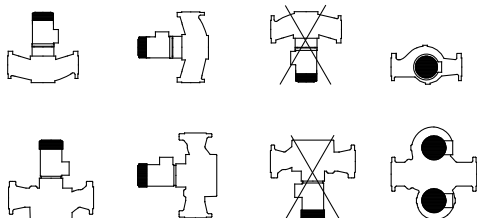

Fig. 50 Installation of motor

You can suspend pumps directly in the pipes, provided the pipes can support the pump. If not, install the pump on a mounting bracket or base plate.

In installations where the pump is suspended directly in the pipes, the pump can support the pipe length L on both sides of the pump. L is less than three times of pipe diameter. See fig. 51. In installations where the pump is suspended directly in the pipes, the pump must be lifted and held in correct position by means of ropes or similar until both pump flanges are completely fastened to the pipe flanges.

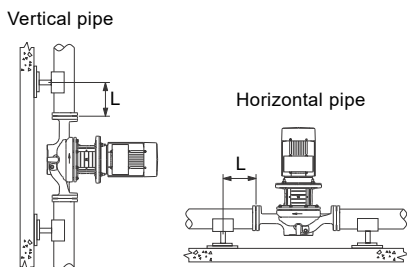

Fig. 51 Pump suspended directly in the pipes

When installing a twin-head pump in a horizontal pipe and with horizontal shaft, fit the upper pump housing with an automatic vent.

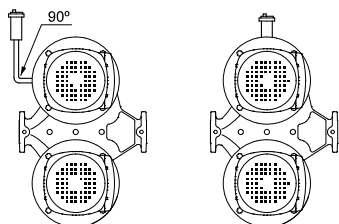

Fig. 52 Twin-head pumps with automatic vent

Twin-head pump housings have two Rp 1/4 tappings for mounting automatic vents.

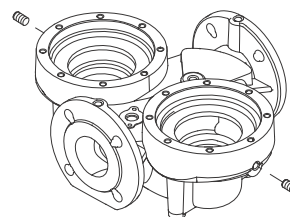

Fig. 53 Tappings for mounting automatic vents in TPE3 D

If the liquid temperature falls below the ambient temperature or if the pump is installed outside, condensation may form in the motor during inactivity. In this case, the drain hole in the motor flange must be open and point downwards. See fig. 54.

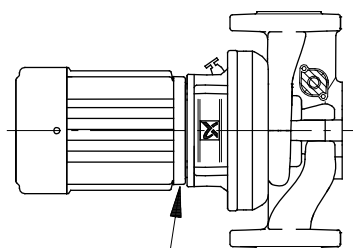

Fig. 54 Drain hole

If twin-head pumps are used for pumping liquids with a temperature below 32 °F (0 °C), condensed water may freeze and cause the coupling to get stuck. You can remedy the problem by installing heating elements. Whenever possible, install pumps with horizontal motor shaft. See fig. 52.

Cooling

To ensure sufficient cooling of motor and electronics, observe the following:

- Place the pump in such a way that sufficient cooling is ensured.
- Keep the motor cooling fins, holes in fan cover and fan blades clean.
- Make sure that the frequency for the motor is at least 6 Hz, 12 % of maximum speed. The shaft seal may generate noise at speeds below 25 % of maximum speed.

TM00 3734 0897

TM07 3140 4718

TM06 3518 0615

TM00 9831 3202

TM03 8127 0507

Condensation cover

When installing the pumps outdoors, provide the motor with a suitable cover to protect the pump and motor against the direct effects of the elements, and open the drain holes to avoid condensation on the electronic components.

When mounting the condensation cover on top of the motor, make sure to leave enough space for the air to cool the motor.

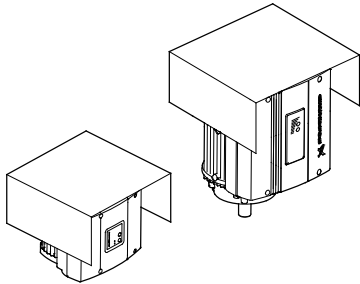

Fig. 55 Motors with condensation cover

TM02 8514 0304

Expansion joints

Expansion joints do the following:

- absorb expansions or contractions in the pipes caused by changing liquid temperature.
- reduce mechanical strains in connection with pressure surges in the pipes.
- isolate mechanical structure-borne noise in the pipes. Only rubber bellows expansion joints.

Note: Do not install expansion joints to compensate for inaccuracies in the pipes such as centre displacement of flanges.

Fit expansion joints at a distance of minimum 1 to 1.5 times the nominal flange diameter away from the pump on the inlet as well as on the outlet side. This prevents the development of turbulence in the expansion joints, resulting in better suction conditions and a minimum pressure loss on the outlet side. At high water velocities, greater than 16.4 ft/s, we recommend that you install larger expansion joints corresponding to the pipes. See fig. 56.

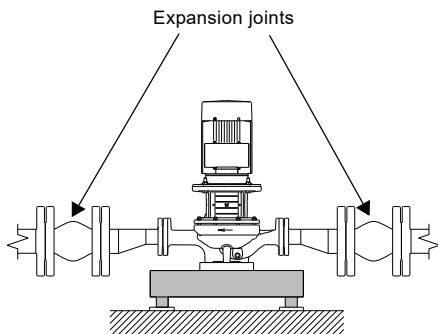

Fig. 56 TPE3 pump installed with larger expansion joints

TM04 9629 4810

The illustration below shows examples of rubber bellows expansion joints with or without limit rods.

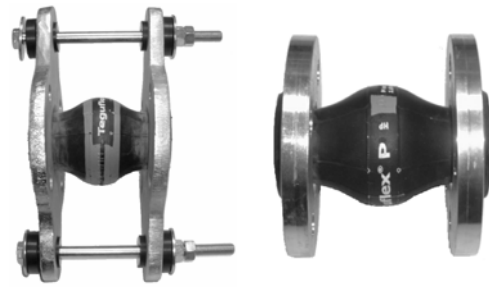

Fig. 57 Examples of rubber bellows expansion joints

TM02 4979 1902 - TM02 4981 1902

You can use expansion joints with limit rods to reduce the effects of the expansion or contraction forces on the pipes. We always recommend expansion joints with limit rods for flanges larger than 4 inches.

Anchor the pipes in such a way that they do not stress the expansion joints and the pump. Follow the supplier's instructions and pass them on to advisers or pipe installers.

The illustration below shows an example of a metal bellows expansion joint with limit rods.



Fig. 58 Example of metal expansion joint

TM02 4980 1902

Due to the risk of rupture of the rubber bellows, metal bellows expansion joints may be preferred at temperatures above 212 °F (100 °C) combined with high pressure.

Terminal box positions

As standard, the terminal box of TPE3 pumps is mounted in 9 o'clock position.

The possible terminal box positions are shown below.

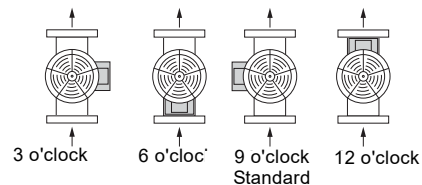

Fig. 59 Possible terminal box positions

TM03 0565 2005

On TPE3 D pumps, the terminal box is installed in a position different from 12 o'clock.

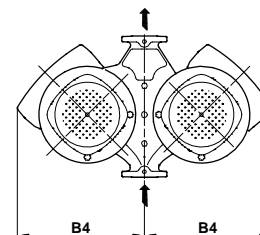

Fig. 60 Terminal box positions of TPE3 D pumps

TM02 8630 0604

13. Motors with built-in VFD

Technical data, single-phase motors

Supply voltage

1 x 200-240 V - 10 %/+ 10 %, 60 Hz, PE.

Confirm that the supply voltage and frequency correspond to the values stated on the nameplate.

Recommended fuse size

Motor size [hp (kW)]	Min. [A]	Max. [A]
0.33 - 1 (0.25 - 0.75)	6	10
1.5 - 2 (1.1 - 1.5)	10	16

You can use standard as well as quick-blow or slow-blow fuses.

Leakage current

Ground leakage current less than 3.5 mA, AC.

Ground leakage current less than 10 mA, DC.

The leakage currents are measured in accordance with EN 61800-5-1:2007.

Technical data, three-phase motors

Supply voltage

- 3 x 440-480 V - 10 %/+ 10 %, 60 Hz, PE.

Confirm that the supply voltage and frequency correspond to the values stated on the nameplate.

Recommended fuse size

Motor size [hp (kW)]	Min. [A]	Max. [A]
0.33 - 1.5 (0.25 - 1.1)	6	6
2 (1.5)	6	10
3 (2.2)	6	16

You can use standard as well as quick-blow or slow-blow fuses.

- 3 x 200-240 V, 60 Hz, PE.

Recommended fuse size

Motor size [hp (kW)]	Min. [A]	Max. [A]
1.5 (1.1)	10	20
2 (1.5)	10	20
3 (2.2)	13	35

You can use standard as well as quick-blow or slow-blow fuses.

Leakage current, AC

Speed [min ⁻¹]	Motor size [hp (kW)]	Mains voltage [V]	Leakage current [mA]
1400-2000 1450-2200	0.33 - 2 (0.25 - 1.5)	≤ 400	< 3.5
		> 400	< 5
	3 (2.2)	≤ 400	< 3.5
		> 400	< 3.5
2900-4000	0.33 - 3 (0.25 - 2.2)	≤ 400	< 3.5
		> 400	< 5
4000-5900	0.3 - 3 (0.25 - 2.2)	≤ 400	< 3.5
		> 400	< 5

The leakage currents are measured without any load on the shaft and in accordance with EN 61800-5-1:2007.

Inputs and outputs

Earth reference, GND

All voltages refer to GND.

All currents return to GND.

Absolute maximum voltage and current limits

Exceeding the following electrical limits may result in severely reduced operating reliability and motor life:

Relay 1:

Maximum contact load: 250 VAC, 2 A or 30 VDC, 2 A.

Relay 2:

Maximum contact load: 30 VDC, 2 A.

GENI terminals: -5.5 to 9.0 VDC or less than 25 mADC.

Other input or output terminals: -0.5 to 26 VDC or less than 15 mADC.

Digital inputs, DI

Internal pull-up current greater than 10 mA at V_i equal to 0 VDC.

Internal pull-up to 5 VDC (current less for V_i greater than 5 VDC).

Low logic level: V_i less than 1.5 VDC.

High logic level: V_i greater than 3.0 VDC.

Hysteresis: No.

Screened cable: 0.5 - 1.5 mm², 28-16 AWG.

Maximum cable length: 1640 ft (500 m).

Open-collector digital outputs, OC

Current sinking capability: 75 mADC, no current sourcing.

Load types: Resistive or/and inductive.

Low-state output voltage at 75 mADC: Maximum 1.2 VDC.

Low-state output voltage at 10 mADC: Maximum 0.6 VDC.

Overcurrent protection: Yes.

Screened cable: 0.5 - 1.5 mm², 28-16 AWG.

Maximum cable length: 1640 ft (500 m).

Analog inputs, AI

Voltage signal ranges:

- 0.5 - 3.5 VDC, AL AU.
- 0-5 VDC, AU.
- 0-10 VDC, AU.

Voltage signal: R_i greater than 100 k Ω at 25 °C.

Leak currents may occur at high operating temperatures. Keep the source impedance low.

Current signal ranges:

- 0-20 mADC, AU.
- 4-20 mADC, AL AU.

Current signal: R_i equal to 292 Ω .

Current overload protection: Yes. Change to voltage signal.

Measurement tolerance: - 0/+ 3 % of full scale (maximum-point coverage).

Screened cable: 0.5 - 1.5 mm², 28-16 AWG.

Maximum cable length: 1640 ft (500 m) (excl. potentiometer).

Potentiometer connected to +5 V, GND, any AI:

Use maximum 10 k Ω .

Maximum cable length: 328 ft (100 m).

Analog output, AO

Current sourcing capability only.

Voltage signal:

- Range: 0-10 VDC.
- Minimum load between AO and GND: 1 k Ω .
- Short-circuit protection: Yes.

Current signal:

- Ranges: 0-20 and 4-20 mADC.
- Maximum load between AO and GND: 500 Ω .
- Open-circuit protection: Yes.

Tolerance: - 0/+ 4 % of full scale (maximum-point coverage).

Screened cable: 0.5 - 1.5 mm², 28-16 AWG.

Maximum cable length: 1640 ft (500 m).

Pt100/1000 inputs, PT

Temperature range:

- Minimum -22 °F (-30 °C). 88 Ω / 882 Ω .
- Maximum 356 °F (180 °C). 168 Ω / 1685 Ω .

Measurement tolerance: \pm 35 °F (1.5 °C).

Measurement resolution: < 33 °F (0.3 °C).

Automatic range detection, Pt100 or Pt1000: Yes.

Sensor fault alarm: Yes.

Screened cable: 0.5 - 1.5 mm², 28-16 AWG.

Use Pt100 for short wires.

Use Pt1000 for long wires.

LiqTec sensor inputs*

Use Grundfos LiqTec sensor only.

Screened cable: 0.5 - 1.5 mm², 28-16 AWG.

Grundfos Digital Sensor input and output, GDS*

Use Grundfos Digital Sensor only.

* Only applicable for TPE3, TPE3 D pumps.

Power supplies**+5 V:**

- Output voltage: 5 VDC - 5 %/+ 5 %.
- Maximum current: 50 mADC, sourcing only.
- Overload protection: Yes.

+24 V:

- Output voltage: 24 VDC - 5 %/+ 5 %.
- Maximum current: 60 mADC, sourcing only.
- Overload protection: Yes.

Digital outputs, relays

Potential-free changeover contacts.

Minimum contact load when in use: 5 VDC, 10 mA.

Screened cable: 0.5 - 2.5 mm², 28-12 AWG.

Maximum cable length: 1640 ft (500 m).

Bus input

Grundfos GENIbus protocol, RS-485.

Screened 3-core cable: 0.5 - 1.5 mm², 28-16 AWG.

Maximum cable length: 1640 ft (500 m).

EMC, electromagnetic compatibility

Standard used: EN 61800-3.

The table below shows the emission category of the motor.

C1 fulfils the requirements for residential areas.

The impedance of the power cables between the motor and the point of common coupling (PCC) must be equivalent to the impedance of a 164 ft (50 m) cable with a cross-section of .02 in (0.5 mm).

C3 fulfils the requirements for industrial areas.

Note: When the motors are installed in residential areas, supplementary measures may be required as the motors may cause radio interference.

Motor [hp (kW)]	Emission category	
	1450-2200 rpm	2900-4000 rpm 4000-5900 rpm
0.33 (0.25)	C1	C1
0.5 (0.37)	C1	C1
0.75 (0.55)	C1	C1
1 (0.75)	C1	C1
1.5 (1.1)	C1	C1
2 (1.5)	C1	C1
3 (2.2)	C1	C1

* C1, if equipped with an external Grundfos EMC filter.

Immunity: The motor fulfils the requirements for industrial areas.

Contact Grundfos for further information.

Enclosure class

Standard: TEFC (IP55) (IEC 34-5).

Insulation class

F (IEC 85).

Ambient temperature

During operation:

- -4 to 122 °F (-20 to 50 °C) 1/60/200-240 and 3/60/440-480.
- -4 to 104 °F (-20 to 40 °C) 3/60/200-240.

During storage and transportation: -22 to 140 °F (-30 to 60 °C).

Standby power consumption

5-10 W.

Cable entries

Motor [hp (kW)]	Number and size of cable entries
	TPE3, TPE3 D
0.33 - 2 (0.25 - 1.5) 3 (2.2)	4 x M20

Sound pressure level

TPE3, TPE3 D

Pump size	Sound pressure level ISO 3743 [dB(A)]
TPE3 40-80	52
TPE3 40-120	59
TPE3 40-150	60
TPE3 40-180	63
TPE3 40-200	65
TPE3 40-240	66
TPE3 50-80	56
TPE3 50-150	60
TPE3 50-200	64
TPE3 50-240	66
TPE3 65-80	51
TPE3 65-120	59
TPE3 65-150	62
TPE3 80-40	43
TPE3 80-110	53
TPE3 80-120	53
TPE3 80-150	62
TPE3 80-180	64

Motor protection

The motor requires no external motor protection. The motor incorporates thermal protection against slow overloading and blocking.

Additional protection

The residual-current circuit breaker must be marked with the following symbol:

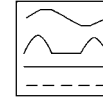

The total leakage current of all the electrical equipment in the installation must be taken into account. You find the leakage current of the motor in [Leakage current](#) and [Leakage current, AC](#), see page 68.

This product can cause a direct current in the protective-earth conductor.

Overvoltage and undervoltage protection

Overvoltage and undervoltage may occur in case of unstable power supply or a faulty installation. The motor is stopped if the voltage falls outside the permissible voltage range. The motor restarts automatically when the voltage is again within the permissible voltage range. Therefore, no additional protection relay is required.

Note: The motor is protected against transients from the power supply according to EN 61800-3. In areas with high lightning intensity, we recommend external lightning protection.

Overload protection

If the upper load limit is exceeded, the motor automatically compensates for this by reducing the speed and stops if the overload condition persists.

The motor remains stopped for a set period. After this period, the motor automatically attempts to restart. The overload protection prevents damage to the motor. Consequently, no additional motor protection is required.

Overtemperature protection

The electronic unit has a built-in temperature sensor as an additional protection. When the temperature rises above a certain level, the motor automatically compensates for this by reducing the speed and stops if the temperature keeps rising. The motor remains stopped for a set period. After this period, the motor automatically attempts to restart.

Protection against phase unbalance

Three-phase motors must be connected to a power supply with a quality corresponding to IEC 60146-1-1, class C, to ensure correct motor operation at phase unbalance. This also ensures long life of the components.

Maximum number of starts and stops

The number of starts and stops via the power supply must not exceed four times per hour.

When switched on via the power supply, the pump starts after approximately 5 seconds.

If you want a higher number of starts and stops, use the input for external start-stop when starting or stopping the pump.

When you start a pump via an external on/off switch, the pump starts immediately.

Wiring diagrams

Single-phase supply:

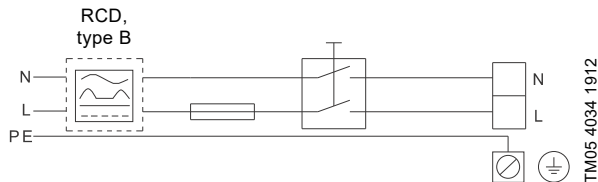

Fig. 61 Example of a motor with main switch, backup fuse and additional protection

Three-phase supply:

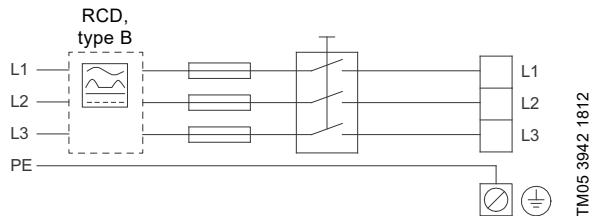

Fig. 62 Example of a motor with main switch, backup fuse and additional protection

Connection terminals

The descriptions and terminal overviews in this section apply to both single-phase and three-phase motors.

Connection terminals, advanced functional module, FM 300

The advanced module has these connections:

- three analog inputs
- one analog output
- two dedicated digital inputs
- two configurable digital inputs or open-collector outputs
- input and output for Grundfos Digital Sensor
The factory-fitted differential-pressure sensor for TPE3 and TPE3 D pumps is connected to this input.
- two Pt100/1000 inputs
- two LiqTec sensor inputs
- two signal relay outputs
- GENiBus connection.

See fig. 63.

Note: Digital input 1 is factory-set to be start-stop input where open circuit results in stop. A jumper has been factory-fitted between terminals 2 and 6. Remove the jumper if digital input 1 is to be used as external start-stop or any other external function.

Inputs and outputs

All inputs and outputs are internally separated from the power-conducting parts by reinforced insulation and galvanically separated from other circuits. All control terminals are supplied by protective extra-low voltage, PELV, thus ensuring protection against electric shock.

Signal relay outputs

– Signal relay 1:

LIVE:

You can connect supply voltages up to 250 VAC.

PELV:

The output is galvanically separated from other circuits. Therefore, you can connect the supply voltage or protective extra-low voltage to the output as desired.

– Signal relay 2:

PELV:

The output is galvanically separated from other circuits. Therefore, you can connect the supply voltage or protective extra-low voltage to the output as desired.

- **Power supply**, terminals N, PE, L or L1, L2, L3, PE.

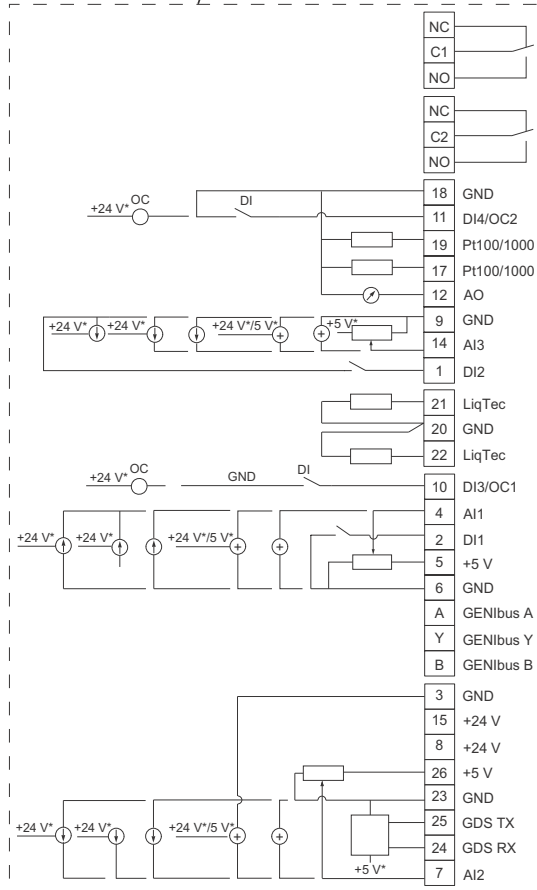
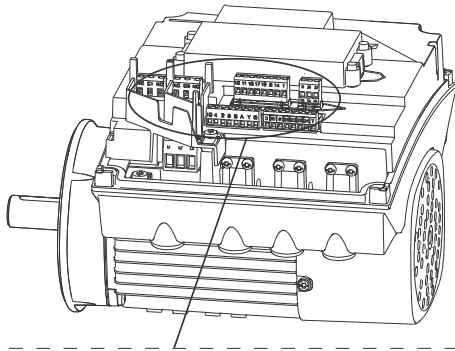

TM05 3509 3512

* If an external supply source is used, there must be a connection to GND.

Fig. 63 Connection terminals, FM 300, option

Terminal	Type	Function
NC	Normally closed contact	Signal relay 1 LIVE or PELV
C1	Common	
NO	Normally open contact	
NC	Normally closed contact	Signal relay 2 PELV only
C2	Common	
NO	Normally open contact	
18	GND	Earth
11	DI4/OC2	Digital input/output, configurable. Open collector: Maximum 24 V resistive or inductive.
19	Pt100/1000 input 2	Pt100/1000 sensor input
17	Pt100/1000 input 1	Pt100/1000 sensor input
12	AO	Analog output: 0-20 mA / 4-20 mA 0-10 V
9	GND	Earth
14	AI3	Analog input: 0-20 mA / 4-20 mA 0-10 V
1	DI2	Digital input, configurable
21	LiqTec sensor input 1	LiqTec sensor input White conductor
20	GND	Earth Brown and black conductors
22	LiqTec sensor input 2	LiqTec sensor input Blue conductor
10	DI3/OC1	Digital input/output, configurable. Open collector: Max. 24 V resistive or inductive.
4	AI1	Analog input: 0-20 mA / 4-20 mA 0.5 - 3.5 V / 0-5 V / 0-10 V
2	DI1	Digital input, configurable
5	+5 V	Supply to potentiometer and sensor
6	GND	Earth
A	GENIbus, A	GENIbus, A (+)
Y	GENIbus, Y	GENIbus, GND
B	GENIbus, B	GENIbus, B (-)
3	GND	Ground
15	+24 V	Supply
8	+24 V	Supply
26	+5 V	Supply to potentiometer and sensor
23	GND	Ground
25	GDS TX	Grundfos Digital Sensor output
24	GDS RX	Grundfos Digital Sensor input
7	AI2	Analog input: 0-20 mA / 4-20 mA 0.5 - 3.5 V / 0-5 V / 0-10 V

Identification of functional module

You can identify the module in one of the following ways:

Grundfos GO

Select the "Fitted modules" menu under "Status".

Pump display

If the pump is fitted with the advanced control panel, select "Fitted modules" menu under "Status".

Motor nameplate

You can identify the fitted module on the motor nameplate. See fig. 64.

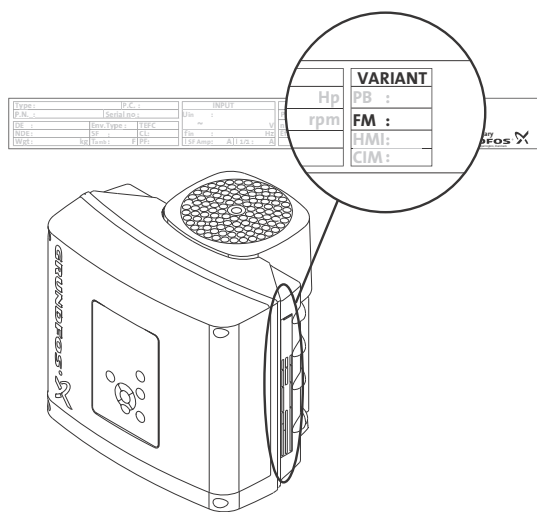

TM06 1889 3314

Fig. 64 Identification of functional module

Variant	Description
FM 300	Advanced functional module

14. Electromagnetic compatibility, EMC

Proper installation

General information

The growing use of electric or electronic controls and electronic equipment including PLCs and computers within all business areas require these products to fulfil the existing standards within electromagnetic compatibility. Make sure that the equipment is mounted properly.

This section deals with these issues.

What is electromagnetic compatibility

Electromagnetic compatibility is the ability of an electric or electronic device to function in a given electromagnetic environment without disturbing the surroundings and without being disturbed by other devices in the surroundings. Electromagnetic compatibility is normally split into emission and immunity.

Emission

Emission is defined as the electric or electromagnetic noise emitted by a device during operation and which can reduce the function of other devices or disturb various radio communications, including radio or TV.

Immunity

Immunity is the ability of a device to function in spite of the presence of electric or electromagnetic noise, such as sparking noise from contactors or high-frequency fields from various transmitters or mobile phones.

E-pumps and electromagnetic compatibility

All Grundfos MLE motors are UL approved, under certain conditions, the Conditions of Acceptability (CoA) and FCC compliant indicating that the product is designed to meet the EMC regulations of the FCC and standards of UL 60730-1.

EMC and UL



All E-pumps are tested according to IEC 61800-3. All E-pumps are fitted with a radio-interference filter and varistors in the mains-supply input to protect the electronics against voltage peaks and noise present in the mains supply (immunity). At the same time, the filter limits the amount of electrical noise which the E-pump emits to the mains supply network (emission). All remaining inputs included in the electronic unit are also protected against peaks and noise which can damage or disturb the function of the unit.

On top of that, the mechanical and electronic designs are made in such a way that the unit can operate sufficiently under a certain level of radiated electromagnetic disturbance.

The limits which the E-pumps are tested against are listed in standard IEC 61800-3.

Where to install E-pumps

You can use all E-pumps with built-in frequency converter motors in both residential areas (first environment) and industrial areas (second environment) within certain limitations.

What is meant by the first and the second environment

The first environment, residential areas, includes establishments directly connected to a low-voltage power supply network which supplies domestic buildings.

The second environment, industrial areas, includes establishments which are not connected to a low-voltage network that supplies domestic buildings.

The level of electromagnetic disturbance can be much higher than in the first environment.

Electromagnetic compatibility and proper installation

With the UL approval, the E-pumps live up to and have been tested to meet specific EMC requirements. This, however, does not mean that E-pumps are immune to all the sources of noise to which they can be exposed in practice. In some installations, the impact may exceed the level to which the product is designed and tested.

Furthermore, unproblematic operation in a noisy environment presupposes that the installation of the E-pump is made properly.

You will find a description of a correct E-pump installation below.

Connection of power supply

Practice shows that large cable loops are often made inside the terminal box to get some "spare cable". Of course, this can be useful. However, with regard to electromagnetic compatibility, it is a poor solution as these cable loops will function as antennas inside the terminal box.

To avoid problems with electromagnetic compatibility, the power supply cable and its individual conductors in the terminal box of the E-pump must be as short as possible. If required, you can establish a spare cable outside the E-pump.

15. Curve charts

How to read the curve charts

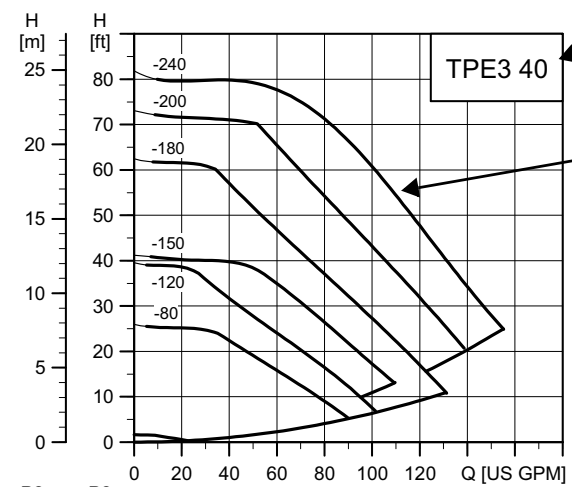

Pump type.

QH curve for the individual single-head pump. The bold curve indicates the recommended performance range.

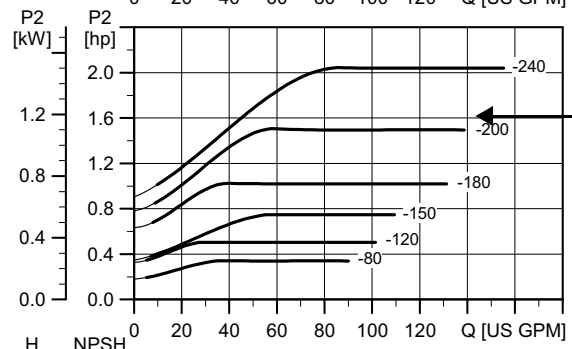

The power curve indicates the pump input power [P2].

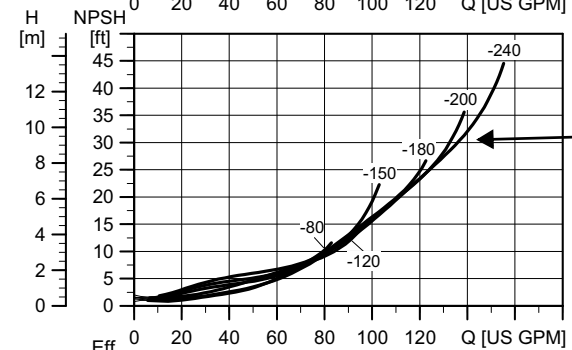

The NPSH (3 %) curve shows the maximum net positive suction head, NPSH, required to ensure that the pump head is not reduced by more than 3 %. The available system pressure at the pump inlet must be according to the NPSH (3 %) curve.

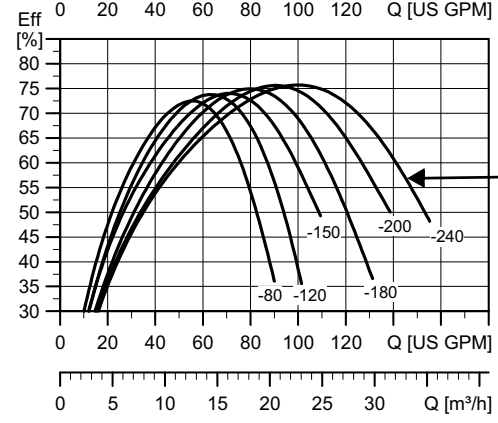

The eta curve shows the pump efficiency.

TM07 3016 3220

Curve conditions

The guidelines below apply to the curves shown on the following pages:

- Tolerances to ISO 9906:2012 Grade 3B.
- The curves apply to the performance of **single-head three-phase pumps**. For other pump versions, please see the exact curves in Grundfos Product Center. See page 99. For other pump versions, the performance may differ for the following reasons:
 - The valve in twin-head pumps may cause losses.
 - Single-phase motors run at lower speed. QH curves of the individual single-head pumps are shown with expected speed of a three-phase motor. For further information, see the tables of technical data on the following pages. The performance of the single-phase motor is slightly reduced. Please refer to Grundfos Product Center for the exact single-phase curves. See page 99.
- Measurements have been made with airless water at a temperature of 68 °F (20 °C).
- The curves apply to a kinematic viscosity of ν equal to 1 mm²/s (1 cSt).
- Due to the risk of overheating, the pump must not run constantly below the minimum flow rate indicated by the bold curves.
- If the pumped liquid density and/or viscosity are higher than those of water, it may be necessary to use a motor with a higher performance.

16. Performance curves and technical data

TPE3, TPE3 D, class 125

TPE3 40

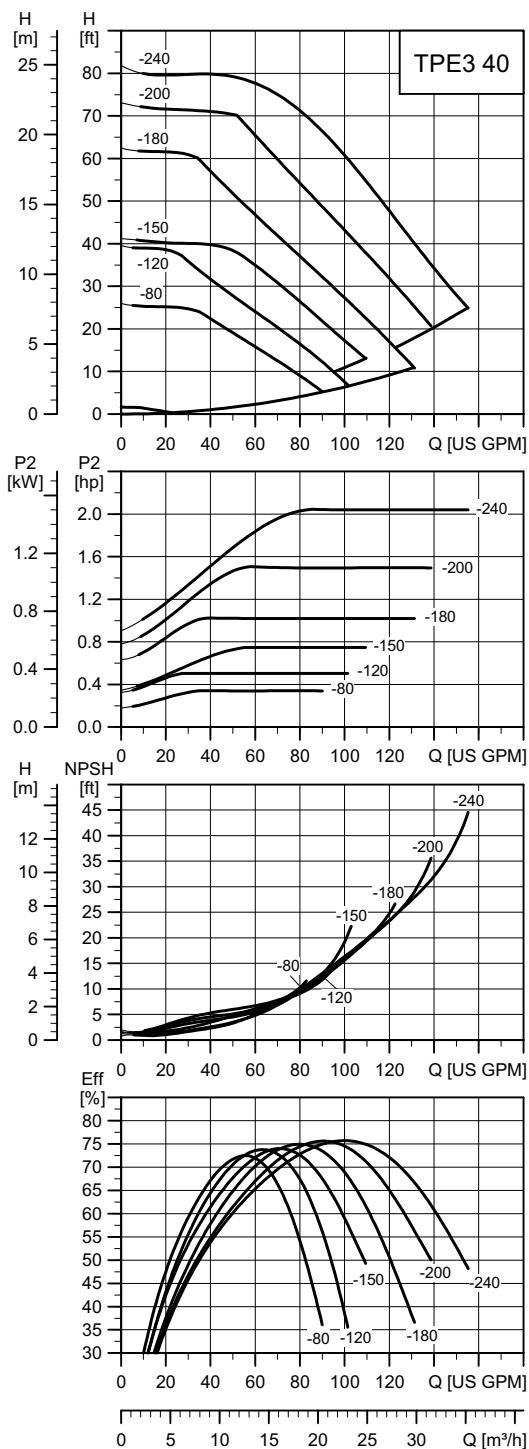

TM07 3016 3220

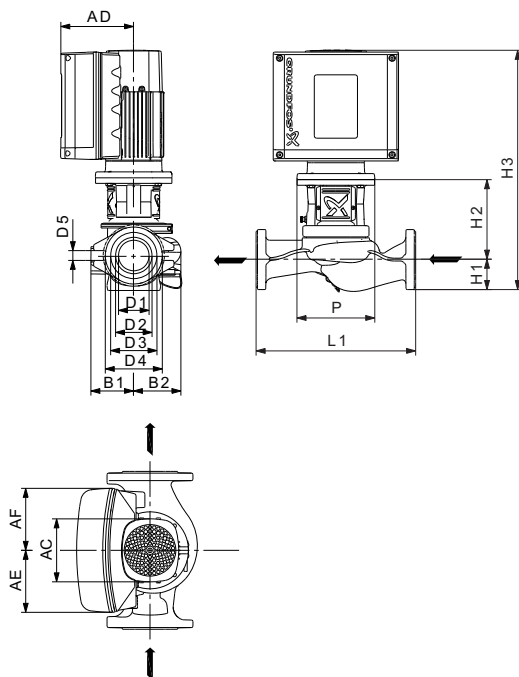

TM07 3099 4918

Dimensions and weights

Pump type	P2 [hp (kW)]	Phase/ Voltage	Dimensions [in (mm)]																Net weight [lbs (kg)]
			AC	AD	AE	AF	B1	B2	D1	D2	D3	D4	D5	H1	H2	H3	L1	P	
TPE3 40-80	0.33 (0.25)	1/60/200-240	4.8 (122)	6.22 (158)	4.17 (106)	4.17 (106)	2.83 (72)	3.23 (82)	1.57 (40)	1.93 (49)	2.36 (60)	3.15 (80)	0.5 (13)	2.56 (65)	6.38 (162)	17.4 (442)	8.50 (216)	6.5 (165)	45.4 (20.6)
		3/60/440-480	4.8 (122)	6.22 (158)	5.28 (134)	5.28 (134)	2.83 (72)	3.23 (82)	1.57 (40)	1.93 (49)	2.36 (60)	3.15 (80)	0.5 (13)	2.56 (65)	6.38 (162)	18.98 (482)	8.50 (216)	6.5 (165)	48.9 (22.2)
TPE3 40-120	0.5 (0.37)	1/60/200-240	4.8 (122)	6.22 (158)	4.17 (106)	4.17 (106)	2.83 (72)	3.23 (82)	1.57 (40)	1.93 (49)	2.36 (60)	3.15 (80)	0.5 (13)	2.56 (65)	6.38 (162)	17.4 (442)	8.50 (216)	6.5 (165)	45.4 (20.6)
		3/60/440-480	4.8 (122)	6.22 (158)	5.28 (134)	5.28 (134)	2.83 (72)	3.23 (82)	1.57 (40)	1.93 (49)	2.36 (60)	3.15 (80)	0.5 (13)	2.56 (65)	6.38 (162)	18.98 (482)	8.50 (216)	6.5 (165)	48.9 (22.2)
TPE3 40-150	0.75 (0.55)	1/60/200-240	4.8 (122)	6.22 (158)	4.17 (106)	4.17 (106)	2.83 (72)	3.23 (82)	1.57 (40)	1.93 (49)	2.36 (60)	3.15 (80)	0.5 (13)	2.56 (65)	6.38 (162)	17.4 (442)	8.50 (216)	6.5 (165)	45.4 (20.6)
		3/60/440-480	4.8 (122)	6.22 (158)	5.28 (134)	5.28 (134)	2.83 (72)	3.23 (82)	1.57 (40)	1.93 (49)	2.36 (60)	3.15 (80)	0.5 (13)	2.56 (65)	6.38 (162)	18.98 (482)	8.50 (216)	6.5 (165)	48.9 (22.2)
	1.5 (1.1)	3/60/200-240	4.8 (122)	6.22 (158)	5.28 (134)	5.28 (134)	2.83 (72)	3.23 (82)	1.57 (40)	1.93 (49)	2.36 (60)	3.15 (80)	0.5 (13)	2.56 (65)	6.38 (162)	18.98 (482)	8.50 (216)	6.5 (165)	50.7 (23.0)
TPE3 40-180	1 (0.75)	1/60/200-240	4.8 (122)	6.22 (158)	4.17 (106)	4.17 (106)	2.83 (72)	3.23 (82)	1.57 (40)	1.93 (49)	2.36 (60)	3.15 (80)	0.5 (13)	2.56 (65)	6.38 (162)	17.4 (442)	8.50 (216)	6.5 (165)	45.4 (20.6)
		3/60/440-480	4.8 (122)	6.22 (158)	5.28 (134)	5.28 (134)	2.83 (72)	3.23 (82)	1.57 (40)	1.93 (49)	2.36 (60)	3.15 (80)	0.5 (13)	2.56 (65)	6.38 (162)	18.98 (482)	8.50 (216)	6.5 (165)	48.9 (22.2)
TPE3 40-200	1.5 (1.1)	1/60/200-240	4.8 (122)	6.22 (158)	4.17 (106)	4.17 (106)	2.83 (72)	3.23 (82)	1.57 (40)	1.93 (49)	2.36 (60)	3.15 (80)	0.5 (13)	2.56 (65)	6.38 (162)	17.4 (442)	8.50 (216)	6.5 (165)	45.4 (20.6)
		3/60/440-480	4.8 (122)	6.22 (158)	5.28 (134)	5.28 (134)	2.83 (72)	3.23 (82)	1.57 (40)	1.93 (49)	2.36 (60)	3.15 (80)	0.5 (13)	2.56 (65)	6.38 (162)	18.98 (482)	8.50 (216)	6.5 (165)	48.9 (22.2)
TPE3 40-240	2 (1.5)	1/60/200-240	4.8 (122)	6.22 (158)	4.17 (106)	4.17 (106)	2.83 (72)	3.23 (82)	1.57 (40)	1.93 (49)	2.36 (60)	3.15 (80)	0.5 (13)	2.56 (65)	6.38 (162)	18.19 (462)	8.50 (216)	6.5 (165)	49.2 (22.3)
		3/60/440-480	4.8 (122)	6.22 (158)	5.28 (134)	5.28 (134)	2.83 (72)	3.23 (82)	1.57 (40)	1.93 (49)	2.36 (60)	3.15 (80)	0.5 (13)	2.56 (65)	6.38 (162)	19.76 (502)	8.50 (216)	6.5 (165)	53.1 (24.1)

Technical data

Flow range: [US GPM (m ³ /hr)]	5.72 (1.3) - 158.4 (36)	Max ambient air temperature: [°F (°C)]	122 (50) - 1/60/200-240 122 (50) - 3/60/440-480 104 (40) - 3/60/200-240
Nominal head range: [ft (m)]	17.7 (5.4) - 61 (18.6)	Gross weight: [lbs (kg)]	64.6 (29.3) - 71.0 (32.2)
Maximum working pressure: [psi (bar)]	232 (16)	Motors:	MLE permanent magnet (FM300)
Temperature range: [°F (°C)]	BQQE: -13 (-25) - +248 (120)	Flanges:	1 1/2" 2 bolt with (2) .5" dia. holes

TPE3 50

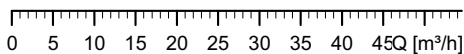
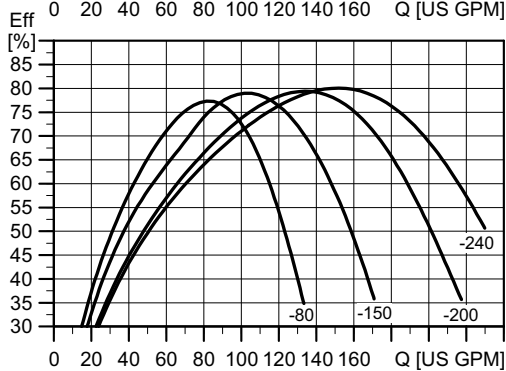
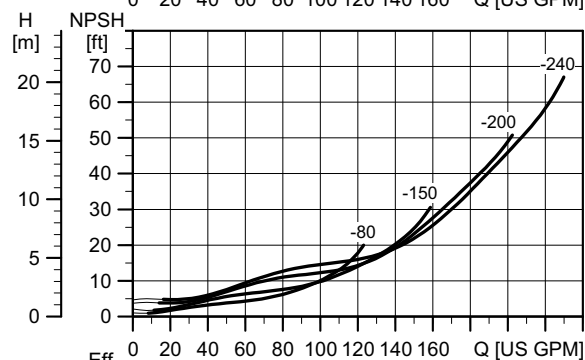
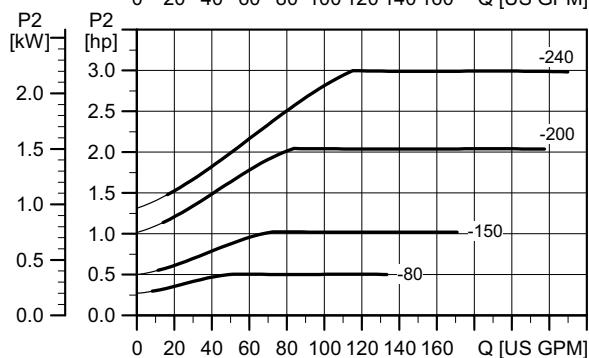
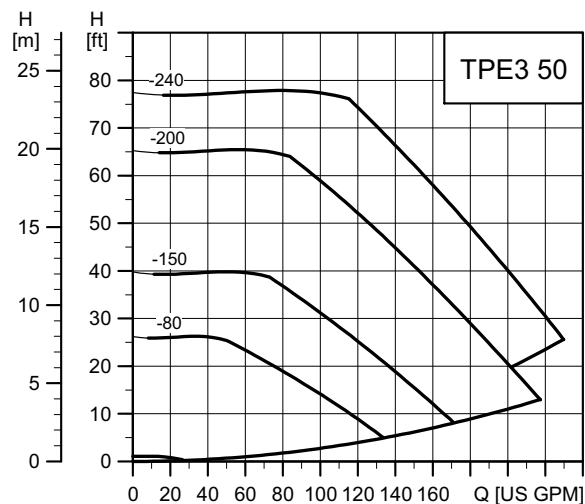

TM07 3017 3220

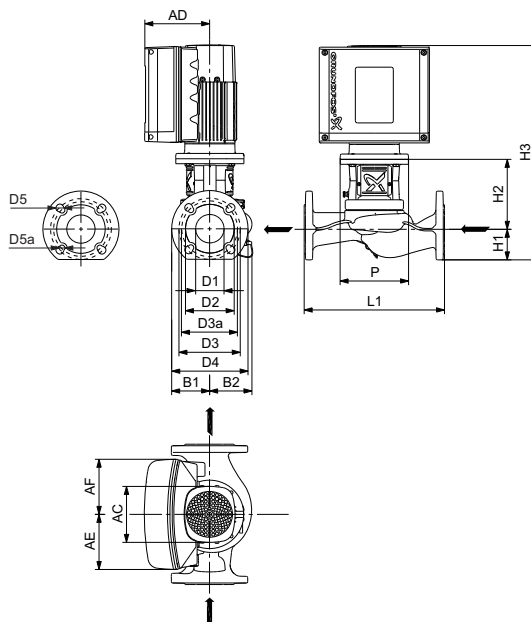

TM07 3100 4918

Dimensions and weights

Pump type	P2 [hp (kW)]	Phase/Voltage	Dimensions [in (mm)]																	Net weight [lbs (kg)]	
			AC	AD	AE	AF	B1	B2	D1	D2	D3	D3a	D4	D5	D5a	H1	H2	H3	L1		P
TPE3 50-80	0.5 (0.37)	1/60/200-240	4.8 (122)	6.22 (158)	4.17 (106)	4.17 (106)	2.95 (75)	3.58 (91)	1.97 (50)	3.9 (99)	4.92 (125)	4.33 (110)	6.5 (165)	0.75 (19)	0.55 (14)	2.83 (72)	6.38 (162)	17.68 (449)	11.02 (280)	6.5 (165)	56.0 (25.4)
		3/60/440-480	4.8 (122)	6.22 (158)	5.28 (134)	5.28 (134)	2.95 (75)	3.58 (91)	1.97 (50)	3.9 (99)	4.92 (125)	4.33 (110)	6.5 (165)	0.75 (19)	0.55 (14)	2.83 (72)	6.38 (162)	19.25 (489)	11.02 (280)	6.5 (165)	59.7 (27.1)
TPE3 50-150	1 (0.75)	1/60/200-240	4.8 (122)	6.22 (158)	4.17 (106)	4.17 (106)	2.95 (75)	3.58 (91)	1.97 (50)	3.9 (99)	4.92 (125)	4.33 (110)	6.5 (165)	0.75 (19)	0.55 (14)	2.83 (72)	6.38 (162)	17.68 (449)	11.02 (280)	6.5 (165)	56.0 (25.4)
		3/60/440-480	4.8 (122)	6.22 (158)	5.28 (134)	5.28 (134)	2.95 (75)	3.58 (91)	1.97 (50)	3.9 (99)	4.92 (125)	4.33 (110)	6.5 (165)	0.75 (19)	0.55 (14)	2.83 (72)	6.38 (162)	19.25 (489)	11.02 (280)	6.5 (165)	59.7 (27.1)
TPE3 50-200	1.5 (1.1)	3/60/200-240	4.8 (122)	6.22 (158)	5.28 (134)	5.28 (134)	2.95 (75)	3.58 (91)	1.97 (50)	3.9 (99)	4.92 (125)	4.33 (110)	6.5 (165)	0.75 (19)	0.55 (14)	2.83 (72)	6.38 (162)	19.25 (489)	11.02 (280)	6.5 (165)	61.5 (27.9)
		1/60/200-240	4.8 (122)	6.22 (158)	4.17 (106)	4.17 (106)	2.95 (75)	3.58 (91)	1.97 (50)	3.9 (99)	4.92 (125)	4.33 (110)	6.5 (165)	0.75 (19)	0.55 (14)	2.83 (72)	6.38 (162)	18.46 (469)	11.02 (280)	6.5 (165)	59.7 (27.1)
TPE3 50-240	2 (1.5)	3/60/440-480	4.8 (122)	6.22 (158)	5.28 (134)	5.28 (134)	2.95 (75)	3.58 (91)	1.97 (50)	3.9 (99)	4.92 (125)	4.33 (110)	6.5 (165)	0.75 (19)	0.55 (14)	2.83 (72)	6.38 (162)	20.04 (509)	11.02 (280)	6.5 (165)	63.9 (29.0)
		1/60/200-240	4.8 (122)	6.22 (158)	4.17 (106)	4.17 (106)	2.95 (75)	3.58 (91)	1.97 (50)	3.9 (99)	4.92 (125)	4.33 (110)	6.5 (165)	0.75 (19)	0.55 (14)	2.83 (72)	6.38 (162)	20.04 (509)	11.02 (280)	6.5 (165)	65.7 (29.8)

Technical data

Flow range: [US GPM (m ³ /hr)]	7.0 (1.6) - 233.2 (53)	Max ambient air temperature: [°F (°C)]	122 (50) - 1/60/200-240 122 (50) - 3/60/440-480 104 (40) - 3/60/200-240
Nominal head range: [ft (m)]	12.8 (3.9) - 64.3 (19.6)	Gross weight: [lbs (kg)]	72.5 (32.9) - 82.6 (37.45)
Maximum working pressure: [psi (bar)]	232 (16)	Motors:	MLE Permanent magnet (FM300)
Temperature range: [°F (°C)]	BQQE: -13 (-25) - +248 (120)	Flanges:	2" 4 bolt with (4) .75" dia. holes

TPE3, TPE3 D 65

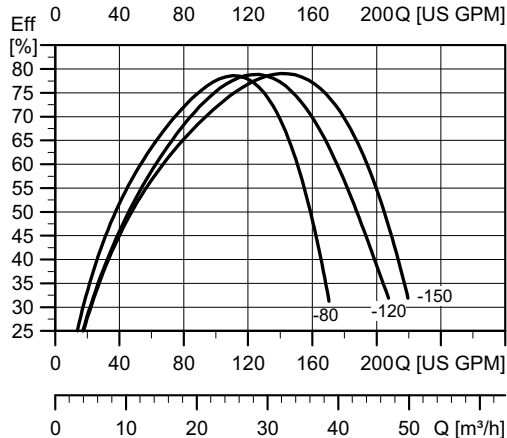
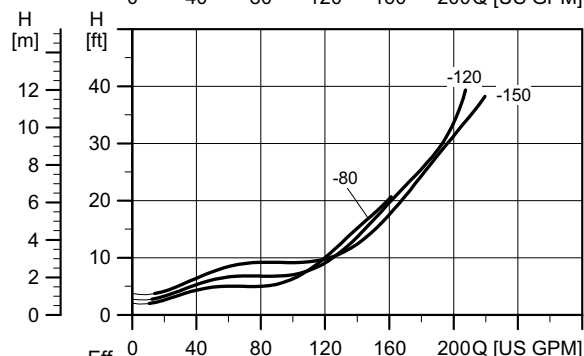
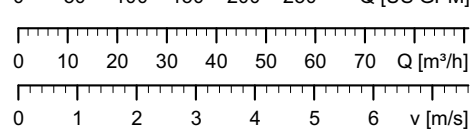
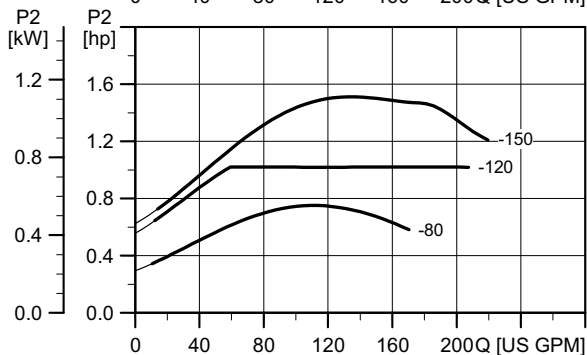
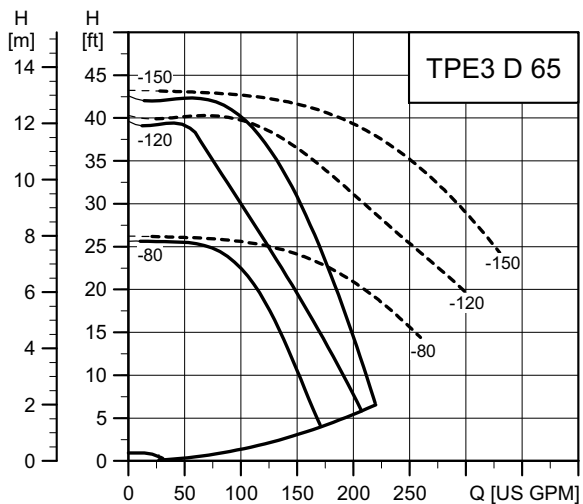
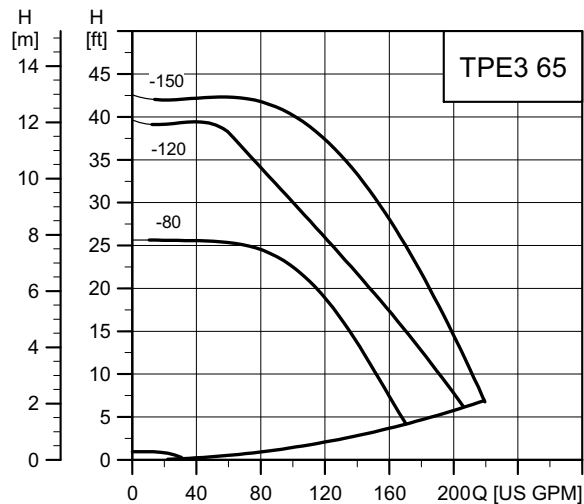

TM07 3019 3220

TM07 3018 3220

Note: The dotted QH curves apply to TPE3 D in parallel operation.

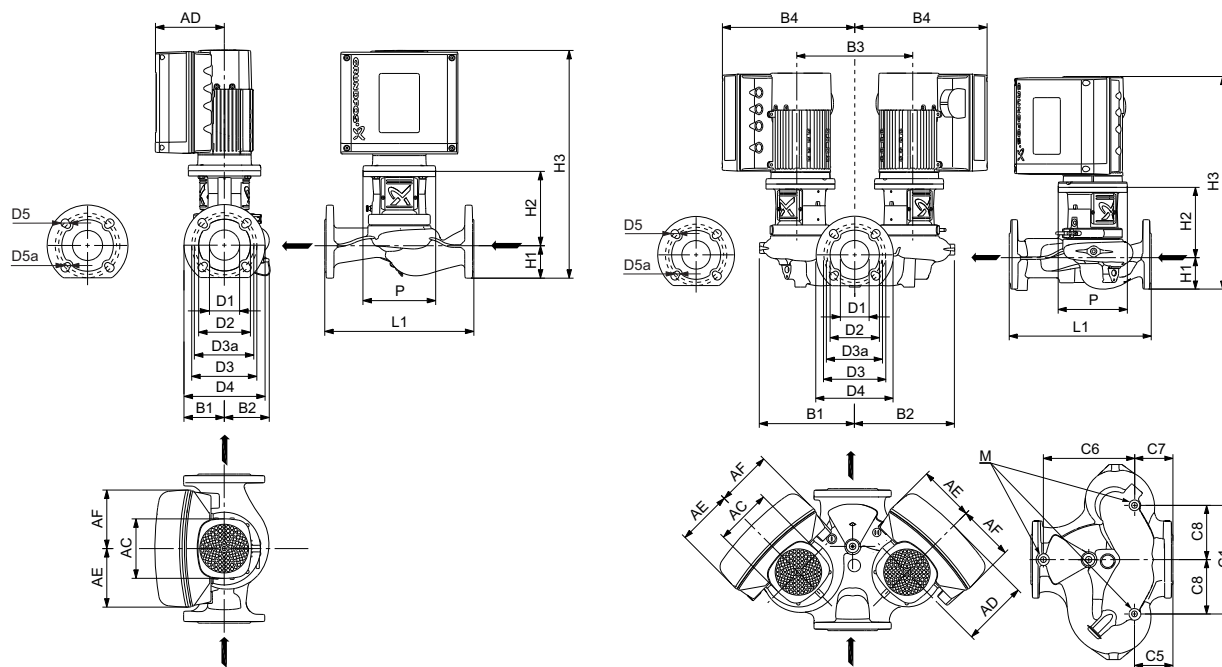

TM07 3100 4918; TM07 3102 4918

Dimensions and weights

Pump type	P2 [hp (kW)]	Dual head	Phase/Voltage	Dimensions [in (mm)]																	Net weight [lbs (kg)]	
				AC	AD	AE	AF	B1	B2	D1	D2	D3	D3a	D4	D5	D5a	H1	H2	H3	L1		P
TPE3 (D) 65-80	0.75 (0.55)	D	1/60/200-240	4.8 (122)	6.22 (158)	4.17 (106)	4.17 (106)	3.19 (81)	4.02 (102)	2.56 (65)	4.65 (118)	5.51 (140)	5 (127)	7.28 (185)	0.75 (19)	0.63 (16)	2.91 (74)	6.65 (169)	18.03 (458)	13.4 (340)	6.5 (165)	61.7 (28.0)
			3/60/440-480	4.8 (122)	6.22 (158)	5.28 (134)	5.28 (134)	3.19 (81)	4.02 (102)	2.56 (65)	4.65 (118)	5.51 (140)	5 (127)	7.28 (185)	0.75 (19)	0.63 (16)	2.91 (74)	6.65 (169)	19.61 (498)	13.4 (340)	6.5 (165)	65.5 (29.7)
			1/60/200-240	4.8 (122)	6.22 (158)	4.17 (106)	4.17 (106)	8.98 (228)	9.45 (240)	2.56 (65)	4.69 (119)	5.71 (145)	5.12 (130)	7.28 (185)	0.75 (19)	0.55 (14)	3.07 (78)	6.65 (169)	18.19 (462)	13.4 (340)	6.5 (165)	116.0 (52.6)
			3/60/440-480	4.8 (122)	6.22 (158)	5.28 (134)	5.28 (134)	8.98 (228)	9.45 (240)	2.56 (65)	4.69 (119)	5.71 (145)	5.12 (130)	7.28 (185)	0.75 (19)	0.55 (14)	3.07 (78)	6.65 (169)	19.76 (502)	13.4 (340)	6.5 (165)	123.2 (55.9)
TPE3 (D) 65-120	1 (0.75)	D	1/60/200-240	4.8 (122)	6.22 (158)	4.17 (106)	4.17 (106)	3.19 (81)	4.02 (102)	2.56 (65)	4.65 (118)	5.51 (140)	5 (127)	7.28 (185)	0.75 (19)	0.63 (16)	2.91 (74)	6.65 (169)	18.03 (458)	13.4 (340)	6.5 (165)	61.7 (28.0)
			3/60/440-480	4.8 (122)	6.22 (158)	5.28 (134)	5.28 (134)	3.19 (81)	4.02 (102)	2.56 (65)	4.65 (118)	5.51 (140)	5 (127)	7.28 (185)	0.75 (19)	0.63 (16)	2.91 (74)	6.65 (169)	19.61 (498)	13.4 (340)	6.5 (165)	65.5 (29.7)
			1/60/200-240	4.8 (122)	6.22 (158)	4.17 (106)	4.17 (106)	8.98 (228)	9.45 (240)	2.56 (65)	4.69 (119)	5.71 (145)	5.12 (130)	7.28 (185)	0.75 (19)	0.55 (14)	3.07 (78)	6.65 (169)	18.19 (462)	13.4 (340)	6.5 (165)	116.0 (52.6)
			3/60/440-480	4.8 (122)	6.22 (158)	5.28 (134)	5.28 (134)	8.98 (228)	9.45 (240)	2.56 (65)	4.69 (119)	5.71 (145)	5.12 (130)	7.28 (185)	0.75 (19)	0.55 (14)	3.07 (78)	6.65 (169)	19.76 (502)	13.4 (340)	6.5 (165)	123.2 (55.9)
TPE3 (D) 65-150	1.5 (1.1)	D	1/60/200-240	4.8 (122)	6.22 (158)	4.17 (106)	4.17 (106)	3.19 (81)	4.02 (102)	2.56 (65)	4.65 (118)	5.51 (140)	5 (127)	7.28 (185)	0.75 (19)	0.63 (16)	2.91 (74)	6.65 (169)	18.03 (458)	13.4 (340)	6.5 (165)	63.5 (28.8)
			3/60/440-480	4.8 (122)	6.22 (158)	5.28 (134)	5.28 (134)	3.19 (81)	4.02 (102)	2.56 (65)	4.65 (118)	5.51 (140)	5 (127)	7.28 (185)	0.75 (19)	0.63 (16)	2.91 (74)	6.65 (169)	19.61 (498)	13.4 (340)	6.5 (165)	67.2 (30.5)
			3/60/200-240	4.8 (122)	6.22 (158)	5.28 (134)	5.28 (134)	3.19 (81)	4.02 (102)	2.56 (65)	4.69 (119)	5.71 (145)	5.12 (130)	7.28 (185)	0.75 (19)	0.63 (16)	2.91 (74)	6.65 (169)	19.61 (498)	13.4 (340)	6.5 (165)	67.2 (30.5)
			1/60/200-240	4.8 (122)	6.22 (158)	4.17 (106)	4.17 (106)	8.98 (228)	9.45 (240)	2.56 (65)	4.69 (119)	5.71 (145)	5.12 (130)	7.28 (185)	0.75 (19)	0.55 (14)	3.07 (78)	6.65 (169)	18.19 (462)	13.4 (340)	6.5 (165)	119.3 (54.1)
TPE3 (D) 65-180	2 (1.5)	D	3/60/440-480	4.8 (122)	6.22 (158)	5.28 (134)	5.28 (134)	8.98 (228)	9.45 (240)	2.56 (65)	4.69 (119)	5.71 (145)	5.12 (130)	7.28 (185)	0.75 (19)	0.55 (14)	3.07 (78)	6.65 (169)	19.76 (502)	13.4 (340)	6.5 (165)	126.8 (57.5)
			3/60/200-240	4.8 (122)	6.22 (158)	5.28 (134)	5.28 (134)	8.98 (228)	9.45 (240)	2.56 (65)	4.69 (119)	5.71 (145)	5.12 (130)	7.28 (185)	0.75 (19)	0.55 (14)	3.07 (78)	6.65 (169)	19.76 (502)	13.4 (340)	6.5 (165)	126.8 (57.5)
			1/60/200-240	4.8 (122)	6.22 (158)	4.17 (106)	4.17 (106)	8.98 (228)	9.45 (240)	2.56 (65)	4.69 (119)	5.71 (145)	5.12 (130)	7.28 (185)	0.75 (19)	0.55 (14)	3.07 (78)	6.65 (169)	18.98 (482)	13.4 (340)	6.5 (165)	123.7 (56.1)
			3/60/440-480	4.8 (122)	6.22 (158)	5.28 (134)	5.28 (134)	8.98 (228)	9.45 (240)	2.56 (65)	4.69 (119)	5.71 (145)	5.12 (130)	7.28 (185)	0.75 (19)	0.55 (14)	3.07 (78)	6.65 (169)	20.55 (522)	13.4 (340)	6.5 (165)	131.6 (59.7)
TPE3 (D) 65-200	3 (2.2)	D	3/60/440-480	4.8 (122)	6.22 (158)	5.28 (134)	5.28 (134)	8.98 (228)	9.45 (240)	2.56 (65)	4.69 (119)	5.71 (145)	5.12 (130)	7.28 (185)	0.75 (19)	0.55 (14)	3.07 (78)	6.65 (169)	20.55 (522)	13.4 (340)	6.5 (165)	135.1 (61.3)

Pump Type	P2 [hp (kW)]	Phase/Voltage	Dimensions [in (mm)]							
			B3	B4	C1	C5	C6	C7	C8	M
TPE3 D 65-80	0.75 (0.55)	1/60/200-240	10.24 (260)	12.48 (317)	10.24 (260)	3.62 (92)	8.58 (218)	3.62 (92)	5.12 (130)	M12
		3/60/440-480	10.24 (260)	13.27 (337)	10.24 (260)	3.62 (92)	8.58 (218)	3.62 (92)	5.12 (130)	M12
TPE3 D 65-120	1 (0.75)	1/60/200-240	10.24 (260)	12.48 (317)	10.24 (260)	3.62 (92)	8.58 (218)	3.62 (92)	5.12 (130)	M12
		3/60/440-480	10.24 (260)	13.27 (337)	10.24 (260)	3.62 (92)	8.58 (218)	3.62 (92)	5.12 (130)	M12
TPE3 D 65-150	1.5 (1.1)	1/60/200-240	10.24 (260)	12.48 (317)	10.24 (260)	3.62 (92)	8.58 (218)	3.62 (92)	5.12 (130)	M12
		3/60/440-480	10.24 (260)	13.27 (337)	10.24 (260)	3.62 (92)	8.58 (218)	3.62 (92)	5.12 (130)	M12
TPE3 D 65-180	2 (1.5)	1/60/200-240	10.24 (260)	12.48 (317)	10.24 (260)	3.62 (92)	8.58 (218)	3.62 (92)	5.12 (130)	M12
		3/60/440-480	10.24 (260)	13.27 (337)	10.24 (260)	3.62 (92)	8.58 (218)	3.62 (92)	5.12 (130)	M12
TPE3 D 65-200	3 (2.2)	3/60/440-480	10.24 (260)	13.27 (337)	10.24 (260)	3.62 (92)	8.58 (218)	3.62 (92)	5.12 (130)	M12

Technical data

Flow range: [US GPM (m ³ /hr)]	8.8 (2.0) - 264(60)	Max ambient air temperature: [°F (°C)]	122 (50) - 1/60/200-240 122 (50) - 3/60/440-480 104 (40) - 3/60/200-240
Nominal head range: [ft (m)]	11.2 (3.4) - 47.9 (14.6)	Gross weight: [lbs (kg)]	81.6 (37) - 166.7 (75.6)
Maximum working pressure: [psi (bar)]	232 (16)	Motors:	MLE Permanent magnet (FM300)
Temperature range: [°F (°C)]	BQQE: -13 (-25) - +248 (120)	Flanges:	2.5" 4 bolt with (4) .75" dia. holes

TPE3, TPE3 D 80

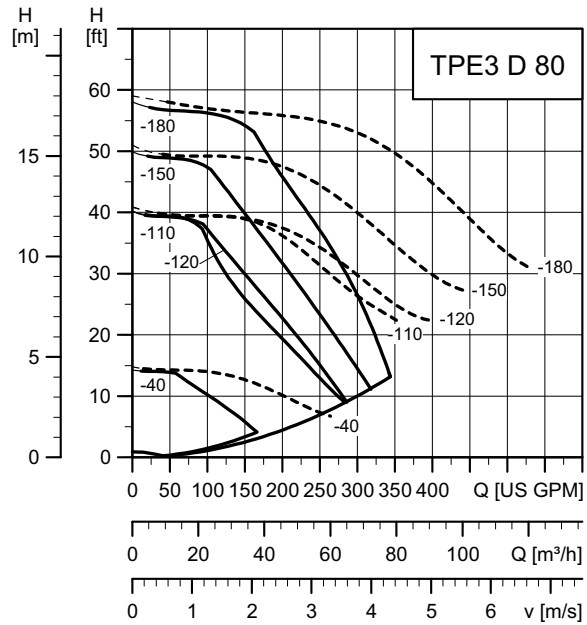
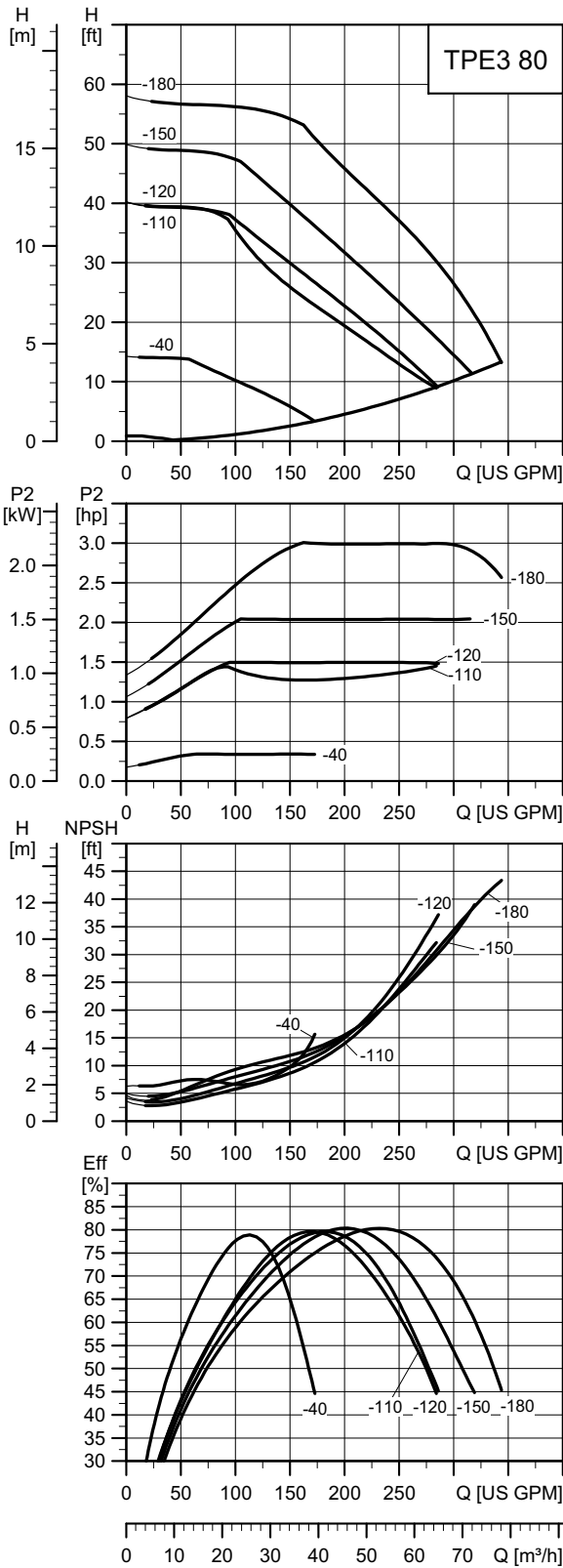

TM07 3021 3220

TM07 3020 3220

Note: The dotted QH curves apply to TPE3 D in parallel operation.

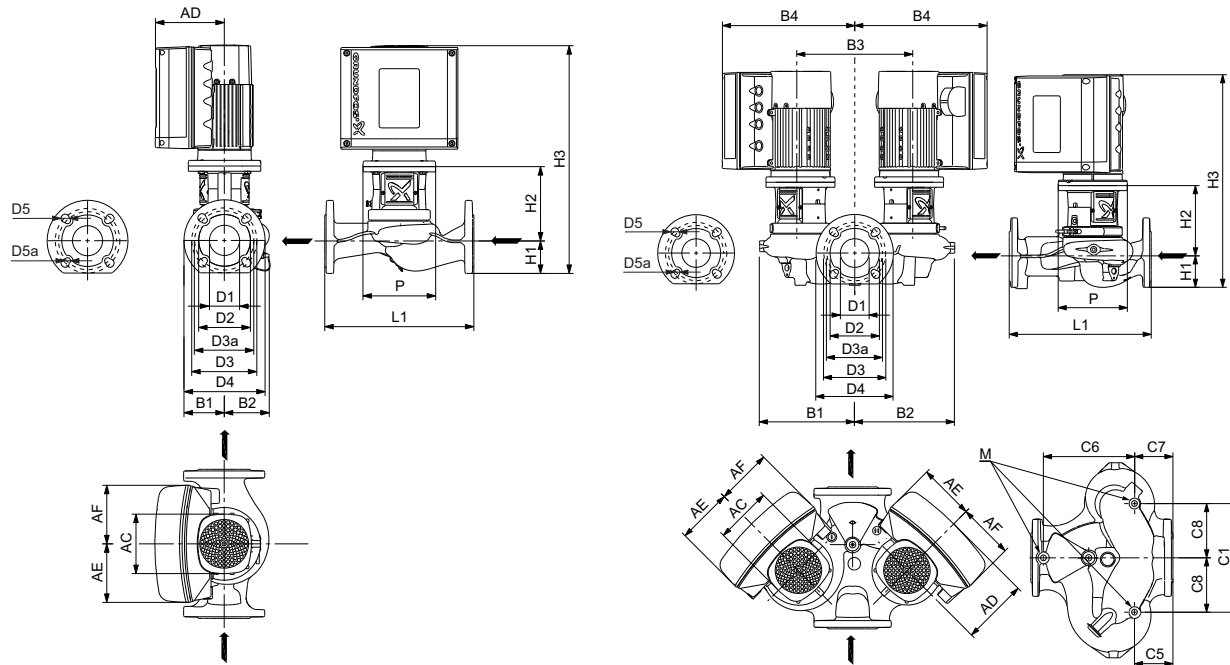

TM07 3100 4918; TM07 3102 4918

Dimensions and weights

Pump type	P2 [hp (kW)]	Dual head	Phase/Voltage	Dimensions [in (mm)]																	Net weight [lbs (kg)]	
				AC	AD	AE	AF	B1	B2	D1	D2	D3	D3a	D4	D5	D5a	H1	H2	H3	L1		P
TPE3 (D) 80-40	0.33 (0.25)	D	1/60/200-240	4.8 (122)	6.22 (158)	4.17 (106)	4.17 (106)	3.82 (97)	4.84 (123)	3.15 (80)	5.2 (132)	5.91 (150)	-	7.87 (200)	0.75 (19)	-	3.7 (94)	6.93 (176)	19.09 (485)	14.2 (360)	6.5 (165)	67.2 (30.5)
			3/60/440-480	4.8 (122)	6.22 (158)	5.28 (134)	5.28 (134)	3.82 (97)	4.84 (123)	3.15 (80)	5.2 (132)	5.91 (150)	-	7.87 (200)	0.75 (19)	-	3.7 (94)	6.93 (176)	20.67 (525)	14.2 (360)	6.5 (165)	71.0 (32.2)
			1/60/200-240	4.8 (122)	6.22 (158)	4.17 (106)	4.17 (106)	9.61 (244)	10 (254)	3.15 (80)	5.04 (128)	6.3 (160)	5.91 (150)	7.87 (200)	0.75 (19)	-	3.82 (97)	6.93 (176)	19.21 (488)	14.2 (360)	6.5 (165)	131.6 (59.7)
			3/60/440-480	4.8 (122)	6.22 (158)	5.28 (134)	5.28 (134)	9.61 (244)	10 (254)	3.15 (80)	5.04 (128)	6.3 (160)	5.91 (150)	7.87 (200)	0.75 (19)	-	3.82 (97)	6.93 (176)	20.79 (528)	14.2 (360)	6.5 (165)	139.3 (63.2)
TPE3 (D) 80-110	1.5 (1.1)	D	3/60/200-240	4.8 (122)	6.22 (158)	5.28 (134)	5.28 (134)	3.82 (97)	4.84 (123)	3.15 (80)	5.2 (132)	5.91 (150)	-	7.87 (200)	0.75 (19)	-	3.7 (94)	6.93 (176)	20.67 (525)	14.2 (360)	6.5 (165)	72.8 (33.0)
			1/60/200-240	4.8 (122)	6.22 (158)	5.28 (134)	5.28 (134)	9.61 (244)	10 (254)	3.15 (80)	5.04 (128)	6.3 (160)	5.91 (150)	7.87 (200)	0.75 (19)	-	3.82 (97)	6.93 (176)	20.79 (528)	14.2 (360)	6.5 (165)	142.6 (64.7)
			1/60/200-240	4.8 (122)	6.22 (158)	4.17 (106)	4.17 (106)	3.82 (97)	4.84 (123)	3.15 (80)	5.2 (132)	5.91 (150)	-	7.87 (200)	0.75 (19)	-	3.7 (94)	6.93 (176)	19.09 (485)	14.2 (360)	6.5 (165)	69.0 (31.3)
			3/60/440-480	4.8 (122)	6.22 (158)	5.28 (134)	5.28 (134)	9.61 (244)	10 (254)	3.15 (80)	5.04 (128)	6.3 (160)	5.91 (150)	7.87 (200)	0.75 (19)	-	3.82 (97)	6.93 (176)	20.79 (528)	14.2 (360)	6.5 (165)	142.6 (64.7)
TPE3 (D) 80-120	1.5 (1.1)	D	1/60/200-240	4.8 (122)	6.22 (158)	4.17 (106)	4.17 (106)	3.82 (97)	4.84 (123)	3.15 (80)	5.2 (132)	5.91 (150)	-	7.87 (200)	0.75 (19)	-	3.7 (94)	6.93 (176)	19.09 (485)	14.2 (360)	6.5 (165)	69.0 (31.3)
			3/60/440-480	4.8 (122)	6.22 (158)	5.28 (134)	5.28 (134)	3.82 (97)	4.84 (123)	3.15 (80)	5.2 (132)	5.91 (150)	-	7.87 (200)	0.75 (19)	-	3.7 (94)	6.93 (176)	20.67 (525)	14.2 (360)	6.5 (165)	72.8 (33.0)
			1/60/200-240	4.8 (122)	6.22 (158)	4.17 (106)	4.17 (106)	9.61 (244)	10 (254)	3.15 (80)	5.04 (128)	6.3 (160)	5.91 (150)	7.87 (200)	0.75 (19)	-	3.82 (97)	6.93 (176)	19.21 (488)	14.2 (360)	6.5 (165)	135.1 (61.3)
			3/60/440-480	4.8 (122)	6.22 (158)	5.28 (134)	5.28 (134)	9.61 (244)	10 (254)	3.15 (80)	5.04 (128)	6.3 (160)	5.91 (150)	7.87 (200)	0.75 (19)	-	3.82 (97)	6.93 (176)	20.79 (528)	14.2 (360)	6.5 (165)	142.6 (64.7)
TPE3 (D) 80-150	2 (1.5)	D	1/60/200-240	4.8 (122)	6.22 (158)	4.17 (106)	4.17 (106)	3.82 (97)	4.84 (123)	3.15 (80)	5.2 (132)	5.91 (150)	-	7.87 (200)	0.75 (19)	-	3.7 (94)	6.93 (176)	19.88 (505)	14.2 (360)	6.5 (165)	72.8 (33.0)
			3/60/440-480	4.8 (122)	6.22 (158)	5.28 (134)	5.28 (134)	3.82 (97)	4.84 (123)	3.15 (80)	5.2 (132)	5.91 (150)	-	7.87 (200)	0.75 (19)	-	3.7 (94)	6.93 (176)	21.46 (545)	14.2 (360)	6.5 (165)	76.5 (34.7)
			3/60/200-240	4.8 (122)	6.22 (158)	5.28 (134)	5.28 (134)	3.82 (97)	4.84 (123)	3.15 (80)	5.2 (132)	5.91 (150)	-	7.87 (200)	0.75 (19)	-	3.7 (94)	6.93 (176)	21.46 (545)	14.2 (360)	6.5 (165)	76.5 (34.7)
			1/60/200-240	4.8 (122)	6.22 (158)	4.17 (106)	4.17 (106)	9.61 (244)	10 (254)	3.15 (80)	5.04 (128)	6.3 (160)	5.91 (150)	7.87 (200)	0.75 (19)	-	3.82 (97)	6.93 (176)	20 (508)	14.2 (360)	6.5 (165)	142.9 (64.8)
TPE3 (D) 80-180	3 (2.2)	D	3/60/440-480	4.8 (122)	6.22 (158)	5.28 (134)	5.28 (134)	3.82 (97)	4.84 (123)	3.15 (80)	5.2 (132)	5.91 (150)	-	7.87 (200)	0.75 (19)	-	3.7 (94)	6.93 (176)	21.46 (545)	14.2 (360)	6.5 (165)	79.6 (36.1)
			3/60/200-240	7.53 (191.3)	7.91 (201)	5.73 (145.5)	5.73 (145.5)	3.82 (97)	4.84 (123)	3.15 (80)	5.2 (132)	5.91 (150)	-	7.87 (200)	0.75 (19)	-	3.7 (94)	6.93 (176)	24.02 (610)	14.2 (360)	6.5 (165)	100.0 (45.4)
			3/60/440-480	4.8 (122)	6.22 (158)	5.28 (134)	5.28 (134)	9.61 (244)	10 (254)	3.15 (80)	5.04 (128)	6.3 (160)	5.91 (150)	7.87 (200)	0.75 (19)	-	3.82 (97)	6.93 (176)	21.57 (548)	14.2 (360)	6.5 (165)	156.3 (70.9)
			3/60/200-240	7.53 (191.3)	7.91 (201)	5.73 (145.5)	5.73 (145.5)	9.61 (244)	10 (254)	3.15 (80)	5.04 (128)	6.3 (160)	5.91 (150)	7.87 (200)	0.75 (19)	-	3.82 (97)	6.93 (176)	24.13 (613)	14.2 (360)	6.5 (165)	197.3 (89.5)

Pump Type	P2 [hp (kW)]	Phase/Voltage	Dimensions [in (mm)]							
			B3	B4	C1	C5	C6	C7	C8	M
TPE3 D 80-40	0.33 (0.25)	1/60/200-240	10.24 (260)	12.48 (317)	10.24 (260)	4.02 (102)	8.58 (218)	4.02 (102)	5.12 (130)	M12
		3/60/440-480	10.24 (260)	13.27 (337)	10.24 (260)	4.02 (102)	8.58 (218)	4.02 (102)	5.12 (130)	M12
TPE3 D 80-110	1.5 (1.1)	3/60/200-240	10.24 (260)	13.27 (337)	10.24 (260)	4.02 (102)	8.58 (218)	4.02 (102)	5.12 (130)	M12
TPE3 D 80-120	1.5 (1.1)	1/60/200-240	10.24 (260)	12.48 (317)	10.24 (260)	4.02 (102)	8.58 (218)	4.02 (102)	5.12 (130)	M12
		3/60/440-480	10.24 (260)	13.27 (337)	10.24 (260)	4.02 (102)	8.58 (218)	4.02 (102)	5.12 (130)	M12
TPE3 D 80-150	2 (1.5)	1/60/200-240	10.24 (260)	12.48 (317)	10.24 (260)	4.02 (102)	8.58 (218)	4.02 (102)	5.12 (130)	M12
		3/60/440-480	10.24 (260)	13.27 (337)	10.24 (260)	4.02 (102)	8.58 (218)	4.02 (102)	5.12 (130)	M12
		3/60/200-240	10.24 (260)	13.27 (337)	10.24 (260)	4.02 (102)	8.58 (218)	4.02 (102)	5.12 (130)	M12
TPE3 D 80-180	3 (2.2)	3/60/440-480	10.24 (260)	13.27 (337)	10.24 (260)	4.02 (102)	8.58 (218)	4.02 (102)	5.12 (130)	M12
		3/60/200-240	10.24 (260)	26.06 (662)	10.24 (260)	4.02 (102)	8.58 (218)	4.02 (102)	5.12 (130)	M12

Technical data

Flow range: [US GPM (m ³ /hr)]	11 (2.5) - 352 (80)	Max ambient air temperature: [°F (°C)]	122 (50) - 1/60/200-240 122 (50) - 3/60/440-480 104 (40) - 3/60/200-240
Nominal head range: [ft (m)]	9.2 (2.8) - 42 (12.8)	Gross weight: [lbs (kg)]	87.3 (39.6) - 187.8 (85.2)
Maximum working pressure: [psi (bar)]	232 (16)	Motors:	MLE Permanent magnet (FM300)
Temperature range: [°F (°C)]	BQQE: -13 (-25) - +248 (120)	Flanges:	3" 4 bolt with (4) .75" dia. holes

17. Weights and shipping volume

Pump type	Connection		Weights				Shipping volume [ft ³ (m ³)]	
	D1 _D	D1 _S	Net [lb (kg)]		Gross [lb (kg)]		TPE3	TPE3 D
			TPE3	TPE3 D	TPE3	TPE3 D		
TPE3 40-80	ANSI 1.5"	ANSI 1.5"	55 (25)		73 (33)		1 (0.035)	
TPE3 40-120	ANSI 1.5"	ANSI 1.5"	55 (25)		73 (33)		1 (0.035)	
TPE3 40-150	ANSI 1.5"	ANSI 1.5"	55 (25)		73 (33)		1 (0.035)	
TPE3 40-180	ANSI 1.5"	ANSI 1.5"	55 (25)		73 (33)		1 (0.035)	
TPE3 40-200	ANSI 1.5"	ANSI 1.5"	55 (25)		73 (33)		1 (0.035)	
TPE3 40-240	ANSI 1.5"	ANSI 1.5"	60 (27)		77 (35)		1 (0.035)	
TPE3 50-80	ANSI 2"	ANSI 2"	60 (27)		77 (35)		1 (0.036)	
TPE3 50-150	ANSI 2"	ANSI 2"	60 (27)		77 (35)		1 (0.036)	
TPE3 50-200	ANSI 2"	ANSI 2"	64 (29)		82 (37)		1 (0.036)	
TPE3 50-240	ANSI 2"	ANSI 2"	66 (30)		84 (38)		1 (0.036)	
TPE3, TPE3 D 65-80	ANSI 2.5"	ANSI 2.5"	64 (29)	115 (52)	84 (38)	134 (61)	2 (0.044)	4 (0.117)
TPE3, TPE3 D 65-120	ANSI 2.5"	ANSI 2.5"	64 (29)	115 (52)	84 (38)	134 (61)	2 (0.044)	4 (0.117)
TPE3, TPE3 D 65-150	ANSI 2.5"	ANSI 2.5"	66 (30)	119 (54)	86 (39)	137 (62)	2 (0.044)	4 (0.117)
TPE3 D 65-180	ANSI 2.5"	ANSI 2.5"		123 (56)		143 (65)		4 (0.117)
TPE3 D 65-200	ANSI 2.5"	ANSI 2.5"		126 (57)		146 (66)		4 (0.117)
TPE3, TPE3 D 80-40	ANSI 3"	ANSI 3"	77 (35)	132 (60)	97 (44)	150 (68)	2 (0.049)	5 (0.129)
TPE3, TPE3 D 80-110	ANSI 3"	ANSI 3"	79 (36)	134 (61)	99 (45)	154 (70)	2 (0.049)	5 (0.129)
TPE3, TPE3 D 80-120	ANSI 3"	ANSI 3"	79 (36)	134 (61)	99 (45)	154 (70)	2 (0.049)	5 (0.129)
TPE3, TPE3 D 80-150	ANSI 3"	ANSI 3"	84 (38)	143 (65)	101 (46)	161 (73)	2 (0.049)	5 (0.129)
TPE3, TPE3 D 80-180	ANSI 3"	ANSI 3"	86 (39)	148 (67)	106 (48)	168 (76)	2 (0.049)	5 (0.129)

18. Accessories

Base plates

Note: TPE3 pumps are not designed to be supplied with a base plate.

TPE3 D

Pump type	Hexagon head screws	Product number
TPE3 D 65	3 x M12 x 40 mm	99150056
TPE3 D 80		

Drawing, TPE3 D 65

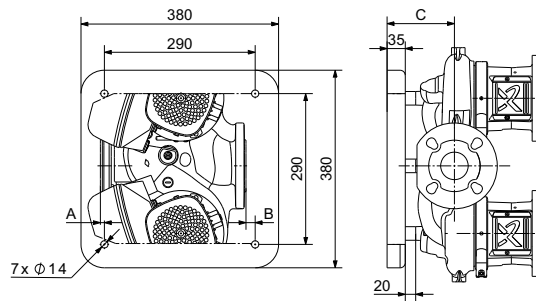

TM06 7445 3516

Drawing, TPE3 D 80

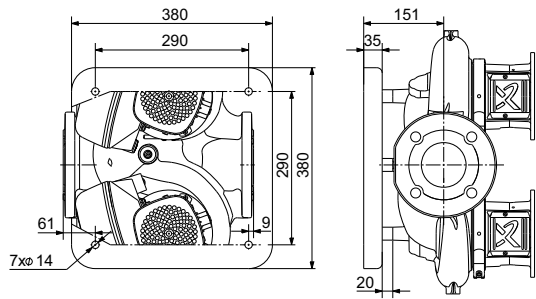

TM06 7481 3616

Insulating kits

Insulating kits are available for TPE3 pumps.

The insulating kit consists of two shells.

The insulating kit is tailored to the individual pump model and encloses the entire pump housing, thus providing optimum insulation.

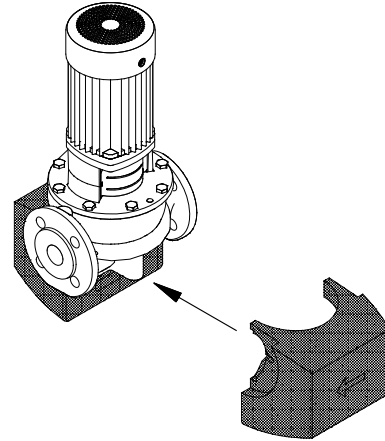

TM00 8095 2496

Fig. 65 Insulating kit

Kits for TPE3 pumps

Pump type	Product number
TPE3 40-80/120/150/180/200/240	98159368
TPE3 50-60/80/120/150/180/200/240	98159367
TPE3 65-60/80/120/150/180/200	98159361
TPE3 80-40/110/120/150/180	98159363

Sensors

Flow sensors

Grundfos Vortex flow sensor, VFi ¹	Type	Flow range [GPM (m ³ /h)]	Pipe connection	O-ring		Connection type		Product number	
				EPDM	FKM	Cast-iron flange	Stainless-steel flange		
 <ul style="list-style-type: none"> • Sensor tube with sensor sensor tube of 1.4408 and sensor of 1.4404 • 4-20 mA output signal • 2 flanges • 16 ft (5 m) cable with M12 connection in one end • quick guide. 	VFI 2-40 020 E	9 (2)-176 (40)	ANSI 1.5"	•		•		97686143	
	VFI 2-40 020 F				•		•		97686144
	VFI 2-40 020 E				•			•	97688299
	VFI 2-40 020 F					•		•	97688300
	VFI 3.2-64 020 E	9 (2)-282 (64)	ANSI 2"	•		•		97686145	
	VFI 3.2-64 020 F				•		•	97686146	
	VFI 3.2-64 020 E				•			•	97688301
	VFI 3.2-64 020 F					•		•	97688302
	VFI 5.2-104 020 E	23 (5.2)-458 (104)	ANSI 2.5"	•		•		97686147	
	VFI 5.2-104 020 F					•		97686148	
	VFI 5.2-104 020 E				•			•	97688303
	VFI 5.2-104 020 F					•		•	97688304
	VFI 8-160 020 E	35 (8)-704 (160)	ANSI 3"	•		•		97686149	
	VFI 8-160 020 F					•		97686150	
	VFI 8-160 020 E				•			•	97688305
	VFI 8-160 020 F					•		•	97688306
VFI 12-240 020 E	53 (12)-1056 (240)	ANSI 4"	•		•		97686151		
VFI 12-240 020 F					•		97686152		
VFI 12-240 020 E				•			•	97688308	
VFI 12-240 020 F						•	•	97688309	

¹ For more information about the VFi sensor, see the data booklet "Grundfos direct sensors", publication number 97790189.

Temperature sensors

Temperature sensor, TTA

Temperature sensor with Pt100 temperature sensor fitted in a $\varnothing 6 \times 100$ mm measuring tube made of stainless steel, ASTM 316Ti (DIN 1.4571) and a 4-20 mA sensor built into a type B head DIN 43.729.

The connecting head is made of painted pressure die-cast aluminium with Pg 16 screwed connection, stainless screws and neoprene rubber gasket.

The sensor is built into the system either by means of a cutting ring bush or by means of one of the two matching protecting tubes $\varnothing 9 \times 100$ mm or $\varnothing 9 \times 50$ mm, respectively.

The protecting tube has a G 1/2 connection.

Cutting ring bush or protecting tube must be ordered separately.

Technical data

Type	TTA (-25) 25	TTA (0) 25	TTA (0) 150	TTA (50) 100
Product number	96430194	96432591	96430195	96432592
Measuring range	-13 to +77 °F (-25 to +25 °C)	32 to +77 °F (0 to +25 °C)	32 to +302 °F (0 to +150 °C)	122 to 212 °F (50 to +100 °C)
Measuring accuracy	According to IEC 751, class B, 32.5 °F (0.3 °C) at 32 °F (0 °C)			
Response time, τ (0.9) in water 0.2 m/s	Without protecting tube:		28 seconds	
	With oil-filled protecting tube:		75 seconds	
Enclosure class	IP55			
Output signal	4-20 mA			
Supply voltage	8-35 VDC			
EMC, electromagnetic compatibility	Emission:		According to EN 50081	
	Immunity:		According to EN 50082	

Accessories

Type	Protecting tube $\varnothing 9 \times 50$ mm	Protecting tube $\varnothing 9 \times 100$ mm	Cutting ring bush
Product number	96430201	96430202	96430203
Description	Protecting tube of stainless steel SINOX SSH 2 for $\varnothing 6$ mm measuring tube. Pipe connection G 1/2.		Cutting ring bush for $\varnothing 6$ mm measuring tube. Pipe connection G 1/2.

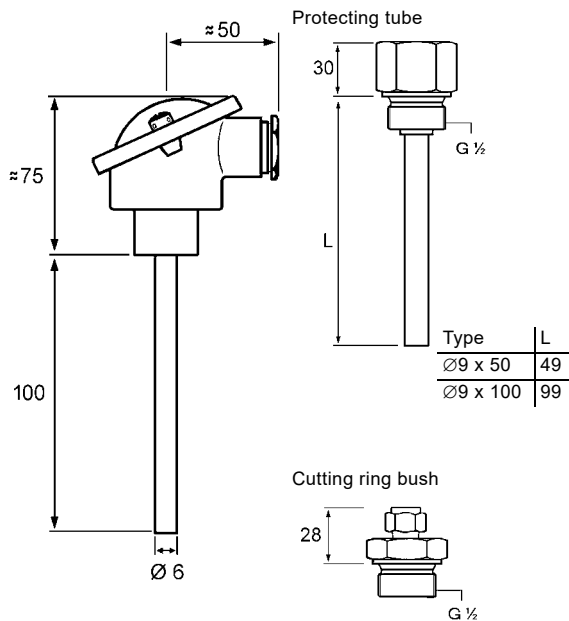

Fig. 66 Dimensional sketch

Differential-temperature sensor, HONSBERG

The temperature sensors T1 and T2 measure the temperature in their respective location at the same time. Besides the temperature measurement, the T1 features an electronic unit calculating the temperature difference between T1 and T2 and transmitting the result as a 4-20 mA signal via a current amplifier.

As the measured signal transmitted from the T2 is also a current signal, a relatively large distance is allowed between T2 and T1.

As appears from fig. 67, it has no effect on the output signal, I_{out} , which of the sensors that measures the highest temperature.

Thus, the current signal generated will always be positive between 4 and 20 mA.

Technical data

Type	ETSD1-04-020K045 + ETSD2-K045	ETSD1-04-050K045 + ETSD2-K045
Product number	96409362	96409363
Measuring range: Temperature difference (T1-T2) or (T2-T1)	32 to 68 °F (0 to +20 °C)	32 to 122 °F (0 to +50 °C)
Supply voltage	15-30 VDC	
Output signal	4-20 mA	
Measuring accuracy	± 0.3 % FS	
Repeatability	± 1 % FS	
Response time, τ (0.9)	2 minutes	
Ambient temperature	-13 to 185 °F (-25 to +85 °C)	
Operating temperature of T1 and T2	-13 to 221 °F (-25 to +105 °C)	
Maximum distance between T1 and T2	984 ft (300 m) with screened cable	
Electrical connection	Between T1 and T2: M12 x 1 plug, output signal with DIN 43650-A plug type	
Storage temperature	-49 to 257 °F (-45 to +125 °C)	
Short-circuit-proof	Yes	
Protected against polarity reversal	Yes, up to 40 V	
Materials in contact with liquid	Stainless steel, ASTM 316 Ti (DIN 1.4571)	
Enclosure class	IP65	
EMC, electromagnetic compatibility	Emission: According to EN 50081	
	Immunity: According to EN 50082	

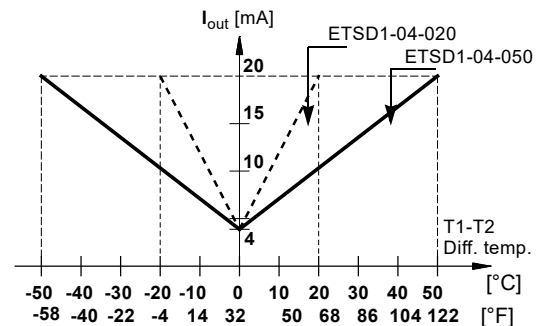

Fig. 67 Sensor characteristics

TM02 1339 1001

ETSD1- 04- 020 K 045	Specification
ETSD1-	Reference temperature, T1.
04-	32 °F (0 °C) corresponds to 4 mA.
020	68 °F (20 °C) corresponds to 20 mA.
050	122 °F (50 °C) corresponds to 20 mA.
K	Material in contact with liquid: Stainless steel, ASTM 316 Ti (DIN 1.4571).
045	Length of sensing element: 45 mm.
ETSD2- K 045	Specification
ETSD2-	Reference temperature, T2.
K	Material in contact with liquid: Stainless steel, DIN 1.4571.
045	Length of sensing element: 45 mm.

Installing the sensor

Fit the two sensors in such a way that the sensing elements are located in the middle of the flow of the liquid to be measured.

For tightening, use only the hexagon nut.

You can turn the upper part of the sensors to any position suitable for the connection of cables.

The sensors have a G 1/2 thread. See fig. 68.

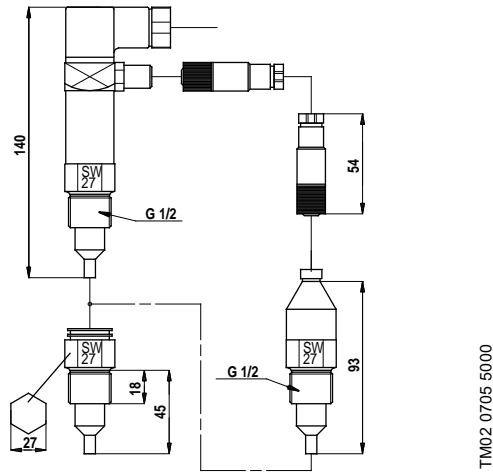

Fig. 68 Dimensional sketch

Ambient temperature sensor

Sensor type	Type	Supplier	Measuring range	Product number
Temperature sensor, ambient temperature	WR 52	tmg DK: Plesner	-58 to 122 °F (-50 to +50 °C)	ID8295

Pressure sensors

Sensors for boosting applications

Danfoss pressure sensor kit	Pressure range [psi (bar)]	Product number
<ul style="list-style-type: none"> • Connection: G 1/2 A, DIN 16288 - B6kt • Electrical connection: plug DIN 43650 	0-36 (2.5)	96478188
	0-58 (4)	91072075
	0-87 (6)	91072076
	0-145 (10)	91072077
	0-232 (16)	91072078
<ul style="list-style-type: none"> • Pressure sensor, type MBS 3000, with 7 ft (2 m) screened cable • Connection: G 1/4 A, DIN 16288 - B6kt • 5 cable clips, black • Fitting instructions PT, 00400212 	0-36 (2.5)	405159
	0-58 (4)	405160
	0-87 (6)	405161
	0-145 (10)	405162
	0-232 (16)	405163

Sensors for circulation applications

Grundfos differential pressure sensor, DPI	Pressure range [psi (bar)]	Product number
<ul style="list-style-type: none"> • 1 sensor including 0.9 m screened cable, 7/16" connections • 1 original DPI bracket for wall mounting • 1 Grundfos bracket for mounting on motor • 2 M4 screws for mounting of sensor on bracket • 1 M6 screw, self-cutting, for mounting on MLE 90/100 • 1 M8 screw, self-cutting, for mounting on MLE 112/132 • 1 M10 screw, self-cutting, for mounting on MLE 160 • 1 M12 screw, self-cutting, for mounting on MLE 180 • 3 capillary tubes, short/long • 2 fittings, 1/4" - 7/16" • 5 cable clips, black • Installation and operating instructions • Service kit instruction 	0-9 (0.6)	96611522
	0-14.5 (1)	96611523
	0-23 (1.6)	96611524
	0-36 (2.5)	96611525
	0-58 (4)	96611526
	0-87 (6)	96611527
	0-145 (10)	96611550
	Fitting kit for TPED with two sensors	

Select the differential pressure sensor so that the maximum pressure of the sensor is higher than the maximum differential pressure of the pump.

External Grundfos sensors

Sensor	Type	Supplier	Measuring range [psi (bar)]	Transmitter output [mA]	Power supply [VDC]	Process connection	Product number
Pressure transmitter	RPI	Grundfos	0-9 (0.6)	4-20	12-30	G 1/2	97748907
			0 - 14.5 (1)				97748908
			0-23 (1.6)				97748909
			0-36 (2.5)				97748910
			0-58 (4)				97748921
			0-87 (6)				97748922
			0-174 (12)				97748923
			0-232 (16)				97748924

Sensor interface

Sensor interface, SI 001 PSU ¹	Description	Product number
	Grundfos Direct Sensors™, type SI 001 PSU, is an external power supply for the VFI, DPI and other transmitters with 24 VDC supply voltage. The power supply is used when the cable between transmitter and controller is more than 98 ft (30 m) long.	96915820

¹ For further information about the PSU sensor interface, see the installation and operating instructions, "SI 001 PSU - sensor interface" publication number 96944355, or quick guide, publication number 96944356.

Potentiometer

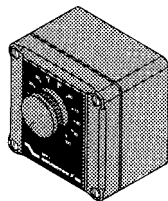

TM02 1630 5102

Fig. 69 Potentiometer

Potentiometer for setpoint setting and start/stop of the pump.

Product	Product number
External potentiometer with cabinet for wall mounting	625468

Grundfos GO

Grundfos GO is used for wireless infrared or radio communication with the pumps.

MI 301

MI 301 is a module with built-in infrared and radio communication. Use MI 301 in conjunction with Android or iOS-based smart devices with a Bluetooth connection. MI 301 has rechargeable Li-ion battery and you must charge it separately.



TM05 3890 1712

Fig. 70 MI 301

Supplied with the product:

- Grundfos MI 301
- sleeve
- battery charger
- quick guide.

Product numbers

Grundfos GO variant	Product number
Grundfos MI 301	98046408

CIU communication interface units



GrA 6118

Fig. 71 Grundfos CIU communication interface unit

The CIU units enable communication of operating data, such as measured values and setpoints, between TPE pumps and a building management system. The CIU unit incorporates a 24-240 VAC/VDC power supply module and a CIM module. You can mount the CIU unit on a DIN rail or on a wall. For further information See [Communication](#) on page 24.

We offer the following CIU units:

Description	Product number
CIU 900 CIU box without CIM	99448387
CIU 901 CIU box with IO 270 only	99448389
CIU 902 Autoadapt without CIM	97644690
CIU 903 SQFlex without CIM	98106399

For further information about data communication via CIU units and fieldbus protocols, see the CIU documentation available in Grundfos Product Center. See page 99.

CIM communication interface modules

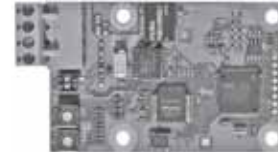

GrA6121

Fig. 72 Grundfos CIM communication interface module

The CIM modules enable communication of operating data, such as measured values and setpoints, between TPE pumps and a building management system. The CIM modules are add-on communication modules which are fitted in the terminal box of TPE pumps. For further information see [Communication](#) on page 24.

Note: CIM modules must be fitted by authorized personnel.

We offer the following CIM modules:

Description	Fieldbus protocol	Product number
CIM 050	GENIbus	96824631
CIM 100	LonWorks	96824797
CIM 150	PROFIBUS DP	96824793
CIM 200	Modbus RTU	96824796
CIM 260	3G/4G cellular	99439306
CIM 280	GRM GiC 3G/4G	99439725
CIM 300	BACnet MS/TP	96893770
CIM 500	PROFINET	
CIM 500	Modbus TCP	
CIM 500	BACnet IP	98301408
CIM 500	EtherNet/IP	
CIM 500	GRM IP	

* Antenna not included. See below.

Antennas for CIM 260 and 280

Description	Product number
Antenna (puc) 3G/4G for CIM 260/280	99518079

For further information about data communication via CIM modules and fieldbus protocols, see the CIM documentation available in Grundfos Product Center. See page 99.

19. Minimum inlet pressure - NPSH

To ensure optimum and noiseless operation, we recommend that you use the minimum inlet pressure values shown on page 97.

A minimum inlet pressure is required to avoid pressure drop that may cause cavitation.

Use the following formula to calculate the minimum inlet pressure, p_s in bar relative. The pressure gauge value on the pump inlet side.

Note: Base the calculation of the minimum inlet pressure on the maximum required flow.

$$p_s \geq \left(\text{NPSH}_R \times \rho \times g - \frac{1}{2} \times \rho \times c^2 \right) \times 0,00001 - p_b + p_d \text{ [bar relative]}$$

- p_s = Minimum inlet pressure in bar.
 NPSH_R = The required Net Positive Suction Head in m head, to be read from the NPSH curve at the highest flow the pump will be delivering.
 ρ = Density of the pumped liquid measured in kg/m^3 .
 g = Gravitational acceleration measured in m/s^2 . For estimated calculations use the value 9.81 m/s^2 .
 c = Flow velocity of the pumped liquid at the pressure gauge. Insert the flow velocity as the unit [m/s]. See individual curve charts from page 165.
 p_b = Barometric pressure in bar. Set the barometric pressure to 0.97 bar.
Note: Only occasionally the pressure is as high as 1 bar; this value is also at sea level.
 p_d = Vapor pressure in bar. See fig. 73.

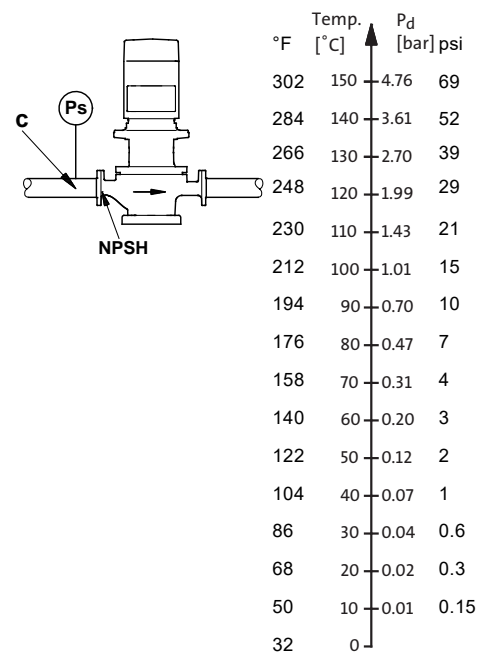

Fig. 73 Minimum inlet pressure

TM02 8491 0204 - TM03 0371 5004

Pump type	p [psi (bar)]				
	68 °F (20 °C)	140 °F (60 °C)	194 °F (90 °C)	230 °F (110 °C)	248 °F (120 °C)
TPE3 40-80	1 (0.1)	1 (0.1)	3 (0.2)	13 (0.9)	22 (1.5)
TPE3 40-120	1 (0.1)	1 (0.1)	3 (0.2)	13 (0.9)	22 (1.5)
TPE3 40-150	1 (0.1)	1 (0.1)	7 (0.5)	17 (1.2)	26 (1.8)
TPE3 40-180	1 (0.1)	1 (0.1)	9 (0.6)	19 (1.3)	28 (1.9)
TPE3 40-200	1 (0.1)	3 (0.2)	10 (0.7)	20 (1.4)	29 (2)
TPE3 40-240	1 (0.1)	4 (0.3)	12 (0.8)	22 (1.5)	30 (2.1)
TPE3 50-80	1 (0.1)	4 (0.3)	12 (0.8)	22 (1.5)	30 (2.1)
TPE3 50-150	9 (0.6)	12 (0.8)	19 (1.3)	29 (2)	38 (2.6)
TPE3 50-200	13 (0.9)	16 (1.1)	23 (1.6)	33 (2.3)	42 (2.9)
TPE3 50-240	13 (0.9)	16 (1.1)	23 (1.6)	33 (2.3)	42 (2.9)
TPE3, TPE3 D 65-80	1 (0.1)	1 (0.1)	4 (0.3)	16 (1.1)	25 (1.7)
TPE3, TPE3 D 65-120	1 (0.1)	3 (0.2)	9 (0.6)	20 (1.4)	29 (2)
TPE3, TPE3 D 65-150	1 (0.1)	3 (0.2)	10 (0.7)	22 (1.5)	30 (2.1)
TPE3 D 65-180	4 (0.3)	7 (0.5)	15 (1)	26 (1.8)	35 (2.4)
TPE3 D 65-200	9 (0.6)	12 (0.8)	19 (1.3)	30 (2.1)	39 (2.7)
TPE3, TPE3 D 80-40	1 (0.1)	1 (0.1)	4 (0.3)	15 (1)	23 (1.6)
TPE3, TPE3 D 80-110	1 (0.1)	4 (0.3)	13 (0.9)	22 (1.5)	30 (2.1)
TPE3, TPE3 D 80-120	1 (0.1)	4 (0.3)	13 (0.9)	22 (1.5)	30 (2.1)
TPE3, TPE3 D 80-150	1 (0.1)	4 (0.3)	13 (0.9)	22 (1.5)	30 (2.1)
TPE3, TPE3 D 80-180	4 (0.3)	7 (0.5)	16 (1.1)	25 (1.7)	33 (2.3)

20. Grundfos Product Center

Online search and sizing tool to help you make the right choice.

<http://product-selection.grundfos.com>



This drop-down menu enables you to set the search function to "Products" or "Literature".

"SIZING" enables you to size a pump based on entered data and selection choices.

"REPLACEMENT" enables you to find a replacement product. Search results will include information on the following:

- the lowest purchase price
- the lowest energy consumption
- the lowest total life cycle cost.

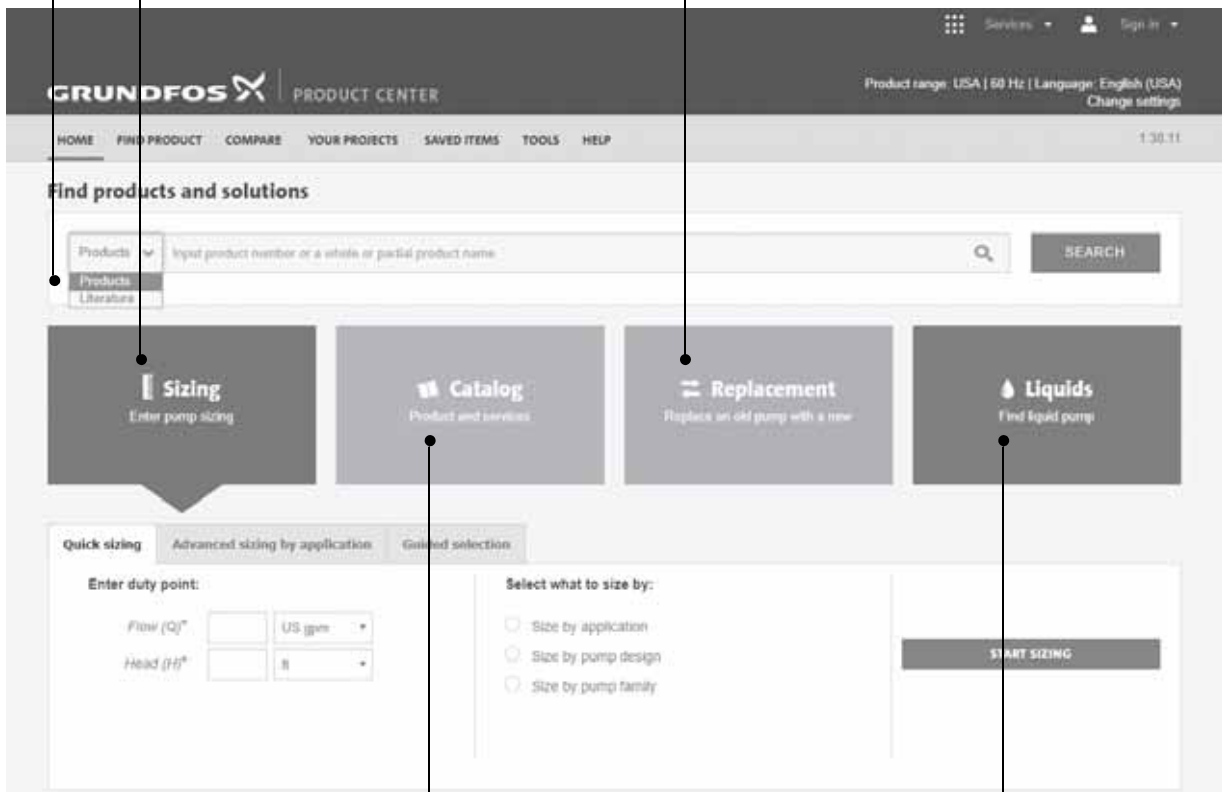

"CATALOGUE" gives you access to the Grundfos product catalogue.

"LIQUIDS" enables you to find pumps designed for aggressive, flammable or other special liquids.

All the information you need in one place

Performance curves, technical specifications, pictures, dimensional drawings, motor curves, wiring diagrams, spare parts, service kits, 3D drawings, documents, system parts. The Product Center displays any recent and saved items - including complete projects - right on the main page.

Downloads

On the product pages, you can download installation and operating instructions, data booklets, service instructions, etc. in PDF format.

Grundfos GO

Mobile solution for professionals on the GO!

Grundfos GO is the mobile tool box for professional users on the go. It is the most comprehensive platform for mobile pump control and pump selection including sizing, replacement and documentation. It offers intuitive, handheld assistance and access to Grundfos online tools, and it saves valuable time for reporting and data collection.

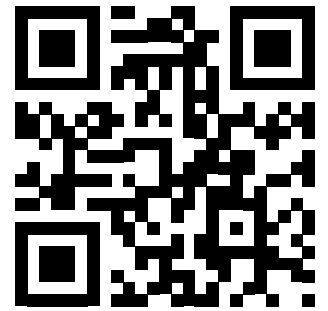

99526972 09.2020

ECM: 1293137

GRUNDFOS Chicago

3905 Enterprise Court
P.O. Box 6620
Aurora, IL 60598-0620
Phone: +1-630-236-5500
Fax: +1-630-236-5511

GRUNDFOS Kansas City

9300 Loiret Boulevard
Lenexa, Kansas 6619
Phone: +1-913-227-3400
Fax: +1-913-227-3500

GRUNDFOS CBS

902 Koomey Road
Brookshire, TX 77423
Phone: +1-281-994-2700
Fax: +1-800-945-4777

www.grundfos.us

Canada

GRUNDFOS Canada
2941 Brighton Road
Phone: +1-905-829-9533
Fax: +1-905-829-9512

www.grundfos.ca

México

GRUNDFOS México
Boulevard TLC No. 15
Parque Industrial Stiva Aeropuerto
Phone: +011-52-81-8144-4000
Fax: +011-52-81-8144-4010

www.grundfos.mx