

Dell EMC PowerEdge R650

Installation and Service Manual

Notes, cautions, and warnings

 **NOTE:** A NOTE indicates important information that helps you make better use of your product.

 **CAUTION:** A CAUTION indicates either potential damage to hardware or loss of data and tells you how to avoid the problem.

 **WARNING:** A WARNING indicates a potential for property damage, personal injury, or death.

| | |
|--|-----------|
| Chapter 1: About this document | 7 |
| Chapter 2: Dell EMC PowerEdge R650 system overview | 8 |
| Front view of the system..... | 8 |
| Right control panel view..... | 11 |
| Left control panel view..... | 12 |
| Rear view of the system..... | 13 |
| Inside the system | 16 |
| Locating the Express Service Code and Service Tag..... | 17 |
| System information label..... | 18 |
| Rail sizing and rack compatibility matrix..... | 20 |
| Chapter 3: Initial system setup and configuration | 22 |
| Setting up the system..... | 22 |
| iDRAC configuration..... | 22 |
| Options to set up iDRAC IP address..... | 22 |
| Options to log in to iDRAC..... | 23 |
| Resources to install operating system..... | 24 |
| Options to download firmware | 24 |
| Options to download and install OS drivers | 25 |
| Downloading drivers and firmware..... | 25 |
| Chapter 4: Minimum to POST and system management configuration validation | 26 |
| Minimum configuration to POST | 26 |
| Configuration validation..... | 26 |
| Error messages..... | 27 |
| Chapter 5: Installing and removing system components | 28 |
| Safety instructions..... | 28 |
| Before working inside your system..... | 29 |
| After working inside your system..... | 29 |
| Recommended tools..... | 29 |
| Cable routing..... | 30 |
| Optional front bezel..... | 36 |
| Removing the front bezel..... | 36 |
| Installing the front bezel..... | 37 |
| System cover..... | 38 |
| Removing the system cover..... | 38 |
| Installing the system cover..... | 39 |
| Drive backplane cover..... | 40 |
| Removing the drive backplane cover..... | 40 |
| Installing the drive backplane cover..... | 41 |
| Air shroud..... | 43 |
| Removing the air shroud..... | 43 |

| | |
|--|-----|
| Installing the air shroud..... | 44 |
| Cooling fans..... | 46 |
| Removing a cooling fan module..... | 46 |
| Installing a cooling fan module..... | 46 |
| Drives..... | 47 |
| Removing a drive blank..... | 47 |
| Installing a drive blank..... | 48 |
| Removing the drive carrier..... | 48 |
| Installing the drive carrier..... | 49 |
| Removing the drive from the drive carrier..... | 50 |
| Installing the drive into the drive carrier..... | 51 |
| Drive backplane..... | 52 |
| Drive backplane connectors..... | 52 |
| Removing the drive backplane | 59 |
| Installing the drive backplane..... | 60 |
| Rear mounting front PERC module..... | 62 |
| Removing the front mounting front PERC module..... | 62 |
| Installing the front mounting front PERC module..... | 63 |
| Removing the rear mounting front PERC module..... | 64 |
| Installing the rear mounting front PERC module..... | 65 |
| Rear drive module..... | 66 |
| Removing the rear drive module..... | 66 |
| Installing the rear drive module..... | 66 |
| System memory..... | 67 |
| System memory guidelines..... | 67 |
| General memory module installation guidelines..... | 69 |
| Intel Persistent Memory 200 series (BPS) installation guidelines | 70 |
| Removing a memory module..... | 75 |
| Installing a memory module..... | 76 |
| Processor and heat sink module..... | 77 |
| Removing the processor and heat sink module..... | 77 |
| Removing the processor from the processor heat sink module..... | 79 |
| Installing the processor..... | 80 |
| Installing the processor heat sink module..... | 84 |
| Removing the liquid cooling module..... | 86 |
| Installing the liquid cooling module..... | 87 |
| Expansion cards and expansion card risers..... | 88 |
| Expansion card installation guidelines..... | 89 |
| Removing the expansion card risers..... | 101 |
| Installing the expansion card risers..... | 104 |
| Removing expansion card from the expansion card riser..... | 106 |
| Installing an expansion card into the expansion card riser | 109 |
| Removing the R1 paddle cards..... | 111 |
| Installing R1 paddle card..... | 112 |
| Intrusion switch module..... | 113 |
| Removing the intrusion switch module..... | 113 |
| Installing the intrusion switch module..... | 114 |
| M.2 SSD module on BOSS-S1 adapter card..... | 115 |
| Removing the M.2 SSD module..... | 115 |
| Installing the M.2 SSD module..... | 116 |

| | |
|---|-----|
| Optional BOSS S2 module..... | 117 |
| Removing the BOSS S2 filler..... | 117 |
| Installing the BOSS S2 filler..... | 118 |
| Removing the BOSS S2 module..... | 119 |
| Installing the BOSS S2 controller card..... | 122 |
| Optional IDSDM module..... | 125 |
| Removing the IDSDM module..... | 125 |
| Installing the IDSDM module..... | 126 |
| MicroSD card..... | 127 |
| Removing the MicroSD card..... | 127 |
| Installing the MicroSD card..... | 128 |
| Optional OCP card..... | 129 |
| Removing the OCP card..... | 129 |
| Installing the OCP card..... | 130 |
| System battery | 131 |
| Replacing the system battery..... | 131 |
| Optional internal USB card..... | 133 |
| Removing the optional internal USB card..... | 133 |
| Installing the internal USB card..... | 134 |
| VGA module..... | 134 |
| Removing the VGA module..... | 134 |
| Installing the VGA module..... | 136 |
| Removing the rear VGA port..... | 138 |
| Installing the rear VGA port..... | 139 |
| Power supply unit..... | 140 |
| Hot spare feature..... | 140 |
| Removing a power supply unit blank..... | 140 |
| Installing a power supply unit blank..... | 141 |
| Removing a power supply unit..... | 142 |
| Installing a power supply unit..... | 142 |
| Optional serial COM port..... | 143 |
| Removing the serial COM port..... | 143 |
| Installing the serial COM port..... | 145 |
| System board..... | 147 |
| Removing the system board..... | 147 |
| Installing the system board..... | 148 |
| Restoring the system using Easy Restore..... | 150 |
| Trusted Platform Module..... | 150 |
| Upgrading the Trusted Platform Module..... | 150 |
| Initializing TPM for users..... | 151 |
| Initializing the TPM 1.2 for users..... | 151 |
| Initializing the TPM 2.0 for users..... | 151 |
| LOM and rear IO card..... | 151 |
| Removing the rear Input Output card and LOM card..... | 151 |
| Installing the RIO card and LOM card..... | 152 |
| Control panel..... | 153 |
| Removing the right control panel..... | 153 |
| Installing the right control panel..... | 154 |
| Removing the left control panel..... | 155 |
| Installing the left control panel..... | 156 |

| | |
|---|----------------|
| Chapter 6: Upgrade Kits..... | 158 |
| Management Interface Card (MIC) kit..... | 158 |
| BOSS S2 kit..... | 159 |
| IDSDM kit..... | 161 |
| Internal USB card kit..... | 162 |
| VGA port kit..... | 162 |
| Serial COM port kit..... | 162 |
| Chapter 7: Jumpers and connectors..... | 163 |
| System board connectors..... | 163 |
| System board jumper settings..... | 165 |
| Disabling a forgotten password..... | 165 |
| Chapter 8: System diagnostics and indicator codes..... | 166 |
| Status LED indicators..... | 166 |
| System health and system ID indicator codes..... | 167 |
| iDRAC Quick Sync 2 indicator codes..... | 168 |
| iDRAC Direct LED indicator codes..... | 168 |
| LCD panel..... | 169 |
| Viewing Home screen..... | 170 |
| Setup menu..... | 170 |
| View menu..... | 170 |
| NIC indicator codes..... | 171 |
| Power supply unit indicator codes..... | 171 |
| Drive indicator codes..... | 173 |
| Using system diagnostics..... | 173 |
| Dell Embedded System Diagnostics..... | 173 |
| Chapter 9: Getting help..... | 175 |
| Recycling or End-of-Life service information..... | 175 |
| Contacting Dell Technologies..... | 175 |
| Accessing system information by using QRL..... | 175 |
| Quick Resource Locator for PowerEdge R650 system..... | 176 |
| Receiving automated support with SupportAssist | 176 |
| Chapter 10: Documentation resources..... | 177 |

About this document

This document provides an overview about the system, information about installing and replacing components, diagnostic tools, and guidelines to be followed while installing certain components.

Dell EMC PowerEdge R650 system overview

The Dell EMC PowerEdge R650 system is a 1U server that supports:

- Up to two 3rd Generation Intel Xeon Scalable processors, with up to 40 cores per processor
- 32 DIMM slots
- Two redundant AC or DC power supply units
- Up to 4 x 3.5-inch, 8 x 2.5-inch SAS/SATA drives, 10 x 2.5-inch drives (with two or four universal slots to support optional NVMe drives) or 10x 2.5-inch NVMe drives only.

NOTE: For more information about how to hot swap NVMe PCIe SSD U.2 device, see the *Dell Express Flash NVMe PCIe SSD User's Guide* at <https://www.dell.com/support> > **Browse all Products** > **Data Center Infrastructure** > **Storage Adapters & Controllers** > **Dell PowerEdge Express Flash NVMe PCIe SSD** > **Documentation** > **Manuals and Documents**.

NOTE: All instances of SAS, SATA, NVMe drives are referred to as drives in this document, unless specified otherwise.

CAUTION: Do not install GPUs, network cards, or other PCIe devices on your system that are not validated and tested by Dell. Damage caused by unauthorized and invalidated hardware installation will null and void the system warranty.

For more information, see the *Dell EMC PowerEdge R650 Technical Specifications* on the product documentation page.

Topics:

- [Front view of the system](#)
- [Rear view of the system](#)
- [Inside the system](#)
- [Locating the Express Service Code and Service Tag](#)
- [System information label](#)
- [Rail sizing and rack compatibility matrix](#)

Front view of the system



Figure 1. Front view of 4 x 3.5-inch SAS/SATA drive system

Table 1. Features available on the front of the system

| Item | Ports, panels, and slots | Icon | Description |
|------|--------------------------|------|--|
| 1 | Left control panel | N/A | <p>Contains the system health, system ID, status LED, and the iDRAC Quick Sync 2 (wireless) indicator.</p> <p>NOTE: The iDRAC Quick Sync 2 indicator is available only on certain configurations.</p> <ul style="list-style-type: none"> • Status LED: Enables you to identify any failed hardware components. There are up to five status LEDs and an overall |

Table 1. Features available on the front of the system (continued)

| Item | Ports, panels, and slots | Icon | Description |
|------|--------------------------|---|---|
| | | | <p>system health LED (Chassis health and system ID) bar. For more information, see the Status LED indicators section.</p> <ul style="list-style-type: none"> Quick Sync 2 (wireless): Indicates a Quick Sync enabled system. The Quick Sync feature is optional. This feature allows management of the system by using mobile devices called as OpenManage Mobile (OMM) feature. Using iDRAC Quick Sync 2 with OpenManage Mobile (OMM) aggregates hardware or firmware inventory and various system level diagnostic and error information that can be used in troubleshooting the system. For more information, see the <i>Integrated Dell Remote Access Controller User's Guide</i> available at https://www.dell.com/idracmanuals |
| 2 | Drive (4) | N/A | Enables you to install drives that are supported on your system. |
| 3 | VGA port |  | Enables you to connect a display device to the system. |
| 4 | Right control panel | N/A | Contains the power button, USB port, iDRAC Direct micro port, and the iDRAC Direct status LED. |
| 5 | Information tag | N/A | The Information tag is a slide-out label panel that contains system information such as Service Tag, NIC, MAC address, and so on. If you have opted for the secure default access to iDRAC, then the Information tag will also contain the iDRAC secure default password. |



Figure 2. Front view of 8 x 2.5-inch SAS/SATA drive system

Table 2. Features available on the front of the system

| Item | Ports, panels, and slots | Icon | Description |
|------|--------------------------|------|--|
| 1 | Left control panel | N/A | <p>Contains the system health, system ID, status LED, and the iDRAC Quick Sync 2 (wireless) indicator.</p> <p>NOTE: The iDRAC Quick Sync 2 indicator is available only on certain configurations.</p> <ul style="list-style-type: none"> Status LED: Enables you to identify any failed hardware components. There are up to five status LEDs and an overall system health LED (Chassis health and system ID) bar. For more information, see the Status LED indicators section. Quick Sync 2 (wireless): Indicates a Quick Sync enabled system. The Quick Sync feature is optional. This feature allows management of the system by using mobile devices called as OpenManage Mobile (OMM) feature. Using iDRAC Quick Sync 2 with OpenManage Mobile (OMM) aggregates hardware or firmware inventory and various system level diagnostic and error information that can be used in troubleshooting the system. For more information, see the <i>Integrated Dell Remote Access Controller User's Guide</i> available at https://www.dell.com/idracmanuals |

Table 2. Features available on the front of the system (continued)

| Item | Ports, panels, and slots | Icon | Description |
|------|--------------------------|---|---|
| 2 | Drive (8) | N/A | Enables you to install drives that are supported on your system. |
| 3 | Right control panel | N/A | Contains the power button, USB port, iDRAC Direct micro port, and the iDRAC Direct status LED. |
| 4 | VGA port |  | Enables you to connect a display device to the system. |
| 5 | Information tag | N/A | The Information tag is a slide-out label panel that contains system information such as Service Tag, NIC, MAC address, and so on. If you have opted for the secure default access to iDRAC, then the Information tag will also contain the iDRAC secure default password. |



Figure 3. Front view of 10 x 2.5-inch SAS/SATA/NVMe drive system

NOTE: For 8 x 2.5-inch all NVMe drive system, need to install drive blanks on drive bays 8 and 9 in the same chassis..

Table 3. Features available on the front of the system

| Item | Ports, panels, and slots | Icon | Description |
|------|--------------------------|---|--|
| 1 | Left control panel | N/A | <p>Contains the system health, system ID, status LED, and the iDRAC Quick Sync 2 (wireless) indicator.</p> <p>NOTE: The iDRAC Quick Sync 2 indicator is available only on certain configurations.</p> <ul style="list-style-type: none"> • Status LED: Enables you to identify any failed hardware components. There are up to five status LEDs and an overall system health LED (Chassis health and system ID) bar. For more information, see the Status LED indicators section. • Quick Sync 2 (wireless): Indicates a Quick Sync enabled system. The Quick Sync feature is optional. This feature allows management of the system by using mobile devices called as OpenManage Mobile (OMM) feature. Using iDRAC Quick Sync 2 with OpenManage Mobile (OMM) aggregates hardware or firmware inventory and various system level diagnostic and error information that can be used in troubleshooting the system. For more information, see the <i>Integrated Dell Remote Access Controller User's Guide</i> available at https://www.dell.com/idracmanuals |
| 2 | VGA port |  | Enables you to connect a display device to the system. |
| 3 | Right control panel | N/A | Contains the power button, USB port, iDRAC Direct micro port, and the iDRAC Direct status LED. |
| 4 | Information tag | N/A | The Information tag is a slide-out label panel that contains system information such as Service Tag, NIC, MAC address, and so on. If you have opted for the secure default access to |

Table 3. Features available on the front of the system (continued)

| Item | Ports, panels, and slots | Icon | Description |
|------|--------------------------|------|--|
| | | | iDRAC, then the Information tag will also contain the iDRAC secure default password. |
| 5 | Drive (10) | N/A | Enables you to install drives that are supported on your system. |

For more information about the ports, see the *Dell EMC PowerEdge R650 Technical Specifications on the product documentation page*.

Right control panel view

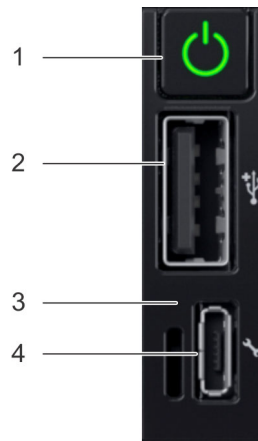

Figure 4. Right control panel

Table 4. Right control panel

| Item | Indicator or button | Icon | Description |
|------|----------------------------------|------|---|
| 1 | Power button | | Indicates if the system is powered on or off. Press the power button to manually power on or off the system. NOTE: Press the power button to gracefully shut down the ACPI-compliant operating system. |
| 2 | USB 2.0-compliant port | | The USB port is a 4-pin connector and 2.0-compliant. This port enables you to connect USB devices to the system. |
| 3 | iDRAC Direct LED indicator | N/A | The iDRAC Direct LED indicator lights up to indicate that the iDRAC Direct port is actively connected to a device. |
| 4 | iDRAC Direct port (Micro-AB USB) | | The iDRAC Direct port (Micro-AB USB) enables you to access the iDRAC Direct Micro-AB features. For more information, see the <i>Integrated Dell Remote Access Controller User's Guide</i> available at https://www.dell.com/idracmanuals . NOTE: You can configure iDRAC Direct by using a USB to micro USB (type AB) cable, which you can connect to your laptop or tablet. Cable length should not exceed 3 feet (0.91 meters). Performance could be affected by cable quality. |

NOTE: For more information, see the *Dell EMC PowerEdge R650 Technical Specifications* on the product documentation page.

Left control panel view

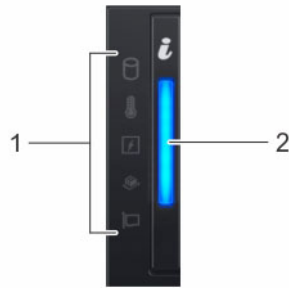

Figure 5. Left control panel without optional iDRAC Quick Sync 2.0 indicator

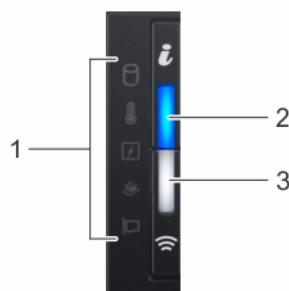

Figure 6. Left control panel with optional iDRAC Quick Sync 2.0 indicator

Table 5. Left control panel

| Item | Indicator, button, or connector | Icon | Description |
|------|--|----------|---|
| 1 | Status LED indicators | N/A | Indicates the status of the system. For more information, see the Status LED indicators section. |
| 2 | System health and system ID indicator | <i>i</i> | Indicates the system health. For more information, see the System health and system ID indicator codes section. |
| 3 | iDRAC Quick Sync 2 wireless indicator (optional) | ⊞ | Indicates if the iDRAC Quick Sync 2 wireless option is activated. The Quick Sync 2 feature allows management of the system using mobile devices. This feature aggregates hardware/firmware inventory and various system level diagnostic/error information that can be used in troubleshooting the system. You can access system inventory, Dell Lifecycle Controller logs or system logs, system health status, and also configure iDRAC, BIOS, and networking parameters. You can also launch the virtual Keyboard, Video, and Mouse (KVM) viewer and virtual Kernel-based Virtual Machine (KVM), on a supported mobile device. For more information, see the Integrated Dell Remote Access Controller User's Guide at www.dell.com/poweredgemanuals |

NOTE: For more information about the indicator codes, see the [System diagnostics and indicator codes](#) section.

Rear view of the system

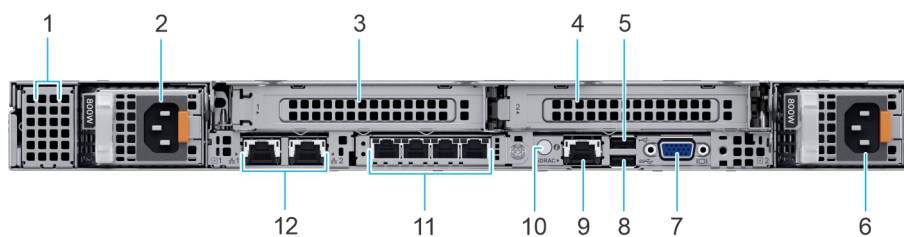

Figure 7. Rear view of the system with 2 x FH PCIe slots

Table 6. Rear view of the system with 2 x FH PCIe slots

| Item | Ports, panels, or slots | Icon | Description |
|------|---|--------------|--|
| 1 | BOSS S2 module blank | N/A | This slot supports the BOSS S2 module. |
| 2 | Power supply unit (PSU 1) | | Indicates the PSU. |
| 3 | PCIe expansion card riser (slot 1 - FH) | N/A | The expansion card riser enables you to connect PCI Express expansion cards. |
| 4 | PCIe expansion card riser (slot 2 - FH) | N/A | The expansion card riser enables you to connect PCI Express expansion cards. |
| 5 | USB 2.0 port (1) | | This port is USB 2.0-compliant. |
| 6 | Power supply unit (PSU 2) | | Indicates the PSU. |
| 7 | VGA port (on STD RIO board) | | Enables you to connect a display device to the system. |
| 8 | USB 3.0 port (1) | | This port is USB 3.0-compliant. |
| 9 | iDRAC dedicated port | iDRAC | Enables you to remotely access iDRAC. For more information, see the iDRAC User's Guide at www.dell.com/poweredgemanuals . |
| 10 | System identification button | | <p>Press the system ID button:</p> <ul style="list-style-type: none"> To locate a particular system within a rack. To turn the system ID on or off. <p>To reset iDRAC, press and hold the button for more than 16 seconds.</p> <p>NOTE:</p> <ul style="list-style-type: none"> To reset iDRAC using system ID, ensure that the system ID button is enabled in the iDRAC setup. If the system stops responding during POST, press and hold the system ID button (for more than 5 seconds) to enter the BIOS progress mode. |
| 11 | OCP NIC port (optional) | N/A | This port supports OCP 3.0. The NIC ports are integrated on the OCP card which is connected to the system board. |
| 12 | NIC port (2) | | The NIC ports are embedded on the LOM card that is connected to the system board. |

NOTE: For more information, see the *Dell EMC PowerEdge R650 Technical Specifications* on the product documentation page.

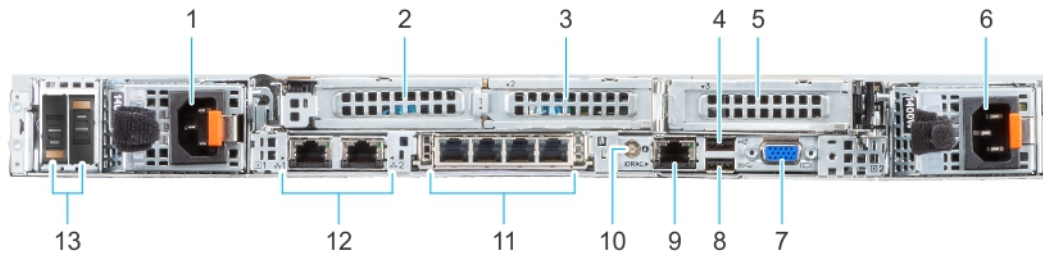

Figure 8. Rear view of the system with 3 x LP PCIe slots

Table 7. Rear view of the system with 3 x LP PCIe slots

| Item | Ports, panels, or slots | Icon | Description |
|------|------------------------------------|--------------|--|
| 1 | Power supply unit (PSU 1) | | Indicates the PSU. |
| 2 | PCIe expansion card riser (slot 1) | N/A | The expansion card riser enables you to connect PCI Express expansion cards. |
| 3 | PCIe expansion card riser (slot 2) | N/A | The expansion card riser enables you to connect PCI Express expansion cards. |
| 4 | USB 2.0 port (1) | | This port is USB 2.0-compliant. |
| 5 | PCIe expansion card riser (slot 3) | N/A | The expansion card riser enables you to connect PCI Express expansion cards. |
| 6 | Power supply unit (PSU 2) | | Indicates the PSU. |
| 7 | VGA port (on STD RIO board) | | Enables you to connect a display device to the system. |
| 8 | USB 3.0 port (1) | | This port is USB 3.0-compliant. |
| 9 | iDRAC dedicated port | iDRAC | Enables you to remotely access iDRAC. For more information, see the iDRAC User's Guide at www.dell.com/poweredgemanuals . |
| 10 | System identification button | | <p>Press the system ID button:</p> <ul style="list-style-type: none"> To locate a particular system within a rack. To turn the system ID on or off. <p>To reset iDRAC, press and hold the button for more than 16 seconds.</p> <p>i NOTE:</p> <ul style="list-style-type: none"> To reset iDRAC using system ID, ensure that the system ID button is enabled in the iDRAC setup. If the system stops responding during POST, press and hold the system ID button (for more than 5 seconds) to enter the BIOS progress mode. |
| 11 | OCP NIC port (optional) | N/A | This port supports OCP 3.0. The NIC ports are integrated on the OCP card which is connected to the system board. |
| 12 | NIC port (2) | | The NIC ports are embedded on the LOM card that is connected to the system board. |
| 13 | BOSS S2 module (optional) | N/A | This slot supports the BOSS S2 module. |

i NOTE: For more information, see the *Dell EMC PowerEdge R650 Technical Specifications* on the product documentation page.

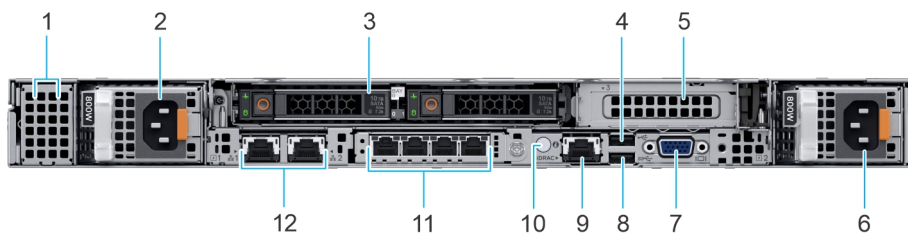

Figure 9. Rear view of the system with 2 x 2.5-inch rear drive module and 1 x LP PCIe slot

Table 8. Rear view of the system with 2 x 2.5-inch rear drive module and 1 x LP PCIe slot

| Item | Ports, panels, or slots | Icon | Description |
|------|------------------------------------|--------------|--|
| 1 | BOSS S2 module blank | N/A | This slot supports the BOSS S2 module. |
| 2 | Power supply unit (PSU 1) | | Indicates the PSU. |
| 3 | Rear drive module | N/A | Enables you to install drives that are supported on your system. |
| 4 | USB 2.0 port (1) | | This port is USB 2.0-compliant. |
| 5 | PCIe expansion card riser (slot 3) | N/A | The expansion card riser enables you to connect PCI Express expansion cards. |
| 6 | Power supply unit (PSU 2) | | Indicates the PSU. |
| 7 | VGA port (on STD RIO board) | | Enables you to connect a display device to the system. |
| 8 | USB 3.0 port (1) | | This port is USB 3.0-compliant. |
| 9 | iDRAC dedicated port | iDRAC | Enables you to remotely access iDRAC. For more information, see the iDRAC User's Guide at www.dell.com/poweredgemanuals . |
| 10 | System identification button | | <p>Press the system ID button:</p> <ul style="list-style-type: none"> To locate a particular system within a rack. To turn the system ID on or off. <p>To reset iDRAC, press and hold the button for more than 16 seconds.</p> <p>NOTE:</p> <ul style="list-style-type: none"> To reset iDRAC using system ID, ensure that the system ID button is enabled in the iDRAC setup. If the system stops responding during POST, press and hold the system ID button (for more than 5 seconds) to enter the BIOS progress mode. |
| 11 | OCP NIC port (optional) | N/A | This port supports OCP 3.0. The NIC ports are integrated on the OCP card which is connected to the system board. |
| 12 | NIC port (2) | | The NIC ports are embedded on the LOM card that is connected to the system board. |

NOTE: For more information, see the *Dell EMC PowerEdge R650 Technical Specifications* on the product documentation page.

Inside the system

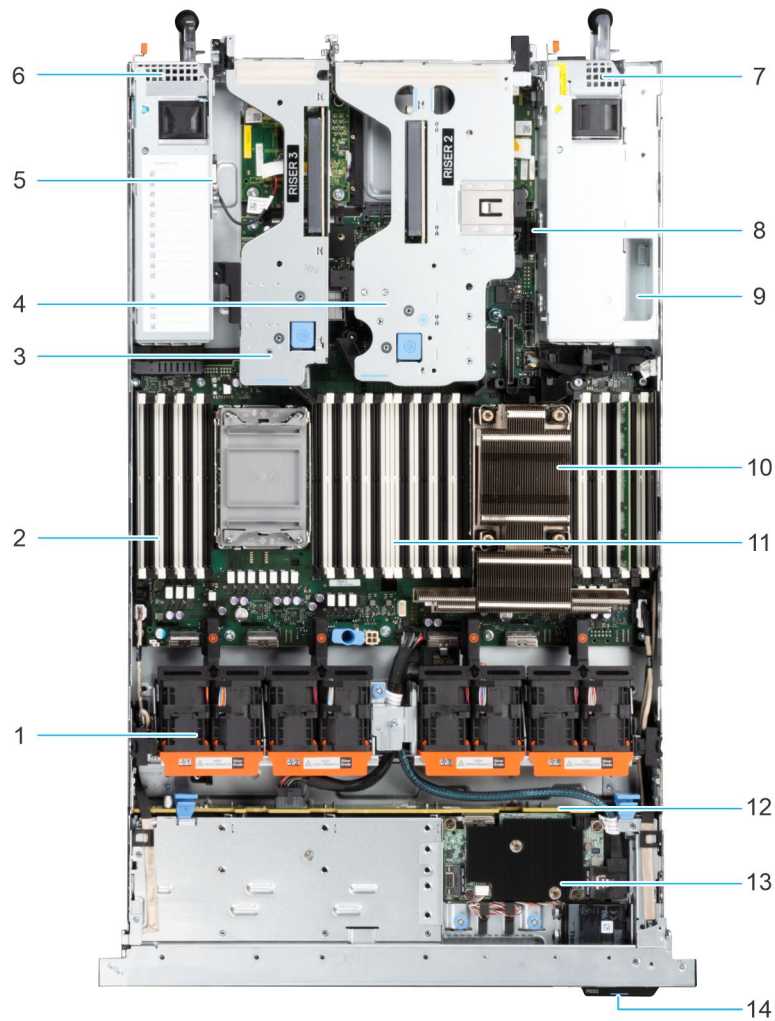

Figure 10. Inside the system with front mounting fPERC

- | | |
|---|--|
| 1. Cooling fan | 2. Memory DIMM socket for processor 2 (B2) |
| 3. Riser 3 | 4. Riser 2 |
| 5. Intrusion switch | 6. Power supply unit (PSU 2) |
| 7. Power supply unit (PSU 1) | 8. IDSDM/Internal USB card port |
| 9. BOSS S2 module | 10. Heat sink for processor 1 |
| 11. Memory DIMM socket for processor 1 (A6) | 12. Drive backplane |
| 13. fPERC | 14. Service Tag |

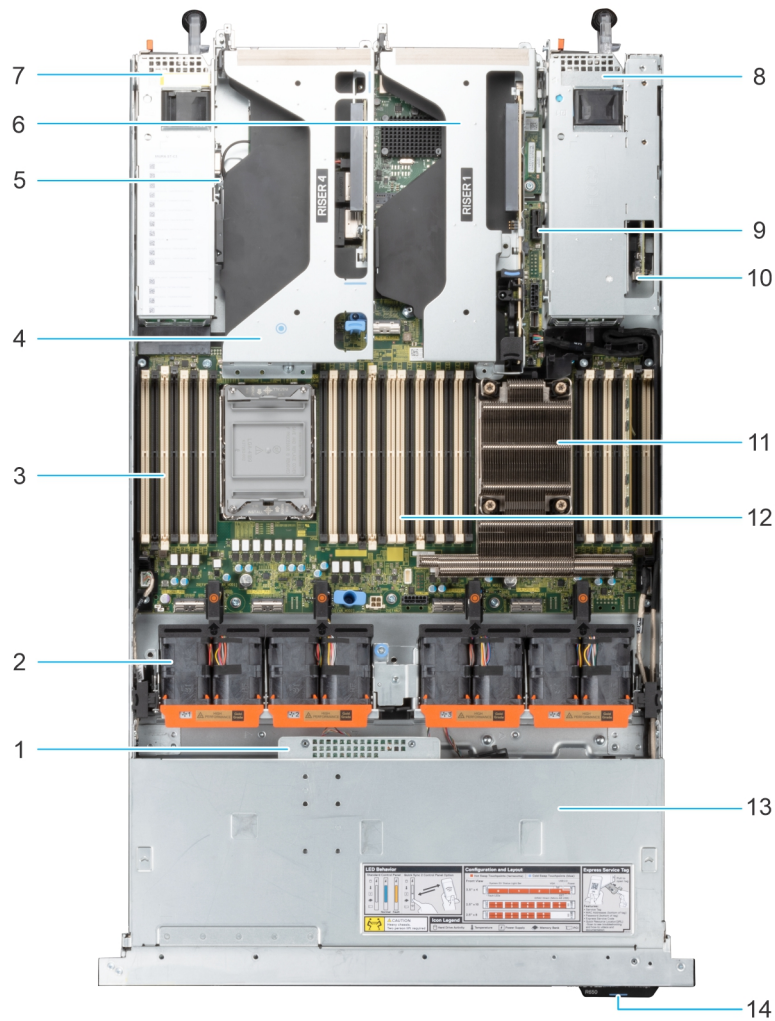

Figure 11. Inside the system with rear mounting fPERC

- | | |
|--|---|
| 1. fPERC | 2. Cooling fan |
| 3. Memory DIMM socket for processor 2 (B2) | 4. Riser 4 |
| 5. Intrusion switch | 6. Riser 1 |
| 7. Power supply unit (PSU 1) | 8. Power supply unit (PSU 2) |
| 9. IDS/DM/Internal USB card port | 10. BOSS S2 module |
| 11. Heat sink for processor 1 | 12. Memory DIMM socket for processor 1 (A6) |
| 13. Backplane cover | 14. Service Tag |

Locating the Express Service Code and Service Tag

The unique Express Service Code and Service Tag are used to identify the system.

The information tag is located on the front of the system that includes system information such as the Service Tag, Express Service Code, Manufacture date, NIC, MAC address, QRL label, and so on. If you have opted for the secure default access to iDRAC, the Information tag also contains the iDRAC secure default password. If you have opted for iDRAC Quick Sync 2, the Information tag also contains the OpenManage Mobile (OMM) label, where administrators can configure, monitor, and troubleshoot the PowerEdge servers.

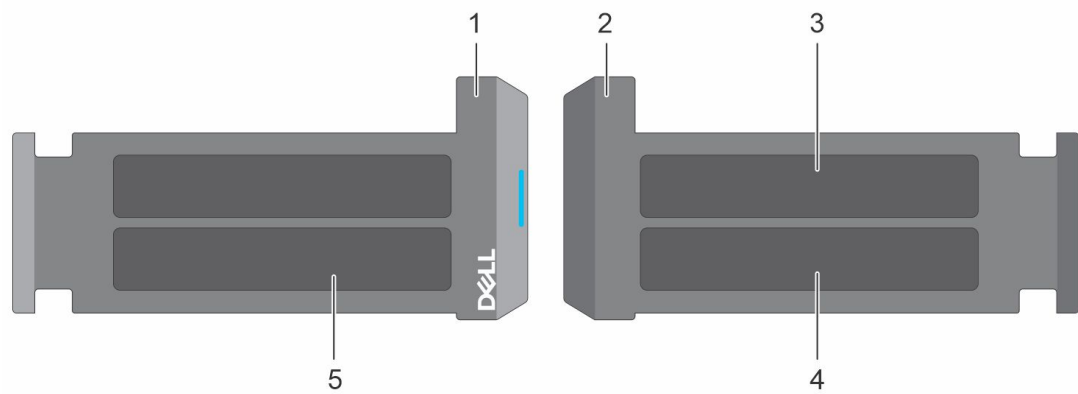

Figure 12. Locating the Express Service Code and Service tag

1. Information tag (front view)
2. Information tag (back view)
3. OpenManage Mobile (OMM) label
4. iDRAC MAC address and iDRAC secure password label
5. Service Tag, Express Service Code, QRL label

The Mini Enterprise Service Tag (MEST) label is located on the rear of the system that includes the Service Tag (ST), Express Service Code (Exp Svc Code), and Manufacture Date (Mfg. Date). The Exp Svc Code is used by Dell EMC to route support calls to the appropriate personnel.

Alternatively, the Service Tag information is located on a label on the left wall of the chassis.

System information label

The system information label is located on back side of the system cover.

Service Information

System Touchpoints

■ Hot swap touchpoints: Components with terracotta touchpoints can be serviced while the system is running.

■ Cold swap touchpoints: Components with blue touchpoints require a full system shutdown before servicing.

Mechanical Overview

Top View

Front of system

Rear View Configurations

Hot Swap

Boot Optimized M.2 Drives

Fan Installation

System Tasks

Front PERC (rear loading)

System Tasks

Front PERC (front loading)

Caution: Many repairs may only be done by a certified service technician. You should only perform troubleshooting and simple repairs as authorized in your product documentation, or as directed by the online or telephone service and support team. Damage due to servicing that is not authorized by Dell is not covered by your warranty. Read and follow the safety instructions that came with the product.

To learn more about this Dell product or to order additional or replacement parts, go to Dell.com/support

Copyright © 2019 Dell Inc. or its subsidiaries. All Rights Reserved. Rev A00. Label Part No. 7DP10

Figure 13. Service information

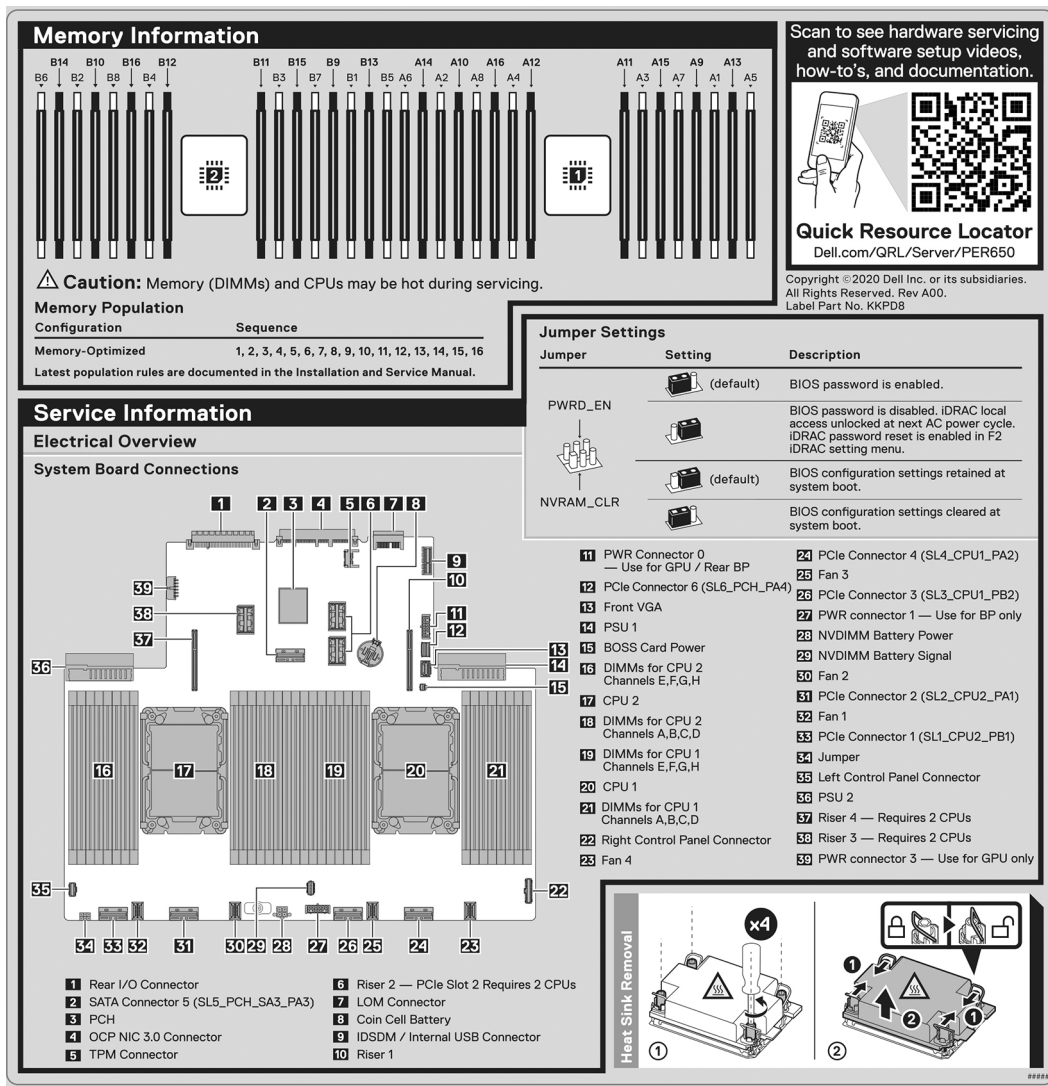

Figure 14. Memory information and system board connectors

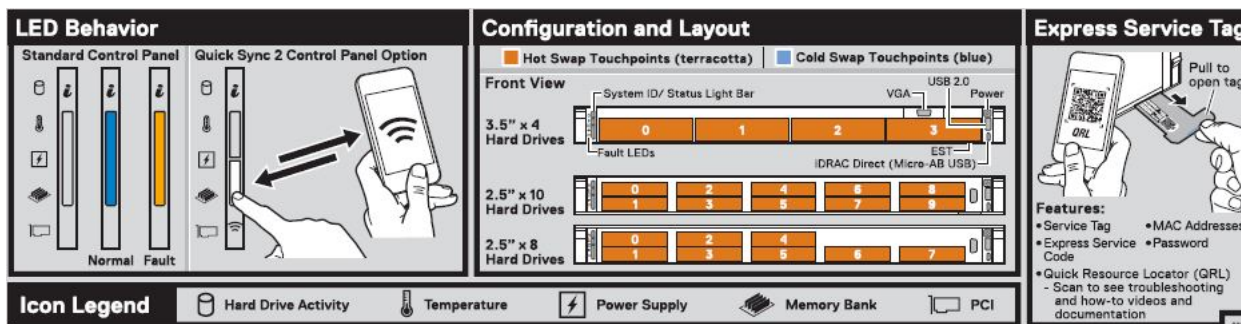

Figure 15. LED behavior, configuration and layout, express service tag

Rail sizing and rack compatibility matrix

For specific information about the rail solutions compatible with your system, see the *Dell EMC Enterprise Systems Rail Sizing and Rack Compatibility Matrix* available at https://i.dell.com/sites/csdocuments/Business_solutions_engineering-Docs_Documents/en/rail-rack-matrix.pdf.

The document provides the information that is listed below:

- Specific details about rail types and their functionalities.

- Rail adjustability range for various types of rack mounting flanges.
- Rail depth with and without cable management accessories.
- Types of racks supported for various types of rack mounting flanges.

Initial system setup and configuration

This section describes the tasks for initial setup and configuration of the Dell EMC system. The section also provides general steps to set up the system and the reference guides for detailed information.

Topics:

- [Setting up the system](#)
- [iDRAC configuration](#)
- [Resources to install operating system](#)

Setting up the system

Perform the following steps to set up the system:

Steps

1. Unpack the system.
2. Install the system into the rack. For more information, see the rail installation and cable management accessory guides relevant to your rail and cable management solution at www.dell.com/poweredgemanuals.
3. Connect the peripherals to the system and the system to the electrical outlet.
4. Power on the system.

For more information about setting up the system, see the *Getting Started Guide* that is shipped with your system.

i **NOTE:** For information about managing the basic settings and features of the system, see the *Dell Technologies PowerEdge R650 BIOS and UEFI Reference Guide* on the product documentation page.

iDRAC configuration

The Integrated Dell Remote Access Controller (iDRAC) is designed to make you more productive as a system administrator and improve the overall availability of Dell EMC servers. iDRAC alerts you to system issues, helps you to perform remote management, and reduces the need for physical access to the system.

i **NOTE:** To reset iDRAC, see [how to reset iDRAC](#).

Options to set up iDRAC IP address

To enable communication between your system and iDRAC, you must first configure the network settings based on your network infrastructure. The network settings option is set to **DHCP**, by default.

i **NOTE:** For static IP configuration, you must request for the settings at the time of purchase.

You can set up the iDRAC IP address using one of the interfaces in the table below. For information about setting up iDRAC IP address, see the documentation links provided in the table below.

Table 9. Interfaces to set up iDRAC IP address

| Interface | Documentation links |
|------------------------|---|
| iDRAC Settings utility | <i>Integrated Dell Remote Access Controller User's Guide</i> at https://www.dell.com/idracmanuals or for system specific <i>Integrated Dell Remote Access Controller User's Guide</i> , go to https://www.dell.com/poweredgemanuals > Product Support page of your system > Documentation . |

Table 9. Interfaces to set up iDRAC IP address (continued)

| Interface | Documentation links |
|--|--|
| | <p>i NOTE: To determine the most recent iDRAC release for your platform and for latest documentation version, see KB article https://www.dell.com/support/article/sln308699.</p> |
| OpenManage Deployment Toolkit | <p><i>Dell OpenManage Deployment Toolkit User's Guide</i> available at https://www.dell.com/openmanagemanuals > Open Manage Deployment Toolkit.</p> |
| iDRAC Direct | <p><i>Integrated Dell Remote Access Controller User's Guide</i> at https://www.dell.com/idracmanuals or for system specific <i>Integrated Dell Remote Access Controller User's Guide</i>, go to https://www.dell.com/poweredgemanuals > Product Support page of your system > Documentation.</p> <p>i NOTE: To determine the most recent iDRAC release for your platform and for latest documentation version, see KB article https://www.dell.com/support/article/sln308699.</p> |
| Lifecycle Controller | <p><i>Dell Lifecycle Controller User's Guide</i> at https://www.dell.com/idracmanuals or for system specific <i>Dell Lifecycle Controller User's Guide</i>, go to https://www.dell.com/poweredgemanuals > Product Support page of your system > Documentation.</p> <p>i NOTE: To determine the most recent iDRAC release for your platform and for latest documentation version, see KB article https://www.dell.com/support/article/sln308699.</p> |
| Server LCD panel | <p>LCD panel section.</p> |
| iDRAC Direct and Quick Sync 2 (optional) | <p><i>Integrated Dell Remote Access Controller User's Guide</i> at https://www.dell.com/idracmanuals or for system specific <i>Integrated Dell Remote Access Controller User's Guide</i>, go to https://www.dell.com/poweredgemanuals > Product Support page of your system > Documentation.</p> <p>i NOTE: To determine the most recent iDRAC release for your platform and for latest documentation version, see KB article https://www.dell.com/support/article/sln308699.</p> |

i **NOTE:** To access iDRAC, ensure that you connect the ethernet cable to the iDRAC dedicated network port or use the iDRAC Direct port by using the USB cable. You can also access iDRAC through the shared LOM mode, if you have opted for a system that has the shared LOM mode enabled.

Options to log in to iDRAC

To log in to the iDRAC Web User Interface, open a browser and enter the IP address.

You can log in to iDRAC as:

- iDRAC user
- Microsoft Active Directory user
- Lightweight Directory Access Protocol (LDAP) user

In the login screen displayed, if you have opted for secure default access to iDRAC, enter the iDRAC secure default password available on back of the Information Tag. If you have not opted for secure default access to iDRAC, enter the default user name and password – `root` and `calvin`. You can also log in by using your Single Sign-On or Smart Card.

NOTE: Ensure that you change the default username and password after setting up the iDRAC IP address.

For more information about logging in to the iDRAC and iDRAC licenses, see the latest *Integrated Dell Remote Access Controller User's Guide* at www.dell.com/idracmanuals.

NOTE: To determine the most recent iDRAC release for your platform and for latest documentation version, see KB article <https://www.dell.com/support/article/sln308699>.

You can also access iDRAC using command-line protocol - RACADM. For more information, see the *Integrated Dell Remote Access Controller RACADM CLI Guide* available at <https://www.dell.com/idracmanuals>.

You can also access iDRAC using automation tool - Redfish API. For more information, see the *Integrated Dell Remote Access Controller User's Guide Redfish API Guide* available at <https://developer.dell.com>.

Resources to install operating system

If the system is shipped without an operating system, you can install a supported operating system by using one of the resources provided in the table below. For information about how to install the operating system, see the documentation links provided in the table below.

Table 10. Resources to install the operating system

| Resource | Documentation links |
|-------------------------------|--|
| iDRAC | <i>Integrated Dell Remote Access Controller User's Guide</i> at https://www.dell.com/idracmanuals or for system specific <i>Integrated Dell Remote Access Controller User's Guide</i> , go to https://www.dell.com/poweredgemanuals > Product Support page of your system > Documentation . NOTE: To determine the most recent iDRAC release for your platform and for latest documentation version, see KB article at https://www.dell.com/support/article/sln308699 . |
| Lifecycle Controller | <i>Dell Lifecycle Controller User's Guide</i> at https://www.dell.com/idracmanuals or for system specific <i>Dell Lifecycle Controller User's Guide</i> , go to https://www.dell.com/poweredgemanuals > Product Support page of your system > Documentation . Dell recommends using Lifecycle Controller to install the OS, since all required drivers are installed on the system. NOTE: To determine the most recent iDRAC release for your platform and for latest documentation version, see KB article at https://www.dell.com/support/article/sln308699 . |
| OpenManage Deployment Toolkit | www.dell.com/openmanagemanuals > OpenManage Deployment Toolkit |
| Dell certified VMware ESXi | www.dell.com/virtualizationsolutions |

NOTE: For more information about installation and how-to videos for operating systems supported on PowerEdge systems, see [Supported Operating Systems for Dell EMC PowerEdge systems](#).

Options to download firmware

You can download firmware from the Dell support site. For information about downloading firmware, see the [Downloading drivers and firmware](#) section.

You can also choose any one of the following options to download the firmware. For information about how to download the firmware, see the documentation links provided in the table below.

Table 11. Options to download firmware

| Option | Documentation link |
|---|--|
| Using Integrated Dell Remote Access Controller Lifecycle Controller (iDRAC with LC) | www.dell.com/idracmanuals |
| Using Dell Repository Manager (DRM) | www.dell.com/openmanagemanuals > Repository Manager |
| Using Dell Server Update Utility (SUU) | www.dell.com/openmanagemanuals > Server Update Utility |

Table 11. Options to download firmware (continued)

| Option | Documentation link |
|--|--|
| Using Dell OpenManage Deployment Toolkit (DTK) | www.dell.com/openmanagemanuals > OpenManage Deployment Toolkit |
| Using iDRAC virtual media | www.dell.com/idracmanuals |

Options to download and install OS drivers

You can choose any one of the following options to download and install OS drivers. For information about how to download or install OS drivers, see the documentation links provided in the table below.

Table 12. Options to download and install OS drivers

| Option | Documentation |
|-----------------------|--|
| Dell EMC support site | Downloading drivers and firmware section. |
| iDRAC virtual media | <i>Integrated Dell Remote Access Controller User's Guide</i> at https://www.dell.com/idracmanuals or for system specific <i>Integrated Dell Remote Access Controller User's Guide</i> , go to https://www.dell.com/poweredgemanuals > Product Support page of your system > Documentation .  NOTE: To determine the most recent iDRAC release for your platform and for latest documentation version, see https://www.dell.com/support/article/sln308699 . |

Downloading drivers and firmware

It is recommended that you download and install the latest BIOS, drivers, and systems management firmware on the system.

Prerequisites

Ensure that you clear the web browser cache before downloading the drivers and firmware.

Steps

1. Go to www.dell.com/support/drivers.
2. Enter the Service Tag of the system in the **Enter a Dell Service Tag, Dell EMC Product ID or Model** field, and then press Enter.

 **NOTE:** If you do not have the Service Tag, click **Browse all products**, and navigate to your product.

3. On the displayed product page, click **Drivers & Downloads**.
On the **Drivers & Downloads** page, all drivers that are applicable to the system are displayed.
4. Download the drivers to a USB drive, CD, or DVD.

Minimum to POST and system management configuration validation

This section describes the minimum to POST system requirement and system management configuration validation of the Dell EMC system.

Topics:

- [Minimum configuration to POST](#)
- [Configuration validation](#)

Minimum configuration to POST

The components listed below are the minimum configuration to POST:

- One processor (CPU) in socket processor 1
- One memory module (DIMM) in socket A1
- One power supply unit
- System board + LOM card + RIO card

Configuration validation

The new generation of PowerEdge systems have added interconnect flexibility and advanced iDRAC management features to collect precise system configuration information and report configuration errors.

When the system is powered on, information about installed cables, risers, backplanes, floating card (fPERClike BOSS), and processor is obtained from the CPLD and backplane memory maps is analyzed. This information forms a unique configuration, which is compared with one of the qualified configurations stored in a table maintained by iDRAC.

One or more sensors are assigned to each of the configuration elements. During POST, any configuration validation error is logged in the System Event Log (SEL)/LifeCycle (LC) log. The reported events are categorized in the configuration validation error table.

Table 13. Configuration validation error

| Error | Description | Possible cause and recommendations | Example |
|----------------|---|--|---|
| Config Error | A configuration element within the closest match contains something that is unexpected and does not match any Dell qualified configuration. | Wrong configuration | Config Error: Backplane cable CTRS_SRC_SA1 and BP-DST_SA1 |
| | | The element reported in HWC8010 errors are assembled incorrectly. Verify element (cable, risers, etc) placement in the system. | Config Error : SL Cable PLANAR_SL7 and CTRL_DST_PA1 |
| Config Missing | iDRAC found a configuration element missing within the closest match detected. | Missing or damaged cable, device, or part | Config Missing: Float card front PERC/HBA |
| | | Missing element or cable is reported in HWC8010 error logs. Install the | Config Missing : SL cable PLANAR_SL8 and CTRL_DST_PA1 |

Table 13. Configuration validation error (continued)

| Error | Description | Possible cause and recommendations | Example |
|------------|---|--|-------------------------|
| | | missing element (cable, risers, etc). | |
| Comm Error | A configuration element is not responding to iDRAC using the management interface while running an inventory check. | System management sideband communication Unplug AC Power, reseal the element and replace the element if the problem persists. | Comm Error: Backplane 2 |

Error messages

This section describes the error messages displayed on the screen during POST or captured in the system event log (SEL)/ LifeCycle (LC) log.

Table 14. Error message HWC8010

| Error code | HWC8010 |
|-----------------------------|---|
| Message | The System Configuration Check operation resulted in the following issue involving the indicated component type |
| Arguments | Riser, floating card (fPERClike BOSS), backplane, processor, cable, or other components |
| Detailed Description | The issue identified in the message is observed in the System Configuration Check operation. |
| Recommended Response Action | Do the following and retry the operation: <ol style="list-style-type: none"> 1. Disconnect the input power. 2. Check for proper cable connection and component placement. If the issue persists, contact the service provider. |
| Category | System Health (HWC = Hardware Config) |
| Severity | Critical |
| Trap/EventID | 2329 |

Table 15. Error message HWC8011

| Error code | HWC8011 |
|-----------------------------|---|
| Message | The System Configuration Check operation resulted in multiple issues involving the indicated component type |
| Arguments | Riser, floating card (fPERClike BOSS), backplane, processor, cable, or other components |
| Detailed Description | Multiple issues are observed in the System Configuration Check operation. |
| Recommended Response Action | Do the following and retry the operation: <ol style="list-style-type: none"> 1. Disconnect the input power. 2. Check for proper cable connection and component placement. If the issue persists, contact the service provider. |
| Category | System Health (HWC = Hardware Config) |
| Severity | Critical |

Installing and removing system components

Topics:

- Safety instructions
- Before working inside your system
- After working inside your system
- Recommended tools
- Cable routing
- Optional front bezel
- System cover
- Drive backplane cover
- Air shroud
- Cooling fans
- Drives
- Drive backplane
- Rear mounting front PERC module
- Rear drive module
- System memory
- Processor and heat sink module
- Expansion cards and expansion card risers
- Intrusion switch module
- M.2 SSD module on BOSS-S1 adapter card
- Optional BOSS S2 module
- Optional IDSDM module
- MicroSD card
- Optional OCP card
- System battery
- Optional internal USB card
- VGA module
- Power supply unit
- Optional serial COM port
- System board
- Trusted Platform Module
- LOM and rear IO card
- Control panel

Safety instructions

 **NOTE:** Whenever you need to lift the system, get others to assist you. To avoid injury, do not attempt to lift the system by yourself.

 **CAUTION:** Ensure that two or more people lift the system horizontally from the box and place it on a flat surface, rack lift, or into the rails.

 **WARNING:** Opening or removing the system cover while the system is powered on may expose you to a risk of electric shock.

 **WARNING:** Do not operate the system without the cover for a duration exceeding five minutes. Operating the system without the system cover can result in component damage.

CAUTION: Many repairs may only be done by a certified service technician. You should only perform troubleshooting and simple repairs as authorized in your product documentation, or as directed by the online or telephone service and support team. Damage due to servicing that is not authorized by Dell is not covered by your warranty. Read and follow the safety instructions that are shipped with your product.

NOTE: It is recommended that you always use an antistatic mat and antistatic strap while working on components inside the system.

CAUTION: To ensure proper operation and cooling, all system bays and fans must always be populated with a component or a blank.

NOTE: While replacing the hot swappable PSU, after next server boot; the new PSU automatically updates to the same firmware and configuration of the replaced one. For updating to the latest firmware and changing the configuration, see the *Lifecycle Controller User's Guide* at <https://www.dell.com/idracmanuals>.

NOTE: While replacing faulty storage controller, FC, or NIC card with the same type of card, after you power on the system; the new card automatically updates to the same firmware and configuration of the faulty one. For updating to the latest firmware and changing the configuration, see the *Lifecycle Controller User's Guide* at <https://www.dell.com/idracmanuals>.

CAUTION: Do not install GPUs, network cards, or other PCIe devices on your system that are not validated and tested by Dell. Damage caused by unauthorized and invalidated hardware installation will null and void the system warranty.

Before working inside your system

Prerequisites

Follow the safety guidelines listed in the [Safety instructions](#).

Steps

1. Power off the system and all attached peripherals.
2. Disconnect the system from the electrical outlet, and disconnect the peripherals.
3. If applicable, remove the system from the rack.
For more information, see the *Rail Installation Guide* relevant to your rail solutions at www.dell.com/poweredge manuals.
4. Remove the system cover.

After working inside your system

Prerequisites

Follow the safety guidelines listed in [Safety instructions](#).

Steps

1. Replace the system cover.
2. If applicable, install the system into the rack.
For more information, see the *Rail Installation Guide* relevant to your system at www.dell.com/poweredge manuals.
3. Reconnect the peripherals and connect the system to the electrical outlet, and then power on the system.

Recommended tools

You may need any or combination of the following tools to perform the removal and installation procedures:

- Key to the bezel lock. The key is required only if your system includes a bezel.
- Phillips 1 screwdriver

- Phillips 2 screwdriver
- Torx T30 screwdriver
- 5 mm hex nut screwdriver
- Plastic scribe
- 1/4-inch flat blade screwdriver
- Wrist grounding strap connected to the ground
- ESD mat
- Needle-nose pliers

You need the following tools to assemble the cables for a DC power supply unit:

- AMP 90871-1 hand-crimping tool or equivalent
- Tyco Electronics 58433-3 or equivalent
- Wire-stripper pliers to remove insulation from size 10 AWG solid or stranded, insulated copper wire

NOTE: Use alpha wire part number 3080 or equivalent (65/30 stranding).

Cable routing

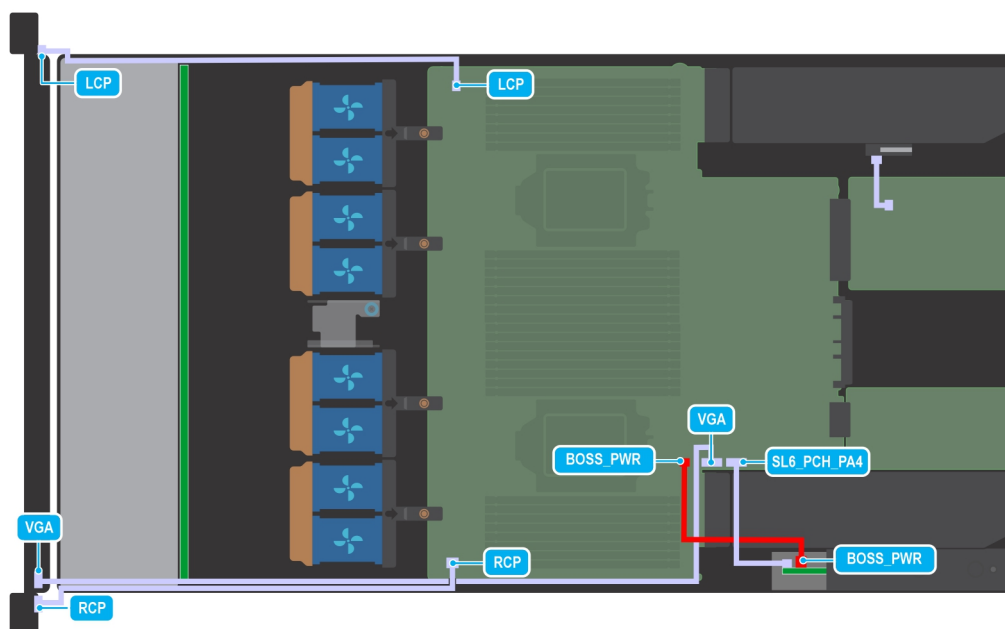

Figure 16. Control panels and intrusion switch

Table 16. Control panels, BOSS S2 and VGA cabling

| From | To |
|--|---|
| Left control panel connector | Left control panel (LCP) |
| Right control panel connector | Right control panel (RCP) |
| Front VGA connector | VGA on RCP |
| BOSS_CARD_PWR (BOSS S2 module power connector on system board) | BOSS_PWR (BOSS S2 module power connector on BOSS S2 module) |
| SL6_PCH_PA4 (BOSS signal connector on system board) | BOSS signal on BOSS S2 card module |

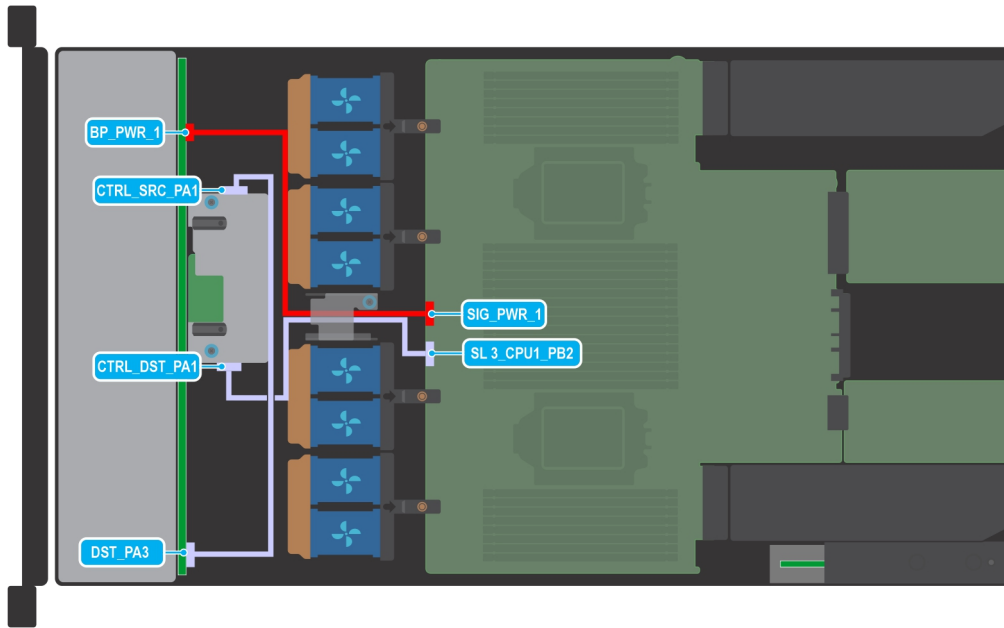

Figure 17. 10 x 2.5-inch SAS with fPERC

Table 17. 10 x 2.5-inch SAS with fPERC

| From | To |
|--|---|
| SIG_PWR_1 (system board power connector) | BP_PWR (backplane power connector) |
| CTRL_DST_PA1 (fPERC input connector) | SL3_CPU1_PB2 (Signal connector on system board) |
| CTRL_SRC_PA1 (fPERC output connector) | DST_PA3 (backplane signal connector) |

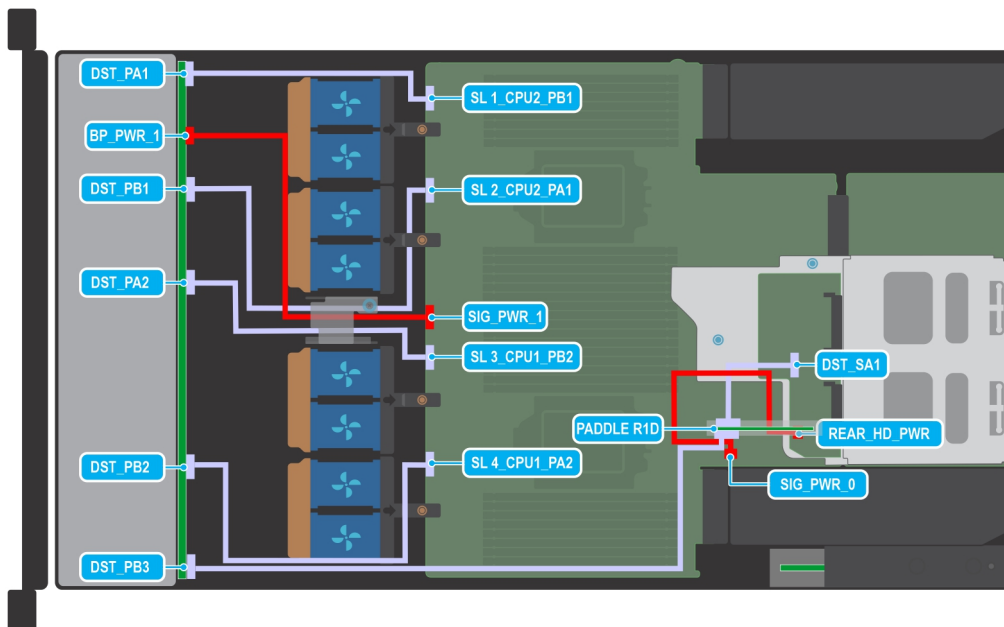

Figure 18. 10 x 2.5-inch NVMe and 2 x 2.5-inch NVMe

Table 18. 10 x 2.5-inch NVMe and 2 x 2.5-inch NVMe

| From | To |
|---|--|
| SL1_CPU2_PB1 (Signal connector on system board) | DST_PA1 (backplane signal connector) |
| SL2_CPU2_PA1 (Signal connector on system board) | DST_PB1 (backplane signal connector) |
| SL3_CPU1_PB2 (Signal connector on system board) | DST_PA2 (backplane signal connector) |
| SL4_CPU1_PA2 (Signal connector on system board) | DST_PB2 (backplane signal connector) |
| PADDLE R1d (Paddle R1d connector on system board) | DST_PA3 (backplane signal connector) |
| SIG_PWR_1 (system board power connector) | BP_PWR (backplane power connector) |
| SIG_PWR_0 (system board power connector) | REAR_HDD_PWR (Rear HDD module power connector) |
| PADDLE R1d (Paddle R1d connector on system board) | DST_SA1 (rear backplane signal connector) |

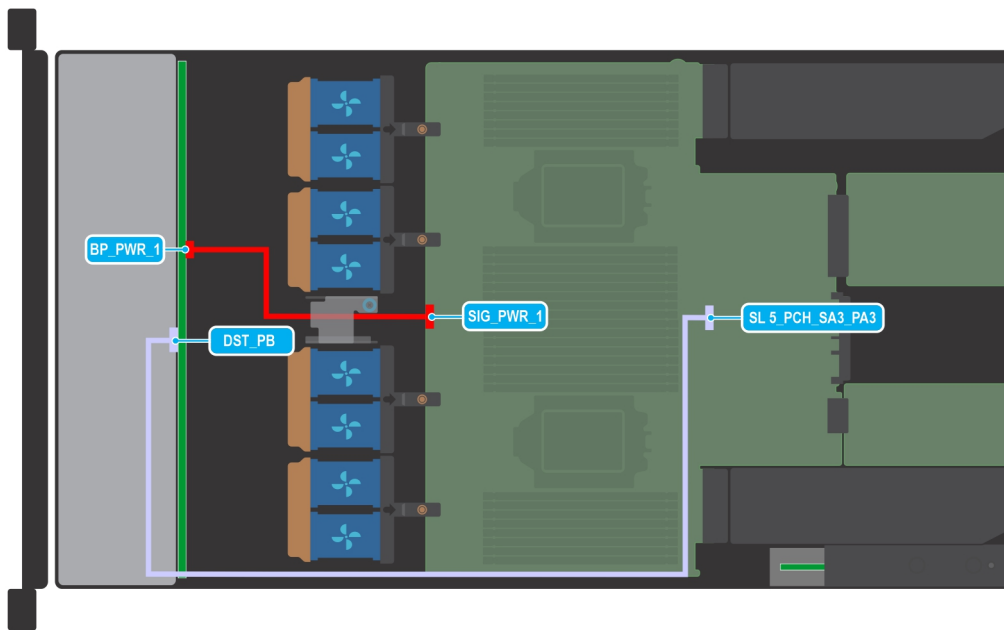

Figure 19. 4 x 3.5-inch chipset SATA

Table 19. 4 x 3.5-inch chipset SATA

| From | To |
|--|--------------------------------------|
| SIG_PWR_1 (system board power connector) | BP_PWR_1 (backplane power connector) |
| SL5_PCH_SA3_PA3 (Signal connector on system board) | DST_PB (backplane signal connector) |

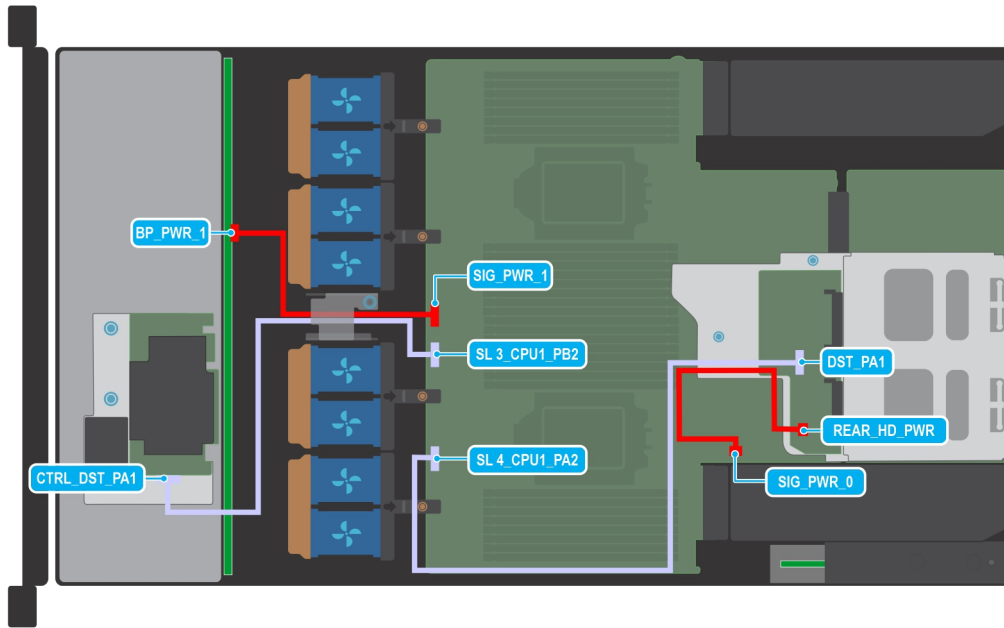

Figure 20. 4 x 3.5-inch SAS/SATA with fPERC and 2 x 2.5 rear drives

Table 20. 4 x 3.5-inch SAS/SATA with fPERC and 2 x 2.5 rear drives

| From | To |
|---|--|
| SIG_PWR_1 (system board power connector) | BP_PWR (backplane power connector) |
| SL3_CPU1_PB2 (Signal connector on system board) | CTRL_DST_PA1 (fPERC connector) |
| SL4_CPU1_PA2 (Signal connector on system board) | DST_PA1 (rear backplane signal connector) |
| SIG_PWR_0 (system board power connector) | REAR_HDD_PWR (Rear HDD module power connector) |

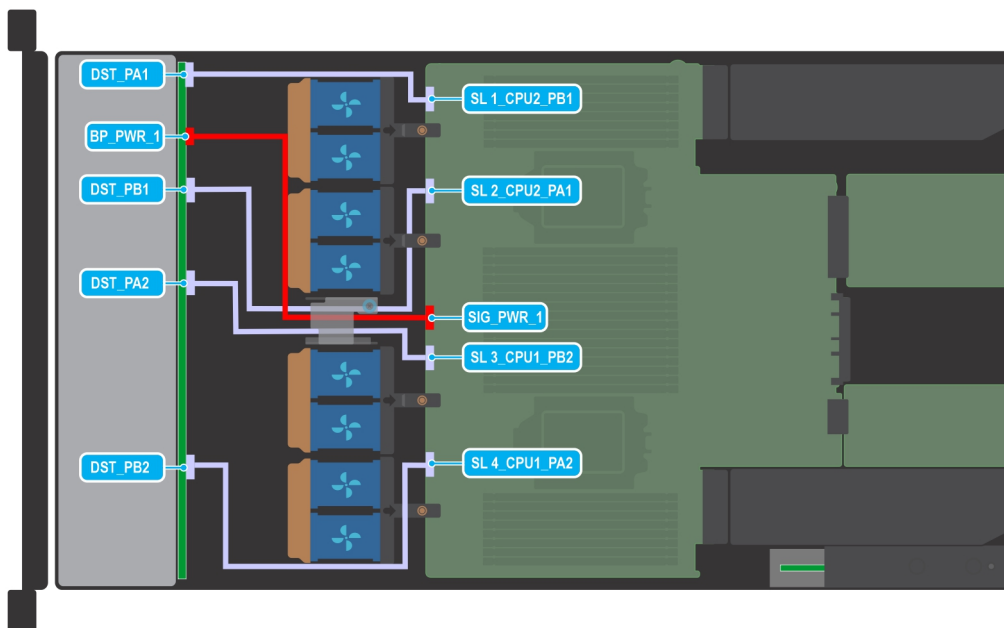

Figure 21. 8 x 2.5-inch NVMe without fPERC

Table 21. 8 x 2.5-inch NVMe without fPERC

| From | To |
|---|--------------------------------------|
| SL1_CPU2_PB1 (Signal connector on system board) | DST_PA1 (backplane signal connector) |
| SL2_CPU2_PA1 (Signal connector on system board) | DST_PB1 (backplane signal connector) |
| SL3_CPU1_PB2 (Signal connector on system board) | DST_PA2 (backplane signal connector) |
| SL4_CPU1_PA2 (Signal connector on system board) | DST_PB2 (backplane signal connector) |
| SIG_PWR_1 (system board power connector) | BP_PWR (backplane power connector) |

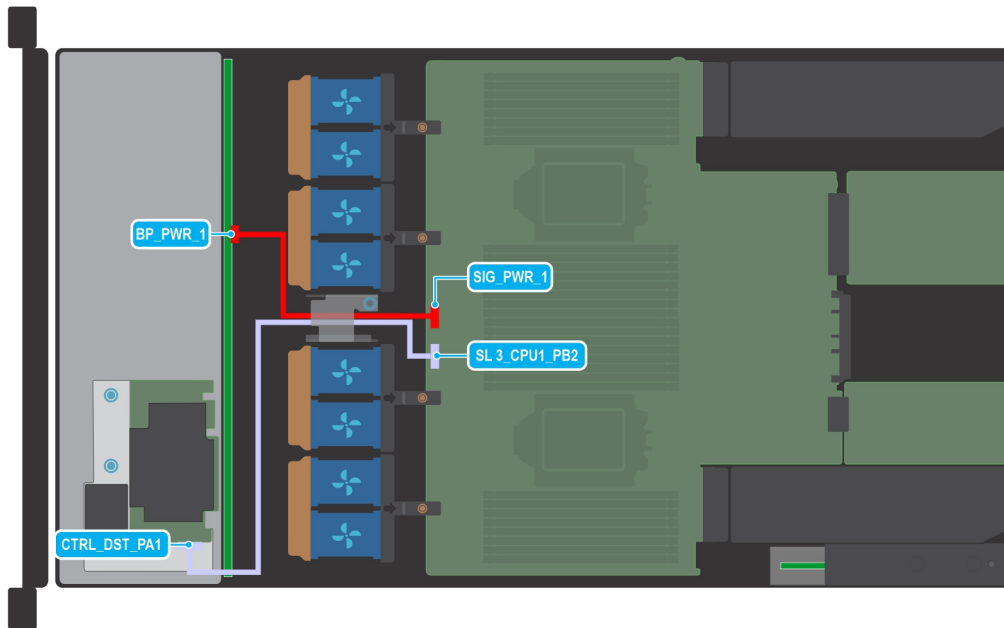

Figure 22. 8 x 2.5-inch SAS with front PERC module

Table 22. 8 x 2.5-inch SAS with front PERC module

| From | To |
|--|---|
| SIG_PWR_1 (system board power connector) | BP_PWR (backplane power connector) |
| CTRL_DST_PA1 (fPERC connector) | SL3_CPU1_PB2 (Signal connector on system board) |

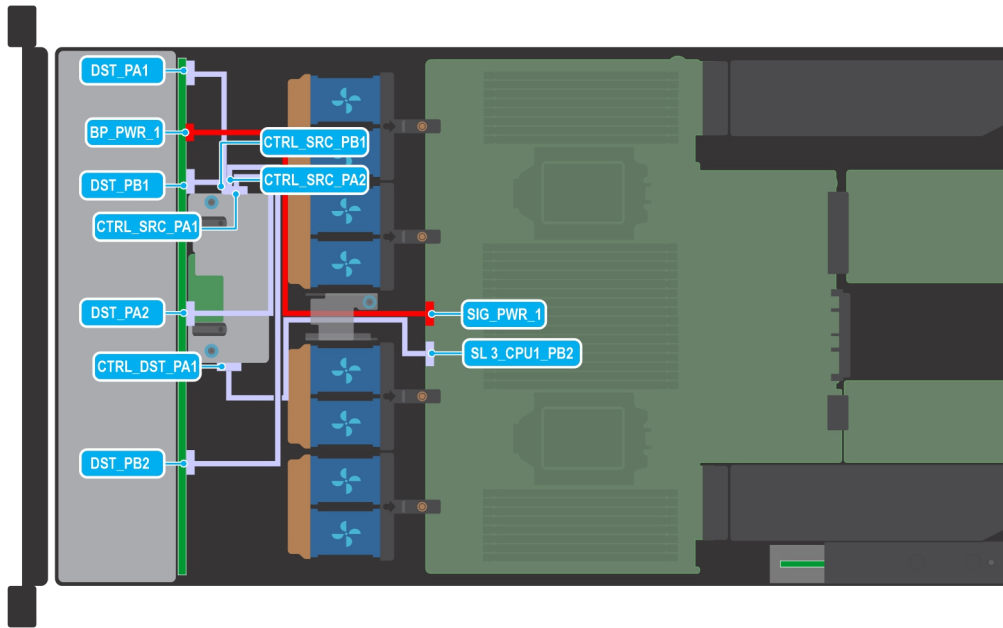

Figure 23. 8 x 2.5-inch all NVME with front PERC module

Table 23. 8 x 2.5-inch all NVME with front PERC module

| From | To |
|--|---|
| CTRL_SRC_PA1 (PERC controller connector) | DST_PA1 (backplane signal connector) |
| CTRL_SRC_PB1 (PERC controller connector) | DST_PB1 (backplane signal connector) |
| CTRL_SRC_PA2 (PERC controller connector) | DST_PA2 (backplane signal connector) |
| CTRL_SRC_PB2 (PERC controller connector) | DST_PB2 (backplane signal connector) |
| CTRL_DST_PA1 (PERC controller connector) | SL3_CPU1_PB2 (Signal connector on system board) |
| SIG_PWR_1 (system board power connector) | BP_PWR (backplane power connector) |

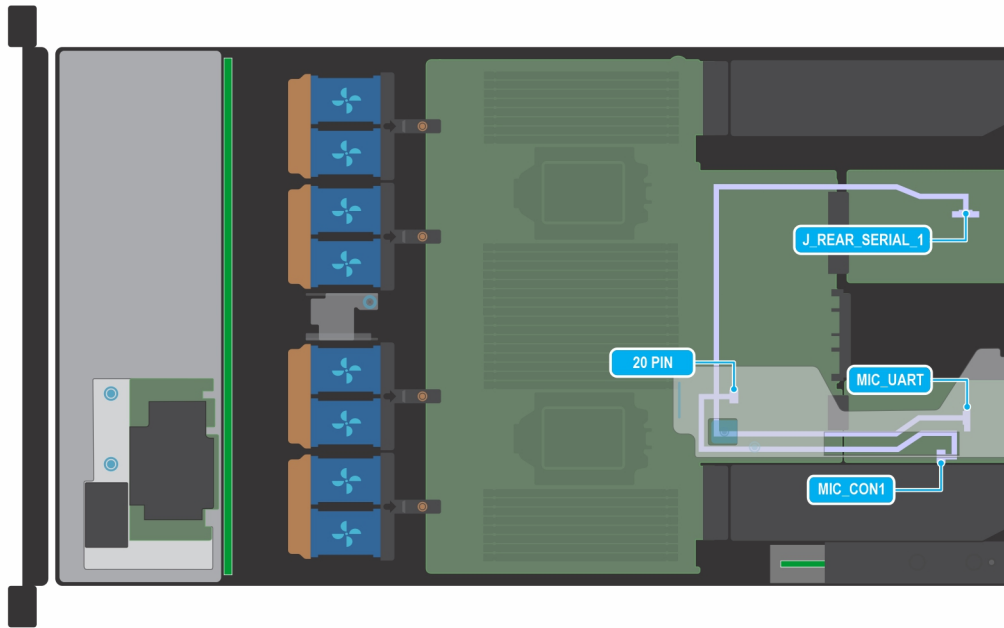

Figure 24. Management Interface Card (MIC)

Table 24. Management Interface Card (MIC)

| From | To |
|---|--------------------------|
| J_REAR_SERIAL_1 (Rear I/O card connector) | MIC_UART (MIC connector) |
| MIC_CON1 (System board connector) | 20 PIN (MIC connector) |

Optional front bezel

NOTE: LCD panel is optional on the front bezel. If the front bezel has an LCD panel, see [LCD panel](#) section.

Removing the front bezel

The procedure to remove the front bezel with and without the LCD panel is the same.

Prerequisites

1. Follow the safety guidelines listed in the [Safety instructions](#).
2. Keep the bezel key handy.

NOTE: The bezel key is part of the LCD bezel package.

Steps

1. Unlock the bezel.
2. Press the release button, and disengage the left end of the bezel.
3. Unhook the right end, and remove the bezel.



Figure 25. Removing the front bezel with the LCD panel

Next steps

Replace the front bezel.

Installing the front bezel

The procedure to install the front bezel with and without the LCD panel is the same.

Prerequisites

1. Follow the safety guidelines listed in the [Safety instructions](#).
2. Locate and remove the bezel key.

NOTE: The bezel key is part of the LCD bezel package.

Steps

1. Align and insert the tabs on the bezel into the slots on the system.
2. Press the bezel until the release button clicks in place.
3. Lock the bezel.



Figure 26. Installing the front bezel with the LCD panel

System cover

Removing the system cover

Prerequisites

1. Follow the safety guidelines listed in the [Safety instructions](#).
2. Power off the system, and any attached peripherals.
3. Disconnect the system from the electrical outlet and peripherals.

Steps

1. Using a 1/4-inch flat head or a Phillips #2 screwdriver rotate the lock counterclockwise to the unlock position.
2. Lift the release latch until the system cover slides back.
3. Lift the cover from the system.

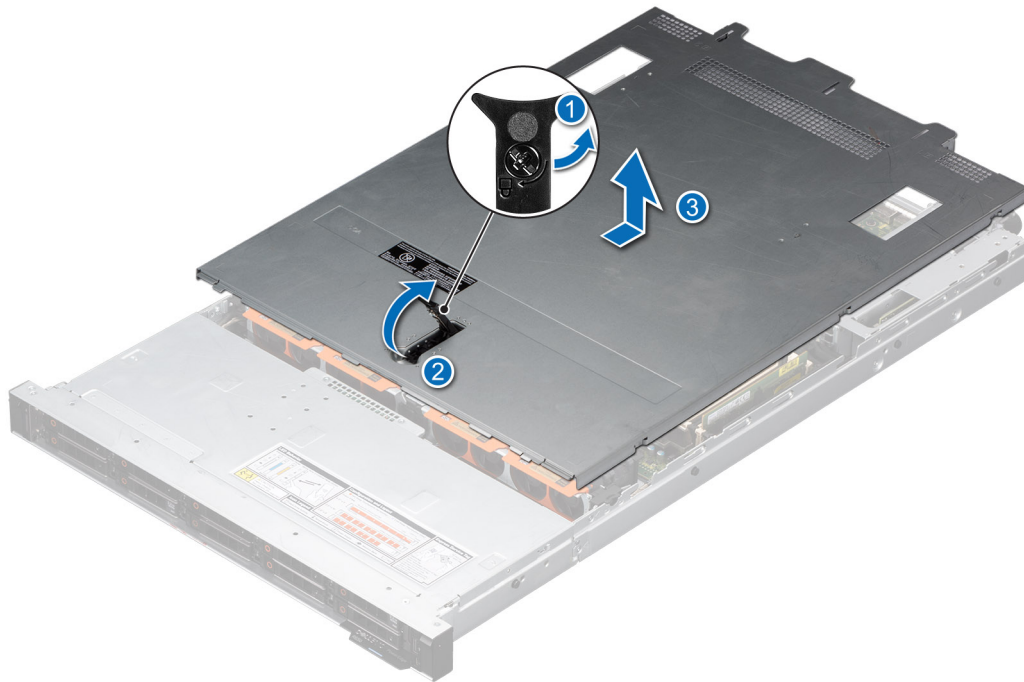

Figure 27. Removing the system cover

Next steps

1. [Replace the system cover.](#)

Installing the system cover

Prerequisites

1. Follow the safety guidelines listed in the [Safety instructions](#).
2. Follow the procedure listed in [Before working inside your system](#).
3. Ensure that all internal cables are connected and routed properly, and no tools or extra parts are left inside the system.

Steps

1. Align the tabs on the system cover with the guide slots on the system and slide the system cover.
2. Close the system cover release latch.
3. Using a 1/4-inch flat head or Phillips #2 screwdriver, rotate the lock clockwise to the lock position.

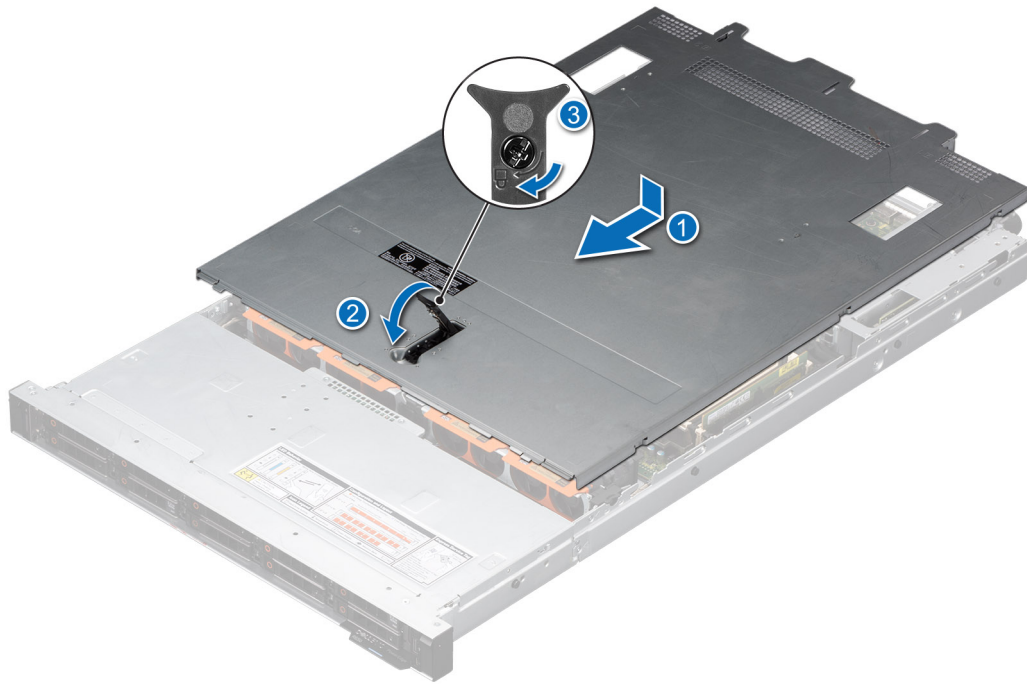

Figure 28. Installing the system cover

Drive backplane cover

Removing the drive backplane cover

Prerequisites

1. Follow the safety guidelines listed in the [Safety instructions](#).
2. Follow the procedure listed in [Before working inside your system](#).

Steps

1. Slide the backplane cover in the direction of the arrows marked on the drive backplane cover.
2. Lift the backplane cover from the system.

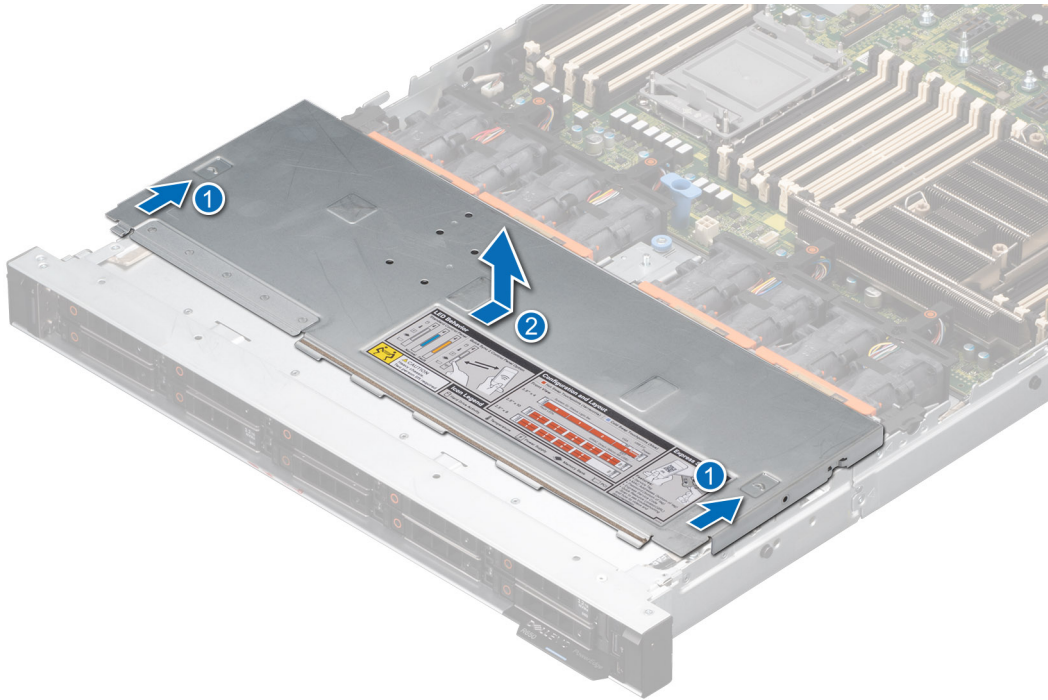

Figure 29. Removing the drive backplane cover

Next steps

1. [Replace the drive backplane cover.](#)

Installing the drive backplane cover

Prerequisites

1. Follow the safety guidelines listed in the [Safety instructions](#).

Steps

1. Align the drive backplane cover with the guide slots on the system.
2. Slide the drive backplane cover to the front of the system until the drive backplane cover fits into place.

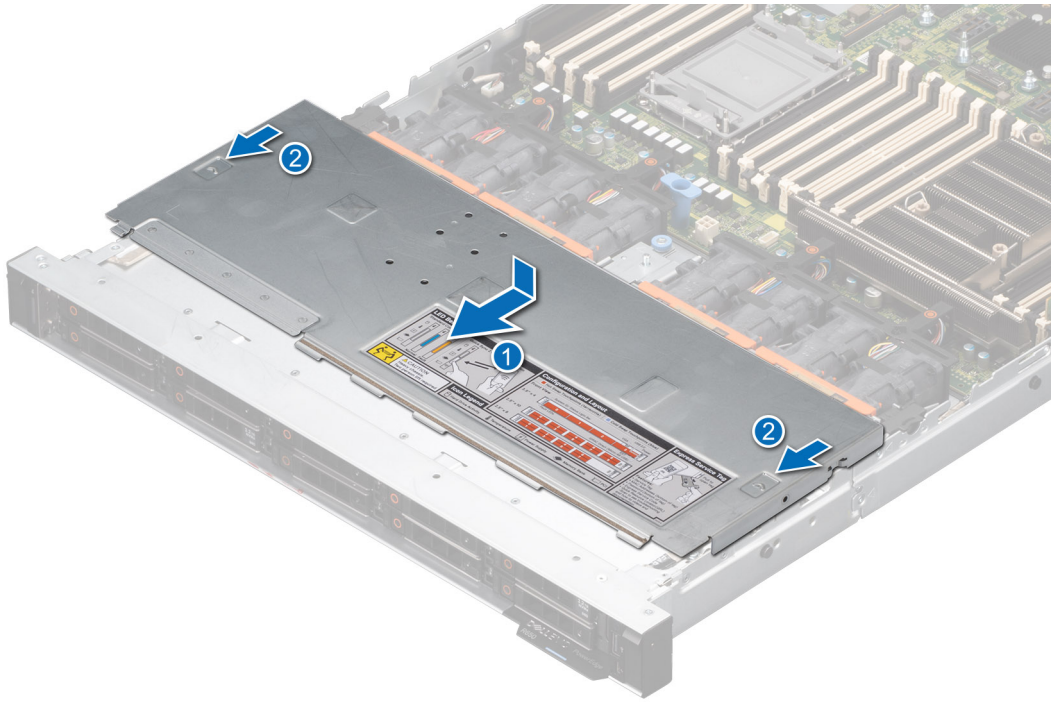

Figure 30. Installing the drive backplane cover

Next steps

1. Follow the procedure listed in [After working inside your system.](#)

Air shroud

Removing the air shroud

Prerequisites

CAUTION: Never operate your system with the air shroud removed. The system may get overheated quickly, resulting in shutdown of the system and loss of data.

1. Follow the safety guidelines listed in the [Safety instructions](#).
2. Follow the procedure listed in [Before working inside your system](#).

Steps

1. Hold the edges of the air shroud, and lift the air shroud out of the system.

NOTE: Air shroud is not supported for T-type heat sink and liquid cooling configurations.

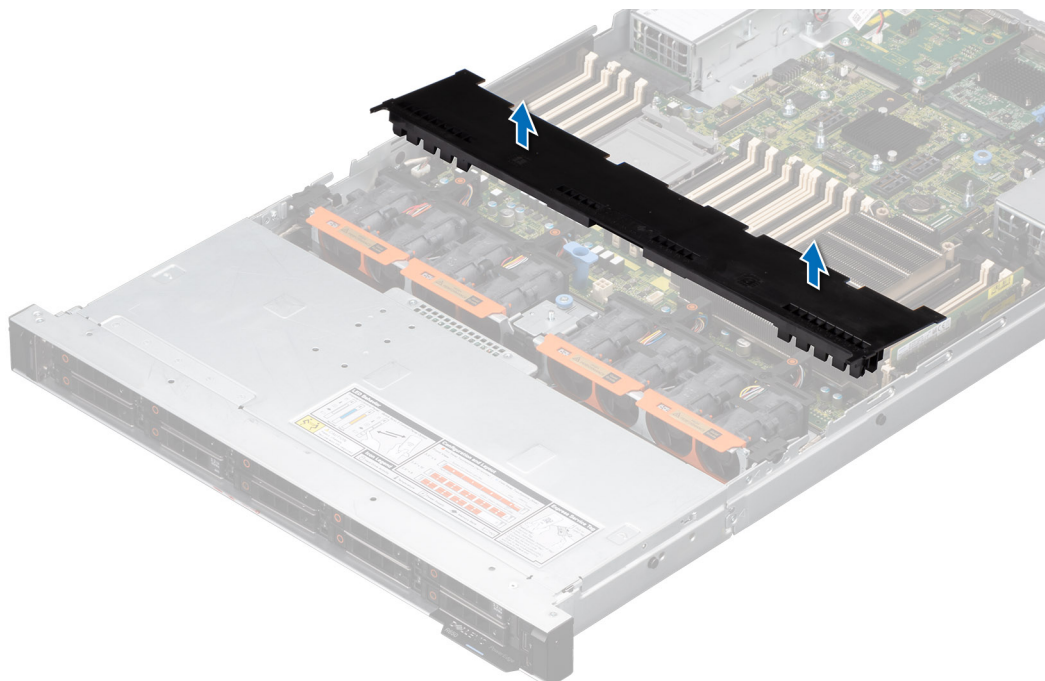

Figure 31. Removing the air shroud

2. For the air shroud on the rear drive module, hold the edges of the air shroud, and lift the air shroud out of the rear drive module.

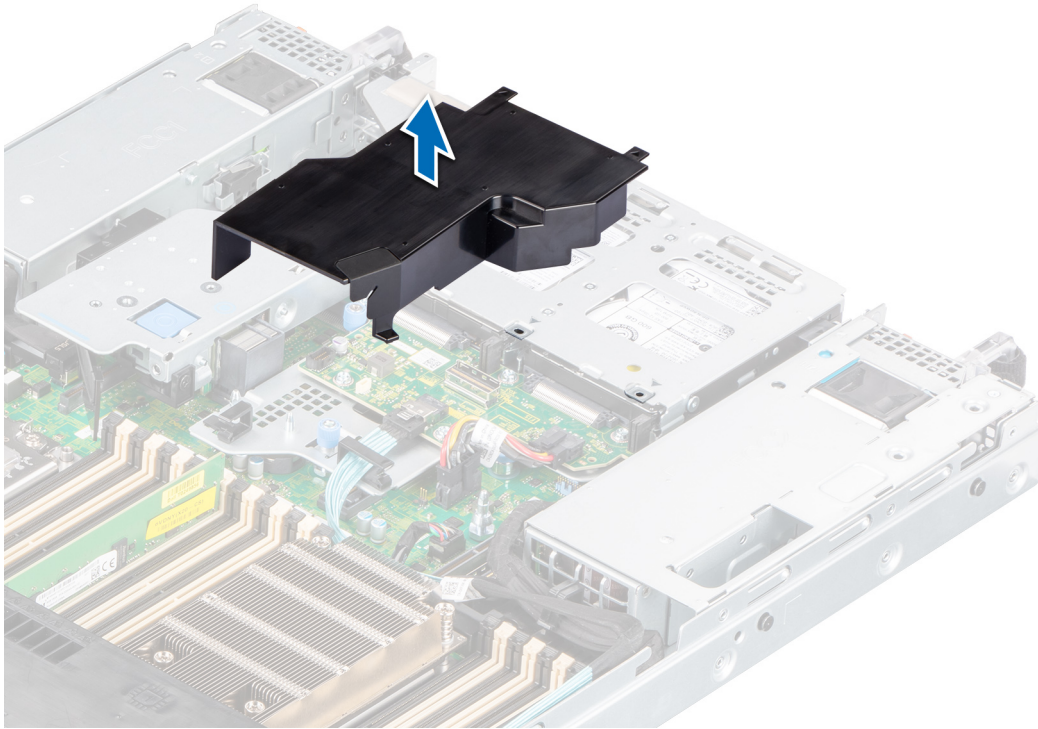

Figure 32. Removing the air shroud from the rear drive module

Next steps

1. [Replace the air shroud.](#)

Installing the air shroud

Prerequisites

1. Follow the safety guidelines listed in the [Safety instructions](#).
2. Follow the procedure listed in [Before working inside your system](#).

Steps

1. Holding the edges of the air shroud, align the slot on the air shroud with the standoff on the system.
2. Lower the air shroud into the system until it is firmly seated.

NOTE: Air shroud is not supported for T-type heat sink and liquid cooling configurations.

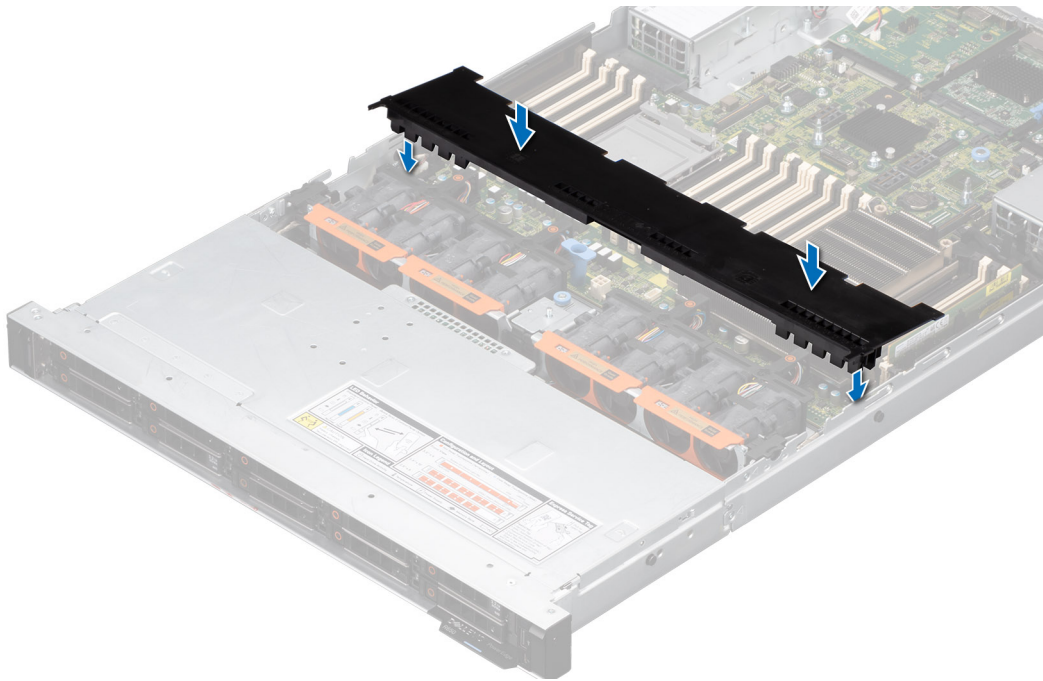

Figure 33. Installing the air shroud

3. For the air shroud on the rear drive module, lower the air shroud into the rear drive module until it is firmly seated.

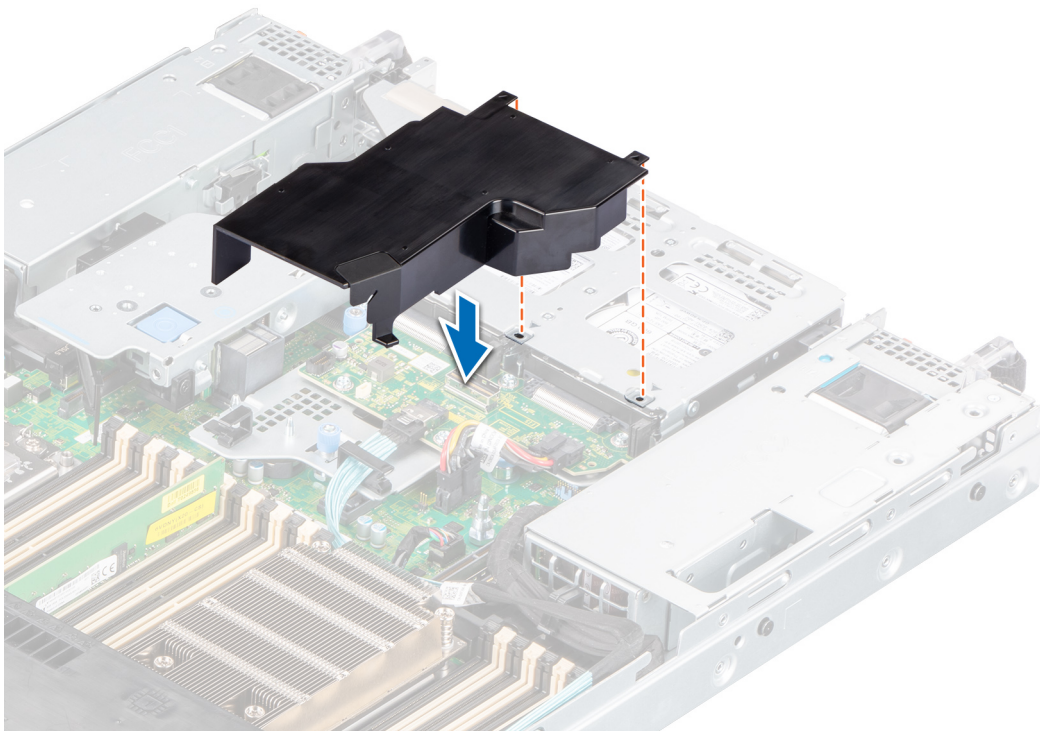

Figure 34. Installing the air shroud on the rear drive module

Next steps

1. Follow the procedure listed in [After working inside your system.](#)

Cooling fans

Removing a cooling fan module

Prerequisites

1. Follow the safety guidelines listed in the [Safety instructions](#).
2. Follow the procedure listed in [Before working inside your system](#).
3. If installed, [remove the air shroud](#).

Steps

Holding the orange and black edges on the fan module, lift the cooling fan module to disconnect from the connector on the system board.

NOTE: The procedure to remove standard (STD), high performance silver grade (HPR SLVR), or high performance gold grade (HPR Gold) dual cooling fan modules are same.

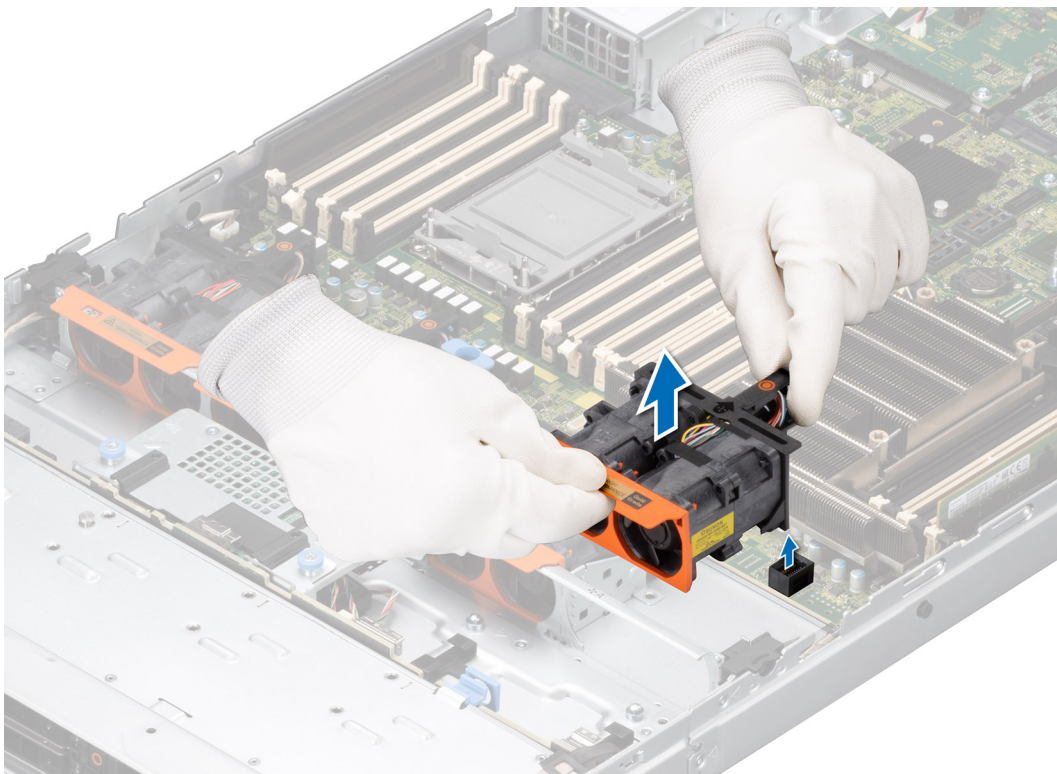

Figure 35. Removing a cooling fan module

WARNING: Ensure not to tilt or rotate the cooling fan module while removing from the system.

Next steps

1. [Replace a cooling fan module](#).

Installing a cooling fan module

Prerequisites

1. Follow the safety guidelines listed in the [Safety instructions](#).
2. Follow the procedure listed in [Before working inside your system](#).

3. If installed, [remove the air shroud](#).

Steps

1. Align and place the fan module connector horizontally with the connector on the system board.

i **NOTE:** The procedure to remove standard (STD), high performance silver grade (HPR SLVR), or high performance gold grade (HPR Gold) dual cooling fan modules are same.

2. Press the touch point on the cooling fan module until firmly connected.

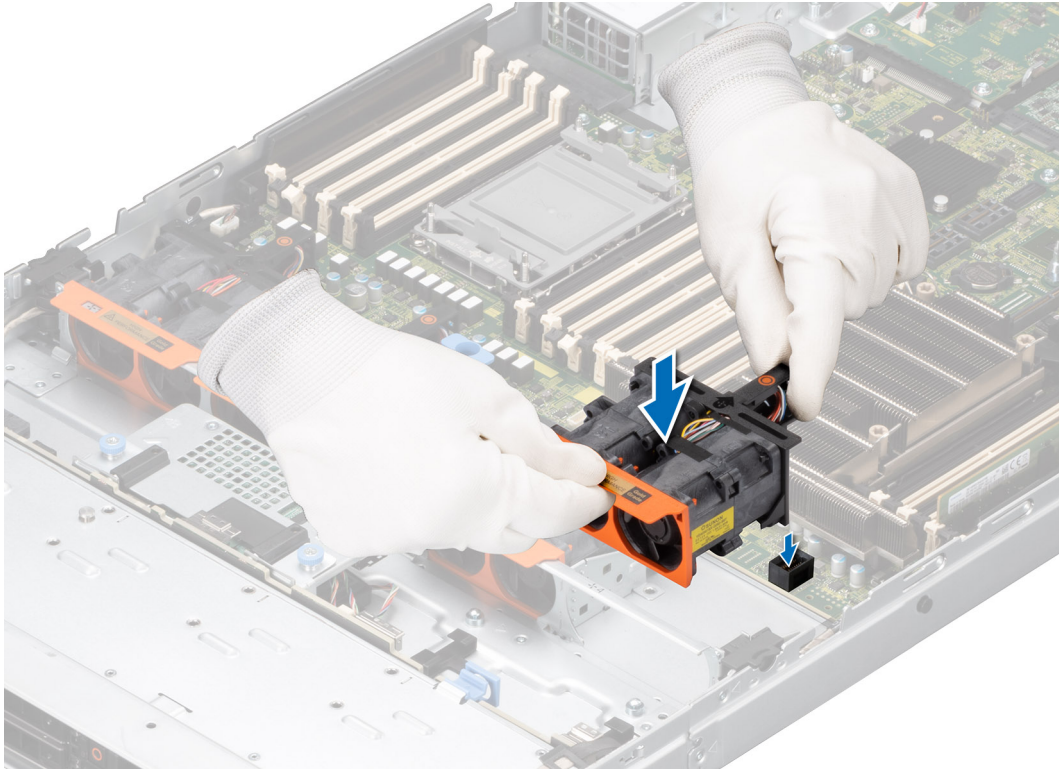

Figure 36. Installing a cooling fan module

Next steps

1. If applicable, [install the air shroud](#).
2. Follow the procedure listed in [After working inside your system](#).

Drives

Removing a drive blank

Prerequisites

1. Follow the safety guidelines listed in the [Safety instructions](#).
2. If installed, [remove the front bezel](#).

⚠ CAUTION: To maintain proper system cooling, drive blanks must be installed in all empty drive slots.

Steps

Press the release button, and slide the drive blank out of the drive slot.

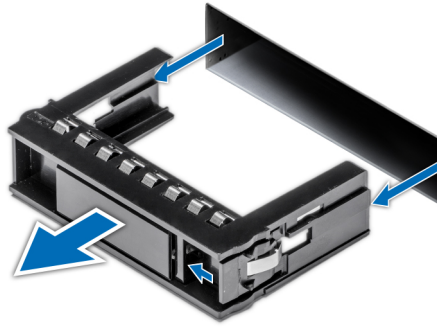

Figure 37. Removing a drive blank

Next steps

Installing a drive or replace the drive blank.

Installing a drive blank

Prerequisites

1. Follow the safety guidelines listed in the [Safety instructions](#).
2. If installed, [remove the front bezel](#).

Steps

Insert the drive blank into the drive slot until the release button clicks into place.

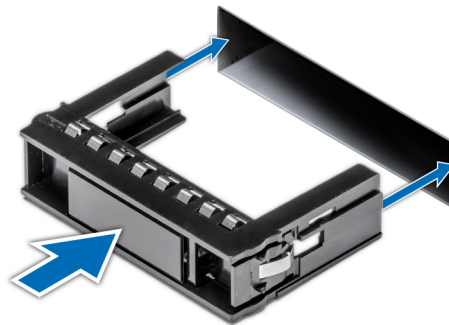

Figure 38. Installing a drive blank

Next steps

If removed, [install the front bezel](#).

Removing the drive carrier

Prerequisites

1. Follow the safety guidelines listed in the [Safety instructions](#).
2. If installed, [remove the front bezel](#).
3. Using the management software, prepare the drive for removal. If the drive is online, the green activity or fault indicator blinks while the drive is powering off. When the drive indicators are off, the drive is ready for removal. For more information, see the documentation for the storage controller.

CAUTION: Before attempting to remove or install a drive while the system is running, see the documentation for the storage controller card to ensure that the host adapter is configured correctly to support drive removal and insertion.

CAUTION: To prevent data loss, ensure that your operating system supports drive installation. See the documentation supplied with your operating system.

Steps

1. Press the release button to open the drive carrier release handle.
2. Holding the drive carrier release handle, slide the drive carrier out of the drive slot.



Figure 39. Removing a drive carrier

Next steps

Install a drive carrier or drive blank.

Installing the drive carrier

Prerequisites

CAUTION: Before removing or installing a drive while the system is running, see the documentation for the storage controller card to ensure that the host adapter is configured correctly to support drive removal and insertion.

CAUTION: Combining SAS and SATA drives in the same RAID volume is not supported.

CAUTION: When installing a drive, ensure that the adjacent drives are fully installed. Inserting a drive carrier and attempting to lock its handle next to a partially installed carrier can damage the partially installed carrier's shield spring and make it unusable.

CAUTION: To prevent data loss, ensure that your operating system supports hot-swap drive installation. See the documentation supplied with your operating system.

CAUTION: When a replacement hot swappable drive is installed and the system is powered on, the drive automatically begins to rebuild. Ensure that the replacement drive is blank or contains data that you wish to overwrite. Any data on the replacement drive is immediately lost after the drive is installed.

NOTE: Ensure that the drive carrier's release handle is in the open position before inserting the carrier into the slot.

1. Follow the safety guidelines listed in the [Safety instructions](#).
2. If installed, [remove the front bezel](#).
3. Remove the drive carrier or remove the drive blank when you want to assemble the drives in to the system.

Steps

1. Hold the release handle and slide the drive carrier into the drive slot.
2. Close the drive carrier release handle to lock the drive in place.



Figure 40. Installing a drive carrier

Next steps

If removed, [install the front bezel](#).

Removing the drive from the drive carrier

Prerequisites

1. Follow the safety guidelines listed in the [Safety instructions](#).

Steps

1. Using a Phillips #1 screwdriver, remove the screws from the slide rails on the drive carrier.

NOTE: If the hard drive or SSD carrier has Torx screw, use Torx 6 (for 2.5-inch drive) or Torx 8 (for 3.5-inch drive) screwdriver to remove the drive. 

2. Lift the drive out of the drive carrier.

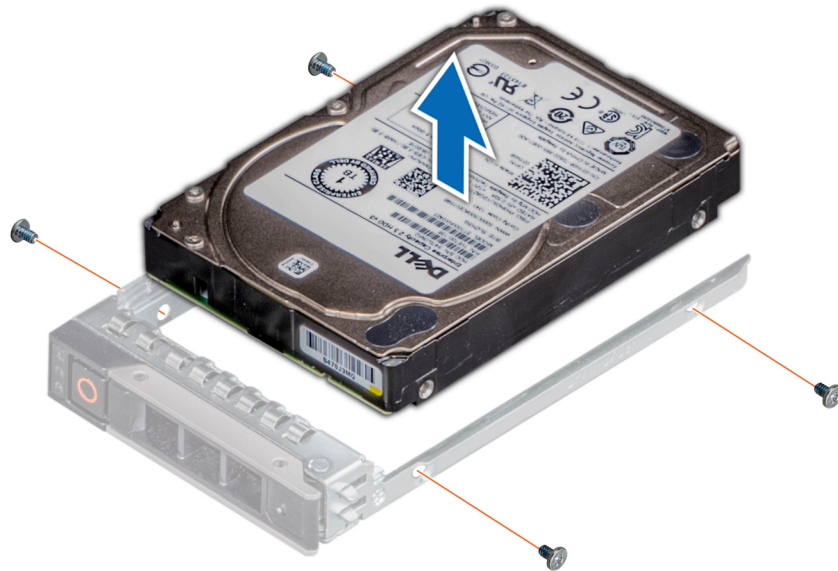

Figure 41. Removing the drive from the drive carrier

Next steps

Install the drive into the drive carrier.

Installing the drive into the drive carrier

Prerequisites

Follow the safety guidelines listed in the [Safety instructions](#)

NOTE: When installing a drive into the drive carrier, ensure that the screws are torqued to 4 in-lbs.

Steps

1. Insert the drive into the drive carrier with the drive connector facing towards the rear of the carrier.
2. Align the screw holes on the drive with the screws holes on the drive carrier.
3. Using a Phillips #1 screwdriver, secure the drive to the drive carrier with the screws.

NOTE: If the hard drive or SSD carrier has Torx screw, use Torx 6 (for 2.5-inch drive) or Torx 8 (for 3.5-inch drive) screwdriver to install the drive. 



Figure 42. Installing a drive into the drive carrier

Next steps

Install the drive carrier.

Drive backplane

This is a service technician replaceable part only.

Drive backplane connectors

Depending on your system configuration, the drive backplanes supported are listed here:

Table 25. Supported backplane options

| System | Supported hard drives options |
|----------------|--|
| PowerEdge R650 | 3.5-inch (x4) SAS, SATA backplane |
| | 2.5-inch (x8) SAS or SATA backplane |
| | 2.5-inch (x10) SAS, SATA or NVMe backplane |
| | 2.5-inch (x2) SAS/SATA/NVME rear backplane |



Figure 43. 4 x 3.5-inch drive backplane

1. BP_PWR_1 (backplane power and signal cable to system board)

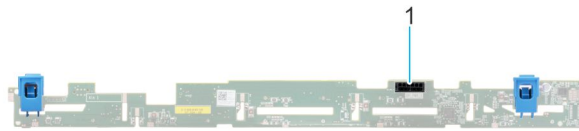

Figure 44. 8 x 2.5-inch drive backplane

1. BP_PWR_1 (backplane power and signal cable to system board)

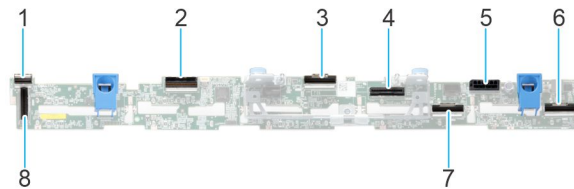

Figure 45. 10 x 2.5-inch drive backplane

- | | |
|--|----------------------------------|
| 1. DST_SA2 (backplane to front PERC) | 2. DST_PB2 (PCIe/NVMe connector) |
| 3. DST_PA2 (PCIe/NVMe connector) | 4. DST_SA1 (PERC to backplane) |
| 5. BP_PWR_1 (backplane power and signal cable to system board) | 6. DST_PA1 (PCIe/NVMe connector) |
| 7. DST_PB1 (PCIe/NVMe connector) | 8. DST_PA3 (PCIe/NVMe connector) |

Cable routing

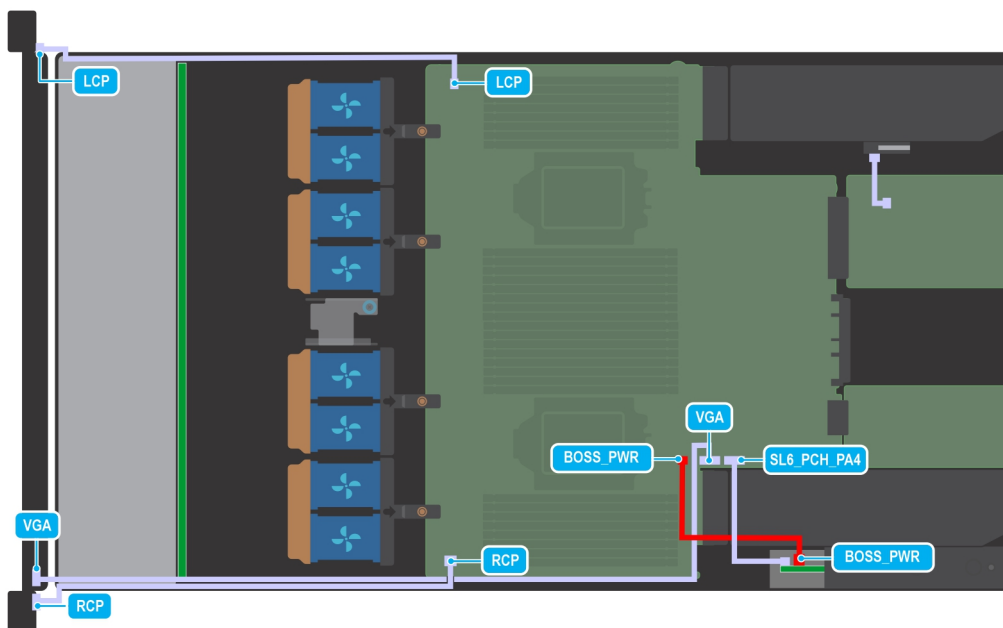

Figure 46. Control panels and intrusion switch

Table 26. Control panels, BOSS S2 and VGA cabling

| From | To |
|--|---|
| Left control panel connector | Left control panel (LCP) |
| Right control panel connector | Right control panel (RCP) |
| Front VGA connector | VGA on RCP |
| BOSS_CARD_PWR (BOSS S2 module power connector on system board) | BOSS_PWR (BOSS S2 module power connector on BOSS S2 module) |

Table 26. Control panels, BOSS S2 and VGA cabling (continued)

| From | To |
|---|------------------------------------|
| SL6_PCH_PA4 (BOSS signal connector on system board) | BOSS signal on BOSS S2 card module |

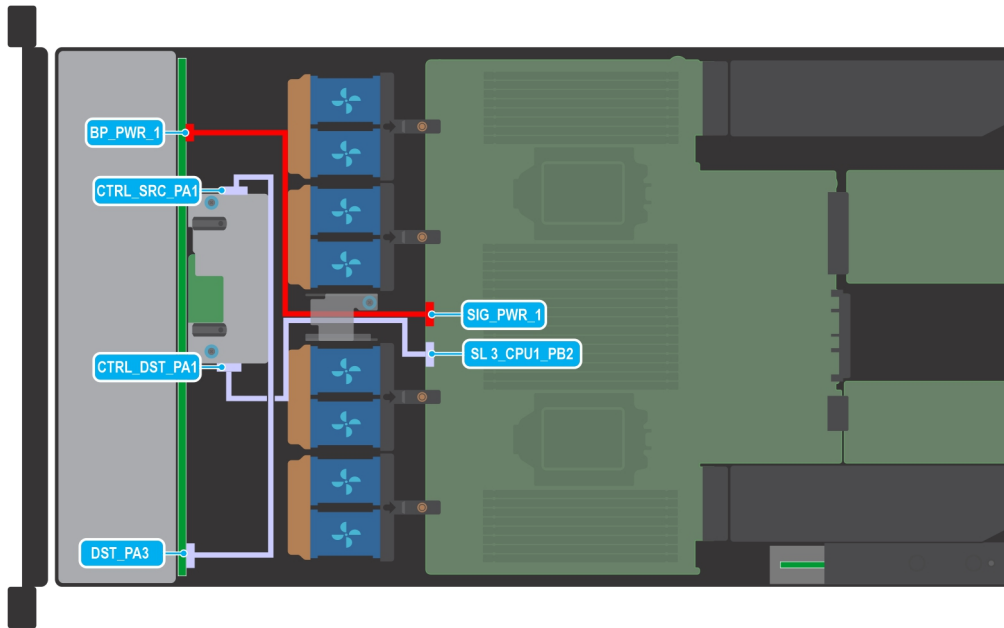

Figure 47. 10 x 2.5-inch SAS with fPERC

Table 27. 10 x 2.5-inch SAS with fPERC

| From | To |
|--|---|
| SIG_PWR_1 (system board power connector) | BP_PWR (backplane power connector) |
| CTRL_DST_PA1 (fPERC input connector) | SL3_CPU1_PB2 (Signal connector on system board) |
| CTRL_SRC_PA1 (fPERC output connector) | DST_PA3 (backplane signal connector) |

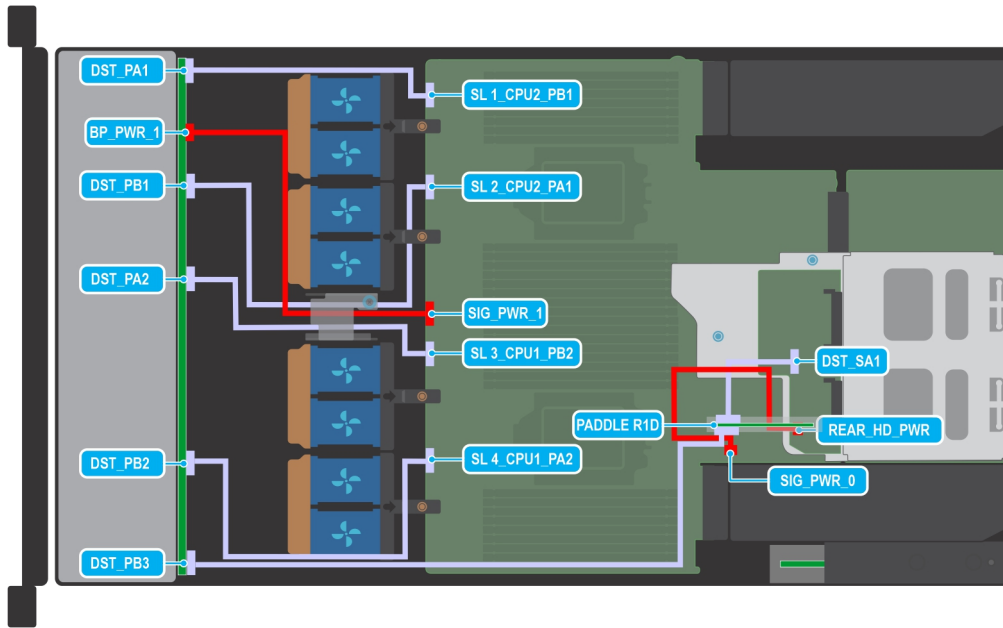

Figure 48. 10 x 2.5-inch NVMe and 2 x 2.5-inch NVMe

Table 28. 10 x 2.5-inch NVMe and 2 x 2.5-inch NVMe

| From | To |
|---|--|
| SL1_CPU2_PB1 (Signal connector on system board) | DST_PA1 (backplane signal connector) |
| SL2_CPU2_PA1 (Signal connector on system board) | DST_PB1 (backplane signal connector) |
| SL3_CPU1_PB2 (Signal connector on system board) | DST_PA2 (backplane signal connector) |
| SL4_CPU1_PA2 (Signal connector on system board) | DST_PB2 (backplane signal connector) |
| PADDLE R1d (Paddle R1d connector on system board) | DST_PA3 (backplane signal connector) |
| SIG_PWR_1 (system board power connector) | BP_PWR (backplane power connector) |
| SIG_PWR_0 (system board power connector) | REAR_HDD_PWR (Rear HDD module power connector) |
| PADDLE R1d (Paddle R1d connector on system board) | DST_SA1 (rear backplane signal connector) |

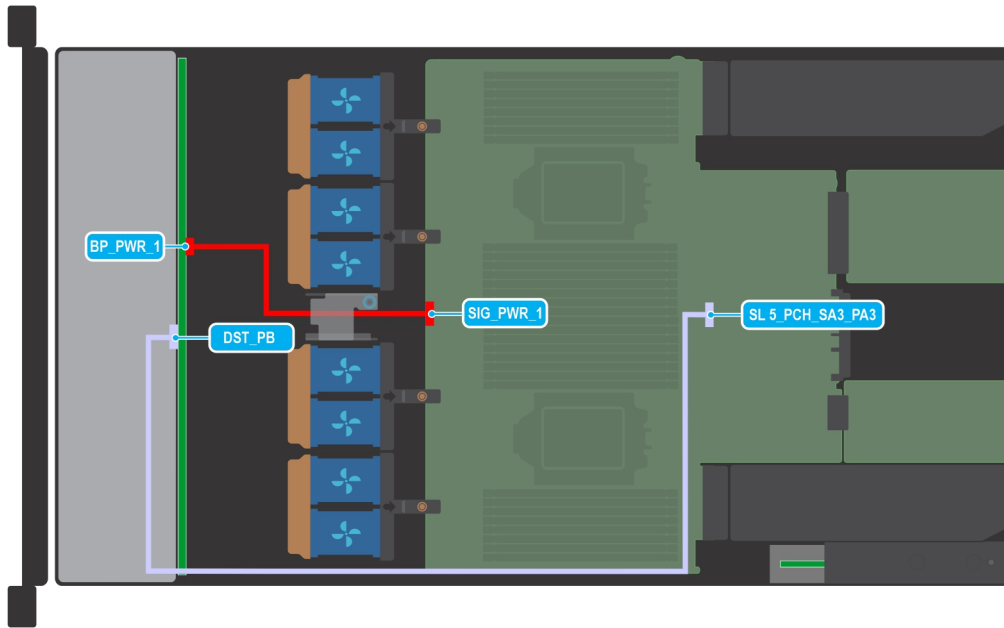

Figure 49. 4 x 3.5-inch chipset SATA

Table 29. 4 x 3.5-inch chipset SATA

| From | To |
|--|--------------------------------------|
| SIG_PWR_1 (system board power connector) | BP_PWR_1 (backplane power connector) |
| SL5_PCH_SA3_PA3 (Signal connector on system board) | DST_PB (backplane signal connector) |

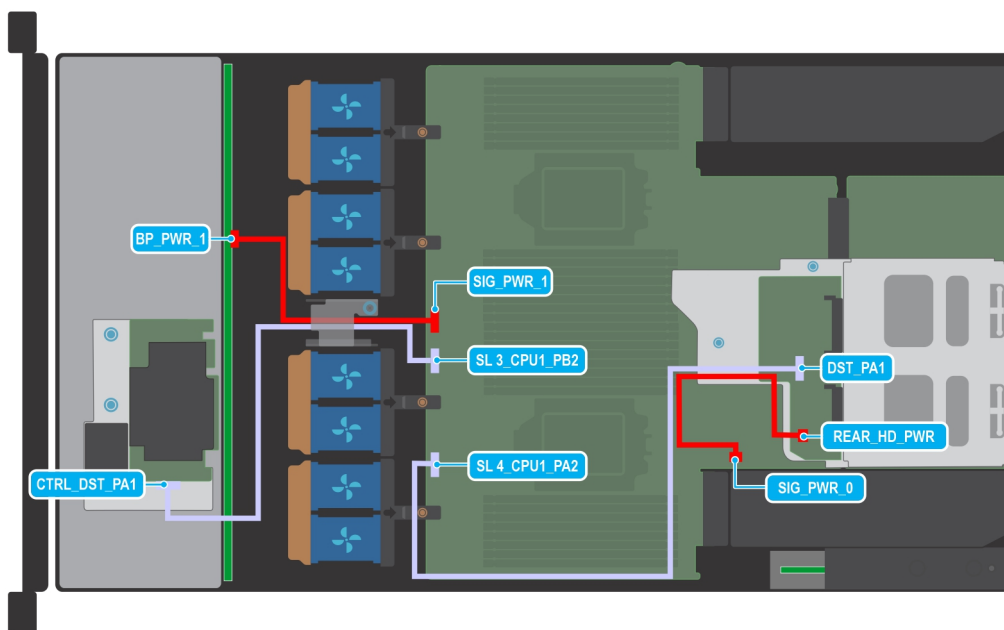

Figure 50. 4 x 3.5-inch SAS/SATA with fPERC and 2 x 2.5 rear drives

Table 30. 4 x 3.5-inch SAS/SATA with fPERC and 2 x 2.5 rear drives

| From | To |
|---|--|
| SIG_PWR_1 (system board power connector) | BP_PWR (backplane power connector) |
| SL3_CPU1_PB2 (Signal connector on system board) | CTRL_DST_PA1 (fPERC connector) |
| SL4_CPU1_PA2 (Signal connector on system board) | DST_PA1 (rear backplane signal connector) |
| SIG_PWR_0 (system board power connector) | REAR_HDD_PWR (Rear HDD module power connector) |

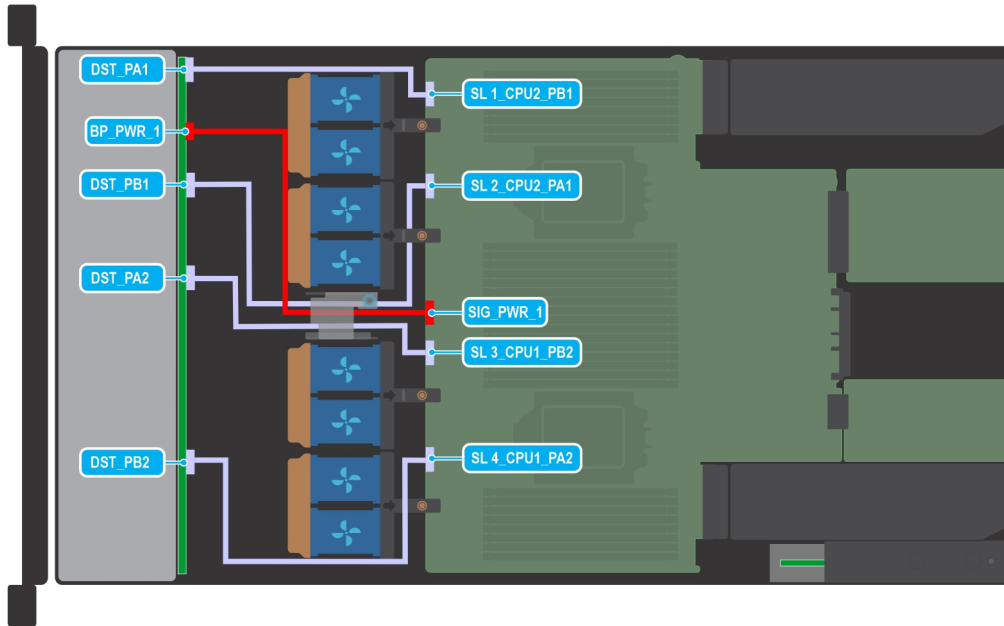

Figure 51. 8 x 2.5-inch NVMe without fPERC

Table 31. 8 x 2.5-inch NVMe without fPERC

| From | To |
|---|--------------------------------------|
| SL1_CPU2_PB1 (Signal connector on system board) | DST_PA1 (backplane signal connector) |
| SL2_CPU2_PA1 (Signal connector on system board) | DST_PB1 (backplane signal connector) |
| SL3_CPU1_PB2 (Signal connector on system board) | DST_PA2 (backplane signal connector) |
| SL4_CPU1_PA2 (Signal connector on system board) | DST_PB2 (backplane signal connector) |
| SIG_PWR_1 (system board power connector) | BP_PWR (backplane power connector) |

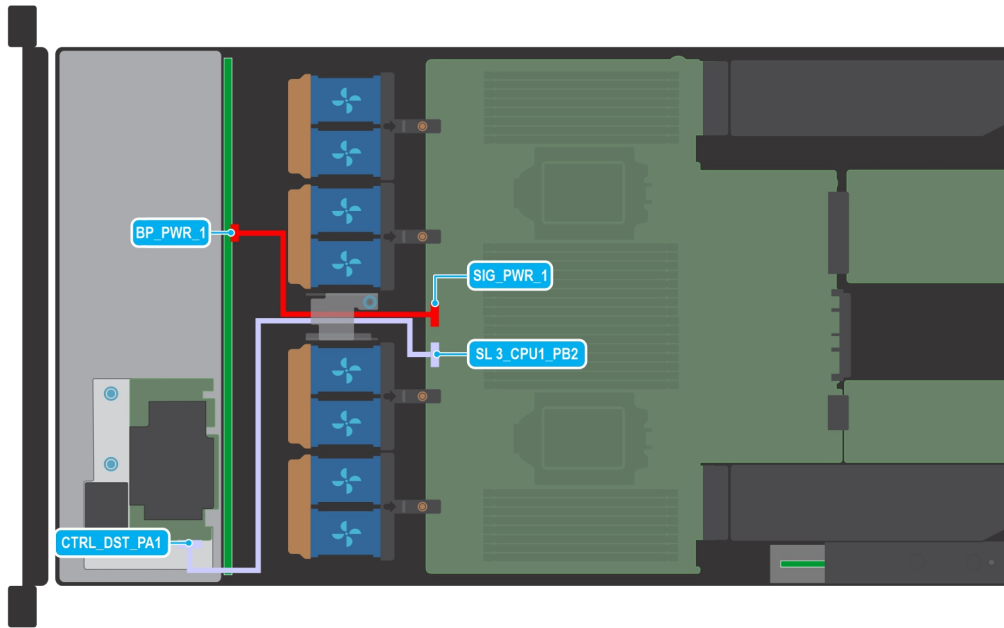

Figure 52. 8 x 2.5-inch SAS with front PERC module

Table 32. 8 x 2.5-inch SAS with front PERC module

| From | To |
|--|---|
| SIG_PWR_1 (system board power connector) | BP_PWR (backplane power connector) |
| CTRL_DST_PA1 (fPERC connector) | SL3_CPU1_PB2 (Signal connector on system board) |

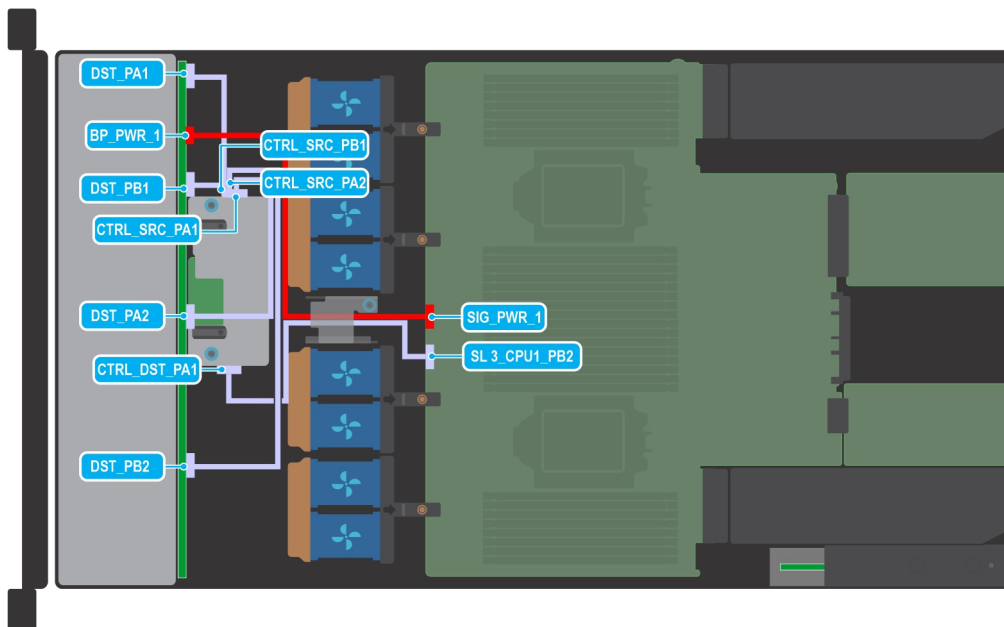

Figure 53. 8 x 2.5-inch all NVME with front PERC module

Table 33. 8 x 2.5-inch all NVME with front PERC module

| From | To |
|--|---|
| CTRL_SRC_PA1 (PERC controller connector) | DST_PA1 (backplane signal connector) |
| CTRL_SRC_PB1 (PERC controller connector) | DST_PB1 (backplane signal connector) |
| CTRL_SRC_PA2 (PERC controller connector) | DST_PA2 (backplane signal connector) |
| CTRL_SRC_PB2 (PERC controller connector) | DST_PB2 (backplane signal connector) |
| CTRL_DST_PA1 (PERC controller connector) | SL3_CPU1_PB2 (Signal connector on system board) |
| SIG_PWR_1 (system board power connector) | BP_PWR (backplane power connector) |

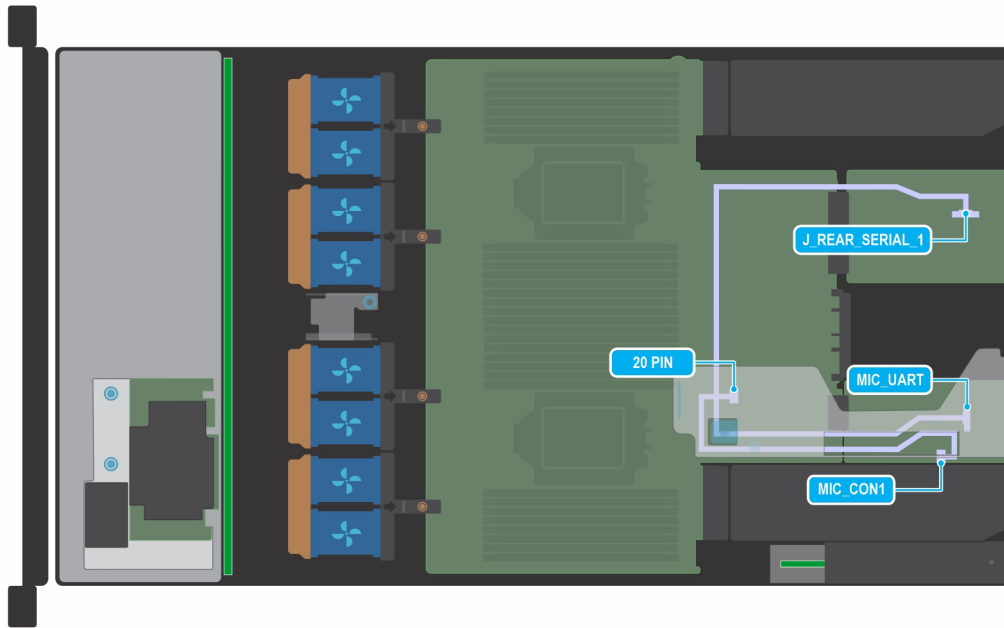

Figure 54. Management Interface Card (MIC)

Table 34. Management Interface Card (MIC)

| From | To |
|---|--------------------------|
| J_REAR_SERIAL_1 (Rear I/O card connector) | MIC_UART (MIC connector) |
| MIC_CON1 (System board connector) | 20 PIN (MIC connector) |

Removing the drive backplane

Prerequisites

CAUTION: To prevent damage to the drives and backplane, remove the drives from the system before removing the backplane.

CAUTION: Note the number of each drive and temporarily label them before you remove the drive so that you can reinstall them in the same location.

NOTE: The procedure to remove the backplane is similar for all backplane configurations.

1. Follow the safety guidelines listed in the [Safety instructions](#).
2. Follow the procedure listed in [Before working inside your system](#).
3. If installed, [remove the air shroud](#).

4. Remove the drive backplane cover.
5. Remove all the drives.

Steps

1. Loosen the captive screw on the cable guiding latch and lift the latch to remove the cables.
2. Disconnect the drive backplane cable from the connector on the system board.
3. Press the blue release tabs to disengage the drive backplane from the hooks on the system.
4. Lift and pull the drive backplane out of the system.

i **NOTE:** To avoid damaging the backplane, ensure that you move the control panel cables from the cable routing clips before removing the backplane.

i **NOTE:** The numbers on the image do not depict the exact steps. The numbers are for representation of sequence.



Figure 55. Removing the drive backplane

Next steps

1. Replace the drive backplane.

Installing the drive backplane

Prerequisites

1. Follow the safety guidelines listed in the [Safety instructions](#).
2. Follow the procedure listed in [Before working inside your system](#).

3. If installed, [remove the air shroud](#).
4. [Remove the drive backplane cover](#).
5. [Remove all the drives](#).

i **NOTE:** To avoid damaging the backplane, ensure to move the control panel cables from the cable routing clips before removing the backplane.

i **NOTE:** Route the cable properly when you replace it to prevent the cable from being pinched or crimped.

Steps

1. Use the guides on the system to align the slots on the backplane.
2. Insert the backplane into the guides and lower the backplane until the blue release tabs clicks into place.

i **NOTE:** The numbers on the image do not depict the exact steps. The numbers are for representation of sequence.

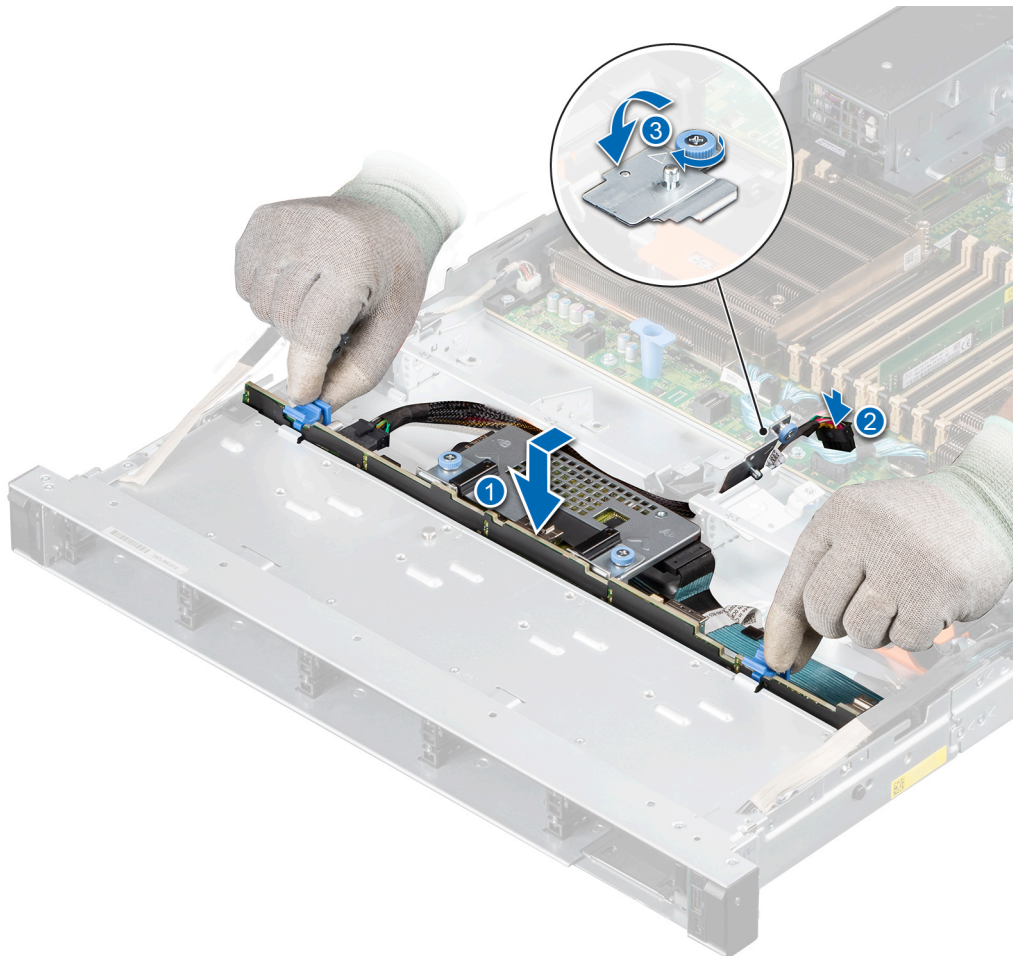

Figure 56. Installing the drive backplane

3. Route the cables properly through the cable guide and connect the cables to the connector on the system board. Tighten the captive screw on the cable guiding latch.

Next steps

1. [Install all the drives](#).
2. If removed, [install the air shroud](#).
3. [Install the drive backplane cover](#).
4. Follow the procedure listed in [After working inside your system](#).

Rear mounting front PERC module

Removing the front mounting front PERC module

Prerequisites

1. Follow the safety guidelines listed in the [Safety instructions](#).
2. Follow the procedure listed in the [Before working inside your system](#).
3. [Remove the drive backplane cover](#).
4. If installed, [remove the air shroud](#).
5. Disconnect the SAS cable from PERC, observe the cable routing.

Steps

1. Using a Phillips #2 screwdriver, loosen the captive screws on the front PERC module.
2. Pull the front PERC module to disengage from the connector on the drive backplane.
3. Tilt and lift the front PERC module out of the system.

 **NOTE:** The numbers on the image do not depict the exact steps. The numbers are for representation of sequence.

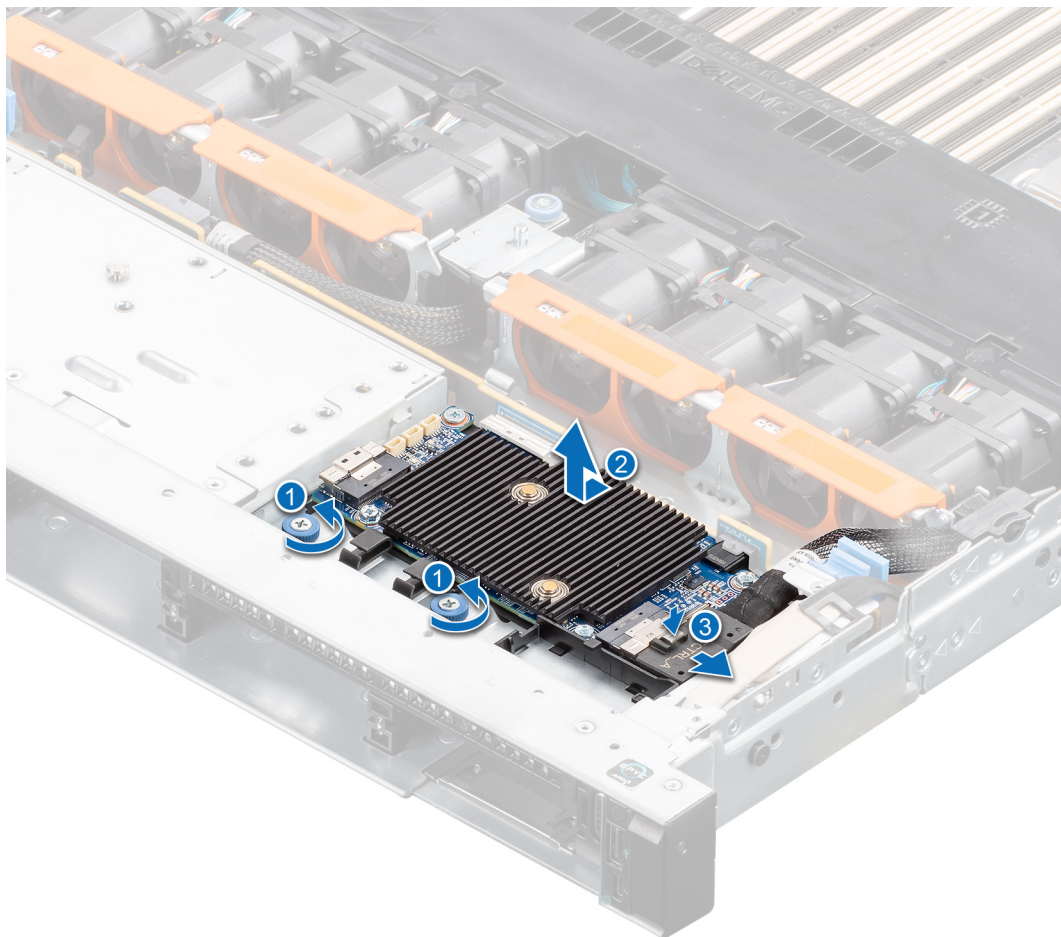

Figure 57. Removing the front mounting front PERC module

Next steps

1. [Replace the front mounting front PERC module](#).

Installing the front mounting front PERC module

Prerequisites

1. Follow the safety guidelines listed in the [Safety instructions](#).
2. Follow the procedure listed in [Before working inside your system](#).
3. [Remove the drive backplane cover](#).
4. If installed, [remove the air shroud](#).
5. Route the cable properly to prevent the cable from being pinched or crimped.

Steps

1. Connect the PERC cable to the front PERC module.
2. Align the front PERC module at an angle until the tray touches the slot in the system.
3. Press the front PERC module connector with the connector on the drive backplane until firmly seated.
4. Using a Phillips #2 screwdriver, tighten the captive screws on the front PERC module.

NOTE: The numbers on the image do not depict the exact steps. The numbers are for representation of sequence.

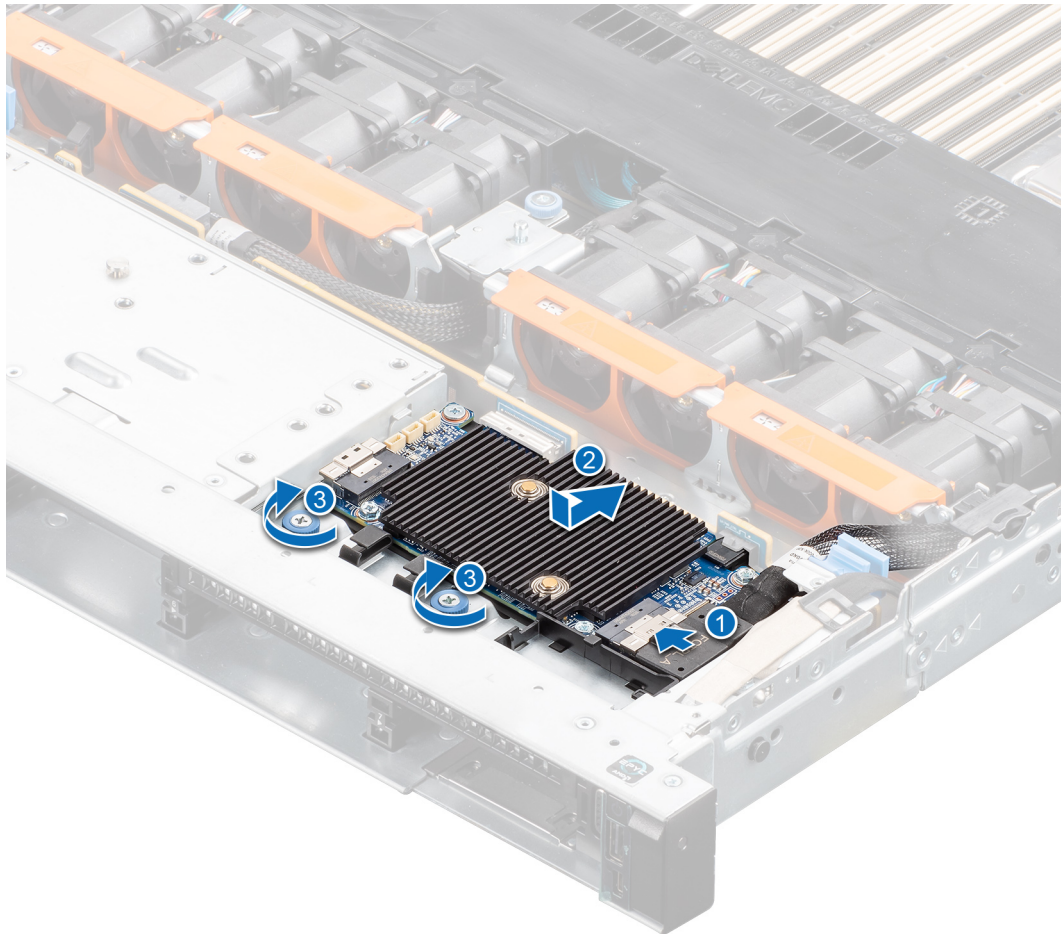

Figure 58. Installing the front mounting front PERC module

Next steps

1. Reconnect the required cables.
2. If removed, [install the air shroud](#).
3. [Install the drive backplane cover](#).
4. Follow the procedure listed in [After working inside your system](#).

Removing the rear mounting front PERC module

Prerequisites

1. Follow the safety guidelines listed in the [Safety instructions](#).
2. Follow the procedure listed in the [Before working inside your system](#).
3. [Remove the drive backplane cover](#).
4. If installed, [remove the air shroud](#).
5. [Remove the drive backplane](#).
6. Disconnect all the cables, observe the cable routing.

Steps

1. Using a Phillips #2 screwdriver, loosen the captive screws on the front PERC module.
2. Slide the front PERC module to disengage from the connector on the drive backplane.

 **NOTE:** The numbers on the image do not depict the exact steps. The numbers are for representation of sequence.

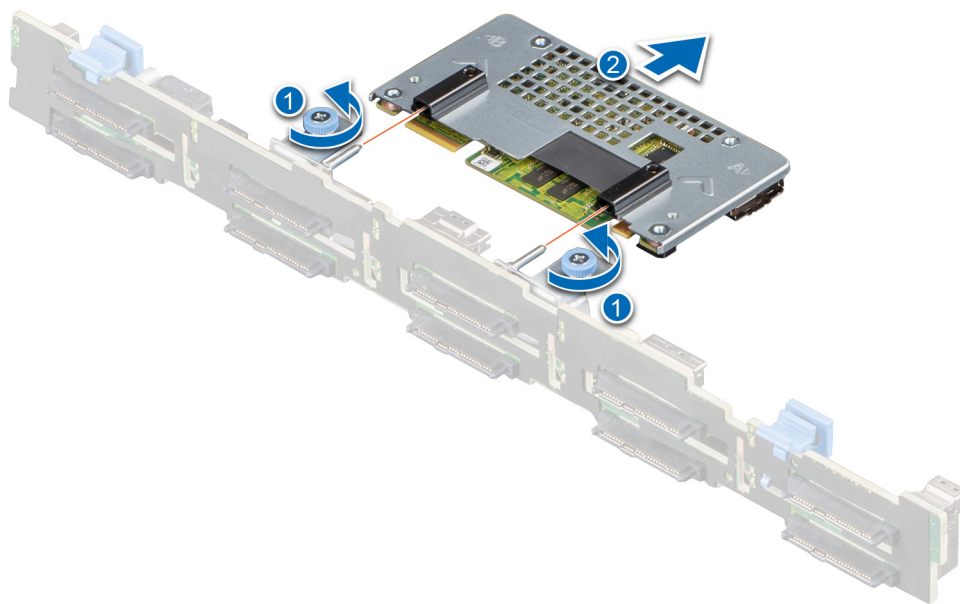

Figure 59. Removing the rear mounting front PERC module

Next steps

1. [Replace the rear mounting front PERC module](#).

Installing the rear mounting front PERC module

Prerequisites

1. Follow the safety guidelines listed in the [Safety instructions](#).
2. Follow the procedure listed in the [Before working inside your system](#).
3. [Remove the drive backplane cover](#).
4. If installed, [remove the air shroud](#).
5. [Remove the drive backplane](#).
6. Route the cable properly to prevent the cable from being pinched or crimped.

Steps

1. Align the connectors on the front PERC module with the connectors on the drive backplane.
2. Slide the front PERC module until the module is connected to the drive backplane.
3. Using a Phillips #2 screwdriver, tighten the captive screws on the front PERC module.

NOTE: The numbers on the image do not depict the exact steps. The numbers are for representation of sequence.

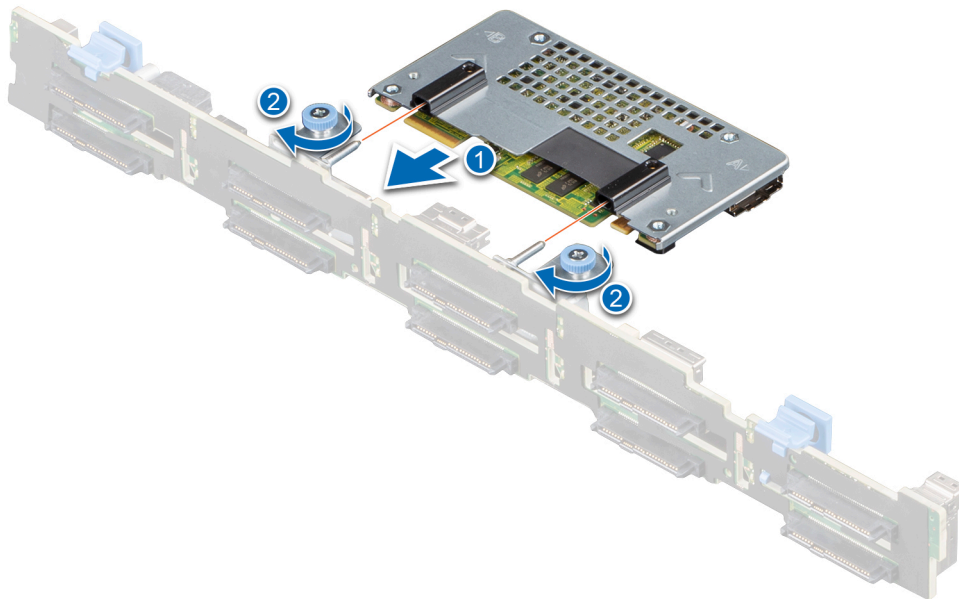

Figure 60. Installing the rear mounting front PERC module

Next steps

1. [Install the drive backplane](#).
2. If removed, [install the air shroud](#).
3. [Install the drive backplane cover](#).
4. Follow the procedure listed in [After working inside your system](#).

Rear drive module

Removing the rear drive module

Prerequisites

1. Follow the safety guidelines listed in the [Safety instructions](#).
2. Follow the procedure listed in [Before working inside your system](#).
3. If installed, [remove the air shroud](#).
4. [Remove the rear drives](#).
5. Disconnect all the cables from the rear drive module.
6. If installed, [remove the expansion card riser 3](#).

Steps

1. Using a Phillips #1 screwdriver, loosen the captive screws on the rear drive module or the liquid cooling rear drive module.
2. Slide the rear drive module and lift it away from the system.

NOTE: The procedure is same for removing the rear drive module in liquid cooling module configuration.

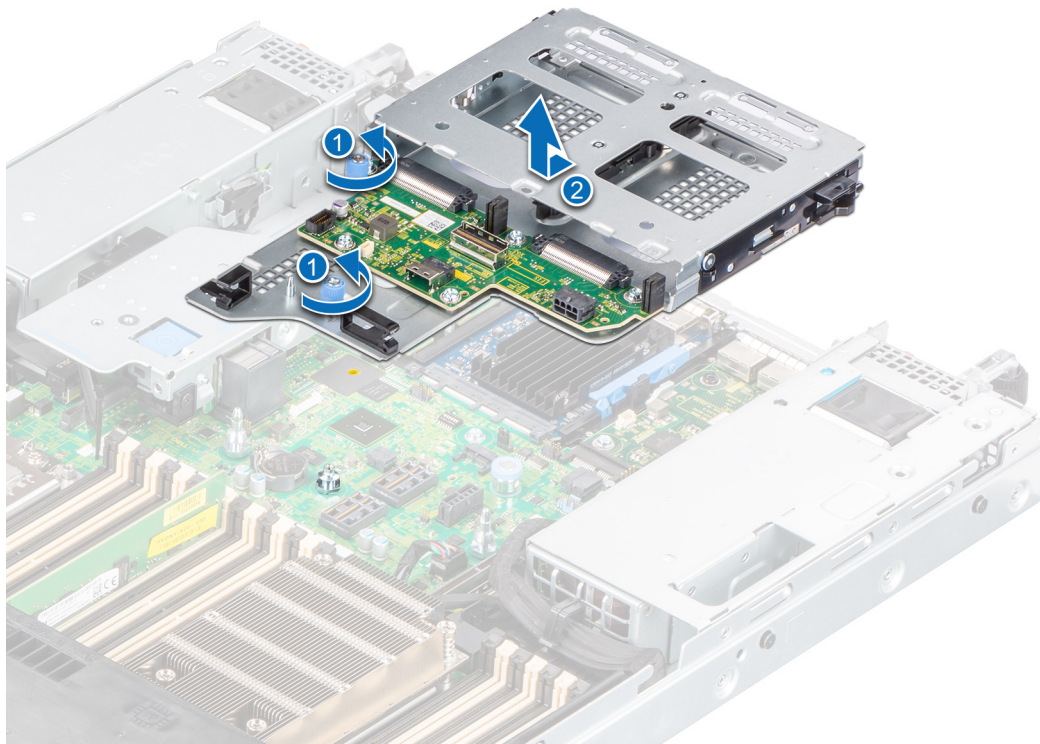

Figure 61. Removing the rear drive module

Next steps

1. [Replace the rear drive module](#).

Installing the rear drive module

Prerequisites

1. Follow the safety guidelines listed in the [Safety instructions](#).
2. Follow the procedure listed in [Before working inside your system](#).

3. If installed, [remove the air shroud](#).

Steps

1. Align the rear drive module with the guide on the system board.
2. Lower the rear drive module and slide till it clicks.
3. Using a Phillips #1 screwdriver, tighten the captive screws on the rear drive module.

NOTE: The procedure to install the rear drive module is same for liquid cooling module configuration.

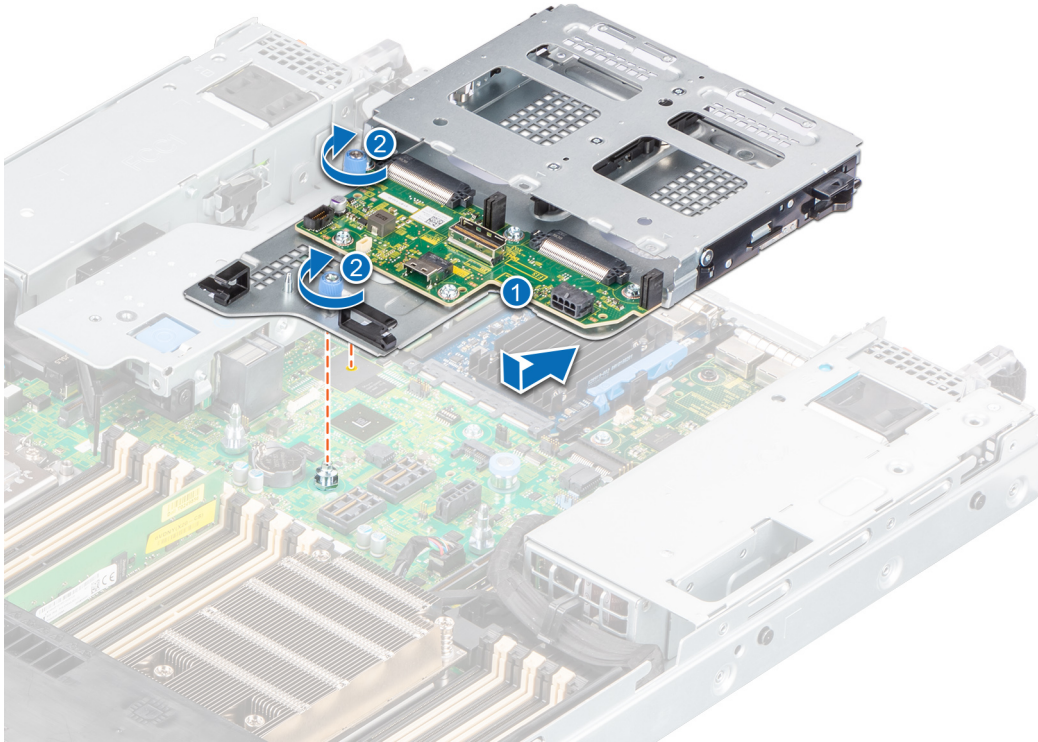

Figure 62. Installing the rear drive module

Next steps

1. If removed, [install the expansion card riser 3](#).
2. Connect all the cables to the rear drive module.
3. [Install the rear drives](#).
4. If removed, [install the air shroud](#).
5. Follow the procedure listed in [After working inside your system](#).

System memory

System memory guidelines

The PowerEdge R650 system supports DDR4 registered DIMMs (RDIMMs), Load Reduced DIMM (LRDIMMs) and Intel Persistent Memory 200 series (BPS). System memory holds the instructions that are started by the processor.

Your system memory is organized into eight channels per processor (two memory sockets per channel), 16 memory sockets per processor and 32 memory sockets per system.

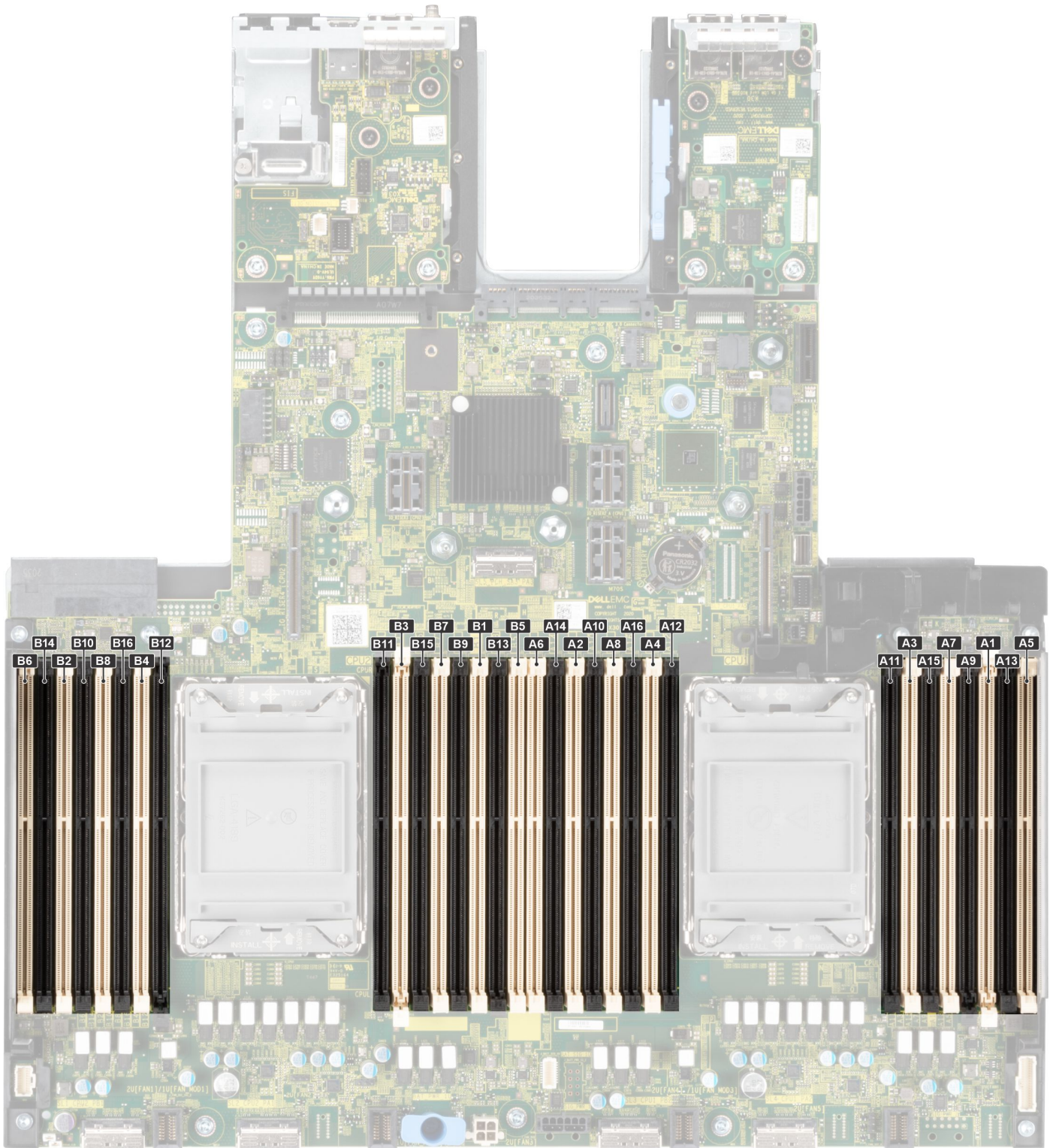

Figure 63. Memory channels

Memory channels are organized as follows:

Table 35. Memory channels

| Processor | Channel A | Channel B | Channel C | Channel D | Channel E | Channel F | Channel G | Channel H |
|-------------|-----------------|------------------|------------------|------------------|------------------|------------------|------------------|------------------|
| Processor 1 | Slots A1 and A9 | Slots A5 and A13 | Slots A3 and A11 | Slots A7 and A15 | Slots A2 and A10 | Slots A6 and A14 | Slots A4 and A12 | Slots A8 and A16 |

Table 35. Memory channels (continued)

| Processor | Channel A | Channel B | Channel C | Channel D | Channel E | Channel F | Channel G | Channel H |
|-------------|-----------------|------------------|------------------|------------------|------------------|------------------|------------------|------------------|
| Processor 2 | Slots B1 and B9 | Slots B5 and B13 | Slots B3 and B11 | Slots B7 and B15 | Slots B2 and B10 | Slots B6 and B14 | Slots B4 and B12 | Slots B8 and B16 |

Table 36. Supported memory matrix

| DIMM type | Rank | Capacity | DIMM rated voltage and speed | Operating Speed | |
|--|------|------------------------|------------------------------|--------------------------|---------------------------|
| | | | | 1 DIMM per channel (DPC) | 2 DIMMs per channel (DPC) |
| RDIMM | 1 R | 8 GB | DDR4 (1.2 V), 3200 MT/s | 3200 MT/s | 3200 MT/s |
| | 2 R | 16 GB, 32 GB, 64 GB | DDR4 (1.2 V), 3200 MT/s | 3200 MT/s | 3200 MT/s |
| LRDIMM | 4 R | 128 GB | DDR4 (1.2 V), 2666 MT/s | 3200 MT/s | 3200 MT/s |
| | | | DDR4 (1.2 V), 3200 MT/s | 3200 MT/s | 3200 MT/s |
| | 8 R | 256 GB | DDR4 (1.2 V), 3200 MT/s | 3200 MT/s | 3200 MT/s |
| Intel Persistent Memory 200 series (BPS) | 2 R | 128 GB, 256 GB, 512 GB | DDR4 (1.2 V), 3200 MT/s | 3200 MT/s | 3200 MT/s |

General memory module installation guidelines

To ensure optimal performance of your system, observe the following general guidelines when configuring your system memory. If your system's memory configurations fail to observe these guidelines, your system might not boot, stop responding during memory configuration, or operate with reduced memory.

The memory bus may operate at speeds of 3200 MT/s, 2933 MT/s depending on the following factors:

- System profile selected (for example, Performance Optimized, or Custom [can be run at high speed or lower])
- Maximum supported DIMM speed of the processors
- Maximum supported speed of the DIMMs

NOTE: MT/s indicates DIMM speed in MegaTransfers per second.

NOTE: Fault Resilient Memory-Non Uniform Memory Access is supported.

The system supports Flexible Memory Configuration, enabling the system to be configured and run in any valid chipset architectural configuration. The following are the recommended guidelines for installing memory modules:

- All DIMMs must be DDR4.
- x4 and x8 DRAM based memory modules can be mixed.
- If memory modules with different speeds are installed, they operate at the speed of the slowest installed memory module(s).
- Populate memory module sockets only if a processor is installed.
 - For single-processor systems, sockets A1 to A16 are available.
 - For dual-processor systems, sockets A1 to A16 and sockets B1 to B16 are available.
- In **Optimizer Mode**, the DRAM controllers operate independently in the 64-bit mode and provide optimized memory performance.

Table 37. Memory population rules

| Processor | Configuration | Memory population | Memory population information |
|---|--|--|---|
| Single processor | Optimizer (Independent channel) population order | A{1}, A{2}, A{3}, A{4}, A{5}, A{6}, A{7}, A{8}, A{9}, A{10}, A{11}, A{12}, A{13}, A{14}, A{15}, A{16} | 1, 2, 4, 6, 8, 12 or 16 DIMMs are allowed. |
| Dual processor (Start with processor1. Processor 1 and processor 2 population should match) | Optimizer (Independent channel) population order | A{1}, B{1}, A{2}, B{2}, A{3}, B{3}, A{4}, B{4}, A{5}, B{5}, A{6}, B{6}, A{7}, B{7}, A{8}, B{8}, A{9}, B{9}, A{10}, B{10}, A{11}, B{11}, A{12}, B{12}, A{13}, B{13}, A{14}, B{14}, A{15}, B{15}, A{16}, B{16} | 2, 4, 8, 12, 16, 24 and 32 DIMMs are supported per system. NOTE: Optimizer population order is not traditional for 8 and 16 DIMMs installations for dual processor. |

- Populate all the sockets with white release tabs first, followed by the black release tabs.
- Only RDIMM Memory modules of different capacities can be mixed provided other memory population rules are followed.
NOTE: For example, 8 GB and 16 GB memory modules can be mixed.
- Mixing of more than two memory module capacities in a system is not supported.
- Unbalanced or odd memory configuration results in a performance loss and system may not identify the memory modules being installed, so always populate memory channels identically with equal DIMMs for best performance.
- Supported RDIMM / LRDIMM configurations are 1, 2, 4, 6, 8, 12, or 16 DIMMs per processor.

Intel Persistent Memory 200 series (BPS) installation guidelines

The following are the recommended guidelines for installing Intel Persistent Memory 200 series (BPS) memory modules:

- Each system supports maximum of one Intel Persistent Memory 200 series (BPS) memory module per channel.
NOTE: If two different Intel Persistent Memory 200 series (BPS) capacities are mixed, an F1/F2 warning is displayed as the configuration is not supported.
- Intel Persistent Memory 200 series (BPS) can be mixed with RDIMM, LRDIMM, and 3DS LRDIMM.
NOTE: Intel Persistent Memory 200 series (BPS) cannot be mixed with 256 GB LRDIMM.
- Mixing of DDR4 DIMM types (RDIMM, LRDIMM, and 3DS LRDIMM), within channels, for Integrated Memory Controller (iMC), or across sockets are not supported.
- Mixing of Intel Persistent Memory 200 series (BPS) operating modes (App Direct Mode, Memory Mode) is not supported.
- If only one DIMM is populated on a channel, then the DIMM should always be populated in the first slot in that channel (white slot).
- If a Intel Persistent Memory 200 series (BPS) and a DDR4 DIMM are populated on the same channel, always plug Intel Persistent Memory 200 series (BPS) on second slot (black slot).
- If the Intel Persistent Memory 200 series (BPS) is configured in Memory Mode, the recommended DDR4 to Intel Persistent Memory 200 series (BPS) capacity ratio is 1:4 to 1:16 per iMC.
- Intel Persistent Memory 200 series (BPS) cannot be mixed with other capacities of Intel Persistent Memory 200 series (BPS) or with NVDIMMs.
- Mixing different capacities of RDIMMs and LRDIMMs are not allowed when Intel Persistent Memory 200 series (BPS) is installed.
- Intel Persistent Memory 200 series (BPS) of different capacities are not allowed.
- VMware ESXi boot takes longer time when higher capacity of Intel Persistent Memory 200 series (BPS) are configured in App Direct Mode, This is Address Range Scrub (ARS). This is expected as background Address Range Scrub (ARS) is going on the interleave sets and needs to be completed prior the pMem datastore is mounted on ESXi.
- In App Direct Mode (AP), sockets can be populated symmetrically or asymmetrically.
- In Memory Mode (MM), sockets can be populated symmetrically.
- Memory mode is not supported for the 6+1, 8+1 and 12+2 configurations irrespective of DDR to Intel Persistent Memory 200 series (BPS) capacity ratio.
- In VMware ESXi environment, if BPS goal is changed between App Direct Mode and Memory Mode, it is recommended to sanitize the Intel Persistent Memory 200 series (BPS) before creating a new goal.

- Populate Intel Persistent Memory 200 series (BPS) in DIMM slot 1, unless Intel Persistent Memory 200 series (BPS) is the only DIMM in that channel, and then populate in DIMM slot 0.

For more information about the supported Intel Persistent Memory 200 series (BPS) configurations, see the *Dell EMC Intel Persistent Memory 200 series (BPS) User's Guide* at https://www.dell.com/support/home/products/server_int/server_int_poweredge.

Table 38. Supported Intel Persistent Memory 200 series (BPS) for dual processor configurations

| Configuration | Description per processor | Memory population rules | |
|-----------------|---|--|--|
| | | RDIMMs or LRDIMMs | Intel Persistent Memory 200 series (BPS) |
| Configuration 1 | 4 x RDIMMs, 4 x Intel Persistent Memory 200 series (BPS) | Processor1 {A1, 2, 3, 4} Processor2 {B1, 2, 3, 4} | Processor1 {A5, 6, 7, 8} Processor2 {B5, 6, 7, 8} |
| Configuration 2 | 6 x RDIMMs, 1 x Intel Persistent Memory 200 series (BPS) | Processor1 {A1, 2, 3, 4, 5, 6} Processor2 {B1, 2, 3, 4, 5, 6} | Processor1 {A7} Processor2 {B7} |
| Configuration 3 | 8 x RDIMMs, 1 x Intel Persistent Memory 200 series (BPS) | Processor1 {A1, 2, 3, 4, 5, 6, 7, 8} Processor2 {B1, 2, 3, 4, 5, 6, 7, 8} | Processor1 {A9} Processor2 {B9} |
| Configuration 4 | 8 x RDIMMs, 4 x Intel Persistent Memory 200 series (BPS) | Processor1 {A1, 2, 3, 4, 5, 6, 7, 8} Processor2 {B1, 2, 3, 4, 5, 6, 7, 8} | Processor1 {A9, 10, 11, 12} Processor2 {B9, 10, 11, 12} |
| Configuration 5 | 8 x RDIMMs, 8 x Intel Persistent Memory 200 series (BPS) | Processor1 {A1, 2, 3, 4, 5, 6, 7, 8} Processor2 {B1, 2, 3, 4, 5, 6, 7, 8} | Processor1 {A9, 10, 11, 12, 13, 14, 15, 16} Processor2 {B9, 10, 11, 12, 13, 14, 15, 16} |
| Configuration 6 | 12 x RDIMMs, 2 x Intel Persistent Memory 200 series (BPS) | Processor1 {A1, 2, 3, 4, 5, 6, 7, 8, 9, 10, 11, 12, 15, 16} Processor2 {B1, 2, 3, 4, 5, 6, 7, 8, 9, 10, 11, 12, 15, 16} | Processor1 {A5, 6} Processor2 {B5, 6} |

NOTE: There are limited configurations available for dual socket servers with only one processor populated.

Table 39. Intel Persistent Memory 200 series (BPS) Configuration 1 - 4 x RDIMMs, 4 x Intel Persistent Memory 200 series (BPS) per processor

| Total No of RDIMMs | Total No of Intel Persistent Memory 200 series (BPS) DIMMs | 1 RDIMM capacity (GB) | 1 Intel Persistent Memory 200 series (BPS) capacity (GB) | Total Standard Memory Capacity (GB) | Total PM Capacity (GB) | Supported Modes |
|--------------------|--|-----------------------|--|-------------------------------------|------------------------|-----------------|
| 4 | 4 | 16 | 128 | 64 | 512 | MM or AD |
| 4 | 4 | 32 | 128 | 128 | 512 | MM or AD |
| 4 | 4 | 64 | 128 | 256 | 512 | AD |
| 4 | 4 | 16 | 256 | 64 | 1024 | MM or AD |
| 4 | 4 | 32 | 256 | 128 | 1024 | MM or AD |
| 4 | 4 | 64 | 256 | 256 | 1024 | MM or AD |
| 4 | 4 | 16 | 512 | 64 | 2048 | AD |
| 4 | 4 | 32 | 512 | 128 | 2048 | MM or AD |

Table 39. Intel Persistent Memory 200 series (BPS) Configuration 1 - 4 x RDIMMs, 4 x Intel Persistent Memory 200 series (BPS) per processor (continued)

| Total No of RDIMMs | Total No of Intel Persistent Memory 200 series (BPS) DIMMs | 1 RDIMM capacity (GB) | 1 Intel Persistent Memory 200 series (BPS) capacity (GB) | Total Standard Memory Capacity (GB) | Total PM Capacity (GB) | Supported Modes |
|--------------------|--|-----------------------|--|-------------------------------------|------------------------|-----------------|
| 4 | 4 | 64 | 512 | 256 | 2048 | MM or AD |

Table 40. Intel Persistent Memory 200 series (BPS) Configuration 1 - 4 x LRDIMMs, 4 x Intel Persistent Memory 200 series (BPS) per processor

| Total No of LRDIMMs | Total No of Intel Persistent Memory 200 series (BPS) DIMMs | 1 LRDIMM capacity (GB) | 1 Intel Persistent Memory 200 series (BPS) capacity (GB) | Total Standard Memory Capacity (GB) | Total PM Capacity (GB) | Supported Modes |
|---------------------|--|------------------------|--|-------------------------------------|------------------------|-----------------|
| 4 | 4 | 128 | 128 | 512 | 512 | AD |
| 4 | 4 | 128 | 256 | 512 | 1024 | AD |
| 4 | 4 | 128 | 512 | 512 | 2048 | MM or AD |

Table 41. Intel Persistent Memory 200 series (BPS) Configuration 2 - 6 x RDIMMs, 1 x Intel Persistent Memory 200 series (BPS) per processor

| Total No of RDIMMs | Total No of Intel Persistent Memory 200 series (BPS) DIMMs | 1 RDIMM capacity (GB) | 1 Intel Persistent Memory 200 series (BPS) capacity (GB) | Total Standard Memory Capacity (GB) | Total PM Capacity (GB) | Supported Modes |
|--------------------|--|-----------------------|--|-------------------------------------|------------------------|-----------------|
| 6 | 1 | 16 | 128 | 96 | 128 | AD |
| 6 | 1 | 32 | 128 | 192 | 128 | AD |
| 6 | 1 | 64 | 128 | 384 | 128 | AD |
| 6 | 1 | 16 | 256 | 96 | 256 | AD |
| 6 | 1 | 32 | 256 | 192 | 256 | AD |
| 6 | 1 | 64 | 256 | 384 | 256 | AD |
| 6 | 1 | 16 | 512 | 96 | 512 | AD |
| 6 | 1 | 32 | 512 | 192 | 512 | AD |
| 6 | 1 | 64 | 512 | 384 | 512 | AD |

Table 42. Intel Persistent Memory 200 series (BPS) Configuration 2 - 6 x LRDIMMs, 1 x Intel Persistent Memory 200 series (BPS) per processor

| Total No of LRDIMMs | Total No of Intel Persistent Memory 200 series (BPS) DIMMs | 1 LRDIMM capacity (GB) | 1 Intel Persistent Memory 200 series (BPS) capacity (GB) | Total Standard Memory Capacity (GB) | Total PM Capacity (GB) | Supported Modes |
|---------------------|--|------------------------|--|-------------------------------------|------------------------|-----------------|
| 6 | 1 | 128 | 128 | 768 | 128 | AD |
| 6 | 1 | 128 | 256 | 768 | 256 | AD |
| 6 | 1 | 128 | 512 | 768 | 512 | AD |

Table 43. Intel Persistent Memory 200 series (BPS) Configuration 3 - 8 x RDIMMs, 1 x Intel Persistent Memory 200 series (BPS) per processor

| Total No of RDIMMs | Total No of Intel Persistent Memory 200 series (BPS) DIMMs | 1 RDIMM capacity (GB) | 1 Intel Persistent Memory 200 series (BPS) capacity (GB) | Total Standard Memory Capacity (GB) | Total PM Capacity (GB) | Supported Modes |
|--------------------|--|-----------------------|--|-------------------------------------|------------------------|-----------------|
| 8 | 1 | 16 | 128 | 128 | 128 | AD |
| 8 | 1 | 32 | 128 | 256 | 128 | AD |
| 8 | 1 | 64 | 128 | 512 | 128 | AD |
| 8 | 1 | 16 | 256 | 128 | 256 | AD |
| 8 | 1 | 32 | 256 | 256 | 256 | AD |
| 8 | 1 | 64 | 256 | 512 | 256 | AD |
| 8 | 1 | 16 | 512 | 128 | 512 | AD |
| 8 | 1 | 32 | 512 | 256 | 512 | AD |
| 8 | 1 | 64 | 512 | 512 | 512 | AD |

Table 44. Intel Persistent Memory 200 series (BPS) Configuration 3 - 8 x LRDIMMs, 1 x Intel Persistent Memory 200 series (BPS) per processor

| Total No of LRDIMMs | Total No of Intel Persistent Memory 200 series (BPS) DIMMs | 1 LRDIMM capacity (GB) | 1 Intel Persistent Memory 200 series (BPS) capacity (GB) | Total Standard Memory Capacity (GB) | Total PM Capacity (GB) | Supported Modes |
|---------------------|--|------------------------|--|-------------------------------------|------------------------|-----------------|
| 8 | 1 | 128 | 128 | 1024 | 128 | AD |
| 8 | 1 | 128 | 256 | 1024 | 256 | AD |
| 8 | 1 | 128 | 512 | 1024 | 512 | AD |

Table 45. Intel Persistent Memory 200 series (BPS) Configuration 4 - 8 x RDIMMs, 4 x Intel Persistent Memory 200 series (BPS) per processor

| Total No of RDIMMs | Total No of Intel Persistent Memory 200 series (BPS) DIMMs | 1 RDIMM capacity (GB) | 1 Intel Persistent Memory 200 series (BPS) capacity (GB) | Total Standard Memory Capacity (GB) | Total PM Capacity (GB) | Supported Modes |
|--------------------|--|-----------------------|--|-------------------------------------|------------------------|-----------------|
| 8 | 4 | 16 | 128 | 128 | 512 | MM or AD |
| 8 | 4 | 32 | 128 | 256 | 512 | AD |
| 8 | 4 | 64 | 128 | 512 | 512 | AD |
| 8 | 4 | 16 | 256 | 128 | 1024 | MM or AD |
| 8 | 4 | 32 | 256 | 256 | 1024 | MM or AD |
| 8 | 4 | 64 | 256 | 512 | 1024 | AD |
| 8 | 4 | 16 | 512 | 128 | 2048 | MM or AD |
| 8 | 4 | 32 | 512 | 256 | 2048 | MM or AD |
| 8 | 4 | 64 | 512 | 512 | 2048 | MM or AD |

Table 46. Intel Persistent Memory 200 series (BPS) Configuration 4 - 8 x LRDIMMs, 4 x Intel Persistent Memory 200 series (BPS) per processor

| Total No of LRDIMMs | Total No of Intel Persistent Memory 200 series (BPS) DIMMs | 1 LRDIMM capacity (GB) | 1 Intel Persistent Memory 200 series (BPS) capacity (GB) | Total Standard Memory Capacity (GB) | Total PM Capacity (GB) | Supported Modes |
|---------------------|--|------------------------|--|-------------------------------------|------------------------|-----------------|
| 8 | 4 | 128 | 128 | 1024 | 512 | AD |
| 8 | 4 | 128 | 256 | 1024 | 1024 | AD |
| 8 | 4 | 128 | 512 | 1024 | 2048 | AD |

Table 47. Intel Persistent Memory 200 series (BPS) Configuration 5 - 8 x RDIMMs, 8 x Intel Persistent Memory 200 series (BPS) per processor

| Total No of RDIMMs | Total No of Intel Persistent Memory 200 series (BPS) DIMMs | 1 RDIMM capacity (GB) | 1 Intel Persistent Memory 200 series (BPS) capacity (GB) | Total Standard Memory Capacity (GB) | Total PM Capacity (GB) | Supported Modes |
|--------------------|--|-----------------------|--|-------------------------------------|------------------------|-----------------|
| 8 | 8 | 16 | 128 | 128 | 1024 | MM or AD |
| 8 | 8 | 32 | 128 | 256 | 1024 | MM or AD |
| 8 | 8 | 64 | 128 | 512 | 1024 | AD |
| 8 | 8 | 16 | 256 | 128 | 2048 | MM or AD |
| 8 | 8 | 32 | 256 | 256 | 2048 | MM or AD |
| 8 | 8 | 64 | 256 | 512 | 2048 | MM or AD |
| 8 | 8 | 16 | 512 | 128 | 4096 | AD |
| 8 | 8 | 32 | 512 | 256 | 4096 | MM or AD |
| 8 | 8 | 64 | 512 | 512 | 4096 | MM or AD |

Table 48. Intel Persistent Memory 200 series (BPS) Configuration 5 - 8 x LRDIMMs, 8 x Intel Persistent Memory 200 series (BPS) per processor

| Total No of LRDIMMs | Total No of Intel Persistent Memory 200 series (BPS) DIMMs | 1 LRDIMM capacity (GB) | 1 Intel Persistent Memory 200 series (BPS) capacity (GB) | Total Standard Memory Capacity (GB) | Total PM Capacity (GB) | Supported Modes |
|---------------------|--|------------------------|--|-------------------------------------|------------------------|-----------------|
| 8 | 8 | 128 | 128 | 1024 | 1024 | AD |
| 8 | 8 | 128 | 256 | 1024 | 2048 | AD |
| 8 | 8 | 128 | 512 | 1024 | 4096 | MM or AD |

Table 49. Intel Persistent Memory 200 series (BPS) Configuration 6 - 12 x RDIMMs, 2 x Intel Persistent Memory 200 series (BPS) per processor

| Total No of RDIMMs | Total No of Intel Persistent Memory 200 series (BPS) DIMMs | 1 RDIMM capacity (GB) | 1 Intel Persistent Memory 200 series (BPS) capacity (GB) | Total Standard Memory Capacity (GB) | Total PM Capacity (GB) | Supported Modes |
|--------------------|--|-----------------------|--|-------------------------------------|------------------------|-----------------|
| 12 | 2 | 16 | 128 | 192 | 256 | AD |
| 12 | 2 | 32 | 128 | 384 | 256 | AD |

Table 49. Intel Persistent Memory 200 series (BPS) Configuration 6 - 12 x RDIMMs, 2 x Intel Persistent Memory 200 series (BPS) per processor (continued)

| Total No of RDIMMs | Total No of Intel Persistent Memory 200 series (BPS) DIMMs | 1 RDIMM capacity (GB) | 1 Intel Persistent Memory 200 series (BPS) capacity (GB) | Total Standard Memory Capacity (GB) | Total PM Capacity (GB) | Supported Modes |
|--------------------|--|-----------------------|--|-------------------------------------|------------------------|-----------------|
| 12 | 2 | 64 | 128 | 768 | 256 | AD |
| 12 | 2 | 16 | 256 | 192 | 512 | AD |
| 12 | 2 | 32 | 256 | 384 | 512 | AD |
| 12 | 2 | 64 | 256 | 768 | 512 | AD |
| 12 | 2 | 16 | 512 | 192 | 1024 | AD |
| 12 | 2 | 32 | 512 | 384 | 1024 | AD |
| 12 | 2 | 64 | 512 | 768 | 1024 | AD |

Table 50. Intel Persistent Memory 200 series (BPS) Configuration 6 - 12 x LRDIMMs, 2 x Intel Persistent Memory 200 series (BPS) per processor

| Total No of LRDIMMs | Total No of Intel Persistent Memory 200 series (BPS) DIMMs | 1 LRDIMM capacity (GB) | 1 Intel Persistent Memory 200 series (BPS) capacity (GB) | Total Standard Memory Capacity (GB) | Total PM Capacity (GB) | Supported Modes |
|---------------------|--|------------------------|--|-------------------------------------|------------------------|-----------------|
| 12 | 2 | 128 | 128 | 1536 | 256 | AD |
| 12 | 2 | 128 | 256 | 1536 | 512 | AD |
| 12 | 2 | 128 | 512 | 1536 | 1024 | AD |

Removing a memory module

Prerequisites

1. Follow the safety guidelines listed in the [Safety instructions](#).
2. Follow the procedure listed in the [Before working inside your system](#).
3. [Remove the air shroud](#).

 **WARNING:** The memory modules are hot to touch for some time after the system has been powered off. Allow the memory modules to cool before handling them.

 **NOTE:** To ensure proper system cooling, memory module blanks must be installed in any memory socket that is not occupied. Remove memory module blanks only if you intend to install memory modules in those sockets.

 **NOTE:** DIMM blanks to be removed for partial configurations with EXT heat sink having CPU TDP > 165 W.

Steps

1. Locate the appropriate memory module socket.
2. To release the memory module from the socket, simultaneously press the ejectors on both ends of the memory module socket to fully open.

 **CAUTION:** Handle each memory module only by the card edges, ensuring not to touch the middle of the memory module or metallic contacts.

3. Lift the memory module away from the system.

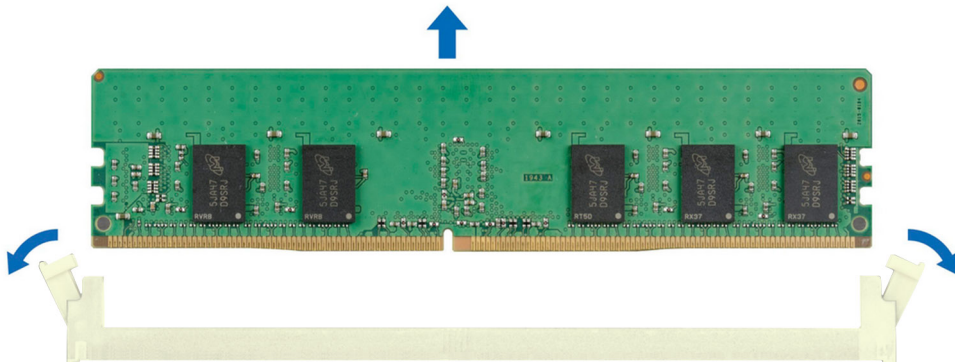

Figure 64. Removing a memory module

Next steps

1. [Replace the memory module.](#)
2. If you are removing the memory module permanently, install a memory module blank. The procedure to install a memory module blank is similar to that of the memory module.

NOTE: When operating your system with single processor, install memory module blanks in processor 2 memory sockets.

Installing a memory module

Prerequisites

1. Follow the safety guidelines listed in the [Safety instructions](#).
2. Follow the procedure listed in [Before working inside your system](#).
3. [Remove the air shroud.](#)

Steps

1. Locate the appropriate memory module socket.

CAUTION: Handle each memory module only by the card edges, ensuring not to touch the middle of the memory module or metallic contacts.

2. If a memory module is installed in the socket, remove it.

NOTE: Ensure the socket ejector latches are fully open, before installing the memory module.

3. Align the edge connector of the memory module with the alignment key of the memory module socket, and insert the memory module in the socket.

CAUTION: To prevent damage to the memory module or the memory module socket during installation, do not bend or flex the memory module; insert both ends of the memory module simultaneously.

NOTE: The memory module socket has an alignment key that enables you to install the memory module in the socket in only one orientation.

CAUTION: Do not apply pressure at the center of the memory module; apply pressure at both ends of the memory module evenly.

4. Press the memory module with your thumbs until the ejectors firmly click into place. When the memory module is properly seated in the socket, the levers on the memory module socket align with the levers on the other sockets that have memory modules installed.

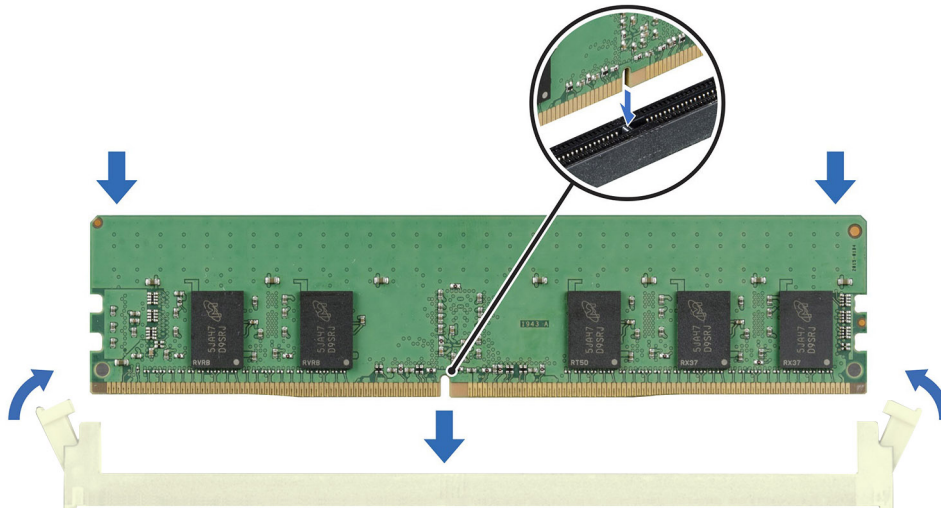

Figure 65. Installing a memory module

Next steps

1. Install the air shroud.
2. Follow the procedure listed in [After working inside the system](#).
3. To verify if the memory module has been installed properly, press F2 and navigate to **System Setup Main Menu > System BIOS > Memory Settings**. In the **Memory Settings** screen, the System Memory Size must reflect the updated capacity of the installed memory.
4. If the System Memory Size is incorrect, one or more of the memory modules may not be installed properly. Ensure that the memory modules are firmly seated in their sockets.
5. Run the system memory test in system diagnostics.

Processor and heat sink module

This is a service technician replaceable part only.

Removing the processor and heat sink module

Prerequisites

1. Follow the safety guidelines listed in the [Safety instructions](#).
2. Follow the procedure listed in the [Before working inside your system](#).
3. If installed, [remove the air shroud](#).

NOTE: The heat sink and processor are hot to touch for some time after the system has been powered down. Allow the processor heat sink module (PHM) to cool down before handling them.

Steps

1. Ensure all four anti-tilt wires are in the locked position (outward position), using a Torx #T30 screwdriver, loosen the captive screws on the PHM in the order below:
 - a. Loosen the first screw three turns.
 - b. Loosen the screw diagonally opposite to the screw you loosened first.
 - c. Repeat the procedure for the remaining two screws.
 - d. Return to the first screw and loosen it completely.
2. Set all the anti-tilt wires to unlocked position (inward position).

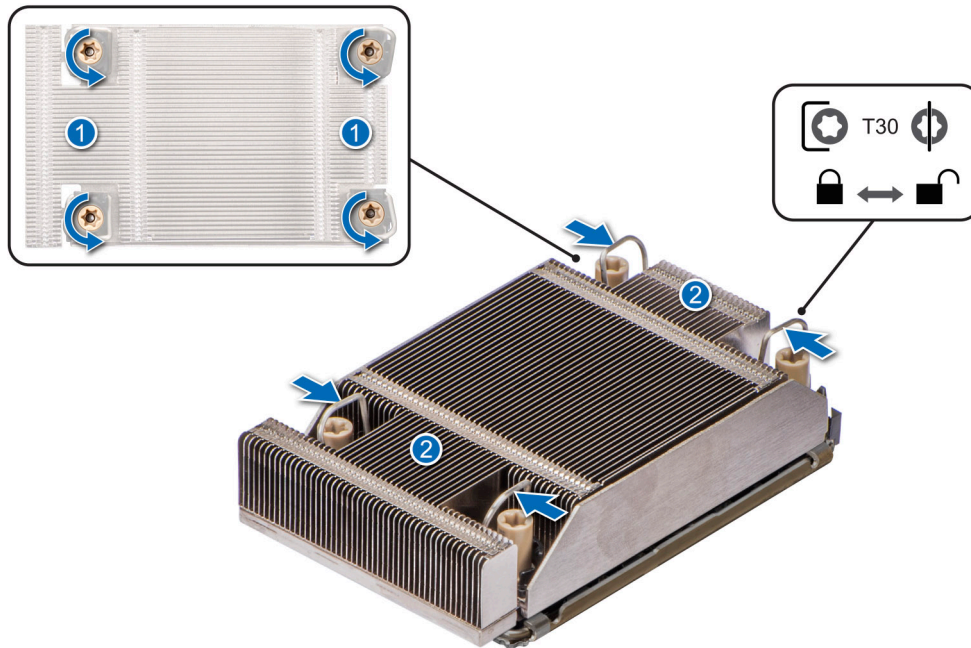

Figure 66. Loosening the screws and set the anti-tilt wires to the unlocked position

3. Lift the PHM from the system and set the PHM aside with the processor side facing up.

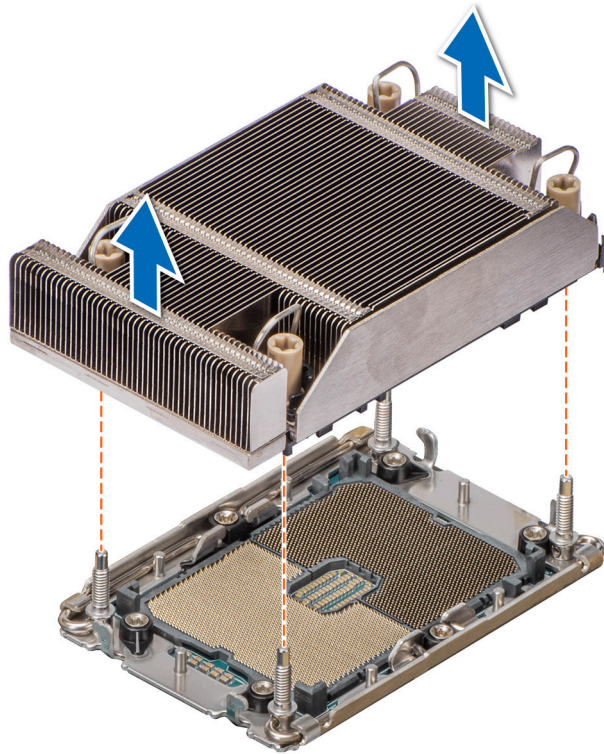

Figure 67. Removing a processor and heat sink module

Next steps

If you are removing a faulty heat sink, [replace the heat sink](#), if not, [remove the processor](#).

Removing the processor from the processor heat sink module

Prerequisites

⚠ WARNING: Remove the processor from processor and heat sink module (PHM) only if you are replacing the processor or heat sink.

1. Follow the safety guidelines listed in the [Safety instructions](#).
2. Follow the procedure listed in the [Before working inside your system](#).
3. If installed, [remove the air shroud](#).
4. [Remove the processor and heat sink module \(PHM\) or the liquid cooling module](#).

⚠ CAUTION: You may find the CMOS battery loss or CMOS checksum error displayed during the first instance of powering on the system after replacing the processor or system board. To fix this, simply go to setup option to configure the system settings.

Steps

1. Place the PHM with the processor side facing up.
2. Using your thumb, lift up the Thermal Interface Material (TIM) break lever to release the processor from the TIM and carrier.
3. Holding the processor by its edges, lift the processor away from the carrier.

i NOTE: Ensure to hold the carrier to the heat sink as you lift the TIM break lever.

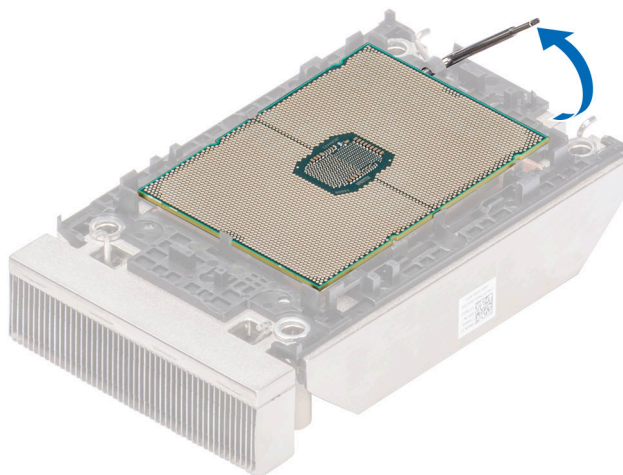

Figure 68. Lift up the TIM break lever

- Using your thumb and index finger, first hold the carrier release tab at the pin 1 connector, pull out the tip of the carrier release tab, and then lift the carrier partially from the heat sink.

NOTE: Ensure to return the TIM break lever back to its original position.

- Using your thumb and index finger, first hold the carrier release tab at the pin 1 connector, pull out the tip of the carrier release tab, and then lift the carrier from the heat sink.
- After all the corners are released from the heat sink, lift the carrier from the pin 1 corner of the heat sink.

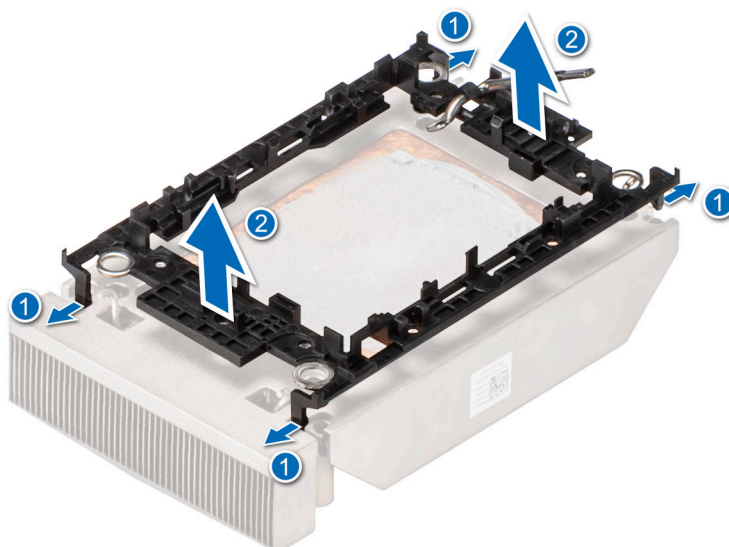

Figure 69. Removing the processor carrier

Next steps

Replace the processor into a processor and heat sink module (PHM).

Installing the processor

Prerequisites

- Follow the safety guidelines listed in the [Safety instructions](#).
- Follow the procedure listed in [Before working inside your system](#).

Steps

1. Place the processor in the processor tray.

i **NOTE:** Ensure the pin 1 indicator on the processor tray is aligned with the pin 1 indicator on the processor.

2. Place the processor carrier on top of the processor that is in the processor tray aligning pin 1 indicator on the processor.

i **NOTE:** Ensure the pin 1 indicator on the bracket is aligned with the pin 1 indicator on the processor before placing the bracket on the processor.

i **NOTE:** Before you install the heat sink, ensure to place the processor and carrier in the tray.

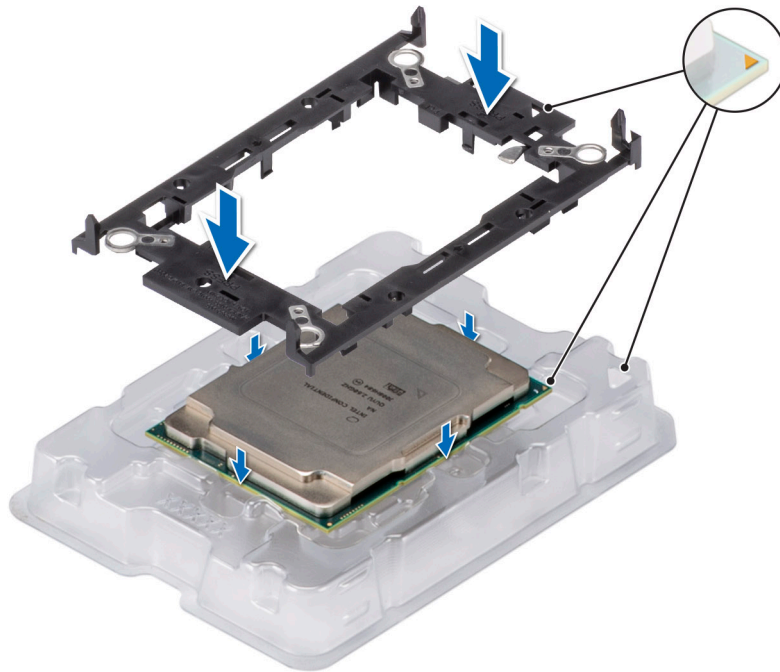

Figure 70. Installing the processor carrier

3. Align the processor with processor carrier, by using the fingers press the carrier on all the four sides until it clicks into place.

i **NOTE:** Ensure the processor is securely latched to the processor carrier.

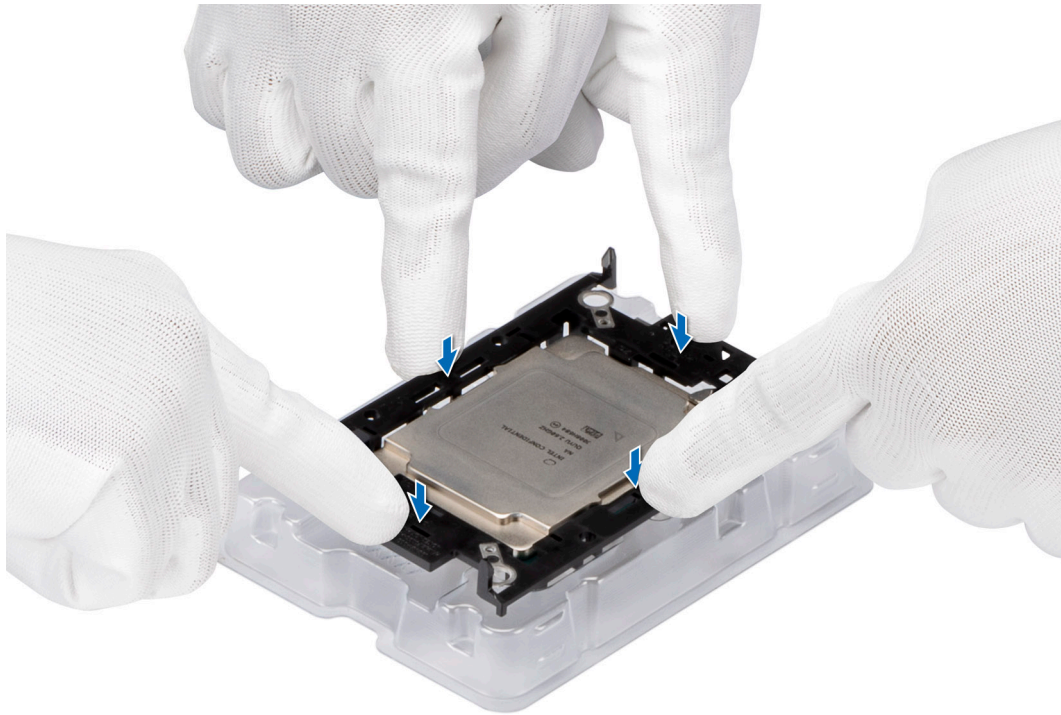

Figure 71. Press the carrier on the four sides

4. If you are using an existing heat sink, remove the thermal grease on the heat sink by using a clean lint-free cloth.
5. Use the thermal grease syringe included with your processor kit to apply the grease in a thin spiral on the bottom of the heat sink.

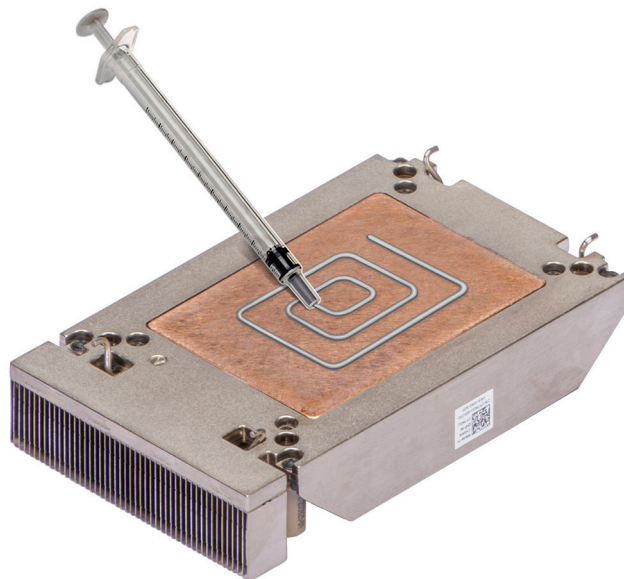

Figure 72. Applying thermal grease

CAUTION: Applying too much thermal grease can result in excess grease coming in contact with and contaminating the processor socket.

NOTE: The thermal grease syringe is intended for single use only. Dispose of the syringe after you use it.

6. For new heat sink, remove the Thermal Interface Material (TIM) protective film from the base of heat sink.

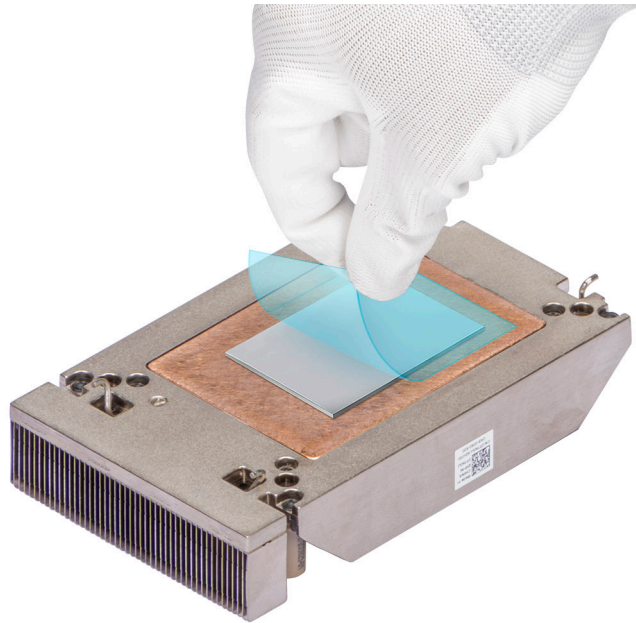

Figure 73. Remove the Thermal Interface Material (TIM) protective film

7. Place the heat sink on the processor and press the base of the heat sink until the carrier locks onto the heat sink at all the four corners.

CAUTION: To avoid damaging the fins on the heat sink, do not press down on the heat sink fins.

NOTE:

- Ensure latching features on processor carrier and heat sink are aligned during assembly.
- Ensure that the pin 1 indicator on the heat sink is aligned with the pin 1 indicator on the carrier before placing the heat sink onto the processor carrier.

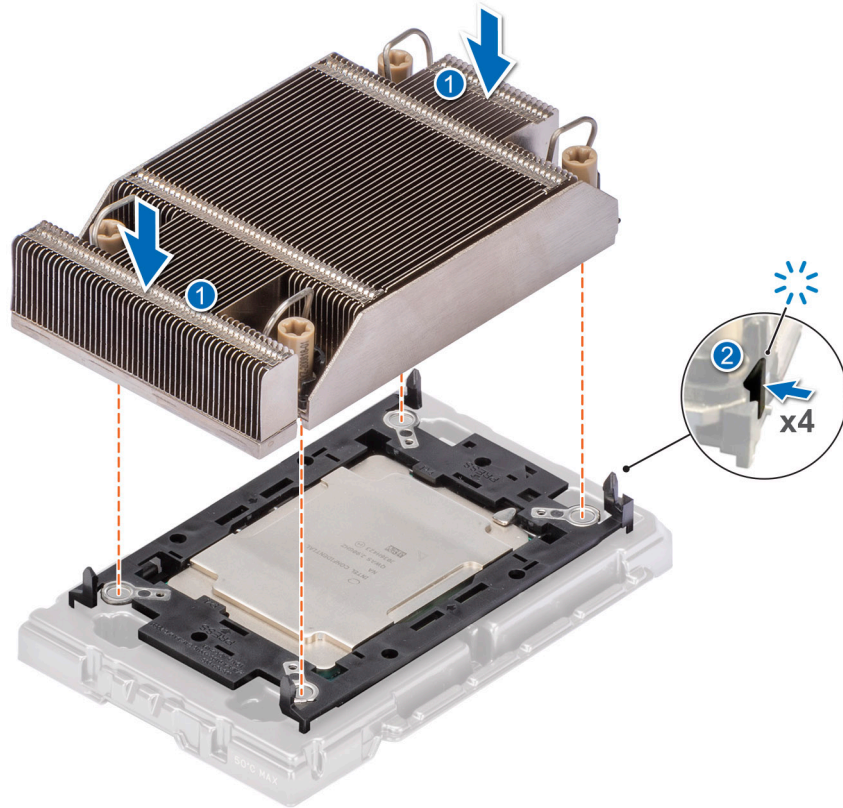

Figure 74. Installing the heat sink onto the processor

Next steps

1. [Install the processor heat sink module.](#)
2. If removed, [install the air shroud.](#)
3. Follow the procedure listed in [After working inside your system.](#)

Installing the processor heat sink module

Prerequisites

Never remove the heat sink from a processor unless you intend to replace the processor or system board. The heat sink is necessary to maintain proper thermal conditions.

1. Follow the safety guidelines listed in the [Safety instructions.](#)
2. Follow the procedure listed in the [Before working inside your system.](#)
3. If installed, [remove the air shroud.](#)
4. If installed, remove the processor dust cover.

Steps

1. Set the anti-tilt wires to the unlocked position on the heat sink (inward position).
2. Align the pin 1 indicator of the heat sink to the system board, and then place the processor and heat sink on the processor socket.

CAUTION: To avoid damaging the fins on the heat sink, do not press down on the heat sink fins.

NOTE: Ensure the heat sink is held parallel to the system board to prevent damaging the components.

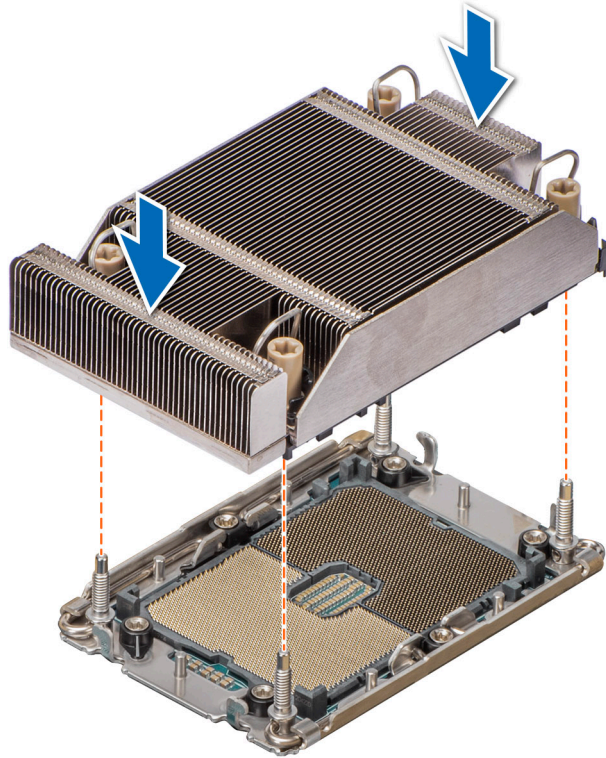

Figure 75. Installing the processor and heat sink (PHM)

3. Set the anti-tilt wires to the locked position (outward position), and then using the Torx #T30 screwdriver, tighten the screws (8 in-lbf) on the heat sink in the below sequence:
 - a. Tighten the first screw three turns.
 - b. Tighten the screw diagonally opposite to the screw you tighten first.
 - c. Repeat the procedure for the remaining two screws.
 - d. Return to the first screw to tighten it completely.

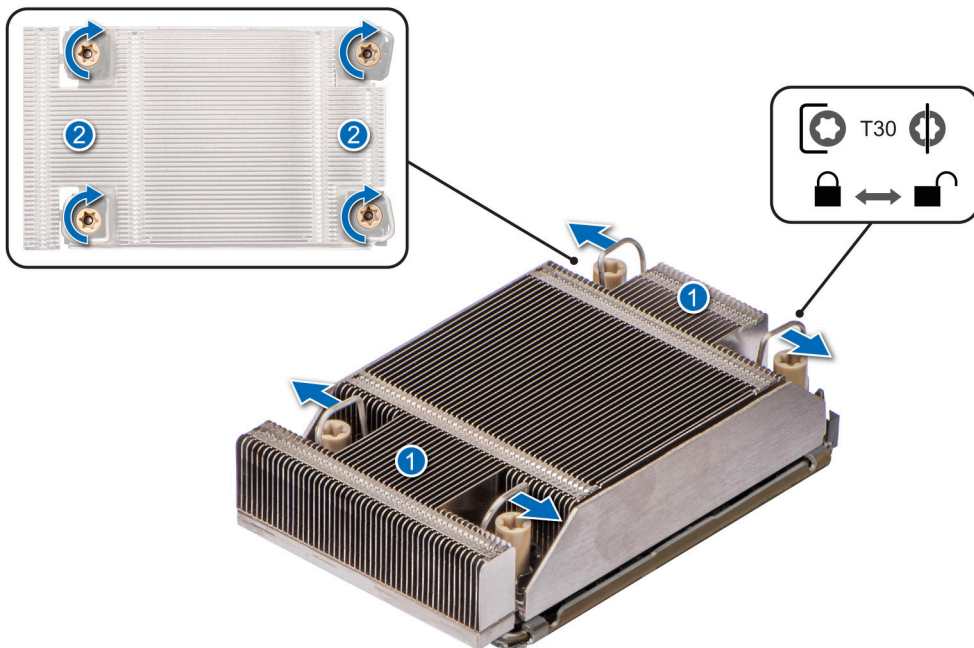

Figure 76. Set the anti-tilt wires to the locked position and tightening the screws

Next steps

1. If removed, [install the air shroud](#).
2. Follow the procedure listed in the [After working inside your system](#).

Removing the liquid cooling module

Prerequisites

1. Follow the safety guidelines listed in the [Safety instructions](#).
2. Follow the procedure listed in the [Before working inside your system](#).

⚠ WARNING: The heat sink and processor are hot to touch for some time after the system has been powered off. Allow the heat sink and processor to cool down before handling them.

Steps

1. Using a Phillips #1 screwdriver, loosen the captive screw on the liquid cooling ring holder.
2. Lift up the liquid cooling ring holder to loosen the liquid cooling tubes.
3. Disconnect the liquid cooling detection cable from the rear I/O (RIO) card connector.
4. Unlatch the tube clip to loosen the liquid cooling tubes.
5. Remove the liquid cooling tubes from the RIO panel.
6. Using a Torx #T30 screwdriver, loosen the captive screws on the heat sink.
7. Set all the anti-tilt wires to unlocked position (inward position).
8. Lift the liquid cooling heat sink modules from the system.

i NOTE: The numbers on the image do not depict the exact steps. The numbers are for representation of sequence.

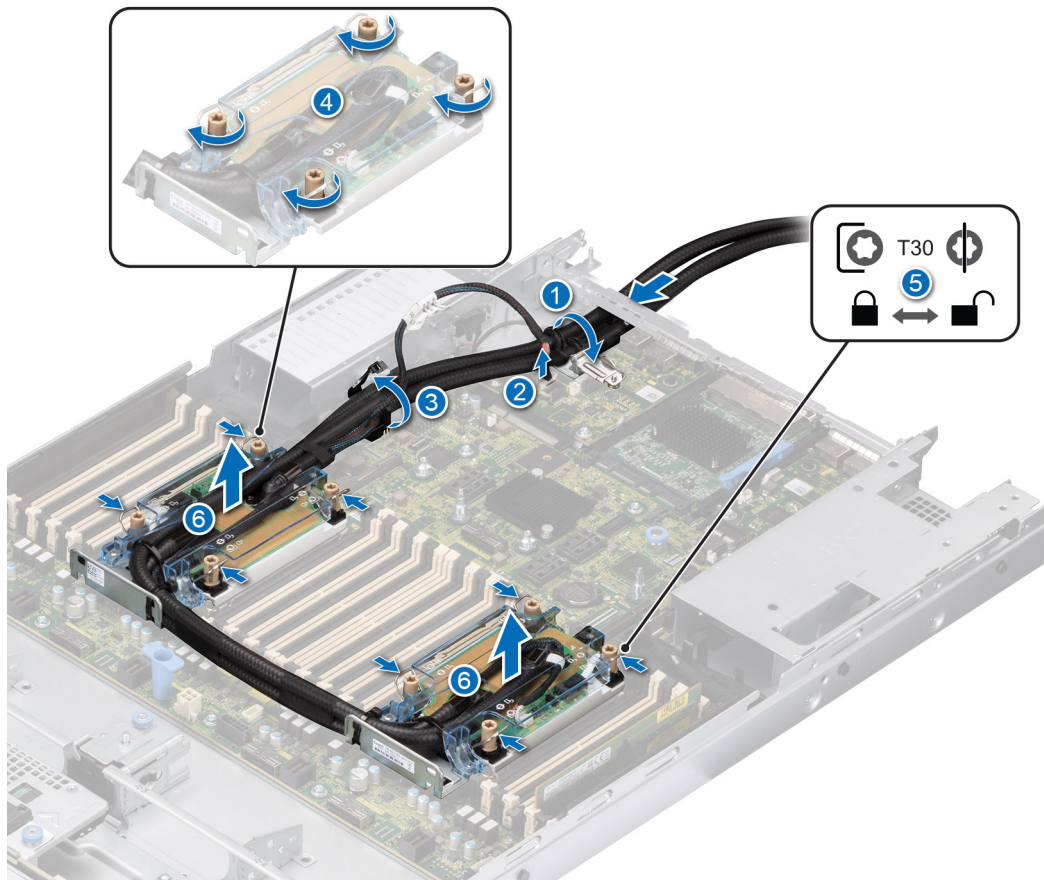

Figure 77. Removing the liquid cooling heat sink modules

Next steps

1. If you are uninstalling a faulty liquid cooling module, [replace the liquid cooling modules](#), else [remove the processor](#).

Installing the liquid cooling module

Prerequisites

Never uninstall the heat sink from a processor unless you intend to replace the processor or system board. The heat sink is necessary to maintain proper thermal conditions.

1. Follow the safety guidelines listed in the [Safety instructions](#).
2. Follow the procedure listed in the [Before working inside your system](#).
3. If installed, [remove the air shroud](#).
4. Remove [expansion card riser](#).
5. If installed, remove the processor dust cover.

Steps

1. Align the screws on the liquid cooling module with the standoff screws on the system board.

NOTE: Ensure that the liquid cooling tubes and liquid detection cable are placed towards the rear of the system.

2. Set all the anti-tilt wires to locked position (outward position).
3. Using a Torx #T30 screwdriver, tighten the captive screws on liquid cooling module.
4. Route the liquid cooling tubes on the front of the system between DIMM slots and J_SL connector.
5. Route the liquid cooling tubes to the rear end of the system between DIMM slots and the relay components.

NOTE: Liquid detection cable must be placed underneath the cooling tubes to ensure it does not interfere with the PCIe risers.

6. Route the rear end of the liquid cooling tube through the RIO panel.

NOTE: Follow the number labels on the liquid cooling tubes and ring holders (1,2).

7. Connect the liquid cooling detection cable to the RIO connector.
8. Insert the rubber rings on the tubes on to the rubber holder.
9. Using a Phillips #1 screwdriver, tighten the captive screw on the liquid cooling ring holder to secure it in place.
10. Route the liquid cooling tubes and liquid cooling detection cable along side PSU 2 and secure them with the tube clip.

NOTE: The numbers on the image do not depict the exact steps. The numbers are for representation of sequence.

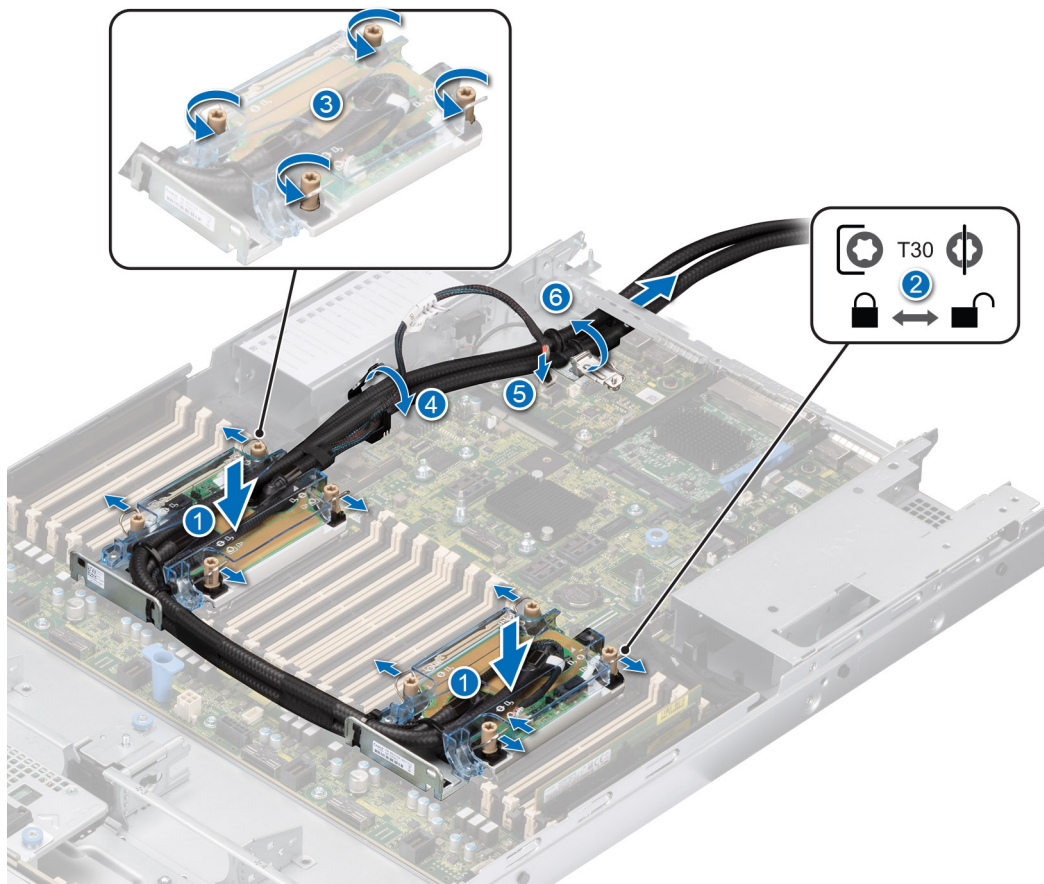

Figure 78. Installing the liquid cooling modules

Next steps

1. Install the [expansion card riser](#).
2. Follow the procedure listed in the [After working inside your system](#).

Expansion cards and expansion card risers

NOTE: When an expansion card is not supported or missing, riser the iDRAC and Lifecycle Controller logs an event. This does not prevent your system from booting. However, if a F1/F2 pause occurs with an error message, see *Troubleshooting expansion cards* section in the *Dell EMC PowerEdge Servers Troubleshooting Guide* at www.dell.com/poweredgemanuals.

Expansion card installation guidelines

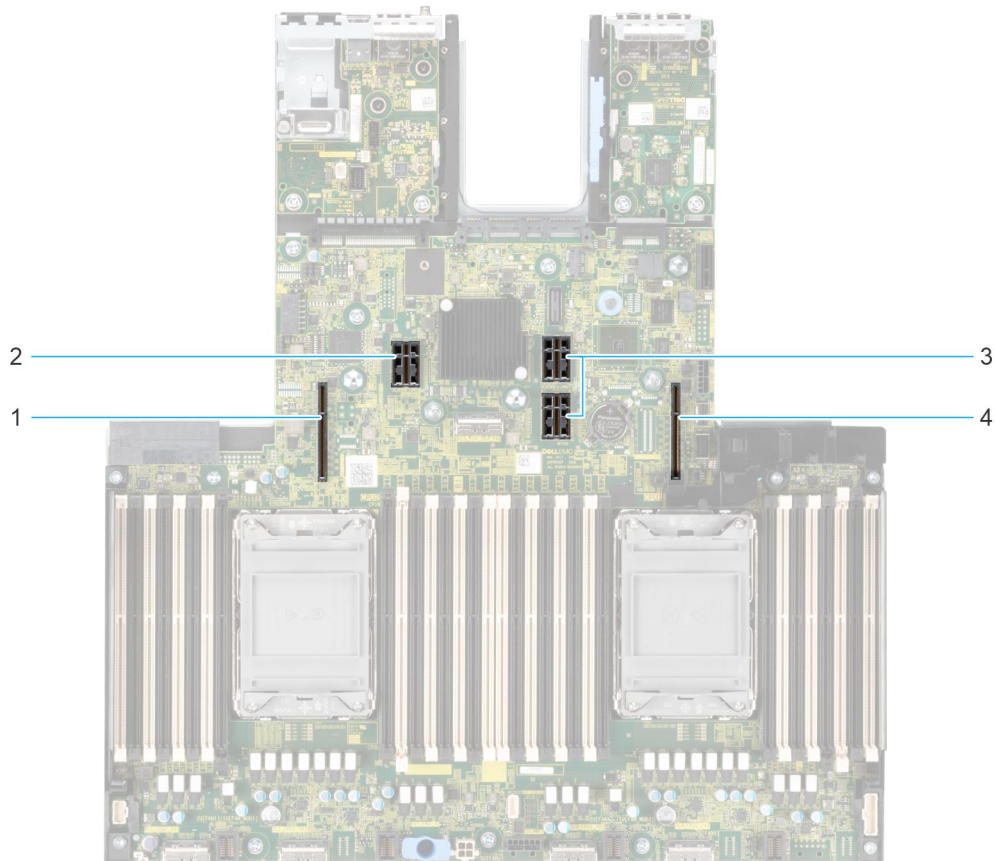

Figure 79. Expansion card slot connectors

- 1. Riser 4 slot
- 2. Riser 3 slot
- 3. Riser 2 slot
- 4. Riser 1 slot

Table 51. Expansion card risers

| Expansion card riser | PCIe slots on the riser | No. of slots | Processor connection | height | length | Slot width |
|----------------------|-------------------------|--------------|----------------------|-------------|--------------|------------|
| R1a (Riser 1) | Slot 1 | 1 | Processor 1 | Full height | 3/4th length | x16 |
| R2a (Riser 2) | Slot 1 | 2 | Processor 1 | Low profile | Half length | x16 |
| | Slot 2 | | Processor 2 | Low profile | Half length | x16 |
| R2b (SANPI Riser) | Slot 1 | 2 | Processor 1 and 2 | Low profile | Half length | x16 |
| | Slot 2 | | Processor 2 | Low profile | Half length | x8 |
| R3a (Riser 3) | Slot 3 | 1 | Processor 2 | Low profile | Half length | x16 |
| R4c + R4d (Riser 4) | Slot 2 | 1 | Processor 2 | Full height | 3/4th length | x16 |
| R1d (Paddle card) | Slot 1 | 1 | Processor 1 | Low profile | Half length | x16 |

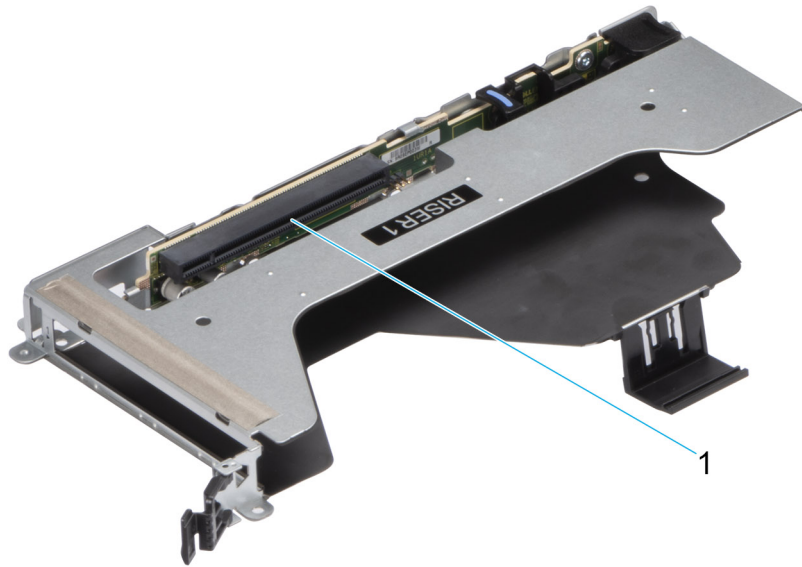

Figure 80. Riser 1 - Full height

1. Slot 1

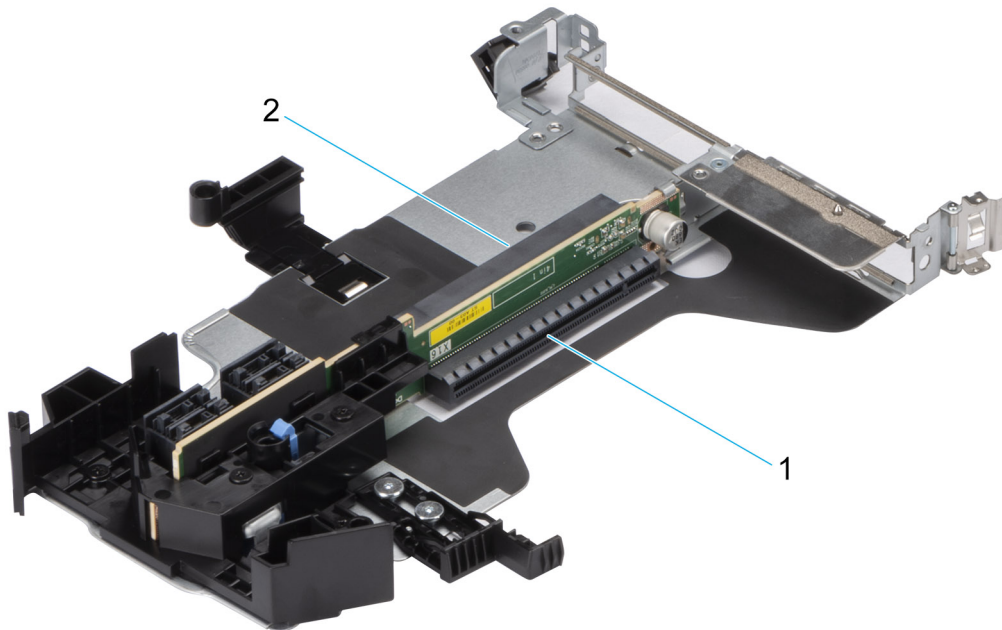

Figure 81. Riser 2 - Low profile

1. Slot 1
2. Slot 2

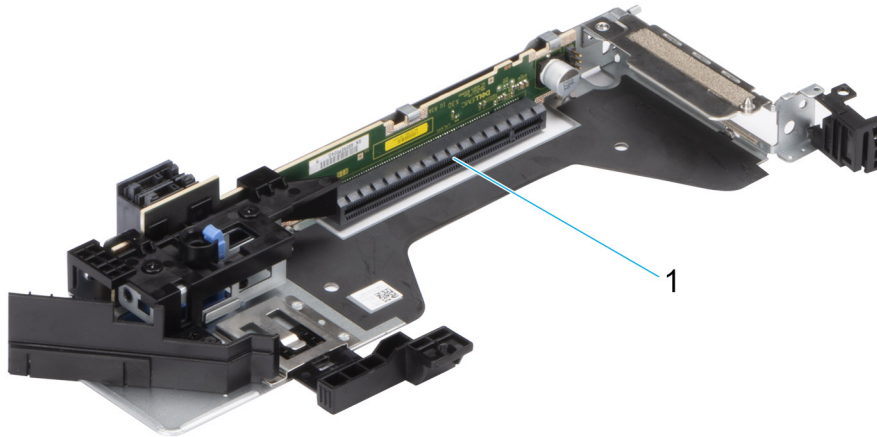

Figure 82. Riser 3 - Low profile

1. Slot 3

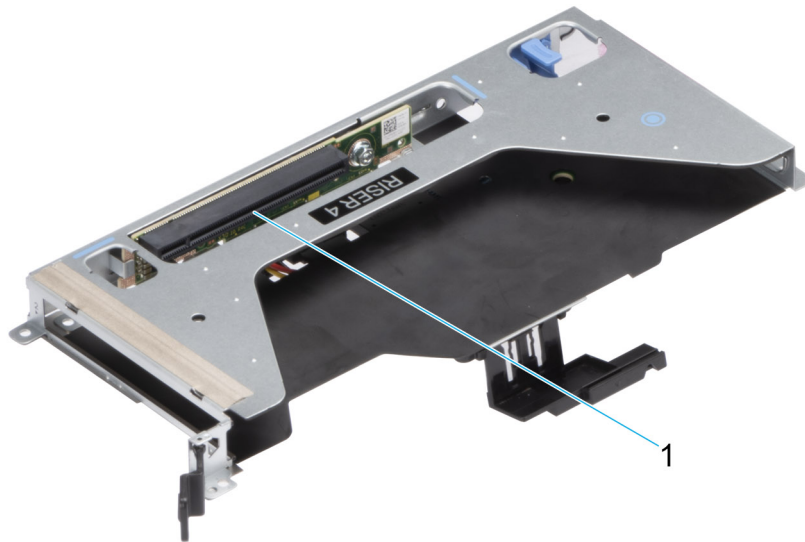

Figure 83. Riser 4 -Full height

1. Slot 2

Table 52. PCIe riser configuration and PERC type support

| Configuration | Number of processors | PERC supported | Rear storage |
|---------------------------------------|----------------------|----------------|--------------|
| R2A + R3A (Config0-1) | 1 | fPERC | No |
| R2A + R3A (Config0-2) | 2 | fPERC | No |
| R2B + R3A (Config1) | 2 | fPERC | No |
| R3A (Config2) | 2 | fPERC | Yes |
| R1A + R4C + R4D(Config3) | 2 | fPERC | No |
| R1D paddle card + R2A+R3A(Config4) | 2 | fPERC | No |
| R1D paddle card + R2B + R3A (Config5) | 2 | fPERC | No |
| R3a + R1D paddle card (Config6) | 2 | fPERC | Yes |

The PowerEdge R650 supports the following riser configurations:

Table 53. Riser configuration 0-1: R2A + R3A

| Card type | Slot priority |
|-------------------------------|----------------------|
| Storage | |
| Dell External PERC Adapter | 1 |
| Foxconn (fPERC) | Integrated slot |
| Inventec (fPERC) | Integrated slot |
| Dell BOSS S2 Module | Integrated slot |
| Intel (PCIe SSD) | 1 |
| Samsung (PCIe SSD) | 1 |
| BOSS-S1 | 1 |
| Networking | |
| Mellanox (NIC: 100 Gb) | 1 |
| Mellanox (NIC: 25 Gb) | 1 |
| SolarFlare (NIC: 25 Gb) | 1 |
| Broadcom (NIC: 25 Gb) | 1 |
| Broadcom (NIC: 100 Gb) | 1 |
| Qlogic - Marvell (NIC: 25 Gb) | 1 |
| Emulex (HBA: FC 32) | 1 |
| Emulex (HBA: FC 16) | 1 |
| Qlogic (HBA: FC 32) | 1 |
| Qlogic (HBA: FC 16) | 1 |
| Qlogic (NIC: 10 Gb) | 1 |
| Qlogic - Marvell (NIC: 10 Gb) | 1 |
| Broadcom (NIC: 10 Gb) | 1 |
| Intel (NIC: 10 Gb) | 1 |
| Intel (NIC: 100 Gb) | 1 |
| Mellanox (NIC: HDR100 VPI) | 1 |
| Mellanox (NIC:HDR VPI) | 1 |
| Marvell (OCP: 25 Gb) | Integrated slot |
| Mellanox (OCP: 25 Gb) | Integrated slot |
| SolarFlare (OCP: 25 Gb) | Integrated slot |
| Broadcom (OCP: 25 Gb) | Integrated slot |
| Intel (OCP: 25 Gb) | Integrated slot |
| Broadcom (OCP: 10 Gb) | Integrated slot |
| Intel (OCP: 10 Gb) | Integrated slot |
| Qlogic (OCP: 10 Gb) | Integrated slot |
| Broadcom (OCP: 1 Gb) | Integrated slot |
| Intel (OCP: 1 Gb) | Integrated slot |
| Others | |

Table 53. Riser configuration 0-1: R2A + R3A (continued)

| Card type | Slot priority |
|-------------------|---------------|
| Inventec (VGA) | 3 |
| Inventec (Serial) | 3 |

Table 54. Riser configuration 0-2: R2A + R3A

| Card type | Slot priority |
|-------------------------------|-----------------|
| Storage | |
| Dell External PERC Adapter | 2, 1, 3 |
| Foxconn (fPERC) | Integrated slot |
| Inventec (fPERC) | Integrated slot |
| Dell BOSS S2 Module | Integrated slot |
| Intel (PCIe SSD) | 2, 1, 3 |
| Samsung (PCIe SSD) | 2, 1, 3 |
| BOSS-S1 | 2, 1, 3 |
| Networking | |
| Mellanox (NIC: 100 Gb) | 2, 1, 3 |
| Mellanox (NIC: 25 Gb) | 2, 1, 3 |
| SolarFlare (NIC: 25 Gb) | 2, 1, 3 |
| Broadcom (NIC: 25 Gb) | 2, 1, 3 |
| Broadcom (NIC: 100 Gb) | 2, 1, 3 |
| Qlogic - Marvell (NIC: 25 Gb) | 2, 1, 3 |
| Emulex (HBA: FC 32) | 2, 1, 3 |
| Emulex (HBA: FC 16) | 2, 1, 3 |
| Qlogic (HBA: FC 32) | 2, 1, 3 |
| Qlogic (HBA: FC 16) | 2, 1, 3 |
| Qlogic (NIC: 10 Gb) | 2, 1, 3 |
| Qlogic - Marvell (NIC: 10 Gb) | 2, 1, 3 |
| Broadcom (NIC: 10 Gb) | 2, 1, 3 |
| Intel (NIC: 10 Gb) | 2, 1, 3 |
| Intel (NIC: 100 Gb) | 2, 1, 3 |
| Broadcom (NIC: 1 Gb) | 2, 1, 3 |
| Intel (NIC: 1 Gb) | 2, 1, 3 |
| Mellanox (NIC: HDR100 VPI) | 2, 1, 3 |
| Mellanox (NIC:HDR VPI) | 2, 1, 3 |
| Marvell (OCP: 25 Gb) | Integrated slot |
| Mellanox (OCP: 25 Gb) | Integrated slot |
| SolarFlare (OCP: 25 Gb) | Integrated slot |
| Broadcom (OCP: 25 Gb) | Integrated slot |
| Intel (OCP: 25 Gb) | Integrated slot |

Table 54. Riser configuration 0-2: R2A + R3A (continued)

| Card type | Slot priority |
|-----------------------|-----------------|
| Broadcom (OCP: 10 Gb) | Integrated slot |
| Intel (OCP: 10 Gb) | Integrated slot |
| Qlogic (OCP: 10 Gb) | Integrated slot |
| Broadcom (OCP: 1 Gb) | Integrated slot |
| Intel (OCP: 1 Gb) | Integrated slot |
| GPU / Others | |
| Nvidia (T4 GPU) | 2, 1, 3 |
| Intel (GPU) | 2, 1, 3 |
| Inventec (VGA) | 3 |
| Inventec (Serial) | 3 |

Table 55. Riser configuration 1: R2B + R3A

| Card type | Slot priority |
|-------------------------------|-----------------|
| Storage | |
| Dell External PERC Adapter | 2, 3 |
| Foxconn (fPERC) | Integrated slot |
| Inventec (fPERC) | Integrated slot |
| Dell BOSS S2 Module | Integrated slot |
| Intel (PCIe SSD) | 2, 3 |
| Samsung (PCIe SSD) | 2, 3 |
| Networking | |
| Mellanox (NIC: 100 Gb) | 3 |
| Mellanox (NIC: 25 Gb) | 3 |
| SolarFlare (NIC: 25 Gb) | 2, 3 |
| Broadcom (NIC: 25 Gb) | 2, 3 |
| Broadcom (NIC: 100 Gb) | 3 |
| Qlogic - Marvell (NIC: 25 Gb) | 2, 3 |
| Emulex (HBA: FC 32) | 2, 3 |
| Emulex (HBA: FC 16) | 2, 3 |
| Qlogic (HBA: FC 32) | 2, 3 |
| Qlogic (HBA: FC 16) | 2, 3 |
| Qlogic (NIC: 10 Gb) | 2, 3 |
| Qlogic - Marvell (NIC: 10 Gb) | 2, 3 |
| Broadcom (NIC: 10 Gb) | 2, 3 |
| Broadcom (NIC: 10 Gb) | 3 |
| Intel (NIC: 10 Gb) | 2, 3 |
| Intel (NIC: 100 Gb) | 3 |
| Broadcom (NIC: 1 Gb) | 2, 3 |

Table 55. Riser configuration 1: R2B + R3A (continued)

| Card type | Slot priority |
|----------------------------|-----------------|
| Intel (NIC: 1 Gb) | 2, 3 |
| Mellanox (NIC: HDR100 VPI) | 1 |
| Mellanox (NIC:HDR VPI) | 1 |
| Marvell (OCP: 25 Gb) | Integrated slot |
| Mellanox (OCP: 25 Gb) | Integrated slot |
| SolarFlare (OCP: 25 Gb) | Integrated slot |
| Broadcom (OCP: 25 Gb) | Integrated slot |
| Intel (OCP: 25 Gb) | Integrated slot |
| Broadcom (OCP: 10 Gb) | Integrated slot |
| Intel (OCP: 10 Gb) | Integrated slot |
| Qlogic (OCP: 10 Gb) | Integrated slot |
| Broadcom (OCP: 1 Gb) | Integrated slot |
| Intel (OCP: 1 Gb) | Integrated slot |
| GPU / Others | |
| Nvidia (T4 GPU) | 3 |
| Intel (GPU) | 3 |
| Inventec (VGA) | 3 |
| Inventec (Serial) | 3 |

Table 56. Riser configuration 2: R3A

| Card type | Slot priority |
|-------------------------------|-----------------|
| Storage | |
| Dell External PERC Adapter | 3 |
| Foxconn (fPERC) | Integrated slot |
| Inventec (fPERC) | Integrated slot |
| Dell BOSS S2 Module | Integrated slot |
| Intel (PCIe SSD) | 3 |
| Samsung (PCIe SSD) | 3 |
| BOSS-S1 | 3 |
| Networking | |
| Mellanox (NIC: 100 Gb) | 3 |
| Mellanox (NIC: 25 Gb) | 3 |
| SolarFlare (NIC: 25 Gb) | 3 |
| Broadcom (NIC: 25 Gb) | 3 |
| Broadcom (NIC: 100 Gb) | 3 |
| Qlogic - Marvell (NIC: 25 Gb) | 3 |
| Emulex (HBA: FC 32) | 3 |
| Emulex (HBA: FC 16) | 3 |

Table 56. Riser configuration 2: R3A (continued)

| Card type | Slot priority |
|-------------------------------|----------------------|
| Qlogic (HBA: FC 32) | 3 |
| Qlogic (HBA: FC 16) | 3 |
| Qlogic (NIC: 10 Gb) | 3 |
| Qlogic - Marvell (NIC: 10 Gb) | 3 |
| Broadcom (NIC: 10 Gb) | 3 |
| Intel (NIC: 10 Gb) | 3 |
| Intel (NIC: 100 Gb) | 3 |
| Broadcom (NIC: 1 Gb) | 3 |
| Intel (NIC: 1 Gb) | 3 |
| Mellanox (NIC: HDR100 VPI) | 3 |
| Mellanox (NIC:HDR VPI) | 3 |
| Marvell (OCP: 25 Gb) | Integrated slot |
| Mellanox (OCP: 25 Gb) | Integrated slot |
| SolarFlare (OCP: 25 Gb) | Integrated slot |
| Broadcom (OCP: 25 Gb) | Integrated slot |
| Intel (OCP: 25 Gb) | Integrated slot |
| Broadcom (OCP: 10 Gb) | Integrated slot |
| Intel (OCP: 10 Gb) | Integrated slot |
| Qlogic (OCP: 10 Gb) | Integrated slot |
| Broadcom (OCP: 1 Gb) | Integrated slot |
| Intel (OCP: 1 Gb) | Integrated slot |
| GPU / Others | |
| Inventec (Serial) | 3 |

Table 57. Riser configuration 3: R1A + R4C + R4D

| Card type | Slot priority |
|-----------------------------|----------------------|
| Storage | |
| Dell External PERC Adapter | 2, 1 |
| Foxconn (fPERC) | Integrated slot |
| Inventec (fPERC) | Integrated slot |
| Dell BOSS S2 Module | Integrated slot |
| Intel (PCIe SSD) | 2, 1 |
| Samsung (PCIe SSD) | 2, 1 |
| BOSS-S1 | 2, 1 |
| Networking | |
| Mellanox (NIC: 100 Gb) | 2, 1 |
| Pensando (SmartNIC: 100 Gb) | 1 |
| Nvidia (SmartNIC: 25 Gb) | 1 |

Table 57. Riser configuration 3: R1A + R4C + R4D (continued)

| Card type | Slot priority |
|-------------------------------|----------------------|
| Mellanox (NIC: 25 Gb) | 2, 1 |
| SolarFlare (NIC: 25 Gb) | 2, 1 |
| Broadcom (NIC: 25 Gb) | 2, 1 |
| Nvidia (NIC: 25 Gb) | 2, 1 |
| Nvidia (NIC: 100 Gb) | 2, 1 |
| Broadcom (NIC: 100 Gb) | 2, 1 |
| Qlogic - Marvell (NIC: 25 Gb) | 2, 1 |
| Emulex (HBA: FC 32) | 2, 1 |
| Emulex (HBA: FC 16) | 2, 1 |
| Qlogic (HBA: FC 32) | 2, 1 |
| Qlogic (HBA: FC 16) | 2, 1 |
| Qlogic (NIC: 10 Gb) | 2, 1 |
| Qlogic - Marvell (NIC: 10 Gb) | 2, 1 |
| Broadcom (NIC: 10 Gb) | 2, 1 |
| Intel (NIC: 10 Gb) | 2, 1 |
| Intel (NIC: 25 Gb) | 2, 1 |
| Intel (NIC: 100 Gb) | 2, 1 |
| Broadcom (NIC: 1 Gb) | 2, 1 |
| Intel (NIC: 1 Gb) | 2, 1 |
| Mellanox (NIC: HDR100 VPI) | 2, 1 |
| Mellanox (NIC:HDR VPI) | 2, 1 |
| Marvell (OCP: 25 Gb) | Integrated slot |
| Mellanox (OCP: 25 Gb) | Integrated slot |
| SolarFlare (OCP: 25 Gb) | Integrated slot |
| Broadcom (OCP: 25 Gb) | Integrated slot |
| Intel (OCP: 25 Gb) | Integrated slot |
| Broadcom (OCP: 10 Gb) | Integrated slot |
| Intel (OCP: 10 Gb) | Integrated slot |
| Qlogic (OCP: 10 Gb) | Integrated slot |
| Broadcom (OCP: 1 Gb) | Integrated slot |
| Intel (OCP: 1 Gb) | Integrated slot |
| GPU/Others | |
| Nvidia (T4 GPU) | 2, 1 |
| Intel (GPU) | 2, 1 |
| Inventec (DPU) | Integrated slot |

Table 58. Riser configuration 4: R2A + R3A + R1D Paddle card

| Card type | Slot priority |
|-------------------------------|-----------------|
| Storage | |
| Dell External PERC Adapter | 2, 1, 3 |
| Foxconn (fPERC) | Integrated slot |
| Inventec (fPERC) | Integrated slot |
| Dell BOSS S2 Module | Integrated slot |
| Intel (PCIe SSD) | 2, 1, 3 |
| Samsung (PCIe SSD) | 2, 1, 3 |
| Networking | |
| Mellanox (NIC: 100 Gb) | 2, 1, 3 |
| Mellanox (NIC: 25 Gb) | 2, 1, 3 |
| SolarFlare (NIC: 25 Gb) | 2, 1, 3 |
| Broadcom (NIC: 25 Gb) | 2, 1, 3 |
| Broadcom (NIC: 100 Gb) | 2, 1, 3 |
| Qlogic - Marvell (NIC: 25 Gb) | 2, 1, 3 |
| Emulex (HBA: FC 32) | 2, 1, 3 |
| Emulex (HBA: FC 16) | 2, 1, 3 |
| Qlogic (HBA: FC 32) | 2, 1, 3 |
| Qlogic (HBA: FC 16) | 2, 1, 3 |
| Qlogic (NIC: 10 Gb) | 2, 1, 3 |
| Qlogic - Marvell (NIC: 10 Gb) | 2, 1, 3 |
| Broadcom (NIC: 10 Gb) | 2, 1, 3 |
| Intel (NIC: 10 Gb) | 2, 1, 3 |
| Intel (NIC: 100 Gb) | 2, 1, 3 |
| Broadcom (NIC: 1 Gb) | 2, 1, 3 |
| Intel (NIC: 1 Gb) | 2, 1, 3 |
| Mellanox (NIC: HDR100 VPI) | 2, 1, 3 |
| Mellanox (NIC:HDR VPI) | 2, 1, 3 |
| Marvell (OCP: 25 Gb) | Integrated slot |
| Mellanox (OCP: 25 Gb) | Integrated slot |
| SolarFlare (OCP: 25 Gb) | Integrated slot |
| Broadcom (OCP: 25 Gb) | Integrated slot |
| Intel (OCP: 25 Gb) | Integrated slot |
| Broadcom (OCP: 10 Gb) | Integrated slot |
| Intel (OCP: 10 Gb) | Integrated slot |
| Qlogic (OCP: 10 Gb) | Integrated slot |
| Broadcom (OCP: 1 Gb) | Integrated slot |
| Intel (OCP: 1 Gb) | Integrated slot |

Table 58. Riser configuration 4: R2A + R3A + R1D Paddle card (continued)

| Card type | Slot priority |
|---------------------|---------------|
| GPU / Others | |
| Nvidia (T4 GPU) | 2, 1, 3 |
| Intel (GPU) | 2, 1, 3 |
| Inventec (VGA) | 3 |
| Inventec (Serial) | 3 |

Table 59. Riser configuration 5: R2B + R3A + R1D Paddle card

| Card type | Slot priority |
|-------------------------------|-----------------|
| Storage | |
| Dell External PERC Adapter | 2, 3 |
| Foxconn (fPERC) | Integrated slot |
| Inventec (fPERC) | Integrated slot |
| Dell BOSS S2 Module | Integrated slot |
| Intel (PCIe SSD) | 2, 3 |
| Samsung (PCIe SSD) | 2, 3 |
| BOSS-S1 | 2, 3 |
| Networking | |
| Mellanox (NIC: 100 Gb) | 3 |
| Mellanox (NIC: 25 Gb) | 3 |
| SolarFlare (NIC: 25 Gb) | 2, 3 |
| Broadcom (NIC: 25 Gb) | 2, 3 |
| Broadcom (NIC: 100 Gb) | 3 |
| Qlogic - Marvell (NIC: 25 Gb) | 2, 3 |
| Emulex (HBA: FC 32) | 2, 3 |
| Emulex (HBA: FC 16) | 2, 3 |
| Qlogic (HBA: FC 32) | 2, 3 |
| Qlogic (HBA: FC 16) | 2, 3 |
| Qlogic (NIC: 10 Gb) | 2, 3 |
| Qlogic - Marvell (NIC: 10 Gb) | 2, 3 |
| Broadcom (NIC: 10 Gb) | 2, 3 |
| Broadcom (NIC: 10 Gb) | 3 |
| Intel (NIC: 10 Gb) | 2, 3 |
| Intel (NIC: 100 Gb) | 3 |
| Broadcom (NIC: 1 Gb) | 2, 3 |
| Intel (NIC: 1 Gb) | 2, 3 |
| Mellanox (NIC: HDR100 VPI) | 1 |
| Mellanox (NIC:HDR VPI) | 1 |
| Marvell (OCP: 25 Gb) | Integrated slot |

Table 59. Riser configuration 5: R2B + R3A + R1D Paddle card (continued)

| Card type | Slot priority |
|-------------------------|-----------------|
| Mellanox (OCP: 25 Gb) | Integrated slot |
| SolarFlare (OCP: 25 Gb) | Integrated slot |
| Broadcom (OCP: 25 Gb) | Integrated slot |
| Intel (OCP: 25 Gb) | Integrated slot |
| Broadcom (OCP: 10 Gb) | Integrated slot |
| Intel (OCP: 10 Gb) | Integrated slot |
| Qlogic (OCP: 10 Gb) | Integrated slot |
| Broadcom (OCP: 1 Gb) | Integrated slot |
| Intel (OCP: 1 Gb) | Integrated slot |
| GPU / Others | |
| Inventec (VGA) | 3 |
| Inventec (Serial) | 3 |

Table 60. Riser configuration 6: R3A + R1D Paddle card

| Card type | Slot priority |
|-------------------------------|-----------------|
| Storage | |
| Dell External PERC Adapter | 3 |
| Dell BOSS S2 Module | Integrated slot |
| Intel (PCIe SSD) | 3 |
| Samsung (PCIe SSD) | 3 |
| BOSS-S1 | 3 |
| Networking | |
| Mellanox (NIC: 100 Gb) | 3 |
| Mellanox (NIC: 25 Gb) | 3 |
| SolarFlare (NIC: 25 Gb) | 3 |
| Broadcom (NIC: 25 Gb) | 3 |
| Broadcom (NIC: 100 Gb) | 3 |
| Qlogic - Marvell (NIC: 25 Gb) | 3 |
| Emulex (HBA: FC 32) | 3 |
| Emulex (HBA: FC 16) | 3 |
| Qlogic (HBA: FC 32) | 3 |
| Qlogic (HBA: FC 16) | 3 |
| Qlogic (NIC: 10 Gb) | 3 |
| Qlogic - Marvell (NIC: 10 Gb) | 3 |
| Broadcom (NIC: 10 Gb) | 3 |
| Intel (NIC: 10 Gb) | 3 |
| Intel (NIC: 100 Gb) | 3 |
| Broadcom (NIC: 1 Gb) | 3 |

Table 60. Riser configuration 6: R3A + R1D Paddle card (continued)

| Card type | Slot priority |
|----------------------------|----------------------|
| Intel (NIC: 1 Gb) | 3 |
| Mellanox (NIC: HDR100 VPI) | 3 |
| Mellanox (NIC:HDR VPI) | 3 |
| Marvell (OCP: 25 Gb) | Integrated slot |
| Mellanox (OCP: 25 Gb) | Integrated slot |
| SolarFlare (OCP: 25 Gb) | Integrated slot |
| Broadcom (OCP: 25 Gb) | Integrated slot |
| Intel (OCP: 25 Gb) | Integrated slot |
| Broadcom (OCP: 10 Gb) | Integrated slot |
| Intel (OCP: 10 Gb) | Integrated slot |
| Qlogic (OCP: 10 Gb) | Integrated slot |
| Broadcom (OCP: 1 Gb) | Integrated slot |
| Intel (OCP: 1 Gb) | Integrated slot |
| GPU / Others | |
| Inventec (Serial) | 3 |

 **NOTE:** The system supports either BOSS-S1 or BOSS-S2. It cannot support both the cards together.

Removing the expansion card risers

Prerequisites

1. Follow the safety guidelines listed in the [Safety instructions](#).
2. Follow the procedure listed in the [Before working inside your system](#).
3. Disconnect any cables that are connected to the expansion card.

Steps

1. For Riser 1, press the blue tab and holding the edges lift the expansion card riser from the riser connector on the system board.

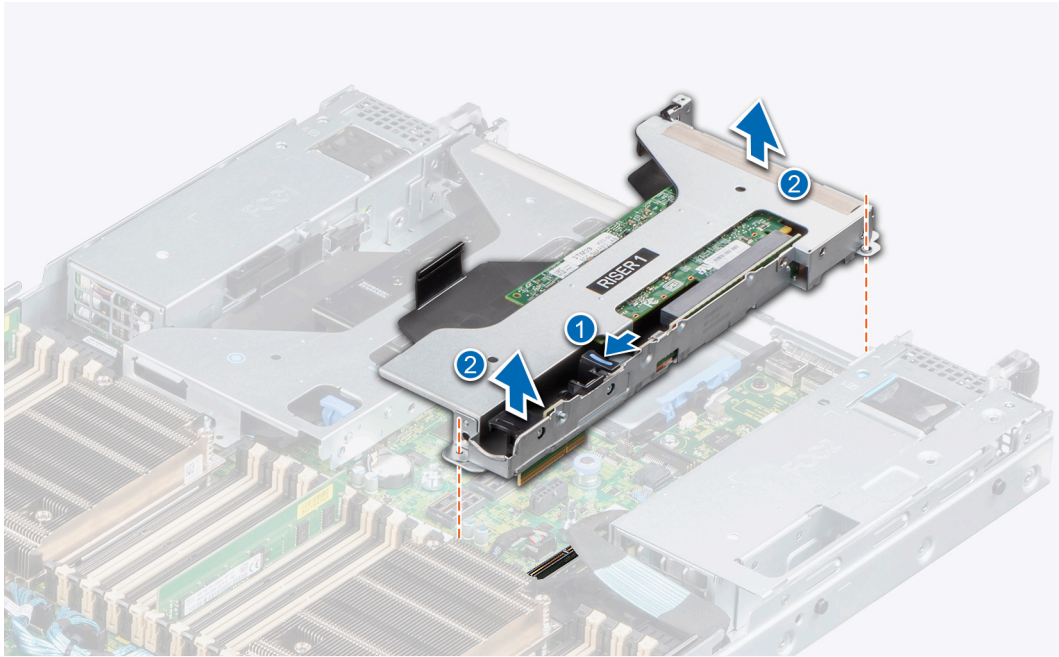

Figure 84. Removing the expansion card riser (Riser 1)

2. For Riser 2 and liquid cooling Riser 2, press the blue button on the riser, and holding the touch points lift the expansion card riser from the riser connector on the system board.

NOTE: The numbers on the image do not depict the exact steps. The numbers are for representation of sequence.

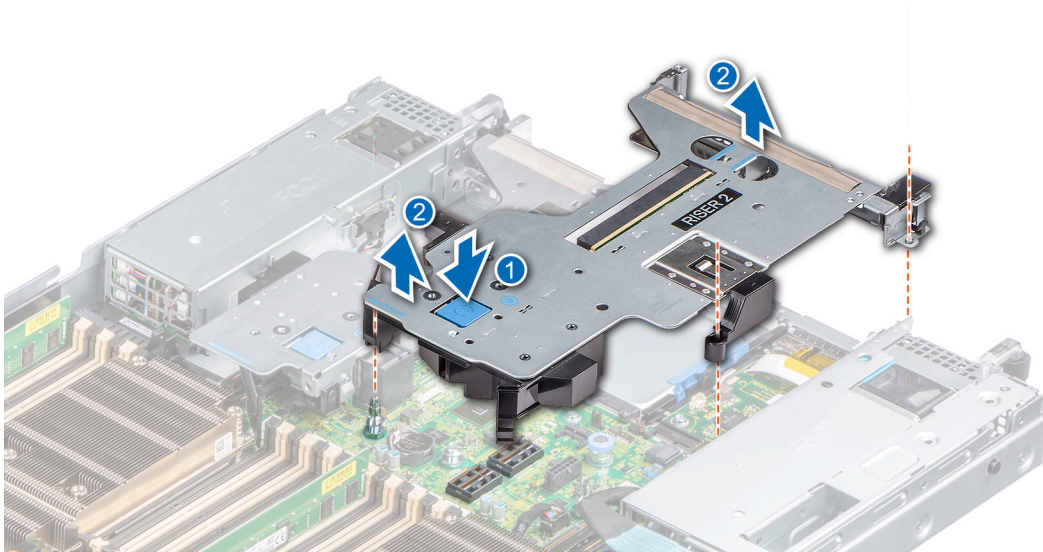

Figure 85. Removing the expansion card riser (Riser 2)

3. For Riser 3 and liquid cooling Riser 3, press the blue button on the riser, and lift the expansion card riser from the riser connector on the system board.

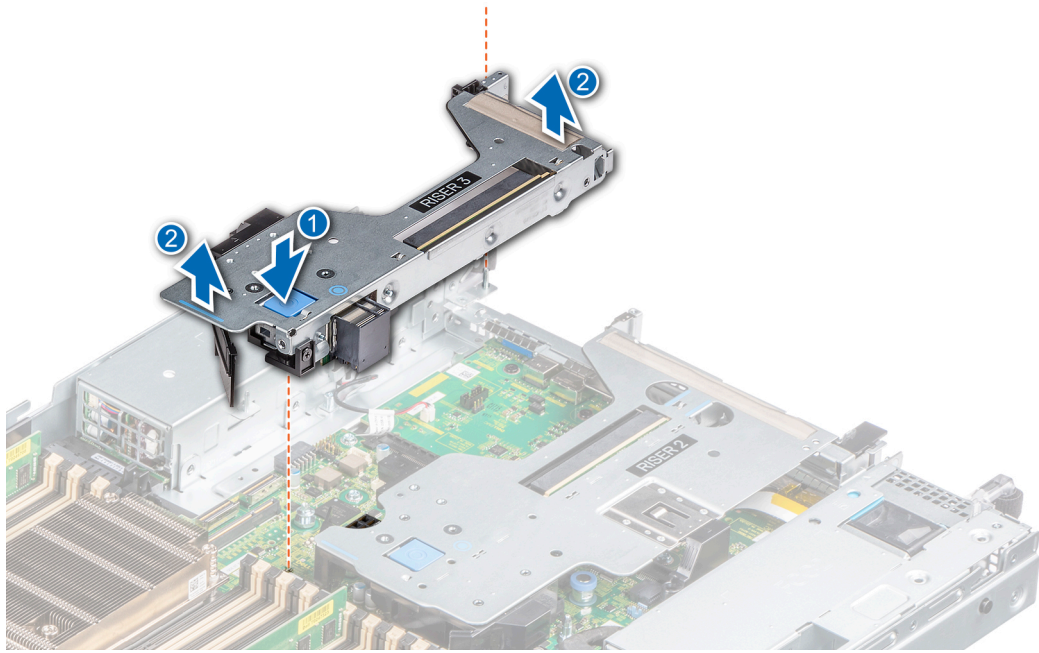

Figure 86. Removing the expansion card riser (Riser 3)

4. For Riser 4, press the blue tab on the riser, and holding the touch point lift the expansion card riser from the riser connector on the system board.

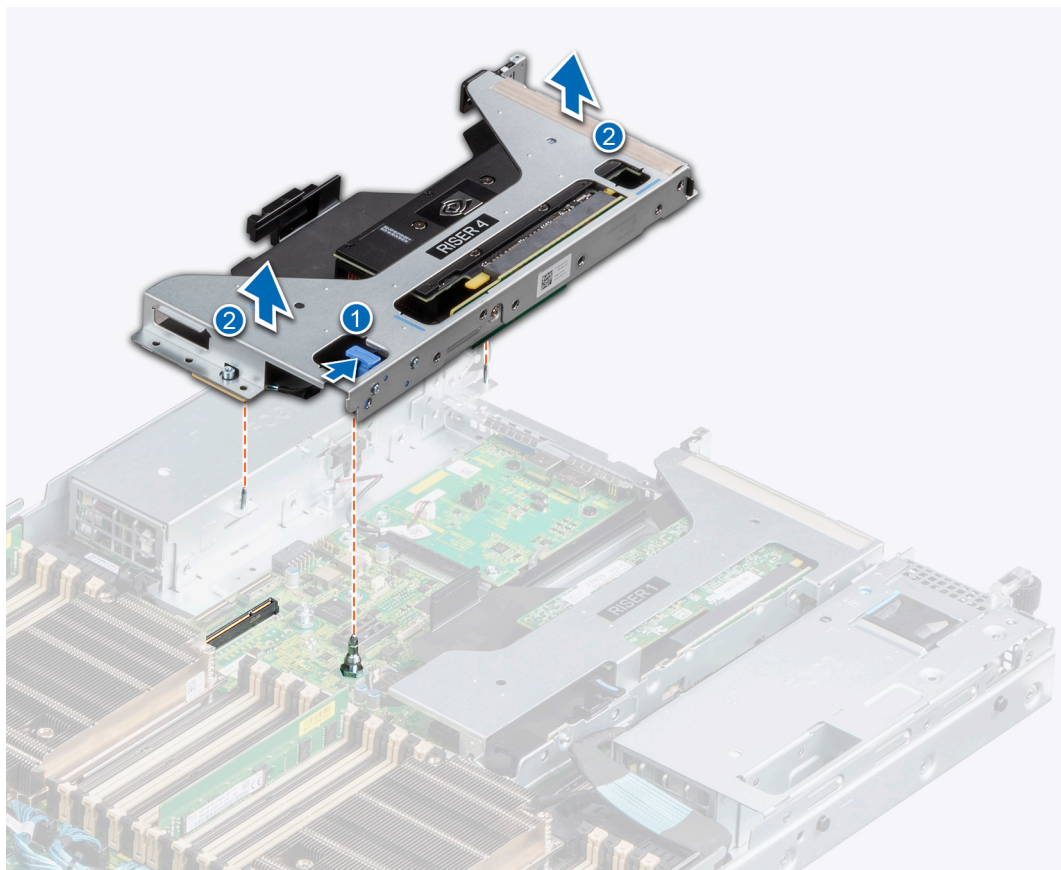

Figure 87. Removing the expansion card riser (Riser 4)

Next steps

1. [Replace the expansion card riser.](#)

Installing the expansion card risers

Prerequisites

1. Follow the safety guidelines listed in the [Safety instructions](#).
2. Follow the procedure listed in [Before working inside your system](#).
3. If removed, [install the expansion cards into the expansion card risers](#).

Steps

1. Holding the edges or the touch points, align the holes on the expansion card riser with the guides on the system board.
2. Lower the expansion card riser into place and press the touch points until the expansion card riser connector is fully seated on the system board connector.

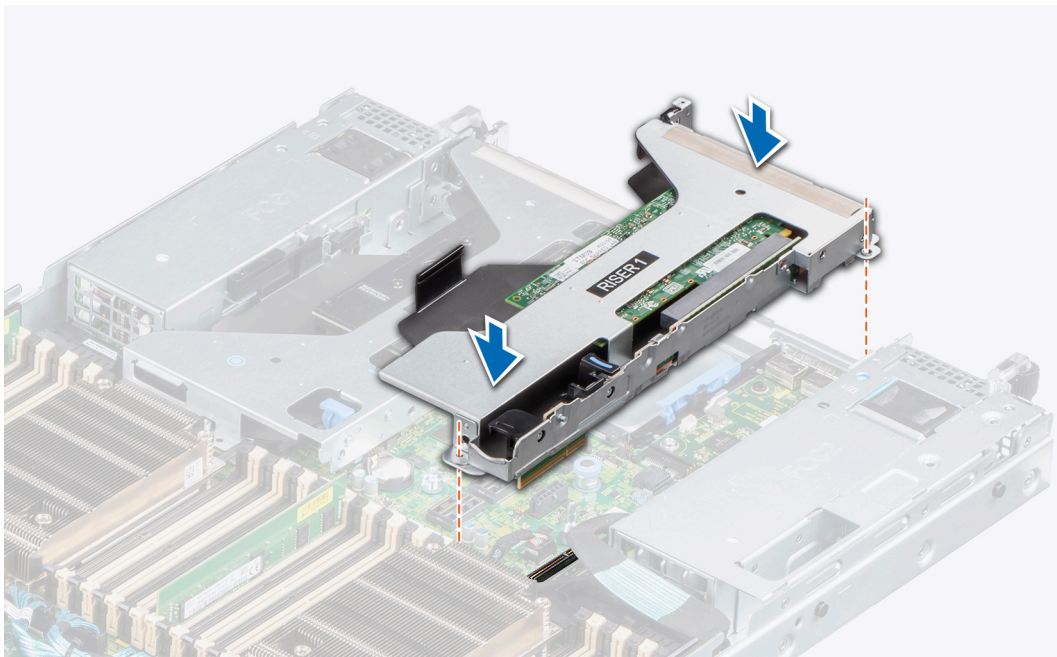

Figure 88. Installing the expansion card riser (Riser 1)

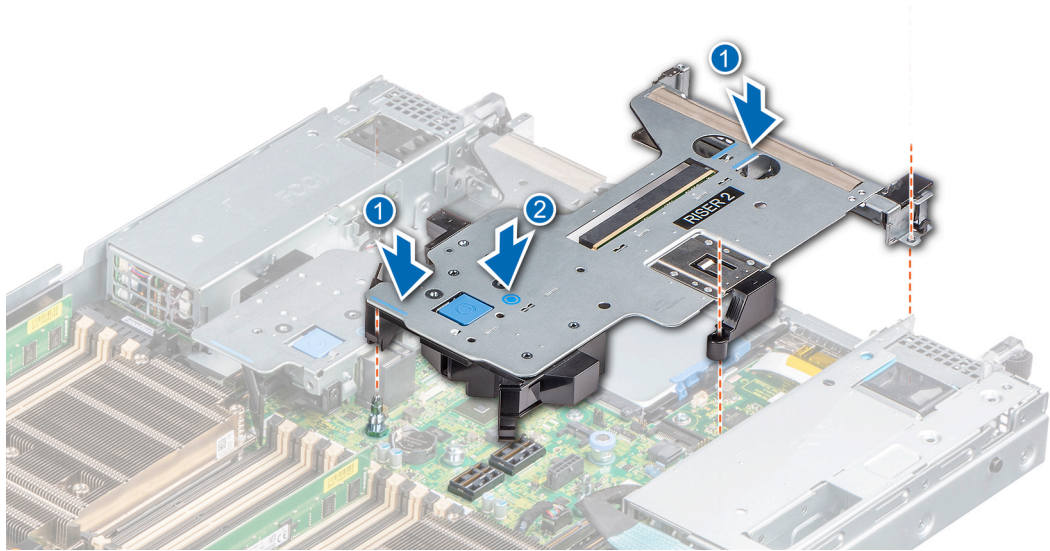

Figure 89. Installing the expansion card riser (Riser 2)

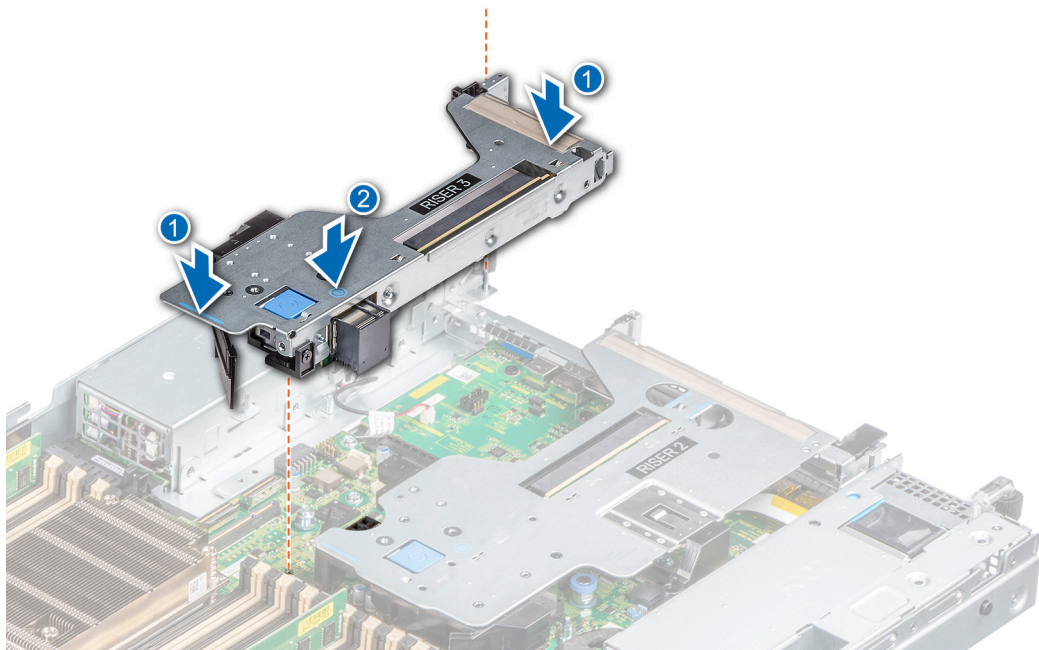

Figure 90. Installing the expansion card riser (Riser 3)

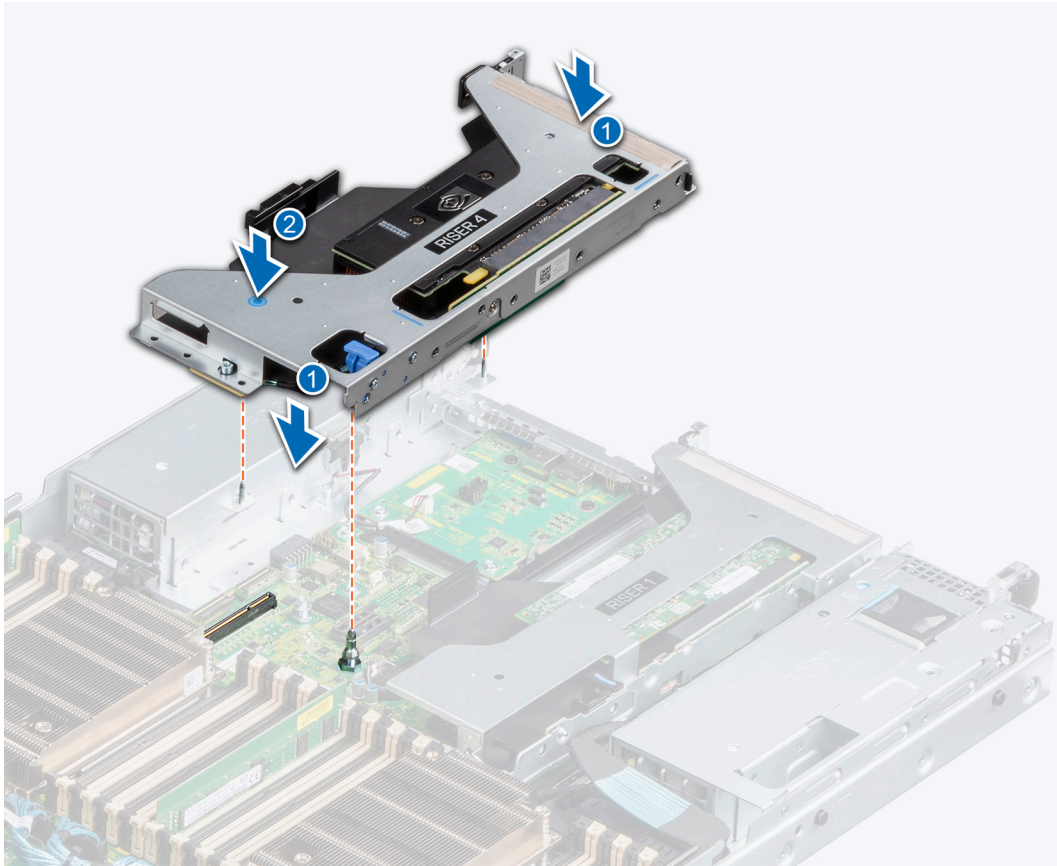

Figure 91. Installing the expansion card riser (Riser 4)

Next steps

1. If required, re-connect the cables to the expansion card.
2. Follow the procedure listed in [After working inside your system](#).
3. Install any device drivers required for the card as described in the documentation for the card.

Removing expansion card from the expansion card riser

Prerequisites

1. Follow the safety guidelines listed in the [Safety instructions](#).
2. Follow the procedure listed in the [Before working inside your system](#).
3. If applicable, disconnect the cables from the expansion card.

Steps

1. Pull and lift the expansion card retention latch lock to open.
NOTE: Pull the card holder before removing the card from the riser.
2. Hold the expansion card by the edges and pull the card until the card edge connector disengages from the expansion card connector on the riser.
NOTE: The numbers on the image do not depict the exact steps. The numbers are for representation of sequence.

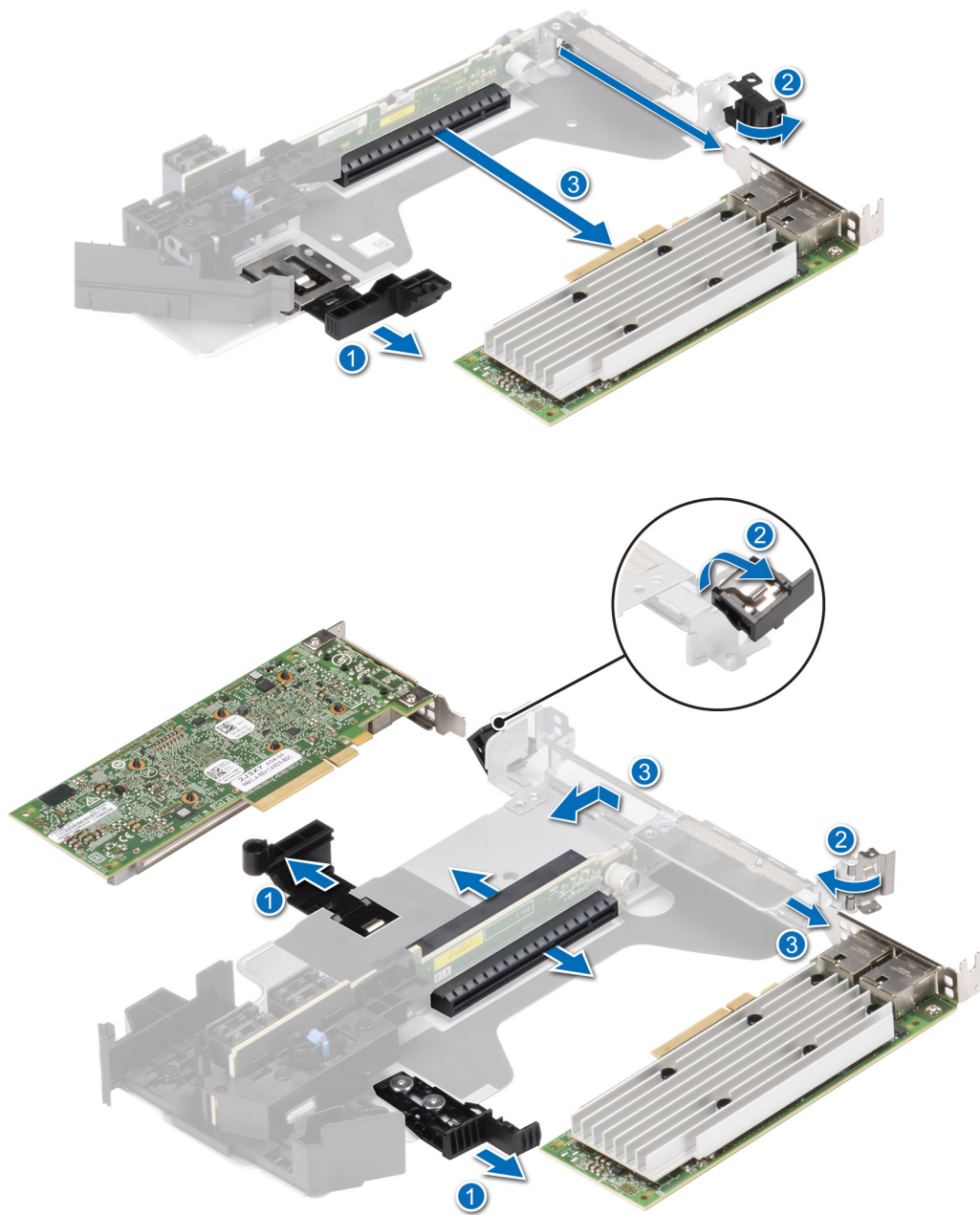

Figure 92. Removing expansion card from the expansion card riser

3. If the expansion card is not going to be replaced, install a filler bracket and close the card retention latch.

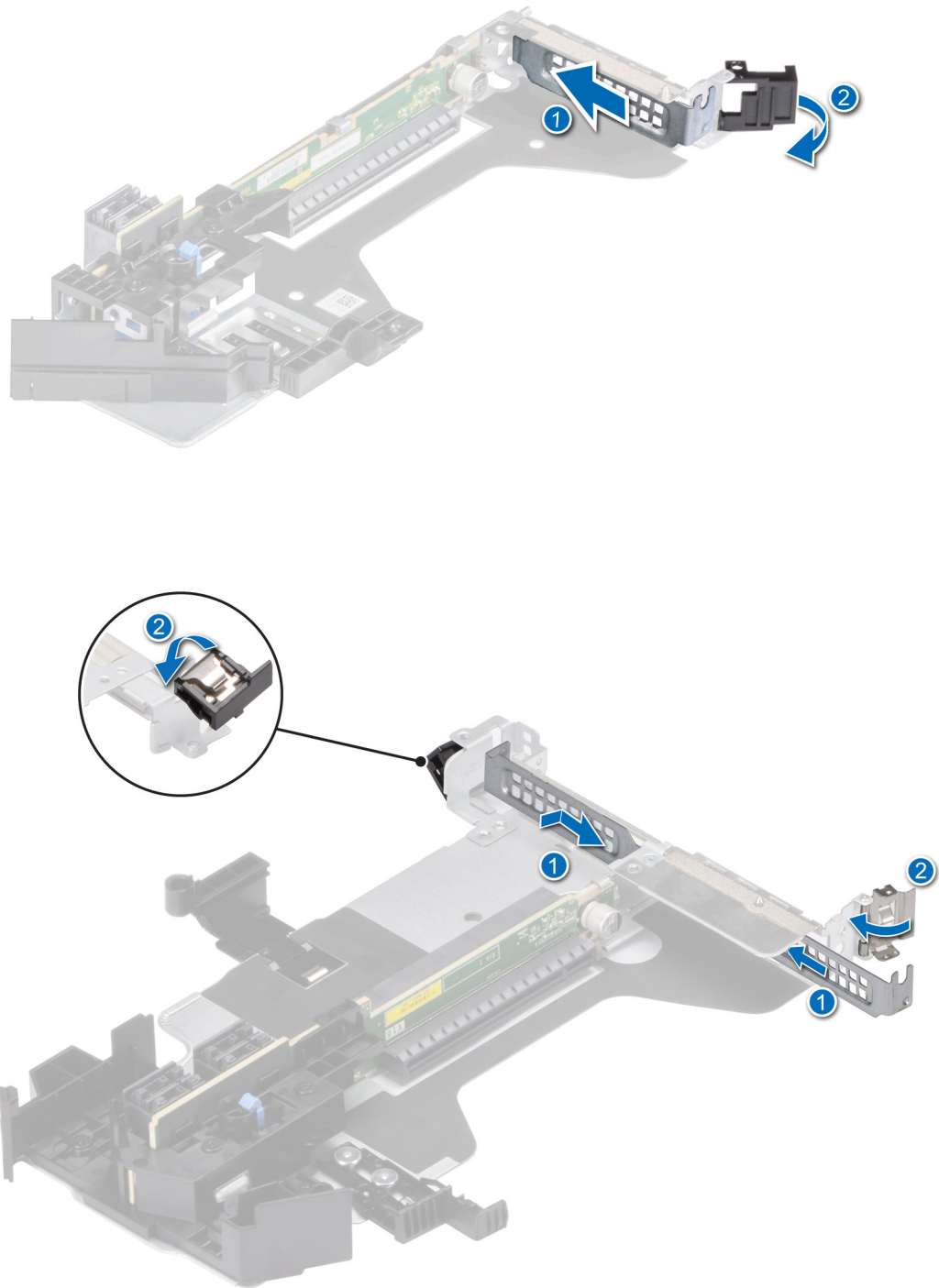

Figure 93. Installing the filler bracket

Next steps

1. Replace an expansion card into the expansion card riser.

Installing an expansion card into the expansion card riser

Prerequisites

1. Follow the safety guidelines listed in the [Safety instructions](#).
2. Follow the procedure listed in [Before working inside your system](#).
3. If installing a new expansion card, unpack it and prepare the card for installation.

i **NOTE:** For instructions, see the documentation accompanying the card.

⚠ CAUTION: Do not install GPUs, network cards, or other PCIe devices on your system that are not validated and tested by Dell. Damage caused by unauthorized and invalidated hardware installation will null and void the system warranty.

Steps

1. Pull and lift up the expansion card retention latch lock to open.
2. If installed, remove the filler bracket.

i **NOTE:** Store the filler bracket for future use. Filler brackets must be installed in empty expansion card slots to maintain Federal Communications Commission (FCC) certification of the system. The brackets also keep dust and dirt out of the system and aid in proper cooling and airflow inside the system.

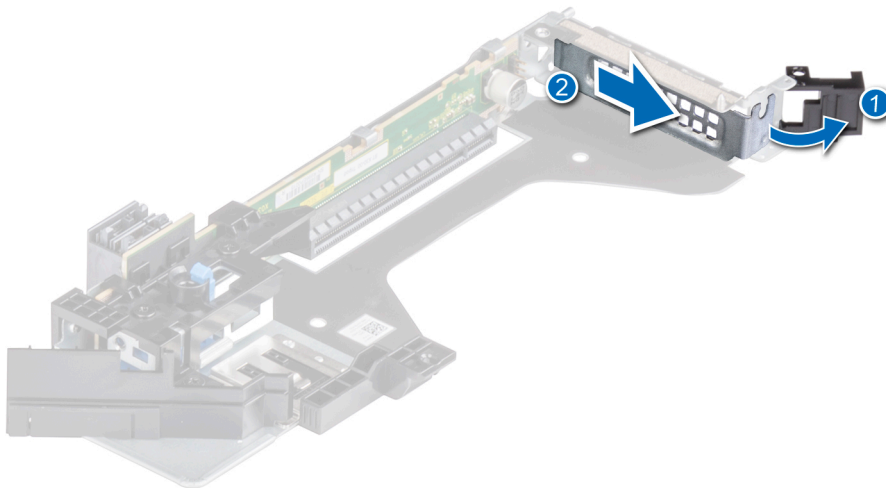

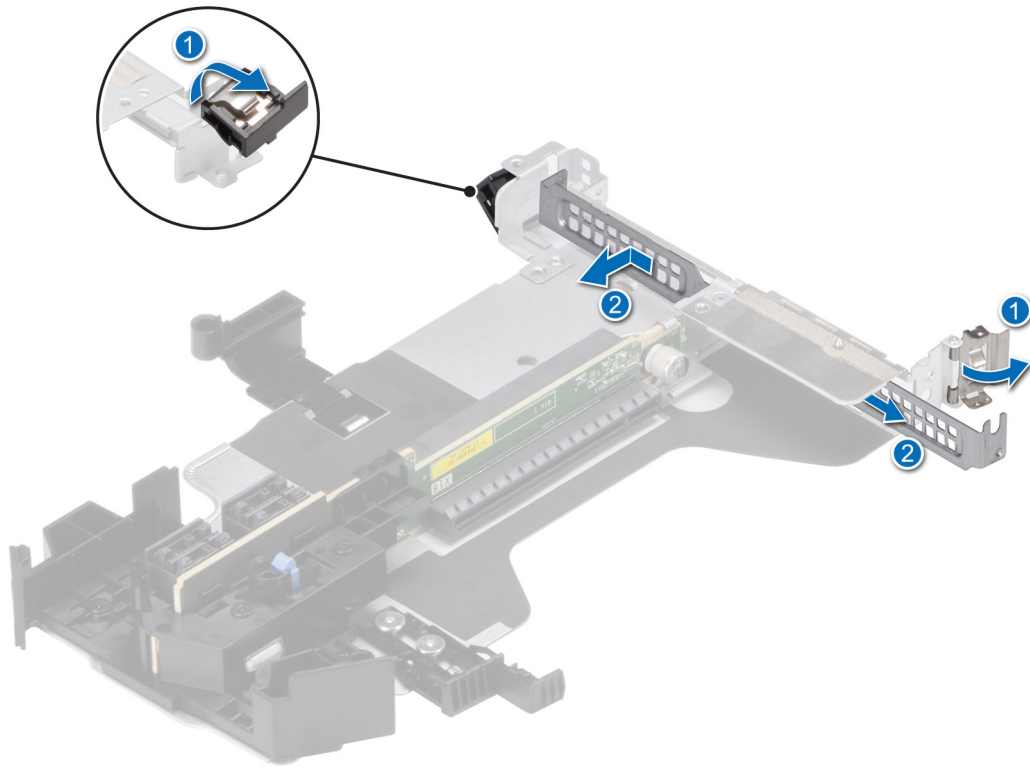
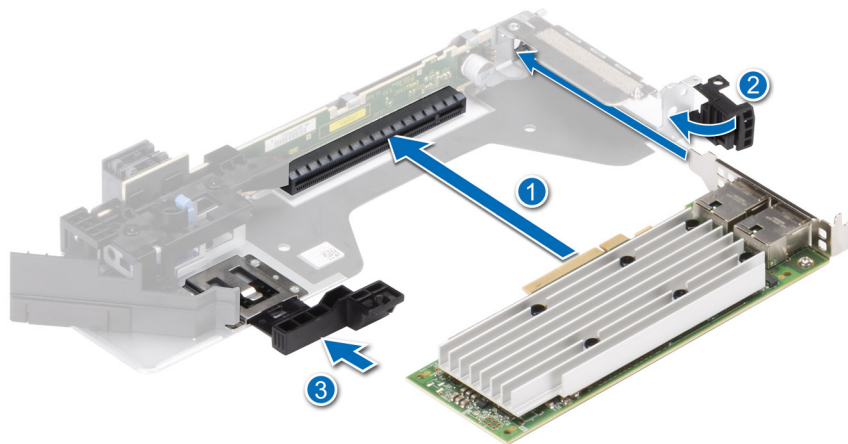

Figure 94. Removing the filler bracket

3. Hold the card by its edges, and align the card edge connector with the expansion card connector on the riser.
4. Insert the card edge connector firmly into the expansion card connector until the card is fully seated.
5. Close the expansion card retention latch.



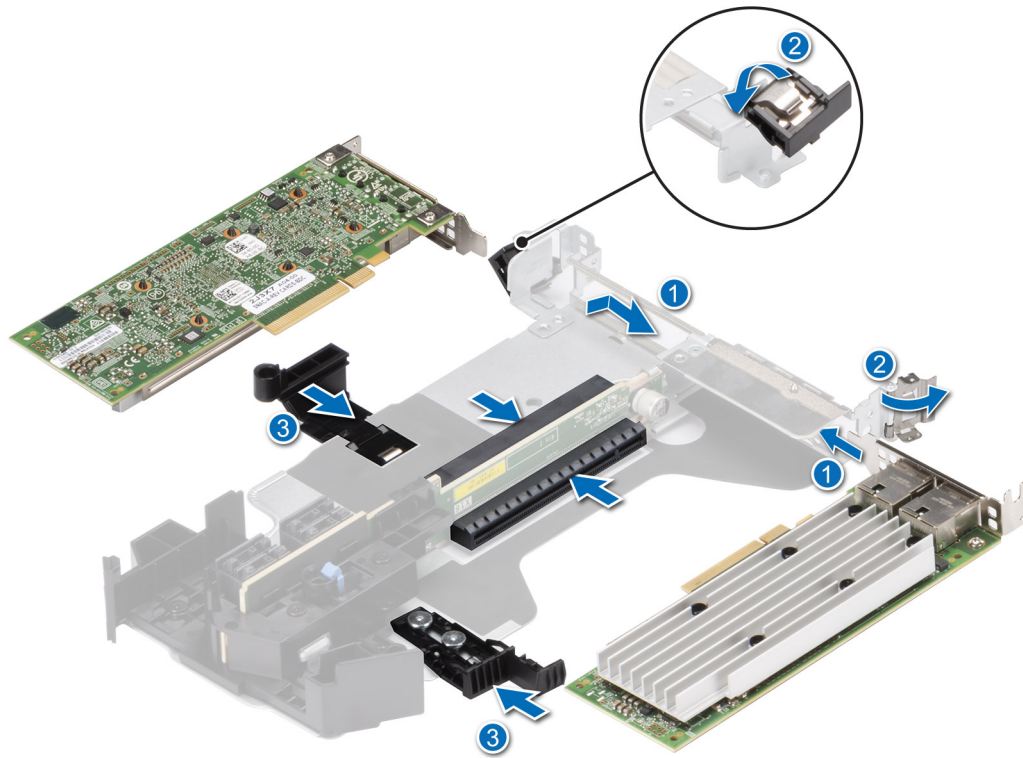

Figure 95. Installing expansion card into the expansion card riser

NOTE: Push the card holder to hold the full length card in the riser.

Next steps

1. If applicable, connect the cables to the expansion card.
2. Follow the procedure listed in [After working inside your system](#).
3. Install any device drivers required for the card as described in the documentation for the card.

Removing the R1 paddle cards

Prerequisites

1. Follow the safety guidelines listed in the [Safety instructions](#).
2. Follow the procedure listed in [Before working inside your system](#).
3. If installed, [remove the air shroud](#).
4. Remove the paddle card cable from side wall bracket.
5. Disconnect the paddle card cables from the drive backplane.

Steps

Press the blue release tab on the paddle cards and holding the edges lift the paddle cards from the riser connector on the system board.

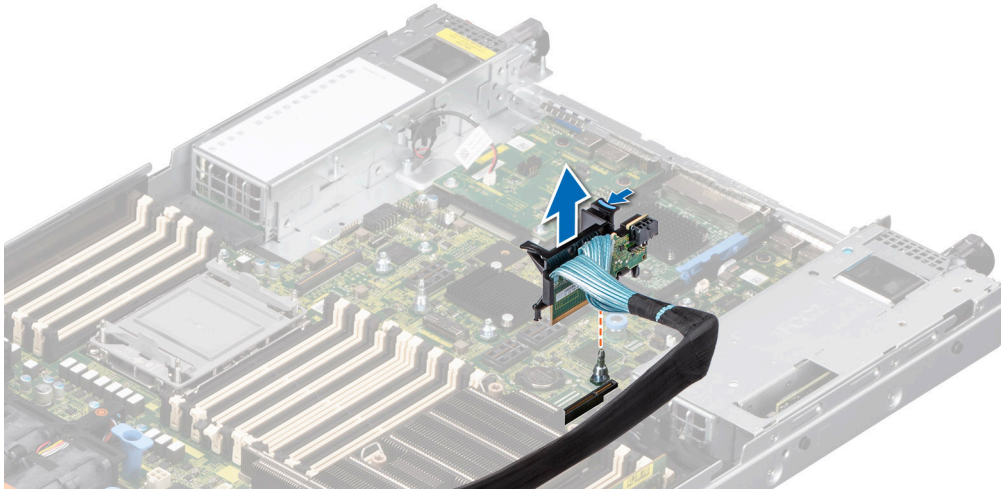

Figure 96. Removing the R1 paddle card

Next steps

1. [Replace the paddle cards.](#)

Installing R1 paddle card

Prerequisites

1. Follow the safety guidelines listed in the [Safety instructions](#).
2. Follow the procedure listed in [Before working inside your system](#).
3. If installed, [remove the air shroud](#).
4. Remove the paddle card cable from side wall bracket.
5. Disconnect the paddle card cables from the drive backplane.

Steps

1. Holding the edges, align the hole on the paddle cards with the guides on the system board.
2. Lower the paddle cards into place and press until the paddle card connector is fully seated on the system board connector.

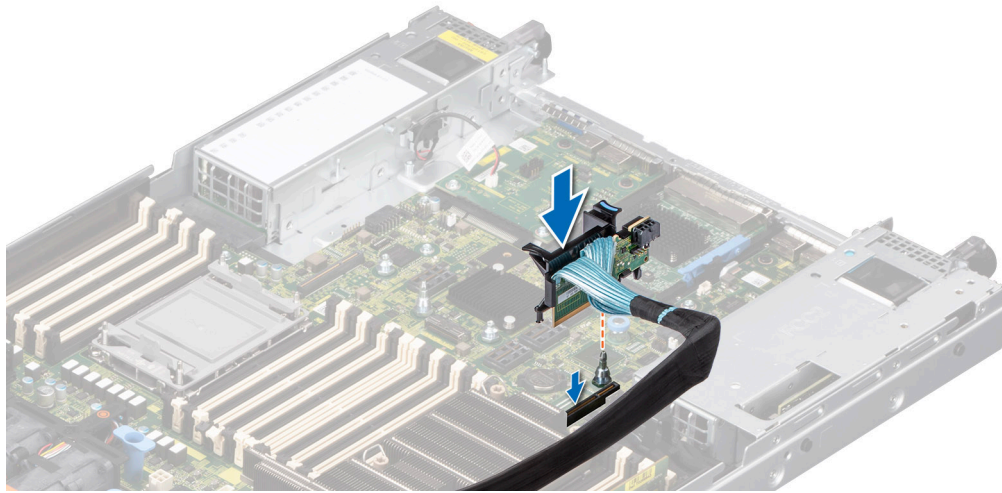

Figure 97. Installing the R1 paddle card

Next steps

1. Connect the paddle card cables to the drive backplane
2. Insert the paddle card cable into the side wall bracket.
3. [If removed, install the air shroud.](#)
4. Follow the procedure listed in [After working inside your system.](#)

Intrusion switch module

This is a service technician replaceable part only.

Removing the intrusion switch module

Prerequisites

1. Follow the safety guidelines listed in the [Safety instructions.](#)
2. Follow the procedure listed in [Before working inside your system.](#)
3. [Remove the expansion card riser.](#)

NOTE: Ensure that you note the routing of the cables as you remove them from the system board. Route the cable properly when you replace it to prevent the cable from being pinched or crimped.

Steps

1. Disconnect the intrusion switch cable from the connector on the rear I/O board.
2. Using a Phillips #2 screwdriver, loosen the screw on the intrusion switch module.
3. Slide the intrusion switch module out of the slot on the system.

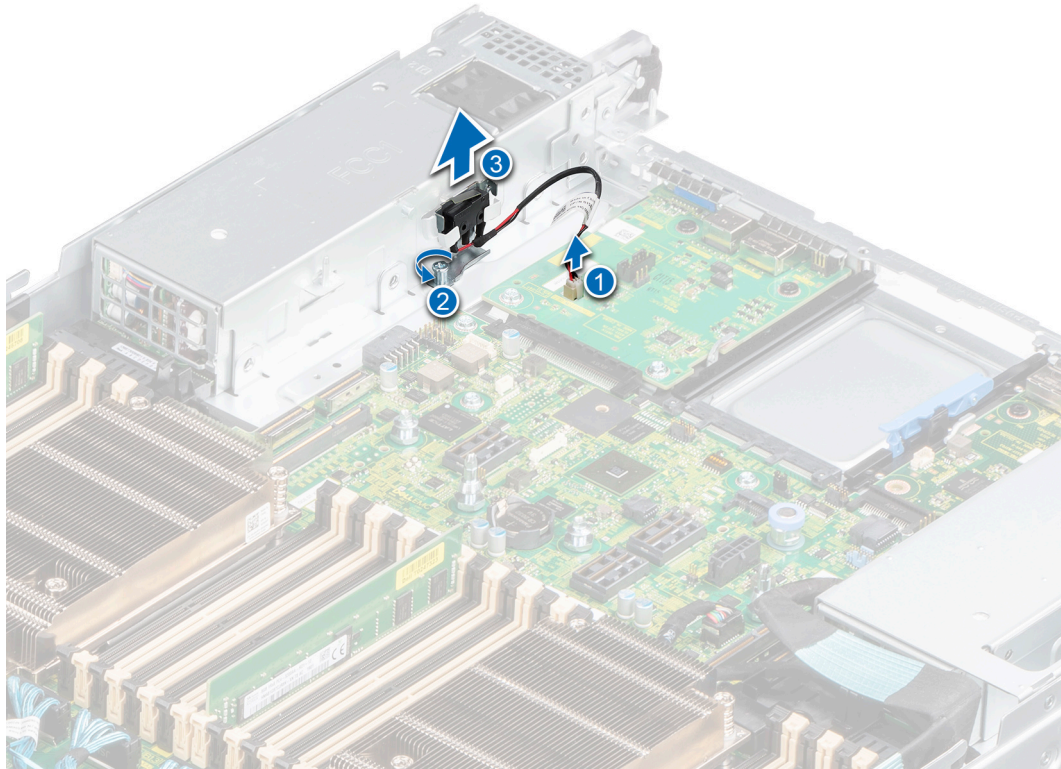

Figure 98. Removing the intrusion switch module

Next steps

1. [Replace the intrusion switch module.](#)

Installing the intrusion switch module

Prerequisites

1. Follow the safety guidelines listed in the [Safety instructions](#).
2. Follow the procedure listed in [Before working inside your system](#).
3. [Remove the expansion card riser.](#)

i **NOTE:** Ensure that you note the routing of the cables as you remove them from the system board. Route the cable properly when you replace it to prevent the cable from being pinched or crimped.

Steps

1. Align the guides on the intrusion switch module with the standoffs on the system.
2. Slide the intrusion switch module into the slot in the system until firmly seated.
3. Using a Phillips #2 screwdriver, tighten the screw on the intrusion switch module.
4. Connect the intrusion switch cable to the connector on the rear I/O board.

i **NOTE:** The numbers on the image do not depict the exact steps. The numbers are for representation of sequence.

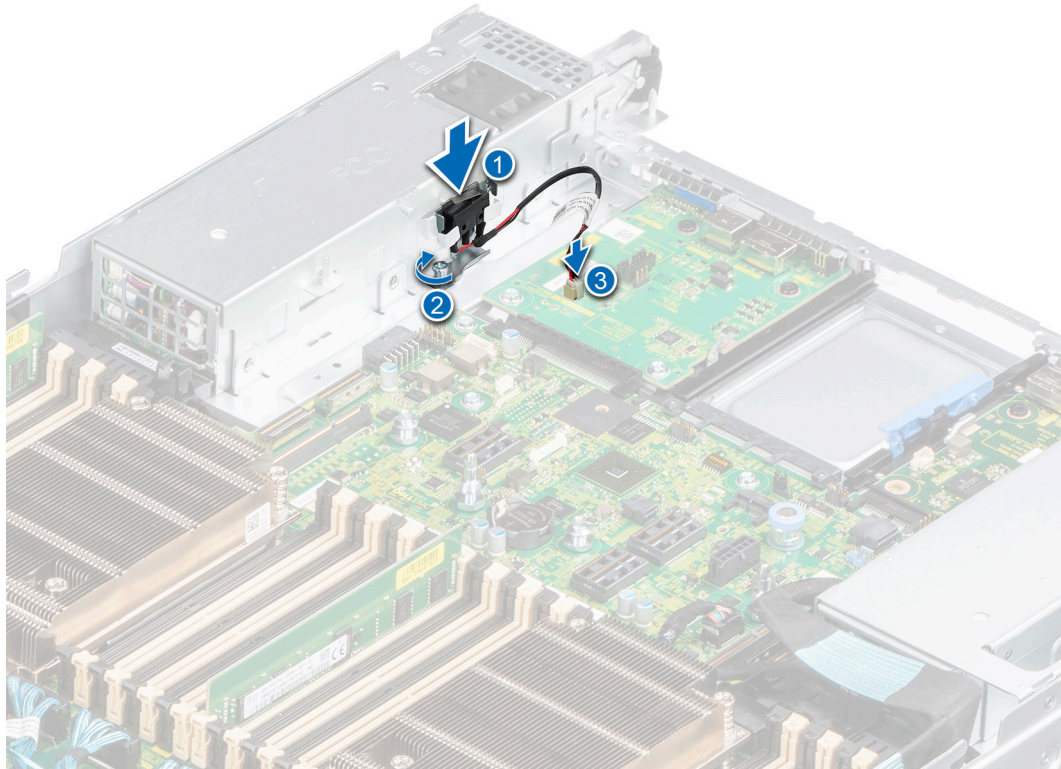

Figure 99. Installing the intrusion switch module

Next steps

1. [Install the expansion card riser.](#)
2. Follow the procedure listed in [After working inside your system.](#)

M.2 SSD module on BOSS-S1 adapter card

Removing the M.2 SSD module

Prerequisites

1. Follow the safety guidelines listed in the [Safety instructions.](#)
2. Follow the procedure listed in the [Before working inside your system.](#)
3. Remove the BOSS card. The BOSS card removal is similar to [removing expansion card from the expansion card riser.](#)

Steps

1. Using the Phillips #1 screwdriver, remove the screws securing the M.2 SSD module to the BOSS card.
2. Pull the M.2 SSD module to disconnect from the BOSS card connector.

i **NOTE:** The numbers on the image do not depict the exact steps. The numbers are for representation of sequence.

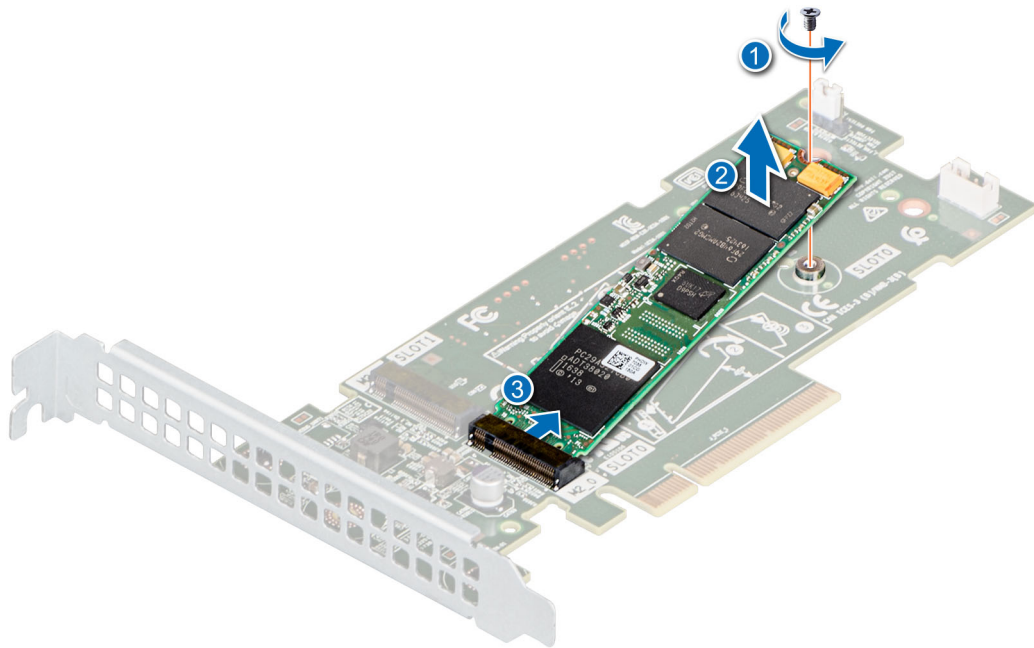

Figure 100. Removing the M.2 SSD module

Next steps

1. [Replace the M.2 SSD module.](#)

Installing the M.2 SSD module

Prerequisites

1. Follow the safety guidelines listed in the [Safety instructions](#).
2. Follow the procedure listed in the [Before working inside your system](#).
3. Remove the BOSS card. Removing BOSS card is similar to [removing expansion card from the expansion card riser](#).

Steps

1. Align the M.2 SSD module at an angle with the BOSS card connector.
2. Insert the M.2 SSD module until it is firmly seated in the BOSS card connector.
3. Using the Phillips #1 screwdriver, secure the M.2 SSD module on the BOSS card with the screw.

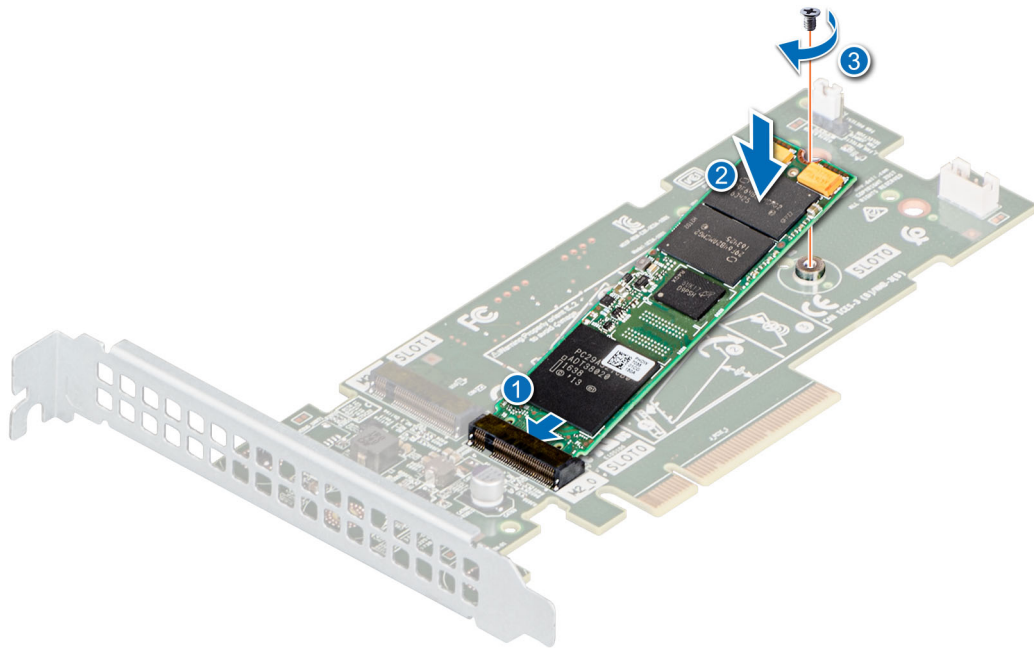

Figure 101. Installing the M.2 SSD module

Next steps

1. Install the BOSS card. Installing the BOSS is similar to [installing expansion card into the expansion card riser](#).
2. Follow the procedure listed in the [After working inside your system](#).

Optional BOSS S2 module

Removing the BOSS S2 filler

Prerequisites

Follow the safety guidelines listed in the [Safety instructions](#).

Steps

Press and pull the BOSS S2 filler out from the BOSS S2 module bay.

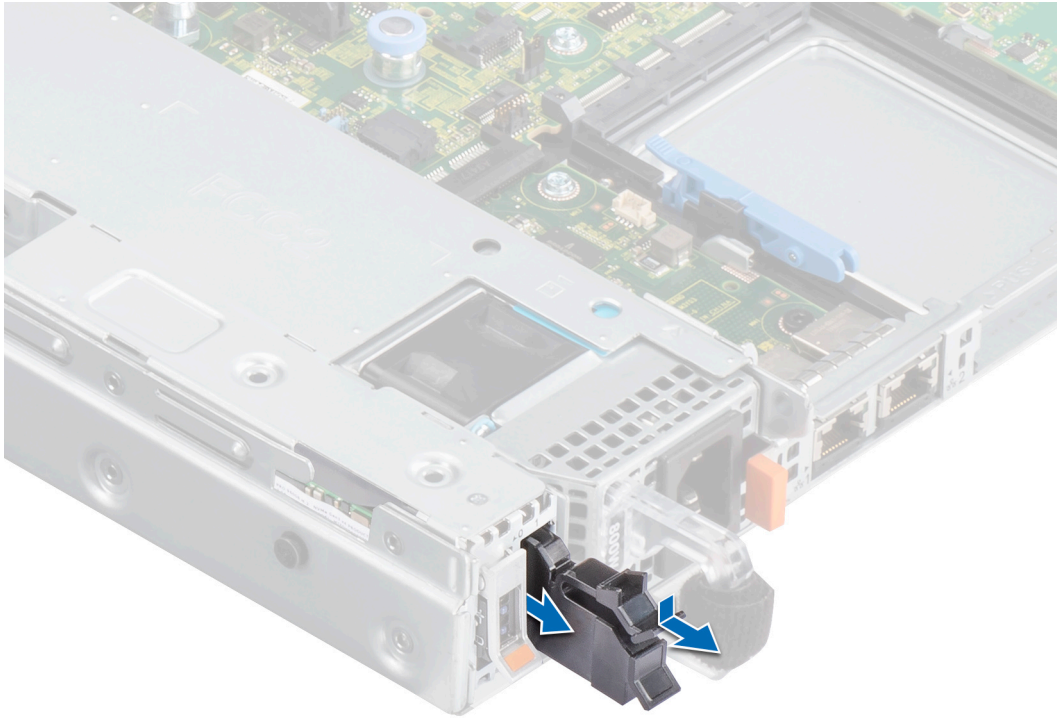

Figure 102. Removing the BOSS S2 filler

Next steps

1. [Install the BOSS S2 module](#) or [replace the BOSS S2 filler](#).

Installing the BOSS S2 filler

Prerequisites

1. Follow the safety guidelines listed in the [Safety instructions](#).

Steps

Align the BOSS S2 card filler with the BOSS S2 module bay and push it into the bay until it clicks into place.

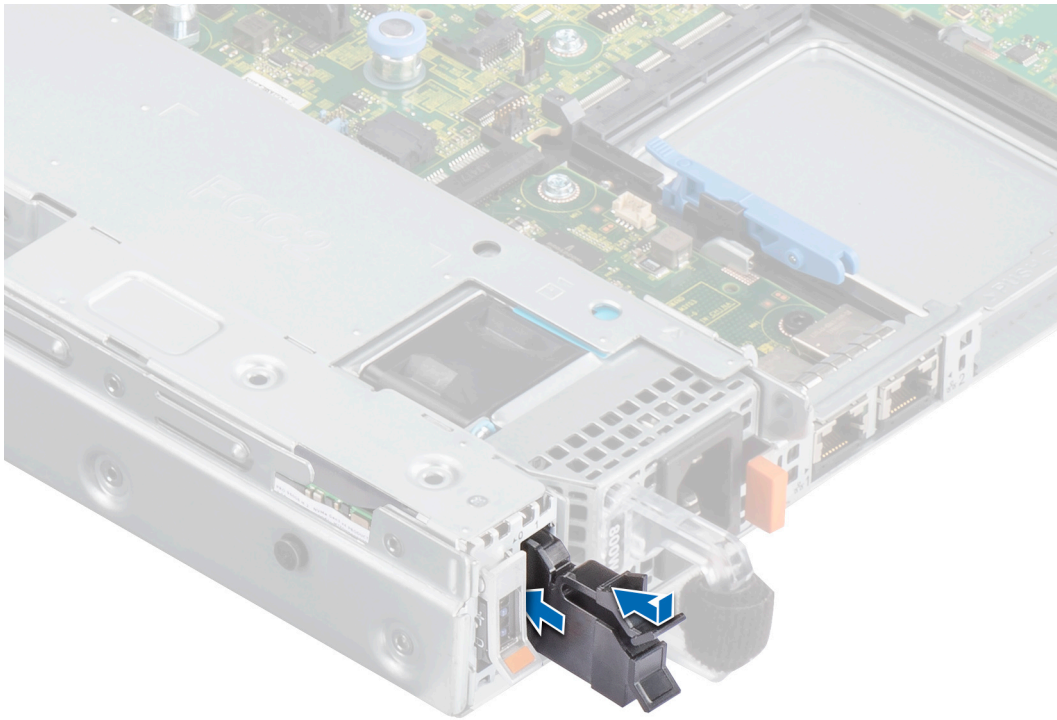

Figure 103. Installing the BOSS S2 filler

Removing the BOSS S2 module

Prerequisites

1. Follow the safety guidelines listed in the [Safety instructions](#).
2. Follow the procedure listed in the [Before working inside your system](#).

Steps

1. Lift the retention latch to release the BOSS S2 card carrier.
2. Slide the BOSS S2 card carrier out from the BOSS S2 module.

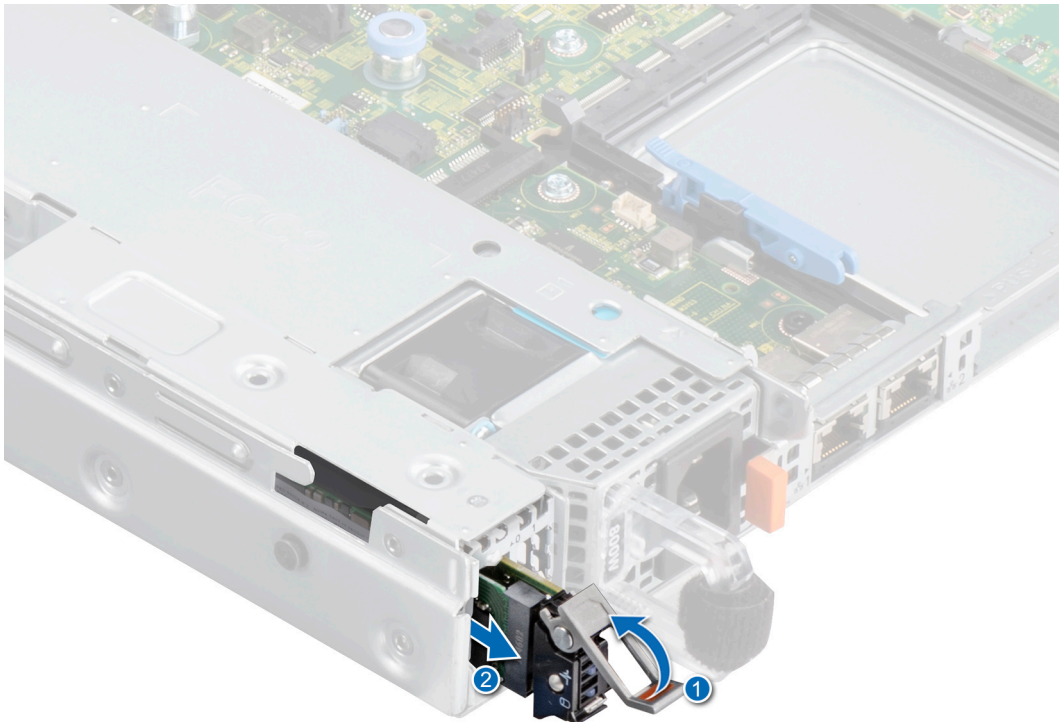

Figure 104. Removing the BOSS S2 card carrier

3. Using the Phillips #1 screwdriver remove the M3 x 0.5 x 4.5 mm screw that secures the M.2 SSD to the BOSS S2 card carrier.
4. Slide the M.2 SSD out and up from the BOSS S2 card carrier.

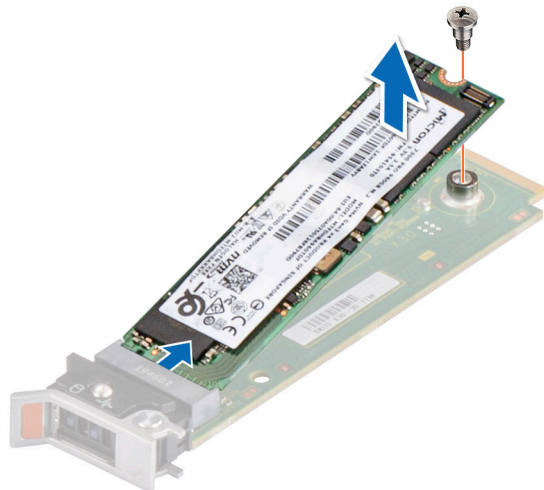

Figure 105. Removing the M.2 SSD

5. Disconnect the BOSS power cable and BOSS signal cable from the system board.
6. Using the Phillips #1 screwdriver remove the two M3 x 0.5 x 4.5 mm screws that secure the BOSS S2 controller card module on the BOSS module bay. Slide the BOSS S2 controller card module out from the BOSS module bay.

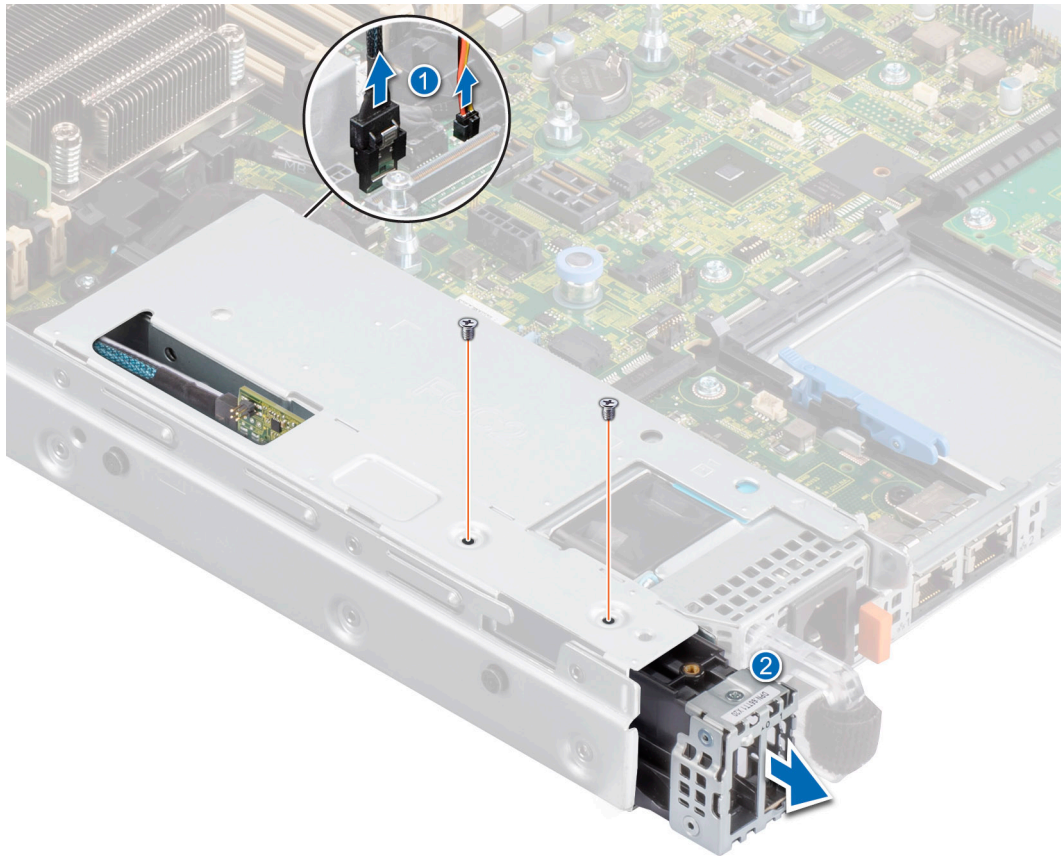

Figure 106. Removing the BOSS S2 module

7. Remove the BOSS power cable and BOSS signal cable from the BOSS S2 controller card module.

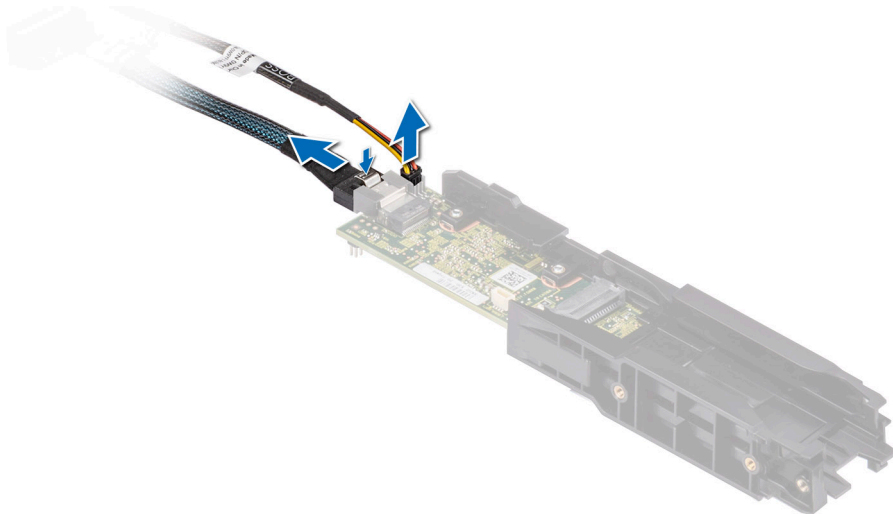

Figure 107. Removing the BOSS power cable and BOSS signal cable

8. Using the Phillips #1 screwdriver, remove the M3 x 0.5 x 4.5 mm screw that secures the BOSS cover on the BOSS S2 controller card module. Slide the BOSS cover out from the BOSS S2 controller card module.

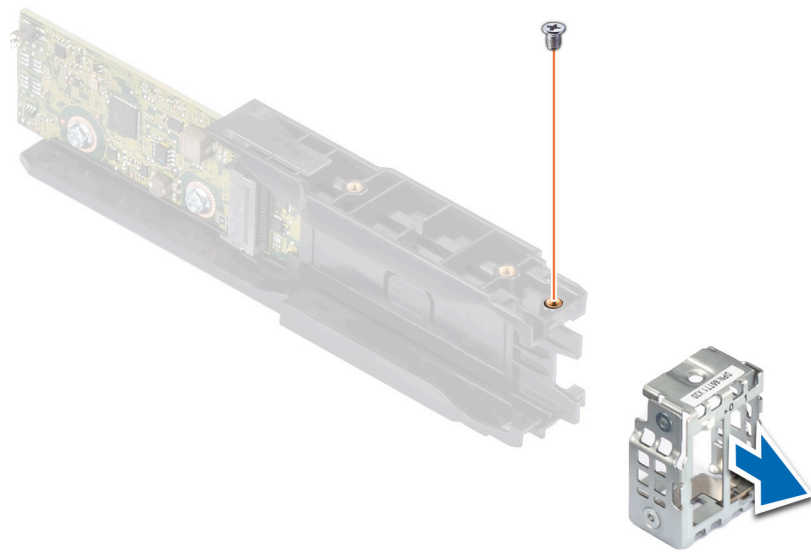

Figure 108. Removing the BOSS cover

Next steps

1. [Replace the BOSS S2 controller card module.](#)

Installing the BOSS S2 controller card

Prerequisites

1. Follow the safety guidelines listed in the [Safety instructions](#).
2. Follow the procedure listed in the [Before working inside your system](#).

Steps

1. Slide the BOSS cover on the BOSS S2 module. Using the Phillips #1 screwdriver, secure the BOSS cover on the BOSS S2 module with the M3 x 0.5 x 4.5 mm screw.

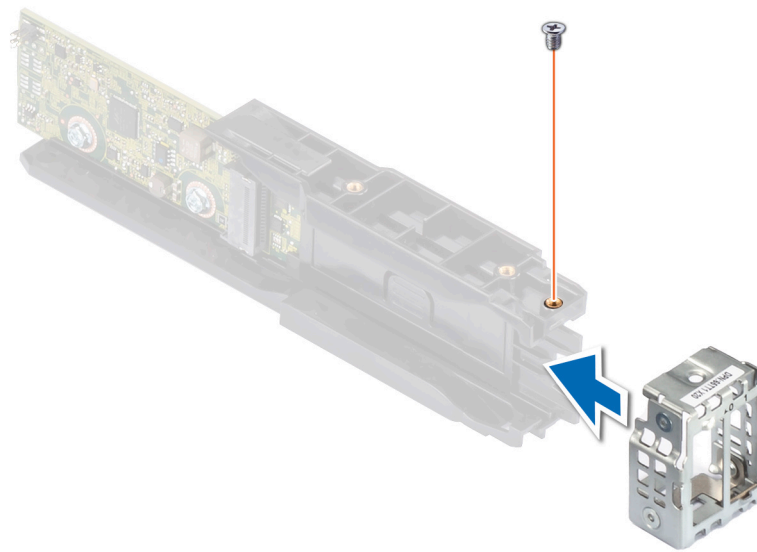

Figure 109. Installing the BOSS cover

2. Connect the BOSS power cable and BOSS signal cable to the BOSS S2 module.

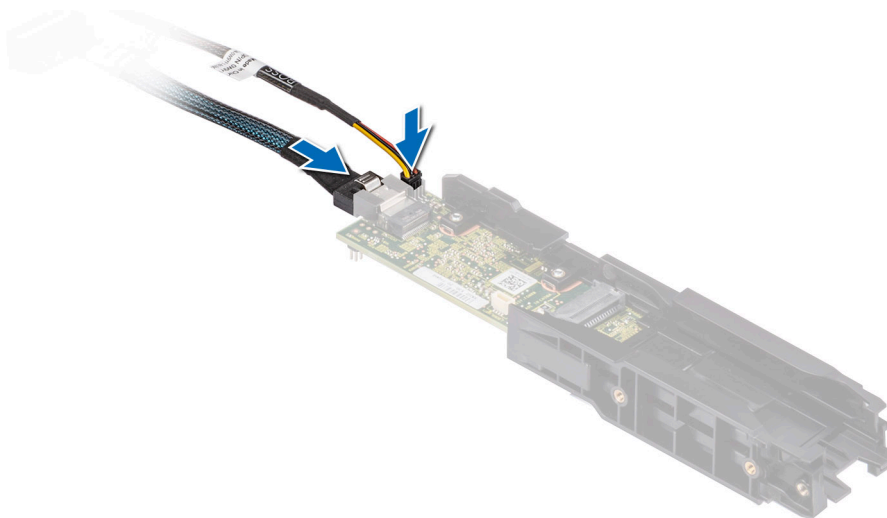

Figure 110. Connecting the BOSS power cable and BOSS Signal cable to the BOSS S2 module

i **NOTE:** Bend the power cable and then twist it together with signal cable.

3. Slide the BOSS S2 module into the BOSS module bay until it is firmly seated.
4. Using the Phillips #1 screwdriver, secure the BOSS S2 module on the BOSS module bay with the two M3 x 0.5 x 4.5 mm screws. Connect the BOSS power cable and the BOSS signal cable to the system board.

i **NOTE:** Un-twist the power and signal cables before connecting them to the connectors on the system board.

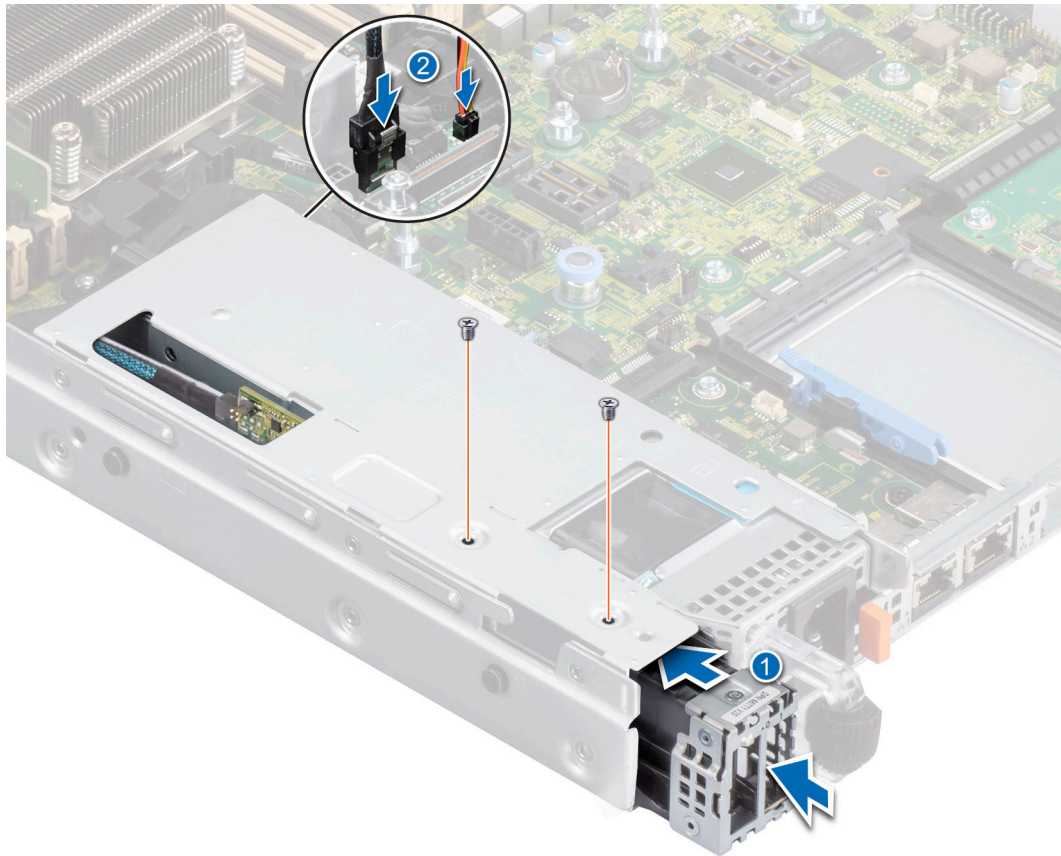

Figure 111. Installing the BOSS S2 module

5. Align the M.2 SSD at an angle with the BOSS S2 card carrier.
6. Insert the M.2 SSD until it is firmly seated in the BOSS S2 card carrier.
7. Using the Phillips #1 screwdriver, secure the M.2 SSD on the BOSS S2 card carrier with the M3 x 0.5 x 4.5 mm screw.

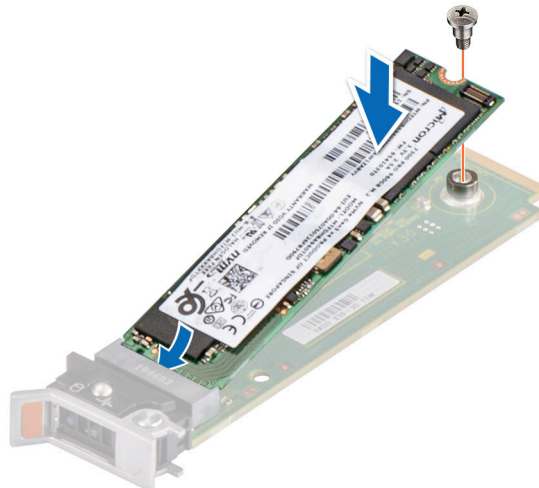

Figure 112. Installing the M.2 SSD

8. Slide the BOSS S2 card carrier into the BOSS S2 module slot.
9. Close the BOSS S2 card carrier release latch to lock the carrier in place.

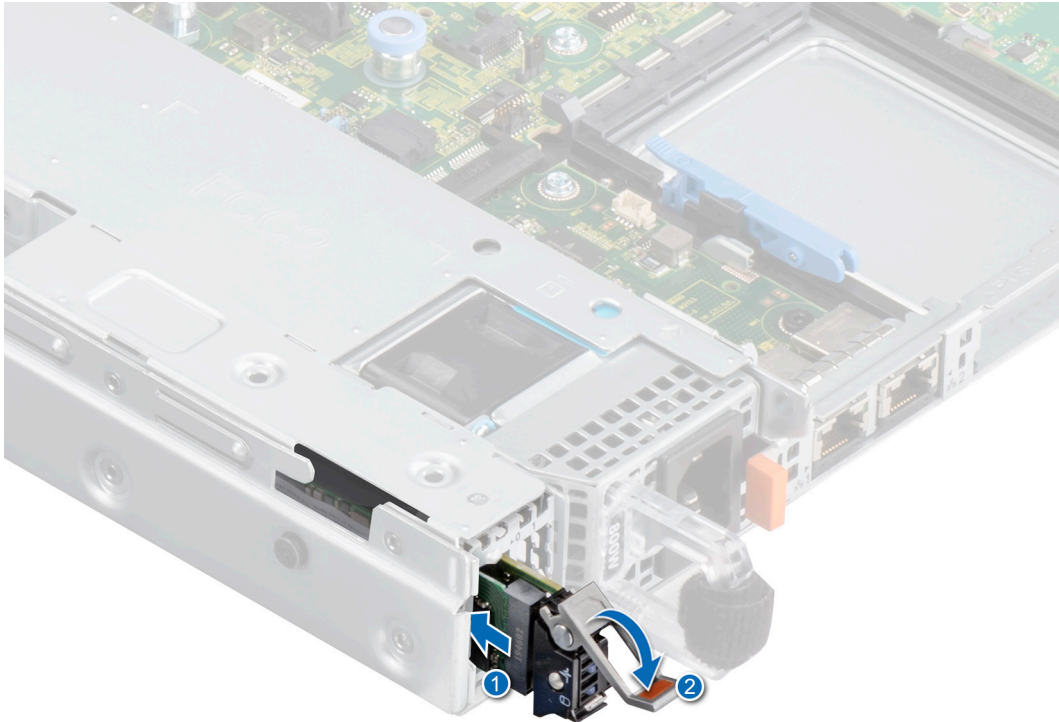

Figure 113. Installing the BOSS S2 card carrier

Next steps

1. Follow the procedure listed in the [After working inside your system](#).

Optional IDSDM module

Removing the IDSDM module

Prerequisites

1. Follow the safety guidelines listed in the [Safety instructions](#).
2. Follow the procedure listed in the [Before working inside your system](#).
3. If you are replacing the IDSDM module, [remove the MicroSD cards](#).

NOTE: Temporarily label each SD card with its corresponding slot number before removal. Reinstall the SD cards into the corresponding slots.

Steps

Holding the blue pull tab, lift the IDSDM module out of the system.

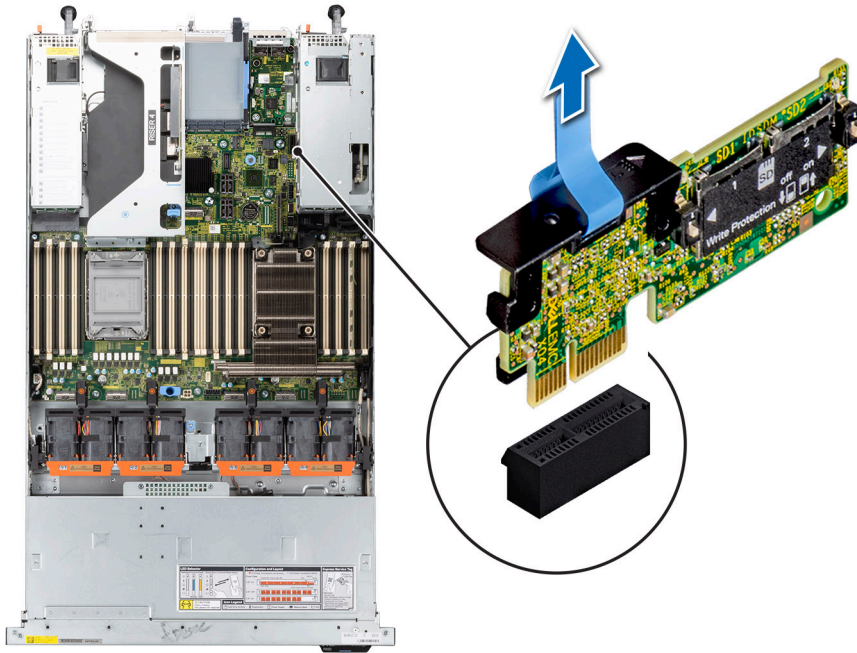

Figure 114. Removing the IDSDM module

Next steps

1. [Replace the IDSDM module.](#)

Installing the IDSDM module

Prerequisites

1. Follow the safety guidelines listed in the [Safety instructions](#).
2. Follow the procedure listed in [Before working inside your system](#).

Steps

1. Locate the IDSDM connector on the system board.
To locate IDSDM module, see the [System board jumpers and connectors](#) section.
2. Align IDSDM module with the connector on the system board.
3. Press the IDSDM module until it is firmly seated in the connector on the system board.

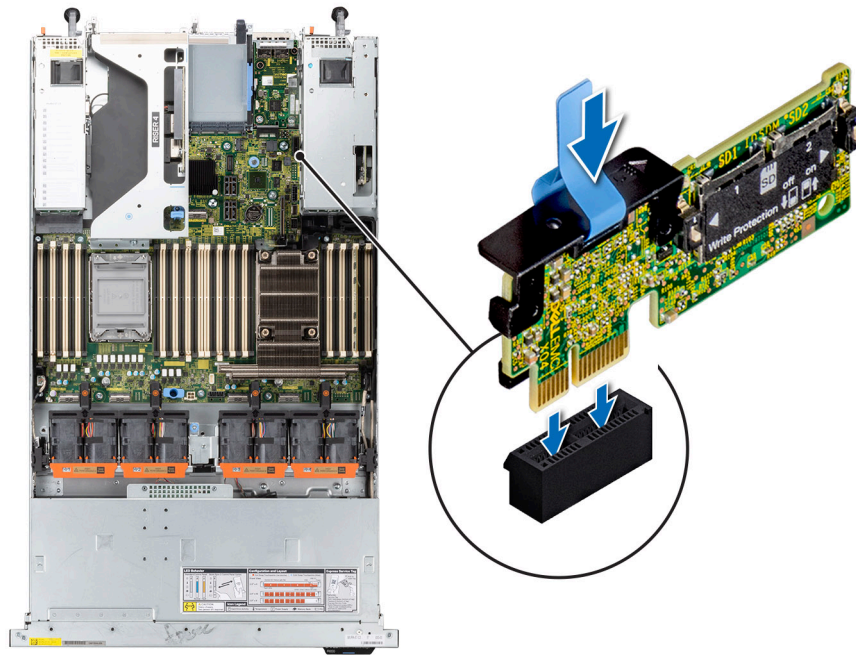

Figure 115. Installing the IDSDM module

Next steps

1. [Install the MicroSD cards.](#)
i **NOTE:** Reinstall the MicroSD cards into the same slots based on the labels you had marked on the cards during removal.
2. Follow the procedure listed in [After working inside your system.](#)

MicroSD card

Removing the MicroSD card

Prerequisites

1. Follow the safety guidelines listed in the [Safety instructions.](#)
2. Follow the procedure listed in the [Before working inside your system.](#)
3. [Remove the air shroud.](#)
4. [Remove the IDSDM module.](#)

Steps

1. Locate the MicroSD card slot on the IDSDM module, and press the card to partially release it from the slot. For more information on the slot location, see [System board jumpers and connectors section.](#)
2. Hold the MicroSD card and remove it from the slot..

i **NOTE:** Temporarily label each MicroSD card with its corresponding slot number after removal.

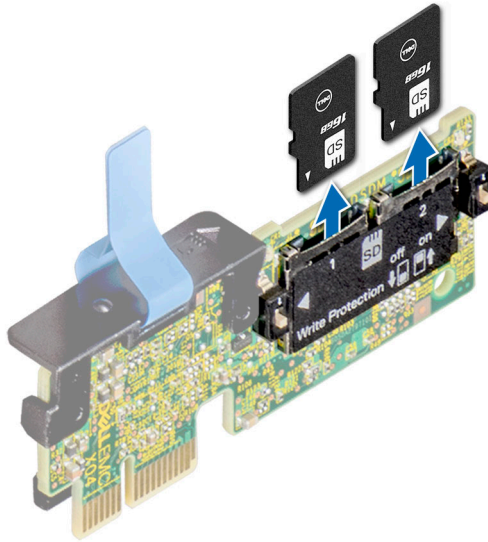

Figure 116. Removing the MicroSD card

Next steps

Replace the MicroSD cards.

Installing the MicroSD card

Prerequisites

1. Follow the safety guidelines listed in the [Safety instructions](#).
2. Follow the procedure listed in the [Before working inside your system](#).
3. [Remove the air shroud](#).
4. [Remove the IDSDM module](#).

NOTE: To use an MicroSD card with your system, ensure that the **Internal SD Card Port** is enabled in System Setup.

NOTE: Ensure that you install the MicroSD cards into the same slots based on the labels you had marked on the cards during removal.

Steps

1. Locate the MicroSD card slot on the IDSDM module. Orient the MicroSD card appropriately and insert the contact-pin end of the card into the slot. To locate IDSDM, see the [system board jumpers and connectors](#) section.

NOTE: The slot is keyed to ensure correct insertion of the card.

2. Press the card into the slot to lock it into place.

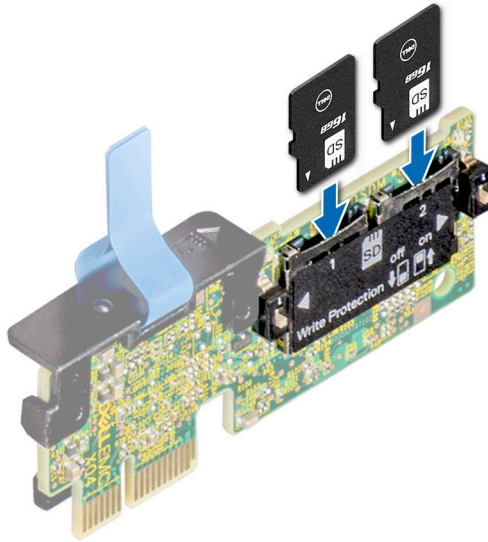

Figure 117. Installing the MicroSD card

Next steps

1. [Install the IDSDM module.](#)
2. [Install the air shroud.](#)
3. Follow the procedure listed in the [After working inside the system.](#)

Optional OCP card

Removing the OCP card

Prerequisites

1. Follow the safety guidelines listed in the [Safety instructions.](#)
2. Follow the procedure listed in the [Before working inside your system.](#)
3. [Remove the expansion card riser.](#)

Steps

1. Open the blue latch to unlock the OCP card.
2. Push the OCP card towards the rear end of the system to disconnect from the connector on the system board and slide the OCP card out of the slot on the system.

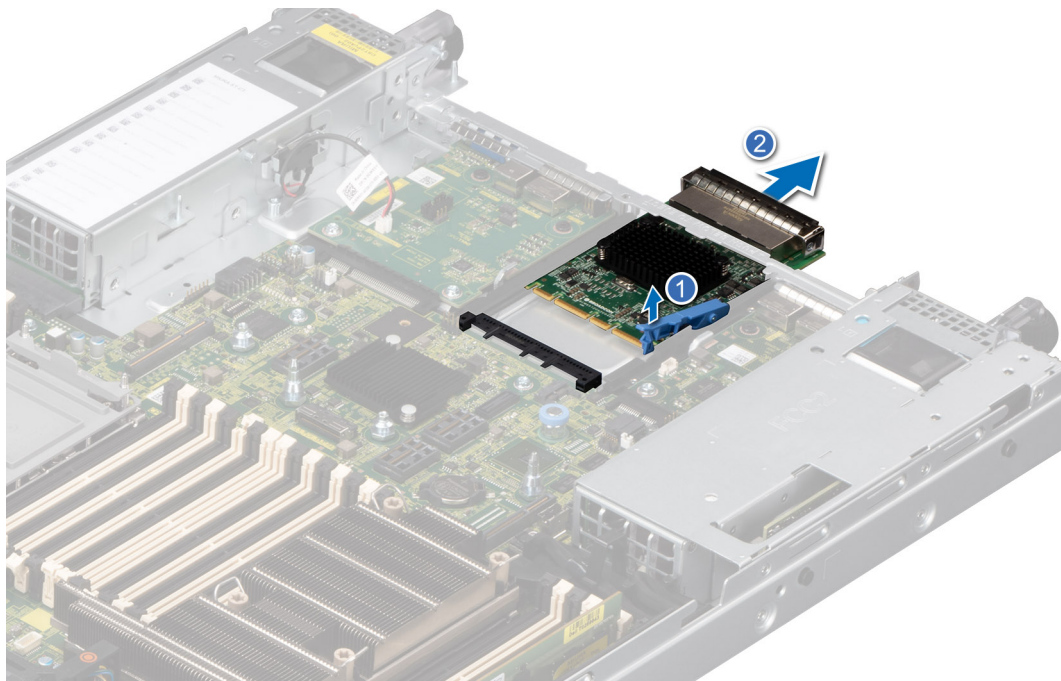

Figure 118. Removing the OCP card

Next steps

1. [Replace the OCP card.](#)

Installing the OCP card

Prerequisites

1. Follow the safety guidelines listed in the [Safety instructions](#).
2. Follow the procedure listed in the [Before working inside your system](#).
3. [Remove the expansion card riser](#).

CAUTION: Do not install GPUs, network cards, or other PCIe devices on your system that are not validated and tested by Dell. Damage caused by unauthorized and invalidated hardware installation will null and void the system warranty.

Steps

1. Open the blue latch on the system board.
2. Slide the OCP card into the slot in the system.
3. Push until the OCP card is connected to the connector on the system board.
4. Close the latch to lock the OCP card to the system.

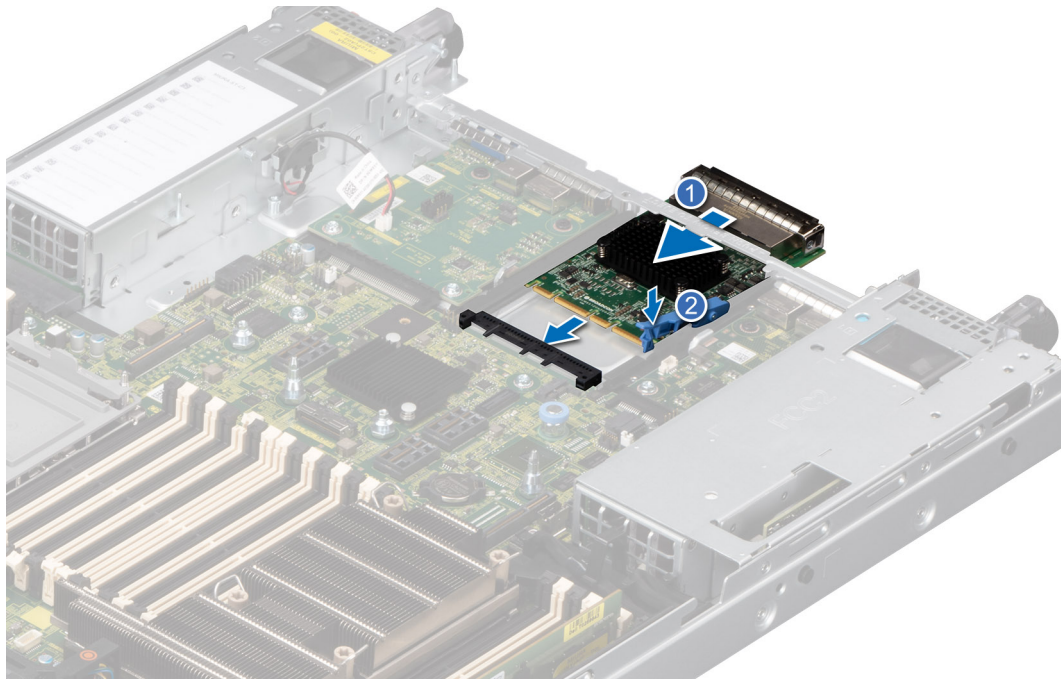

Figure 119. Installing the OCP card

Next steps

1. [Install the expansion card riser](#)
2. Follow the procedure listed in [After working inside the system](#).

System battery

This is a service technician replaceable part only.

Replacing the system battery

Prerequisites

⚠ WARNING: There is a danger of a new battery exploding if it is incorrectly installed. Replace the battery only with the same or equivalent type That is recommended by the manufacturer. Discard used batteries according to the manufacturer's instructions. See the Safety instructions. that came with your system for more information.

1. Follow the safety guidelines listed in the [Safety instructions](#).
2. Follow the procedure listed in the [Before working inside your system](#).
3. If applicable, disconnect the power or data cables from the expansion cards.
4. [Remove the expansion card risers](#).

Steps

1. To remove the battery:
 - a. Use a plastic scribe to pry out the system battery.

⚠ CAUTION: To avoid damage to the battery connector, you must firmly support the connector while installing or removing a battery.

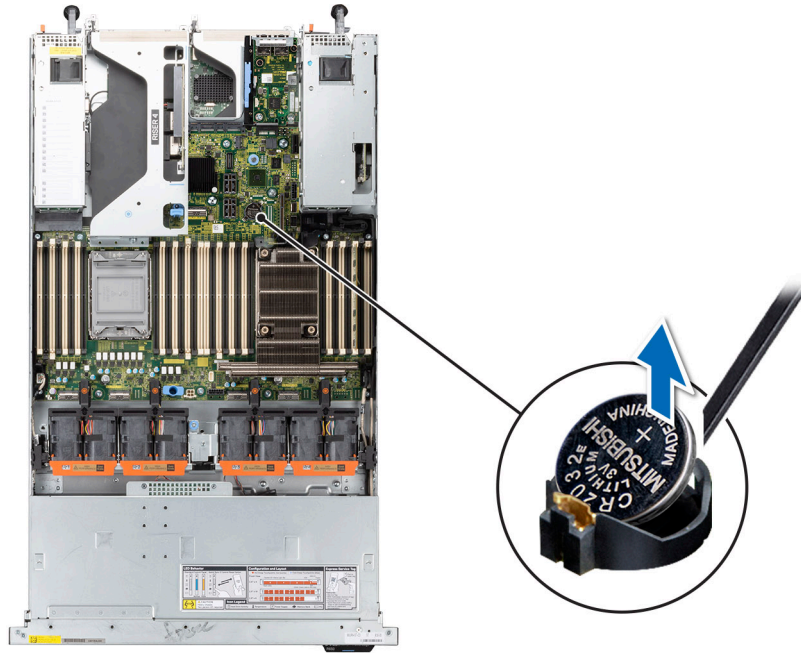

Figure 120. Removing the system battery

2. To install a new system battery:
 - a. Hold the battery with the positive side facing up and slide it under the securing tabs.
 - b. Press the battery into the connector until it snaps into place.

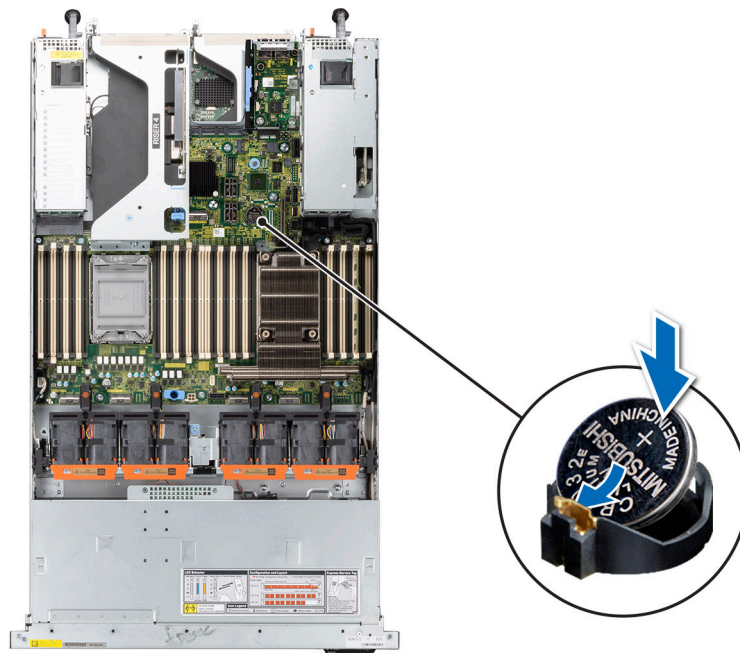

Figure 121. Installing the system battery

Next steps

1. [Install the expansion card risers.](#)
2. If applicable, connect the cables to one or more expansion cards.
3. Follow the procedure listed in [After working inside your system.](#)
4. Confirm that the battery is operating properly, by performing the following steps:
 - a. Enter the System Setup, while booting, by pressing F2.

- b. Enter the correct time and date in the System Setup **Time** and **Date** fields.
- c. **Exit** the System Setup.
- d. To test the newly installed battery, remove the system from the enclosure for at least an hour.
- e. Reinstall the system into the enclosure after an hour.
- f. Enter the System Setup and if the time and date are still incorrect, see [Getting help section](#).

Optional internal USB card

NOTE: To locate the internal USB port on the system board, see the [System board jumpers and connectors](#) section.

Removing the optional internal USB card

Prerequisites

CAUTION: To avoid interference with other components in the server, the maximum permissible dimensions of the USB memory key are 15.9 mm width x 57.15 mm length x 7.9 mm height.

1. Follow the safety guidelines listed in the [Safety instructions](#).
2. Follow the procedure listed in the [Before working inside your system](#).

Steps

1. Holding the blue tag, lift the internal USB card to disconnect from the connector on the system board.
2. Remove the USB memory key from the internal USB card.

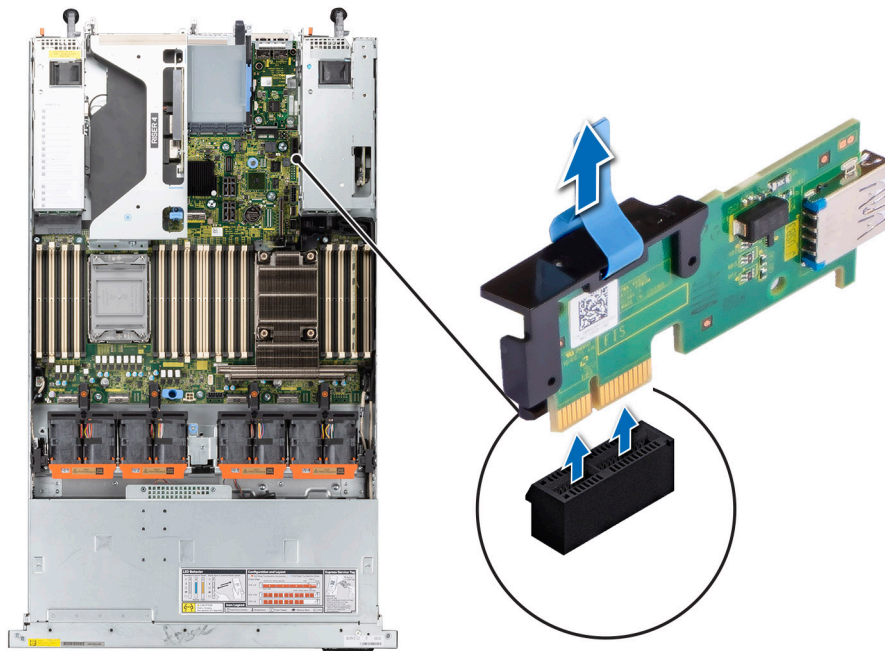

Figure 122. Removing the internal USB card

Next steps

Replace the internal USB card.

Installing the internal USB card

Prerequisites

1. Follow the safety guidelines listed in the [Safety instructions](#).
2. Follow the procedure listed in the [Before working inside your system](#).

Steps

1. Connect the USB key to the internal USB card.
2. Align the internal USB card with the connector on the system board and press firmly until the internal USB card is seated.

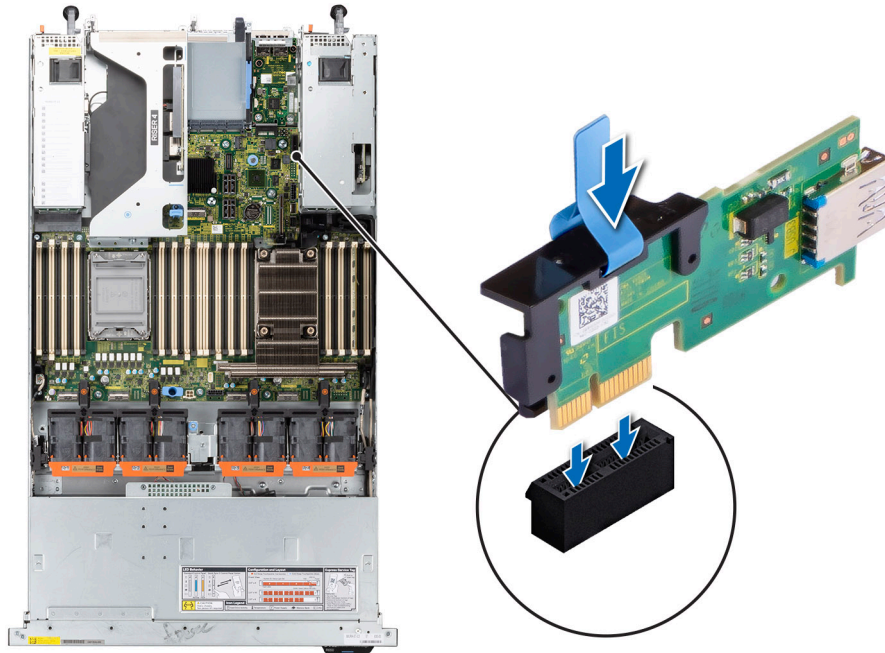

Figure 123. Installing the internal USB card

Next steps

1. Follow the procedure listed in [After working inside your system](#).
2. While booting, press F2 to enter **System Setup** and verify that the system detects the USB memory key.

VGA module

This is a service technician replaceable part only.

Removing the VGA module

Prerequisites

1. Follow the safety guidelines listed in the [Safety instructions](#).
2. Follow the procedure listed in the [Before working inside your system](#).
3. If installed, [remove the front bezel](#).
4. [Remove the backplane cover](#).
5. If installed, [remove the air shroud](#).

Steps

1. Disconnect the VGA cable from the connector on the system board and open the cable latch.
2. Disconnect the right control panel cable from the system board and move it away to see the VGA module screw on the system.

i **NOTE:** Ensure that you note the routing of the cables as you remove them from the system board. Route the cable properly when you replace it to prevent the cable from being pinched or crimped

3. Using Phillips #2 screwdriver, remove the screw on the VGA module.
4. Slide the VGA module out of the system.

i **NOTE:** The numbers on the image do not depict the exact steps. The numbers are for representation of sequence.

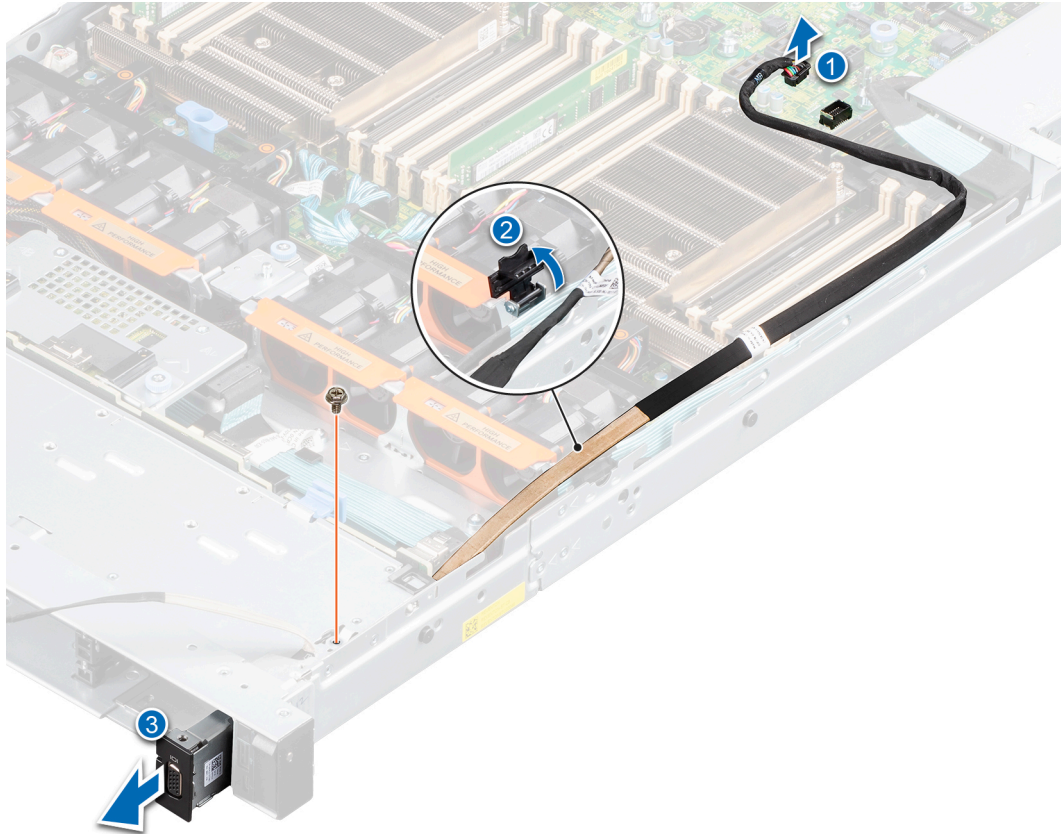

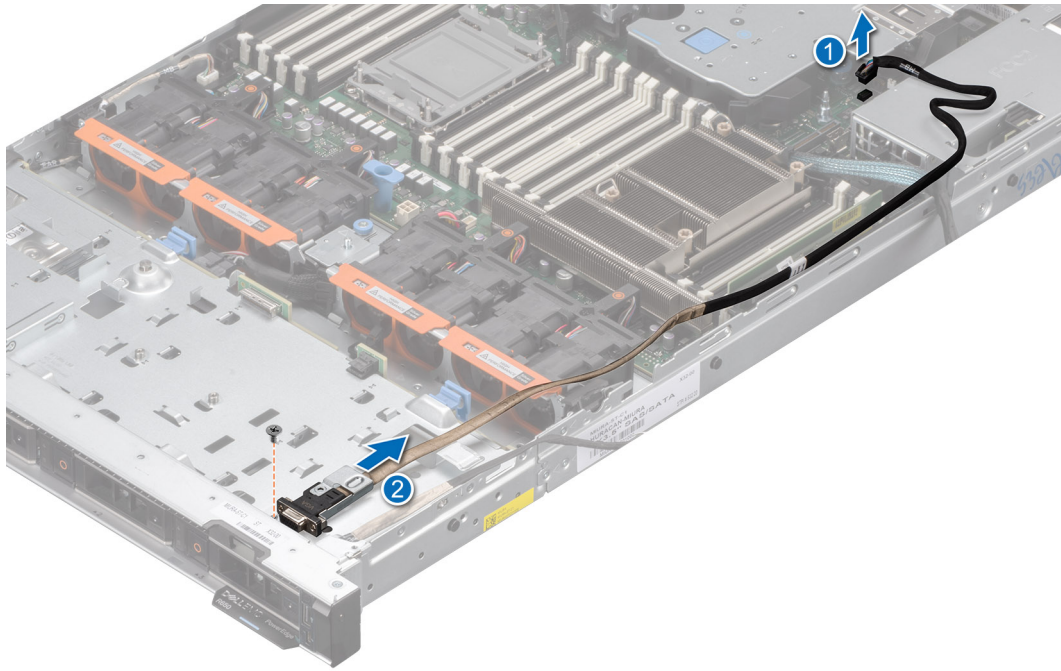

Figure 124. Removing the VGA module

Next steps

1. [Replace the VGA module.](#)

Installing the VGA module

Prerequisites

1. Follow the safety guidelines listed in the [Safety instructions](#).
2. Follow the procedure listed in [Before working inside your system](#).
3. If installed, [remove the front bezel](#).
4. [Remove the backplane cover](#).
5. If installed, [remove the air shroud](#).
6. Disconnect the VGA cable from the connector on the system board.
7. Pull the right control panel cable from the clip and move it to clear the path of the VGA module screw.

NOTE: Ensure that you note the routing of the cables as you remove them from the system board. Route the cable properly when you replace it to prevent the cable from being pinched or crimped

Steps

1. Route the VGA cable through the slot on the front of the system and slide the VGA module into the slot.
2. Align the hole on the module with the screw hole on the system.
3. Using the Phillips #2 screwdriver, secure the VGA module to the system with the screw.

NOTE: The numbers on the image do not depict the exact steps. The numbers are for representation of sequence.

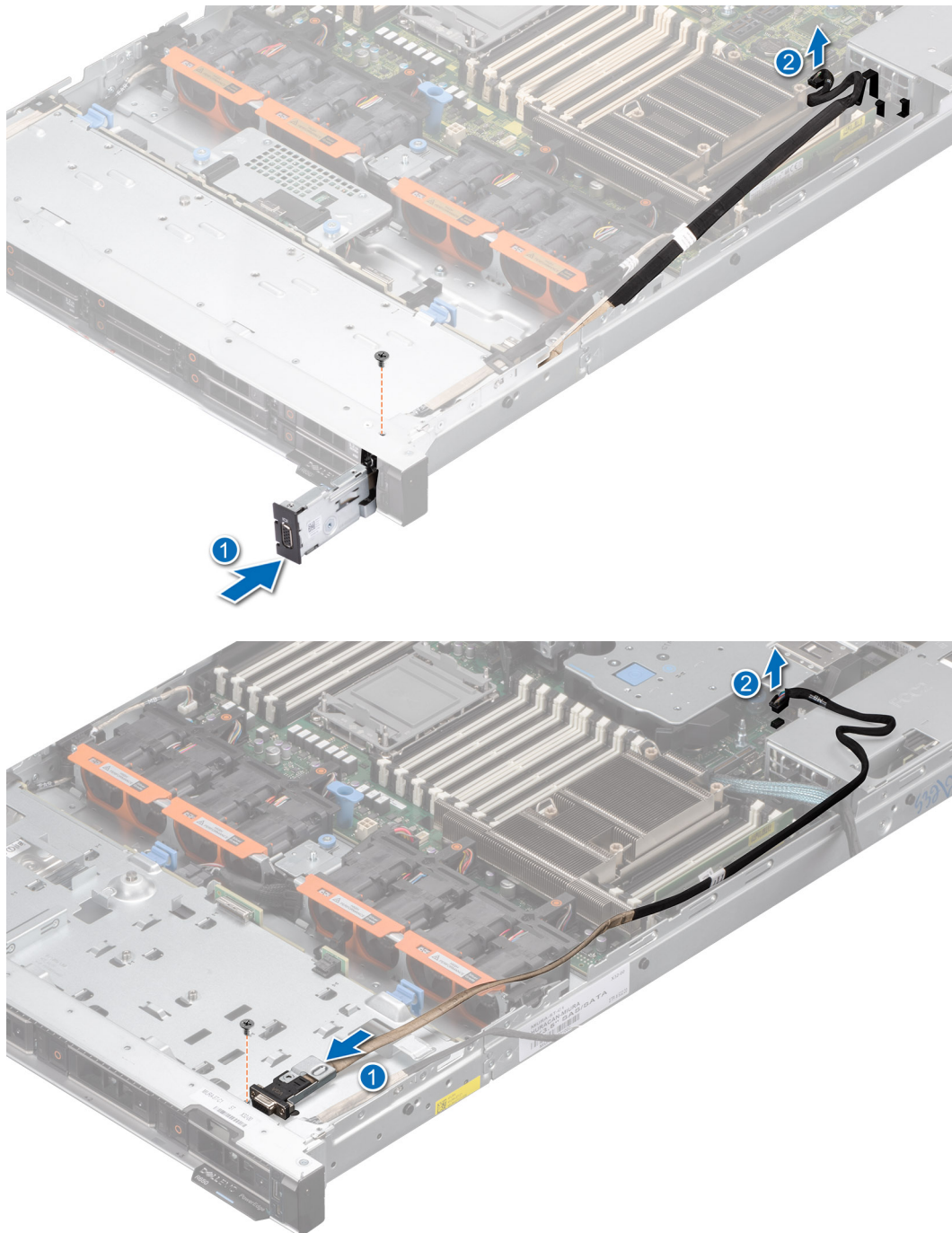

Figure 125. Installing the VGA module

Next steps

1. Route the VGA cable, close the cable latch, and connect the VGA cable to the connector on the system board.
2. Route and connect the right control panel cable.
3. If removed, [install the air shroud](#).
4. [Install the backplane cover](#).
5. If installed, [install the front bezel](#).
6. Follow the procedure listed in the [After working inside your system](#).

Removing the rear VGA port

Prerequisites

1. Follow the safety guidelines listed in the [Safety instructions](#).
2. Follow the procedure listed in [Before working inside your system](#).
3. [Remove expansion card riser 3](#).

Steps

1. Disconnect the VGA port cable from the video connector on the rear I/O board and open the latch on the expansion card riser.
2. Slide the VGA port out of the expansion card riser.

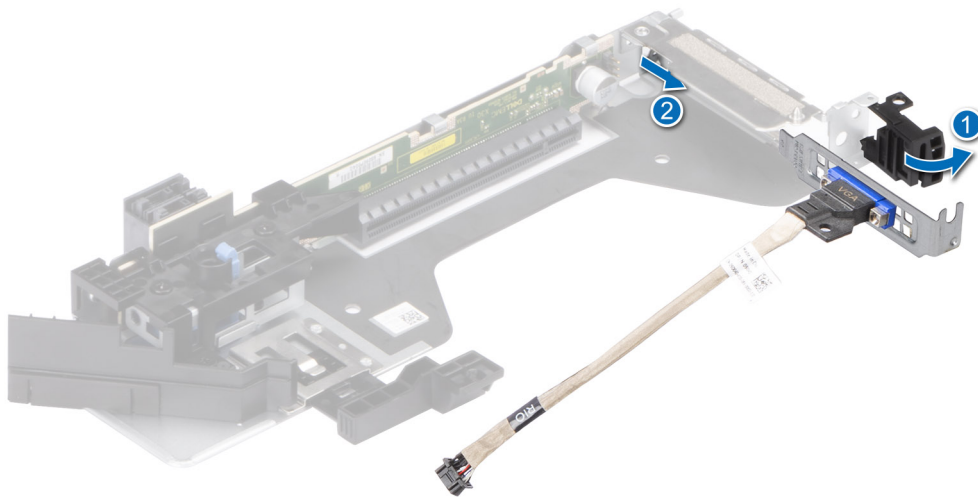

Figure 126. Removing the VGA port

3. If the VGA module is not going to be replaced, install a filler bracket and close the card retention latch.

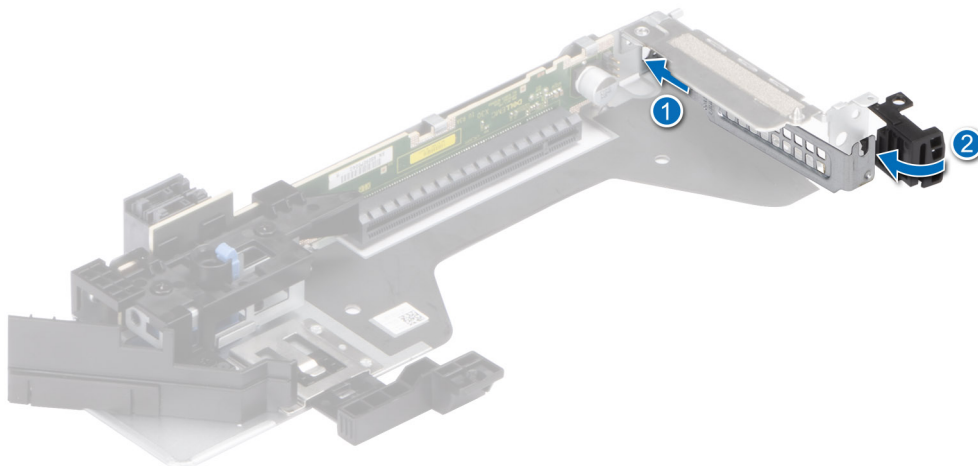

Figure 127. Installing the filler bracket

Next steps

1. Replace the rear VGA module or install the riser blank.

Installing the rear VGA port

Prerequisites

1. Follow the safety guidelines listed in the [Safety instructions](#).
2. Follow the procedure listed in [Before working inside your system](#).
3. [Remove expansion card riser 3](#).

Steps

1. If installed, remove the filler bracket from the expansion card riser (Riser 3).

i **NOTE:** For more information about how to remove the filler bracket, see the [Removing the expansion card from the expansion card riser](#) topic.

i **NOTE:** Store the filler bracket for future use. Filler brackets must be installed in empty expansion card slots to maintain Federal Communications Commission (FCC) certification of the system. The brackets also keep dust and dirt out of the system and aid in proper cooling and airflow inside the system.

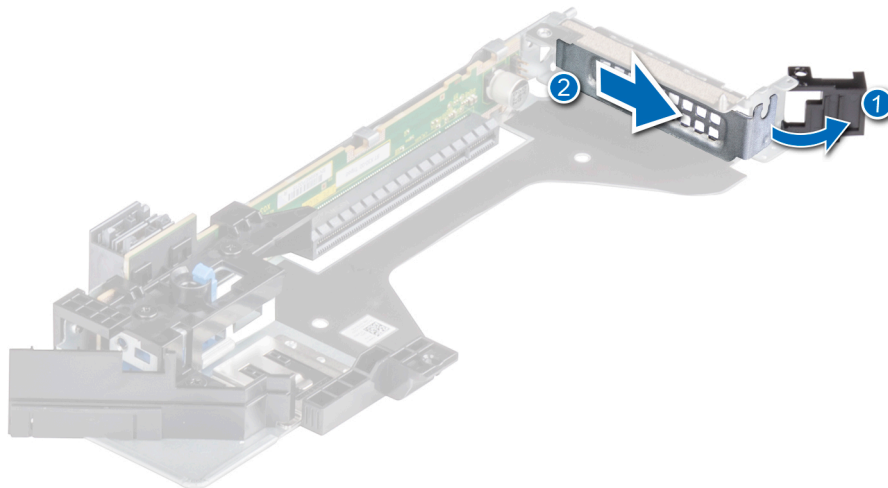

Figure 128. Removing the filler bracket

2. Slide the VGA port into the expansion card riser.
3. Close the expansion card retention latch.
4. Connect the VGA cable to the connector on the rear I/O board.

i **NOTE:** The numbers on the image do not depict the exact steps. The numbers are for representation of sequence.

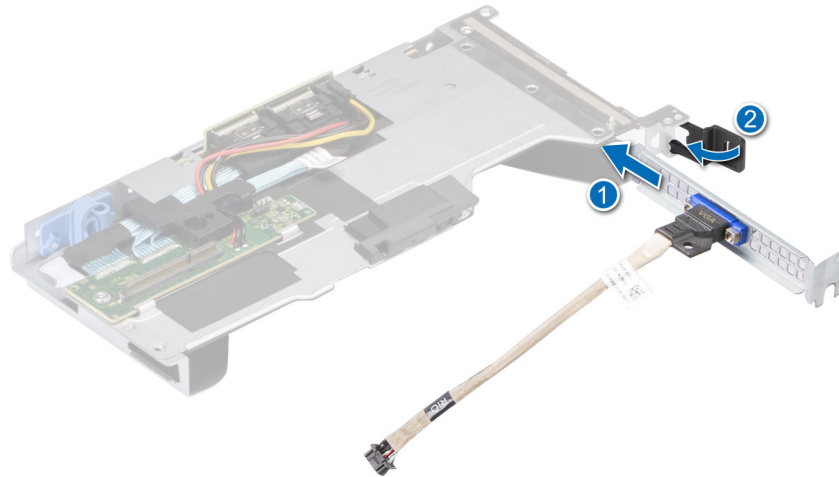

Figure 129. Installing the rear VGA port

Next steps

1. Install the expansion card riser.
2. Follow the procedure listed in [After working inside your system](#).

Power supply unit

NOTE: While replacing the hot swappable PSU, after next server boot; the new PSU automatically updates to the same firmware and configuration of the replaced one. For updating to the latest firmware and changing the configuration, see the *Lifecycle Controller User's Guide* at <https://www.dell.com/idracmanuals>.

Hot spare feature

Your system supports the hot spare feature that significantly reduces the power overhead associated with the power supply unit (PSU) redundancy.

When the hot spare feature is enabled, one of the redundant PSUs is switched to the sleep state. The active PSU supports 100 percent of the system load, thus operating at higher efficiency. The PSU in the sleep state monitors output voltage of the active PSU. If the output voltage of the active PSU drops, the PSU in the sleep state returns to an active output state.

If having both PSUs active is more efficient than having one PSU in the sleep state, the active PSU can also activate the sleeping PSU.

The default PSU settings are as follows:

- If the load on the active PSU is more than 50 percent of PSU rated power wattage, then the redundant PSU is switched to the active state.
- If the load on the active PSU falls below 20 percent of PSU rated power wattage, then the redundant PSU is switched to the sleep state.

You can configure the hot spare feature by using the iDRAC settings. For more information, see the *iDRAC User's Guide* available at www.dell.com/poweredgemanuals.

Removing a power supply unit blank

Prerequisites

Follow the safety guidelines listed in the [Safety instructions](#).

Steps

Pull the blank out of the system.

CAUTION: To ensure proper system cooling, the PSU blank must be installed in the second PSU bay in a non-redundant configuration. Remove the PSU blank only if you are installing a second PSU.

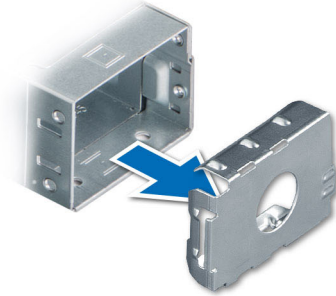

Figure 130. Removing a power supply unit blank

Next steps

Replace the PSU or PSU blank.

Installing a power supply unit blank

Prerequisites

1. Follow the safety guidelines listed in the [Safety instructions](#).
NOTE: Install the power supply unit (PSU) blank only in the second PSU bay.
2. [Remove the PSU](#).

Steps

Align the PSU blank with the PSU bay and push it into the PSU bay until it clicks into place.

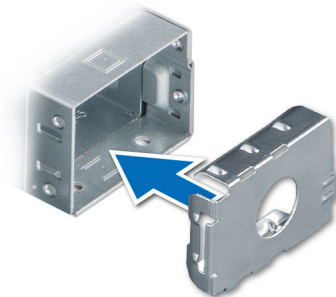

Figure 131. Installing a power supply unit blank

Removing a power supply unit

Prerequisites

CAUTION: The system requires one power supply unit (PSU) for normal operation. On power-redundant systems, remove and replace only one PSU at a time in a system that is powered on.

1. Follow the safety guidelines listed in the [Safety instructions](#).
2. Disconnect the power cable from the power outlet and from the PSU you intend to remove.
3. Remove the cable from the strap on the PSU handle.
4. Unlatch and lift the optional cable management arm if it interferes with the PSU removal.

For information about the cable management arm, see the system's rack documentation at <https://www.dell.com/poweredgemanuals>

Steps

Press the release latch, and holding the PSU handle slide the PSU out of the PSU bay.



Figure 132. Removing a power supply unit

Next steps

Replace the PSU or install the PSU blank.

Installing a power supply unit

Prerequisites

1. Follow the safety guidelines listed in the [Safety instructions](#).
2. For systems that support redundant PSU, ensure that both the PSUs are of the same type and have the same maximum output power.

NOTE: The maximum output power (shown in watts) is listed on the PSU label.

3. Remove the [PSU blank](#).

Steps

Slide the PSU into the PSU bay until the release latch snaps into place.



Figure 133. Installing a power supply unit

Next steps

1. If you have unlatched the cable management arm, relatch it. For information about the cable management arm, see the system's rack documentation at <https://www.dell.com/poweredge/manuals>.
2. Connect the power cable to the PSU, and plug the cable into a power outlet.

CAUTION: When connecting the power cable to the PSU, secure the cable to the PSU with the strap.

NOTE: When installing, hot swapping, or hot adding a new PSU, wait for 15 seconds for the system to recognize the PSU and determine its status. The PSU redundancy may not occur until discovery is complete. The PSU status indicator turns green to indicate that the PSU is functioning properly.

NOTE: For certain premium configurations with high power consumption, system PSU might stay with 2+0 mode only, 1+1 redundant mode is not available.

NOTE: While replacing the hot swappable PSU, after next server boot; the new PSU automatically updates to the same firmware and configuration of the replaced one. For updating to the latest firmware and changing the configuration, see the *Lifecycle Controller User's Guide* at <https://www.dell.com/idrac/manuals>.

Optional serial COM port

Removing the serial COM port

Prerequisites

1. Follow the safety guidelines listed in the [Safety instructions](#).
2. Follow the procedure listed in [Before working inside your system](#).

Steps

1. [Lift the expansion card riser](#) and disconnect the serial COM port cable from the connector on the rear I/O board.
2. Open the latch on the expansion card riser.
3. Slide the serial COM port out of the expansion card riser.

NOTE: The numbers on the image do not depict the exact steps. The numbers are for representation of sequence.

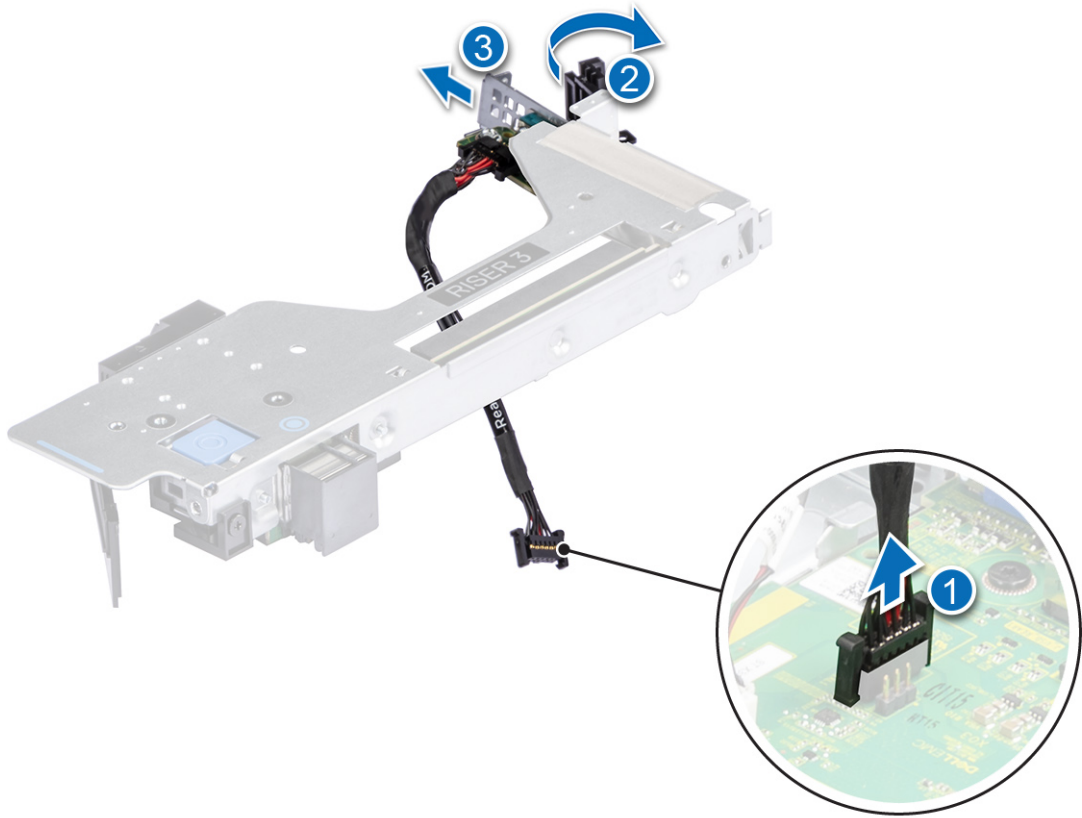

Figure 134. Removing the serial COM port

4. If the serial COM port is not going to be replaced, install a filler bracket.
5. Close the card retention latch.

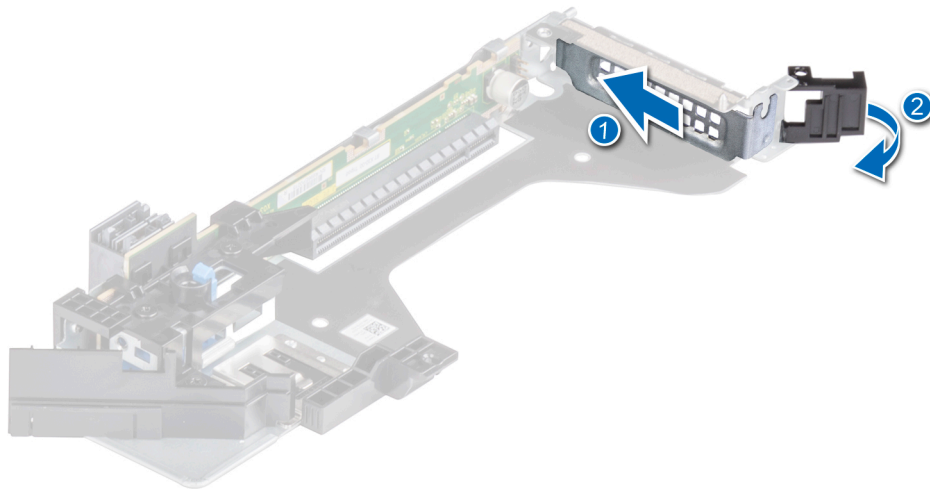

Figure 135. Installing the filler bracket

Next steps

1. [Replace the serial COM port.](#)

Installing the serial COM port

Prerequisites

1. Follow the safety guidelines listed in the [Safety instructions](#).
2. Follow the procedure listed in [Before working inside your system](#).
3. [Lift the expansion card riser](#) and disconnect the serial COM port cable from the connector on the rear I/O board.

Steps

1. If installed, remove the filler bracket from the expansion card riser (Riser 3).

i **NOTE:** For more information about how to remove the filler bracket, see the [Removing the expansion card from the expansion card riser](#) topic.

i **NOTE:** Store the filler bracket for future use. Filler brackets must be installed in empty expansion card slots to maintain Federal Communications Commission (FCC) certification of the system. The brackets also keep dust and dirt out of the system and aid in proper cooling and airflow inside the system.

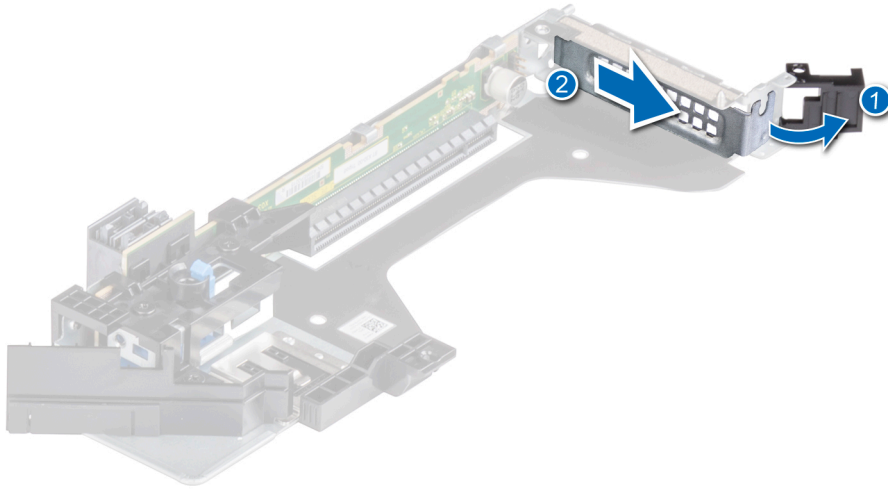

Figure 136. Removing the filler bracket

2. Slide the serial COM port into the expansion card riser.
3. Connect the serial COM port cable to the serial port.
4. Close the expansion card retention latch.
5. Connect the serial COM port cable to the connector on the rear I/O board.

NOTE: The numbers on the image do not depict the exact steps. The numbers are for representation of sequence.

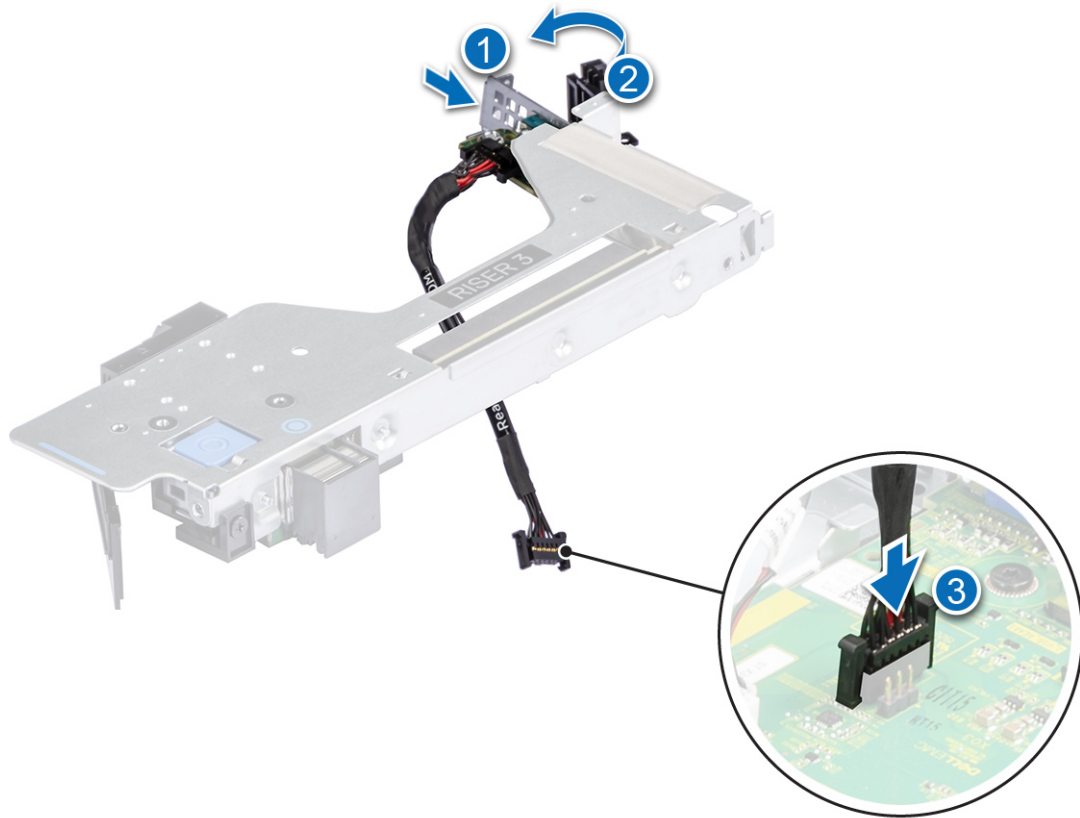

Figure 137. Installing the serial COM port

Next steps

1. [Install the expansion card riser.](#)
2. Follow the procedure listed in [After working inside your system.](#)

System board

This is a service technician replaceable part only.

Removing the system board

Prerequisites

CAUTION: If you are using the Trusted Platform Module (TPM) with an encryption key, you may be prompted to create a recovery key during program or System Setup. Be sure to create and safely store this recovery key. If you replace this system board, you must supply the recovery key when you restart your system or program before you can access the encrypted data on your drives.

1. Follow the safety guidelines listed in the [Safety instructions.](#)
2. Follow the procedure listed in [Before working inside your system.](#)
3. Remove the following components:
 - a. [Air shroud](#)
 - b. [Cooling fan modules](#)
 - c. [Processor and heat sink module](#)
 - d. [Memory modules](#)

- e. Expansion card risers
- f. IDSDM module (if installed)
- g. Internal USB card (if installed)
- h. OCP card (if installed)
- i. Power supply units (PSU)
- j. Disconnect all cables from the system board.

CAUTION: Take care not to damage the system identification button while removing the system board from the system.

Steps

1. Using the system board holder and plunger, slide the system board towards the front of the system.
2. Lift the system board out of the chassis.

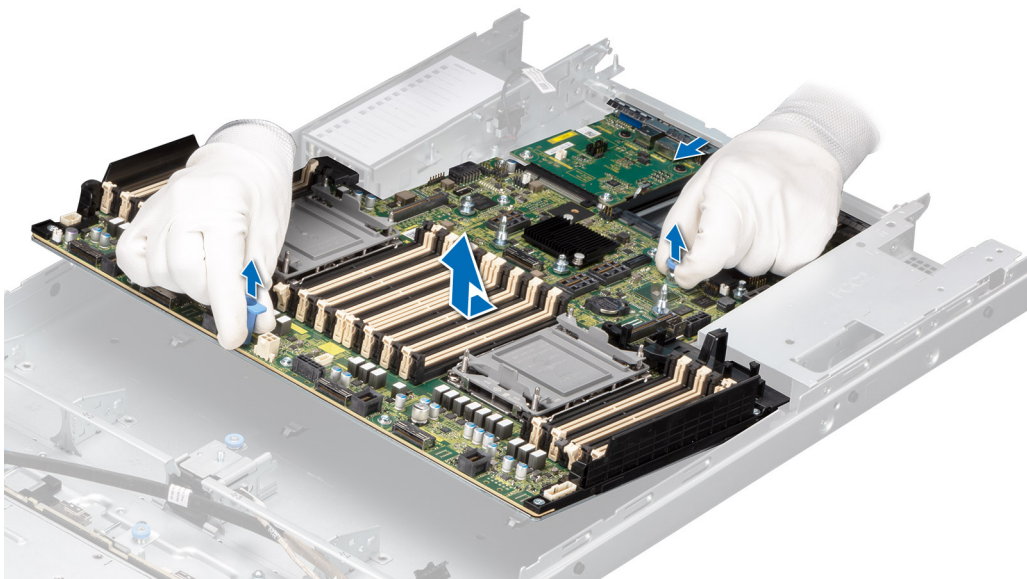

Figure 138. Removing the system board

Next steps

1. Install the system board.

Installing the system board

Prerequisites

NOTE: Before replacing the system board, replace the old iDRAC MAC address label in the Information tag with the iDRAC MAC address label of the replacement system board

1. Follow the safety guidelines listed in the [Safety instructions](#).
2. Follow the procedure listed in [Before working inside your system](#).
3. If you are replacing the system board, remove all the components that are listed in the removing the system board section.

Steps

1. Unpack the new system board assembly.

CAUTION: Do not lift the system board by holding a memory module, processor, or other components.

CAUTION: Take care not to damage the system identification button while placing the system board into the chassis.

2. Holding the system board holder and plunger, lower the system board into the system.
3. Slide the system board towards the rear of the chassis until the connectors are firmly seated in the slots.

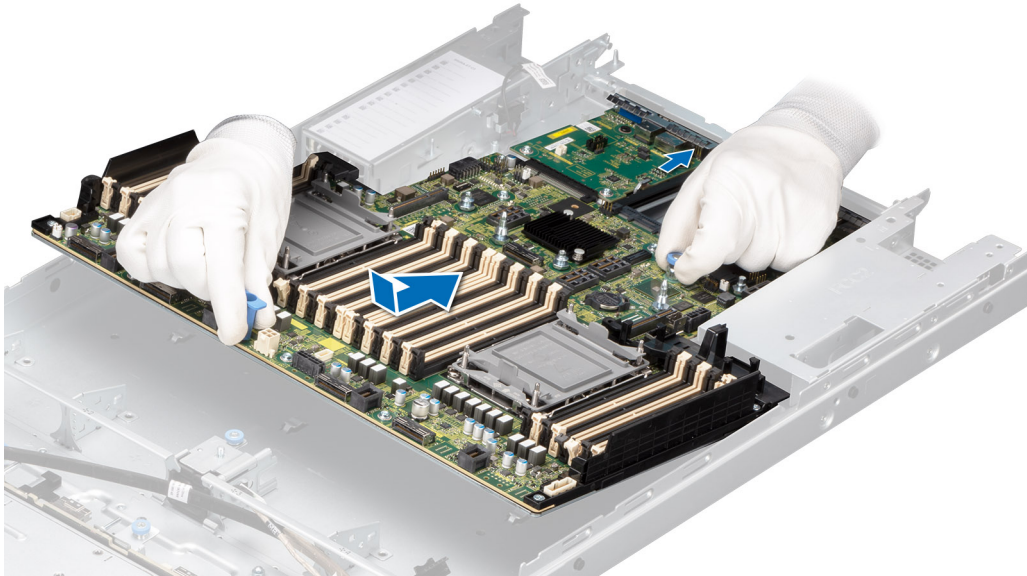

Figure 139. Installing the system board

Next steps

1. Replace the following components:
 - a. [Trusted Platform Module \(TPM\)](#)
NOTE: The TPM Module must be replaced only while installing new system board.
 - b. [IDSDM module \(if installed\)](#)
 - c. [Internal USB card \(if installed\)](#)
 - d. [Power supply units \(PSU\)](#)
 - e. [OCP card \(if installed\)](#)
 - f. [Processor heat sink module](#)
 - g. [Memory modules](#)
 - h. [Cooling fan modules](#)
 - i. [Air shroud](#)
2. Reconnect all cables to the system board.
NOTE: Ensure that the cables inside the system are routed along the chassis wall and secured using the cable securing bracket.
3. Ensure that you perform the following steps:
 - a. Use the Easy Restore feature to restore the Service Tag. See the [Restoring the system by using the Easy Restore feature](#) section.
 - b. If the service tag is not backed up in the backup flash device, enter the system service tag manually. See the [Manually update the Service Tag by using System Setup](#) section.
 - c. Update the BIOS and iDRAC versions.
Reenable the Trusted Platform Module (TPM). See the [Upgrading the Trusted Platform Module](#) section.
4. If you are not using Easy restore, import your new or existing iDRAC Enterprise license. For more information, see the *Integrated Dell Remote Access Controller User's Guide* available at <https://www.dell.com/idracmanuals>.
5. Follow the procedure listed in [After working inside your system](#).

Restoring the system using Easy Restore

The Easy Restore feature enables you to restore your service tag, license, UEFI configuration, and the system configuration data after replacing the system board. All data is backed up in a backup flash device automatically. If BIOS detects a new system board, and the service tag in the backup flash device, BIOS prompts the user to restore the backup information.

About this task

Below is a list of options/steps available:

- Restore the service tag, license, and diagnostics information, press **Y**
- Navigate to the Lifecycle Controller based restore options, press **N**
- Restore data from a previously created **Hardware Server Profile**, press **F10**
i **NOTE:** When the restore process is complete, BIOS prompts to restore the system configuration data.
- Restore data from a previously created **Hardware Server Profile**, press **F10**
- To restore the system configuration data, press **Y**
- To use the default configuration settings, press **N**
- **i** **NOTE:** After the restore process is complete, system reboots.

Trusted Platform Module

This is a service technician replaceable part only.

Upgrading the Trusted Platform Module

Removing the TPM

Prerequisites

- i** **NOTE:**
- Ensure the operating system is compatible with the TPM version you are installing.
 - Ensure that you download and install the latest BIOS firmware on your system.
 - Ensure that the BIOS is configured to enable UEFI boot mode.

△ **CAUTION:** The TPM plug-in module is cryptographically bound to that particular system board after it is installed. When the system is powered on, any attempt to remove an installed TPM plug-in module breaks the cryptographic binding, and the removed TPM cannot be installed on another system board. Ensure any keys you have stored on the TPM have been securely transferred.

Steps

1. Locate the TPM connector on the system board. For more information, see [System board connectors](#).
2. Press to hold the module down and remove the screw using the security Torx 8-bit shipped with the TPM module.
3. Slide the TPM module out from its connector.
4. Push the plastic rivet away from the TPM connector and rotate it 90° counterclockwise to release it from the system board.
5. Pull the plastic rivet out of its slot on the system board.

Installing the TPM

Steps

1. To install the TPM, align the edge connectors on the TPM with the slot on the TPM connector.
2. Insert the TPM into the TPM connector such that the plastic rivet aligns with the slot on the system board.
3. Press the plastic rivet until the rivet snaps into place.

4. Replace the screw that secures the TPM to the system board.

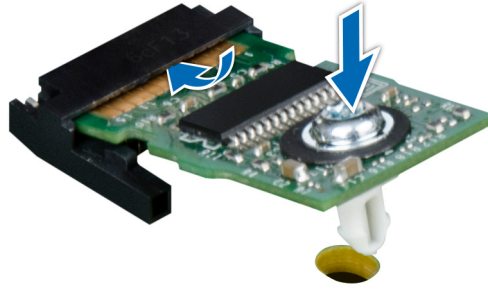

Figure 140. Installing the TPM

Initializing TPM for users

Steps

1. Initialize the TPM.
For more information, see [Initializing the TPM for users](#).
2. The **TPM Status** changes to **Enabled, Activated**.

Initializing the TPM 1.2 for users

Steps

1. While booting your system, press F2 to enter System Setup.
2. On the **System Setup Main Menu** screen, click **System BIOS > System Security Settings**.
3. From the **TPM Security** option, select **On with Preboot Measurements**.
4. From the **TPM Command** option, select **Activate**.
5. Save the settings.
6. Restart your system.

Initializing the TPM 2.0 for users

Steps

1. While booting your system, press F2 to enter System Setup.
2. On the **System Setup Main Menu** screen, click **System BIOS > System Security Settings**.
3. From the **TPM Security** option, select **On**.
4. Save the settings.
5. Restart your system.

LOM and rear IO card

Removing the rear Input Output card and LOM card

Prerequisites

1. Follow the safety guidelines listed in the [Safety instructions](#).

2. Follow the procedure listed in [Before working inside your system](#).
3. [Remove the system board](#).

Steps

1. Using a Phillips #2 screwdriver, remove the screws that secure the rear Input Output (RIO) card and LOM card to the system board.
2. Holding the edges, pull the RIO card and LOM card to disconnect from the connector on the system board.

i **NOTE:** The procedure to remove RIO on liquid cooling configuration is same.

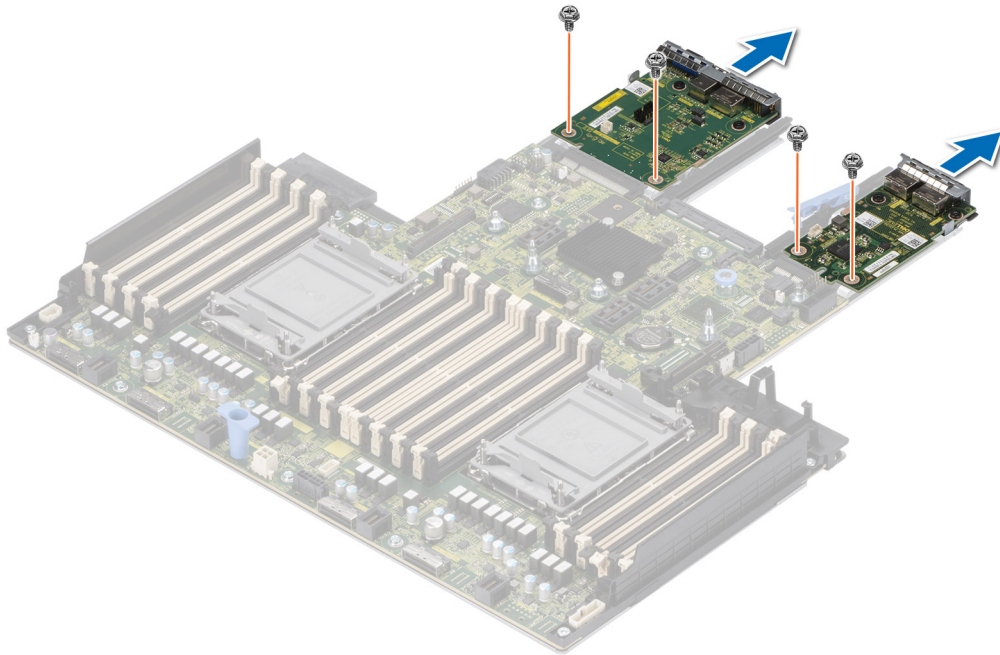

Figure 141. Removing the RIO card

Next steps

1. [Replace the RIO card and LOM card](#).

Installing the RIO card and LOM card

Prerequisites

1. Follow the safety guidelines listed in the [Safety instructions](#).
2. Follow the procedure listed in [Before working inside your system](#).
3. [Remove the system board](#).

i **NOTE:** Upgrading the system board with the liquid cooling solution requires the liquid cooling RIO card.

Steps

1. Align the connectors and slots on RIO card and LOM card with the connector and standoffs on the system board.
2. Press the RIO card and LOM card until firmly seated on the system board connector.
3. Using a Phillips #2 screwdriver, secure the RIO card and LOM card to the system board with the two screws.

i **NOTE:** The procedure to remove RIO on liquid cooling configuration is same.

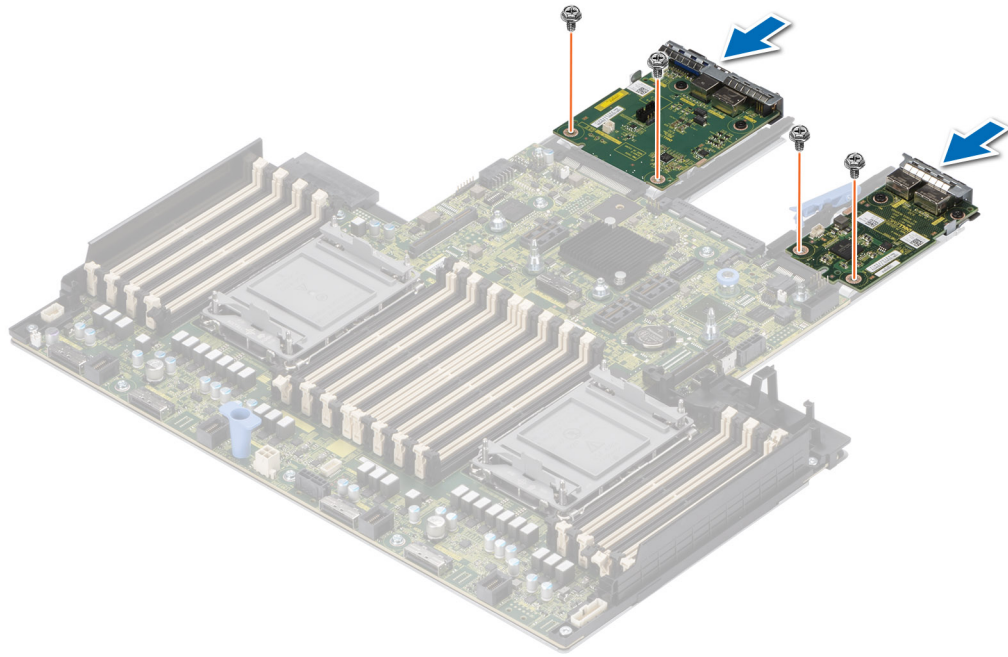

Figure 142. Installing the RIO card

Next steps

1. [Install the system board.](#)
2. Follow the procedure listed in [After working inside your system.](#)

Control panel

This is a service technician replaceable part only.

Removing the right control panel

Prerequisites

1. Follow the safety guidelines listed in the [Safety instructions.](#)
2. Follow the procedure listed in [Before working inside your system.](#)
3. [Remove the drive backplane cover.](#)
4. If installed, [remove the air shroud.](#)

Steps

1. Disconnect the right control panel cable from the connector on the system board.
2. Lift the latch, and slide the cable out of the clip.

NOTE: Observe the routing of the cable as you remove the right control panel from the system.

3. Using the Phillips #1 screwdriver, remove the screws that secure the right control panel to the system.
4. Holding the cable, slide the right control panel out of the system.

NOTE: The numbers on the image do not depict the exact steps. The numbers are for representation of sequence.

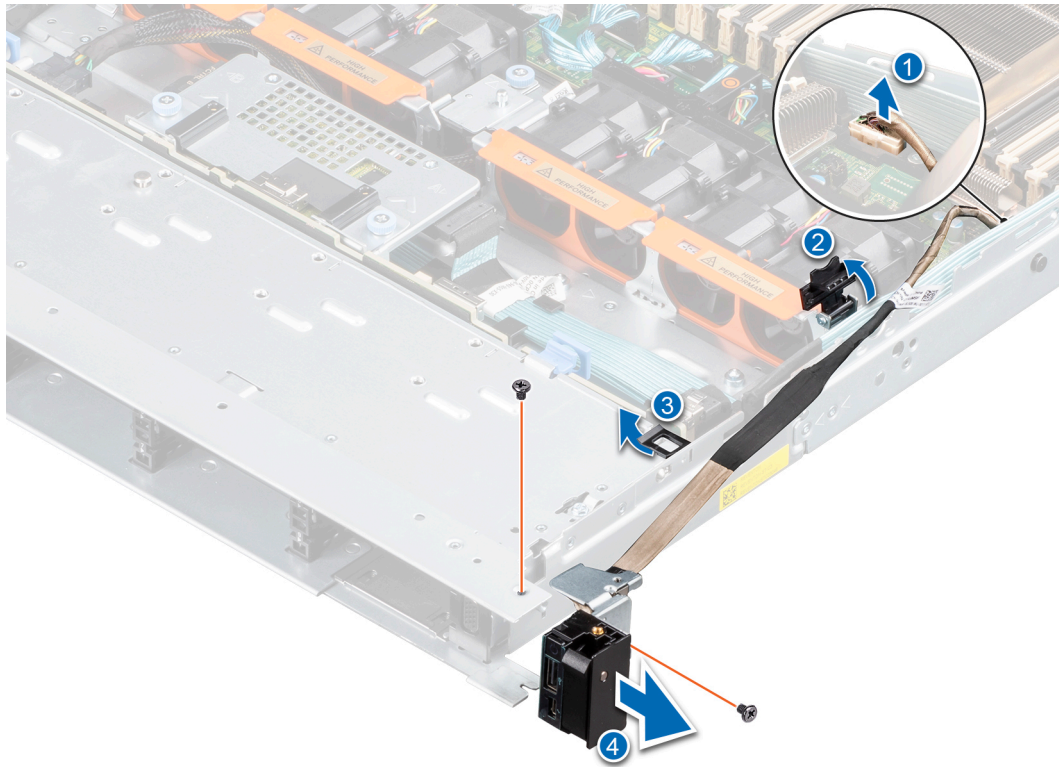

Figure 143. Removing the right control panel

Next steps

1. [Replace the right control panel.](#)

Installing the right control panel

Prerequisites

1. Follow the safety guidelines listed in the [Safety instructions](#).
2. Follow the procedure listed in [Before working inside your system](#).
3. [Remove the drive backplane cover](#).
4. If installed, [remove the air shroud](#).

Steps

1. Align and slide the right control panel in the slot on the system.
2. Connect the right control panel cable to the connector on the system board.
3. Route the right control panel cable through the side wall of the system. Close the cable latch and slide the cable into the clip.

NOTE: Route the cable properly to prevent the cable from being pinched or crimped.

4. Using the Phillips #1 screwdriver, tighten the screws that secure the right control panel to the system.

NOTE: The numbers on the image do not depict the exact steps. The numbers are for representation of sequence.

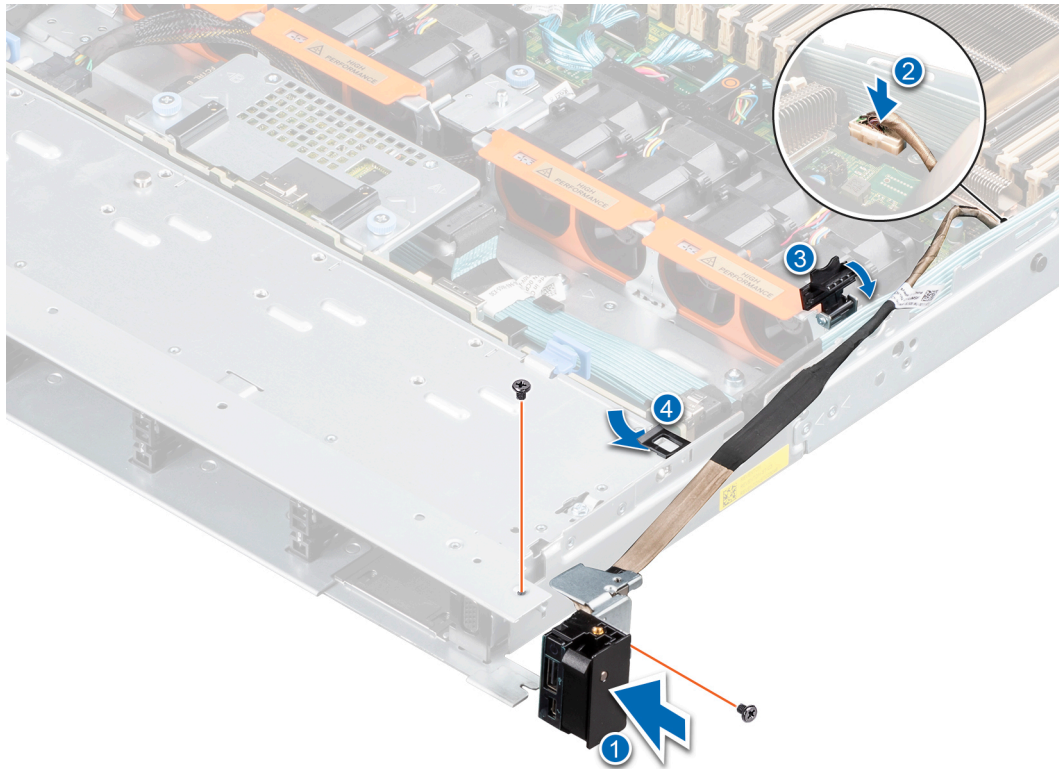

Figure 144. Installing the right control panel

Next steps

1. [Install the drive backplane cover.](#)
2. If applicable, [install the air shroud.](#)
3. Follow the procedure listed in [After working inside your system.](#)

Removing the left control panel

Prerequisites

1. Follow the safety guidelines listed in the [Safety instructions.](#)
2. Follow the procedure listed in [Before working inside your system.](#)
3. [Remove the drive backplane cover.](#)
4. If installed, [remove the air shroud.](#)

Steps

1. Disconnect the control panel cable from the connector on the system board.
2. Lift the latch to release the control panel cable and slide the cable from the clip.

NOTE: Observe the routing of the cable as you remove it from the system.

3. Using the Phillips #1 screwdriver, remove the screws that secure the left control panel to the system.
4. Hold the left control panel cable, and slide the left control panel out of the system.

NOTE: The numbers on the image do not depict the exact steps. The numbers are for representation of sequence.

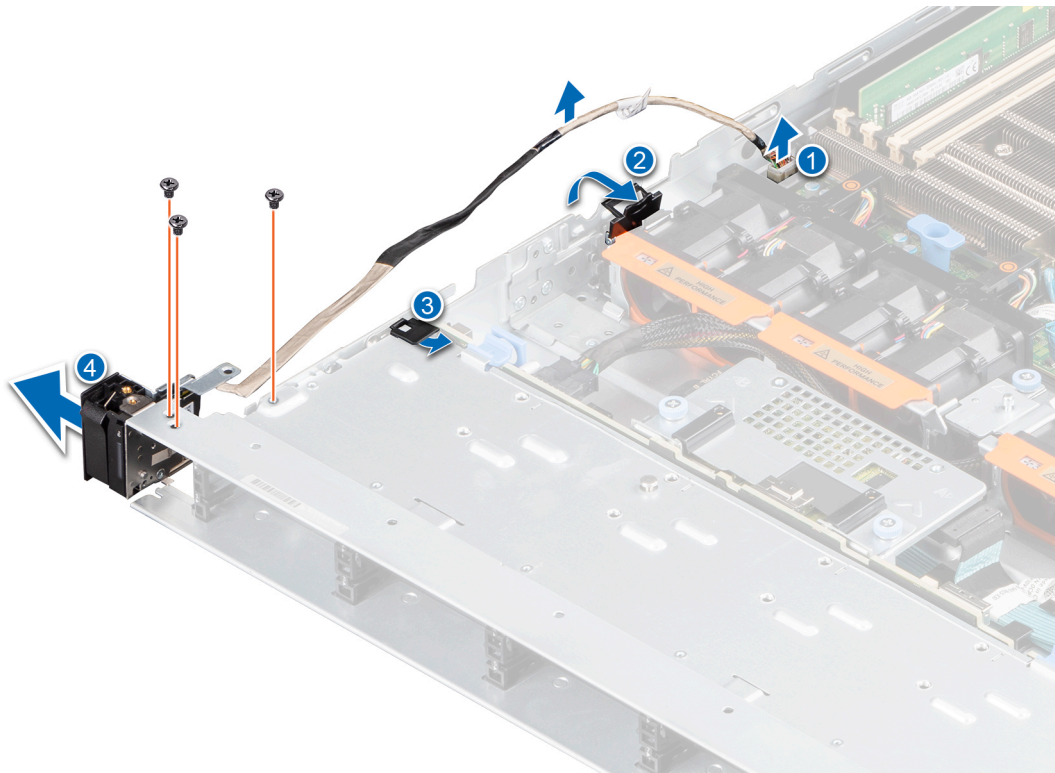

Figure 145. Removing the left control panel

Next steps

1. [Replace the left control panel.](#)

Installing the left control panel

Prerequisites

1. Follow the safety guidelines listed in the [Safety instructions](#).
2. Follow the procedure listed in [Before working inside your system](#).
3. [Remove the drive backplane cover](#).
4. If installed, [remove the air shroud](#).

Steps

1. Align and slide the left control panel in the slot on the system.
2. Connect the left control panel cable to the connector on the system board and secure it using cable latch.
3. Route the left control panel cable through the side wall of the system and slide the cable into the clip.

NOTE: Route the cable properly to prevent the cable from being pinched or crimped.

4. Using the Phillips #1 screwdriver, tighten the screws to secure the left control panel to the system.

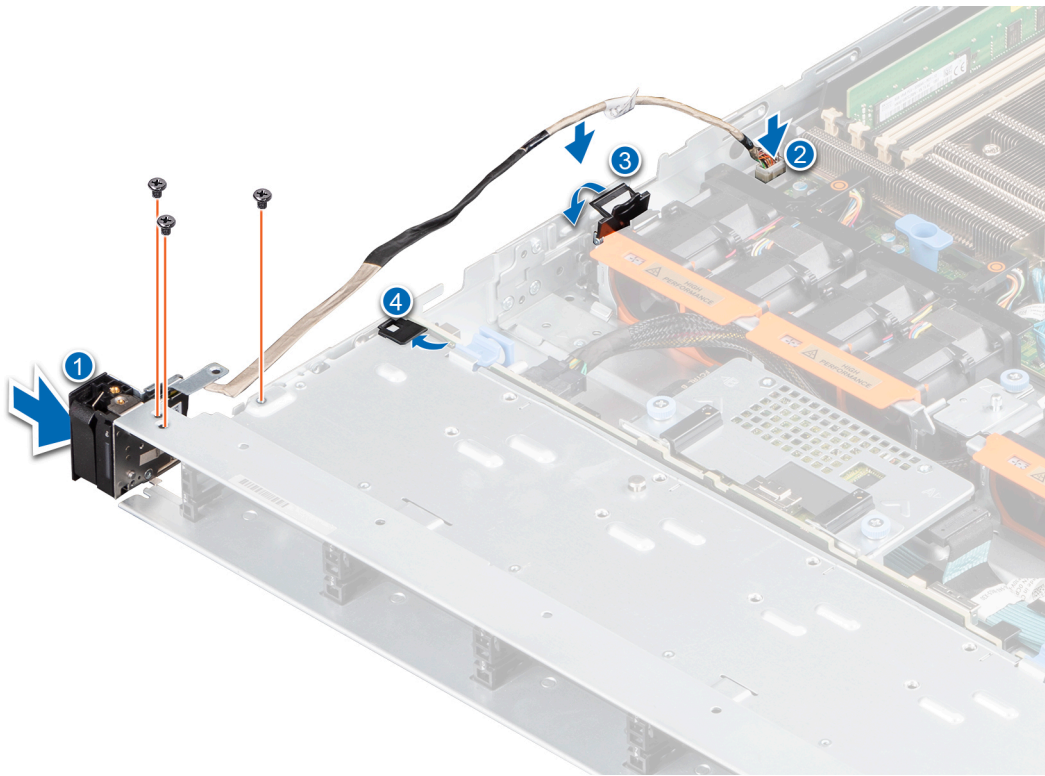

Figure 146. Installing the left control panel

Next steps

1. [Install the drive backplane cover.](#)
2. If applicable, [install the air shroud.](#)
3. Follow the procedure listed in [After working inside your system.](#)

Upgrade Kits

The table lists the available After Point Of Sale [APOS] kits.

Table 61. Upgrade kits

| Kits | Part number | Related links to service instructions | |
|---|---|--|---|
| Bezel | V7YM5/ W45M5 (LCD) | See Installing the front bezel | |
| BOSS S2 | FGNRW | See Installing the BOSS S2 controller card module | |
| Embedded management (IDSDM) | C2KCJ | See IDSDM kit | |
| Hard drives | NA | See Installing the drive | |
| Hard drives SSD | | See Installing the drive into the carrier | |
| Network cards (Standard PCIe adapter LP/FH) | | See Installing the LOM card and rear I/O board | |
| Network cards (OCP) | | See Installing the OCP card | |
| PCIe SSD card | | See Installing an expansion card into the expansion card riser | |
| Power cords | | NA | |
| Power supplies | | See Installing a power supply unit | |
| Quick sync | | 4F7T9 | NA |
| SD cards | | NA | See Installing the MicroSD card |
| TPM | See Upgrading the Trusted Platform Module | | |
| Processor enablement thermal kits | See Installing the processor | | |
| Internal USB 3.0 card | C19XC | See Internal USB card kit | |
| Serial COM port daughter card | DDN4N | See Installing the serial COM port | |

Topics:

- [Management Interface Card \(MIC\) kit](#)
- [BOSS S2 kit](#)
- [IDSDM kit](#)
- [Internal USB card kit](#)
- [VGA port kit](#)
- [Serial COM port kit](#)

Management Interface Card (MIC) kit

The Management Interface Card (MIC) is a small card designed to enable NC-SI communication with the server BMC. The MIC needs to be plugged in the LOM slot of the server and connects to the BMC NC-SI instead of the LOM.

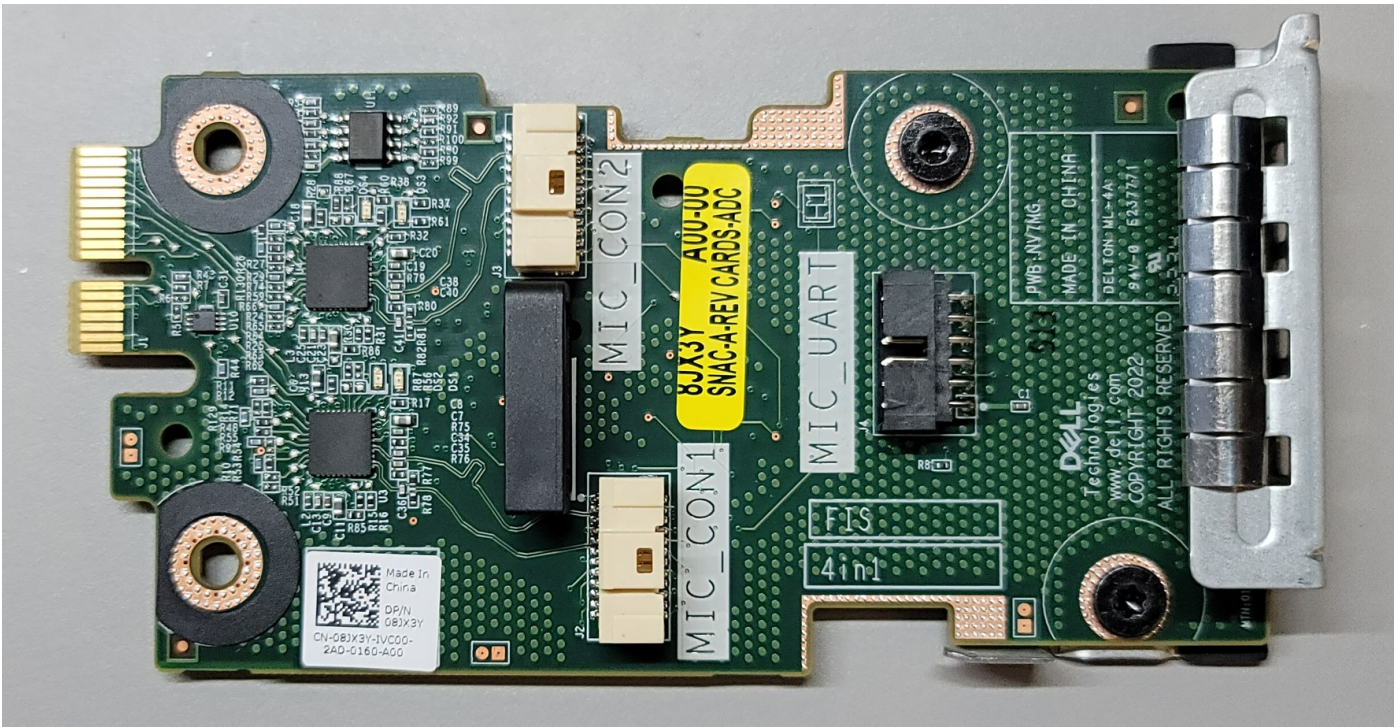

Figure 147. Management Interface Card (MIC)

The Management Interface Card (MIC) has three connectors. One connector, silkscreened UART, for the UART cable connecting the MIC Card and the Rear IO board, and two connectors, silkscreened SN1 and SN2, for the NC-SI MIC cables connecting the MIC card to each DPU. See the [cable routing diagram](#) for MIC for more information.

Removing and installing the MIC

The removal and installation steps for the MIC is similar to any other expansion cards on riser 1. Please see the [remove](#) and [install](#) steps of the expansion cards on riser 1 for more information.

BOSS S2 kit

The BOSS S2 supports up to two M.2 SSDs.

NOTE: To enable the BOSS S2 in the system, ensure that the BIOS firmware version is 1.1.4 and iDRAC firmware version is 4.40.20.00 or later.

Before you begin the installation or removal process, follow the [Safety instructions](#) and [Before working inside your system](#) instructions.

Table 62. BOSS S2 kit components

| R6525 (quantity) | Components in kit |
|------------------|--------------------------------|
| 1 | BOSS cover |
| 3 | M3 x 0.05 x 4.5 mm screws |
| 1 | BOSS signal cable |
| 1 | BOSS power cable |
| 1 | BOSS-S2 controller card module |
| 1 or 2* | BOSS-S2 card carrier |

Table 62. BOSS S2 kit components (continued)

| R6525 (quantity) | Components in kit |
|-------------------------|------------------------------|
| 1 or 2* | M.2 SSD |
| 2 | M.2 240 GB information label |
| 2 | M.2 480 GB information label |
| 1 | BOSS card filler |
| 1 | Tech sheet |

For more information on removal and installation of BOSS S2 bland and card see [optional BOSS S2 module](#) topic.

- i** **NOTE:** Installing the BOSS S2 card carrier does not require the system to be powered off. System shutdown is only required when installing the BOSS S2 controller card module.
- i** **NOTE:** Connect the BOSS signal cable and BOSS power cable after inserting the BOSS S2 controller card module into the system.
- i** **NOTE:** Removal of the BOSS S2 card carrier does not require the system to be powered off. System shutdown is only required when removing the BOSS S2 controller card module.
- i** **NOTE:** Disconnect the BOSS signal cable and the BOSS power cable before lifting the controller card module from the system.

IDSDM kit

The IDSDM kit contains one IDSDM card. For installation procedure of IDSDM, see [optional IDSDM module](#) section.

Internal USB card kit

The internal USB card kit contains one internal USB card. For installation of internal USB card, see [internal USB card](#) section.

VGA port kit

The VGA port kit contains the components listed in the table.

Table 63. VGA port kit

| Components | Quantity |
|---------------|----------|
| VGA port card | 1 |
| Cable | 1 |

For installation procedure of the VGA port, see [VGA port section](#).

Serial COM port kit

The serial COM port kit contains the components listed in the table.

Table 64. Serial COM port kit

| Components | Quantity |
|----------------------|----------|
| Serial COM port card | 1 |
| Cable | 1 |

For installation procedure of the serial COM port, see the [serial COM port](#) section.

Jumpers and connectors

This section provides essential and specific information about jumpers and switches. It also describes the connectors on the various boards in the system. Jumpers on the system board help to disable the system and reset the passwords. To install components and cables correctly, you must be able to identify the connectors on the system board.

Topics:

- [System board connectors](#)
- [System board jumper settings](#)
- [Disabling a forgotten password](#)

System board connectors

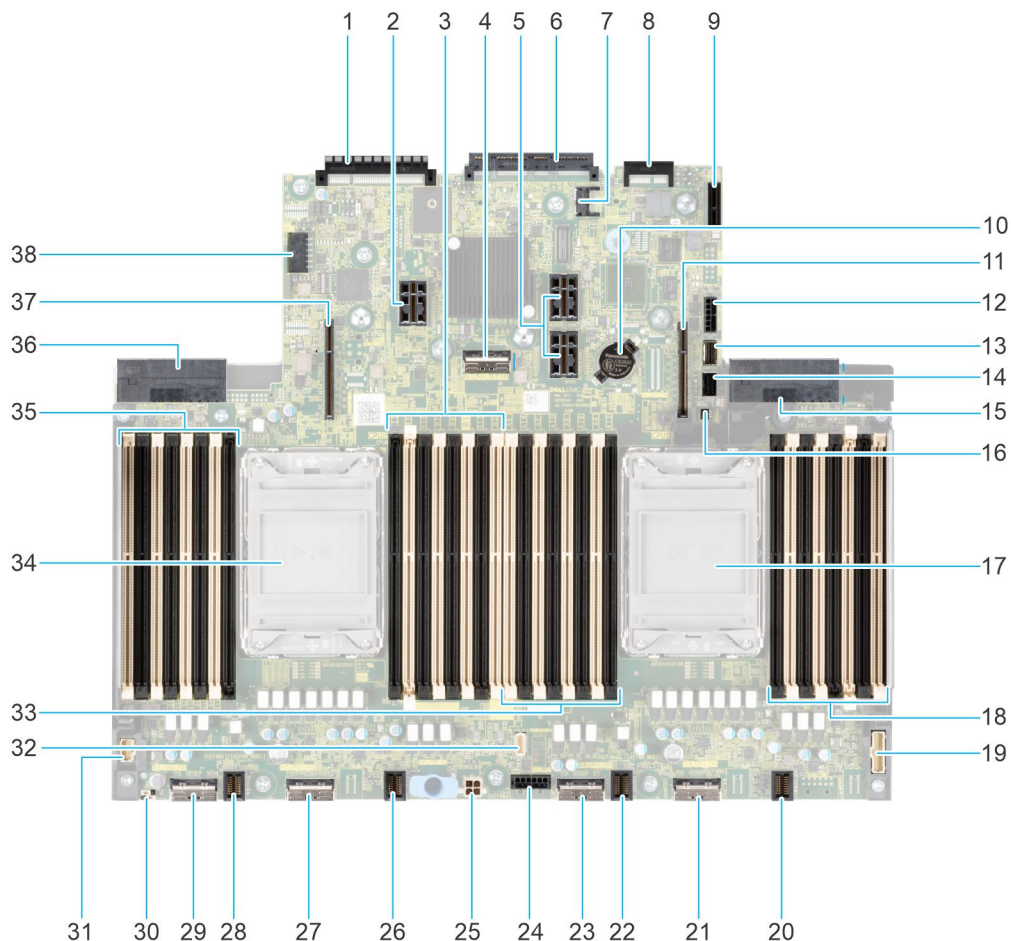

Figure 148. System board jumpers and connectors

Table 65. System board jumpers and connectors

| Item | Connector | Description |
|------|--------------------|--------------------|
| 1. | Rear I/O connector | Rear I/O connector |
| 2. | IO_RISER3 (CPU2) | Riser 3 |





Table 65. System board jumpers and connectors (continued)

| Item | Connector | Description |
|-------------|------------------------------------|--|
| 3. | B11, B3, B15, B7, B9, B1, B13, B5 | DIMM for processor 2 channels A, B, C, D |
| 4. | SL5_PCH_SA3_PA3 | SATA Connector 5 |
| 5. | IO_RISER2 (CPU2) | Riser 2 |
| 6. | OCP NIC 3.0 connector | OCP NIC 3.0 connector |
| 7. | J_TPM | TPM connector |
| 8. | LOM connector | LOM connector |
| 9. | IDSDM/Internal USB connector | IDSDM/Internal USB connector |
| 10. | Coin cell battery | Coin cell battery |
| 11. | IO_RISER1 (CPU1) | Riser 1 |
| 12. | SIG_PWR_0 | Power connector 0 - use for GPU only/ Rear BP |
| 13. | SL6_PCH_PA4 | TPM connector |
| 14. | FRONT_VIDEO | Front VGA |
| 15. | PSU 1 | PSU 1 |
| 16. | BOSS_PWR | BOSS card power |
| 17. | CPU 1 | Processor 1 |
| 18. | A11, A3, A15, A7, A9, A1, A13, A5 | DIMM for CPU 1 channels A, B, C, D |
| 19. | RGT_CP | Right control panel connector |
| 20. | 1U[FAN4] | Fan 4 |
| 21. | SL4_CPU1_PA2 | PCIe Connector 4 |
| 22. | 1U[FAN3] | Fan 3 |
| 23. | SL3_CPU1_PB2 | PCIe Connector 3 |
| 24. | SIG_PWR_1 | Power connector 1 - for BP only |
| 25. | NVDIMM battery power | NVDIMM battery power connector |
| 26. | 1U[FAN2] | Fan 2 |
| 27. | SL2_CPU2_PA1 | Power connector 2 - use for BP only |
| 28. | 1U[FAN1] | Fan 1 |
| 29. | SL1_CPU2_PB1 | PCIe connector 1 |
| 30. | J_PSWD_NVRAM | NVRAM_CLR |
| 31. | LFT_CP | Left control panel connector |
| 32. | NVDIMM battery signal | NVDIMM battery signal |
| 33. | A6, A14, A2, A10, A8, A16, A4, A12 | DIMMs for CPU 1 channels E, F, G, H |
| 34. | CPU 2 | Processor 2 |
| 35. | B6, B14, B2, B10, B8, B16, B4, B12 | DIMMs for CPU 2 channels E, F, G, H |
| 36. | PSU 2 | PSU 2 |
| 37. | IO_RISER4 (CPU2) | Riser 4 |
| 38. | SIG_PWR_3 | Power connector 3- use for GPU only |

System board jumper settings

For information about resetting the password jumper to disable a password, see the [Disabling a forgotten password](#) section.

Table 66. System board jumper settings

| Jumper | Setting | Description |
|-----------|---|---|
| PWRD_EN |  2 4 6 (default) | The BIOS password feature is enabled. |
| |  2 4 6 | The BIOS password feature is disabled. The BIOS password is now disabled and you are not allowed to set a new password. |
| NVRAM_CLR |  1 3 5 (default) | The BIOS configuration settings are retained at system boot. |
| |  1 3 5 | The BIOS configuration settings are cleared at system boot. |

CAUTION: You should be cautious when changing the BIOS settings. The BIOS interface is designed for advanced users. Any changes in the setting might prevent your system from starting correctly and may even result in data loss.

Disabling a forgotten password

The software security features of the system include a system password and a setup password. The password jumper enables or disables password features and clears any password(s) currently in use.

Prerequisites

CAUTION: Many repairs may only be done by a certified service technician. You should only perform troubleshooting and simple repairs as authorized in your product documentation, or as directed by the online or telephone service and support team. Damage due to servicing that is not authorized by Dell is not covered by your warranty. Read and follow the safety instructions that are shipped with your product.

Steps

- Power off the system and all attached peripherals. Disconnect the system from the electrical outlet, and disconnect the peripherals.
- Remove the system cover.
- Move the jumper on the system board from pins 2 and 4 to pins 4 and 6.
- Replace the system cover.
 - NOTE:** The existing passwords are not disabled (erased) until the system boots with the jumper on pins 4 and 6. However, before you assign a new system and/or setup password, you must move the jumper back to pins 2 and 4.
 - NOTE:** If you assign a new system and/or setup password with the jumper on pins 4 and 6, the system disables the new password(s) the next time it boots.
- Reconnect the peripherals and connect the system to the electrical outlet, and then power on the system.
- Power off the system.
- Remove the system cover.
- Move the jumper on the system board from pins 4 and 6 to pins 2 and 4.
- Replace the system cover.
- Reconnect the peripherals and connect the system to the electrical outlet, and then power on the system.
- Assign a new system and/or setup password.

System diagnostics and indicator codes

This section describes the diagnostic indicators on the system front panel that displays the system status during system startup.

Topics:

- Status LED indicators
- System health and system ID indicator codes
- iDRAC Quick Sync 2 indicator codes
- iDRAC Direct LED indicator codes
- LCD panel
- NIC indicator codes
- Power supply unit indicator codes
- Drive indicator codes
- Using system diagnostics

Status LED indicators

 **NOTE:** The indicators display solid amber if any error occurs.

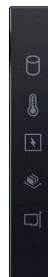

Figure 149. Status LED indicators

Table 67. Status LED indicators and descriptions





| Icon | Description | Condition | Corrective action |
|---|-----------------------|---|--|
|  | Drive indicator | The indicator turns solid amber if there is a drive error. | <ul style="list-style-type: none"> • Check the System Event Log to determine if the drive has an error. • Run the appropriate Online Diagnostics test. Restart the system and run embedded diagnostics (ePSA). • If the drives are configured in a RAID array, restart the system, and enter the host adapter configuration utility program. |
|  | Temperature indicator | The indicator turns solid amber if the system experiences a thermal error (for example, the ambient temperature is out of range or there is a fan failure). | <p>Ensure that none of the following conditions exist:</p> <ul style="list-style-type: none"> • A cooling fan has been removed or has failed. • System cover, air shrouds, or back filler bracket has been removed. • Ambient temperature is too high. • External airflow is obstructed. <p>If the problem persists, see the Getting help section.</p> |

Table 67. Status LED indicators and descriptions (continued)

| Icon | Description | Condition | Corrective action |
|---|----------------------|--|---|
|  | Electrical indicator | The indicator turns solid amber if the system experiences an electrical error (for example, voltage out of range, or a failed power supply unit (PSU) or voltage regulator). | Check the System Event Log or system messages for the specific issue. If it is due to a problem with the PSU, check the LED on the PSU. Reseat the PSU. If the problem persists, see the Getting help section. |
|  | Memory indicator | The indicator turns solid amber if a memory error occurs. | Check the System Event Log or system messages for the location of the failed memory. Reseat the memory module. If the problem persists, see the Getting help section. |
|  | PCIe indicator | The indicator turns solid amber if a PCIe card experiences an error. | Restart the system. Update any required drivers for the PCIe card. Reinstall the card. If the problem persists, see the Getting help section. NOTE: For more information about the supported PCIe cards, see the Expansion card installation guidelines section. |

System health and system ID indicator codes

The system health and system ID indicator is located on the left control panel of the system.



Figure 150. System health and system ID indicator

Table 68. System health and system ID indicator codes

| System health and system ID indicator code | Condition |
|--|---|
| Solid blue | Indicates that the system is powered on, is healthy, and system ID mode is not active. Press the system health and system ID button to switch to system ID mode. |
| Blinking blue | Indicates that the system ID mode is active. Press the system health and system ID button to switch to system health mode. |
| Solid amber | Indicates that the system is in fail-safe mode. If the problem persists, see the Getting help section. |
| Blinking amber | Indicates that the system is experiencing a fault. Check the System Event Log for specific error messages. For information about the event and error messages generated by the system firmware and agents that monitor system components, go to qrl.dell.com > Look Up > Error Code , type the error code, and then click Look it up . |

iDRAC Quick Sync 2 indicator codes

iDRAC Quick Sync 2 module (optional) is located on the left control panel of the system.



Table 69. iDRAC Quick Sync 2 indicators and descriptions

| iDRAC Quick Sync 2 indicator code | Condition | Corrective action |
|---|---|---|
| Off (default state) | Indicates that the iDRAC Quick Sync 2 feature is powered off. Press the iDRAC Quick Sync 2 button to power on the iDRAC Quick Sync 2 feature. | If the LED fails to power on, reseal the left control panel flex cable and check. If the problem persists, see the Getting help section. |
| Solid white | Indicates that iDRAC Quick Sync 2 is ready to communicate. Press the iDRAC Quick Sync 2 button to power off. | If the LED fails to power off, restart the system. If the problem persists, see the Getting help section. |
| Blinks white rapidly | Indicates data transfer activity. | If the indicator continues to blink indefinitely, see the Getting help section. |
| Blinks white slowly | Indicates that firmware update is in progress. | If the indicator continues to blink indefinitely, see the Getting help section. |
| Blinks white five times rapidly and then powers off | Indicates that the iDRAC Quick Sync 2 feature is disabled. | Check if iDRAC Quick Sync 2 feature is configured to be disabled by iDRAC. If the problem persists, see the Getting help section. www.dell.com/poweredge/manuals or <i>Dell OpenManage Server Administrator User's Guide</i> at https://www.dell.com/openmanagemanuals . |
| Solid amber | Indicates that the system is in fail-safe mode. | Restart the system. If the problem persists, see the Getting help section. |
| Blinking amber | Indicates that the iDRAC Quick Sync 2 hardware is not responding properly. | Restart the system. If the problem persists, see the Getting help section. |

iDRAC Direct LED indicator codes

The iDRAC Direct LED indicator lights up to indicate that the port is connected and is being used as a part of the iDRAC subsystem.

You can configure iDRAC Direct by using a USB to micro USB (type AB) cable, which you can connect to your laptop or tablet. Cable length should not exceed 3 feet (0.91 meters). Performance could be affected by cable quality. The following table describes iDRAC Direct activity when the iDRAC Direct port is active:

Table 70. iDRAC Direct LED indicator codes

| iDRAC Direct LED indicator code | Condition |
|---|--|
| Solid green for two seconds | Indicates that the laptop or tablet is connected. |
| Blinking green (on for two seconds and off for two seconds) | Indicates that the laptop or tablet connected is recognized. |

Table 70. iDRAC Direct LED indicator codes (continued)

| iDRAC Direct LED indicator code | Condition |
|---------------------------------|---|
| LED Indicator off | Indicates that the laptop or tablet is unplugged. |

LCD panel

The LCD panel provides system information, status, and error messages to indicate if the system is functioning correctly or requires attention. The LCD panel is used to configure or view the iDRAC IP address of the system. For information about the event and error messages generated by the system firmware and agents that monitor system components, go to qrl.dell.com >

Look Up > Error Code, type the error code, and then click **Look it up**.

The LCD panel is available only on the optional front bezel. The optional front bezel is hot pluggable.

The status and conditions of the LCD panel are outlined here:

- The LCD backlight is white during normal operating conditions.
- If there is an issue, the LCD backlight turns amber and displays an error code followed by descriptive text.
 - ⓘ **NOTE:** If the system is connected to a power source and an error is detected, the LCD turns amber regardless of whether the system is powered on or off.
- When the system powers off and there are no errors, the LCD enters the standby mode after five minutes of inactivity. Press any button on the LCD to power it on.
- If the LCD panel stops responding, remove the bezel and reinstall it.
 - If the problem persists, see [Getting help](#).
- The LCD backlight remains off if LCD messaging is powered off using the iDRAC utility, the LCD panel, or other tools.

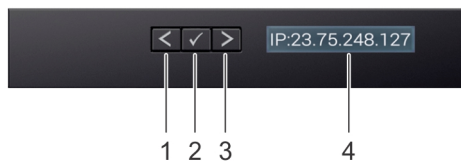

Figure 151. LCD panel features



Table 71. LCD panel features

| Item | Button or display | Description |
|------|-------------------|---|
| 1 | Left | Moves the cursor back in one-step increments. |
| 2 | Select | Selects the menu item highlighted by the cursor. |
| 3 | Right | Moves the cursor forward in one-step increments. During message scrolling: <ul style="list-style-type: none"> • Press and hold the right button to increase scrolling speed. • Release the button to stop. ⓘ NOTE: The display stops scrolling when the button is released. After 45 seconds of inactivity, the display starts scrolling. |
| 4 | LCD display | Displays the system information, status, and error messages or iDRAC IP address. |

Viewing Home screen

The **Home** screen displays user-configurable information about the system. This screen is displayed during normal system operation when there are no status messages or errors. When the system turns off and there are no errors, LCD enters the standby mode after five minutes of inactivity. Press any button on the LCD to turn it on.

Steps

1. To view the **Home** screen, press one of the three navigation buttons (Select, Left, or Right).
2. To navigate to the **Home** screen from another menu, complete the following steps:
 - a. Press and hold the navigation button till the up arrow  is displayed.
 - b. Navigate to the **Home** icon  using the up arrow .
 - c. Select the **Home** icon.
 - d. On the **Home** screen, press the **Select** button to enter the main menu.

Setup menu

 **NOTE:** When you select an option in the Setup menu, you must confirm the option before proceeding to the next action.

Table 72. Setup menu

| Option | Description |
|-----------|--|
| iDRAC | Select DHCP or Static IP to configure the network mode. If Static IP is selected, the available fields are IP , Subnet (Sub) , and Gateway (Gtw) . Select Setup DNS to enable DNS and to view domain addresses. Two separate DNS entries are available. |
| Set error | Select SEL to view LCD error messages in a format that matches the IPMI description in the SEL. This enables you to match an LCD message with an SEL entry. Select Simple to view LCD error messages in a simplified user-friendly description. For information about the event and error messages generated by the system firmware and agents that monitor system components, go to qrl.dell.com > Look Up > Error Code , type the error code, and then click Look it up . |
| Set home | Select the default information to be displayed on the Home screen. See View menu section for the options and option items that can be set as the default on the Home screen. |

View menu

 **NOTE:** When you select an option in the View menu, you must confirm the option before proceeding to the next action.

Table 73. View menu

| Option | Description |
|-------------|--|
| iDRAC IP | Displays the IPv4 or IPv6 addresses for iDRAC9. Addresses include DNS (Primary and Secondary) , Gateway, IP , and Subnet (IPv6 does not have Subnet). |
| MAC | Displays the MAC addresses for iDRAC , iSCSI , or Network devices. |
| Name | Displays the name of the Host , Model , or User String for the system. |
| Number | Displays the Asset tag or the Service tag for the system. |
| Power | Displays the power output of the system in BTU/hr or Watts. The display format can be configured in the Set home submenu of the Setup menu. |
| Temperature | Displays the temperature of the system in Celsius or Fahrenheit. The display format can be configured in the Set home submenu of the Setup menu. |

NIC indicator codes

Each NIC on the back of the system has indicators that provide information about the activity and link status. The activity LED indicator indicates if data is flowing through the NIC, and the link LED indicator indicates the speed of the connected network.

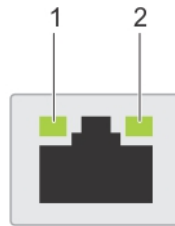

Figure 152. NIC indicator codes

1. Link LED indicator
2. Activity LED indicator

Table 74. NIC indicator codes

| NIC indicator codes | Condition |
|--|---|
| Link and activity indicators are off. | Indicates that the NIC is not connected to the network. |
| Link indicator is green, and activity indicator is blinking green. | Indicates that the NIC is connected to a valid network at its maximum port speed, and data is being sent or received. |
| Link indicator is amber, and activity indicator is blinking green. | Indicates that the NIC is connected to a valid network at less than its maximum port speed, and data is being sent or received. |
| Link indicator is green, and activity indicator is off. | Indicates that the NIC is connected to a valid network at its maximum port speed, and data is not being sent or received. |
| Link indicator is amber, and activity indicator is off. | Indicates that the NIC is connected to a valid network at less than its maximum port speed, and data is not being sent or received. |
| Link indicator is blinking green, and activity is off. | Indicates that the NIC identity is enabled through the NIC configuration utility. |

Power supply unit indicator codes

AC and DC power supply units (PSUs) have an illuminated translucent handle that serves as an indicator. The indicator shows if power is present or if a power fault has occurred.

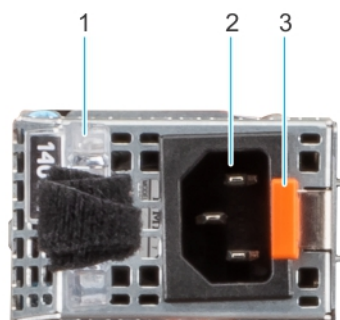

Figure 153. AC PSU status indicator

1. AC PSU handle
2. Socket
3. Release latch

Table 75. AC and DC PSU status indicator codes

| Power indicator codes | Condition |
|-------------------------------|--|
| Green | Indicates that a valid power source is connected to the PSU and the PSU is operational. |
| Blinking amber | Indicates an issue with the PSU. |
| Not powered on | Indicates that the power is not connected to the PSU. |
| Blinking green | Indicates that the firmware of the PSU is being updated. |
| | <p>△ CAUTION: Do not disconnect the power cord or unplug the PSU when updating firmware. If firmware update is interrupted, the PSUs will not function.</p> |
| Blinking green and powers off | <p>When hot-plugging a PSU, it blinks green five times at a rate of 4 Hz and powers off. This indicates a PSU mismatch due to efficiency, feature set, health status, or supported voltage.</p> |
| | <p>△ CAUTION: If two PSUs are installed, both the PSUs must have the same type of label; for example, Extended Power Performance (EPP) label. Mixing PSUs from previous generations of PowerEdge servers is not supported, even if the PSUs have the same power rating. This results in a PSU mismatch condition or failure to power on the system.</p> |
| | <p>△ CAUTION: If two PSUs are used, they must be of the same type and have the same maximum output power.</p> |
| | <p>△ CAUTION: When correcting a PSU mismatch, replace the PSU with the blinking indicator. Swapping the PSU to make a matched pair can result in an error condition and an unexpected system shutdown. To change from a high output configuration to a low output configuration or vice versa, you must power off the system.</p> |
| | <p>△ CAUTION: When two identical PSUs receive different input voltages, they can output different wattage, and trigger a mismatch.</p> |
| | <p><i>For example a 1100W PSU connected to a High-Line AC (HLAC) 200Vac-240Vac input, it will output 1100W. But if a second 1100W PSU in the same system is connected to a Low Line 100-120Vac input, it will only output 1050W, triggering a mismatch.</i></p> |

Drive indicator codes

The LEDs on the drive carrier indicate the state of each drive. Each drive carrier has two LEDs: an activity LED (green) and a status LED (bicolor, green/amber). The activity LED blinks whenever the drive is accessed.



Figure 154. Drive indicators

1. Drive activity LED indicator
2. Drive status LED indicator
3. Drive capacity label

NOTE: If the drive is in the Advanced Host Controller Interface (AHCI) mode, the status LED indicator does not power on.

NOTE: Drive status indicator behavior is managed by Storage Spaces Direct. Not all drive status indicators may be used.

Table 76. Drive indicator codes

| Drive status indicator code | Condition |
|--|---|
| Blinks green twice per second | Indicates that the drive is being identified or preparing for removal. |
| Off | Indicates that the drive is ready for removal. NOTE: The drive status indicator remains off until all drives are initialized after the system is powered on. Drives are not ready for removal during this time. |
| Blinks green, amber, and then powers off | Indicates that there is an unexpected drive failure. |
| Blinks amber four times per second | Indicates that the drive has failed. |
| Blinks green slowly | Indicates that the drive is rebuilding. |
| Solid green | Indicates that the drive is online. |
| Blinks green for three seconds, amber for three seconds, and then powers off after six seconds | Indicates that the rebuild has stopped. |

Using system diagnostics

If you experience an issue with the system, run the system diagnostics before contacting Dell Technologies for technical assistance. The purpose of running system diagnostics is to test the system hardware without using additional equipment or risking data loss. If you are unable to fix the issue yourself, service and support personnel can use the diagnostics results to help you solve the issue.

Dell Embedded System Diagnostics

NOTE: The Dell Embedded System Diagnostics is also known as Enhanced Pre-boot System Assessment (ePSA) diagnostics.

The Embedded System Diagnostics provide a set of options for particular device groups or devices allowing you to:

- Run tests automatically or in an interactive mode
- Repeat tests

- Display or save test results
- Run thorough tests to introduce additional test options to provide extra information about the failed device(s)
- View status messages that inform you if tests are completed successfully
- View error messages that inform you of issues encountered during testing

Running the Embedded System Diagnostics from the Dell Lifecycle Controller

Steps

1. When the system is booting, press F10.
2. Select **Hardware Diagnostics** → **Run Hardware Diagnostics**.
The **ePSA Pre-boot System Assessment** window is displayed, listing all devices detected in the system. The diagnostics start executing the tests on all the detected devices.

Running the Embedded System Diagnostics from Boot Manager

Run the Embedded System Diagnostics (ePSA) if your system does not boot.

Steps

1. When the system is booting, press F11.
2. Use the up arrow and down arrow keys to select **System Utilities** > **Launch Diagnostics**.
3. Alternatively, when the system is booting, press F10, select **Hardware Diagnostics** > **Run Hardware Diagnostics**.
The **ePSA Pre-boot System Assessment** window is displayed, listing all devices detected in the system. The diagnostics starts executing the tests on all the detected devices.

System diagnostic controls

Table 77. System diagnostic controls

| Menu | Description |
|----------------------|---|
| Configuration | Displays the configuration and status information of all detected devices. |
| Results | Displays the results of all tests that are run. |
| System health | Provides the current overview of the system performance. |
| Event log | Displays a time-stamped log of the results of all tests run on the system. This is displayed if at least one event description is recorded. |

Getting help

Topics:

- [Recycling or End-of-Life service information](#)
- [Contacting Dell Technologies](#)
- [Accessing system information by using QRL](#)
- [Receiving automated support with SupportAssist](#)

Recycling or End-of-Life service information

Take back and recycling services are offered for this product in certain countries. If you want to dispose of system components, visit www.dell.com/recyclingworldwide and select the relevant country.

Contacting Dell Technologies

Dell provides online and telephone based support and service options. If you do not have an active internet connection, you can find Dell contact information on your purchase invoice, packing slip, bill or Dell product catalog. The availability of services varies depending on the country and product, and some services may not be available in your area. To contact Dell for sales, technical assistance, or customer service issues follow these steps:

Steps

1. Go to www.dell.com/support/home.
2. Select your country from the drop-down menu on the lower right corner of the page.
3. For customized support:
 - a. Enter the system Service Tag in the **Enter a Service Tag, Serial Number, Service Request, Model, or Keyword** field.
 - b. Click **Search**.
The support page that lists the various support categories is displayed.
4. For general support:
 - a. Select your product category.
 - b. Select your product segment.
 - c. Select your product.
The support page that lists the various support categories is displayed.
5. For contact details of Dell Global Technical Support:
 - a. Click [Contact Technical Support](#).
 - b. The **Contact Technical Support** page is displayed with details to call, chat, or e-mail the Dell Global Technical Support team.

Accessing system information by using QRL

You can use the Quick Resource Locator (QRL) located on the information tag in the front of the R650 system, to access information about Dell Technologies PowerEdge R650. There is also another QRL for accessing product information located on the back of the system cover.

Prerequisites

Ensure that your smartphone or tablet has a QR code scanner installed.

The QRL includes the following information about your system:

- How-to videos
- Reference materials, including the Installation and Service Manual, LCD diagnostics, and mechanical overview
- The system service tag to quickly access the specific hardware configuration and warranty information
- A direct link to Dell to contact technical assistance and sales teams

Steps

1. Go to www.dell.com/qrl, and navigate to your specific product or
2. Use your smart phone or tablet to scan the model-specific Quick Resource (QR) code on your system or in the Quick Resource Locator section.

Quick Resource Locator for PowerEdge R650 system



Figure 155. Quick Resource Locator for PowerEdge R650 system

Receiving automated support with SupportAssist

Dell EMC SupportAssist is an optional Dell EMC Services offering that automates technical support for your Dell EMC server, storage, and networking devices. By installing and setting up a SupportAssist application in your IT environment, you can receive the following benefits:

- Automated issue detection — SupportAssist monitors your Dell EMC devices and automatically detects hardware issues, both proactively and predictively.
- Automated case creation — When an issue is detected, SupportAssist automatically opens a support case with Dell EMC Technical Support.
- Automated diagnostic collection — SupportAssist automatically collects system state information from your devices and uploads it securely to Dell EMC. This information is used by Dell EMC Technical Support to troubleshoot the issue.
- Proactive contact — A Dell EMC Technical Support agent contacts you about the support case and helps you resolve the issue.

The available benefits vary depending on the Dell EMC Service entitlement purchased for your device. For more information about SupportAssist, go to www.dell.com/supportassist.

Documentation resources

This section provides information about the documentation resources for your system.

To view the document that is listed in the documentation resources table:

- From the Dell Technologies support site:
 1. Click the documentation link that is provided in the Location column in the table.
 2. Click the required product or product version.
-  **NOTE:** To locate the model number, see the front of your system.
- 3. On the Product Support page, click **Documentation**.
- Using search engines:
 - Type the name and version of the document in the search box.

Table 78. Additional documentation resources for your system

| Task | Document | Location |
|-------------------------|--|--|
| Setting up your system | <p>For more information about installing and securing the system into a rack, see the Rail Installation Guide included with your rail solution.</p> <p>For information about setting up your system, see the <i>Getting Started Guide</i> document that is shipped with your system.</p> | www.dell.com/poweredgemanuals |
| Configuring your system | <p>For information about the iDRAC features, configuring and logging in to iDRAC, and managing your system remotely, see the Integrated Dell Remote Access Controller User's Guide.</p> <p>For information about understanding Remote Access Controller Admin (RACADM) subcommands and supported RACADM interfaces, see the RACADM CLI Guide for iDRAC.</p> <p>For information about Redfish and its protocol, supported schema, and Redfish Eventing implemented in iDRAC, see the Redfish API Guide.</p> <p>For information about iDRAC property database group and object descriptions, see the Attribute Registry Guide.</p> <p>For information about Intel QuickAssist Technology, see the Integrated Dell Remote Access Controller User's Guide.</p> | www.dell.com/poweredgemanuals |
| | <p>For information about earlier versions of the iDRAC documents.</p> <p>To identify the version of iDRAC available on your system, on the iDRAC web interface, click ? > About.</p> | www.dell.com/idracmanuals |

Table 78. Additional documentation resources for your system (continued)

| Task | Document | Location |
|--|--|--|
| | For information about installing the operating system, see the operating system documentation. | www.dell.com/operatingsystemmanuals |
| | For information about updating drivers and firmware, see the Methods to download firmware and drivers section in this document. | www.dell.com/support/drivers |
| Managing your system | For information about systems management software offered by Dell, see the Dell OpenManage Systems Management Overview Guide. | www.dell.com/poweredgemanuals |
| | For information about setting up, using, and troubleshooting OpenManage, see the Dell OpenManage Server Administrator User's Guide. | www.dell.com/openmanagemanuals > OpenManage Server Administrator |
| | For information about installing and using Dell SupportAssist, see the Dell EMC SupportAssist Enterprise User's Guide. | https://www.dell.com/serviceabilitytools |
| | For information about partner programs enterprise systems management, see the OpenManage Connections Enterprise Systems Management documents. | www.dell.com/openmanagemanuals |
| Working with the Dell PowerEdge RAID controllers | For information about understanding the features of the Dell PowerEdge RAID controllers (PERC), Software RAID controllers, or BOSS card and deploying the cards, see the Storage controller documentation. | www.dell.com/storagecontrollermanuals |
| Understanding event and error messages | For information about the event and error messages generated by the system firmware and agents that monitor system components, go to qrl.dell.com > Look Up > Error Code , type the error code, and then click Look it up . | www.dell.com/qrl |
| Troubleshooting your system | For information about identifying and troubleshooting the PowerEdge server issues, see the Server Troubleshooting Guide. | www.dell.com/poweredgemanuals |