

Dell EMC PowerEdge R7525

Technical Guide

Notes, cautions, and warnings

 **NOTE:** A NOTE indicates important information that helps you make better use of your product.

 **CAUTION:** A CAUTION indicates either potential damage to hardware or loss of data and tells you how to avoid the problem.

 **WARNING:** A WARNING indicates a potential for property damage, personal injury, or death.

Contents

Chapter 1: Product overview	5
Introduction.....	5
Featured technologies.....	5
Chapter 2: System features	7
Product comparison.....	7
Chapter 3: Chassis views and features	9
Front view of the system.....	9
Rear view of the system.....	11
Inside the system	12
Quick Resource Locator for PowerEdge R7525 system.....	14
Chapter 4: Processor	15
Processor features.....	15
Supported processors.....	16
Chapter 5: Memory	18
Supported memory.....	18
Memory speed.....	19
Chapter 6: Storage	20
Storage controllers.....	20
Supported drives.....	20
External drives.....	21
Chapter 7: Networking and PCIe	22
Expansion card installation guidelines.....	22
Chapter 8: Power, thermal, and acoustics	54
Power	54
Thermal	54
Acoustics.....	55
Chapter 9: Supported operating systems	57
Chapter 10: Dell Technologies Services	58
Dell EMC ProDeploy Enterprise Suite	58
Dell EMC ProDeploy Plus.....	59
Dell EMC ProDeploy.....	59
Basic Deployment.....	59
Dell EMC Server Configuration Services.....	59
Dell EMC Residency Services.....	59

Dell EMC Remote Consulting Services.....	59
Dell EMC Data Migration Service.....	59
Dell EMC ProSupport Enterprise Suite.....	59
Dell EMC ProSupport Plus for Enterprise.....	60
Dell EMC ProSupport for Enterprise.....	60
Dell EMC ProSupport One for Data Center.....	61
ProSupport for HPC.....	61
Support Technologies.....	62
Dell Technologies Education Services.....	63
Dell Technologies Consulting Services.....	63
Dell EMC Managed Services.....	63
Chapter 11: Dell EMC OpenManage systems management.....	64
Server and Chassis Managers.....	65
Dell EMC consoles.....	65
Automation Enablers.....	65
Integration with third-party consoles.....	65
Connections for third-party consoles.....	65
Dell EMC Update Utilities.....	65
Dell resources.....	65
Chapter 12: Appendix A. Additional specifications.....	67
Chassis dimensions.....	67
Chassis weight.....	68
Video specifications.....	68
USB ports specifications.....	69
Environmental specifications.....	69
Thermal restriction matrix.....	71
Chapter 13: Appendix B. Standards compliance.....	76
Chapter 14: Appendix C Additional resources.....	77

Product overview

Topics:

- [Introduction](#)
- [Featured technologies](#)

Introduction

The Dell EMC PowerEdge R7525 is a two socket, 2U rack servers that is designed to run workloads using flexible I/O and network configurations. The PowerEdge R7525 features the AMD® EPYC™ Generation 2 and Generation 3 processors, supports up to 32 DIMMs, PCI Express (PCIe) Gen 4.0 enabled expansion slots, and a choice of network interface technologies to cover networking options.

The PowerEdge R7525 is designed to handle demanding workloads and applications, such as data warehouses, ecommerce, databases, and high-performance computing (HPC).

Featured technologies

The following table shows the new technologies for the PowerEdge R7525:

Table 1. New technologies

Technology	Detailed Description
AMD® EPYC™ Generation 2 and Generation 3 processors.	<ul style="list-style-type: none"> • 7 nm processor technology • AMD Interchip global memory interconnect (xGMI) up to 64 lanes • Up to 64 cores per socket • Up to 3.8 GHz • Max TDP: 280 W
3200 MT/s DDR4 memory	<ul style="list-style-type: none"> • Up to 32 DIMMs • 8x DDR4 Channels per socket, 2 DIMMs per channel (2DPC) • Up to 3200 MT/s (configuration-dependent) • Supports RDIMM, LRDIMM, and 3DS DIMM
PCIe Gen and slot	<ul style="list-style-type: none"> • Gen 4 at 16 T/s
Flex I/O	<ul style="list-style-type: none"> • LOM board, 2 x 1G with BCM5720 lan controller • Rear I/O with 1 G dedicated management network port • One USB 3.0, one USB 2.0 and VGA port • OCP Mezz 3.0 • Serial port option
CPLD 1-wire	<ul style="list-style-type: none"> • Support payload data of front PERC, Riser, backplane and rear I/O to BIOS and IDRAC
Dedicated PERC	<ul style="list-style-type: none"> • Front storage module PERC with front PERC 10.4
Software RAID	<ul style="list-style-type: none"> • Operating system RAID/PERC S 150
iDRAC9 with Lifecycle Controller	The embedded systems management solution for Dell servers features hardware and firmware inventory and alerting, in-depth memory alerting, faster performance, a dedicated Gb port and many more features.
Wireless Management	The Quick Sync feature is an extension of NFC-based low-bandwidth interface. Quick Sync 2.0 offers feature parity with the previous versions of the NFC interface with improved user experience. To extend this Quick Sync feature to wide variety of Mobile

Table 1. New technologies (continued)

Technology	Detailed Description
	OSs with higher data throughput, the Quick Sync 2 version replaces previous generation NFC technology with wireless at-the-box system management.
Power supply	<ul style="list-style-type: none">● 60 mm / 86 mm dimension is the new PSU form factor● Platinum Mixed Mode 800 W AC or HVDC● (-48V) 1100 W DC PSU● Platinum Mixed Mode 1400 W AC or HVDC● Platinum Mixed Mode 2400 W AC or HVDC● Titanium 1100 W Mixed Mode AC/HVDC
Boot Optimized Storage Subsystem S2 (BOSS S2)	Boot Optimized Storage Subsystem S2 (BOSS S2) is a RAID solution card that is designed for booting a server's operating system that supports up to: <ul style="list-style-type: none">● 80 mm M.2 SATA Solid-State Devices (SSDs)● PCIe card which is a Single Gen2 PCIe x 2 host interface● Dual SATA Gen3 device interfaces
Liquid cooling solution	<ul style="list-style-type: none">● The new liquid cooling solution provides efficient method to manage the system temperature.● It also provides liquid leak detection mechanism via iDRAC. This technology is managed by the Liquid Leak Sensor (LLS) mechanism.● LLS determines leaks as small as 0.02 ml or as large as 0.2 ml.

System features

Topics:

- [Product comparison](#)

Product comparison

Table 2. Product comparison

Feature	PowerEdge R7525	PowerEdge R7425
Processor	Two AMD® EPYC™ Generation 2 or Generation 3 processors.	Two AMD Naples™ socket SP3 compatible processors
CPU Interconnect	Inter-chip global memory interconnect (xGMI-2)	AMD Socket to Socket Global Memory Interface (xGMI)
Memory	32x DDR4 RDIMM, LRDIMM, 3DS	32x DDR4 RDIMM, LRDIMM
Disk Drives	3.5-inch, 2.5-inch: 12G SAS, 6G SATA, NVMe HDD	3.5-inch, 2.5-inch: 12G SAS, 6G SATA HDD
Storage Controllers	H755, H755N, H745, HBA345, HBA355, HBA355E, H345, H840, 12G SAS HBA SW RAID: S150	Adapters: H330, H730P, H740P, H840 , HBA330, 12G SAS HBA SW RAID: S140
PCIe SSD	Up to 24x PCIe SSD	Up to 24x PCIe SSD
PCIe Slots	Up to 8 (PCIe 4.0)	Up to 8(Gen3 x16)
rNDC	2 x 1 GB	Select Network Adapter NDC: 4 x 1 GB, 4 x 10 GB, 2 x 10 GB + 2 x 1 GB, or 2 x 25 GB
OCP	Yes for OCP 3.0	NA
USB Ports	Front: 1 x USB 2.0, 1 x iDRAC USB (Micro-AB USB) Rear: 1 x USB 3.0, 1 x USB 2.0 Internal: 1 x USB 3.0	Front: 1 x USB2.0, 1 x iDRAC USB(Micro USB) , Optional 1xUSB 3.0 front port Rear: 2 x USB3.0 Internal: 1 xUSB3.0
Rack Height	2U	2U
Power Supplies	Mixed Mode (MM) AC/HVDC (Platinum) 800 W, 1400 W, 2400 W, Titanium 1100 W Mixed Mode AC/HVDC, (-48 V) 1100 W DC PSU	AC Platinum : 2400 W, 2000 W, 1600 W, 1100 W, 495 W 750 W AC Platinum: Mixed Mode HVDC (for China only), Mixed Mode AC, DC (DC for China only) 1100 W -48 V DC Gold
System Management	LC 3.x, OpenManage, QuickSync2.0, OMPC3, Digital License Key, iDRAC Direct (dedicated micro-USB port), Easy Restore	LC 3.x, OpenManage, QuickSync 2.0, Digital License Key, iDRAC9, iDRAC Direct (dedicated micro-USB port), Easy Restore, vFlash
GPU	3 x 300 W (DW) or 6 x 75 W (SW)	3 x 300 W (DW) or 6 x 150 W (SW)

Table 2. Product comparison (continued)

Feature	PowerEdge R7525	PowerEdge R7425
Availability	Hot-plug drives, Hot-plug redundant power supplies, BOSS, IDSDM	Hot-plug drives, Hot-plug redundant power supplies, BOSS, IDSDM

Chassis views and features

Topics:

- Front view of the system
- Rear view of the system
- Inside the system
- [Quick Resource Locator for PowerEdge R7525 system](#)

Front view of the system

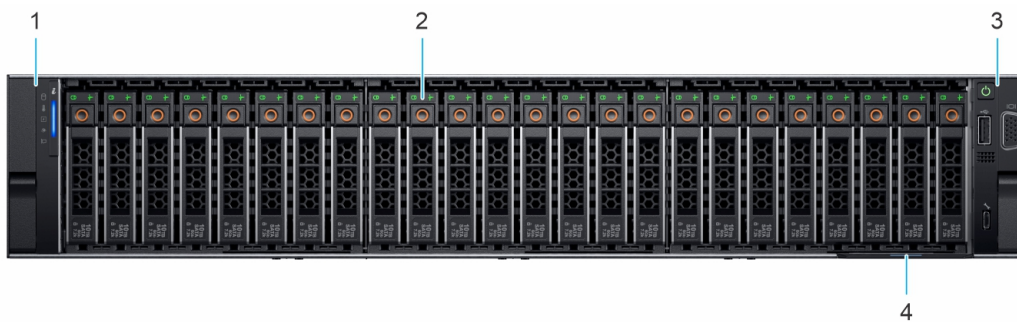

Figure 1. Front view of the 24 x 2.5-inch drive system

1. Left control panel
2. Drive (24)
3. Right control panel
4. Information tag

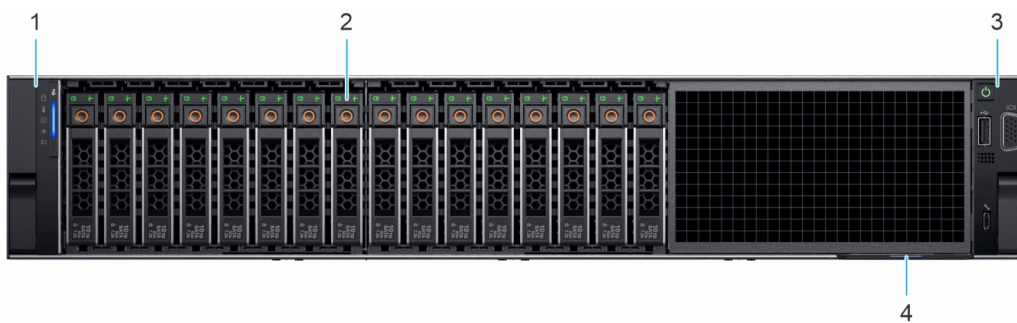

Figure 2. Front view of the 16 x 2.5-inch drive system

1. Left control panel
2. Drive (16)
3. Right control panel
4. Information tag



Figure 3. Front view of the 8 x 2.5-inch drive system

1. Left control panel
2. Drive (8)
3. Right control panel
4. Information tag

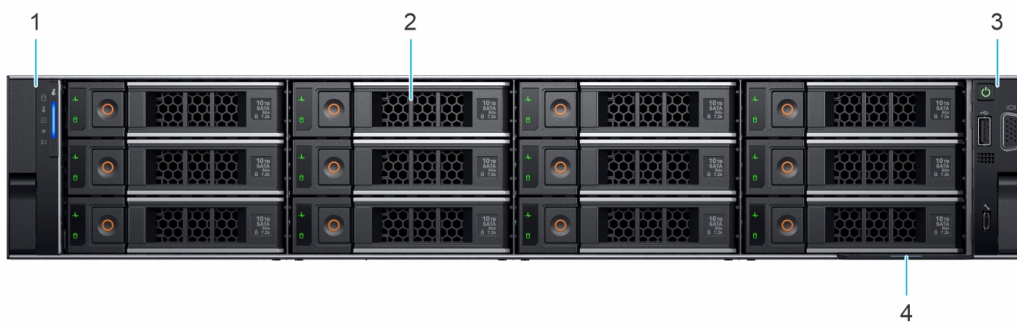

Figure 4. Front view of the 12 x 3.5-inch drive system

1. Left control panel
2. Drive (12)
3. Right control panel
4. Information tag

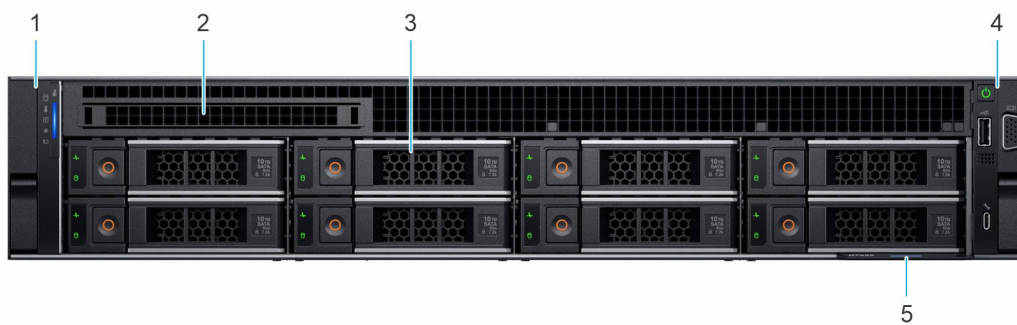
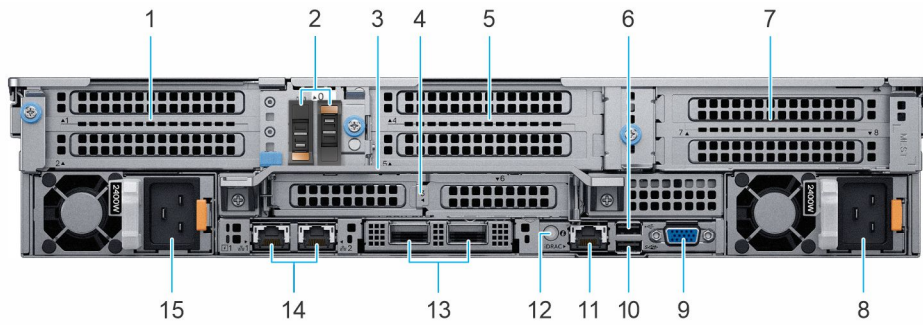

Figure 5. Front view of the 8 x 3.5-inch drive system

1. Left control panel
2. Optical Drive blank
3. Drive (8)
4. Right control panel
5. Information tag

Rear view of the system



1. PCIe expansion card riser 1 (slot 1 and slot 2)
2. BOSS S2 card (optional)
3. Rear Handle
4. PCIe expansion card riser 2 (slot 3 and slot 6)
5. PCIe expansion card riser 3 (slot 4 and slot 5)
6. USB 2.0 port (1)
7. PCIe expansion card riser 4 (slot 7 and slot 8)
8. Power supply unit (PSU 2)
9. VGA port
10. USB 3.0 port (1)
11. iDRAC dedicated port
 - i** NOTE: Enables you to remotely access iDRAC.
12. System identification button
13. OCP NIC port (optional)
14. NIC port (1,2)
15. Power supply unit (PSU 1)

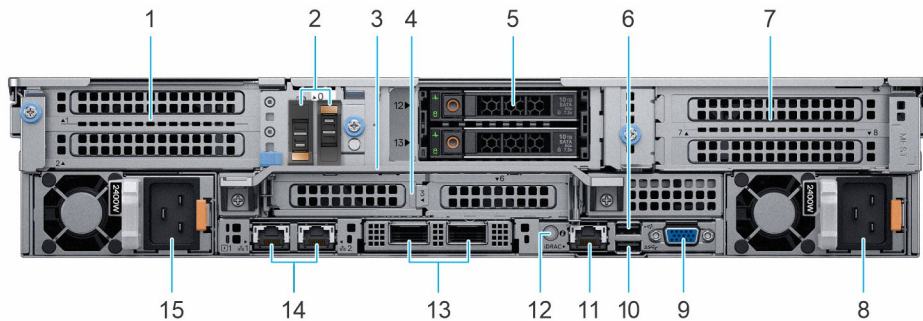

Figure 6. Rear view of the system with 2 x 2.5-inch rear drive module

1. PCIe expansion card riser 1 (slot 1 and slot 2)
2. BOSS S2 card (optional)
3. Rear Handle
4. PCIe expansion card riser 2 (slot 3 and slot 6)
5. Rear drive module
6. USB 2.0 port (1)
7. PCIe expansion card riser 4 (slot 7 and slot 8)
8. Power supply unit (PSU 2)
9. VGA port
10. USB 3.0 port (1)
11. iDRAC dedicated port
 - i** NOTE: Enables you to remotely access iDRAC.
12. System identification button

- 13. OCP NIC port (optional)
- 14. NIC port (1,2)
- 15. Power supply unit (PSU 1)

Inside the system

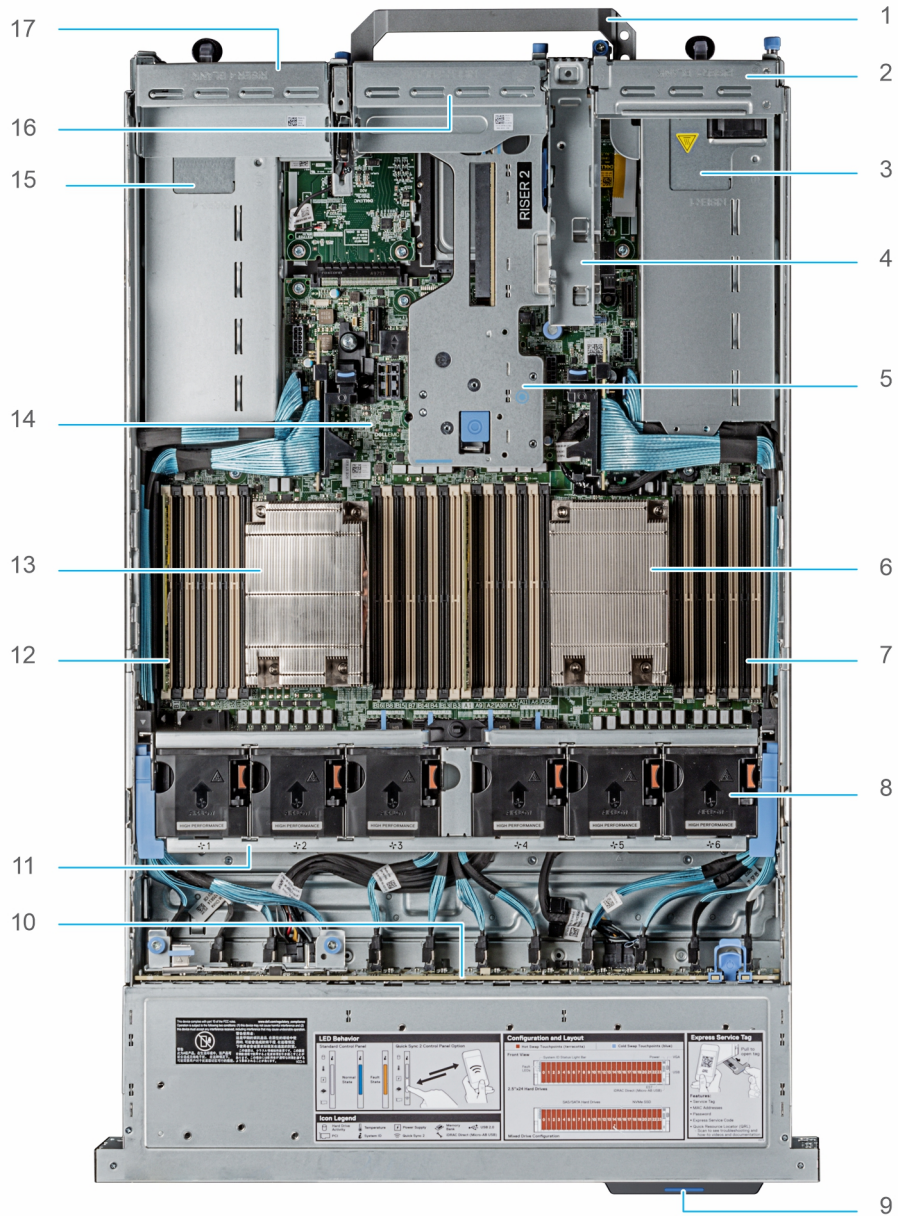

Figure 7. Inside the system

- | | |
|---|--|
| 1. Handle | 2. Riser 1 blank |
| 3. Power supply unit (PSU 1) | 4. BOSS S2 card slot |
| 5. Riser 2 | 6. Heat sink for processor 1 |
| 7. Memory DIMM socket for processor 1 (E,F,G,H) | 8. Cooling fan assembly |
| 9. Service tag | 10. Drive backplane |
| 11. Cooling fan cage assembly | 12. Memory DIMM socket for processor 2 (A,B,C,D) |
| 13. Heat sink for processor 2 | 14. System board |
| 15. Power supply unit (PSU 2) | 16. Riser 3 blank |
| 17. Riser 4 blank | |

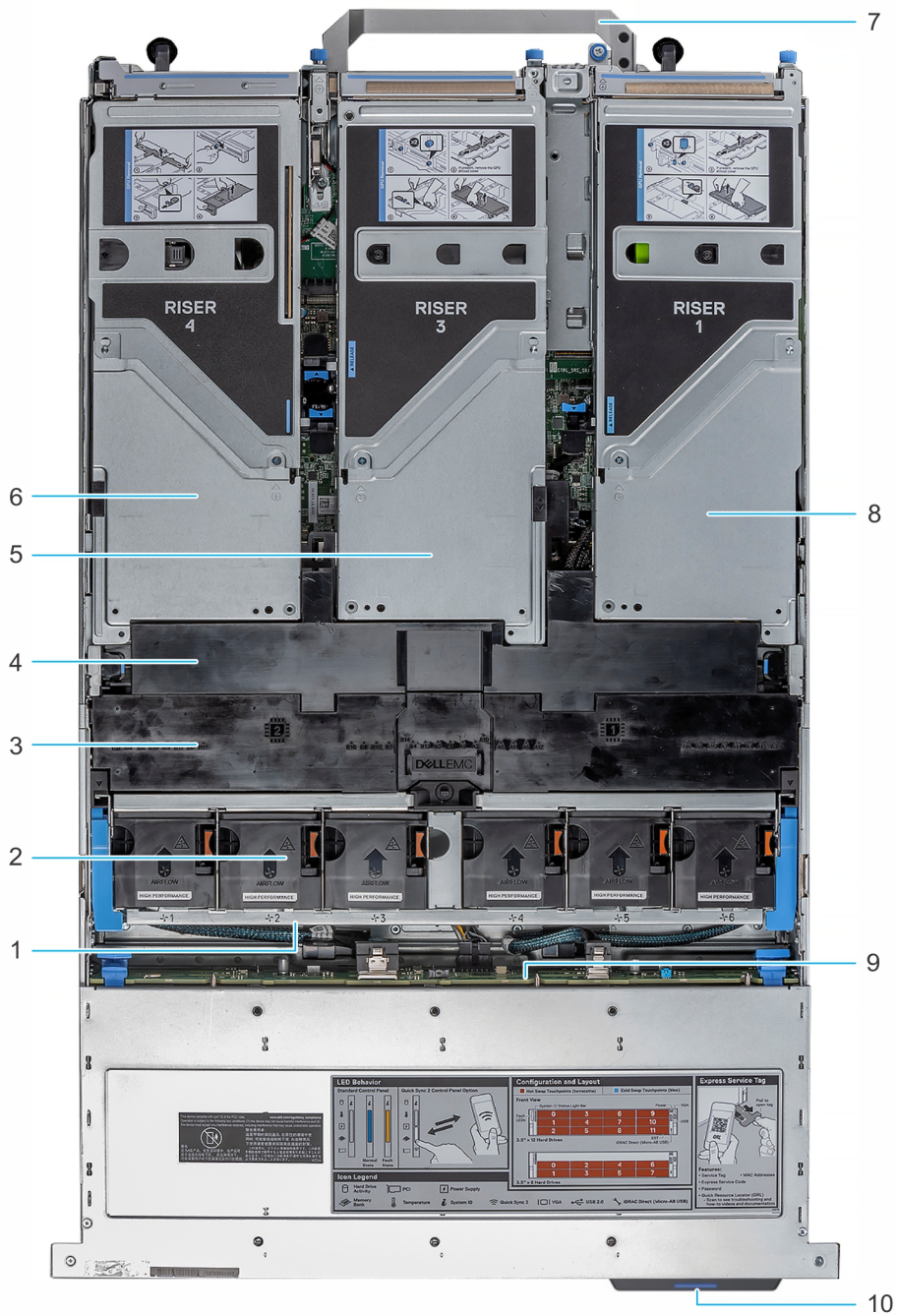

Figure 8. Inside the system with full length risers

- | | |
|------------------------------|-----------------------------|
| 1. Cooling fan cage assembly | 2. Cooling fan |
| 3. GPU air shroud | 4. GPU air shroud top cover |
| 5. Riser 3 | 6. Riser 4 |
| 7. Handle | 8. Riser 1 |
| 9. Drive backplane | 10. Service tag |

Quick Resource Locator for PowerEdge R7525 system



Figure 9. Quick Resource Locator for PowerEdge R7525 system

Processor



The AMD® EPYC™ Generation 2 and Generation 3 processors supports up to 64 cores.

Topics:

- [Processor features](#)
- [Supported processors](#)

Processor features

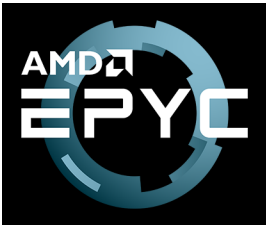

The key features of the AMD® EPYC™ Generation 2 and Generation 3 processors are:

- Support up to 64 cores
- Up to 8 channels with 2 DIMMs per channel (DPC) per processor and 32 DIMMs in total
- Supports RDIMM, LRDIMM, 3DS DIMM DDR4 with ECC up to 3200 MT/s
- Integrated PCI Express Gen 4 for improved bandwidth and connectivity
- Up to 128 lanes per processor

Single processor configuration

The system is designed such that a single processor placed in the processor 1 socket functions normally. Processor and memory blanks that are associated with processor 2 are required to be populated for thermal reasons. The system will not boot if only the processor 2 socket is populated.

Only Riser 1 is functional with single processor configuration.

Processor restrictions

The following are AMD EPYC processor restrictions:

- The RTC/COMS is build in the processor. Therefore, removing or reinstalling processor 1 will cause the RTC/COMS to be lost.
- AMD does not support early boot. There is no error message when there is no memory populating in the system.

Supported processors

Table 3. Supported processor for the PowerEdge R7525

Processor model number	Base frequency in GHz	Cores/Threads	TDP in W	L3 Cache in MB	Max DDR frequency (1 DPC) MHz
7773X	3.50	64/128	280	768	3200
7573X	3.60	32/64	280	768	3200
7473X	3.70	24/48	240	768	3200
7373X	3.80	16/32	240	768	3200
7H12	2.6	64/128	280	256	3200
7763	2.45	64/128	280	256	3200
7742	2.25	64/128	225	256	3200
7713P	2.0	64/128	225	256	3200
7713	2.0	64/128	225	256	3200
7702	2.0	64/128	200	256	3200
7663	2.0	56/112	240	256	3200
7662	2.0	64/128	225	256	3200
7643	2.3	48/96	225	256	3200
7642	2.3	48/96	225	256	3200
75F3	2.95	32/64	280	256	3200
7552	2.2	48/96	200	192	3200
7543P	2.8	32/64	225	256	3200
7543	2.8	32/64	225	256	3200
7542	2.9	32/64	225	128	3200
7532	2.4	32/64	200	256	3200
7513	2.6	32/64	200	128	3200
7502	2.5	32/64	180	128	3200
74F3	3.2	24/48	240	256	3200
7453	2.75	28/56	225	64	3200
7452	2.35	32/64	155	128	3200
7443P	2.85	24/48	200	128	3200
7443	2.85	24/48	200	128	3200
7413	2.65	24/48	180	128	3200
7402	2.8	24/48	180	128	3200
73F3	3.5	16/32	240	256	3200
7352	2.3	24/48	155	128	3200
7343	3.2	16/32	190	128	3200
7313P	3.0	16/32	155	128	3200
7313	3.0	16/32	155	128	3200

Table 3. Supported processor for the PowerEdge R7525 (continued)

Processor model number	Base frequency in GHz	Cores/Threads	TDP in W	L3 Cache in MB	Max DDR frequency (1 DPC) MHz
7302	2.35	16/32	155	128	3200
72F3	3.7	8/16	180	256	3200
7282	2.8	16/32	120	64	3200
7272	2.9	12/24	120	64	3200
7262	3.2	8/16	155	128	3200
7252	3.1	8/16	120	32	3200

Memory

The PowerEdge R7525 system supports up to 32 DIMMS, 4 TB of memory, and speeds up to 3200MT/s.

The R7525 support registered (RDIMMs) and load reduced DIMMs (LRDIMMs) which use a buffer to reduce memory loading and provide greater density, allowing for the maximum platform memory capacity. Unbuffered DIMMs (UDIMMs) are not supported.

Topics:

- [Supported memory](#)
- [Memory speed](#)

Supported memory

The following table lists the memory technologies that are supported by the R7525:

Table 4. Memory technology comparison

Feature	R7525(DDR4)
DIMM type	RDIMM
	LRDIMM
Transfer speed	3200 MT/s
	2933 MT/s
Voltage	1.2 V

The following table shows the supported DIMMs for the PowerEdge R7525:

Table 5. Supported DIMMs for the PowerEdge R7525

DIMM Speed(MT/s)	DIMM Type	DIMM Capacity(GB)	Ranks per DIMM	Data Width	DIMM Voltage (V)	Maximum RAM
3200	RDIMM	8	1	8	1.2	256 GB
3200	RDIMM	16	2	8	1.2	512 GB
3200	RDIMM	32	2	8	1.2	32 GB
3200	RDIMM	32	2	4	1.2	1 TB
3200	RDIMM	64	2	4	1.2	2 TB
2666	LRDIMM	128	8	4	1.2	4 TB
3200	LRDIMM	128	4	4	1.2	4 TB

NOTE: The older 32 GB capacity RDIMM memory with x4 data width and 8Gb DRAM density cannot be mixed with the newer 32 GB capacity RDIMM memory with x8 data width and 16Gb DRAM density in the same AMD EPYC™ processor unit.

NOTE: The older 128 GB capacity LRDIMM memory at 2666 MT/s speed cannot be mixed with the new 128 GB capacity LRDIMM memory at 3200 MT/s speed.

Memory speed

Table 6. Supported memory matrix

DIMM type	Rank	Capacity	DIMM rated voltage and speed	Operating Speed on AMD EPYC™ processor	
				1 DIMM per channel (1DPC)	2 DIMMs per channel (2DPC)
RDIMM	1R	8 GB	DDR4 (1.2V), 3200 MT/s	3200 MT/s	2933 MT/s
	2R	16 GB, 32 GB, 64 GB	DDR4 (1.2V), 3200 MT/s	3200 MT/s	2933 MT/s
LRDIMM	4 R	128 GB	DDR4 (1.2 V), 3200 MT/s	3200 MT/s	2933 MT/s
	8R	128 GB	DDR4 (1.2V), 2666 MT/s	2666 MT/s	2666 MT/s
	8R	128 GB	DDR4 (1.2V), 3200 MT/s	3200 MT/s	2933 MT/s

NOTE: The older 32 GB capacity RDIMM memory with x4 data width and 8Gb DRAM density cannot be mixed with the newer 32GB capacity RDIMM memory with x8 data width and 16Gb DRAM density in the same AMD EPYC™ processor unit.

NOTE: The older 128 GB capacity LRDIMM memory at 2666 MT/s speed cannot be mixed with the new 128 GB capacity LRDIMM memory at 3200 MT/s speed.

Storage

The PowerEdge R7525 supports the following drive configurations:

- 8 x 3.5-inch backplane configuration with support up to 8 SAS/SATA drives
- 8 x 2.5-inch backplane configuration with support up to 8 NVMe drives
- 12 x 3.5-inch backplane configuration with support up to 12 SAS/SATA drives
- 16 x 2.5-inch backplane configuration with support up to 16 SAS/SATA drives
- 24 x 2.5-inch backplane configuration with support up to 24 SAS/SATA/NVMe drives
- 2 x 2.5-inch backplane configuration with support up to 2 rear SAS/SATA drives

Topics:

- [Storage controllers](#)
- [Supported drives](#)
- [External drives](#)

Storage controllers

Dell EMC RAID controller options offer performance improvements, including the Mini PERC solution. Mini PERC provides a base RAID HW controller without consuming a PCIe slot by using a small form factor and high density connector to the base planar.

The following table shows the supported storage controllers for the PowerEdge R7525:

Table 7. Supported storage controllers

Performance level	Description
Entry	S150 (SATA, NVMe) Software RAID SATA
Value	H745 (internal), H345, HBA345 (internal), H840 (external), 12Gbps SAS HBA (external)
Value Performance	H755N (internal), HBA355 (internal), HBA355E (external)

Supported drives

Table 8. Supported drives - SAS and SATA or SSD

Form Factor	Type	Speed	Rotational Speed	Capacities
2.5-inch	SAS	12 Gb	10 K	300 GB, 600 GB, 1.2 TB, 1.8 TB, 1.2 TB (SED/FIPS), 2.4 TB, 2.4 TB (SED/FIPS)
	SATA	6 Gb	7.2 K	1 TB, 2 TB
	SATA SSD (M.2)	6 Gb	N/A	120 GB, 240 GB
	SAS SSD	12 Gb	N/A	400 GB, 800 GB, 960 GB, 1.633 TB, 1.92 TB, 3.2 TB, 3.840 TB, 1.92 TB (SED/FIPS)
	SATA SSD	6 Gb	N/A	120 GB, 200 GB, 240 GB, 300 GB, 400 GB, 480 GB, 800 GB, 960 GB, 1.2 TB, 1.6 TB, 1.92 TB, 3.84 TB

Table 8. Supported drives - SAS and SATA or SSD (continued)

Form Factor	Type	Speed	Rotational Speed	Capacities
	SAS	12 Gb	15 K	300 GB, 600 GB, 900 GB
	SAS	12 Gb	7.2 K	1 TB, 2 TB, 4 TB, 6 TB, 8 TB, 10 TB, 2 TB (SED/FIPS)
3.5-inch	SATA	6 Gb	7.2 K	1 TB, 2 TB, 4 TB, 6 TB, 8 TB, 10 TB
	SAS	12 Gb	7.2 K	1 TB, 2 TB, 4 TB, 8 TB, 10 TB, 4 TB (SED FIPS), 8 TB (SED FIPS)
2.5-inch	NVMe SSD (U.2)	Gen4	N/A	960 GB, 1.92 TB, 7.68 TB, 15.36 TB

Table 9. Supported NVMe SSDs

Description
SSDR,1.6,NVMEPCIE,2.5,PM1725B
SSDR,6.4,NVMEPCIE,2.5,PM1725B
CRD,CTL,NVME,1.6,HHHL,PM1725B
SSDR,3.2,NVMEPCIE,2.5,PM1725B
SSDR,12.8,NVMEPCIE,2.5,PM1725B
CRD,CTL,NVME,3.2,HHHL,PM1725B
CRD,CTL,NVME,6.4,HHHL,PM1725B
SSDR,960GB,NVMEPCIE,2.5,CD5
SSDR,3.84TB,NVMEPCIE,2.5,CD5
NVMe PM1735a 1.6TB GB 2.5" PCIe SSD
NVMe PM1735a 3.2TB GB 2.5" PCIe SSD
NVMe PM1735a 6.4TB GB 2.5" PCIe SSD
NVMe PM1735a 12.8TB GB 2.5" PCIe SSD
NVMe PM1733a 1.92TB GB 2.5" PCIe SSD
NVMe PM1733a 3.8TB GB 2.5" PCIe SSD
NVMe PM1733a 7.6TB GB 2.5" PCIe SSD
NVMe PM1733a 15.36TB GB 2.5" PCIe SSD

External drives

The following table shows the supported external storage for the PowerEdge R7525:

Table 10. Supported external storage

Device Type	Description
External Tape	Supports connection to external USB tape products
NAS/IDM appliance software	Supports NAS software stack
JBOD	Supports connection to 12Gb MD-series JBODs

Networking and PCIe

The PowerEdge R7525 system supports two Network Interface Controller (NIC) ports embedded on the LOM card.

The PowerEdge R7525 system also supports OCP NIC port integrated on the optional OCP card.

Table 11. NIC port specification

Feature	Specifications
LOM card	1 GB x 2
OCP card (OCP 3.0)	1 GbE x 4, 10 GbE x 2, 25 GbE x 2, 25 GbE x 4, 50 GbE x 2, 100 GbE x 2

Topics:

- [Expansion card installation guidelines](#)

Expansion card installation guidelines

The following table describes the supported expansion cards:

Table 12. Expansion card riser configurations

Expansion card riser	PCIe slots	Processor connection	Height	Length	Slot width
Riser 1	Slot 1	Processor 1	Full Height	Half Length	x8
					x16
	Slot 2				x8
					x16
Riser 2	Slot 3	Processor 1	Low Profile	Half Length	x16
	Slot 6	Processor 2			
Riser 3	Slot 4	Processor 2	Full Height	Half Length	x8
	Slot 5				x16
Riser 4	Slot 7	Processor 2	Full Height	Half Length	x8
					x16
					x8
	Slot 8				x16

Table 13. PCIe Riser Configs

Config #	RSR Configuration	# of CPUs	PERC type supported	Rear Storage Possible	x8 CPU 1	x16 CPU 1	x8 CPU 2	x16 CPU 2
0	NO RSR	2	None	No	0	0	0	0

Table 13. PCIe Riser Configs (continued)

Config #	RSR Configuration	# of CPUs	PERC type supported	Rear Storage Possible	x8 CPU 1	x16 CPU 1	x8 CPU 2	x16 CPU 2
1	R1B	1	Front PERC	No	2	0	0	0
2	R1B+R4B	2	Front PERC/ PERC Adapter	No	2	0	2	0
3-1	R1A+R2A+ R3A+R4A (FL)	2	Front PERC/ PERC Adapter	No	0	2	0	3
3-2	R1A+R2A+ R3A+R4A (HL)	2	Front PERC/ PERC Adapter	No	0	2	0	3
4	R1B+R2A+ R3B+R4B	2	Front PERC/ PERC Adapter	No	2	1	4	1
6	R1C+R2A+ R3A+R4C	2	PERC Adapter	No	0	3	0	4
7	R1D+R2A+ R3B+R4D	2	None	No	0	1	2	1
8-1	R1A+R2A+ R4A (FL)	2	PERC Adapter	Yes	0	2	0	2
8-2	R1A+R2A+ R4A (HL)	2	PERC Adapter	Yes	0	2	0	2
9	R1B+R2A+ R4B	2	PERC Adapter	Yes	2	1	2	1
10	R2A+R4B	2	PERC Adapter	Yes	0	1	2	1
11	R1D+R2A+ R3B+R4B	2	None	No	0	1	4	1
12-1	R1D+R2A+ R3A+R4A (FL)	2	None	No	0	1	0	3
12-2	R1D+R2A+ R3A+R4A (HL)	2	None	No	0	1	0	3
13-1	R1A+R2A+ R3A (FL)	2	Front PERC/ PERC Adapter	No	0	2	0	2
13-2	R1A+R2A+ R3A (HL)	2	Front PERC/ PERC Adapter	No	0	2	0	2
14	R1B+R2A+ R3B	2	Front PERC/	No	2	1	2	1

Table 13. PCIe Riser Configs (continued)

Config #	RSR Configuration	# of CPUs	PERC type supported	Rear Storage Possible	x8 CPU 1	x16 CPU 1	x8 CPU 2	x16 CPU 2
			PERC Adapter					
15	R1D+R4D	1	None	No	0	0	0	0

 **NOTE:** The expansion-card slots are not hot-swappable.

The following table provides guidelines for installing expansion cards to ensure proper cooling and mechanical fit. The expansion cards with the highest priority should be installed first using the slot priority indicated. All the other expansion cards should be installed in the card priority and slot priority order.

Table 14. Configuration 0 - No riser

Card type	Slot priority	Maximum number of cards
Broadcom (OCP: 25 Gb)	Internal slot	1
QLogic (OCP: 25 Gb)	Internal slot	1
Mellanox (OCP: 25 Gb)	Internal slot	1
SolarFlare (OCP: 25 Gb)	Internal slot	1
Intel (OCP: 25 Gb)	Internal slot	1
Intel (OCP: 10 Gb)	Internal slot	1
Broadcom (OCP: 10 Gb)	Internal slot	1
QLogic (OCP: 10 Gb)	Internal slot	1
Broadcom (OCP: 1 Gb)	Internal slot	1
Intel (OCP: 1 Gb)	Internal slot	1
Intel (OCP: 25Gb)	Internal slot	1
Dell BOSS S2 card Module	Internal slot	1

Table 15. Configuration 1: R1B

Card type	Slot priority	Maximum number of cards
Intel (NIC: 25 Gb)	1,2	2
SolarFlare (NIC: 25 Gb)	1,2	2
Broadcom (NIC: 25 Gb)	1,2	2
QLogic (NIC: 25 Gb)	1,2	2
Emulex (HBA: FC64 FH)	1,2	2
Emulex (HBA: FC32)	1,2	2
QLogic (HBA: FC32)	1,2	2
Emulex (HBA: FC16)	1,2	2
QLogic (HBA: FC16)	1,2	2
FOXCONN (HBA355E, HBA355I)	1,2	2

Table 15. Configuration 1: R1B (continued)

Card type	Slot priority	Maximum number of cards
Intel (NIC: 10 Gb)	1,2	2
Broadcom (NIC: 10 Gb)	1,2	2
QLogic (NIC: 10 Gb)	1,2	2
Intel (NIC: 1 Gb)	1,2	2
Broadcom (NIC: 1 Gb)	1,2	2
Samsung (PCIE SSD)	1,2	1
Intel (PCIE SSD)	1,2	1
Dell PERC Adapter	1,2	2
Dell BOSS Adapter	1,2	1
Intel (NIC: 25Gb)	1,2	2
Intel (NIC: 100Gb)	1,2	2
Broadcom (NIC: 10Gb)	1,2	2
Dell Front PERC	Internal slot	1
Mellanox (OCP: 100 Gb)	Internal slot	1
Mellanox (OCP: 50 Gb)	Internal slot	1
Broadcom (OCP: 25 Gb)	Internal slot	1
QLogic (OCP: 25 Gb)	Internal slot	1
Mellanox (OCP: 25 Gb)	Internal slot	1
SolarFlare (OCP: 25 Gb)	Internal slot	1
Intel (OCP: 25 Gb)	Internal slot	1
Intel (OCP: 10 Gb)	Internal slot	1
Broadcom (OCP: 10 Gb)	Internal slot	1
QLogic (OCP: 10 Gb)	Internal slot	1
Broadcom (OCP: 1 Gb)	Internal slot	1
Intel (OCP: 1 Gb)	Internal slot	1
Dell BOSS S2 card Module	Internal slot	1

Table 16. Configuration 2: R1B+ R4B

Card type	Slot priority	Maximum number of cards
Dell Serial	8	1
Dell BOSS Adapter	1, 2, 7, 8	1
Dell PERC Adapter	2	1
Intel (NIC: 25 Gb)	1, 2, 7	3
Mellanox (NIC: 25 Gb)	1, 2, 3	3

Table 16. Configuration 2: R1B+ R4B (continued)

Card type	Slot priority	Maximum number of cards
SolarFlare (NIC: 25 Gb)	1, 2, 7	3
QLogic (NIC: 25 Gb)	1, 2, 7	3
Emulex (HBA: FC64 FH)	1, 2, 7	3
Emulex (HBA: FC32)	1, 2, 7	3
QLogic (HBA: FC32)	1, 2, 7	3
Emulex (HBA: FC16)	1, 2, 7	3
QLogic (HBA: FC16)	1, 2, 7	3
FOXCONN (HBA355E)	1, 2, 7, 8	2
FOXCONN (HBA355I)	2	1
Intel (NIC: 10 Gb)	1, 2, 7	3
Broadcom (NIC: 10 Gb)	1, 2, 7	3
QLogic (NIC: 10 Gb)	1, 2, 7	3
Intel (NIC: 10 Gb)	1, 2, 7	3
Intel (NIC: 1 Gb)	1, 2, 7	3
Broadcom (NIC: 1 Gb)	1, 2, 7	3
Broadcom (NIC: 10Gb)	1, 2, 7	3
Intel (NIC: 25Gb)	1, 2, 7	3
Intel (NIC: 100Gb)	1, 2, 7	3
Dell PERC Adapter	1, 2, 7, 8	3
Samsung (PCIe SSD)	1, 2, 7, 8	3
Intel (PCIe SSD)	1, 2, 7, 8	3
Dell Front PERC	Internal slot	1
Broadcom (OCP: 25 Gb)	Internal slot	1
QLogic (OCP: 25 Gb)	Internal slot	1
Mellanox (OCP: 25 Gb)	Internal slot	1
SolarFlare (OCP: 25 Gb)	Internal slot	1
Intel (OCP: 25 Gb)	Internal slot	1
Intel (OCP: 10 Gb)	Internal slot	1
Broadcom (OCP: 10 Gb)	Internal slot	1
QLogic (OCP: 10 Gb)	Internal slot	1
Broadcom (OCP: 1 Gb)	Internal slot	1
Intel (OCP: 1 Gb)	Internal slot	1
Dell BOSS S2 card Module	Internal slot	1

Table 17. Configuration 3-1: R1A + R2A + R3A + R4A (Full Length)

Card type	Slot priority	Maximum number of cards
Dell Serial	4	1
GPU: NVIDIA T4 16 GB (Low Profile)	3, 6	2
GPU: NVIDIA A2 16 GB (Low Profile)	3, 6	2
GPU: NVIDIA M10 32 GB (Full Height)	2, 5, 7	3
GPU: NVIDIA A100 40 GB (Full Height)	2, 5, 7	3
GPU: NVIDIA A10 24 GB (Full Height)	2, 5, 7	3
GPU: NVIDIA A30 24 GB (Full Height)	2, 5, 7	3
GPU: NVIDIA A40 48 GB (Full Height)	2, 5, 7	3
GPU: NVIDIA V100 16 GB (Full Height)	2, 5, 7	3
GPU: NVIDIA V100S 32 GB (Full Height)	2, 5, 7	3
GPU: AMD MI100 32 GB (Full Height)	2, 5, 7	3
GPU: AMD MI210 64 GB (Full Height)	2, 5, 7	3
GPU: NVIDIA RTX6000 24 GB (Full Height)	2, 5, 7	3
GPU: NVIDIA RTX8000 48 GB (Full Height)	2, 5, 7	3
GPU: NVIDIA RTX5000 16 GB (Full Height)	2, 5, 7	3
GPU: NVIDIA A16 64 GB (Full Height)	2, 5, 7	3
GPU: NVIDIA A100 80 GB (Full Height)	2, 5, 7	3
Xilinx (Accelerators - FPGAs - Full Height)	2, 5, 7	3
FOXCONN front PERC	Internal slot	1
Inventec front PERC	Internal slot	1
FOXCONN PERC Adapter (Low Profile)	3	1
Inventec PERC Adapter (Low Profile)	3	1
Mellanox (NIC: 100 Gb - Low Profile)	3, 6	2
Intel (NIC: 25 Gb - Low Profile)	3, 6	2
Mellanox (NIC: 25 Gb - Low Profile)	3, 6	2
Broadcom (NIC: 25 Gb - Low Profile)	3, 6	2
QLogic (NIC: 25 Gb - Low Profile)	3, 6	2
Emulex (HBA: FC64 - Low Profile)	3, 6	2
Emulex (HBA: FC32 - Low Profile)	3, 6	2
QLogic (HBA: FC32 - Low Profile)	3, 6	2
Emulex (HBA: FC16 - Low Profile)	3, 6	2
QLogic (HBA: FC16 - Low Profile)	3, 6	2
FOXCONN (HBA355E - Low Profile/Full Height)	3, 6	2
QLogic (NIC: 10 Gb - Low Profile)	3, 6	2

Table 17. Configuration 3-1: R1A + R2A + R3A + R4A (Full Length) (continued)

Card type	Slot priority	Maximum number of cards
Intel (NIC: 10 Gb - Low Profile)	3, 6	2
Broadcom (NIC: 10 Gb - Low Profile)	3, 6	2
QLogic (NIC: 10 Gb - Low Profile)	3, 6	2
Intel (NIC: 10 Gb - Low Profile)	3, 6	2
Intel (NIC: 1 Gb - Low Profile)	3, 6	2
Intel (NIC: 100Gb, LP)	3, 6	2
Broadcom (NIC: 1 Gb - Low Profile)	3, 6	2
Mellanox (NIC: HDR100 VPI - Low Profile)	3, 6	2
Mellanox (NIC:HDR VPI - Low Profile)	3, 6	2
Broadcom (OCP: 25 Gb)	Internal	1
QLogic (OCP: 25 Gb)	Internal	1
Mellanox (OCP: 25 Gb)	Internal	1
SolarFlare (OCP: 25 Gb)	Internal	1
Intel (OCP: 10 Gb)	Internal	1
Broadcom (OCP: 10 Gb)	Internal	1
QLogic (OCP: 10 Gb)	Internal	1
Intel (OCP: 10 Gb)	Internal	1
QLogic (OCP: 10 Gb)	Internal	1
Broadcom (OCP: 1 Gb)	Internal	1
Intel (OCP: 1 Gb)	Internal	1
FOXCONN (External adapter - Low Profile)	3, 6	2
Dell BOSS S2 Adapter (Low Profile)	Internal	1
Dell BOSS Adapter (Low Profile)	3, 6	1
Samsung (PCIe SSD)	3, 6	2
Intel (PCIe SSD)	3, 6	2
FOXCONN (ASSY,CRD,CTL,H755,FRONT)	Internal	1
Emulex (CRD,CTL,EMLX,LP,FC32,2P,V1.1)	3,6	2
QLogic (CRD,CTL,MRVL,LP,FC32,1P,S28,F1)	3,6	2
FOXCONN (PWA,CTL,HBA355I,ADPT,V2)	3	1
FOXCONN (PWA,CTL,HBA355I,FRONT,V2)	Internal	1
Inventec (ASSY,CRD,CTL,BOSS,ADPT,S2V2,15G)	Internal	1
Emulex (CRD,CTL,EMLX,LP,FC32,1P,S28)	3, 6	2

Table 17. Configuration 3-1: R1A + R2A + R3A + R4A (Full Length) (continued)

Card type	Slot priority	Maximum number of cards
Intel (CRD,NTWK,INTL,FH,25G,2P,S28,F1)	Internal	1
Intel (CRD,NTWK,INTL,LP,25G,2P,S28,F1)	3, 6	2

Table 18. Configuration 3-2: R1A + R2A + R3A + R4A (Half Length)

Card type	Slot priority	Maximum number of cards
Dell Serial	4	1
GPU: NVIDIA T4 16 GB (Full Height)	2, 5, 7	3
GPU: NVIDIA T4 16 GB (Low Profile)	3, 6	2
GPU: NVIDIA A2 16 GB (Full Height)	2, 5, 7	3
GPU: NVIDIA A2 16 GB (Low Profile)	3, 6	2
FOXCONN Front PERC	Internal	1
Inventec Front PERC	Internal	1
FOXCONN PERC Adapter (Low Profile)	3	1
Inventec PERC Adapter (Low Profile)	3	1
Mellanox (NIC: 100 Gb - Low Profile)	2, 5, 7	3
Mellanox (NIC: 100 Gb - Low Profile)	3, 6	2
NAPATECH (NIC: 100 Gb - Low Profile)	2, 5, 7	3
QLogic (NIC: 25 Gb - Low Profile)	2, 5, 7	3
QLogic (NIC: 25 Gb - Low Profile)	3, 6	2
Intel (NIC: 25 Gb - Low Profile)	2, 5, 7	3
Intel (NIC: 25 Gb - Low Profile)	3, 6	2
Mellanox (NIC: 25 Gb - Low Profile)	2, 5, 7	3
Mellanox (NIC: 25 Gb - Low Profile)	3, 6	2
Broadcom (NIC: 25 Gb - Low Profile)	2, 5, 7	3
Broadcom (NIC: 25 Gb - Low Profile)	3, 6	2
Emulex (HBA: FC64 Full Height)	2, 5, 7	3
Emulex (HBA: FC64 Low Profile)	3, 6	2
Emulex (HBA: FC32 - Low Profile)	2, 5, 7	3
Emulex (HBA: FC32 - Low Profile)	3, 6	2
QLogic (HBA: FC32 - Low Profile)	2, 5, 7	3
QLogic (HBA: FC32 - Low Profile)	3, 6	2
Emulex (HBA: FC16 - Low Profile)	2, 5, 7	3
Emulex (HBA: FC16 - Low Profile)	3, 6	2
QLogic (HBA: FC16 - Low Profile)	2, 5, 7	3
QLogic (HBA: FC16 - Low Profile)	3, 6	2
FOXCONN (HBA355E - Low Profile/Full Height)	3, 6	2

Table 18. Configuration 3-2: R1A + R2A + R3A + R4A (Half Length) (continued)

Card type	Slot priority	Maximum number of cards
QLogic (NIC: 10 Gb - Low Profile)	2, 5, 7	3
QLogic (NIC: 10 Gb - Low Profile)	3, 6	2
Intel (NIC: 10 Gb - Low Profile)	3, 6	2
Intel (NIC: 10 Gb - Low Profile)	2, 5, 7	3
Broadcom (NIC: 10 Gb - Low Profile)	2, 5, 7	3
Broadcom (NIC: 10 Gb - Low Profile)	3, 6	2
QLogic (NIC: 10 Gb - Low Profile)	2, 5, 7	3
QLogic (NIC: 10 Gb - Low Profile)	3, 6	2
Intel (NIC: 10 Gb - Low Profile)	2, 5, 7	3
Intel (NIC: 10 Gb - Low Profile)	3, 6	2
Intel (NIC: 1 Gb - Low Profile)	3, 6	2
Intel (NIC: 1 Gb - Low Profile)	2, 5, 7	3
Intel (NIC: 25Gb)	2, 5, 7	3
Intel (NIC: 100Gb, FH)	2, 5, 7	3
Intel (NIC: 100Gb)	3, 6	2
Broadcom (NIC: 1 Gb - Low Profile)	2, 5, 7	3
Broadcom (NIC: 1 Gb - Low Profile)	3, 6	2
Broadcom (NIC: 10Gb, FH)	2, 5, 7	3
Broadcom (NIC: 10Gb, LP)	3, 6	2
Mellanox (NIC: HDR100 VPI - Low Profile)	3, 6	2
Mellanox (NIC: HDR100 VPI - Low Profile)	2, 5, 7	3
Mellanox (NIC:HDR VPI - Low Profile)	3, 6	2
Mellanox (NIC:HDR VPI - Low Profile)	2, 5, 7	3
Broadcom (OCP: 25 Gb)	INT	1
QLogic (OCP: 25 Gb)	INT	1
Mellanox (OCP: 25 Gb)	INT	1
SolarFlare (OCP: 25 Gb)	INT	1
Intel (OCP: 10 Gb)	INT	1
Broadcom (OCP: 10 Gb)	INT	1
QLogic (OCP: 10 Gb)	INT	1
Intel (OCP: 10 Gb)	INT	1
QLogic (OCP: 10 Gb)	INT	1
Broadcom (OCP: 1 Gb)	INT	1
Intel (OCP: 1 Gb)	INT	1
Intel (OCP: 25Gb)	INT	1

Table 18. Configuration 3-2: R1A + R2A + R3A + R4A (Half Length) (continued)

Card type	Slot priority	Maximum number of cards
FOXCONN (External adapter - Low Profile)	2, 5, 7	2
FOXCONN (External adapter - Low Profile)	3, 6	2
Dell BOSS S2 Adapter (Low Profile)	Internal	1
Dell BOSS Adapter (Low Profile)	2, 5, 7	1
Dell BOSS Adapter (Low Profile)	3, 6	1
Samsung (PCIe SSD)	3, 6, 2, 5, 7	5
FOXCONN (ASSY,CRD,CTL,H755,FRONT)	Internal	1
Intel (PCIe SSD)	3, 6, 2, 5, 7	5
Emulex (CRD,CTL,EMLX,FH,FC32)	2, 5, 7	3
Emulex (CRD,CTL,EMLX,LP,FC32,2P,V1.1)	3, 6	2
QLogic (CRD,CTL,MRVL,FH,FC32,1P,S2)8,F1)	2, 5, 7	3
QLogic (CRD,CTL,MRVL,LP,FC32,1P,S28,F1)	3, 6	2
FOXCONN (PWA,CTL,HBA355I,ADPT,V2)	3	1
FOXCONN (PWA,CTL,HBA355I,FRONT,V2)	Internal	1
Inventec (ASSY,CRD,CTL,BOSS,ADPT,S2V2,15G)	Internal	1
Emulex (CRD,CTL,EMLX,FH,FC32,1P,S28)	2, 5, 7	3
Emulex (CRD,CTL,EMLX,LP,FC32,1P,S28)	3, 6	2
Intel (CRD,NTWK,INTL,FH,25G,2P,S28,F1)	2, 5, 7	3
Intel (CRD,NTWK,INTL,LP,25G,2P,S28,F1)	3, 6	2

Table 19. Configuration 4: R1B + R2A + R3A + R4B

Card type	Slot priority	Maximum number of cards
Dell Serial	4, 8	1
Dell BOSS Adapter (Full Height)	1, 2, 5, 7, 8	1
Dell PERC Adapter	2	1
Mellanox (NIC: 100 Gb - Full Height)	5	1
Mellanox (NIC: 100 Gb - Low Profile)	3, 6	2
Intel (NIC: 25 Gb - Full Height)	1, 2, 5, 7	4
Mellanox (NIC: 25 Gb - Full Height)	1, 2, 5, 7	4
Mellanox (NIC: 25 Gb - Low Profile)	3, 6	2

Table 19. Configuration 4: R1B + R2A + R3A + R4B (continued)

Card type	Slot priority	Maximum number of cards
SolarFlare (NIC: 25 Gb - Full Height)	1, 2, 5, 7	4
Broadcom (NIC: 25 Gb - Full Height)	1, 2, 5, 7	4
Broadcom (NIC: 25 Gb - Low Profile)	3, 6	2
QLogic (NIC: 25 Gb - Full Height)	1, 2, 5, 7	4
Emulex (HBA: FC64 Full Height)	4, 5, 1, 2, 7	5
Emulex (HBA: FC64 Low Profile)	3, 6	2
Emulex (HBA: FC32 - Full Height)	1, 2, 5, 7	4
QLogic (HBA: FC32 - Full Height)	1, 2, 5, 7	4
Emulex (HBA: FC16 - Full Height)	1, 2, 5, 7	4
QLogic (HBA: FC16 - Full Height)	1, 2, 5, 7	4
Intel (NIC: 10 Gb - Full Height)	1, 2, 5, 7	4
Broadcom (NIC: 10 Gb - Full Height)	1, 2, 5, 7	4
QLogic (NIC: 10 Gb - Full Height)	1, 2, 5, 7	4
Intel (NIC: 10 Gb - Full Height)	1, 2, 5, 7	4
Intel (NIC: 1 Gb - Full Height)	1, 2, 5, 7	4
Broadcom (NIC: 1 Gb - Full Height)	1, 2, 5, 7	4
Mellanox (NIC: HDR100 VPI - Full Height)	5	2
Mellanox (NIC: HDR100 VPI - Low Profile)	3, 6	2
Mellanox (NIC:HDR VPI - Full Height)	5	1
Mellanox (NIC:HDR VPI - Low Profile)	3, 6	2
Dell (External adapter - Full Height)	1, 2, 5, 7	4
Dell (External adapter - Low Profile)	3, 6	2
Samsung (PCIe SSD)	1, 2, 5, 7, 8	1
Intel (PCIe SSD)	1, 2, 5, 7, 8	1
Dell Front PERC	Internal slot	1
Broadcom (OCP: 25 Gb)	Internal slot	1
QLogic (OCP: 25 Gb)	Internal slot	1
Mellanox (OCP: 25 Gb)	Internal slot	1
SolarFlare (OCP: 25 Gb)	Internal slot	1
Intel (OCP: 25 Gb)	Internal slot	1
Intel (OCP: 10 Gb)	Internal slot	1
Broadcom (OCP: 10 Gb)	Internal slot	1
QLogic (OCP: 10 Gb)	Internal slot	1

Table 19. Configuration 4: R1B + R2A + R3A + R4B (continued)

Card type	Slot priority	Maximum number of cards
Broadcom (OCP: 1 Gb)	Internal slot	1
Intel (OCP: 1 Gb)	Internal slot	1
FOXCONN (ASSY,CRD,CTL,H755,FRONT)	Internal slot	1
Emulex (CRD,CTL,EMLX,FH,FC32,2P,V1.1)	4, 5, 1, 2, 7	5
Emulex (CRD,CTL,EMLX,LP,FC32,2P,V1.1)	3, 6	2

Table 20. Configuration 6: R1C + R2A + R3A + R4C

Card type	Slot priority	Maximum number of cards
Dell Serial	4, 8	1
GPU: NVIDIA T4 16 GB (Full Height)	1, 2, 7, 8	4
GPU: NVIDIA T4 16 GB (Low Profile)	3, 6	2
GPU: NVIDIA A2 16 GB (Full Height)	1, 2, 7, 8	4
GPU: NVIDIA A2 16 GB (Low Profile)	3, 6	2
Dell BOSS Adapter (Full Height)	1, 2, 5, 7	1
Dell BOSS Adapter (Low Profile)	3, 6	1
Dell PERC Adapter	5, 3	1
Mellanox (NIC: 100 Gb - Full Height)	1, 2, 5, 7	4
Mellanox (NIC: 100 Gb - Low Profile)	3, 6	2
Intel (NIC: 25 Gb - Full Height)	1, 2, 5, 7	4
Intel (NIC: 25 Gb - Low Profile)	3, 6	2
Mellanox (NIC: 25 Gb - Full Height)	1, 2, 5, 7	4
Mellanox (NIC: 25 Gb - Low Profile)	3, 6	2
SolarFlare (NIC: 25 Gb - Full Height)	1, 2, 5, 7	4
SolarFlare (NIC: 25 Gb - Low Profile)	3, 6	2
Broadcom (NIC: 25 Gb - Full Height)	1, 2, 5, 7	4
Broadcom (NIC: 25 Gb - Low Profile)	3, 6	2
Broadcom (NIC: 100Gb, FH)	1, 2, 5, 7	4
Broadcom (NIC: 100Gb, LP)	3, 6	2
QLogic (NIC: 25 Gb - Full Height)	1, 2, 5, 7	4
QLogic (NIC: 25 Gb - Low Profile)	3, 6	2
Emulex (HBA: FC64 - Full Height)	1, 2, 5, 7	4
Emulex (HBA: FC64 - Low Profile)	3, 6	2
Emulex (HBA: FC32 - Full Height)	1, 2, 5, 7	4
Emulex (HBA: FC32 - Low Profile)	3, 6	2
QLogic (HBA: FC32 - Full Height)	1, 2, 5, 7	4
QLogic (HBA: FC32 - Low Profile)	3, 6	2

Table 20. Configuration 6: R1C + R2A + R3A + R4C (continued)

Card type	Slot priority	Maximum number of cards
Emulex (HBA: FC16 - Full Height)	1, 2, 5, 7	4
Emulex (HBA: FC16 - Low Profile)	3, 6	2
QLogic (HBA: FC16 - Full Height)	1, 2, 5, 7	4
QLogic (HBA: FC16 - Low Profile)	3, 6	2
FOXCONN (HBA355E - Low Profile/Full Height)	3, 6	2
Intel (NIC: 10 Gb - Full Height)	1, 2, 5, 7	4
Intel (NIC: 10 Gb - Low Profile)	3, 6	2
Broadcom (NIC: 10 Gb - Full Height)	1, 2, 5, 7	4
Broadcom (NIC: 10 Gb - Low Profile)	3, 6	2
QLogic (NIC: 10 Gb - Full Height)	1, 2, 5, 7	4
QLogic (NIC: 10 Gb - Low Profile)	3, 6	2
Intel (NIC: 10 Gb - Full Height)	1, 2, 5, 7	4
Intel (NIC: 10 Gb - Low Profile)	3, 6	2
Intel (NIC: 1 Gb - Full Height)	1, 2, 5, 7	4
Intel (NIC: 1 Gb - Low Profile)	3, 6	2
Intel (NIC: 100Gb, FH)	1, 2, 5, 7	4
Intel (NIC: 100Gb, LP)	3, 6	2
Broadcom (NIC: 1 Gb - Full Height)	1, 2, 5, 7	4
Broadcom (NIC: 1 Gb - Low Profile)	3, 6	2
Mellanox (NIC: HDR100 VPI - Full Height)	1, 2, 5, 7	4
Mellanox (NIC: HDR100 VPI - Low Profile)	3, 6	2
Mellanox (NIC:HDR VPI - Full Height)	1, 2, 5, 7	4
Mellanox (NIC:HDR VPI - Low Profile)	3, 6	2
Dell (External adapter - Full Height)	1, 2, 5, 7	4
Dell (External adapter - Low Profile)	3, 6	2
Samsung (PCIe SSD)	1, 2, 5, 7, 8, 3, 6	1
Intel (PCIe SSD)	1, 2, 5, 7, 8, 3, 6	1
Dell Front PERC	Internal slot	1
Broadcom (OCP: 25 Gb)	Internal slot	1
QLogic (OCP: 25 Gb)	Internal slot	1
Mellanox (OCP: 25 Gb)	Internal slot	1
SolarFlare (OCP: 25 Gb)	Internal slot	1
Intel (OCP: 25 Gb)	Internal slot	1

Table 20. Configuration 6: R1C + R2A + R3A + R4C (continued)

Card type	Slot priority	Maximum number of cards
Intel (OCP: 10 Gb)	Internal slot	1
Broadcom (OCP: 10 Gb)	Internal slot	1
QLogic (OCP: 10 Gb)	Internal slot	1
Broadcom (OCP: 1 Gb)	Internal slot	1
Intel (OCP: 1 Gb)	Internal slot	1
FOXCONN (ASSY,CRD,CTL,H755,FRONT)	Internal slot	1
Emulex (CRD,CTL,EMLX,FH,FC32,2P,V1.1)	1, 2, 5, 7	4
Emulex (CRD,CTL,EMLX,LP,FC32,2P,V1.1)	3, 6	2
QLogic (CRD,CTL,MRVL,FH,FC32,1P,S28,F1)	1, 2, 5, 7	4
QLogic (CRD,CTL,MRVL,LP,FC32,1P,S28,F1)	3, 6	2
FOXCONN (PWA,CTL,HBA355I,ADPT,V2)	5, 3	1
Emulex (CRD,CTL,EMLX,FH,FC32,1P,S28)	1, 2, 5, 7	4
Emulex (CRD,CTL,EMLX,LP,FC32,1P,S28)	3, 6	2
Intel (CRD,NTWK,INTL,FH,25G,2P,S28,F1)	1, 2, 5, 7	4
Intel (CRD,NTWK,INTL,LP,25G,2P,S28,F1)	3, 6	2

Table 21. Configuration 7: R1D + R2A + R3B + R4D

Card type	Slot priority	Maximum number of cards
Dell Serial	4, 8	1
Dell BOSS Adapter (Full Height)	4, 5	2
Dell BOSS Adapter (Low Profile)	3, 6	1
Mellanox (NIC: 100 Gb - Low Profile)	3, 6	2
Intel (NIC: 25 Gb - Full Height)	4, 5	2
Intel (NIC: 25 Gb - Low Profile)	3, 6	2
Mellanox (NIC: 25 Gb - Full Height)	4, 5	2
Mellanox (NIC: 25 Gb - Low Profile)	3, 6	2
SolarFlare (NIC: 25 Gb - Full Height)	4, 5	2
SolarFlare (NIC: 25 Gb - Low Profile)	3, 6	2
Broadcom (NIC: 25 Gb - Full Height)	4, 5	2
Broadcom (NIC: 25 Gb - Low Profile)	3, 6	2

Table 21. Configuration 7: R1D + R2A + R3B + R4D (continued)

Card type	Slot priority	Maximum number of cards
Broadcom (NIC: 100Gb, FH)	5, 4	2
Broadcom (NIC: 100Gb, LP)	3, 6	2
QLogic (NIC: 25 Gb - Full Height)	4, 5	2
QLogic (NIC: 25 Gb - Low Profile)	3, 6	2
Emulex (HBA: FC64 - Full Height)	5, 4	2
Emulex (HBA: FC64 - Low Profile)	3, 6	2
Emulex (HBA: FC32 - Full Height)	4, 5	2
Emulex (HBA: FC32 - Low Profile)	3, 6	2
QLogic (HBA: FC32 - Full Height)	4, 5	2
QLogic (HBA: FC32 - Low Profile)	3, 6	2
Emulex (HBA: FC16 - Full Height)	4, 5	2
Emulex (HBA: FC16 - Low Profile)	3, 6	2
QLogic (HBA: FC16 - Full Height)	4, 5	2
QLogic (HBA: FC16 - Low Profile)	3, 6	2
FOXCONN (HBA355E - Low Profile/Full Height)	3, 6	2
Intel (NIC: 10 Gb - Full Height)	4, 5	2
Intel (NIC: 10 Gb - Low Profile)	3, 6	2
Broadcom (NIC: 10 Gb - Full Height)	4, 5	2
Broadcom (NIC: 10 Gb - Low Profile)	3, 6	2
QLogic (NIC: 10 Gb - Full Height)	4, 5	2
QLogic (NIC: 10 Gb - Low Profile)	3, 6	2
Intel (NIC: 10 Gb - Full Height)	4, 5	2
Intel (NIC: 10 Gb - Low Profile)	3, 6	2
Intel (NIC: 1 Gb - Full Height)	4, 5	2
Intel (NIC: 1 Gb - Low Profile)	3, 6	2
Broadcom (NIC: 1 Gb - Full Height)	4, 5	2
Broadcom (NIC: 1 Gb - Low Profile)	3, 6	2
Mellanox (NIC: HDR100 VPI - Low Profile)	3, 6	2
Mellanox (NIC:HDR VPI - Low Profile)	3, 6	2
Dell (External adapter - Full Height)	4, 5	2
Dell (External adapter - Low Profile)	3, 6	2
Samsung (PCIe SSD)	3, 6, 4, 5	1
Intel (PCIe SSD)	3, 6, 4, 5	1
Intel (NIC: 100Gb, LP)	3, 6	2
Intel (NIC: 25Gb, FH)	5, 4	2
Intel (NIC: 100Gb, FH)	5, 4	2

Table 21. Configuration 7: R1D + R2A + R3B + R4D (continued)

Card type	Slot priority	Maximum number of cards
Broadcom (OCP: 25 Gb)	Internal slot	1
QLogic (OCP: 25 Gb)	Internal slot	1
Mellanox (OCP: 25 Gb)	Internal slot	1
SolarFlare (OCP: 25 Gb)	Internal slot	1
Intel (OCP: 25 Gb)	Internal slot	1
Intel (OCP: 10 Gb)	Internal slot	1
Broadcom (OCP: 10 Gb)	Internal slot	1
QLogic (OCP: 10 Gb)	Internal slot	1
Broadcom (OCP: 1 Gb)	Internal slot	1
Intel (OCP: 1 Gb)	Internal slot	1
Emulex (CRD,CTL,EMLX,FH,FC32,2P,V1.1)	5, 4	2
Emulex (CRD,CTL,EMLX,LP,FC32,2P,V1.1)	3, 6	2
QLogic (CRD,CTL,MRVL,FH,FC32,1P,S28,F1)	5, 4	2
QLogic (CRD,CTL,MRVL,LP,FC32,1P,S28,F1)	3, 6	2
Inventec (ASSY,CRD,CTL,BOSS,ADPT,S2V2,15G)	Internal slot	1
Emulex (CRD,CTL,EMLX,FH,FC32,1P,S28)	5, 4	2
Emulex (CRD,CTL,EMLX,LP,FC32,1P,S28)	3, 6, 4, 5	2
Intel (CRD,NTWK,INTL,FH,25G,2P,S28,F1)	5, 4	2
Intel (CRD,NTWK,INTL,LP,25G,2P,S28,F1)	3, 6	2

Table 22. Configuration 8-1: R1A + R2A + R4A (FL)

Card type	Slot priority	Maximum number of cards
Dell BOSS-S2 Adapter	Internal slot	1
Dell BOSS-S1 card module	3, 6	1
Dell Front PERC Adapter	Internal slot	1
Dell PERC Adapter	3	1
Broadcom (NIC: 100 Gb - Low Profile)	3, 6	2
Broadcom (NIC: 25 Gb - Low Profile)	3, 6	2
Broadcom (NIC: 10 Gb - Low Profile)	3, 6	2
Broadcom (NIC: 1 Gb - Low Profile)	3, 6	2

Table 22. Configuration 8-1: R1A + R2A + R4A (FL) (continued)

Card type	Slot priority	Maximum number of cards
Emulex (HBA: FC64 - Low Profile)	3, 6	2
Emulex (HBA: FC32 - Low Profile)	3, 6	2
Emulex (HBA: FC16 - Low Profile)	3, 6	2
Intel (NIC: 100 Gb - Low Profile)	3, 6	2
Intel (NIC: 25 Gb - Low Profile)	3, 6	2
Intel (NIC: 10 Gb - Low Profile)	3, 6	2
Intel (NIC: 10 Gb - Low Profile)	3, 6	2
Intel (NIC: 1 Gb - Low Profile)	3, 6	2
Mellanox (NIC: 100 Gb - Low Profile)	3, 6	2
Mellanox (NIC: 25 Gb - Low Profile)	3, 6	2
Mellanox (NIC: HDR100 VPI - Low Profile)	3, 6	2
Mellanox (NIC:HDR VPI - Low Profile)	3, 6	2
QLogic (NIC: 25 Gb - Low Profile)	3, 6	2
QLogic (HBA: FC32 - Low Profile)	3, 6	2
QLogic (HBA: FC16 - Low Profile)	3, 6	2
QLogic (NIC: 10 Gb - Low Profile)	3, 6	2
Dell (External adapter - Low Profile)	3, 6	2
Samsung (PCIe SSD)	3, 6	1
Intel (PCIe SSD)	3, 6	1
Broadcom (OCP: 25 Gb)	Internal slot	1
QLogic (OCP: 25 Gb)	Internal slot	1
Mellanox (OCP: 25 Gb)	Internal slot	1
SolarFlare (OCP: 25 Gb)	Internal slot	1
Intel (OCP: 25 Gb)	Internal slot	1
Intel (OCP: 10 Gb)	Internal slot	1
Broadcom (OCP: 10 Gb)	Internal slot	1
QLogic (OCP: 10 Gb)	Internal slot	1
Broadcom (OCP: 1 Gb)	Internal slot	1
Intel (OCP: 1 Gb)	Internal slot	1

Table 23. Configuration 8-2: R1A + R2A + R4A (HL)

Card type	Slot priority	Maximum number of cards
Dell Serial	8	1
Dell BOSS-S2 Adapter	Internal slot	1
Dell BOSS-S1 card module	3, 6	1

Table 23. Configuration 8-2: R1A + R2A + R4A (HL) (continued)

Card type	Slot priority	Maximum number of cards
Dell Front PERC Adapter	Internal slot	1
Dell PERC Adapter	3	1
Broadcom (NIC: 100 Gb - Full Height)	2, 7	2
Broadcom (NIC: 100 Gb - Low Profile)	3, 6	2
Mellanox (NIC: 100 Gb - Full Height)	2, 7	2
Mellanox (NIC: 100 Gb - Low Profile)	3, 6	2
Intel (NIC: 25 Gb - Full Height)	2, 7	2
Intel (NIC: 25 Gb - Low Profile)	3, 6	2
Mellanox (NIC: 25 Gb - Full Height)	2, 7	2
Mellanox (NIC: 25 Gb - Low Profile)	3, 6	2
SolarFlare (NIC: 25 Gb - Full Height)	2, 7	2
SolarFlare (NIC: 25 Gb - Low Profile)	3, 6	2
Broadcom (NIC: 25 Gb - Full Height)	2, 7	2
Broadcom (NIC: 25 Gb - Low Profile)	3, 6	2
QLogic (NIC: 25 Gb - Full Height)	2, 7	2
Emulex (HBA: FC32 - Full Height)	2, 7	2
Emulex (HBA: FC64 - Low Profile)	3, 6	2
Emulex (HBA: FC64 - Full Height)	2, 7	2
Emulex (HBA: FC32 - Low Profile)	3, 6	2
QLogic (HBA: FC32 - Full Height)	2, 7	2
QLogic (HBA: FC32 - Low Profile)	3, 6	2
Emulex (HBA: FC16 - Full Height)	2, 7	2
Emulex (HBA: FC16 - Low Profile)	3, 6	2
QLogic (HBA: FC16 - Full Height)	2, 7	2
QLogic (HBA: FC16 - Low Profile)	3, 6	2
Intel (NIC: 10 Gb - Full Height)	2, 7	2
Intel (NIC: 10 Gb - Low Profile)	3, 6	2
Broadcom (NIC: 10 Gb - Full Height)	2, 7	2
Broadcom (NIC: 10 Gb - Low Profile)	3, 6	2
QLogic (NIC: 10 Gb - Full Height)	2, 7	2
QLogic (NIC: 10 Gb - Low Profile)	3, 6	2
Intel (NIC: 10 Gb - Full Height)	2, 7	2
Intel (NIC: 10 Gb - Low Profile)	3, 6	2
Intel (NIC: 1 Gb - Full Height)	2, 7	2
Intel (NIC: 1 Gb - Low Profile)	3, 6	2
Broadcom (NIC: 1 Gb - Full Height)	2, 7	2
Broadcom (NIC: 1 Gb - Low Profile)	3, 6	2

Table 23. Configuration 8-2: R1A + R2A + R4A (HL) (continued)

Card type	Slot priority	Maximum number of cards
Mellanox (NIC: HDR100 VPI - Full Height)	2, 7	2
Mellanox (NIC: HDR100 VPI - Low Profile)	3, 6	2
Mellanox (NIC:HDR VPI - Full Height)	2, 7	2
Mellanox (NIC:HDR VPI - Low Profile)	3, 6	2
Dell (External adapter - Full Height)	2, 7	2
Dell (External adapter - Low Profile)	3, 6	2
Samsung (PCIe SSD)	2, 7, 3, 6	1
Intel (PCIe SSD)	2, 7, 3, 6	1
Broadcom (OCP: 25 Gb)	Internal slot	1
QLogic (OCP: 25 Gb)	Internal slot	1
Mellanox (OCP: 25 Gb)	Internal slot	1
SolarFlare (OCP: 25 Gb)	Internal slot	1
Intel (OCP: 25 Gb)	Internal slot	1
Intel (OCP: 10 Gb)	Internal slot	1
Broadcom (OCP: 10 Gb)	Internal slot	1
QLogic (OCP: 10 Gb)	Internal slot	1
Broadcom (OCP: 1 Gb)	Internal slot	1
Intel (OCP: 1 Gb)	Internal slot	1

Table 24. Configuration 9: R1B + R2A + R4B

Card type	Slot priority	Maximum number of cards
Dell Serial	8	1
Dell BOSS Adapter (Full Height)	1, 2, 7, 8	2
Dell BOSS Adapter (Low Profile)	3, 6	1
Dell PERC Adapter	3, 2	1
Broadcom (NIC: 100 Gb - Low Profile)	3, 6	2
Mellanox (NIC: 100 Gb - Low Profile)	3, 6	2
Intel (NIC: 25 Gb - Full Height)	1, 2, 7	3
Intel (NIC: 25 Gb - Low Profile)	3, 6	2
Intel (NIC: 100Gb, FH)	1, 2, 7	3
Intel (NIC: 100Gb, LP)	3, 6	2
Mellanox (NIC: 25 Gb - Full Height)	1, 2, 7	3
Mellanox (NIC: 25 Gb - Low Profile)	3, 6	2
SolarFlare (NIC: 25 Gb - Full Height)	1, 2, 7	3

Table 24. Configuration 9: R1B + R2A + R4B (continued)

Card type	Slot priority	Maximum number of cards
SolarFlare (NIC: 25 Gb - Low Profile)	3, 6	2
Broadcom (NIC: 25 Gb - Low Profile)	3, 6	2
QLogic (NIC: 25 Gb - Full Height)	1, 2, 7	3
QLogic (NIC: 25 Gb - Low Profile)	3, 6	2
Emulex (HBA: FC64 - Full Height)	1, 2, 7	3
Emulex (HBA: FC64 - Low Profile)	3, 6	2
Emulex (HBA: FC32 - Full Height)	1, 2, 7	3
Emulex (HBA: FC32 - Low Profile)	3, 6	2
QLogic (HBA: FC32 - Full Height)	1, 2, 7	3
QLogic (HBA: FC32 - Low Profile)	3, 6	2
Emulex (HBA: FC16 - Full Height)	1, 2, 7	3
Emulex (HBA: FC16 - Low Profile)	3, 6	2
QLogic (HBA: FC16 - Full Height)	1, 2, 7	3
QLogic (HBA: FC16 - Low Profile)	3, 6	2
FOXCONN (HBA355E - Low Profile/Full Height)	3, 6	2
Intel (NIC: 10 Gb - Full Height)	1, 2, 7	3
Intel (NIC: 10 Gb - Low Profile)	3, 6	2
Broadcom (NIC: 10 Gb - Full Height)	1, 2, 7	3
Broadcom (NIC: 10 Gb - Low Profile)	3, 6	2
QLogic (NIC: 10 Gb - Full Height)	1, 2, 7	3
QLogic (NIC: 10 Gb - Low Profile)	3, 6	2
Intel (NIC: 10 Gb - Full Height)	1, 2, 7	3
Intel (NIC: 10 Gb - Low Profile)	3, 6	2
Intel (NIC: 1 Gb - Full Height)	1, 2, 7	3
Intel (NIC: 1 Gb - Low Profile)	3, 6	2
Broadcom (NIC: 1 Gb - Full Height)	1, 2, 7	3
Broadcom (NIC: 1 Gb - Low Profile)	3, 6	2
Mellanox (NIC: HDR100 VPI - Low Profile)	3, 6	2
Mellanox (NIC:HDR VPI - Low Profile)	3, 6	2
Dell (External adapter - Full Height)	1, 2, 7	3
Dell (External adapter - Low Profile)	3, 6	2
Samsung (PCIe SSD)	3, 6, 1, 2, 7, 8	1
Intel (PCIe SSD)	3, 6, 1, 2, 7, 8	1
Broadcom (OCP: 25 Gb)	Internal slot	1
QLogic (OCP: 25 Gb)	Internal slot	1

Table 24. Configuration 9: R1B + R2A + R4B (continued)

Card type	Slot priority	Maximum number of cards
Mellanox (OCP: 25 Gb)	Internal slot	1
SolarFlare (OCP: 25 Gb)	Internal slot	1
Intel (OCP: 25 Gb)	Internal slot	1
Intel (OCP: 10 Gb)	Internal slot	1
Broadcom (OCP: 10 Gb)	Internal slot	1
QLogic (OCP: 10 Gb)	Internal slot	1
Broadcom (OCP: 1 Gb)	Internal slot	1
FOXCONN (ASSY,CRD,CTL,H755,FRONT)	Internal slot	1
Intel (OCP: 1 Gb)	Internal slot	1
Emulex (CRD,CTL,EMLX,FH,FC32,2P,V1.1)	1, 2, 7	3
Emulex (CRD,CTL,EMLX,LP,FC32,2P,V1.1)	3, 6	2
QLogic (CRD,CTL,MRVL,FH,FC32,1P,S28,F1)	1, 2, 7	3
QLogic (CRD,CTL,MRVL,LP,FC32,1P,S28,F1)	3, 6	2
FOXCONN (PWA,CTL,HBA355I,ADPT,V2)	3	1
FOXCONN (PWA,CTL,HBA355I,FRONT,V2)	Internal slot	1
Inventec (ASSY,CRD,CTL,BOSS,ADPT,S2V2,15G)	Internal slot	1
Emulex (CRD,CTL,EMLX,FH,FC32,1P,S28)	1, 2, 7	3
Emulex (CRD,CTL,EMLX,LP,FC32,1P,S28)	3, 6	2
Intel (CRD,NTWK,INTL,FH,25G,2P,S28,F1)	1, 2, 7	3
Intel (CRD,NTWK,INTL,LP,25G,2P,S28,F1)	3, 6	2

Table 25. Configuration 10: R2A + R4B

Card type	Slot priority	Maximum number of cards
Dell BOSS-S2 Adapter	Internal slot	1
Dell BOSS-S1 card module (Full Height)	7, 8	1
Dell BOSS-S1 card module (Low Profile)	3, 6	1
Dell Front PERC Adapter	Internal slot	1
Dell PERC Adapter	3	1

Table 25. Configuration 10: R2A + R4B (continued)

Card type	Slot priority	Maximum number of cards
FOXCONN (HBA355I)	3	1
FOXCONN (HBA355E, H840)	3, 6, 7	3
Broadcom (NIC: 100 Gb - Low Profile)	3, 6	2
Broadcom (NIC: 25 Gb - Low Profile)	3, 6	2
Broadcom (NIC: 10 Gb - Full Height)	7	1
Broadcom (NIC: 10 Gb - Low Profile)	3, 6	2
Broadcom (NIC: 1 Gb - Full Height)	7	1
Broadcom (NIC: 1 Gb - Low Profile)	3, 6	2
Emulex (HBA: FC64 - Full Height)	7	1
Emulex (HBA: FC64 - Low Profile)	3, 6	2
Emulex (HBA: FC32 - Full Height)	7	1
Emulex (HBA: FC32 - Low Profile)	3, 6	2
Emulex (HBA: FC16 - Full Height)	7	1
Emulex (HBA: FC16 - Low Profile)	3, 6	2
Intel (NIC: 100 Gb - Low Profile)	3, 6	2
Intel (NIC: 25 Gb - Full Height)	7	1
Intel (NIC: 25 Gb - Low Profile)	3, 6	2
Intel (NIC: 10 Gb - Full Height)	7	1
Intel (NIC: 10 Gb - Low Profile)	3, 6	2
Intel (NIC: 1 Gb - Full Height)	7	1
Intel (NIC: 1 Gb - Low Profile)	3, 6	2
Mellanox (NIC: 100 Gb -Full Height)	7, 8	2
Mellanox (NIC: 100 Gb - Low Profile)	3, 6	2
Mellanox (NIC: 25 Gb - Full Height)	7	1
Mellanox (NIC: 25 Gb - Low Profile)	3, 6	2
Mellanox (NIC: HDR100 VPI - Low Profile)	3, 6	2
Mellanox (NIC:HDR VPI - Low Profile)	3, 6	2
QLogic (NIC: 25 Gb - Full Height)	7	1
QLogic (NIC: 25 Gb - Low Profile)	3, 6	2
QLogic (HBA: FC32 - Full Height)	7	1
QLogic (HBA: FC32 - Low Profile)	3, 6	2
QLogic (HBA: FC16 - Full Height)	7	1
QLogic (HBA: FC16 - Low Profile)	3, 6	2
QLogic (NIC: 10 Gb -Full Height)	7	1
QLogic (NIC: 10 Gb - Low Profile)	3, 6	2
Dell (External adapter - Full Height)	7	1
Dell (External adapter - Low Profile)	3, 6	2

Table 25. Configuration 10: R2A + R4B (continued)

Card type	Slot priority	Maximum number of cards
Samsung (PCIe SSD)	3, 6	1
Intel (PCIe SSD)	3, 6	1
Broadcom (OCP: 25 Gb)	Internal slot	1
QLogic (OCP: 25 Gb)	Internal slot	1
Mellanox (OCP: 25 Gb)	Internal slot	1
SolarFlare (OCP: 25 Gb)	Internal slot	1
Intel (OCP: 25 Gb)	Internal slot	1
Intel (OCP: 10 Gb)	Internal slot	1
Broadcom (OCP: 10 Gb)	Internal slot	1
QLogic (OCP: 10 Gb)	Internal slot	1
Broadcom (OCP: 1 Gb)	Internal slot	1
Intel (OCP: 1 Gb)	Internal slot	1

Table 26. Configuration 11: R1D + R2A + R3B + R4B

Card type	Slot priority	Maximum number of cards
Dell Serial port	4, 8	2
Dell BOSS-S2 Adapter	Internal slot	1
Dell BOSS-S1 card module (Full Height)	4, 5, 7, 8	4
Dell BOSS-S1 card module (Low Profile)	3, 6	2
FOXCONN (HBA355E, H840, HBA - 12 GBPS) (Full Height/ Low profile)	3, 4, 5, 6, 7	5
Broadcom (NIC: 100 Gb - Low Profile)	3, 6	2
Broadcom (NIC: 25 Gb - Low Profile)	3, 6	2
Broadcom (NIC: 10 Gb - Full Height)	4, 5, 7	3
Broadcom (NIC: 10 Gb - Low Profile)	3, 6	2
Broadcom (NIC: 1 Gb - Full Height)	4, 5, 7	3
Broadcom (NIC: 1 Gb - Low Profile)	3, 6	2
Emulex (HBA: FC64 - Full Height)	4, 5, 7	3
Emulex (HBA: FC64 - Low Profile)	3, 6	2
Emulex (HBA: FC32 - Full Height)	4, 5, 7	3
Emulex (HBA: FC32 - Low Profile)	3, 6	2
Emulex (HBA: FC16 - Full Height)	4, 5, 7	3
Emulex (HBA: FC16 - Low Profile)	3, 6	2
Intel (NIC: 100 Gb - Low Profile)	3, 6	2
Intel (NIC: 25 Gb - Full Height)	4, 5, 7	3
Intel (NIC: 25 Gb - Low Profile)	3, 6	2

Table 26. Configuration 11: R1D + R2A + R3B + R4B (continued)

Card type	Slot priority	Maximum number of cards
Intel (NIC: 10 Gb - Full Height)	4, 5, 7	3
Intel (NIC: 10 Gb - Low Profile)	3, 6	2
Intel (NIC: 1 Gb - Full Height)	4, 5, 7	3
Intel (NIC: 1 Gb - Low Profile)	3, 6	2
Mellanox (NIC: 100 Gb - Full Height)	4, 5, 7, 8	4
Mellanox (NIC: 100 Gb - Low Profile)	3, 6	2
Mellanox (NIC: 25 Gb - Low Profile)	3, 6	2
Mellanox (NIC: HDR100 VPI - Low Profile)	3, 6	2
Mellanox (NIC:HDR VPI - Low Profile)	3, 6	2
QLogic (NIC: 25 Gb - Full Height)	4, 5, 7	3
QLogic (NIC: 25 Gb - Low Profile)	3, 6	2
QLogic (HBA: FC32 - Full Height)	4, 5, 7	3
QLogic (HBA: FC32 - Low Profile)	3, 6	2
QLogic (HBA: FC16 - Full Height)	4, 5, 7	3
QLogic (HBA: FC16 - Low Profile)	3, 6	2
QLogic (NIC: 10 Gb -Full Height)	4, 5, 7	3
QLogic (NIC: 10 Gb - Low Profile)	3, 6	2
Dell (External adapter - Full Height)	4, 5, 7	3
Dell (External adapter - Low Profile)	3, 6	2
Samsung (PCIe SSD)	3, 6, 4, 5, 7, 8	6
Intel (PCIe SSD)	3, 6, 4, 5, 7, 8	6
Broadcom (OCP: 25 Gb)	Internal slot	1
QLogic (OCP: 25 Gb)	Internal slot	1
Mellanox (OCP: 25 Gb)	Internal slot	1
SolarFlare (OCP: 25 Gb)	Internal slot	1
Intel (OCP: 25 Gb)	Internal slot	1
Intel (OCP: 10 Gb)	Internal slot	1
Broadcom (OCP: 10 Gb)	Internal slot	1
QLogic (OCP: 10 Gb)	Internal slot	1
Broadcom (OCP: 1 Gb)	Internal slot	1
Intel (OCP: 1 Gb)	Internal slot	1

Table 27. Config12-1: R1D+R2A+R3A+R4A(FL)

Card type	Slot priority	Maximum number of cards
Dell BOSS-S2 Adapter	Internal slot	1

Table 27. Config12-1: R1D+R2A+R3A+R4A(FL) (continued)

Card type	Slot priority	Maximum number of cards
Dell BOSS-S1 card module (Low Profile)	3, 6	2
FOXCONN (HBA355E, H840, HBA - 12 GBPS) (Full Height/ Low profile)	3, 6	2
Broadcom (NIC: 100 Gb - Low Profile)	3, 6	2
Broadcom (NIC: 25 Gb - Low Profile)	3, 6	2
Broadcom (NIC: 10 Gb - Low Profile)	3, 6	2
Broadcom (NIC: 1 Gb - Low Profile)	3, 6	2
Emulex (HBA: FC64 - Low Profile)	3, 6	2
Emulex (HBA: FC32 - Low Profile)	3, 6	2
Emulex (HBA: FC16 - Low Profile)	3, 6	2
Intel (NIC: 100 Gb - Low Profile)	3, 6	2
Intel (NIC: 25 Gb - Low Profile)	3, 6	2
Intel (NIC: 10 Gb - Low Profile)	3, 6	2
Intel (NIC: 1 Gb - Low Profile)	3, 6	2
Mellanox (NIC: 100 Gb - Low Profile)	3, 6	2
Mellanox (NIC: 25 Gb - Low Profile)	3, 6	2
Mellanox (NIC: HDR100 VPI - Low Profile)	3, 6	2
Mellanox (NIC:HDR VPI - Low Profile)	3, 6	2
QLogic (NIC: 25 Gb - Low Profile)	3, 6	2
QLogic (HBA: FC32 - Low Profile)	3, 6	2
QLogic (HBA: FC16 - Low Profile)	3, 6	2
QLogic (NIC: 10 Gb - Low Profile)	3, 6	2
Xilinx (FPGA - Full Height)	5, 7	2
Dell (External adapter - Low Profile)	3, 6	2
Samsung (PCIe SSD)	3, 6	2
Intel (PCIe SSD)	3, 6	2
Broadcom (OCP: 25 Gb)	Internal slot	1
QLogic (OCP: 25 Gb)	Internal slot	1
Mellanox (OCP: 25 Gb)	Internal slot	1
SolarFlare (OCP: 25 Gb)	Internal slot	1
Intel (OCP: 25 Gb)	Internal slot	1
Intel (OCP: 10 Gb)	Internal slot	1
Broadcom (OCP: 10 Gb)	Internal slot	1
QLogic (OCP: 10 Gb)	Internal slot	1
Broadcom (OCP: 1 Gb)	Internal slot	1

Table 27. Config12-1: R1D+R2A+R3A+R4A(FL) (continued)

Card type	Slot priority	Maximum number of cards
Intel (OCP: 1 Gb)	Internal slot	1

Table 28. Configuration12-2:R1D+R2A+R3A+R4A (HL)

Card type	Slot priority	Maximum number of cards
Dell Serial port	4, 8	2
Dell BOSS-S2 Adapter	Internal slot	1
Dell BOSS-S1 card module (Full Height)	5, 7	2
Dell BOSS-S1 card module (Low Profile)	3, 6	2
FOXCONN (HBA355E, H840, HBA - 12 GBPS) (Full Height/ Low profile)	3, 6, 5, 7	4
Broadcom (NIC: 100 Gb - Full Height)	5, 7	2
Broadcom (NIC: 100 Gb - Low Profile)	3, 6	2
Broadcom (NIC: 25 Gb - Full Height)	5, 7	2
Broadcom (NIC: 25 Gb - Low Profile)	3, 6	2
Broadcom (NIC: 10 Gb - Full Height)	5, 7	2
Broadcom (NIC: 10 Gb - Low Profile)	3, 6	2
Broadcom (NIC: 1 Gb - Full Height)	5, 7	2
Broadcom (NIC: 1 Gb - Low Profile)	3, 6	2
Emulex (HBA: FC64 - Full Height)	5, 7	2
Emulex (HBA: FC64 - Low Profile)	3, 6	2
Emulex (HBA: FC32 - Full Height)	5, 7	2
Emulex (HBA: FC32 - Low Profile)	3, 6	2
Emulex (HBA: FC16 - Full Height)	5, 7	2
Emulex (HBA: FC16 - Low Profile)	3, 6	2
Intel (NIC: 100 Gb - Full Height)	5, 7	2
Intel (NIC: 100 Gb - Low Profile)	3, 6	2
Intel (NIC: 25 Gb - Full Height)	5, 7	2
Intel (NIC: 25 Gb - Low Profile)	3, 6	2
Intel (NIC: 10 Gb - Full Height)	5, 7	2
Intel (NIC: 10 Gb - Low Profile)	3, 6	2
Intel (NIC: 1 Gb - Full Height)	5, 7	2
Intel (NIC: 1 Gb - Low Profile)	3, 6	2
Mellanox (NIC: 100 Gb - Full Height)	5, 7	2
Mellanox (NIC: 100 Gb - Low Profile)	3, 6	2
Mellanox (NIC: 25 Gb - Full Height)	5, 7	2
Mellanox (NIC: 25 Gb - Low Profile)	3, 6	2
Mellanox (NIC: HDR100 VPI - Low Profile)	3, 6	2

Table 28. Configuration12-2:R1D+R2A+R3A+R4A (HL) (continued)

Card type	Slot priority	Maximum number of cards
Mellanox (NIC:HDR VPI - Low Profile)	3, 6	2
QLogic (NIC: 25 Gb - Full Height)	5, 7	2
QLogic (NIC: 25 Gb - Low Profile)	3, 6	2
QLogic (HBA: FC32 - Full Height)	5, 7	2
QLogic (HBA: FC32 - Low Profile)	3, 6	2
QLogic (HBA: FC16 - Full Height)	5, 7	2
QLogic (HBA: FC16 - Low Profile)	3, 6	2
QLogic (NIC: 10 Gb -Full Height)	5, 7	2
QLogic (NIC: 10 Gb - Low Profile)	3, 6	2
Dell (External adapter - Full Height)	5, 7	2
Dell (External adapter - Low Profile)	3, 6	2
Samsung (PCIe SSD)	3, 6, 5, 7	4
Intel (PCIe SSD)	3, 6, 5, 7	4
Broadcom (OCP: 25 Gb)	Internal slot	1
QLogic (OCP: 25 Gb)	Internal slot	1
Mellanox (OCP: 25 Gb)	Internal slot	1
SolarFlare (OCP: 25 Gb)	Internal slot	1
Intel (OCP: 25 Gb)	Internal slot	1
Intel (OCP: 10 Gb)	Internal slot	1
Broadcom (OCP: 10 Gb)	Internal slot	1
QLogic (OCP: 10 Gb)	Internal slot	1
Broadcom (OCP: 1 Gb)	Internal slot	1
Intel (OCP: 1 Gb)	Internal slot	1

Table 29. Configuration13-1: R1A+R2A+R3A (FL)

Card type	Slot priority	Maximum number of cards
Dell BOSS-S2 Adapter	Internal slot	1
Dell BOSS-S1 card module (Low Profile)	3, 6	2
FOXCONN (HBA355E, H840, HBA - 12 GBPS) (Full Height/ Low profile)	3, 6	2
Broadcom (NIC: 100 Gb - Low Profile)	3, 6	2
Broadcom (NIC: 25 Gb - Low Profile)	3, 6	2
Broadcom (NIC: 10 Gb - Low Profile)	3, 6	2
Broadcom (NIC: 1 Gb - Low Profile)	3, 6	2
Emulex (HBA: FC64 - Low Profile)	3, 6	2
Emulex (HBA: FC32 - Low Profile)	3, 6	2

Table 29. Configuration13-1: R1A+R2A+R3A (FL) (continued)

Card type	Slot priority	Maximum number of cards
Emulex (HBA: FC16 - Low Profile)	3, 6	2
Intel (NIC: 100 Gb - Low Profile)	3, 6	2
Intel (NIC: 25 Gb - Low Profile)	3, 6	2
Intel (NIC: 10 Gb - Low Profile)	3, 6	2
Intel (NIC: 1 Gb - Low Profile)	3, 6	2
Mellanox (NIC: 100 Gb - Low Profile)	3, 6	2
Mellanox (NIC: 25 Gb - Low Profile)	3, 6	2
Mellanox (NIC: HDR100 VPI - Low Profile)	3, 6	2
Mellanox (NIC:HDR VPI - Low Profile)	3, 6	2
QLogic (NIC: 25 Gb - Low Profile)	3, 6	2
QLogic (HBA: FC32 - Low Profile)	3, 6	2
QLogic (HBA: FC16 - Low Profile)	3, 6	2
QLogic (NIC: 10 Gb - Low Profile)	3, 6	2
Dell (External adapter - Low Profile)	3	1
Samsung (PCIe SSD)	3, 6	2
Intel (PCIe SSD)	3, 6	2
Broadcom (OCP: 25 Gb)	Internal slot	1
QLogic (OCP: 25 Gb)	Internal slot	1
Mellanox (OCP: 25 Gb)	Internal slot	1
SolarFlare (OCP: 25 Gb)	Internal slot	1
Intel (OCP: 25 Gb)	Internal slot	1
Intel (OCP: 10 Gb)	Internal slot	1
Broadcom (OCP: 10 Gb)	Internal slot	1
QLogic (OCP: 10 Gb)	Internal slot	1
Broadcom (OCP: 1 Gb)	Internal slot	1
Intel (OCP: 1 Gb)	Internal slot	1

Table 30. Configuration13-2: R1A+R2A+R3A (HL)

Card type	Slot priority	Maximum number of cards
Dell Serial port	4, 8	2
Dell BOSS-S2 Adapter	Internal slot	1
Dell BOSS-S1 card module (Full Height)	2, 5	2
Dell BOSS-S1 card module (Low Profile)	3, 6	2
FOXCONN (HBA355E, H840, HBA - 12 GBPS) (Full Height/ Low profile)	3, 6, 5, 7	4

Table 30. Configuration13-2: R1A+R2A+R3A (HL) (continued)

Card type	Slot priority	Maximum number of cards
Broadcom (NIC: 100 Gb - Full Height)	2, 5	2
Broadcom (NIC: 100 Gb - Low Profile)	3, 6	2
Broadcom (NIC: 25 Gb - Full Height)	2, 5	2
Broadcom (NIC: 25 Gb - Low Profile)	3, 6	2
Broadcom (NIC: 10 Gb - Full Height)	2, 5	2
Broadcom (NIC: 10 Gb - Low Profile)	3, 6	2
Broadcom (NIC: 1 Gb - Full Height)	2, 5	2
Broadcom (NIC: 1 Gb - Low Profile)	3, 6	2
Emulex (HBA: FC64 - Full Height)	2, 5	2
Emulex (HBA: FC64 - Low Profile)	3, 6	2
Emulex (HBA: FC32 - Full Height)	2, 5	2
Emulex (HBA: FC32 - Low Profile)	3, 6	2
Emulex (HBA: FC16 - Full Height)	2, 5	2
Emulex (HBA: FC16 - Low Profile)	3, 6	2
Intel (NIC: 100 Gb - Full Height)	2, 5	2
Intel (NIC: 100 Gb - Low Profile)	3, 6	2
Intel (NIC: 25 Gb - Full Height)	2, 5	2
Intel (NIC: 25 Gb - Low Profile)	3, 6	2
Intel (NIC: 10 Gb - Full Height)	2, 5	2
Intel (NIC: 10 Gb - Low Profile)	3, 6	2
Intel (NIC: 1 Gb - Full Height)	2, 5	2
Intel (NIC: 1 Gb - Low Profile)	3, 6	2
Mellanox (NIC: 100 Gb - Full Height)	2, 5	2
Mellanox (NIC: 100 Gb - Low Profile)	3, 6	2
Mellanox (NIC: 25 Gb - Full Height)	2, 5	2
Mellanox (NIC: 25 Gb - Low Profile)	3, 6	2
Mellanox (NIC: HDR100 VPI - Low Profile)	3, 6	2
Mellanox (NIC:HDR VPI - Low Profile)	3, 6	2
QLogic (NIC: 25 Gb - Full Height)	2, 5	2
QLogic (NIC: 25 Gb - Low Profile)	3, 6	2
QLogic (HBA: FC32 - Full Height)	2, 5	2
QLogic (HBA: FC32 - Low Profile)	3, 6	2
QLogic (HBA: FC16 - Full Height)	2, 5	2
QLogic (HBA: FC16 - Low Profile)	3, 6	2
QLogic (NIC: 10 Gb -Full Height)	5, 7	2
QLogic (NIC: 10 Gb - Low Profile)	3, 6	2
Dell (External adapter - Low Profile)	3, 6	2

Table 30. Configuration13-2: R1A+R2A+R3A (HL) (continued)

Card type	Slot priority	Maximum number of cards
Samsung (PCIe SSD)	3, 6, 2, 5	4
Intel (PCIe SSD)	3, 6, 2, 5	4
Broadcom (OCP: 25 Gb)	Internal slot	1
QLogic (OCP: 25 Gb)	Internal slot	1
Mellanox (OCP: 25 Gb)	Internal slot	1
SolarFlare (OCP: 25 Gb)	Internal slot	1
Intel (OCP: 25 Gb)	Internal slot	1
Intel (OCP: 10 Gb)	Internal slot	1
Broadcom (OCP: 10 Gb)	Internal slot	1
QLogic (OCP: 10 Gb)	Internal slot	1
Broadcom (OCP: 1 Gb)	Internal slot	1
Intel (OCP: 1 Gb)	Internal slot	1

Table 31. Configuration 14: R1B+R2A+R3B

Card type	Slot priority	Maximum number of cards
Dell Front PERC	Internal slot	1
Dell Serial	8	1
Dell BOSS Adapter (Full Height)	1, 2, 7, 8	2
Dell BOSS Adapter (Low Profile)	3, 6	1
FOXCONN (HBA355E, H840) (Full Height/ Low profile)	3, 6, 4, 5, 1, 2	2
FOXCONN (HBA - 12 GBPS) (Full Height)	4, 5, 1, 2	2
FOXCONN (HBA - 12 GBPS) (Low profile)	3, 6	2
Dell PERC Adapter	3, 2	1
Broadcom (NIC: 100 Gb - Low Profile)	3, 6	2
Broadcom (NIC: 25 Gb - Full Height)	4, 5, 1, 2	4
Broadcom (NIC: 25 Gb - Low Profile)	3, 6	2
Broadcom (NIC: 10 Gb - Full Height)	4, 5, 1, 2	4
Broadcom (NIC: 10 Gb - Low Profile)	3, 6	2
Broadcom (NIC: 1 Gb - Full Height)	4, 5, 1, 2	4
Broadcom (NIC: 1 Gb - Low Profile)	3, 6	2
Emulex (HBA: FC64 - Full Height)	4, 5, 1, 2	4
Emulex (HBA: FC64 - Low Profile)	3, 6	2
Emulex (HBA: FC32 - Full Height)	4, 5, 1, 2	4

Table 31. Configuration 14: R1B+R2A+R3B (continued)

Card type	Slot priority	Maximum number of cards
Emulex (HBA: FC32 - Low Profile)	3, 6	2
Emulex (HBA: FC16 - Full Height)	4, 5, 1, 2	4
Emulex (HBA: FC16 - Low Profile)	3, 6	2
Intel (NIC: 100 Gb - Full Height)	4, 5, 1, 2	4
Intel (NIC: 100 Gb - Low Profile)	3, 6	2
Intel (NIC: 25 Gb - Full Height)	4, 5, 1, 2	4
Intel (NIC: 25 Gb - Low Profile)	3, 6	2
Intel (NIC: 10 Gb - Full Height)	4, 5, 1, 2	4
Intel (NIC: 10 Gb - Low Profile)	3, 6	2
Intel (NIC: 1 Gb - Full Height)	4, 5, 1, 2	4
Intel (NIC: 1 Gb - Low Profile)	3, 6	2
Mellanox (NIC: 100 Gb - Full Height)	4, 5, 1, 2	4
Mellanox (NIC: 100 Gb - Low Profile)	3, 6	2
Mellanox (NIC: 25 Gb - Full Height)	4, 5, 1, 2	4
Mellanox (NIC: 25 Gb - Low Profile)	3, 6	2
Mellanox (NIC: HDR100 VPI - Low Profile)	4, 5, 1, 2	4
Mellanox (NIC:HDR VPI - Low Profile)	3, 6	2
QLogic (NIC: 25 Gb - Full Height)	4, 5, 1, 2	4
QLogic (NIC: 25 Gb - Low Profile)	3, 6	2
QLogic (HBA: FC32 - Full Height)	4, 5, 1, 2	4
QLogic (HBA: FC32 - Low Profile)	3, 6	2
QLogic (HBA: FC16 - Full Height)	4, 5, 1, 2	4
QLogic (HBA: FC16 - Low Profile)	3, 6	2
QLogic (NIC: 10 Gb -Full Height)	4, 5, 1, 2	4
QLogic (NIC: 10 Gb - Low Profile)	3, 6	2
Samsung (PCIe SSD)	3, 6, 4, 5, 1, 2	6
Intel (PCIe SSD)	3, 6, 4, 5, 1, 2	6
Broadcom (OCP: 25 Gb)	Internal slot	1
QLogic (OCP: 25 Gb)	Internal slot	1
Mellanox (OCP: 25 Gb)	Internal slot	1
SolarFlare (OCP: 25 Gb)	Internal slot	1
Intel (OCP: 25 Gb)	Internal slot	1
Intel (OCP: 10 Gb)	Internal slot	1
Broadcom (OCP: 10 Gb)	Internal slot	1

Table 31. Configuration 14: R1B+R2A+R3B (continued)

Card type	Slot priority	Maximum number of cards
QLogic (OCP: 10 Gb)	Internal slot	1
Broadcom (OCP: 1 Gb)	Internal slot	1
FOXCONN (ASSY,CRD,CTL,H755,FRONT)	Internal slot	1
Intel (OCP: 1 Gb)	Internal slot	1

Table 32. Configuration 15: R1D + R4D

Card type	Supplier	Category
Dell BOSS-S2 Adapter	Internal slot	1
Broadcom (OCP: 25 Gb)	Internal slot	1
QLogic (OCP: 25 Gb)	Internal slot	1
Mellanox (OCP: 25 Gb)	Internal slot	1
SolarFlare (OCP: 25 Gb)	Internal slot	1
Intel (OCP: 25 Gb)	Internal slot	1
Intel (OCP: 10 Gb)	Internal slot	1
Broadcom (OCP: 10 Gb)	Internal slot	1
QLogic (OCP: 10 Gb)	Internal slot	1
Broadcom (OCP: 1 Gb)	Internal slot	1

Power, thermal, and acoustics

Topics:

- Power
- Thermal
- Acoustics

Power

The PowerEdge R7525 system has an extensive collection of sensors that automatically track thermal activity, and helps to regulate temperature and reduce server noise and power consumption.

Table 33. Power tools and technologies

Feature	Description
PSU portfolio	Dell EMC's PSU portfolio includes intelligent features such as dynamically optimizing power usage while maintaining availability and redundancy.
Industry compliance	Dell EMC's servers are compliant with all relevant industry certifications and guidelines, including 80 PLUS, Climate Savers, and ENERGY STAR.
Power monitoring accuracy	PSU power monitoring improvements include: <ul style="list-style-type: none"> • Power monitoring accuracy of 1%, lower than the industry standard of 5% • Higher power reporting accuracy • Better performance under a power cap
Power capping	Use Dell EMC systems management software to set your system power cap to limit the output of a PSU and reduce system power consumption.
Systems management	iDRAC Enterprise provides server level management that monitors, reports, and controls power consumption at the processor, memory, and system level. Dell OpenManage Power Center delivers group power management at the rack, row, and data center level for servers, power distribution units, and uninterruptible power supplies.
Active power management	Node Manager is an embedded technology that provides individual server- level power reporting and power limiting functionality. Hot spare technology reduces consumption of redundant power supplies.
Fresh air cooling	See dell.com/fresh-air-cooling
Rack infrastructure	Dell EMC offers some of the industry's highest efficiency power infrastructure solutions, including: <ul style="list-style-type: none"> • Power distribution units (PDUs) • Uninterruptible power supplies (UPSs) • Energy Smart containment rack enclosures For additional information see: http://content.dell.com/us/en/enterprise/power-and-cooling-technologies-components-rack-infrastructure.aspx .

Thermal

The thermal management of the platform helps deliver high performance with the right amount of cooling to components, while maintaining the lowest fan speeds possible. This is done across a wide range of ambient temperatures from 10°C to 35°C (50°F to 95°F) and to extended ambient temperature ranges.

The thermal design of the PowerEdge R7525 reflects the following:

- Optimized thermal design: architecture built into the system layout.
- System component placement and layout are designed to provide maximum airflow coverage to critical components with minimum expense of fan power.
- Comprehensive thermal management achieved by regulating the fan speed based on several different responses from all system component temperature sensors, as well as inventory for system configurations. Temperature monitoring includes components such as processors, DIMMs, chipset, the inlet air ambient, hard disk drives, and LOM riser.
- Open and closed loop thermal fan control uses system configuration to determine fan speed based on inlet air ambient temperature. Closed loop thermal control method uses feedback temperatures to dynamically determine proper fan speeds.
- User-configurable settings in the iDRAC BIOS setup screen.

Cooling N+1 fan redundancy allows continuous operation with one fan failure in the system.

Acoustics

The PowerEdge R7525 is a rack-mount server appropriate for attended data center environment. However, lower acoustical output is attainable with proper hardware or software configurations. For example, the minimum configuration of R7525 is quiet enough for typical office environment.

Table 34. PowerEdgeR7525 acoustical performance

Configuration	Entry / Minimum	Volume / Typical	GPU	No Backplane	NVMe box	Volume / Typical 3
Acoustical Category	Category 1	Category 2	Category 5	Category 3	Category 5	Category 5
CPU	1 x 120 W	2 x 180 W	2 x 180 W	2 x 180 W	2 x 225 W	2 x 120 W
Memory	8 x 8 GB RDIMM	8 x 8 GB RDIMM	8 x 8 GB RDIMM	8 x 8 GB RDIMM	8 x 32GB RDIMM	16 x 16 GB RDIMM
Storage configuration: Front, Internal, Rear, PCIe	8 x 3.5-inch	16 x 2.5-inch	16 x 2.5-inch	0 hard drives	24 x 2.5-inch NVMe	12 x 3.5-inch + Rear 2 x 2.5-inch
Cards	H345	H745	H740	H745	100 GB PCI	H745
	OCP 2 x 10 G	2-port 25 GB	GPU Double-Wides	2-port 25 GB	OCP 2 x 25 G	1-port 10 GB
	LOM Down, 1-GB	OCP 1025 G	OCP 2 x 25 GB	OCP 1025 G	M.2	OCP 1025 G
		M.2	M.2	M.2	LOM Down, 1-GB	M.2
		LOM Down, 1-GB	LOM Down, 1-GB	LOM Down, 1-GB		LOM Down, 1-GB

The acoustical design of the PowerEdge R7525 reflects the following:

- Versatility—The PowerEdge R7525 has a reduced power draw in the data center. It is also quiet enough for office environment in typical and minimum configurations.
- High sound quality standards—Sound quality is different from sound power level and sound pressure level in that it describes how humans respond to sound annoyance such as whistles and hums. One of the sound quality metrics in the Dell specifications is the prominence ratio of a tone.
- Noise ramp and descent at boot from power-off—Fan speeds and noise levels ramp during the boot process (from power off to power on) to add a layer of protection to component cooling in when the system is not able to boot properly. To keep the boot process as quiet as possible, the fan speed reached during boot is limited to about half of full speed.
- Noise level dependencies—If acoustics are important to you, then you should consider several configuration choices and settings:

- For lower acoustical output, use a few lower rotational speed SATA hard drives, nearline SAS hard drives, or non-rotational devices such as SSDs. 15 k hard drives generate more acoustic noise than lower rotational speed hard drives. Also, noise increases with number of hard drives.
- Fan speeds and noise may increase from baseline factory configurations when certain profiles are changed by the user, or system configurations are updated. The following is a list of items that impact fan speeds and acoustical output:
 - iDRAC9 BIOS settings—Performance Per Watt, DAPC or operating system, may be quieter than Performance or Dense Configuration (**iDRAC Settings > Thermal > Max. Exhaust Temperature or Fan speed offset**).
 - The quantity and type of PCIe cards installed—This affects overall system acoustics. Installation of more than two PCIe cards results in an increase in overall system acoustics.
 - Using a GPU card—GPU card results in an increase in overall system acoustics.
 - PCIe controller-based SSD drives—Drives such as express flash drives and Fusion IO cards require greater airflow for cooling, and result in higher noise levels
 - Systems with an H330 PERC—This configuration may be quieter than configurations with an H740P PERC with battery backup. However, higher noise levels result when a system is configured as non-RAID.
 - Hot spare feature of power supply unit—In the system default setting, the hot spare feature is disabled. Acoustical output from the power supplies is lowest in this setting.

Supported operating systems

The PowerEdge R7525 supports the following operating systems:

- Canonical Ubuntu Server LTS
- Citrix XenServer
- Microsoft Windows Server with Hyper-V
- Red Hat Enterprise Linux
- SUSE Linux Enterprise Server
- VMware vSAN/ESXi

For more information, see www.dell.com/ossupport.

Dell Technologies Services

Dell Technologies Services include a wide, customizable range of service choices to simplify the assessment, design, implementation, management and maintenance of IT environments and to help you transition from platform to platform. Depending on your current business requirements and the level of service right for you, we provide factory, on-site, remote, modular, and specialized services that fit your needs and budget. We'll help with a little or a lot—your choice—and provide access to our global resources.

For more information, see DellEMC.com/Services.

Topics:

- [Dell EMC ProDeploy Enterprise Suite](#)
- [Dell EMC Remote Consulting Services](#)
- [Dell EMC Data Migration Service](#)
- [Dell EMC ProSupport Enterprise Suite](#)
- [Dell EMC ProSupport Plus for Enterprise](#)
- [Dell EMC ProSupport for Enterprise](#)
- [Dell EMC ProSupport One for Data Center](#)
- [ProSupport for HPC](#)
- [Support Technologies](#)
- [Dell Technologies Education Services](#)
- [Dell Technologies Consulting Services](#)
- [Dell EMC Managed Services](#)

Dell EMC ProDeploy Enterprise Suite

ProDeploy Enterprise Suite gets your server out of the box and into optimized production—fast. Our elite deployment engineers with broad and deep experience utilizing best-in-class processes along with our established global scale can help you around the clock and around the globe. From simple to the most complex server installations and software integration, we take the guess work and risk out of deploying your new server technology.

		Basic Deployment	ProDeploy	ProDeploy Plus
Pre-deployment	Single point of contact for project management	-	●	In-region
	Site readiness review	-	●	●
	Implementation planning	-	●	●
	SAM engagement for ProSupport Plus entitled devices	-	-	●
Deployment	Deployment service hours	Business hours	24x7	24x7
	Remote guidance for hardware installation or Onsite hardware installation and packaging material removal	Onsite	Remote or Onsite	Onsite
	Install and configure system software	-	Remote	Onsite
	Install support software and connect with Dell Technologies	-	●	●
	Project documentation with knowledge transfer	-	●	●
	Post-deployment	Deployment verification	-	●
Configuration data transfer to Dell EMC technical support		-	●	●
30-days of post-deployment configuration assistance		-	-	●
Training credits for Dell EMC Education Services		-	-	●

Figure 10. ProDeploy Enterprise Suite capabilities

NOTE: Hardware installation not applicable on selected software products.

Dell EMC ProDeploy Plus

From beginning to end, ProDeploy Plus provides the skill and scale needed to successfully execute demanding deployments in today's complex IT environments. Certified Dell EMC experts start with extensive environmental assessments and detailed migration planning and recommendations. Software installation includes set up of most versions of Dell EMC SupportAssist and OpenManage system management utilities. Post-deployment configuration assistance, testing, and product orientation services are also available.

Dell EMC ProDeploy

ProDeploy provides full service installation and configuration of both server hardware and system software by certified deployment engineers including set up of leading operating systems and hypervisors as well as most versions of Dell EMC SupportAssist and OpenManage system management utilities. To prepare for the deployment, we conduct a site readiness review and implementation planning exercise. System testing, validation, and full project documentation with knowledge transfer complete the process.

Basic Deployment

Basic Deployment delivers worry-free professional installation by experienced technicians who know Dell EMC servers inside and out.

Dell EMC Server Configuration Services

With Dell EMC Rack Integration and other Dell EMC PowerEdge Server Configuration Services, you save time by receiving your systems racked, cabled, tested, and ready to integrate into the data center. Dell EMC staff pre-configure RAID, BIOS and iDRAC settings, install system images, and even install third-party hardware and software.

For more information, see [Server Configuration Services](#).

Dell EMC Residency Services

Residency Services helps customers transition to new capabilities quickly with the assistance of on-site or remote Dell EMC experts whose priorities and time you control. Residency experts can provide post implementation management and knowledge transfer related to a new technology acquisition or day-to-day operational management of the IT infrastructure.

Dell EMC Remote Consulting Services

When you are in the final stages of your PowerEdge server implementation, you can rely on Dell EMC Remote Consulting Services and our certified technical experts to help you optimize your configuration with best practices for your software, virtualization, server, storage, networking, and systems management.

Dell EMC Data Migration Service

Protect your business and data with our single point of contact to manage your data migration project. Your project manager will work with our experienced team of experts to create a plan using industry-leading tools and proven processes based on global best practices to migrate your existing files and data so your business system get up and running quickly and smoothly.

Dell EMC ProSupport Enterprise Suite

With the ProSupport Enterprise Suite, we help keep your IT systems running smoothly, so you can focus on running your business. We will help maintain peak performance and availability of your most essential workloads. ProSupport Enterprise Suite is a suite of support services that enable you to build the solution that is right for your organization.

Choose support models based on how you use technology and where you want to allocate resources. From the desktop to the data center, address everyday IT challenges, such as unplanned downtime, mission-critical needs, data and asset protection, support planning, resource allocation, software application management and more. Optimize IT resources by choosing the right support model.



Figure 11. Dell EMC ProSupport Enterprise Suite

Dell EMC ProSupport Plus for Enterprise

When you purchase your PowerEdge server, we recommend ProSupport Plus, our proactive and preventative support service for your business-critical systems. ProSupport Plus provides you with all the benefits of ProSupport, plus the following:

- An assigned Services Account Manager who knows your business and your environment
- Immediate advanced troubleshooting from an engineer who understands your PowerEdge server
- Personalized, preventive recommendations based on analysis of support trends and best practices from across the Dell Technologies infrastructure solutions customer base to reduce support issues and improve performance
- Predictive analysis for issue prevention and optimization enabled by SupportAssist
- Proactive monitoring, issue detection, notification, and automated case creation for accelerated issue resolution enabled by SupportAssist
- On-demand reporting and analytics-based recommendations enabled by SupportAssist and TechDirect

Dell EMC ProSupport for Enterprise

Our ProSupport service offers highly trained experts around the clock and around the globe to address your IT needs. We help minimize disruptions and maximize availability of PowerEdge server workloads with:

- 24x7 support through phone, chat and online
- Predictive, automated tools and innovative technology
- A central point of accountability for all hardware and software issues
- Collaborative 3rd party support
- Hypervisor, operating system and application support
- Consistent experience regardless of where you are located or what language you speak
- Optional onsite parts and labor response options including next business day or four-hour mission critical

i **NOTE:** Subject to service offer country availability.

Enterprise Support Services Feature Comparison

	Basic	ProSupport	ProSupport Plus
Remote technical support	9x5	24x7	24x7
Covered products	Hardware	Hardware Software	Hardware Software
Onsite hardware support	Next business day	Next business day or 4hr mission critical	Next business day or 4 hr mission critical
3 rd party collaborative assistance		●	●
Automated issue detection & proactive case creation		●	●
Self-service case initiation and management		●	●
Access to software updates		●	●
Priority access to specialized support experts			●
3 rd party software support			●
Assigned Services Account Manager			●
Personalized assessments and recommendations			●
Semiannual systems maintenance			●

Availability and terms of Dell Technologies services vary by region and by product. For more information, please view our Service Descriptions available on Dell.com

Figure 12. Dell EMC Enterprise Support model

Dell EMC ProSupport One for Data Center

ProSupport One for Data Center offers flexible site-wide support for large and distributed data centers with more than 1,000 assets. This offering is built on standard ProSupport components that leverage our global scale but are tailored to your company's needs. While not for everyone, this service option offers a truly unique solution for Dell Technologies largest customers with the most complex environments.

- Team of assigned Services Account Managers with remote, on-site options
- Assigned ProSupport One technical and field engineers who are trained on your environment and configurations
- On-demand reporting and analytics-based recommendations enabled by SupportAssist and TechDirect
- Flexible on-site support and parts options that fit your operational model
- A tailored support plan and training for your operations staff

ProSupport for HPC

The ProSupport for HPC provides solution-aware support including:

- Access to senior HPC experts
- Advanced HPC cluster assistance: performance, interoperability & configuration
- Enhanced HPC solution level end-to-end support
- Remote pre-support engagement with HPC Specialists during ProDeploy implementation

Learn more at DellEMC.com/HPC-Services.

ProSupport Add-on for HPC

Delivering a true end-to-end support experience across your HPC environment

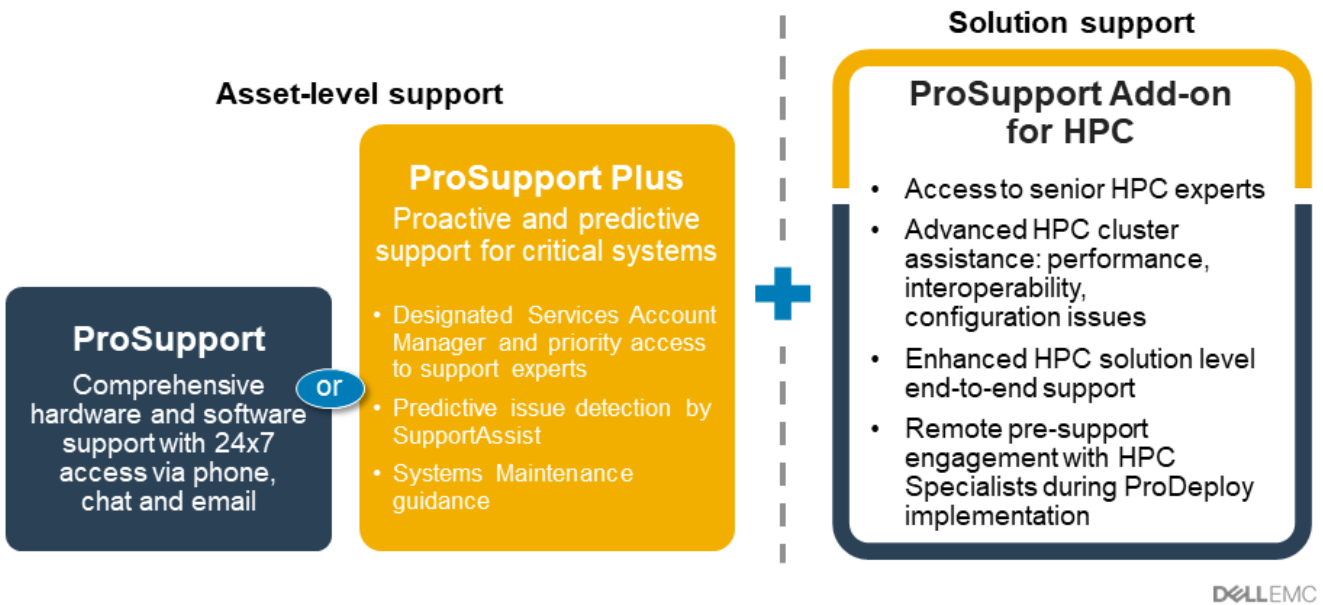

Figure 13. ProSupport for HPC

Support Technologies

Powering your support experience with predictive, data-driven technologies.

Dell EMC SupportAssist

The best time to solve a problem is before it happens. The automated proactive and predictive technology SupportAssist helps reduce steps and time to resolution, often detecting issues before they become a crisis. Benefits include:

- Value—SupportAssist is available to all customers at no additional charge
- Improve productivity—replace manual, high-effort routines with automated support
- Accelerate time to resolution—receive issue alerts, automatic case creation, and proactive contact from Dell EMC experts
- Gain insight and control—optimize enterprise devices with on-demand ProSupport Plus reporting in TechDirect, and get predictive issue detection before the problem starts

NOTE: SupportAssist is included with all support plans, but features vary based on service level agreement.

	Basic Hardware Warranty	ProSupport	ProSupport Plus
Automated issue detection and system state information collection	•	•	•
Proactive, automated case creation and notification		•	•
Predictive issue detection for failure prevention			•
Recommendation reporting available on-demand in TechDirect			•

Figure 14. SupportAssist model

Get started at Dell.com/SupportAssist

Dell EMC TechDirect

Boost IT team productivity when supporting Dell EMC systems. With over 1.4 million self-dispatches processed each year, TechDirect has proven its effectiveness as a support tool. You can:

- Self-dispatch replacement parts
- Request technical support
- Integrate APIs into your help desk

Or, access all your Dell EMC certification and authorization requirements. Train your staff on Dell EMC products, as TechDirect allows you to:

- Download study guides
- Schedule certification and authorization exams
- View transcripts of completed courses and exams

Register at techdirect.dell.

Dell Technologies Education Services

Build the IT skills required to influence the transformational outcomes of the business. Enable talent and empower teams with the right skills to lead and execute transformational strategy that drives competitive advantage. Leverage the training and certification required for real transformation.

Dell Technologies Education Services offers PowerEdge server training and certifications designed to help you achieve more from your hardware investment. The curriculum delivers the information and the practical, hands-on skills that you and your team need to confidently install, configure, manage, and troubleshoot your Dell EMC servers. To learn more or register for a class today, see LearnDell.com/Server.

Dell Technologies Consulting Services

Our expert consultants help you transform faster, and quickly achieve business outcomes for the high value workloads Dell EMC PowerEdge systems can handle.

From strategy to full-scale implementation, Dell Technologies Consulting can help you determine how to execute your IT, workforce, or application transformation.

We use prescriptive approaches and proven methodologies combined with Dell Technologies' portfolio and partner ecosystem to help you achieve real business outcomes. From multi-cloud, applications, DevOps, and infrastructure transformations, to business resiliency, data center modernization, analytics, workforce collaboration, and user experiences—we're here to help.

Dell EMC Managed Services

Reduce the cost, complexity, and risk of managing IT. Focus your resources on digital innovation and transformation while our experts help optimize your IT operations and investment with managed services backed by guaranteed service levels.

Dell EMC OpenManage systems management

Dell EMC OpenManage Portfolio

Simplifying hardware management through ease of use and automation

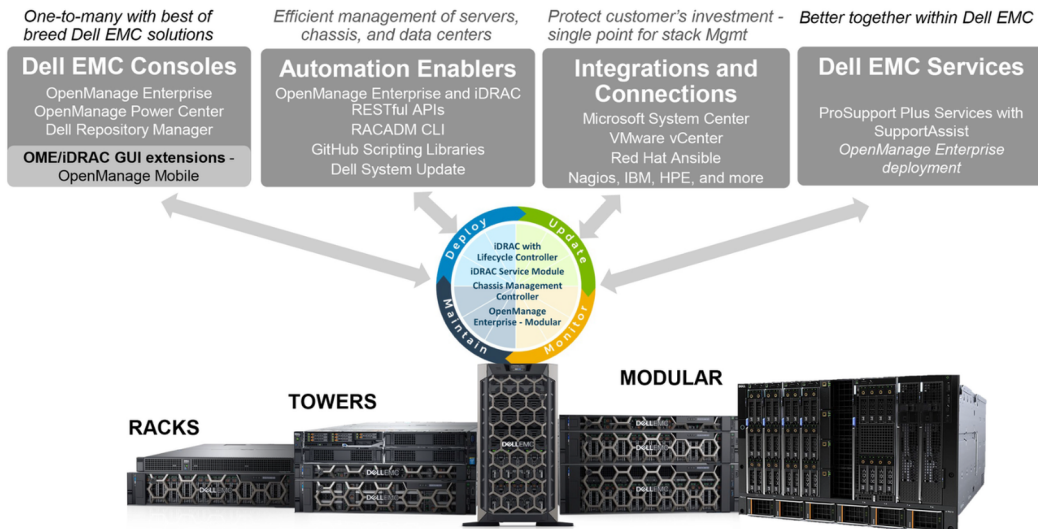

Figure 15. Dell EMC OpenManage Portfolio

Dell EMC delivers management solutions that help IT Administrators effectively deploy, update, monitor, and manage IT assets. OpenManage solutions and tools enable you to quickly respond to problems by helping them to manage Dell EMC servers effectively and efficiently; in physical, virtual, local, and remote environments, operating in-band, and out-of-band (agent-free). The OpenManage portfolio includes innovative embedded management tools such as the integrated Dell Remote Access Controller (iDRAC), Chassis Management Controller and Consoles like OpenManage Enterprise, OpenManage Power Manager plug in, and tools like Repository Manager.

Dell EMC has developed comprehensive systems management solutions based on open standards and has integrated with management consoles that can perform advanced management of Dell hardware. Dell EMC has connected or integrated the advanced management capabilities of Dell hardware into offerings from the industry's top systems management vendors and frameworks such as Ansible, thus making Dell EMC platforms easy to deploy, update, monitor, and manage.

The key tools for managing Dell EMC PowerEdge servers are iDRAC and the one-to-many OpenManage Enterprise console. OpenManage Enterprise helps the system administrators in complete lifecycle management of multiple generations of PowerEdge servers. Other tools such as Repository Manager, which enables simple yet comprehensive change management.

OpenManage tools integrate with systems management framework from other vendors such as VMware, Microsoft, Ansible, and ServiceNow. This enables you to use the skills of the IT staff to efficiently manage Dell EMC PowerEdge servers.

Topics:

- [Server and Chassis Managers](#)
- [Dell EMC consoles](#)
- [Automation Enablers](#)
- [Integration with third-party consoles](#)
- [Connections for third-party consoles](#)
- [Dell EMC Update Utilities](#)
- [Dell resources](#)

Server and Chassis Managers

- Integrated Dell Remote Access Controller (iDRAC)
- iDRAC Service Module (iSM)

Dell EMC consoles

- Dell EMC OpenManage Enterprise
- Dell EMC Repository Manager (DRM)
- Dell EMC OpenManage Enterprise Power Manager plugin to OpenManage Enterprise
- Dell EMC OpenManage Mobile (OMM)

Automation Enablers

- OpenManage Ansible Modules
- iDRAC RESTful APIs (Redfish)
- Standards-based APIs (Python, PowerShell)
- RACADM Command Line Interface (CLI)
- GitHub Scripting Libraries

Integration with third-party consoles

- Dell EMC OpenManage Integrations with Microsoft System Center
- Dell EMC OpenManage Integration for VMware vCenter (OMIVV)
- Dell EMC OpenManage Ansible Modules
- Dell EMC OpenManage Integration with ServiceNow

Connections for third-party consoles

- Micro Focus and other HPE tools
- OpenManage Connection for IBM Tivoli
- OpenManage Plug-in for Nagios Core and XI

Dell EMC Update Utilities

- Dell System Update (DSU)
- Dell EMC Repository Manager (DRM)
- Dell EMC Update Packages (DUP)
- Dell EMC Server Update Utility (SUU)
- Dell EMC Platform Specific Bootable ISO (PSBI)

Dell resources

For additional information about white papers, videos, blogs, forums, technical material, tools, usage examples, and other information, go to the OpenManage page at <https://www.dell.com/openmanagemanuals> or the following product pages:

Table 35. Dell resources

Resource	Location
Integrated Dell Remote Access Controller (iDRAC)	https://www.dell.com/idracmanuals
iDRAC Service Module (iSM)	https://www.dell.com/support/kbdoc/000178050/
OpenManage Ansible Modules	https://www.dell.com/support/kbdoc/000177308/
OpenManage Essentials (OME)	https://www.dell.com/support/kbdoc/000175879/
OpenManage Mobile (OMM)	https://www.dell.com/support/kbdoc/000176046
OpenManage Integration for VMware vCenter (OMIVV)	https://www.dell.com/support/kbdoc/000176981/
OpenManage Integration for Microsoft System Center (OMIMSSC)	https://www.dell.com/support/kbdoc/000147399
Dell EMC Repository Manager (DRM)	https://www.dell.com/support/kbdoc/000177083
Dell EMC System Update (DSU)	https://www.dell.com/support/kbdoc/000130590
Dell EMC Platform Specific Bootable ISO (PSBI)	Dell.com/support/article/sln296511
Dell EMC Chassis Management Controller (CMC)	www.dell.com/support/article/sln311283
OpenManage Connections for Partner Consoles	https://www.dell.com/support/kbdoc/000146912
OpenManage Enterprise Power Manager	https://www.dell.com/support/kbdoc/000176254
OpenManage Integration with ServiceNow (OMISNOW)	Dell.com/support/article/sln317784

 **NOTE:** Features may vary by server. Please refer to the product page on <https://www.dell.com/manuals> for details.

Appendix A. Additional specifications

Topics:

- Chassis dimensions
- Chassis weight
- Video specifications
- USB ports specifications
- Environmental specifications

Chassis dimensions

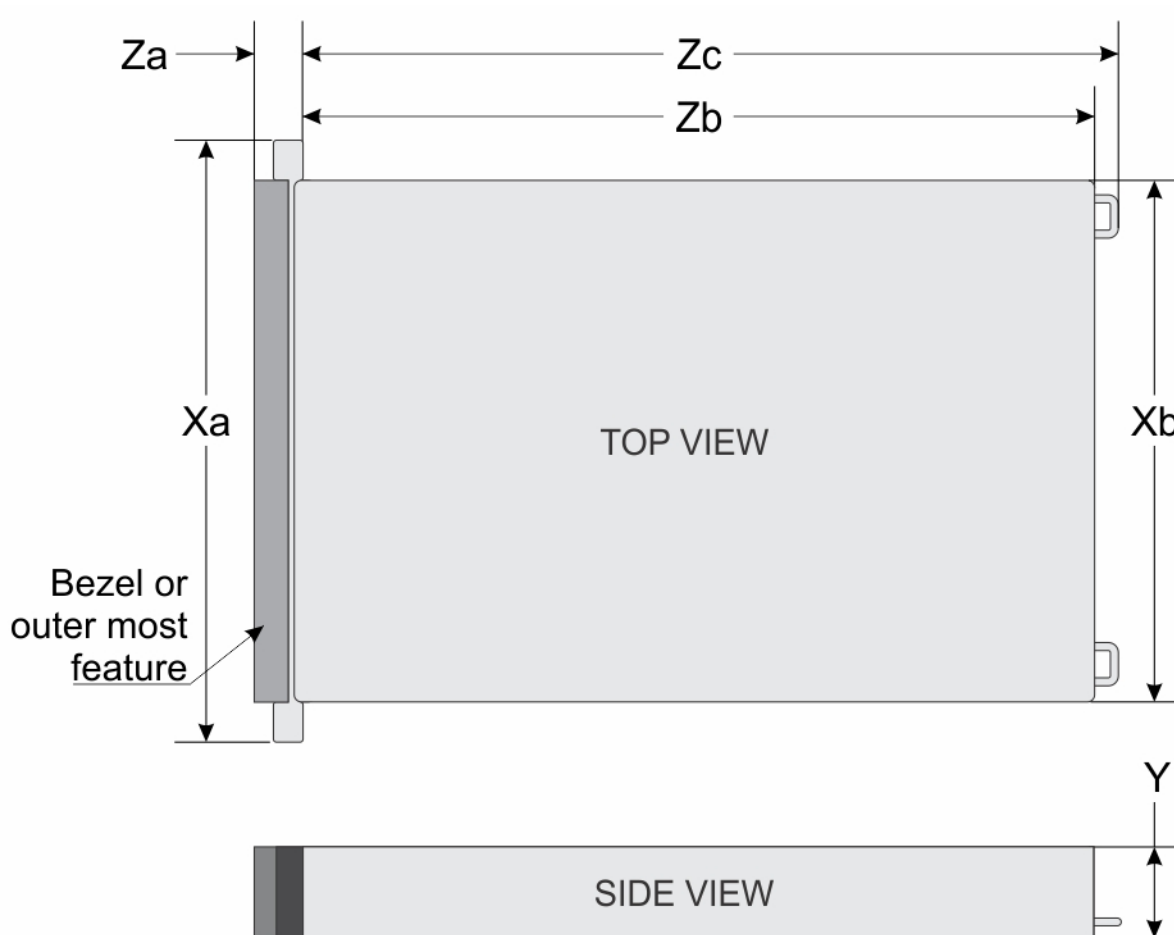

Figure 16. Chassis dimensions

Table 36. PowerEdge R7525

Drives	Xa	Xb	Y	Za	Zb	Zc
12 drives	482.0 mm (18.97 inches)	434.0 mm (17.08 inches)	86.8 mm (3.41 inches)	With bezel: 35.84 mm (1.4 inches)	700.7 mm (27.58 inches)	736.29 mm (28.98 inches)

Table 36. PowerEdge R7525 (continued)

Drives	Xa	Xb	Y	Za	Zb	Zc
				Without bezel: 22.0 mm (0.87 inches)	(Ear to rear wall)	(Ear to PSU handle)
24 drives	482.0 mm (18.97 inches)	434.0 mm (17.08 inches)	86.8 mm (3.41 inches)	With bezel: 35.84 mm (1.4 inches) Without bezel: 22.0 mm (0.87 inches)	700.7 mm (27.58 inches) (Ear to rear wall)	736.29 mm (28.98 inches) (Ear to PSU handle)

NOTE: Zb is the nominal rear wall external surface where the system board I/O connectors reside.

Chassis weight

Table 37. PowerEdge R7525

System configuration	Maximum weight (with all drives/SSDs)
12 x 3.5-inch	36.3 kg (80.02 lb)
8 x 3.5-inch	33.2 kg (73.19 lb)
24 x 2.5-inch	28.6 kg (63.05 lb)
16 x 2.5-inch	26.6 kg (58.64 lb)
8 x 2.5-inch	24.6 kg (54.23 lb)

Video specifications

The PowerEdge R7525 system supports integrated Matrox G200 graphics controller with 16 MB of video frame buffer.

Table 38. Supported front video resolution options

Resolution	Refresh rate (Hz)	Color depth (bits)
1024 x 768	60	8, 16, 32
1280 x 800	60	8, 16, 32
1280 x 1024	60	8, 16, 32
1360 x 768	60	8, 16, 32
1440 x 900	60	8, 16, 32

Table 39. Supported rear video resolution options

Resolution	Refresh rate (Hz)	Color depth (bits)
1024 x 768	60	8, 16, 32
1280 x 800	60	8, 16, 32
1280 x 1024	60	8, 16, 32
1360 x 768	60	8, 16, 32
1440 x 900	60	8, 16, 32
1600 x 900	60	8, 16, 32

Table 39. Supported rear video resolution options (continued)

Resolution	Refresh rate (Hz)	Color depth (bits)
1600 x 1200	60	8, 16, 32
1680 x 1050	60	8, 16, 32
1920 x 1080	60	8, 16, 32
1920 x 1200	60	8, 16, 32

USB ports specifications

Table 40. PowerEdge R7525 system USB specifications

Front		Rear		Internal (Optional)	
USB port type	No. of ports	USB port type	No. of ports	USB port type	No. of ports
USB 2.0-compliant port	One	USB 3.0-compliant ports	One	Internal USB 3.0-compliant port	One
Micro-USB 2.0 compliant port	One	USB 2.0-compliant ports	One		

- NOTE:** The micro USB 2.0 compliant port can only be used as an iDRAC Direct or a management port.
- NOTE:** The USB 2.0 specifications provide a 5 V supply on a single wire to power connected USB devices. A unit load is defined as 100 mA in USB 2.0, and 150 mA in USB 3.0. A device may draw a maximum of 5 unit loads (500 mA) from a port in USB 2.0; 6 (900 mA) in USB 3.0.
- NOTE:** The USB 2.0 interface can provide power to low-power peripherals but must adhere to USB specification. An external power source is required for higher-power peripherals to function, such as external CD/DVD Drives.

Environmental specifications

- NOTE:** For additional information about environmental certifications, refer to the *Product Environmental Datasheet* located with the Manuals & Documents on www.dell.com/support/home.

Table 41. Operational climatic range category A2

Temperature	Specifications
Allowable continuous operations	
Temperature ranges for altitudes <= 900 m (<= 2953 ft)	10–35°C (50–95°F) with no direct sunlight on the equipment
Humidity percent ranges (non-condensing at all times)	8% RH with -12°C minimum dew point to 80% RH with 21°C (69.8°F) maximum dew point
Operational altitude de-rating	Maximum temperature is reduced by 1°C/300 m (33.8°F/984 Ft) above 900 m (2953 Ft)

Table 42. Operational climatic range category A3

Temperature	Specifications
Allowable continuous operations	
Temperature ranges for altitudes <= 900 m (<= 2953 ft)	5–40°C (41–104°F) with no direct sunlight on the equipment

Table 42. Operational climatic range category A3 (continued)

Temperature	Specifications
Humidity percent ranges (non-condensing at all times)	8% RH with -12°C minimum dew point to 85% RH with 24°C (75.2°F) maximum dew point
Operational altitude de-rating	Maximum temperature is reduced by 1°C/175 m (33.8°F/574 Ft) above 900 m (2953 Ft)

Table 43. Operational climatic range category A4

Temperature	Specifications
Allowable continuous operations	
Temperature ranges for altitudes <= 900 m (<= 2953 ft)	5–45°C (41–113°F) with no direct sunlight on the equipment
Humidity percent ranges (non-condensing at all times)	8% RH with -12°C minimum dew point to 90% RH with 24°C (75.2°F) maximum dew point
Operational altitude de-rating	Maximum temperature is reduced by 1°C/125 m (33.8°F/410 Ft) above 900 m (2953 Ft)

Table 44. Shared requirements across all categories

Temperature	Specifications
Allowable continuous operations	
Maximum temperature gradient (applies to both operation and non-operation)	20°C in an hour* (36°F in an hour) and 5°C in 15 minutes (41°F in 15 minutes), 5°C in an hour* (41°F in an hour) for tape <i>i</i> NOTE: * - Per ASHRAE thermal guidelines for tape hardware, these are not instantaneous rates of temperature change.
Non-operational temperature limits	-40 to 65°C (-104 to 149°F)
Non-operational humidity limits	5% to 95% RH with 27°C (80.6°F) maximum dew point
Maximum non-operational altitude	12,000 meters (39,370 feet)
Maximum operational altitude	3,048 meters (10,000 feet)

Table 45. Maximum vibration specifications

Maximum vibration	Specifications
Operating	0.26 G _{rms} at 5 Hz to 350 Hz (all operation orientations)
Storage	1.88 G _{rms} at 10 Hz to 500 Hz for 15 minutes (all six sides tested)

Table 46. Maximum shock pulse specifications

Maximum shock pulse	Specifications
Operating	Six consecutively executed shock pulses in the positive and negative x, y, and z axis of 6 G for up to 11 ms.
Storage	Six consecutively executed shock pulses in the positive and negative x, y, and z axis (one pulse on each side of the system) of 71 G for up to 2 ms.

Thermal restriction matrix

Table 47. Thermal restriction matrix

Configurati on	8 x 2.5- inch NVM e	16 x 2.5- inch SAS	16 x 2.5- inch NVM e	24 x 2.5-inch SAS			16 x 2.5- inch SAS + 8 x 2.5- inch NVM e	24 x 2.5- inch NV Me	8 x 3.5- inch	12 x 3.5-inch			Ambie nt tempe rature		
	Rear storage	No Rear Drive s	No Rear Drive s	No Rear Drive s	No Rear Drives	2 x Rear 2.5- inch No Rear Fan	4 x Rear 2.5- inch with Rear Fan	No Rear Drives	No Rear Drive s	No Rear Drives	No Rear Drives	2 x Rear 2.5- inch No Rear Fan		4 x Rear 2.5- inch with Rear Fan	
CPU TDP/ cTDP	120 W	STD fan 1U STD HSK	STD fan 1U STD HSK	STD fan 1U STD HSK	STD fan 1U STD HSK	HPR fan 1U STD HSK	HPR fan 1U STD HSK	STD fan 1U STD HSK	HPR fan 1U STD HSK	STD fan 1U STD HSK	HPR fan 1U STD HSK	HPR fan 1U STD HSK	HPR fan 1U STD HSK	35°C	
	155 W	STD fan 1U STD HSK	STD fan 1U STD HSK	STD fan 1U STD HSK	STD fan 1U STD HSK	HPR fan 1U STD HSK	HPR fan 1U STD HSK	STD fan 1U STD HSK	HPR fan 1U STD HSK	STD fan 1U STD HSK	HPR fan 1U STD HSK	HPR fan 1U STD HSK	HPR fan 1U STD HSK	35°C	
	170 W	STD fan 1U STD HSK	STD fan 1U STD HSK	STD fan 1U STD HSK	STD fan 1U STD HSK	HPR fan 1U STD HSK	HPR fan 1U STD HSK	STD fan 1U STD HSK	HPR fan 1U STD HSK	STD fan 1U STD HSK	HPR fan 1U STD HSK	HPR fan 1U STD HSK	HPR fan 1U STD HSK	35°C	
	180 W	STD fan 2U Full HSK	STD fan 2U Full HSK	STD fan 2U Full HSK	STD fan 2U Full HSK	HPR fan 2U Full HSK	HPR fan 2U Full HSK	STD fan 2U Full HSK	HPR fan 2U Full HSK	STD fan 2U Full HSK	HPR fan 2U Full HSK	HPR fan 2U Full HSK	HPR fan 2U Full HSK	HPR fan 2U Full HSK	35°C
	200 W	STD fan 2U Full HSK	STD fan 2U Full HSK	STD fan 2U Full HSK	STD fan 2U Full HSK	HPR fan 2U Full HSK	HPR fan 2U Full HSK	STD fan 2U Full HSK	HPR fan 2U Full HSK	STD fan 2U Full HSK	HPR fan 2U Full HSK	HPR fan 2U Full HSK	HPR fan 2U Full HSK	HPR fan 2U Full HSK	35°C
	225 W	STD fan 2U Full HSK	STD fan 2U Full HSK	STD fan 2U Full HSK	STD fan 2U Full HSK	HPR fan 2U Full HSK	HPR fan 2U Full HSK	STD fan 2U Full HSK	HPR fan 2U Full HSK	STD fan 2U Full HSK	HPR fan 2U Full HSK	HPR fan 2U Full HSK	HPR fan 2U Full HSK	HPR fan 2U Full HSK	35°C
	240 W	STD fan	STD fan	STD fan	STD fan 2U Full HSK	HPR fan 2U Full HSK	HPR fan 2U Full HSK	STD fan 2U Full HSK	HPR fan	STD fan 2U Full HSK	HPR fan 2U Full HSK	HPR fan 2U Full HSK	HPR fan 2U Full HSK	HPR fan 2U Full HSK	35°C

Table 47. Thermal restriction matrix (continued)

Configurat ion	8 x 2.5- inch NVM e	16 x 2.5- inch SAS	16 x 2.5- inch NVM e	24 x 2.5-inch SAS			16 x 2.5- inch SAS + 8 x 2.5- inch NVM e	24 x 2.5- inch NV Me	8 x 3.5- inch	12 x 3.5-inch			Ambie nt tempe rature	
				No Rear Drive s	No Rear Drive s	No Rear Drive s				No Rear Drive s	2 x Rear 2.5- inch No Rear Fan	4 x Rear 2.5- inch with Rear Fan		No Rear Drive s
		2U Full HSK	2U Full HSK	2U Full HSK					2U Full HSK					
	280 W - 64C	STD fan 2U Full HSK	STD fan 2U Full HSK	STD fan 2U Full HSK	STD fan* 2U Full HSK	HPR fan 2U Full HSK	VHP fan 2U Full HSK	STD fan* 2U Full HSK	HPR fan* 2U Full HSK	STD fan 2U Full HSK	HPR fan* 2U Full HSK	HPR fan* 2U Full HSK	HPR fan* 2U Full HSK	35°C
	280 W - 32C	STD fan 2U Full HSK	STD fan 2U Full HSK	STD fan 2U Full HSK	STD fan* 2U Full HSK	HPR fan 2U Full HSK	VHP fan 2U Full HSK	STD fan* 2U Full HSK	HPR fan* 2U Full HSK	STD fan 2U Full HSK	-	-	-	35°C
	280 W - 64C/ 32C	STD fan 2U Full HSK	STD fan 2U Full HSK	STD fan 2U Full HSK	STD fan* 2U Full HSK	HPR fan 2U Full HSK	VHP fan 2U Full HSK	STD fan* 2U Full HSK	HPR fan* 2U Full HSK	STD fan 2U Full HSK	-	-	-	35°C
	280 W - 24C/ 16C	VHP fan 2U Full HSK	VHP fan 2U Full HSK	VHP fan 2U Full HSK										
128 GB LRDI MM	-	STD fan	STD fan	STD fan	STD fan	HPR (Silver) fan	HPR (Silver) fan	STD fan	HPR (Silv er) fan	STD fan	HPR (Silver) fan*, if TDP ≥ 200 W	HPR (Silver) fan*, if TDP ≥ 170 W	HPR (Silver) fan*	35°C

NOTE: * Supported ambient temperature is 30°C.

NOTE: Three fan modules are required for single processor, and six fan modules are required for dual processor system.

Table 48. Air cooling and liquid cooling: GPU/FPGA thermal restriction matrix

Con figu ration (Fron t stor age)	Fan type	Max CPU TDP/ cTDP	GPU/FPGA (Ambient temperature)															
			T4	V10 0 (16 GB)	V10 0S	M10	Sno w whit e	RTX 600 0	RTX 800 0	A100	MI10 0	A40	A10	A30	A16	MI21 0	A2	
No Bac kpa ne	HPR (Silv er)	280 W	30° C	35° C	30° C	35° C	35° C	35° C	35° C	35° C	35° C	30° C	30° C	30° C	35° C	35° C	35° C	30° C
8 x 2.5- inch NV Me	HPR (Silv er)	280 W	30° C	35° C	30° C	35° C	35° C	35° C	35° C	35° C	35° C	30° C	30° C	30° C	35° C	35° C	35° C	30° C
16 x 2.5- inch SAS	HPR (Silv er)	280 W	30° C	35° C	30° C	35° C	35° C	35° C	35° C	35° C	35° C	30° C	30° C	30° C	35° C	35° C	35° C	30° C
16 x 2.5- inch NV Me	HPR (Gol d)	280 W	30° C	35° C	30° C	35° C	35° C	35° C	35° C	35° C	35° C	30° C	30° C	30° C	35° C	35° C	35° C	30° C
16 x 2.5- inch SAS + 8 x 2.5- inch NV Me	HPR (Gol d)	280 W	30° C	35° C	30° C	35° C	35° C	35° C	35° C	35° C	35° C	30° C	30° C	30° C	35° C	35° C	35° C	30° C
8 x 3.5- inch SAS	HPR (Silv er)	280 W	30° C	35° C	30° C	35° C	35° C	35° C	35° C	35° C	35° C	30° C	30° C	30° C	35° C	35° C	35° C	30° C

NOTE: GPU is not supported in 12 x 3.5-inch hard drive and 24 x 2.5-inch NVMe configuration systems.

NOTE: Low Profile and Full Height T4 cards are installed in order to support maximum 6 pcs T4 in x 16 slots.

NOTE: In Liquid Cooling system, maximum two DW GPUs are supported.

Table 49. Processor and heat sink matrix

Heat sink	Processor TDP
STD HSK	< 180 W
2U HPR (Silver) HSK	>= 180 W
L-type HSK	Supports all TDP (system should be installed with GPU/FGPA/long PCIe cards)

NOTE: All GPU/FGPA cards require 1U L-type HSK and GPU shroud.

Table 50. Label reference

Label	Description
STD	Standard
HPR (Silver)	High performance (silver grade)
HPR (Gold)	High performance (gold grade)
HSK	Heat sink
LP	Low profile
FH	Full height

Table 51. Liquid cooling: CPU thermal restrictions (non-GPU/FPGA)

Configuration		8 x 2.5-inch NVMe	16 x 2.5-inch SAS	16 x 2.5-inch NVMe	16 x 2.5-inch SAS + 8 x 2.5-inch NVMe	24 x 2.5-inch NVMe	8 x 3.5-inch	12 x 3.5-inch	
Rear storage		No Rear Drives	No Rear Drives	No Rear Drives	No Rear Drives	No Rear Drives	No Rear Drives	No Rear Drives	2 x rear 2.5-inch, No rear fan
CPU TDP/ cTDP	120 W	STD fan	STD fan (A4 support)	STD fan	STD fan	STD fan	STD fan (A4 support)	STD fan (A4 support)	STD fan (A3 support)
	155 W	STD fan	STD fan (A4 support)	STD fan	STD fan	STD fan	STD fan (A4 support)	STD fan (A4 support)	STD fan (A3 support)
	170 W	STD fan	STD fan (A4 support)	STD fan	STD fan	STD fan	STD fan (A4 support)	STD fan (A4 support)	STD fan (A3 support)
	180 W	STD fan	STD fan (A4 support)	STD fan	STD fan	STD fan	STD fan (A4 support)	STD fan (A4 support)	STD fan (A3 support)
	200 W	STD fan	STD fan (A4 support)	STD fan	STD fan	STD fan	STD fan (A4 support)	STD fan (A4 support)	STD fan (A3 support)
	225 W	STD fan	STD fan (A4 support)	STD fan	STD fan	STD fan	STD fan (A4 support)	STD fan (A4 support)	STD fan (A3 support)
	240 W	STD fan	STD fan (A4 support)	STD fan	STD fan	STD fan	STD fan (A4 support)	STD fan (A4 support)	STD fan (A3 support)
	280 W	STD fan	STD fan (A4 support)	STD fan	STD fan	STD fan	STD fan (A4 support)	STD fan (A4 support)	STD fan (A3 support)

Table 52. Liquid cooling: Memory thermal restrictions (non-GPU/FPGA)

Configuration		1 DPC	2 DPC	8 x 2.5-inch NVMe	16 x 2.5-inch SAS	16 x 2.5-inch NVMe	16 x 2.5-inch SAS + 8 x 2.5-inch NVMe	24 x 2.5-inch NVMe	8 x 3.5-inch	12 x 3.5-inch	
Rear storage				No Rear Drives	No Rear Drives	No Rear Drives	No Rear Drives	No Rear Drives	No Rear Drives	No Rear Drives	2 x rear 2.5-inch, No rear fan
Memory	8 GB RDIM M 3200	2.8	2.0	STD fan	STD fan (A4 support)	STD fan	STD fan	STD fan	STD fan (A4 support)	STD fan (A4 support)	STD fan (A3 support)
	16 GB RDIM M 3200	4.3	3.0	STD fan	STD fan (A4 support)	STD fan	STD fan	STD fan	STD fan (A4 support)	STD fan (A4 support)	STD fan (A3 support)
	32 GB RDIM M 3200	6.9	4.8	STD fan	STD fan (A4 support)	STD fan	STD fan	STD fan	STD fan (A4 support)	STD fan (A4 support)	STD fan (A3 support)
	64 GB RDIM M 3200	8.3	5.8	STD fan	STD fan (A4 support)	STD fan	STD fan	STD fan	STD fan (A4 support)	STD fan (A4 support)	STD fan (A3 support)
	128 GB LRDIM M 2666	12.4	9.9	STD fan	STD fan (A3 support)	STD fan	STD fan	STD fan	STD fan (A3 support)	STD fan (A3 support)	STD fan (A3 support)

Appendix B. Standards compliance

The system conforms to the following industry standards.

Table 53. Industry standard documents

Standard	URL for information and specifications
ACPI Advance Configuration and Power Interface Specification, v2.0c	https://uefi.org/specsandtesttools
Ethernet IEEE 802.3-2005	https://standards.ieee.org/
HDG Hardware Design Guide Version 3.0 for Microsoft Windows Server	microsoft.com/whdc/system/platform/pcdesign/desguide/serverdg.mspx
IPMI Intelligent Platform Management Interface, v2.0	intel.com/design/servers/ipmi
DDR4 Memory DDR4 SDRAM Specification	jedec.org/standards-documents/docs/jesd79-4.pdf
PCI Express PCI Express Base Specification Rev. 2.0 and 3.0	pcisig.com/specifications/pciexpress
PMBus Power System Management Protocol Specification, v1.2	http://pmbus.org/Assets/PDFS/Public/PMBus_Specification_Part_1_Rev_1-1_20070205.pdf
SAS Serial Attached SCSI, v1.1	http://www.t10.org/
SATA Serial ATA Rev. 2.6; SATA II, SATA 1.0a Extensions, Rev. 1.2	sata-io.org
SMBIOS System Management BIOS Reference Specification, v2.7	dmtf.org/standards/smbios
TPM Trusted Platform Module Specification, v1.2 and v2.0	trustedcomputinggroup.org
UEFI Unified Extensible Firmware Interface Specification, v2.1	uefi.org/specifications
USB Universal Serial Bus Specification, Rev. 2.0	usb.org/developers/docs

Appendix C Additional resources

Table 54. Additional resources

Resource	Description of contents	Location
Installation and Service Manual	This manual, available in PDF format, provides the following information: <ul style="list-style-type: none"> • Chassis features • System Setup program • System indicator codes • System BIOS • Remove and replace procedures • Diagnostics • Jumpers and connectors 	Dell.com/Support/Manuals
Getting Started Guide	This guide ships with the system, and is also available in PDF format. This guide provides the following information: <ul style="list-style-type: none"> • Initial setup steps 	Dell.com/Support/Manuals
Rack Installation Guide	This document ships with the rack kits, and provides instructions for installing a server in a rack.	Dell.com/Support/Manuals
System Information Label	The system information label documents the system board layout and system jumper settings. Text is minimized due to space limitations and translation considerations. The label size is standardized across platforms.	Inside the system chassis cover
Quick Resource Locator (QRL)	This code on the chassis can be scanned by a phone application to access additional information and resources for the server, including videos, reference materials, service tag information, and Dell EMC contact information.	Inside the system chassis cover
Energy Smart Solution Advisor (ESSA)	The Dell EMC online ESSA enables easier and more meaningful estimates to help you determine the most efficient configuration possible. Use ESSA to calculate the power consumption of your hardware, power infrastructure, and storage.	Dell.com/calc