

合格证  
QC PASS

Godox

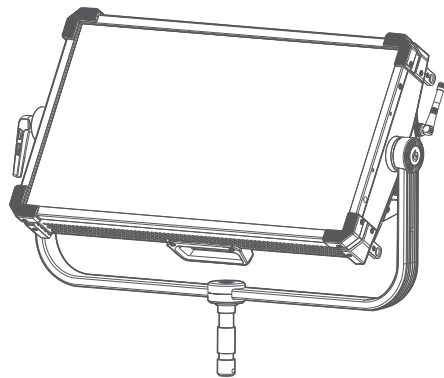

Wechat  
Official Account  
神牛微信公众号

深圳市神牛摄影器材有限公司

地址: 深圳市宝安区福海街道塘尾社区耀川工业区厂房2栋 电话: 0755-29609320(8062)  
传真: 0755-25723423 邮箱: godox@godox.com 说明书版本号: V1.0 机器固件版本号: V1.00

GODOX Photo Equipment Co.,Ltd.

Add.: Building 2, Yaochuan Industrial Zone, Tangwei Community, Fuhai Street, Bao'an District,  
Shenzhen 518103, China Tel: +86-755-29609320(8062) Fax: +86-755-25723423  
E-mail: godox@godox.com

Instruction manual version number: V1.0 Machine firmware version number: V1.00

godox.com

Made in China | 705-P600R0-00



# KNOWLED P600R

诺力LED影视面板灯  
KNOWLED LED Light Panel

使用手册  
Instruction Manual

## 重要的安全说明及注意事项

首先作为最基本原则：本产品为专业灯光布置设备，应由专业灯光师使用或在专业人士指导下使用。使用时必须始终遵循基本的安全预防措施，具体安全预防措施如下：

1. 使用前必须阅读并理解产品说明书。
2. 专业灯具，禁止儿童使用。当儿童靠近时，家长或监护人必须密切监督，以免儿童因碰撞灯具或私用灯具造成人身伤害。
3. 本灯具并非普通照明灯具，不可用于普通照明，任何有过眼部损伤或眼部敏感的人群均应避免使用本灯具。
4. 灯具点亮时，必须小心使用，禁止接触高温部件，如LED灯珠，以免造成灼伤。
5. 灯具点亮时，任何情况下均禁止直视灯珠。应该在专业灯光师指导下使用强光，任何情况下避免长时间处于强光环境，如引起眼睛不适，请及时关闭灯具，暂停使用，请及时就医。
6. 倘灯珠损坏或因热变形，应停止使用，并及时联系制造商、服务代理商或合格的维修人员更换灯珠，以免发生意外。
7. 本产品仅适用于-20°C-50°C工作环境温度及正常湿度环境下使用。
8. 请勿使用损坏的设备或设备配件，待专业维修人员检查维修，确认设备正常方可使用。
9. 在使用过程中，如果本产品由于跌落、受到挤压或遭受强烈冲击而造成外壳破裂的，请勿继续使用，以免因接触到内部电子元件而受到电击伤害。
10. 如需要延长线，请使用额定电流≥该设备额定电流的延长线。如延长线额定电流小于该设备，可能导致过热。
11. 部分产品电源线较长，请合理放置电源线，使其处于安全位置。避免电源线接触过热物体表面、避免放置不当导致拉扯损坏或绊倒现场人员。请使用本厂原装电源线，如使用非本厂电源线导致产品损坏，概不在本厂维修范围内。
12. 在清洁和维修之前，请务必从电源插座上拔出该设备插头。不使用时，禁止拉扯电源线以将设备插头从电源插座中拔出。正常断电，应是用手抓住该设备插头两端，将插头从电源插座中拔出。此设备需连接到接地插座中。
13. 本设备没有防水性能，请让设备保持干燥，请勿将本设备浸入水中或其他液体中。设备需安装在干燥且通风处，避免在雨天、潮湿、多尘或过热环境下使用。请勿将任何物体置于灯具上或使液体流入灯具内部，以免发生意外。
14. 请勿私自拆卸产品，如产品出现故障，须由本公司或授权的维修人员进行检查维修。
15. 存放本设备之前，请确保设备已完全冷却。存放时，将电源线从设备上拔出。设备应放置于设备便携包内或通风干燥处。
16. 请勿将设备放置在酒精、汽油等易燃易爆挥发的溶剂附近。
17. 本厂不推荐的产品附件，请勿使用，以免导致火灾、触电或人身伤害。
18. 清洁本设备时，请勿用湿布擦拭，请用干布，软布擦拭设备污垢。
19. 设备使用前，请注意将保护罩取下。
20. 本产品已通过ROHS, CE和FCC认证，请参考相关国家标准使用和操作。
21. 安全说明依据本厂严格测试制定，设备设计和规格如有变更，恕不另行通知。客户可以上神牛官网查看最新的电子版说明，了解产品最新资讯。
22. 部分产品内置锂电池。此类产品请使用专用的充电器进行充电，并且按正确的操作说明，在规定的电压、温度范围内使用。
23. 部分产品使用电池供电。此类产品请勿使用说明书中未指定的任何电池、电源或附件。请将电池和其他附件置于儿童及婴幼儿无法触及之处。如果儿童或婴幼儿吞下电池或附件，请立即就医。如果电池漏液、变色、变形、冒烟或发出异味，请立即将其取出。在取出过程中请小心，以免烫

伤。如果继续使用，可能会引起火灾、触电或皮肤烫伤。请勿使用任何变形或改造过的电池。请勿拆卸或改造本产品或电池。请勿加热电池或焊接电池。请勿让电池与火或水接触。请勿让电池受到强烈的外力撞击。请勿将电池的正负极错误插入，或将新旧电池或不同类型的电池混合使用。

24. 一年保修期，消耗品电池、适配器、电源线等配件不在此保修范围内。
25. 经发现，擅自检修设备，将取消一年保修期，维修需要收取相关费用。
26. 对于不规范操作引起的机器故障不在保修范围内。

### 保存这些说明

本产品包合型号核准代码为：CMIIT ID:2023DP21595，为该产品的无线电发射模块。

## 前言

感谢您购买神牛产品。

神牛全新推出一款智力LED影视面板灯P600R，输出高达600W，支持AC 100V~240V电压范围，适用于全球范围内的拍摄场景；拥有灯控一体、超高亮度、千分级亮度调节、4种调光曲线、1800K-10000K色温、4种调色模式、16类场景光效、平均CRI≥96、平均TLCI≥96、多种无线控制等諸多特性；适用于大型摄影棚、影视基地、演播室、户外外景以及大型实地场等多种拍摄场景。

## 主要特点

- 灯控一体设计，节省空间的同时，布光更加便捷；
- 600W超强输出功率，全色温段段功率输出；
- 真正千分级调节，能从100%完美平滑调光至0%；
- 4种调光曲线：线性、S曲线、指数、对数；
- 宽广色温，调节范围：1800K-10000K；
- 多种调色模式：HSI模式、RGBW模式、GEL模式、X-Y模式；
- 多种智能控制：DMX 512控制台控制，支持RDM协议、LumenRadio CRMX控制、以太网控制，支持Art-Net & sACN协议、蓝牙APP控制、灯体控制；
- 高效散热风扇，配合全新散热设计，满足大灯具散热需求；
- 16类FX光效模式：闪光灯、雷闪电、多云、坏灯泡、电视机、蜡烛、火、烟花、爆炸、焊接、警车、SOS、彩光循环、派对、像素蜡烛、像素火。

## 警告

- ▲ 大功率LED灯，严禁直视光源或照射他人眼睛。
- ▲ 严禁通电时插拔电源线，以免造成人身伤害。
- ▲ 本灯具工作时，请勿遮挡散热口。
- ▲ 请勿让儿童靠近、接触或使用本灯具。
- ▲ 专业灯光设备，请务必按照使用手册正确操作。

## 部件名称

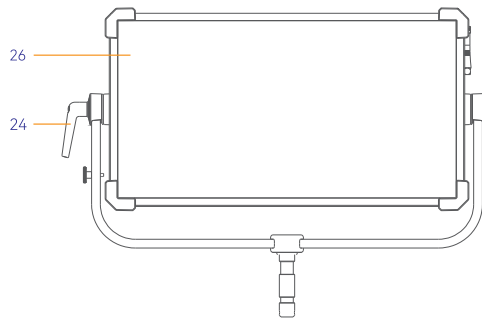
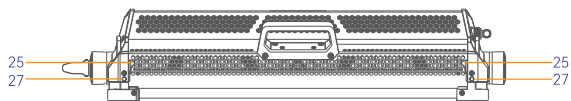
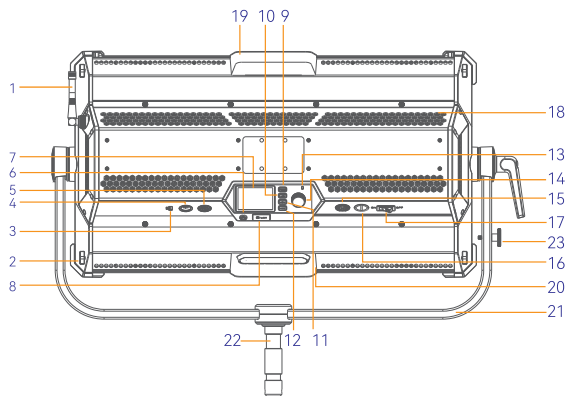

- |              |                |              |
|--------------|----------------|--------------|
| 1. 天线        | 10. LOCK按键     | 19. 提手1      |
| 2. 吊环        | 11. MENU按键     | 20. 提手2      |
| 3. USB-A接口   | 12. MODE按键     | 21. U架       |
| 4. DMX IN接口  | 13. 无线DMX状态指示灯 | 22. 支架柄      |
| 5. DMX OUT接口 | 14. 调节旋钮       | 23. 挂绳装置     |
| 6. 线控接口      | 15. DC 48V输入接口 | 24. 方向调节把手   |
| 7. 显示屏       | 16. AC输入接口     | 25. 附件解锁推制   |
| 8. 以太网接口     | 17. 开关按键       | 26. 可拆卸柔光板   |
| 9. PRESET按键  | 18. 散热孔        | 27. 解锁推制保险按钮 |

注:使用DC48V供电, 开关按键不起作用, 接入电源线时直接开机, 拔出电源线时直接灭灯。

## P600R物料清单

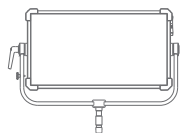

灯体 × 1



天线 × 1



绑绳绳 × 1



安全绳 × 1



交流电源线 × 1



说明书 × 1



DMX实用表 × 1

## P600R K1物料清单

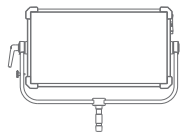

灯体 × 1



天线 × 1



绑绳绳 × 1



安全绳 × 1



交流电源线 × 1

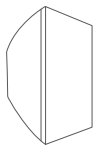

快装柔光箱 × 1



收纳包SC04 × 1



说明书 × 1



DMX实用表 × 1

温馨提示：说明书线图均为示意图，仅供参考。由于产品不断更新与升级，产品实物与线图可能存在差异，请以实物为准。

## 可另购附件

离机遥控器 RC11、杆控U架P600RY02、八角柔光箱P600RO5、四角柔光箱P600RS34  
4叶遮菲P600RB4、蜂巢P600RH30

## U架安装说明

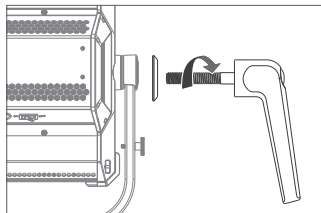

1.先装一侧：灯具竖着摆放，将金属垫块和塑料垫块分开放置在U架安装孔两侧，方向调节把手螺丝柱穿过金属垫块、U架及其塑料垫块的安装孔，最后插入灯体安装孔，顺时针旋转即可拧紧。

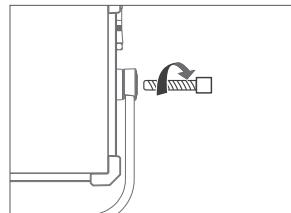

2.另外一侧：将塑料垫块垫在灯具安装孔与U型支架安装孔中间，插入螺丝柱，使用把手顺时针旋转螺丝即可拧紧。

## 拆卸柔光片

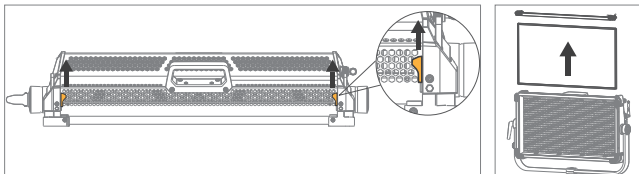

往前推动面板灯顶部两边的附件解锁推制，拿下灯具边框后顺着滑道将柔光片从灯具中取出，即可拆卸完毕。

## 安装柔光片

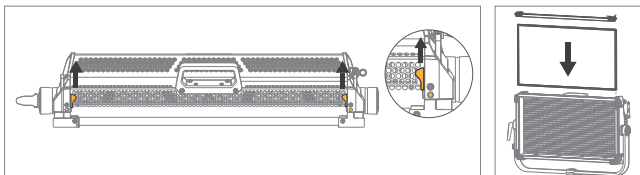

往前推动面板灯顶部两边的附件解锁推制，拿下灯具边框后顺着滑道将柔光片插入灯具，放好灯具边框后按下顶部两侧解锁推制保险按钮即可完成安装。

## 连接DMX控制台

### 无线DMX连接

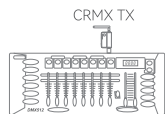

DMX512

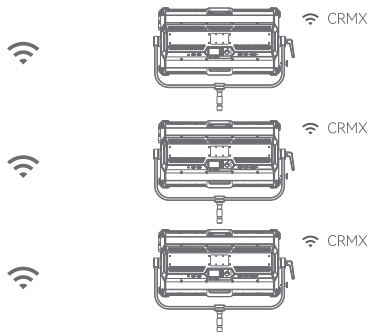

### 有线DMX连接

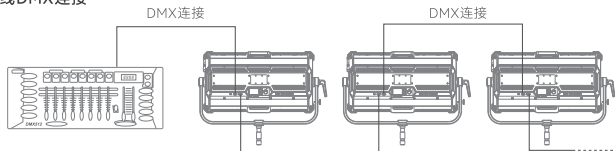

注：DMX连接线需另购

DMX连接

## 连接以太网

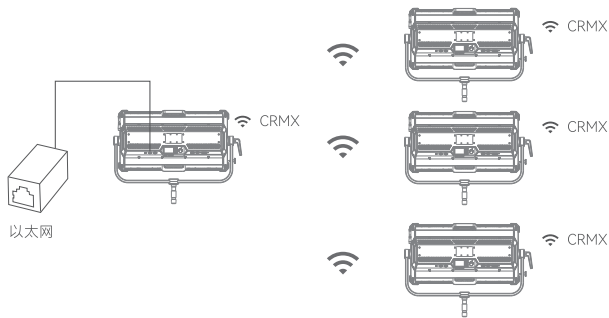

以太网

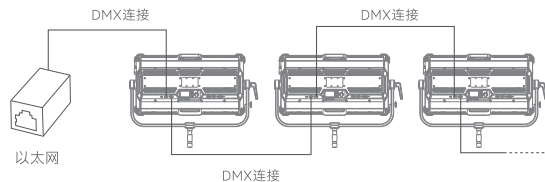

注：DMX连接线需另购

DMX连接

## 开关机

接通电源，拨动开关按键，实现开机 (ON) 或关机(OFF)。

## CCT模式

短按MODE按键进入模式选择界面，旋转调节旋钮可选CCT模式，短按调节旋钮进入CCT模式。

旋转调节旋钮可选亮度调节/色温调节/品红-绿调节，短按调节旋钮进入某项设置，左旋调节旋钮减少参数值，右旋调节旋钮增加参数值。

亮度: 0%~100% (以0.1%为增量)  
色温: 1800K~10000K(以100K为增量)  
品红-绿: -100%~100% (以1%为增量)

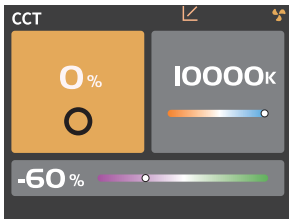

## HSI模式

短按MODE按键进入模式选择界面，旋转调节旋钮可选HSI模式，短按调节旋钮进入HSI模式。

旋转调节旋钮可选亮度调节/色相调节/饱和度调节，短按调节旋钮进入某项设置，左旋调节旋钮减少参数值，右旋调节旋钮增加参数值。

亮度: 0%~100% (以0.1%为增量)  
色相: 0°~360°(以1°为增量)  
饱和度: 0%~100% (以1%为增量)



## RGBW模式

短按 MODE 按键进入模式选择界面，旋转调节旋钮可选 RGBW模式，短按调节旋钮进入 RGBW模式。

旋转调节旋钮可选亮度调节/红光调节/绿光调节/蓝光调节/白光调节，短按调节旋钮进入某项设置，左旋调节旋钮减少参数值，右旋调节旋钮增加参数值。

亮度: 0%~100% (以0.1%为增量)  
红光: 0%~100% (以0.1%为增量)  
绿光: 0%~100% (以0.1%为增量)  
蓝光: 0%~100% (以0.1%为增量)  
白光: 0%~100% (以0.1%为增量)

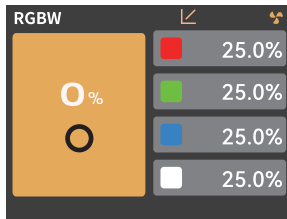

## GEL模式

短按MODE按键进入模式选择界面，旋转调节旋钮可选GEL模式，短按调节旋钮进入GEL模式。

旋转调节旋钮可选亮度调节/色片类型/色片组类型/颜色选择/色温/色相/饱和度，短按调节旋钮进入某项设置，左旋调节旋钮减少参数值，右旋调节旋钮增加参数值。

亮度: 0%~100% (以0.1%为增量)  
色片类型: R-GEL/L-GEL  
色片组类型: Color correction/CalColor/Storago Selection/Cinelux (R-GEL)/Color correction/Color Filters/600 Series /Cosmetic Filters/700 Series (L-GEL)  
色温: 3200K或5600K  
色相: 0°~360°(以1°为增量)  
饱和度: 0%~100% (以1%为增量)

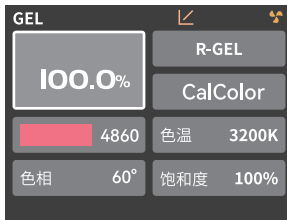

## X-Y模式

短按MODE按键进入模式选择界面，旋转调节旋钮可选X-Y模式，短按调节旋钮进入X-Y模式。旋转调节旋钮可选亮度调节/X坐标调节/Y坐标调节/颜色温度或颜色空间。短按调节旋钮进入某项设置，旋转调节旋钮调节参数。

亮度: 0%~100% (以0.1%为增量)  
 X坐标: 0.0000~0.8500  
 Y坐标: 0.0000~0.9500  
 颜色温度或颜色空间: Gamut、Rec.2020、  
 DCI-P3、Rec.709、Black Body

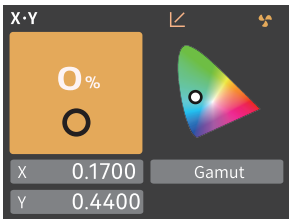

## FX模式

短按MODE按键进入模式选择界面, 旋转调节旋钮可选FX模式, 短按调节旋钮进入FX模式。旋转调节旋钮可选闪光灯/雷闪电/多云/坏灯泡/电视机/蜡烛/火/烟花/爆炸/焊接/警车/SOS/彩光循环/派对/像素蜡烛/像素火, 短按调节旋钮进入某项设置。



### 1. 闪光灯

此光效模拟闪光灯闪光或传统镁光灯闪光, 常用于营造一种生动、活泼的氛围。

通过旋转调节旋钮选择某项设置, 短按调节旋钮进入选项, 根据需求旋转调节旋钮进行调节。设置完毕, 短按调节旋钮返回上一级。

注: 选中手动, 通过短按一次调节旋钮触发一次闪光灯光效。

亮度: 0%~100% (以0.1%为增量)
开关: 开启/关闭
类型: CCT/HSI
色温/色相: 1800K-10000K/0-360°
触发: 手动/自动
速度: 1-100
模式: 闪光灯/镁光灯

### 2. 雷闪电

此光效模拟雷电的闪电, 常用于营造一种紧张、恐怖或神秘的氛围。

通过旋转调节旋钮选择某项设置, 短按调节旋钮进入选项, 根据需求旋转调节旋钮进行调节。设置完毕, 短按调节旋钮返回上一级。

注: 选中手动, 通过短按一次调节旋钮触发一次雷闪电光效。

亮度: 0%~100% (以0.1%为增量)
开关: 开启/关闭
色温: 1800K-10000K
触发: 手动/自动
闪烁次数: 随机/1-10
频率: 随机/1-20

### 3. 多云

此光效模拟云层遮挡效果, 常用于营造一种阴沉、压抑或悲伤氛围。

通过旋转调节旋钮选择某项设置, 短按调节旋钮进入选项, 根据需求旋转调节旋钮进行调节。设置完毕, 短按调节旋钮返回上一级。

亮度: 0%~100% (以0.1%为增量)
开关: 开启/关闭
亮度比例: 10-90
速度: 随机/1-100

### 4. 坏灯泡

此光效模拟一盏损坏的灯泡闪光, 常用于营造昏黄的环境氛围。

通过旋转调节旋钮选择某项设置, 短按调节旋钮进入选项, 根据需求旋转调节旋钮进行调节。设置完毕, 短按调节旋钮返回上一级。

亮度: 0%~100% (以0.1%为增量)
开关: 开启/关闭
类型: CCT/HSI
色温/色相: 1800K-10000K/0-360°
速度: 1-100

### 5. 电视机

此光效模拟电视机或屏幕的光线效果, 常用于营造出一种冷淡、机械或数字化的氛围。

通过旋转调节旋钮选择某项设置, 短按调节旋钮进入选项, 根据需求旋转调节旋钮进行调节。设置完毕, 短按调节旋钮返回上一级。

亮度: 0%~100% (以0.1%为增量)
开关: 开启/关闭
类型: CCT/HSI
速度: 1-100

### 6. 蜡烛

此光效模拟蜡烛的光线效果, 常用于营造出一种柔和、温暖、闪烁的氛围。

通过旋转调节旋钮选择某项设置, 短按调节旋钮进入选项, 根据需求旋转调节旋钮进行调节。设置完毕, 短按调节旋钮返回上一级。

亮度: 0%~100% (以0.1%为增量)
开关: 开启/关闭
速度: 1-100

## 7. 火

此光效模拟火焰的光线效果，常用于营造出一种明亮、热烈、闪烁氛围。

通过旋转调节旋钮选择某项设置，短按调节旋钮进入选项，根据需求旋转调节旋钮进行调节。设置完毕，短按调节旋钮返回上一级。

## 8. 烟花

此光效模拟烟花的光线效果，常用于营造出一种绚丽、多彩、浪漫的氛围。

通过旋转调节旋钮选择某项设置，短按调节旋钮进入选项，根据需求旋转调节旋钮进行调节。设置完毕，短按调节旋钮返回上一级。

## 9. 爆炸

此光效模拟爆炸的光线效果，常用于营造出一种明亮、猛烈、闪烁氛围。

通过旋转调节旋钮选择某项设置，短按调节旋钮进入选项，根据需求旋转调节旋钮进行调节。设置完毕，短按调节旋钮返回上一级。

注：选中手动，通过短按一次调节旋钮触发一次爆炸光效。

## 10. 焊接

此光效模拟焊接的光线效果，常用于营造出一种炽热、机械的氛围。

通过旋转调节旋钮选择某项设置，短按调节旋钮进入选项，根据需求旋转调节旋钮进行调节。设置完毕，短按调节旋钮返回上一级。

## 11. 警车

此光效模拟警车灯光的闪烁效果，常用于营造紧张、追逐或紧张氛围。

通过旋转调节旋钮选择某项设置，短按调节旋钮进入选项，根据需求旋转调节旋钮进行调节。设置完毕，短按调节旋钮返回上一级。

亮度: 0%~100% (以0.1%为增量)
开关: 开启/关闭
速度: 1~100

亮度: 0%~100% (以0.1%为增量)
开关: 开启/关闭
速度: 1~100
余辉: 1~100

亮度: 0%~100% (以0.1%为增量)
开关: 开启/关闭
触发: 手动/自动
类型: CCT/HSI
色温/色相: 1800K-10000K/0~360°
余辉: 1~100
速度: 1~100

亮度: 0%~100% (以0.1%为增量)
开关: 开启/关闭
类型: CCT/HSI
色温/色相: 1800K-10000K/0~360°
速度: 1~100

亮度: 0%~100% (以0.1%为增量)
开关: 开启/关闭
颜色: 红+蓝、红、蓝、白+蓝、黄+蓝、黄、红+蓝+白、红+黄+蓝
模式: 1-5

## 12. SOS SOS

此光效模拟SOS求救信号的闪烁效果，常用于营造危险、求救或紧急情况氛围。

通过旋转调节旋钮选择某项设置，短按调节旋钮进入选项，根据需求旋转调节旋钮进行调节。设置完毕，短按调节旋钮返回上一级。

亮度: 0%~100% (以0.1%为增量)
开关: 开启/关闭
类型: CCT/HSI
色温/色相: 1800K-10000K/0~360°

## 13. 彩光循环

此光效模拟彩色光线的循环和变化效果，常用于营造一种梦幻、科幻的氛围。

通过旋转调节旋钮选择某项设置，短按调节旋钮进入选项，根据需求旋转调节旋钮进行调节。设置完毕，短按调节旋钮返回上一级。

亮度: 0%~100% (以0.1%为增量)
开关: 开启/关闭
饱和度: 0%~100% (以1%为增量)
速度: 1~100

## 14. 派对

此光效模拟彩色光线、闪光灯和激光等效果，常用于营造出一种狂欢、欢乐、高能氛围。

通过旋转调节旋钮选择某项设置，短按调节旋钮进入选项，根据需求旋转调节旋钮进行调节。设置完毕，短按调节旋钮返回上一级。

亮度: 0%~100% (以0.1%为增量)
开关: 开启/关闭
饱和度: 0%~100% (以1%为增量)
速度: 1~100

## 15. 像素蜡烛

此光效模拟蜡烛的光线效果，与普通蜡烛光效相比，具有呼吸感，常用于营造一种古典、神秘、柔和的氛围。

通过旋转调节旋钮选择某项设置，短按调节旋钮进入选项，根据需求旋转调节旋钮进行调节。设置完毕，短按调节旋钮返回上一级。

亮度: 0%~100% (以0.1%为增量)
开关: 开启/关闭
色调: 偏暖/中性/偏冷
速度: 1~100



## 16. 像素火

此光效模拟火焰的颜色和燃烧效果，与普通火光效相比，具有呼吸感，常用于营造紧张、危险、热烈的氛围。

通过旋转调节旋钮选择某项设置，短按调节旋钮进入选项，根据需求旋转调节旋钮进行调节。设置完毕，短按调节旋钮返回上一级。

亮度: 0%~100% (以0.1%为增量)
开关: 开启/关闭
色调: 偏暖/中性/偏冷
速度: 1-100

## 菜单设置

短按MENU按键进入菜单设置，旋转调节旋钮选择DMX、CRMX、蓝牙、以太网、Art-Net&sACN、调光曲线、控制模式、色域空间、风扇、屏幕设置、语言、版本与升级、恢复出厂设置、灯具信息。



## 1.DMX

短按调节旋钮进入DMX设置界面。旋转调节旋钮选择地址/DMX模式/RDM状态/DMX丢失状态/终止开关/增强通道。短按调节旋钮进入选项设置，通过旋转调节旋钮完成选项设置。

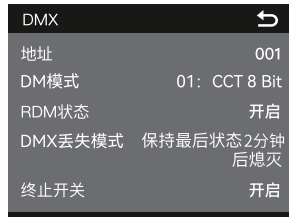

连接有有线DMX，灯体界面



连接CRMX，灯体界面



一级选项	二级选项	说明
地址	001-512	起始地址
DMX模式	01: CCT 8 Bit	8位CCT模式
	02: HSI 8 Bit	8位HSI模式
	03: RGB 8 Bit	8位RGB模式
	04: RGBW 8 Bit	8位RGBW模式
	05: RGBWW 8 Bit	8位RGBWW模式
	06: CCT+HSI 8 Bit	8位CCT+HSI模式
	07: CCT+RGBW 8 Bit	8位CCT+RGBW模式
	08: FX 8 Bit	8位FX模式
	09: GEL 8 Bit	8位GEL模式
	10: CCT 16 Bit	16位CCT模式
	11: HSI 16 Bit	16位HSI模式
	12: RGB 16 Bit	16位RGB模式
	13: RGBW 16 Bit	16位RGBW模式
	14: X-Y 16 Bit	16位X-Y模式
	15: FX 16 Bit	16位FX模式
	16: GEL 16 Bit	16位GEL模式
	17: RGB Engine 8 Bit	8位RGB模式(像素)
	18: RGBW Engine 8 Bit	8位RGBW模式(像素)
	19: HSI Engine 8 Bit	8位HSI模式(像素)
	20: CCT+RGBW Engine 8 Bit	8位CCT+RGBW模式(像素)
RDM状态	开启	开启RDM, 开启后控制台可设置灯具地址及DMX模式
	关闭	关闭RDM
DMX丢失状态	保持最后状态	失去DMX控制信号后, 在关机或再次接收有效DMX控制信号前, 持续使用最后一次接收的DMX控制信号
	直接关闭	灯具直接熄灭
	保持最后状态2分钟熄灭	失去DMX控制信号后, 持续使用最后一次接收的DMX控制信号2分钟, 2分钟后灯具熄灭。注: 如2分钟内接收到有效DMX控制信号, 则使用新的DMX控制信号。
终止开关	开启	开启DMX终端
	关闭	关闭DMX终端
DMX增强通道	开启	开启增强通道信号
	关闭	关闭增强通道信号

注: 使用DMX/RDM控制台控制灯具, 可登录官网 <https://www.godox.com.cn/> 下载DMX实用表。

## 2.CRMX

短按调节旋钮进入CRMX设置界面。旋转调节旋钮选择CRMX开关/模式/发射功率/重置。短按调节旋钮进入某项设置。设置完毕, 短按MENU按键返回上一级。重置: 短按调节旋钮进入重置界面, 接着短按调节旋钮进行重置。

CRMX: 开启/关闭

模式: 发射模式/接收模式

发射功率: 5 dbm、11 dbm、16 dbm、20dbm



## 3.蓝牙

短按调节旋钮进入蓝牙设置界面。旋转调节旋钮选择蓝牙开关/蓝牙重置, 短按调节旋钮进入某项设置。设置完毕, 短按MENU按键返回上一级。

蓝牙开关: 通过旋转调节旋钮完成设置。

蓝牙重置: 旋转调节旋钮选择确认, 通过短按按钮完成设置。

蓝牙MAC码: 位于界面左下角, 方便查找灯具蓝牙。



## “GODOX Light”App下载

扫描下面二维码即可下载“Godox Light”手机app (安卓和苹果系统都可以使用)。

注:

- 1.首个移动设备 (手机或平板电脑) 可直接使用app操控灯体, 更换其他移动设备时, 灯体需进行蓝牙重置方可正常使用app。
2. App需升级至V3.0以上版本。



## 4.以太网

短按调节旋钮进入以太网设置。进入界面后短按调节旋钮可设置网络模式，旋转调节旋钮可选DHCP/Art-Net 2.x/Art-Net 10.x/手动。设置完毕，短按MENU按键返回上一级。

以太网设置	
网络模式	自动
IP	255.255.255.0
子网掩码	255.255.255.0
默认网关	192.168.88.30
MAC:	

一级选项	二级选项	说明
网络模式	DHCP	使用DHCP模式
	Art-Net 2.x	使用2.B.C.D网络
	Art-Net 10.x	使用10.B.C.D网络
	手动	可手动设置网络IP、子网掩码、默认网关
IP	AAA.BBB.CCC.DDD	如果启动DHCP模式，灯光ID地址则有DHCP分配。 如果启动Art-Net 2.x模式，灯光ID地址则为2.B.C.D。 如果启动Art-Net 10.x模式，灯光ID地址则为10.B.C.D。 如果启动手动模式，AAA=0-255 BBB=0-255 CCC=0-255 DDD=0-255
	255.BBB.CCC.DDD	如果启动DHCP/Art-Net 2.x/Art-Net 10.x，子网掩码为255.BBB.CCC.DDD不能通过菜单更改。 如果启动手动，AAA=0-255 BBB=0-255 CCC=0-255 DDD=0-255
默认网关	AAA.BBB.CCC.DDD	如果启动DHCP模式，灯光默认网关则有DHCP分配。 如果启动Art-Net 2.x模式，灯光默认网关地址则为2.B.C.D。 如果Art-Net 10.x模式，灯光默认网关则为10.B.C.D。 如果启动手动模式，AAA=0-255 BBB=0-255 CCC=0-255 DDD=0-255

## 5.Art-Net & sACN

短按调节旋钮进入Art-Net&sACN协议设置。旋转调节旋钮可选Art-Net&sACN/Art-Net Net/Art-Net Sub-Net/Art-Net Port/Art-Net Universe/sACN Universe，短按调节旋钮进入某项设置。设置完毕，短按MENU按键返回上一级。

Art-Net & sACN 设置	
Art-Net & sACN	自动
Art-Net Net	127
Art-Net Sub-Net	15
Art-Net Port	11

一级选项	二级选项	说明
Art-Net&sACN	自动/Art-Net/sACN/关	自动: 接受Art-Net&sACN两种协议。 Art-Net: 只接受Art-Net协议。 sACN: 只接受sACN协议。 关: 不接受网络协议。
Art-Net Net	0-127	选择Art-Net网络
Art-Net Sub-Net	0-15	在Art-Net网络中选择Art-Net子网
Art-Net Port	0-15	Art-Net端口
Art-Net Universe	0..32767	Art-Net域
sACN Universe	1..63999	sACN域

## 6.调光曲线

短按调节旋钮进入调光曲线设置。旋转调节旋钮选择线性、S曲线、指数、对数。设置完毕，短按调节旋钮/短按MENU按键返回上一级。

调光曲线	
线性	S曲线
指数	对数

## 7.控制模式

短按调节旋钮进入控制模式。短按调节旋钮选中模式，旋转调节旋钮选择对应模式，设置完毕，短按MENU按键返回上一级。

模式：常规、低亮。  
频率：1-11

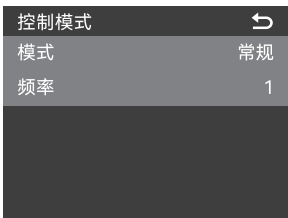

## 8.色域空间

短按调节旋钮进入色域空间。短按调节旋钮选中色域空间，旋转调节旋钮选择对应色域，设置完毕，短按MENU按键返回上一级。

色域空间：原始色域、校色色域、REC 709、DCI-P3。

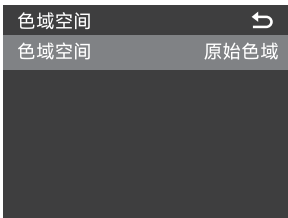

## 9.风扇

短按调节旋钮进入风扇设置。旋转调节旋钮可选静音/自动/中速/高速。选择完毕，短按调节旋钮/MENU按键返回上一级。

不同状态下灯体最大亮度值 (%)

风扇状态	线性	S曲线	指数	对数
静音(关闭)	20%	36.5%	52.4%	8.7%
自动	100%	100%	100%	100%
中速	75%-100%	60%-100%	86%-100%	40%-100%
高速	100%	100%	100%	100%

注：风扇处于中速模式时，最大亮度值随着环境温度变化而变化。



## 10.屏幕设置

短按调节旋钮进入屏幕设置。短按调节旋钮选中屏幕亮度，旋转调节旋钮调节参数，调节范围为10%-100%。设置完毕，短按MENU按键返回上一级。

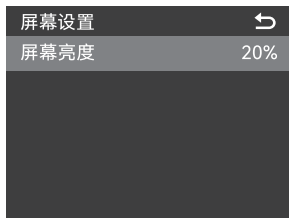

## 11.语言

短按调节旋钮进入语言设置。旋转调节旋钮选择中文/English，短按调节旋钮完成设置。设置完毕，短按MENU按键返回上一级。



## 12.版本与升级

短按调节旋钮进入版本与升级设置。在此界面可查看灯具固件版本及升级固件提示。查看完毕，短按MENU按键返回上一级。

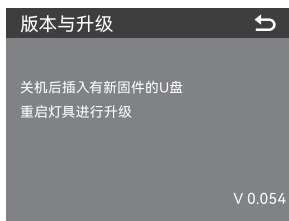

### 升级详情

- 1.在官网 (<https://www.godox.com.cn/firmware-continuous-light>) 下载新固件到U盘上。
- 2.在关机状态下，将存有新固件的U盘插入USB-A接口。
- 3.开机，灯具P600R自动进入升级界面。
- 4.升级完毕自动跳回主界面。

### 注：

- 1.必须在官网上下载新固件，存放在U盘根目录下，而且仅有一个BIN文件。
- 2.USB-A接口支持供电，输出电压电流5V/1.5A，请勿接入大功率USB设备。

### 13. 恢复出厂设置

短按调节旋钮进入恢复出厂设置。旋转调节旋钮选择确定/取消，短按调节旋钮完成设置。恢复出厂设置，亮度值自动变为100%。



### 14. 灯具信息

短按调节旋钮进入灯具信息，在此界面可查看灯具型号、UID号、固件版本、灯头温度等信息。查看完毕，短按MENU按键返回上一级。



### 锁定设置

短按LOCK按键，屏幕出现表示当前界面被锁定；再次短按LOCK按键便可解锁。

注：此锁定功能仅锁定控制器操控面板，其他操作方式仍可正常操作。

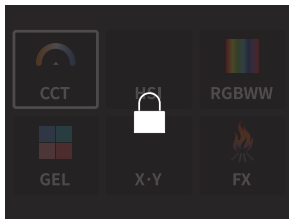

### 预存设置

短按PRESET按键进入预存灯具光效界面。旋转调节旋钮选择1-20组预设，短按调节旋钮进入预设组设置，通过旋转调节旋钮可选应用/保存/取消，最后短按调节旋钮完成设置。设置完毕，短按PRESET按键退出预存设置。

应用：应用该组预设光效。

保存：保存当前灯具光效。

取消：返回上一级。

注：某组预设如未预设过光效，界面不显示应用选项。

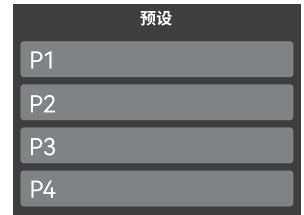

### 维护保养

一年保修期，消耗品电池，适配器，电源线等配件不在此保修范围内。

经发现，擅自检修此LED影视灯，将取消LED影视灯一年保修期，维修需要收取相关费用。

对于不规范操作引起的机器故障不在保修范围内。

所有维修一概由本厂指定的可供原配件的维修部负责。

如本品出现故障或者被水淋湿，在专业人员维修后方可继续使用。LED影视灯灯在工作时，如发现异常，应立即关掉电源，查明原因。

### 照度数据

色温	测试状态	照度单位	3m	5m	7m	9m
3200K	带柔光板	lux	≈2970	≈1360	≈836	≈562
		fc	≈276	≈126	≈77.6	≈52.2
lux		≈3230	≈1470	≈899	≈607	
fc		≈300	≈137	≈83.6	≈56.4	

数据均为平均值，非绝对值，以上测试需在灯体100%亮度下进行。

## 规格参数

型号	P600R
供电	100V~240V~50/60Hz 7A或DC 48V
输入功率	最大≈700W
色温	1800~10000K
品红/绿调节	-100%~100%
调光范围	0%~100%
调光模式	线性/S曲线/指数/对数
CRI	平均≥96
TLCI	平均≥96
控制方式	DMX 512控制台控制, 支持RDM协议/LumenRadio CRMX控制/以太网控制, 支持Art-Net & sACN协议/蓝牙APP控制/灯体控制
蓝牙控制距离	最远30m
Type-A USB接口	固件升级/5V=1.5A供电
工作环境温度	-20°C~45°C
尺寸 (含U架)	≈776mm*567mm*153mm
净重 (含U架)	≈18kg

设计和规格如有变更, 恕不另行通知。

## Safety Instructions and Attentions

First of all, as the most basic principle: This product is a professional lighting set equipment and should be used by professional lighting engineers or under the guidance of professionals. Basic safety attentions must always be followed during use, as follows:

1. Before use, please read and understand these instructions and attentions.
2. Professional lighting is prohibited for children. When children are near, parents or accompanying persons must supervise closely to prevent children from personal injury due to collision with lamps or private use of lamps.
3. This lighting product is not ordinary lighting product and cannot be used for general lighting. Anyone who has suffered eye damage or has sensitive eyes should avoid using this product.
4. When the lamp is on, it must be used with care. Do not touch high-temperature parts, such as LED lamp beads, to avoid burns.
5. When the lamp is on, it is forbidden to look directly at the lamp beads under any circumstances. Strong light should be used under the guidance of professional lighting engineers. Avoid prolonged exposure to strong light under any circumstances. If eye discomfort, please turn off the lamp in time, suspend use, and see a doctor immediately.
6. If the lamp bead is damaged or deformed by heat, stop using this equipment, and contact the manufacturer, service agent or qualified maintenance personnel to replace the lamp bead in time to avoid accidents.
7. This product is only suitable for use in -20°C to 50°C operating environment and normal humidity environment.
8. Do not use damaged equipment or accessories, and wait for professional maintenance personnel to check and repair to confirm being normal before use.
9. During using, if the casing of this product is broken due to being dropped, squeezed or subjected to strong impact, please do not use it, so as to avoid electric shock injury due to contact with internal electronic components.
10. If an extension cord is required, please use an extension cord with a current rating greater than or equal to that of the equipment. If an extension cord is rated less than the equipment, overheating may result.
11. Some products have long power cords, please place the power cords properly and keep them in a safe place. Avoid contacting the power cord with overheating surfaces, avoid improper placement that could cause pulling damage, or trip on-site personnel. Please use the certified power cord from the original manufacturer. If the product is damaged by using a non-certified power cord, it will not be repaired by our factory.
12. Be sure to unplug equipment from the power outlet before cleaning and repairing. When not in use, do not pull the power cord to unplug the equipment. For normal power-off, please hold both ends of the plug of the equipment with your hands and pull the plug out of power outlet. This equipment needs to be connected to a grounded outlet.
13. This equipment is not waterproof, please keep it dry and do not immerse it in water or other liquids. The equipment should be installed in a dry and ventilated place, and avoid using it in rainy, humid, dusty or overheated environments. Do not place any objects on the lamp or let liquid flow into the lamp to avoid accidents.
14. Do not disassemble the product without permission. If the product fails, it must be checked and repaired by authorized maintenance personnel.

15. Before storing, make sure that the equipment has cooled down completely. For storage, unplug the power cord from the equipment. The equipment should be placed in the carrying case or in a ventilated dry place.
16. Do not place equipment near flammable and volatile solvents such as alcohol and gasoline.
17. Do not use accessories that are not recommended by our factory to avoid fire, electric shock or personal injury.
18. When cleaning, do not wipe it with a damp cloth, please use a dry cloth or a soft cloth to wipe the dirt of the equipment.
19. Please take off the protective cover before using.
20. This product complies with ROHS, CE, and FCC certification, please refer to the relevant national standards for use and operation.
21. The safety instructions are formulated according to the strict testing of the factory, and the design and specifications of the equipment are subject to change without prior notice. For latest product information, please check the GODOX website and view latest electronic instruction.
22. Some products have built-in lithium batteries. Please use specified chargers, and use them within a proper range of the specified voltage and temperature according to the correct operating instructions.
23. Some products are battery powered. Do not use any batteries, power sources or accessories not specified in the instructions for such products. Keep batteries and other accessories out of the reach of children and infants. In the instance that a child or infant swallows a battery or accessory, immediate emergency medical attention is required. If the battery leaks, becomes discolored, deformed, emits smoke, or emits an abnormal odor, remove it immediately. Be careful during removal to avoid burns. Continued use could result in fire, electric shock, or burns. Do not use any deformed or modified batteries. Do not disassemble or modify this product or battery. Do not heat or solder the battery. Keep the battery away from fire or water. Do not incorrectly insert the positive and negative ends of batteries, or mix old and new batteries or batteries of different types together.
24. One-year warranty period, accessories such as consumable batteries, adapters, power cords, etc. are not covered by this warranty.
25. If it is found that the equipment is repaired without authorization, the one-year warranty period will be cancelled and relevant fees will be charged for maintenance.
26. Machine failures caused by non-standard operation are not covered by the warranty.

keep these instructions!

## Foreword

Thank you for purchasing a Godox product.

Godox is proud to introduce our latest product, the KNOWLED LED Light Panel P600R, which outputs up to 600W and supports a voltage range of AC 100V-240V, making it suitable for shooting scenes worldwide. The P600R features a built-in light control system, ultra-high brightness, precise brightness adjustment in increments of one-thousandth, four dimming curves, CCT range of 1800K-10000K, four color modes, 16 scene lighting effects, an average CRI of  $\geq 96$ , an average TLCI of  $\geq 96$ , and various wireless control options. It is suitable for a wide range of shooting scenes, including large photography studios, film and television bases, broadcasting studios, outdoor locations, and large real-world environments.

## Main Features

- The built-in light control design not only saves space but also makes lighting more convenient.
- With its powerful 600W output, it provides full power output across the entire CCT range.
- The light intensity can be smoothly adjusted from 100% to 0% in increments of one-thousandth, allowing for precise control.
- The P600R features four dimming curves: linear, S-curve, exponential, and logarithmic.
- The color temperature range is wide, adjustable from 1800K to 10000K.
- There are multiple color modes available, including HSI mode, RGBW mode, GEL mode, and X-Y mode.
- The P600R offers a variety of intelligent controls, including DMX512 (RDM) / CRMX / Ethernet (Art-Net & sACN) / Bluetooth app / On-board control
- The efficient cooling fan, combined with a new heat dissipation design, meets the heat dissipation needs of large lighting fixtures.
- The P600R features 16 FX modes, including flash, lightning, clouds, broken bulb, TV, candle, fire, fireworks, explosion, welding, police car, SOS, RGB cycle, party, pixel candle, and pixel fire.

## Warning

- ▲ High-power LED light. Do not stare at the light source or shine it directly into someone's eyes.
- ▲ Do not plug or unplug the power cord when the power is turned on, otherwise personal injuries may occur.
- ▲ Do not cover the heat dissipation vent in working status.
- ▲ Keep out of reach of children.
- ▲ Please make sure to follow the instruction manual and correctly use this professional lighting device.

## Name of Parts

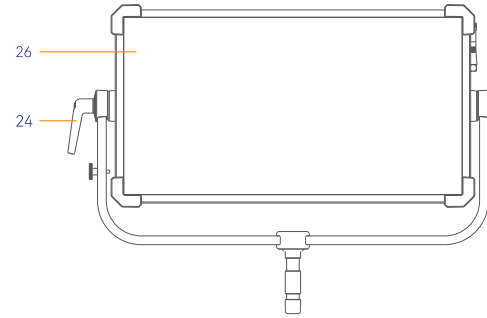
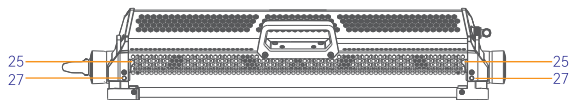
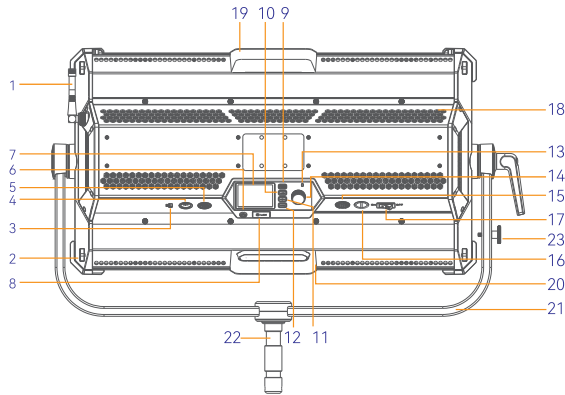

- |                         |                                   |                                |
|-------------------------|-----------------------------------|--------------------------------|
| 1. Antenna              | 10. LOCK Button                   | 19. Handle 1                   |
| 2. Ring                 | 11. MENU Button                   | 20. Handle 2                   |
| 3. USB-A Port           | 12. MODE Button                   | 21. Yoke                       |
| 4. DMX IN Port          | 13. Wireless DMX Status Indicator | 22. Bracket Handle             |
| 5. DMX OUT Port         | 14. Select Dial                   | 23. Lanyard End                |
| 6. Wire-controlled Port | 15. DC 48V Input Port             | 24. Direction Adjusting Handle |
| 7. Display              | 16. AC Input Port                 | 25. Accessory Locking Pusher   |
| 8. Ethernet Port        | 17. Power Switch                  | 26. Removable Diffuser         |
| 9. PRESET Button        | 18. Thermovent                    | 27. Safety Lock Button         |

Note: When using DC48V power supply, the switch button is not functional. The light will turn on directly when the power cord is connected and turn off directly when the power cord is disconnected.



## What is Inside P600R

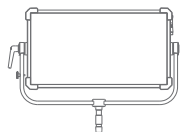

Light Body x 1



Antenna x 1



Tying Rope x 1



Safety Wire x 1



Main Cable x 1



Instruction Manual x 1



DMX Practical Table x 1

## What is Inside P600R K1

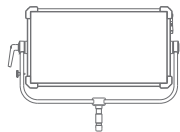

Light Body x 1



Antenna x 1



Tying Rope x 1



Safety Wire x 1



Main Cable x 1

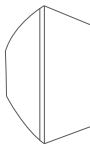

Quick Setup Softbox x 1



Soft Case SC04 x 1



Instruction Manual x 1



DMX Practical Table x 1

Note: Due to continuous updates and upgrades of the products, there may be differences between the actual products and the pictures. Therefore, the pictures are for reference only, products to prevail in kind.

## Optional Accessories

Remove Controller RC11, P.O. Yoke P600RY02, KNOWLED Octa 5' P600RO5  
KNOWLED Softbox 3'\*4' P600RS34, Barndoor P600RB4, Honeycomb P600RH30

## Installation Instructions for Yoke

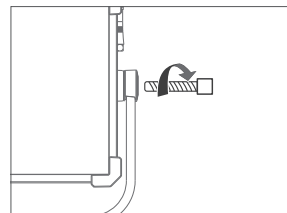
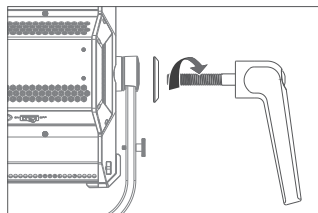

**1. Install one side first:** Place the light fixture vertically and separate the metal and plastic washers, placing them on both sides of the Yoke mounting holes. Thread the screw post of directional adjustment handle through the metal washer, Yoke, and the mounting hole of plastic washer, and finally insert it into the light body mounting hole. Tighten it clockwise to secure it.

**2. Install the other side:** Place the plastic washer between the light fixture mounting hole and the Yoke mounting hole, insert the screw post, and tighten by rotating the handle clockwise.

## Removing the Diffuser

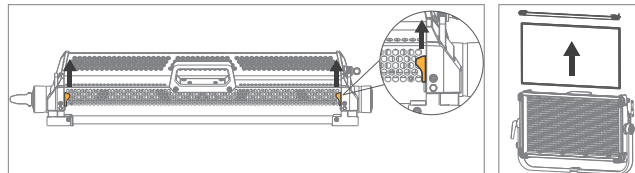

Push the attachment locking pusher on both sides of the top of the panel light forward, and after removing the light frame, slide the diffuser out of the fixture along the track to complete removal.

## Installing the Diffuser

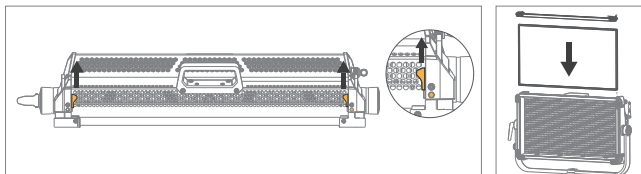

Push the attachment locking pusher on both sides of the top of the panel light forward, and after removing the light frame, insert the diffuser into the fixture along the track. Finally, press the safety lock button on both sides of the top to complete the installation.

## Connect to DMX Controller

### Wireless DMX Connection

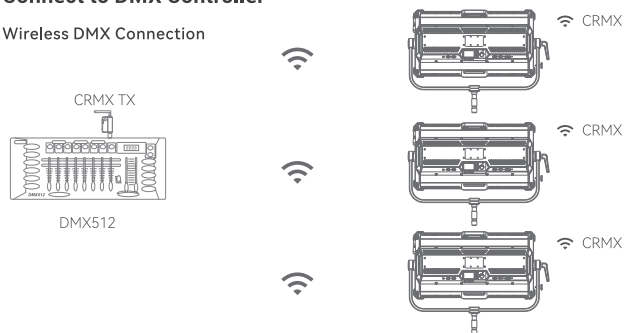

### Wired DMX Connection

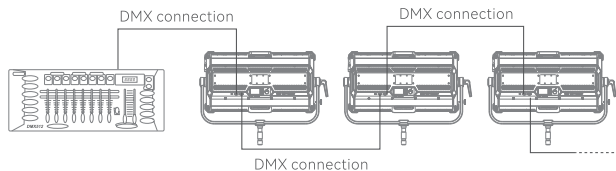

Note: DMX cable is sold separately.

## Connect to Network Settings

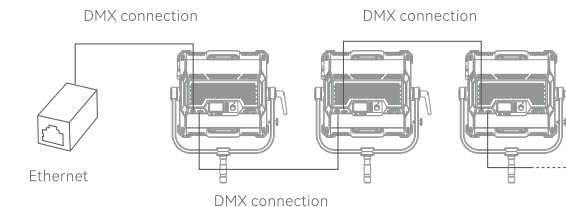
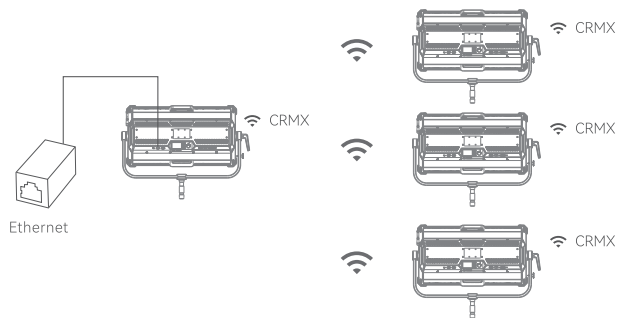

Note: DMX cable is sold separately.

## Power Switch

To turn on or off the device, connect the power supply and toggle the power switch button to the 'ON' position to turn it on or 'OFF' position to turn it off.

## CCT Mode

To access the mode selection screen, press the MODE button briefly. Rotate the select dial to select the CCT mode, and press the select dial briefly to enter the CCT mode.

Rotate the select dial to select brightness/CCT/magenta-green adjustment. Press the select dial briefly to enter a specific setting. Rotate the dial left to decrease the parameter value and right to increase the parameter value.

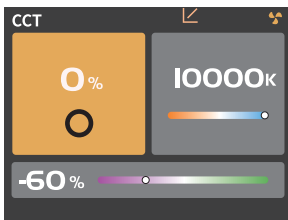

Brightness: 0%~100% (in increments of 0.1%)

CCT: 1800K~10000K (in increments of 100K)

Magenta-green: -100%~100% (in increments of 1%)

## HSI Mode

Press the MODE button briefly to enter the mode selection interface. Rotate the select dial to select the HSI Mode, and press the select dial briefly to enter the HSI Mode.

Rotating the select dial allows you to adjust brightness/hue/saturation. Press the select dial briefly to enter a specific setting. Turn the dial left to decrease the parameter value and right to increase the parameter value.

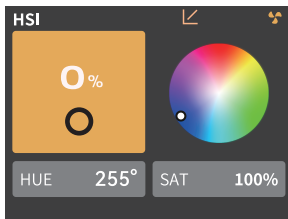

Brightness: 0%~100% (in increments of 0.1%)

Hue: 0°~360° (in increments of 1°)

Saturation: 0%~100% (in increments of 1%)

## RGBW Mode

Press the MODE button briefly to enter the mode selection interface. Rotate the select dial to select RGBW, and press the select dial briefly to enter the RGBW Mode.

Rotating the select dial allows you to adjust brightness/red/green/blue/white color. Press the select dial briefly to enter a specific setting. Turn the dial left to decrease the parameter value and right to increase the parameter value.

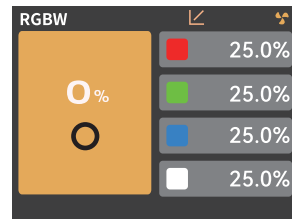

Brightness: 0%~100% (in increments of 0.1%)

Red: 0%~100% (in increments of 0.1%)

Green: 0%~100% (in increments of 0.1%)

Blue: 0%~100% (in increments of 0.1%)

White: 0%~100% (in increments of 0.1%)

## GEL Mode

Press the MODE button briefly to enter the mode selection interface. Rotate the select dial to select the GEL Mode, and press the select dial briefly to enter the GEL Mode. Rotating the select dial allows you to adjust brightness/gel type/gel group type/color selection/color temperature/hue/saturation. Press the select dial briefly to enter a specific setting. Turn the dial left to decrease the parameter value and right to increase the parameter value.

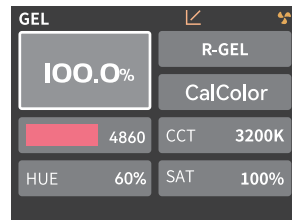

Brightness: 0%~100% (in increments of 0.1%)

Gel Type: R-GEL/L-GEL

Gel Group Type: Color correction/ CalColor/Storaro Selection/Cinelux (R-GEL)/Color Correction/Color Filters/600 Series/Cosmetic Filters/700 Series (L-GEL)

Color Temperature: 3200K or 5600K

Hue: 0°~360° (in increments of 1°)

Saturation: 0%~100% (in increments of 1%)

## X-Y Mode

Press the MODE button briefly to enter the mode selection interface. Rotate the select dial to select the X-Y Mode, and press the select dial briefly to enter the X-Y Mode.

Rotating the select dial allows you to adjust brightness/X-coordinate/Y-coordinate/color temperature or color space. Press the select dial briefly to enter a specific setting and then rotate the select dial to adjust the parameter.

Brightness: 0%~100% (in increments of 0.1%)

X-coordinate: 0.0000~0.8500

Y-coordinate: 0.0000~0.9500

Color Temperature or Color Space: Gamut, Rec.2020, DCI-P3, Rec.709, Black Body

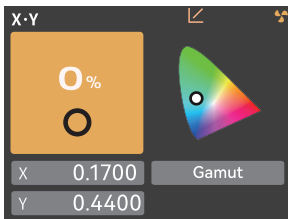

## FX Mode

Press the MODE button briefly to enter the mode selection interface. Rotate the select dial to select the FX Mode, and press the select dial briefly to enter the FX Mode.

Rotating the select dial allows you to select from the following light effects: flash/lightning/cloudy/broken bulb/TV/candle/firework/explosion/welding/police car/SOS/RGB-W/party/pixel candle/pixel fire. Press the select dial briefly to enter a specific setting.

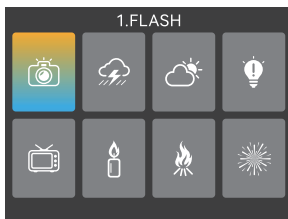

## 1. Flash

This light effect simulates the flash of a strobe light or a traditional magnesium light, often used to create a lively and dynamic atmosphere.

Rotate the select dial to select a specific setting.

Press the select dial briefly to select an option and then adjust the parameter by rotating the dial as needed. Once you have finished setting the parameters, press the select dial briefly to return to the previous level.

Brightness: 0%~100% (in increments of 0.1%)
On/Off: Turn the light on or off
Type: CCT/HSI
Color Temperature/Hue: 1800K-10000K/0-360°
Trigger: Manual/Auto
Speed: 1-100
Mode: Flash/Magnesium Light

Note: If you select Manual mode, press the select dial briefly once to trigger the flash light effect.

## 2. Lightning

This light effect simulates the lightning of thunder, often used to create a tense, terrifying, or mysterious atmosphere.

Rotate the select dial to select a specific setting.

Press the select dial briefly to select an option and then adjust the parameter by rotating the dial as needed. Once you have finished setting the parameters, press the select dial briefly to return to the previous level.

Brightness: 0%~100% (in increments of 0.1%)
On/Off: Turn the light on or off
Color Temperature: 1800K-10000K
Trigger: Manual/Auto
Flashes: Random/1-10
Frequency: Random/1-20

Note: If you select Manual mode, press the select dial briefly once to trigger the lightning effect.

## 3. Cloudy

This light effect simulates the obstructive effect of clouds and is often used to create a gloomy, oppressive, or sad atmosphere.

Rotate the select dial to select a specific setting.

Press the select dial briefly to select an option and then adjust the parameter by rotating the dial as needed. Once you have finished setting the parameters, press the select dial briefly to return to the previous level.

Brightness: 0%~100% (in increments of 0.1%)
On/Off: Turn the light on or off
Brightness Ratio: 10-90
Speed: Random/1-100

## 4. Broken Bulb

This light effect simulates a flash from a broken bulb and is often used to create a dim, yellowish atmosphere.

Rotate the select dial to select a specific setting.

Press the select dial briefly to select an option and then adjust the parameter by rotating the dial as needed. Once you have finished setting the parameters, press the select dial briefly to return to the previous level.

Brightness: 0%~100% (in increments of 0.1%)
On/Off: Turn the light on or off
Type: CCT/HSI
Color Temperature/Hue: 1800K-10000K/0-360°
Speed: 1-100

## 5. TV

This light effect simulates the lighting effect of a TV or screen and is often used to create a cold, mechanical, or digitized atmosphere.

Rotate the select dial to select a specific setting. Press the select dial briefly to select an option and then adjust the parameter by rotating the dial as needed. Once you have finished setting the parameters, press the select dial briefly to return to the previous level.

Brightness: 0%~100% (in increments of 0.1%)
On/Off: Turn the light on or off
Type: CCT/HSI
Speed: 1-100

## 6. Candle

This light effect simulates the lighting effect of a candle and is often used to create a soft, warm, and flickering atmosphere.

Rotate the select dial to select a specific setting. Press the select dial briefly to select an option and then adjust the parameter by rotating the dial as needed. Once you have finished setting the parameters, press the select dial briefly to return to the previous level.

Brightness: 0%~100% (in increments of 0.1%)
On/Off: Turn the light on or off
Speed: 1-100

## 7. Fire

This light effect simulates the lighting effect of a flame and is often used to create a bright, warm, and flickering atmosphere.

Rotate the select dial to select a specific setting. Press the select dial briefly to select an option and then adjust the parameter by rotating the dial as needed. Once you have finished setting the parameters, press the select dial briefly to return to the previous level.

Brightness: 0%~100% (in increments of 0.1%)
On/Off: Turn the light on or off
Speed: 1-100

## 8. Firework

This light effect simulates the lighting effect of firework and is often used to create a colorful, romantic, and dazzling atmosphere.

Rotate the select dial to select a specific setting. Press the select dial briefly to enter an option and then adjust the parameter by rotating the dial as needed. Once you have finished setting the parameters, press the select dial briefly to return to the previous level.

Brightness: 0%~100% (in increments of 0.1%)
On/Off: Turn the light on or off
Speed: 1-100
Embers: 1-100

## 9. Explosion

This light effect simulates the lighting effect of an explosion and is often used to create a bright, intense, and flickering atmosphere.

Rotate the select dial to select a specific setting. Press the select dial briefly to select an option and then adjust the parameter by rotating the dial as needed. Once you have finished setting the parameters, press the select dial briefly to return to the previous level.

Brightness: 0%~100% (in increments of 0.1%)
On/Off: Turn the light on or off
Trigger: Manual/Auto
Type: CCT/HSI
Color Temperature/Hue: 1800K-10000K/0-360°
Embers: 1-100
Speed: 1-100

Note: To activate the explosion light effect when set to manual mode, press the select dial once briefly.

## 10. Welding

This light effect simulates the lighting effect of welding and is often used to create a hot and mechanical atmosphere.

Rotate the select dial to select a specific setting. Press the select dial briefly to select an option and then adjust the parameter by rotating the dial as needed. Once you have finished setting the parameters, press the select dial briefly to return to the previous level.

Brightness: 0%~100% (in increments of 0.1%)
On/Off: Turn the light on or off
Type: CCT/HSI
Color Temperature/Hue: 1800K-10000K/0-360°
Speed: 1-100

## 11. Police Car

This lighting effect simulates the flashing lights of a police car and is commonly used to create a tense, chasing, or suspenseful atmosphere.

Rotate the select dial to select a specific setting. Press the select dial briefly to select an option and then adjust the parameter by rotating the dial as needed. Once you have finished setting the parameters, press the select dial briefly to return to the previous level.

Brightness: 0% to 100% (in increments of 0.1%)
On/Off: Turn the light on or off
Colors: Red+Blue, Red, Blue, White+Blue, Yellow+Blue, Yellow, Red+Blue+White, Red+Yellow+Blue
Modes: 1-5

## 12. SOS SOS

This lighting effect simulates the flashing of an SOS distress signal and is commonly used to create a dangerous, distressing, or emergency atmosphere.

Rotate the select dial to select a specific setting. Press the select dial briefly to select an option and then adjust the parameter by rotating the dial as needed. Once you have finished setting the parameters, press the select dial briefly to return to the previous level.

The interface parameters are displayed as follows:

Brightness: 0% to 100% (in increments of 0.1%)
On/Off: Turn the light on or off
Type: CCT/HSI
Color Temperature/Hue: 1800K-10000K/0-360°

## 13. RGB Cycle

This lighting effect simulates the cycle and variation of colored light effects, and is commonly used to create a dreamy, sci-fi atmosphere.

Rotate the select dial to select a specific setting. Press the select dial briefly to select an option and then adjust the parameter by rotating the dial as needed. Once you have finished setting the parameters, press the select dial briefly to return to the previous level.

Brightness: 0% to 100% (in increments of 0.1%)
On/Off: Turn the light on or off
Saturation: 0% to 100% (in increments of 1%)
Speed: 1-100

## 14. Party

This lighting effect simulates the effects of colorful lights, flash lights, and lasers, and is commonly used to create a festive, joyful, high-energy atmosphere.

Rotate the select dial to select a specific setting. Press the select dial briefly to select an option and then adjust the parameter by rotating the dial as needed. Once you have finished setting the parameters, press the select dial briefly to return to the previous level.

Brightness: 0% to 100% (in increments of 0.1%)
On/Off: Turn the light on or off
Saturation: 0% to 100% (in increments of 1%)
Speed: 1-100

## 15. Pixel Candle

This lighting effect simulates the light of a candle and, compared to a regular candle effect, has a breathing effect. It is commonly used to create a classical, mysterious, and soft atmosphere.

Rotate the select dial to select a specific setting. Press the select dial briefly to select an option and then adjust the parameter by rotating the dial as needed. Once you have finished setting the parameters, press the select dial briefly to return to the previous level.

Brightness: 0% to 100% (in increments of 0.1%)
On/Off: Turn the light on or off
Tone: Warm/Neutral/Cool
Speed: 1-100

## 16. Pixel Fire















This lighting effect simulates the colors and burning effect of fire and has a breathing effect compared to a regular fire effect. It is commonly used to create a tense, dangerous, and passionate atmosphere.

Rotate the select dial to select a specific setting. Press the select dial briefly to select an option and then adjust the parameter by rotating the dial as needed. Once you have finished setting the parameters, press the select dial briefly to return to the previous level.

Brightness: 0% to 100% (in increments of 0.1%)
On/Off: Turn the light on or off
Tone: Warm/Neutral/Cool
Speed: 1-100

## Menu Settings

Press the MENU button briefly to enter the menu settings. Rotate the select dial to choose from DMX, CRMX, Bluetooth, Network Settings, Art-Net & sACN, Dimming Curve, Control Mode, Color Space, Fan, Display, Version & Upgrade, Language, and Fixture Info.

 DMX	002
 CRMX	Off
 Bluetooth	Off
 Network Settings	Off
 Art-Net & sACN	Auto
 Dimming Curves	Linear
 Control Mode	Normal
 Color Space	Original Gamut
 Fan	Medium
 Display	80%
 Language	English
 Version & Upgrade	V0.054
 Factory Reset	
 Fixture Info	

## 1. DMX

Press the select dial briefly to enter the DMX settings interface. Rotate the dial to choose from Address/DMX Mode/RDM Status/DMX Loss Status/Termination Switch/Enhanced Channel. Press the dial briefly to enter the option settings, and adjust the settings by rotating the dial as needed.

DMX	
Address	001
DMX Mode	01:CCT 8 Bit
RDM State	On
DMX Loss	Black Out After 2 Min
Termination	On

Interface when connected to wired DMX

DMX	DIM:50%
DMX Mode: 15: CCT +RGBW Engine 8 Bit	
DMX Terminal: Off	
DMX Address: 67	
IP: 192.168.1.2	
Occupied Channels: 36	
RDM State: On	

Interface when connected to CRMX

CRMX	DIM:50%
DMX Mode: 15: CCT +RGBW Engine 8 Bit	
DMX Terminal: Off	
DMX Address: 67	
IP: 192.168.1.2	
Occupied Channels: 36	
RDM State: On	

Level 1 Option	Level 2 Option	Description
<b>Address</b>	001-512	Initial Address
<b>DMX Mode</b>	01: CCT 8 Bit	CCT 8 bit
	02: HSI 8 Bit	HSI 8 bit
	03: RGB 8 Bit	RGB 8 bit
	04: RGBW 8 Bit	RGBW 8 bit
	05: RGBWW 8 Bit	RGBWW 8 bit
	06: CCT+HSI 8 Bit	CCT+HSI 8 bit
	07: CCT+RGBW 8 Bit	CCT+RGBW 8 bit
	08: FX 8 Bit	FX 8 bit
	09: GEL 8 Bit	GEL 8 bit
	10: CCT 16 Bit	CCT 16 bit
	11: HSI 16 Bit	HSI 16 bit
	12: RGB 16 Bit	RGB :16 bit
	13: RGBW 16 Bit	RGBW 16 bit
	14: X-Y 16 Bit	X-Y 16 bit
	15: FX 16 Bit	FX 16 bit
	16: GEL 16 Bit	GEL 16 bit
	17: RGB Engine 8 Bit	RGB 8 bit(Pixel)
	18: RGBW Engine 8 Bit	RGBW 8 bit(Pixel)
	19: HSI Engine 8 Bit	HSI 8 bit(Pixel)
	20: CCT+RGBW Engine 8 Bit	CCT+RGBW 8 bit(Pixel)
<b>RDM State</b>	On	Turn on RDM, the ADD and DMX mode can be set by controller.
	Off	Turn off RDM
<b>DMX Lost</b>	Hold Last Command	After the DMX control signal is lost, continue to use the last received DMX control signal until power down or a valid DMX control signal is received again.
	Black Out	The light is off immediately.
	Black Out After 2 Min.	After the DMX control signal is lost, continue to use the last received DMX control signal for 2 minutes then black out. Note: If a valid DMX control signal is received within 2 minutes, then use the new DMX control signal.
<b>Termination</b>	On	Turn on DMX terminal
	Off	Turn off DMX terminal
<b>Extended DMX Channels</b>	On	Turn on extend DMX channels
	Off	Turn off extend DMX channels

Note: Control the device by DMX/RDM. The DMX Practical Table can be downloaded from the official website <https://www.godox.com.cn>.

## 2. CRMX

Press the select dial briefly to enter the CRMX settings interface. Rotate the dial to choose from CRMX On/Off, Mode, Transmit Power, and Reset. Press the dial briefly to enter a specific setting. Once the settings are complete, press the MENU button briefly to return to the previous level.

Reset: Press the select dial briefly to enter the reset interface, then press the dial briefly to reset.

CRMX: On/Off

Mode: Transmit/Receive Mode

Transmit Power: 5dbm, 11 dbm, 16dbm, 20dbm

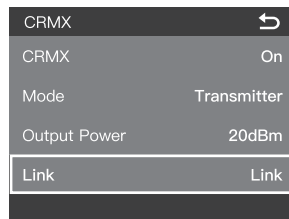

## 3. Bluetooth

Press the select dial briefly to enter the Bluetooth settings interface. Rotate the dial to choose from Bluetooth On/Off and Bluetooth Reset, then press the dial briefly to enter a specific setting. Once the settings are complete, press the MENU button briefly to return to the previous level.

Bluetooth On/Off: Adjust the setting by rotating the select dial.

Bluetooth Reset: Press the dial briefly to select "Apply" then press it again to complete the setting.

Bluetooth MAC Address: Located in the lower left corner of the interface, making it easy to find the Bluetooth of the fixture.

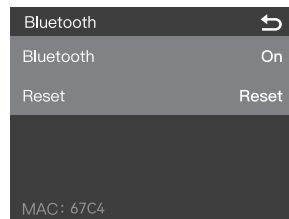

### Download"GODOX Light"App

Scan the QR code to download the "Godox Light" smartphone app (can be used in Android and iOS).

Note:

1.The App can be used directly on the firstly installed device (smartphone or laptop). When change to other mobile device (smartphone or iPad), the light shall be reset before the normal connection of the app.

2.The app version should be 3.0 or above.





## 4. Network Settings

Press the select dial briefly to enter network settings interface. Press the select dial briefly to select network mode, then rotate to select among DHCP, Art-Net 2.x, Art-Net 10.x and manual. Finally, press the MENU button briefly to return to the previous menu.

Network Settings	
Network Mode	Auto
IP	255.255.255.0
Subnet Mask	255.255.255.0
Default Gateway	192.168.88.30
MAC:	

Level 1 Option	Level 2 Option	Description
Network Mode	DHCP	DHCP mode
	Art-Net 2.x	To use 2.B.C.D network
	Art-Net 10.x	To use 10.B.C.D network
	Manual	Set the network IP, subnet mask, and default gateway manually.
IP	AAA.BBB.CCC.DDD	The ID address is assigned by DHCP in DHCP mode. The ID address is 2.B.C.D in Art-Net 2.x mode. The ID address is 10.B.C.D in Art-Net 10.x mode. In manual mode: AAA=0-255 BBB=0-255 CCC=0-255 DDD=0-255
Subnet Mask	255.BBB.CCC.DDD	The subnet mask is 255.BBB.CCC.DDD and can not be adjusted by menu settings in DHCP/Art-Net 2.x/Art-Net 10.x mode. In manual mode: AAA=0-255 BBB=0-255 CCC=0-255 DDD=0-255
Default Gateway	AAA.BBB.CCC.DDD	The default gateway is assigned by DHCP in DHCP mode. The default gateway is 2.B.C.D in Art-Net 2.x mode. The default gateway is 10.B.C.D in Art-Net 10.x mode. In manual mode: AAA=0-255 BBB=0-255 CCC=0-255 DDD=0-255

## 5. Art-Net & sACN

Press the select dial briefly to enter Art-Net & sACN setting interface. Rotate the select dial to select options among Art-Net&sACN, Art-Net Net, Art-Net Sub-Net, Art-Net Port, Art-Net Universe and sACN Universe, then press the select dial briefly to enter a specific setting. Once the settings are complete, press the MENU button briefly to return to the previous menu.

Art-Net & sACN Settings	
Art-Net & sACN	Auto
Art-Net Net	127
Art-Net Sub-Net	15
Art-Net Port	11

Level 1 Option	Level 2 Option	Description
Art-Net&sACN	Auto/Art-Net/sACN/Off	Auto: Art-Net & sACN two protocols are accepted. Art-Net: Only Art-Net protocol. sACN: Only sACN protocol. Off: No network protocols are accepted.
Art-Net Net	0-127	Art-Net network
Art-Net Sub-Net	0-15	Choose Art-Net subnet in Art-Net network.
Art-Net Universe	0..32767	Art-Net universe
sACN Universe	1..63999	sACN universe

## 6. Dimming Curves

Press the select dial briefly to enter dimming curves setting interface. Rotate and press the select dial briefly to choose among linear, S-curve, exponential and logarithmic. Once the settings are complete, press the MENU button briefly to return to the previous menu.

Dimming Curves	
Linear	S-Curve
Exponential	Logarithmic

## 7. Control Mode

Press the select dial briefly to enter the control mode. Press the select dial briefly select the mode, rotate the select dial to choose the corresponding mode. Once the settings are complete, press the MENU button briefly to return to the previous menu.

Modes: Normal, High Speed, and Low Light.  
Frequency: 1-11.

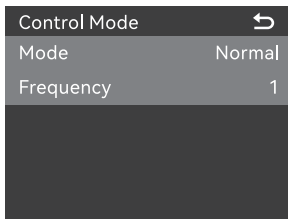

## 8. Color Space

Press the select dial briefly to enter the color space. Press the select dial briefly select the color space, rotate the select dial to choose the corresponding color space. Once the settings are complete, press the MENU button briefly to return to the previous menu.

Color Space: Original Gamut, Correction Gamut, REC 709, and DCI-P3.

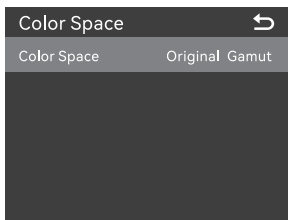

## 9. Fan

Press the select dial briefly to enter fan setting interface. Rotate and press the select dial briefly to choose among silent, auto, medium speed and high speed. Once the settings are complete, press the MENU button briefly to return to the previous menu.

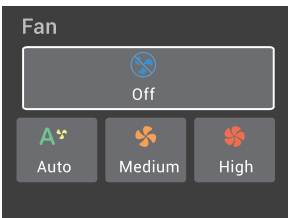

Maximum brightness value of lamp body in the same state (%)

Fan State	Linear	S-curve	Exponential	Logarithmic
Mute(off)	20%	36.5%	52.4%	8.7%
Auto	100%	100%	100%	100%
Medium Speed	75%-100%	60%-100%	86%-100%	40%-100%
High Speed	100%	100%	100%	100%

Note: When the fan is in medium mode, the maximum brightness value changes with the ambient temperature.

## 10. Display

Press the select dial to enter display setting interface. Rotate and press the select dial briefly to adjust display brightness from 10% to 100%. Once the settings are complete, press the MENU button briefly to return to the previous menu.

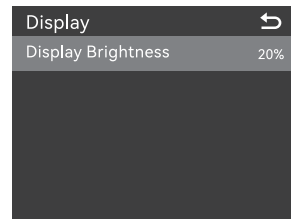

## 11. Language

Press the select dial to enter language setting interface. Rotate and press the select dial briefly to select between Chinese and English. Once the settings are complete, press the MENU button briefly to return to the previous menu.



## 12. Version & Upgrade

Press the select dial to enter version & upgrade setting interface to check the firmware version and upgrade instructions. Then, press the MENU button briefly to return to the previous menu.

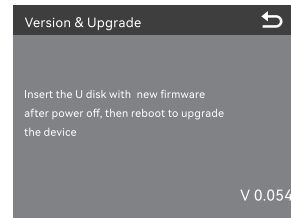

### Software Upgrade

1. Download the new firmware to the U disk from official website (<https://www.godox.com.cn/-firmware-continuous-light>).
2. Turn off the device. Insert the U disk with new firmware into the USB Type-A port.
3. Turn on the device, and it will automatically enter the upgrading interface.
4. It will return to the main interface upon completion.

#### Notes:

1. New firmware must be downloaded from the official website, and keep only one BIN file in the root directory of the USB disk.
2. The USB Type-A port can only support output voltage and current of 5V/1.5A. Do not connect to over-rated USB device.

### 13. Factory Reset

Press the select dial briefly to enter factory reset setting interface. Rotate and press the select dial briefly to select yes or no. The brightness value will turn to 100% after factory reset.

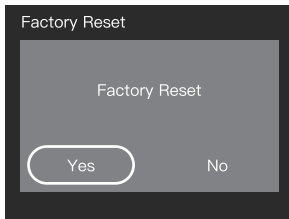

### 14. Fixture Info

Press the select dial briefly to enter fixture info setting interface to check model, UID NO., firmware version, light head temp., etc. Then, press the MENU button briefly to return to the previous menu.



### Lock Setting

Press the LOCK button briefly, the panel will be locked when <img alt="lock icon" data-bbox="98 715 112 735"/> is displayed on the panel, press the button briefly again to unlock the panel.

Note: The locking function only works on the controller panel, other operations are still available.

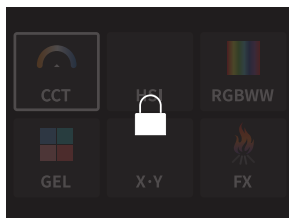

### Preset Setting

Press the PRESET button briefly to enter preset effects interface. Rotate and press the select dial briefly to choose and enter preset effects 1-20, then press briefly to choose save or cancel.

Once the settings are complete, press the select dial briefly to return to the previous menu and press the PRESET button briefly to exit.

Application: Apply the group's preset light effects

Save: Save the current effect data.

Cancel: Return to the previous menu.

Note: If a group of presets has not been preset with a light effect, the interface does not show the application options.

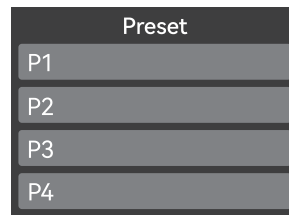

### Maintenance

This product, except consumables, is supported with a one-year warranty.

Unauthorized service will void the warranty.

Maintenance of the light must be performed by our authorized maintenance department which can provide original accessories.

If the product had failures or got wet, do not use it until it is repaired by professionals.

Shut down the device immediately should abnormal operation be detected.

### Photometric Data

CCT	Testing Condition	Unit	3m	5m	7m	9m
3200K	With diffuser	lux	≈2970	≈1360	≈836	≈562
		fc	≈276	≈126	≈77.6	≈52.2
5600K	With diffuser	lux	≈3230	≈1470	≈899	≈607
		fc	≈300	≈137	≈83.6	≈56.4

All the above tests are based on the condition of 100% brightness.

## Technical Data

<b>Model</b>	P600R
<b>Power Supply</b>	100V-240V~50/60Hz 7A or DC 48V
<b>Input Power</b>	Max.≈700W
<b>CCT</b>	1800-10000K
<b>GM Adjustment</b>	-100%~100%
<b>Brightness Range</b>	0%-100%
<b>Dimming Curves</b>	linear, S-curve, exponential, logarithmic
<b>CRI</b>	≥ 96
<b>TLCI</b>	≥ 96
<b>Controlling Methods</b>	DMX512 (RDM) / CRMX / Ethernet (Art-Net & sACN) / Bluetooth app / On-board
<b>Bluetooth Controlling Distance</b>	Max.30m
<b>USB Type-A Port</b>	Firmware Upgrade/5V≈1.5A Power Supply
<b>Working Environment Temperature</b>	-20°C-45°C
<b>Dimension(with Yoke)</b>	776mm*567mm*153mm/30.6"*22.3"*6"
<b>Netweight(with Yoke)</b>	≈18kg

Specifications and data may subject to changes without notice.

## FCC Statement

This device complies with part 15 of the FCC Rules. Operation is subject to the following two conditions:

- (1) This device may not cause harmful interference, and
- (2) this device must accept any interference received, including interference that may cause undesired operation.

Any Changes or modifications not expressly approved by the party responsible for compliance could void the user's authority to operate the equipment.

Note: This equipment has been tested and found to comply with the limits for a Class B digital device, pursuant to part 15 of the FCC Rules. These limits are designed to provide reasonable protection against harmful interference in a residential installation. This equipment generates uses and can radiate radio frequency energy and, if not installed and used in accordance with the instructions, may cause harmful interference to radio communications. However, there is no guarantee that interference will not occur in a particular installation. If this equipment does cause harmful interference to radio or television reception, which can be determined by turning the equipment off and on, the user is encouraged to try to correct the interference by one or more of the following measures:

- Reorient or relocate the receiving antenna.
  - Increase the separation between the equipment and receiver.
  - Connect the equipment into an outlet on a circuit different from that to which the receiver is connected.
  - Consult the dealer or an experienced radio/TV technician for help.
- The device has been evaluated to meet general RF exposure requirement.  
The device can be used in portable exposure condition without restriction.

## ▲ Warning

Operating frequency:

2402MHz – 2480MHz(BT)/2402MHz – 2480MHz(CRMX)

Maximum EIRP Power: 5dBm(BT)/5dBm(CRMX)

## Declaration of Conformity

GODOX Photo Equipment Co.,Ltd. hereby declares that this equipment are in compliance with the essential requirements and other relevant provisions of Directive 2014/53/EU. In accordance with Article 10(2) and Article 10(10), this product is allowed to be used in all EU member states. For more information of DoC, Please click this web link:

<https://www.godox.com/eu-declaration-of-conformity/>

The device complies with RF specifications when the device used at 0mm from your body.

## 产品保修

尊敬的用户, 本保修卡是申请保修服务的重要凭证, 请您配合销售商填写并妥善保管, 谢谢!

产品信息	型号	产品条码
用户信息	姓名	联系电话
	通信地址	
销售商信息	名称	
	联系电话	
	通信地址	
	销售日期	
备注		

注: 此表应由销售商盖章确认。

### 产品信息

本文件适用于相关《产品保修信息》(见后面说明)所列产品, 其他非属此范围的产品或部件(如促销品、赠品及其他出厂后附加的部件等)不在此保修承诺内。

### 保修期

产品及部件的相应保修期按相关的《产品保修信息》执行。保修期自产品首次购买日起算, 购买日以购买产品时保修卡登记日期为准。

### 如何获得保修服务

您可直接与产品销售商或授权服务机构联系, 也可拨打神牛产品售后服务电话, 与我们联系, 由我们的服务人员为您安排服务。申请保修时, 您应提供有效的保修卡作为保修凭证, 方可获得保修。如您不能提供有效的保修卡, 则在我们确认产品或部件属于保修范围的情况下, 也可以为您提供保修, 但这不作为我们的义务。

### 不适用保修的情况

如产品存在下列情况, 本文件项下的保证和服务将不适用: ①产品或部件超过相应保修期; ②错误或不适当使用、维护或保管导致的故障或损坏, 如: 不当搬运; 非按产品合理预期用途使用; 不当插拔外接设备; 跌落或外力挤压; 接触或暴露于不当温度、溶剂、酸碱、水浸或潮湿环境; ③由非神牛授权机构或人员安装、修理、更改、添加或拆卸造成的故障或损坏; ④产品或部件原有识别信息被修改变更或删除; ⑤无有效保修卡; ⑥使用非法授权、非标准或非公开发行的软件造成的故障或损坏; ⑦因不可抗力或意外事件造成的故障或损坏; ⑧其他非因产品本身质量问题导致的故障或损坏。遇上述情况, 您应向相关责任方寻求解决, 神牛对此不承担任何责任。因非在保修期或保修范围内的部件、附件或软件导致产品不能正常使用的, 不是保修范围内的故障。产品使用过程中正常的脱色, 磨损和消耗, 不是保修范围内的故障。

## 产品保修和服务支持信息

产品的保修期和服务类型按以下《产品保修信息》执行:

产品类别	选件名称	保修期(月)	保修服务类型
部件	电路板	12	客户送修
	电池	3	客户送修
	充电器等带电性能的部件。	12	客户送修
其他	如外壳、保护罩、锁紧装置、包装等。	无	无保修

神牛产品售后服务电话 0755-29609320-8062

## Warranty

Dear customers, as this warranty card is an important certificate to apply for our maintenance service, please fill in the following form in coordination with the seller and safe-keep it. Thank you!

Product Information	Model	Product Code Number
Customer Information	Name	Contact Number
	Address	
Seller Information	Name	
	Contact Number	
	Address	
	Date of Sale	
Note		

Note: This form shall be sealed by the seller.

### Applicable Products

The document applies to the products listed on the Product Maintenance Information (see below for further information). Other products or accessories (e.g. promotional items, giveaways and additional accessories attached, etc.) are not included in this warranty scope.

### Warranty Period

The warranty period of products and accessories is implemented according to the relevant Product Maintenance Information. The warranty period is calculated from the day (purchase date) when the product is bought for the first time. And the purchase date is considered as the date registered on the warranty card when buying the product.

### How to Get the Maintenance Service

If maintenance service is needed, you can directly contact the product distributor or authorized service institutions. You can also contact the Godox after-sale service call and we will offer you service. When applying for maintenance service, you should provide valid warranty card. If you cannot provide valid warranty card, we may offer you maintenance service once confirmed that the product or accessory is involved in the maintenance scope, but that shall not be considered as our obligation.

### Inapplicable Cases

The guarantee and service offered by this document are not applicable in the following cases:

- ① The product or accessory has expired its warranty period;
- ② Breakage or damage caused by inappropriate usage, maintenance or preservation, such as improper packing, improper usage, improper plugging in/out external equipment, falling off or squeezing by external force, contacting or exposing to the improper temperature, solvent, acid, base, flooding and damp environments, etc;
- ③ Breakage or damage caused by non-authorized institution or staff in the process of installation, maintenance, alternation, addition and detachment;
- ④ The original identifying information of product or accessory is modified, alternated, or removed;
- ⑤ No valid warranty card;
- ⑥ Breakage or damage caused by using illegally authorized, nonstandard or non-public released software;
- ⑦ Breakage or damage caused by force majeure or accident;
- ⑧ Breakage or damage that could not be attributed to the product itself.

Once met these situations above, you should seek solutions from the related responsible parties and Godox assumes no responsibility. The damage caused by parts, accessories and software that beyond the warranty period or scope is not included in our maintenance scope. The normal discoloration, abrasion and consumption are not the breakage within the maintenance scope.

## Maintenance and Service Support Information

The warranty period and service types of products are implemented according to the following Product Maintenance Information:

Product Type	Name	Maintenance Period(month)	Warranty Service Type
Parts	Circuit board	12	Customer sends the product to designated site
	Battery	3	Customer sends the product to designated site
	Electrical parts e.g.battery charger, etc.	12	Customer sends the product to designated site
Other Items	Lamp body, lamp cover, locking device, package, etc.	No	Without warranty