

ARCHITECTURAL

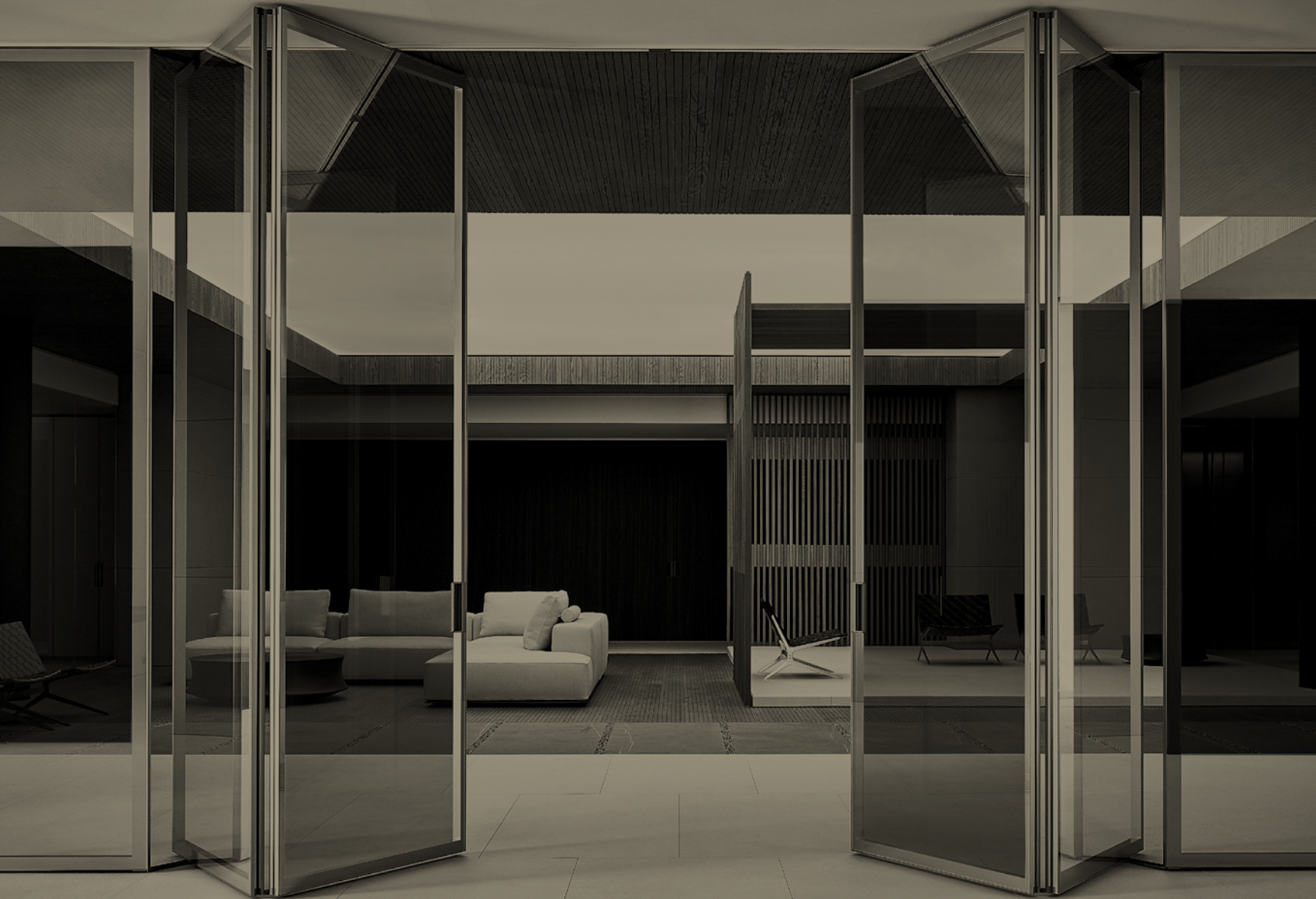

Poliform

Poliform

Poliform presenta Architectural, un progetto che ha l'ambizioso obiettivo di portare l'interior design a un altro livello. Le proposte di Architectural si rivolgono a un mercato evoluto, pronto a leggere l'ambiente domestico come uno spazio fluido dove sistemi e arredi, perfettamente integrati, danno vita a un'architettura totale.

Poliform presents Architectural, a project that has the ambitious goal of taking interior design to another level. Architectural's proposals are aimed at an advanced market, ready to interpret the domestic environment as a fluid space where systems and furnishings, perfectly integrated, give life to a total architecture.

Architectural definisce un impegno preciso nel rapporto con il mondo della progettazione di interni, nell'ottica di un'architettura totale. Al servizio di architetti e interior designer, è un concept nato per offrire una libertà progettuale senza precedenti, un sistema di elementi con cui creare soluzioni innovative.

Architectural defines a clear commitment to the world of interior design, with a focus on total architecture. At the service of architects and interior designers, it is a concept created to offer unprecedented design freedom, a system of elements with which to create innovative solutions.

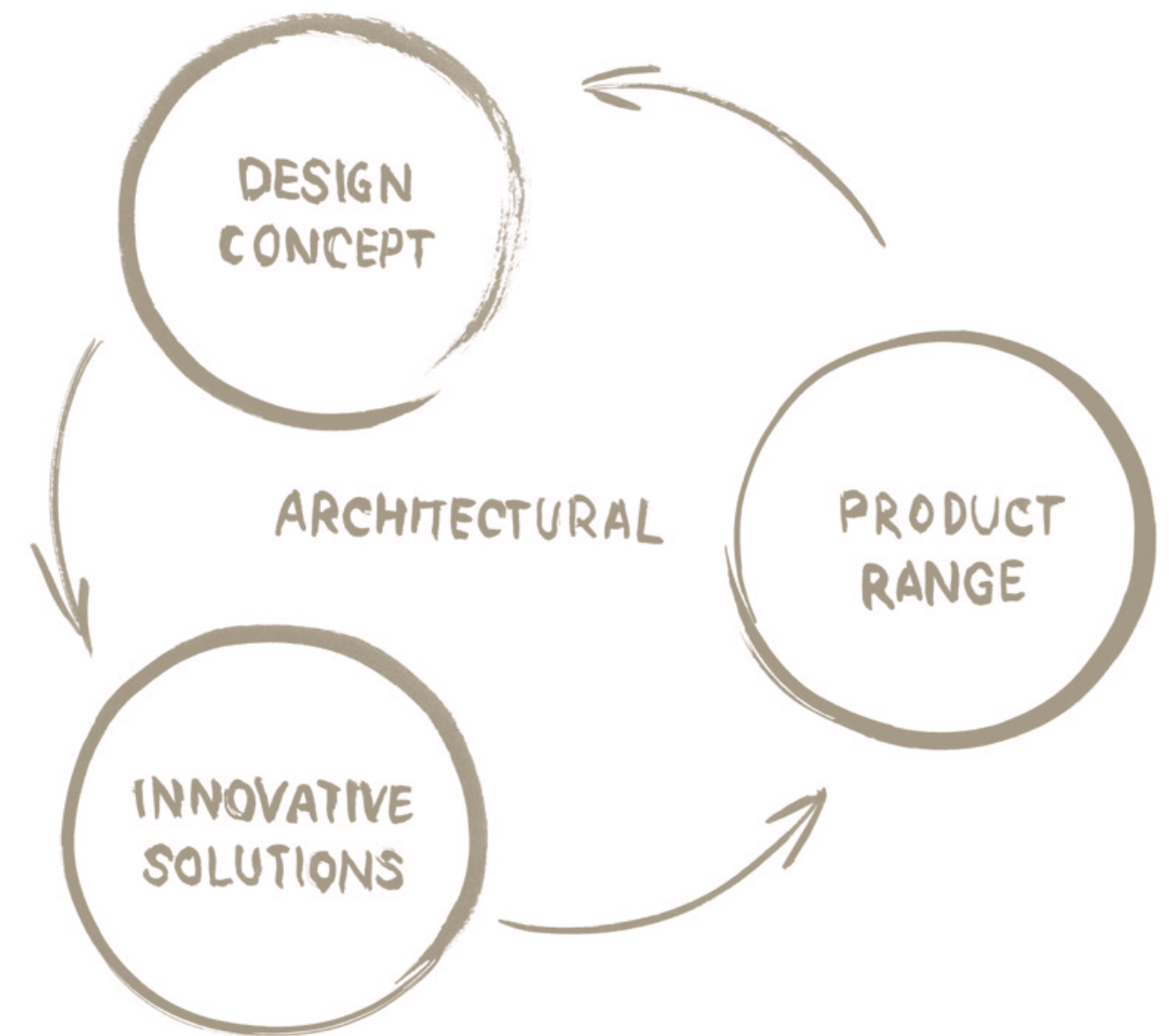

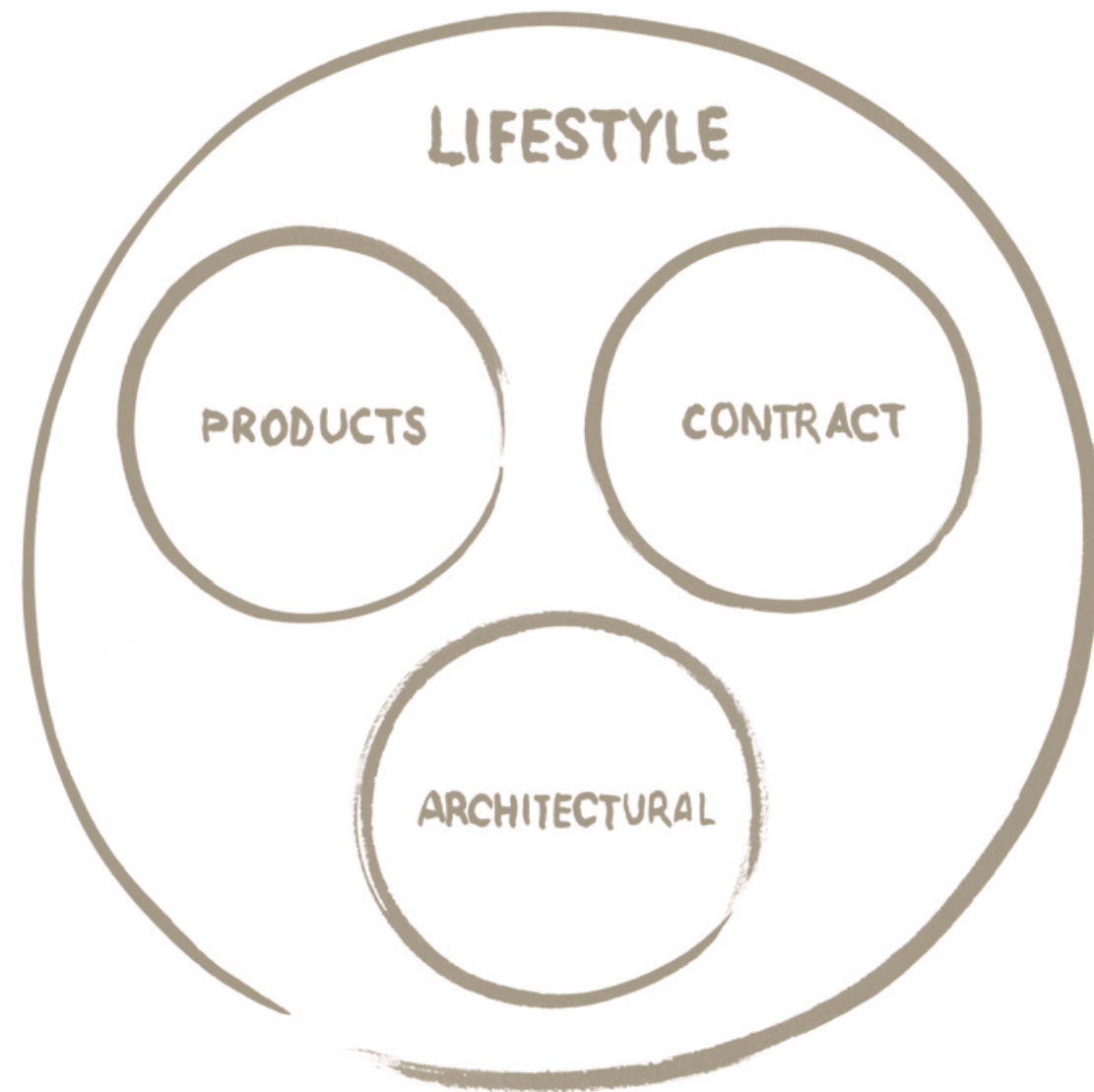

Nato da anni di confronti con i migliori architetti internazionali, e dall'analisi costante di Poliform Lab sulle tendenze dell'abitare contemporaneo, Architectural unisce la qualità delle collezioni di arredi a quella delle realizzazioni su misura, esprimendo pienamente la dimensione lifestyle del brand.

The result of years of discussions with top international architects and Poliform Lab's constant analysis of contemporary living trends, Architectural combines the quality of the furniture collections with that of made-to-measure creations, fully expressing the lifestyle dimension of the brand.

La configurazione dell'ambiente domestico è interpretata alla luce di un'architettura flessibile e leggera in cui i sistemi non solo si integrano completamente, ma creano nuovi spazi.

Architectural rappresenta l'anello di congiunzione delle collezioni Night System, Day System e Kitchen.

The configuration of the domestic environment is interpreted in the light of a flexible and lightweight architecture in which the systems not only integrate completely, but also create new spaces. Architectural is the link between the Night System, Day System and Kitchen collections.

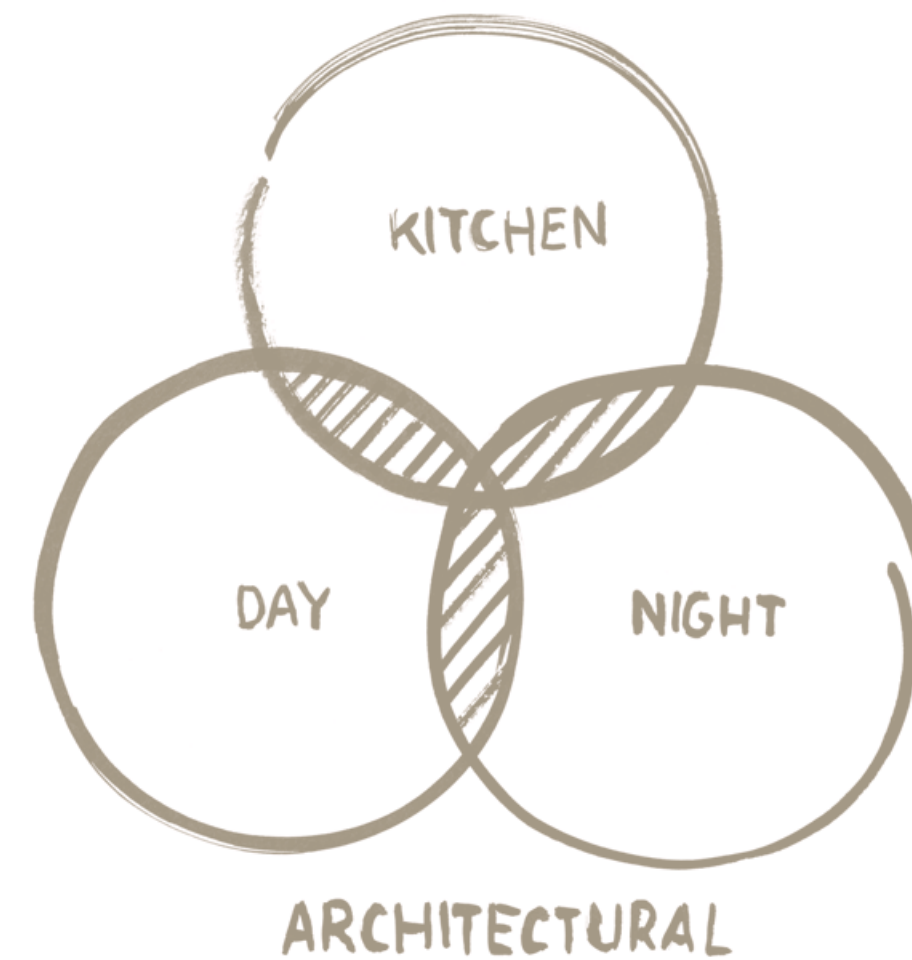

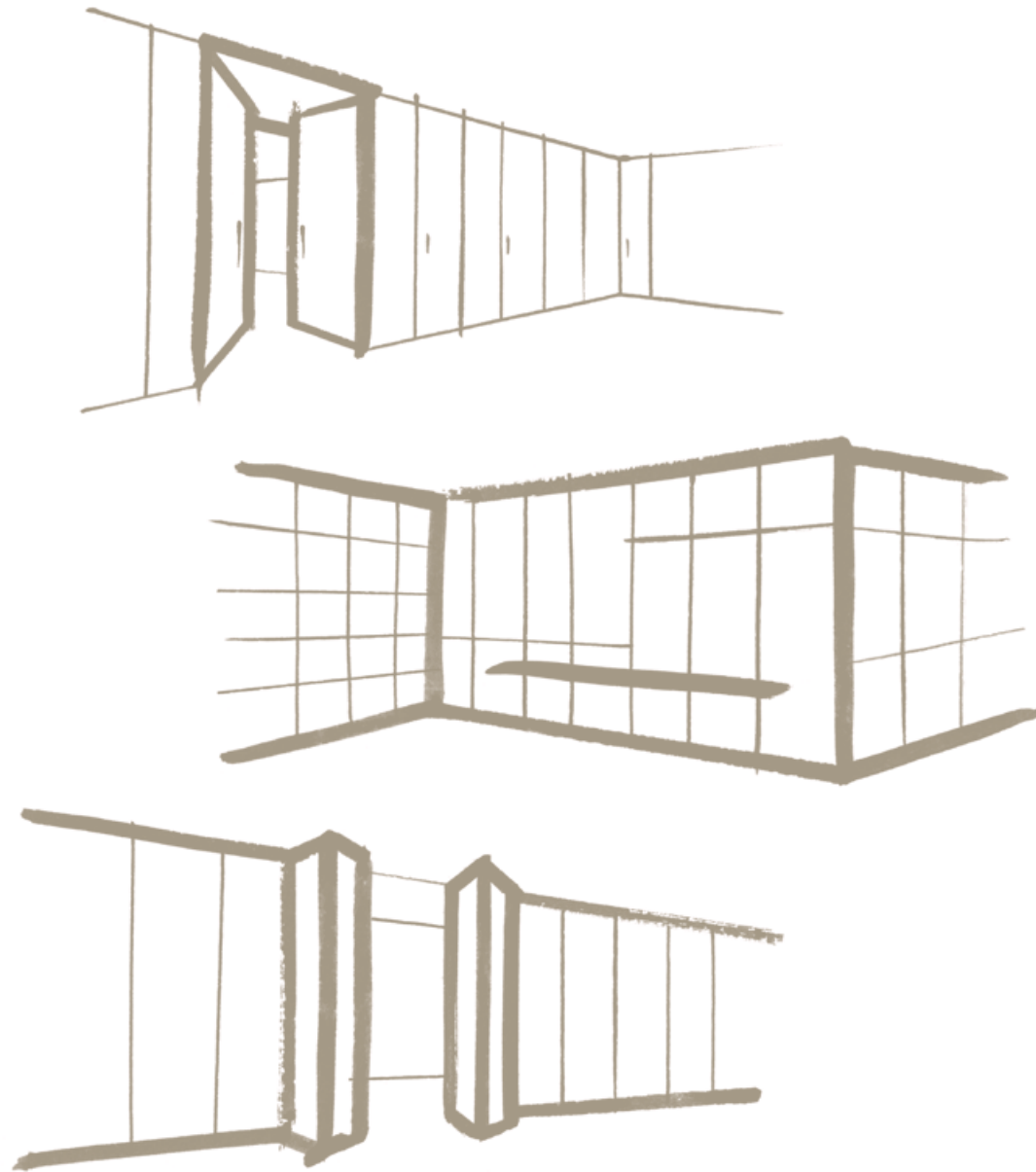

Con gli elementi di Architectural – aperture, boiserie e pannelli interparete – si mettono a punto progetti completi, dove la continuità estetica tra gli ambienti è talmente perfetta da avvicinarsi a una realizzazione artigianale. Precisione tecnica e performance di alto livello sono assicurate dalla produzione industriale.

With the elements of Architectural – openings, panelling and dividing wall panels – complete projects are developed, where the aesthetic continuity between the rooms is so perfect that it comes close to handcrafted. Technical precision and high-level performance are ensured by industrial production.

Il talento di Poliform è il saper fare, una capacità che unisce cultura e conoscenza e che, prima di essere un gesto, è un'idea di progettazione. Con Architectural, Poliform trascende la dimensione dell'arredamento per creare architetture leggere e flessibili che rispondono alle esigenze più attuali dell'abitare.

Poliform's talent is know-how, a skill that combines culture and knowledge and which, before being a concept, is a design idea. With Architectural, Poliform transcends the dimension of furniture to create lightweight, flexible architecture that responds to the latest living requirements.

Lo spazio domestico è fatto di connessioni. Connessioni tra gli ambienti, tra gli oggetti e lo spazio, tra le persone.

Per collegare gli ambienti in modo funzionale ci sono le porte pivotanti, dove finiture e maniglie sono identiche a quelle degli armadi, per un'uniformità estetica totale.

The domestic space is composed of connections.

Connections between environments, between objects and space, between people. To connect the rooms in a functional way, there are pivoting doors, where finishes and handles are identical to those of the wardrobes, for total aesthetic uniformity.

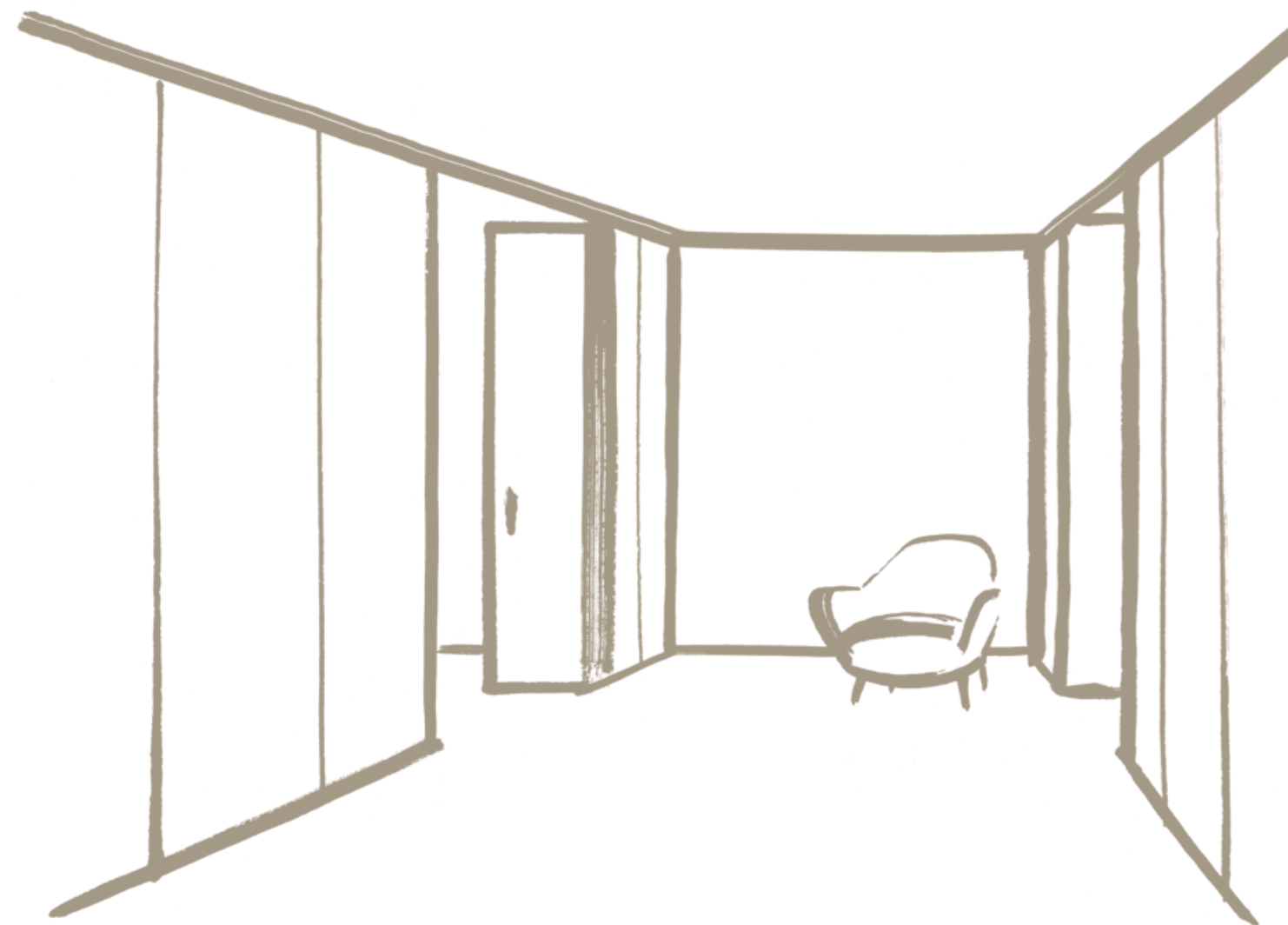



L'idea di casa passa attraverso la costruzione di spazi che si adattano a gusti, abitudini e stili di vita. Grazie alla boiserie, il retro di cucine, armadi e librerie si adatta all'ambiente, diventando una parete da attrezzare in base alle proprie esigenze.

The idea of home passes through the construction of spaces that adapt to tastes, habits and lifestyles. Thanks to the panelling, the back wall of kitchens, wardrobes and bookcases adapts to the environment, becoming a wall to be equipped in accordance with individual needs.

L'architettura è creazione di spazi dotati della qualità della permanenza. Ma se diventa leggera, può dare vita ad ambienti più flessibili, superando il concetto di costruzione tradizionale a favore della progettazione libera di spazi su misura.

Architecture is the creation of spaces with the quality of permanence. But if it becomes lightweight, it can create more flexible environments, overcoming the concept of traditional construction in favour of freely designed, made-to-measure spaces.

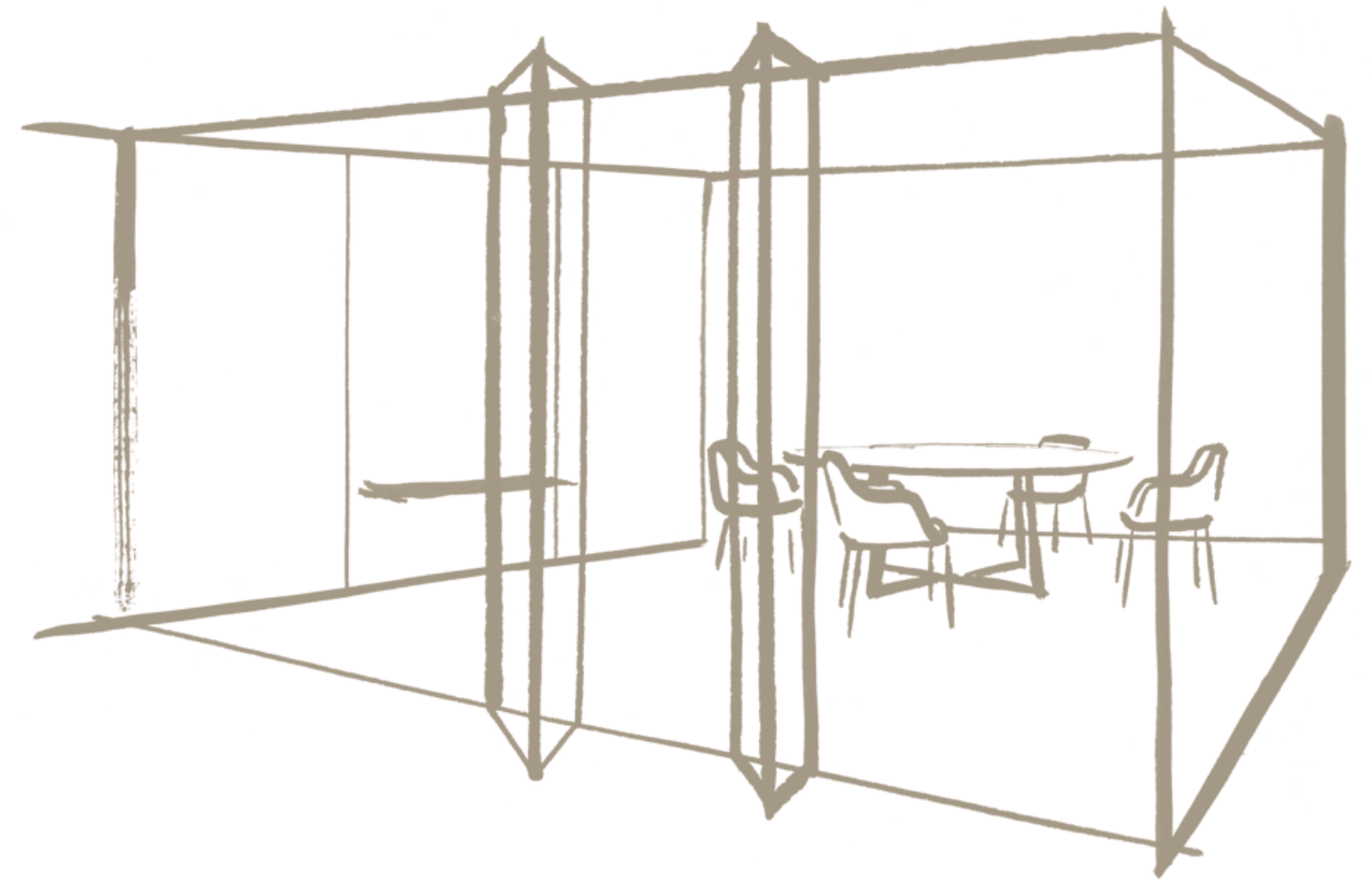

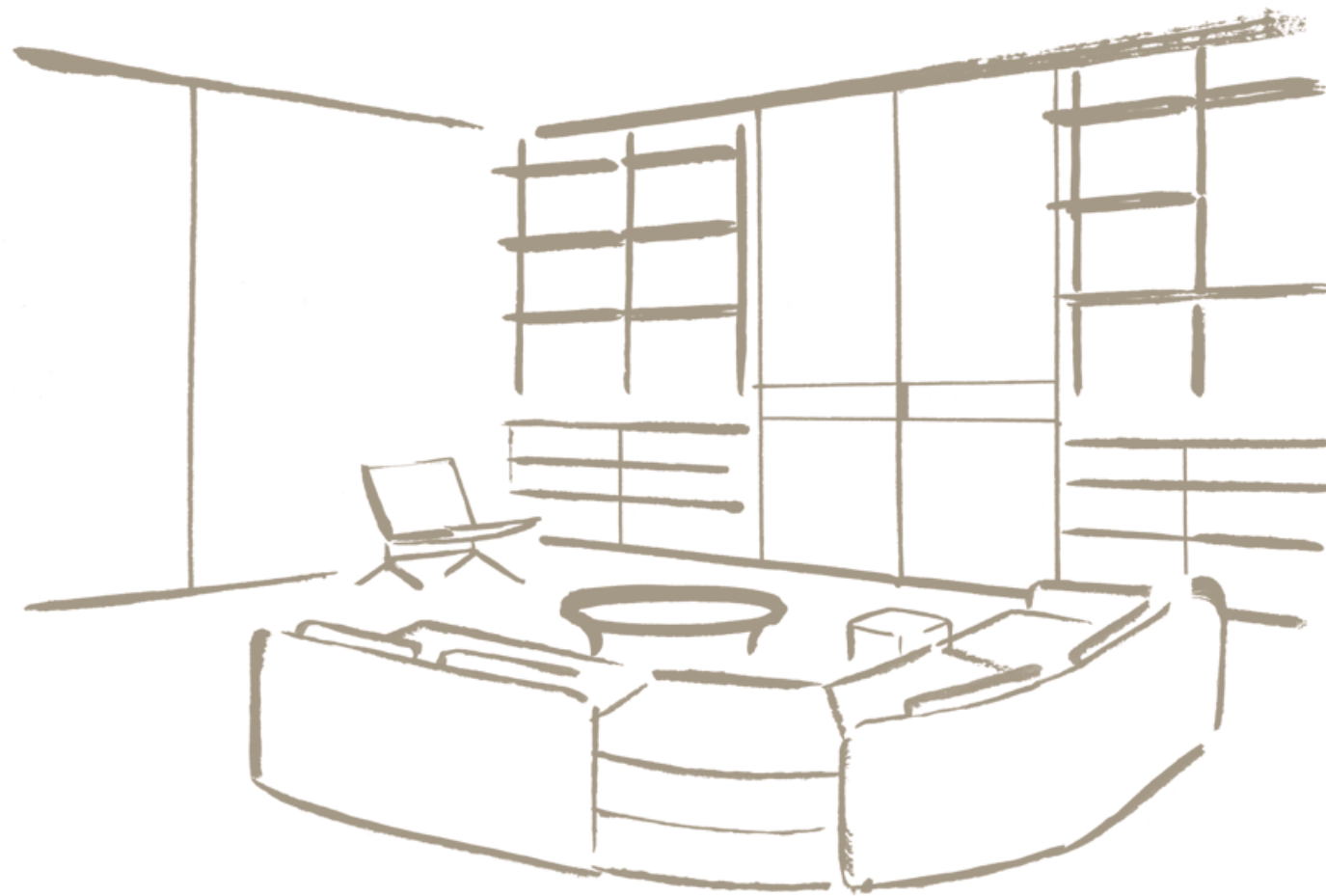

I sistemi nascono sempre ispirandosi a principi di organizzazione e integrazione. Architectural ne offre un'interpretazione contemporanea, dove attrezzature, TV e vani tecnici uniscono funzionalità e discrezione.

The systems are always inspired by principles of organisation and integration. Architectural offers a contemporary interpretation, where fittings, TVs and technical compartments combine functionality and discretion.

ARCHITECTURAL
COLLECTION

ARCHITECTURAL
COLLECTION

PIVOT DOOR SYSTEM	26
WARDROBE AREA	30
NIGHT AREA	40
KITCHEN AREA	48
SURFACE BOISERIE SYSTEM	58
DAY AREA	62
WARDROBE AREA	80
NIGHT AREA	90
TECHNICAL DATA	103



PIVOT DOOR SYSTEM

Pivot è un sistema di aperture pivotanti integrate ai sistemi Poliform. Con finiture e maniglie che riprendono quelle degli armadi della collezione Night System e delle ante della collezione Kitchen, Pivot assicura una perfetta continuità visiva.

Pivot is a system of pivoting openings integrated with Poliform systems. With finishes and handles that recall those of the Night System wardrobes collection and the Kitchen collection doors, Pivot ensures perfect visual continuity.

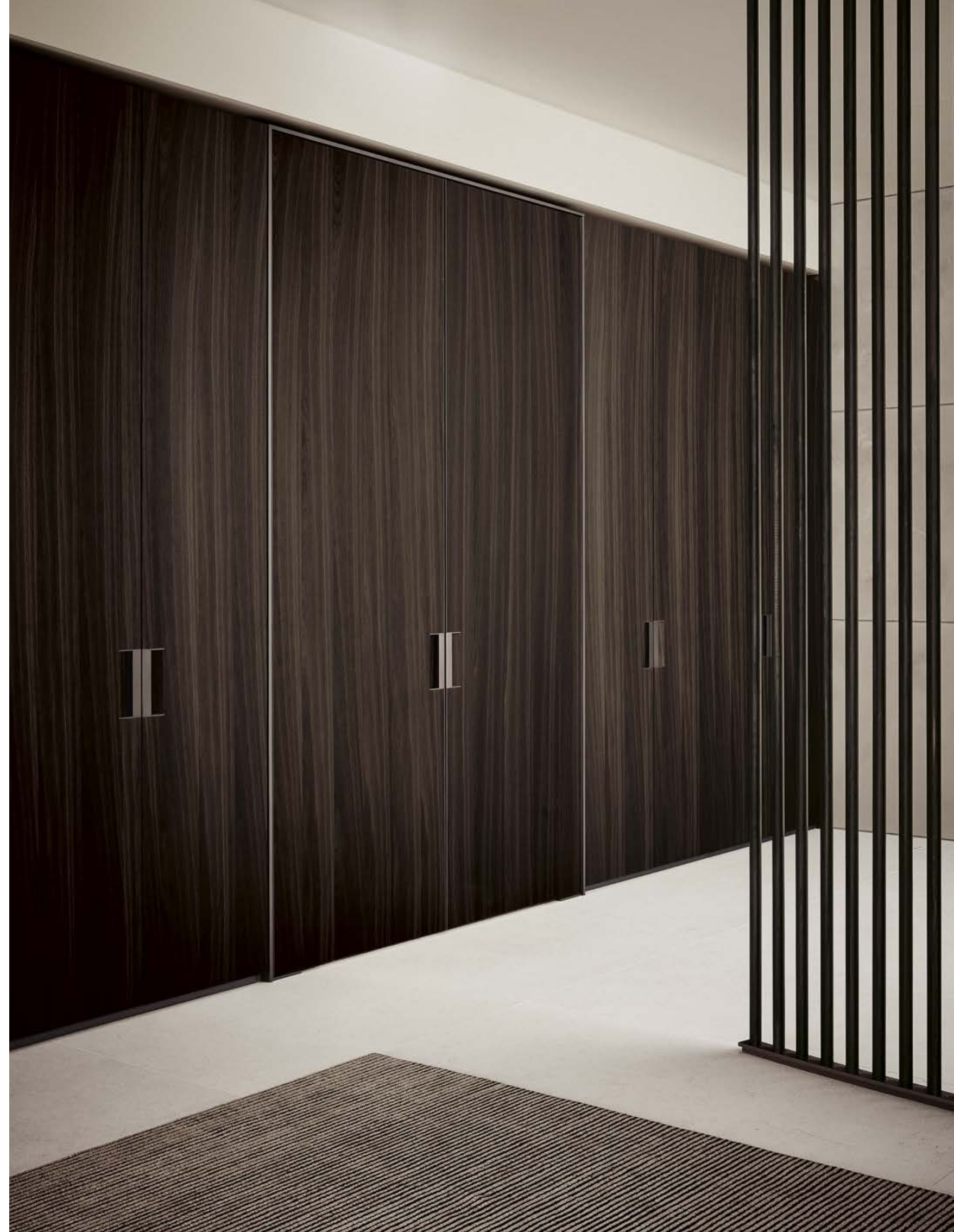



Nella zona notte, Pivot si integra al sistema di armadi Senzafine. Sia la porta Pivot Plus sia le ante dell'armadio sono in rovere spessart con telaio e maniglia Plus in ardesia opaco.

In the sleeping area, Pivot integrates with the Senzafine wardrobe system. Both the Pivot Plus door and the wardrobe doors are in spessart oak with Plus frame and handle in mat ardesia.

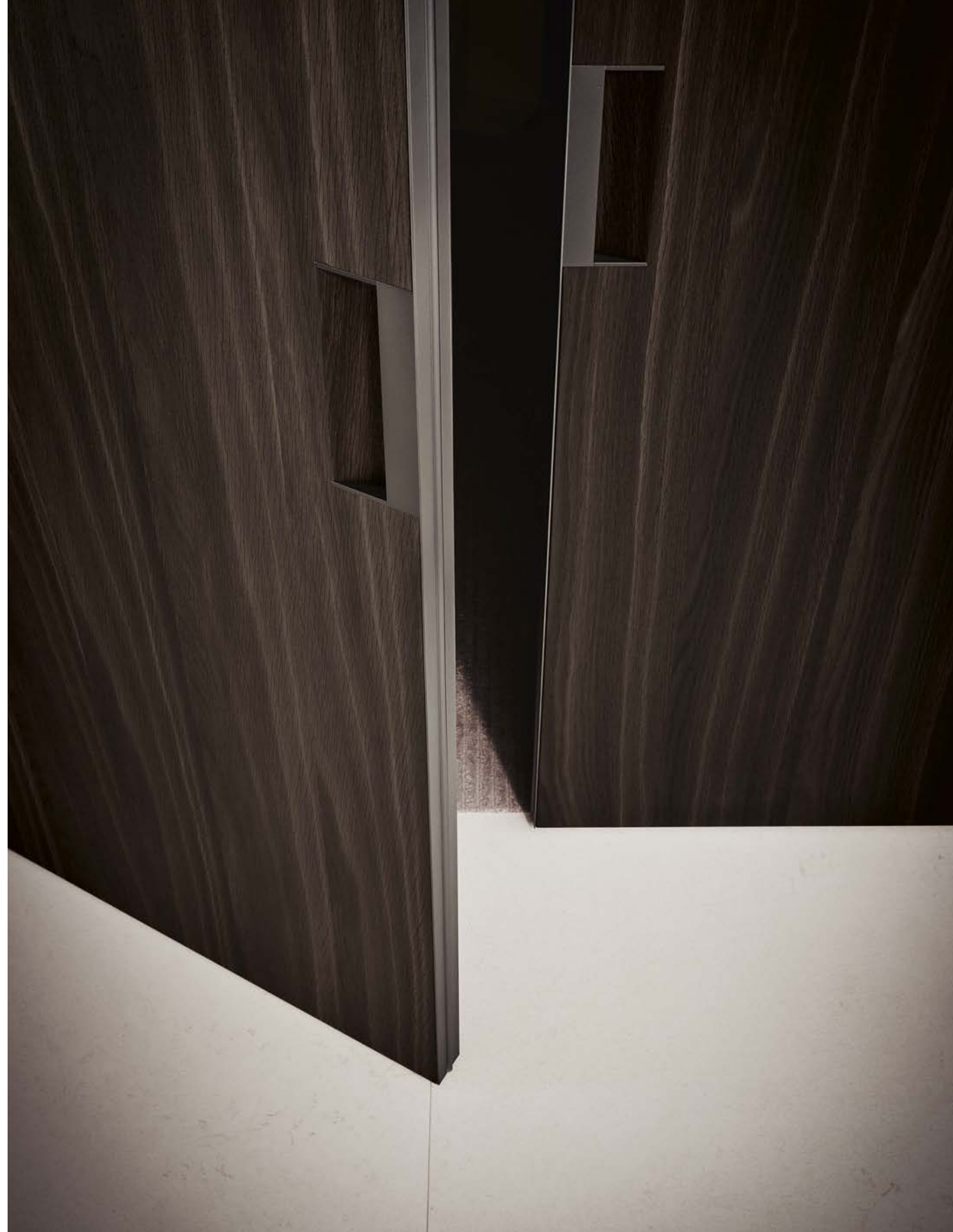



Nel disimpegno, le porte Pivot Plus in rovere spessart si abbinano all'armadio Senzafine Cover in tessuto lino chiaro, con maniglie e profili in champagne opaco.

In the bedroom hallway, the Pivot Plus doors in spessart oak match the Senzafine Cover wardrobe upholstered in lino chiaro fabric, with mat champagne handles and profiles.



PIVOT
WARDROBE AREA

- 1 Porta Pivot Plus, portale rovere spessart e stipite ardesia opaco, porta rovere spessart con maniglia Plus e profili ardesia opaco.
- 2 Armadio Senzafine Plus, apertura battente, ante rovere spessart con maniglia Plus ardesia opaco, sagoma fianco rovere spessart.
- 3 Boiserie Surface tessuto lino chiaro e profili champagne opaco, sagoma di finitura champagne opaco.
- 4 Armadio Senzafine Cover, apertura battente, ante tessuto lino chiaro con maniglia Fitted champagne opaco, sagoma fianco champagne opaco.
- 5 Boiserie Surface rovere spessart e profili ardesia opaco, sagoma di finitura rovere spessart.
- 6 Mensola Code laccato metallico bronzo, luce a led, profili ardesia.

- 1 Pivot Plus door, spessart oak portal and mat ardesia jamb, spessart oak door with Plus handle and profiles mat ardesia.
- 2 Wardrobe Senzafine Plus, leaf opening, spessart oak doors with mat ardesia Plus handle, profile of the side spessart oak.
- 3 Surface wall panelling in fabric lino chiaro and mat champagne profiles, mat champagne finishing profile.
- 4 Wardrobe Senzafine Cover, leaf opening, doors fabric lino chiaro with mat champagne Fitted handle, profile of the side mat champagne.
- 5 Surface wall panelling in spessart oak and mat ardesia profiles, spessart oak finishing profile.
- 6 Code shelf in metal lacquer bronzo, led light, ardesia profiles.

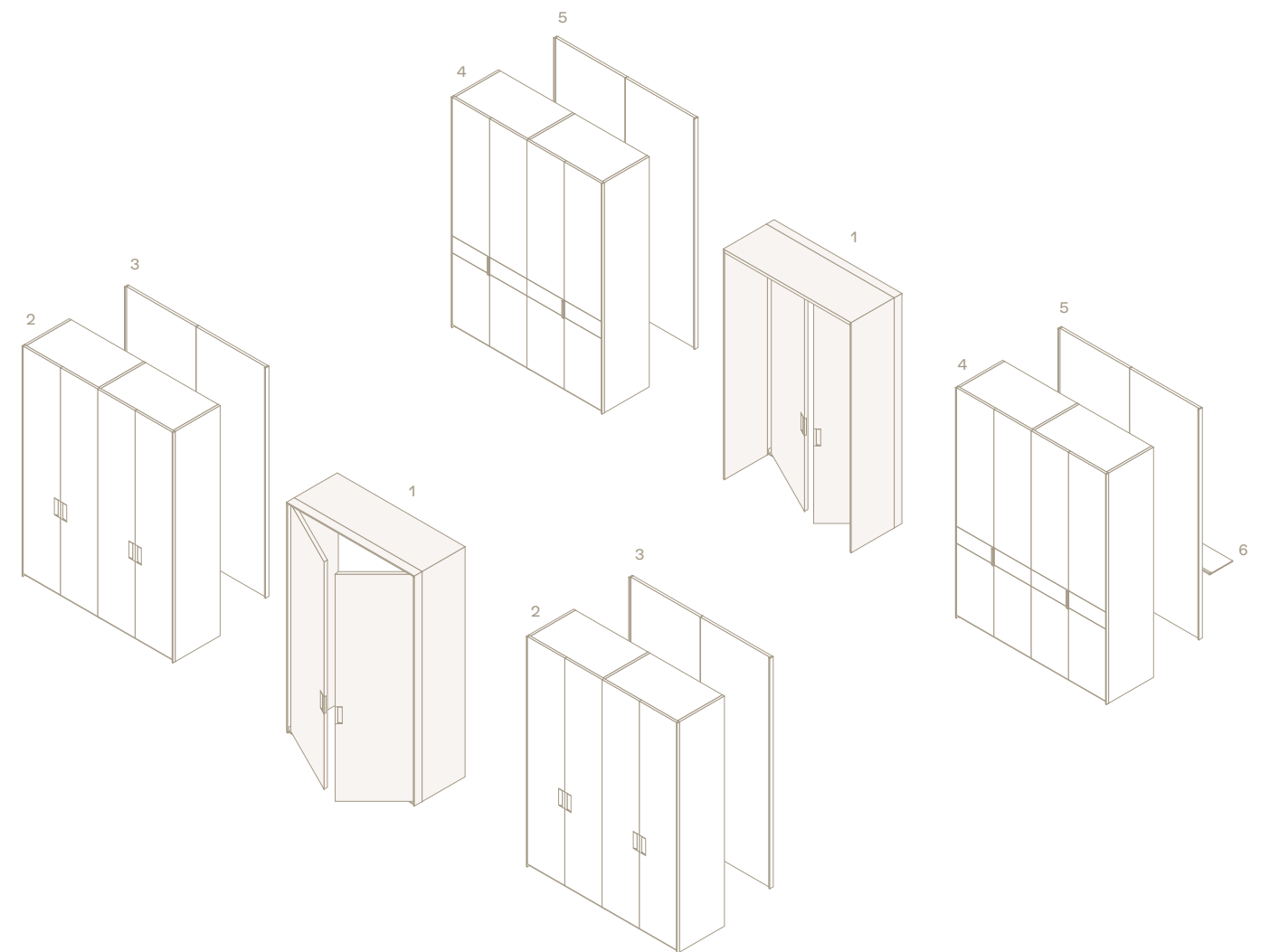
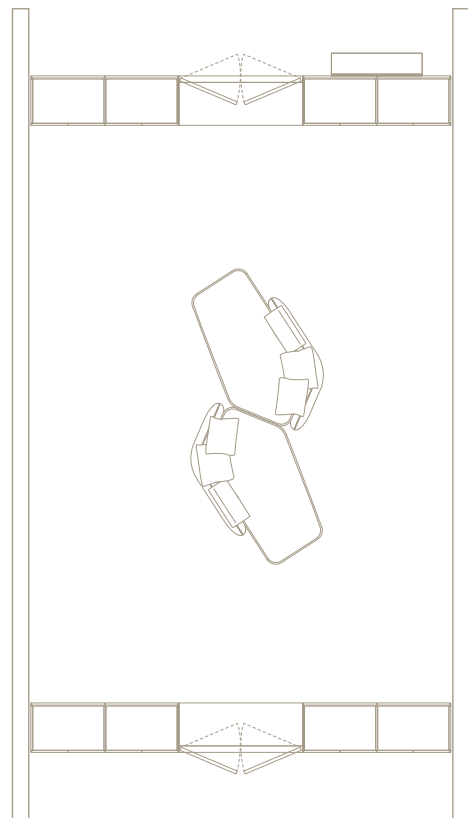





Pivot può anche essere inserita tra armadio e parete. Declinata nelle finiture di ante o boiserie, diventa un'apertura filo muro integrata ed elegante.

Pivot can also be inserted between wardrobe and wall. Matching the doors or the wall panelling finishes, it becomes an integrated and elegant flush-to-wall opening.



PIVOT
NIGHT AREA

- 1 Porta Pivot Plus, portale rovere spessart e stipite ardesia opaco, porta rovere spessart con maniglia Plus e profili ardesia opaco.
- 2 Pivot, telaio a parete ardesia opaco.
- 3 Boiserie Surface rovere spessart e profili ardesia opaco.
- 4 Boiserie Surface rovere spessart e profili ardesia opaco, sagoma di finitura rovere spessart.
- 5 Mensola Code laccato metallico bronzo, luce a led, profili ardesia.
- 6 Armadio Senzafine Cover, apertura battente, ante tessuto lino chiaro con maniglia Fitted champagne opaco, sagoma fianco rovere spessart.
- 7 Boiserie Surface tessuto lino chiaro e profili champagne opaco.

- 1 Pivot Plus door, spessart oak portal and mat ardesia jamb, spessart oak door with Plus handle and profiles mat ardesia.
- 2 Pivot, wall frame in mat ardesia.
- 3 Surface wall panelling in spessart oak and mat ardesia profiles.
- 4 Surface wall panelling in spessart oak and mat ardesia profiles, spessart oak finishing profile.
- 5 Code shelf in metal lacquer bronzo, led light, ardesia profiles.
- 6 Wardrobe Senzafine Cover, leaf opening, doors fabric lino chiaro with mat champagne Fitted handle, profile of the side spessart oak.
- 7 Surface wall panelling in fabric lino chiaro and mat champagne profiles.

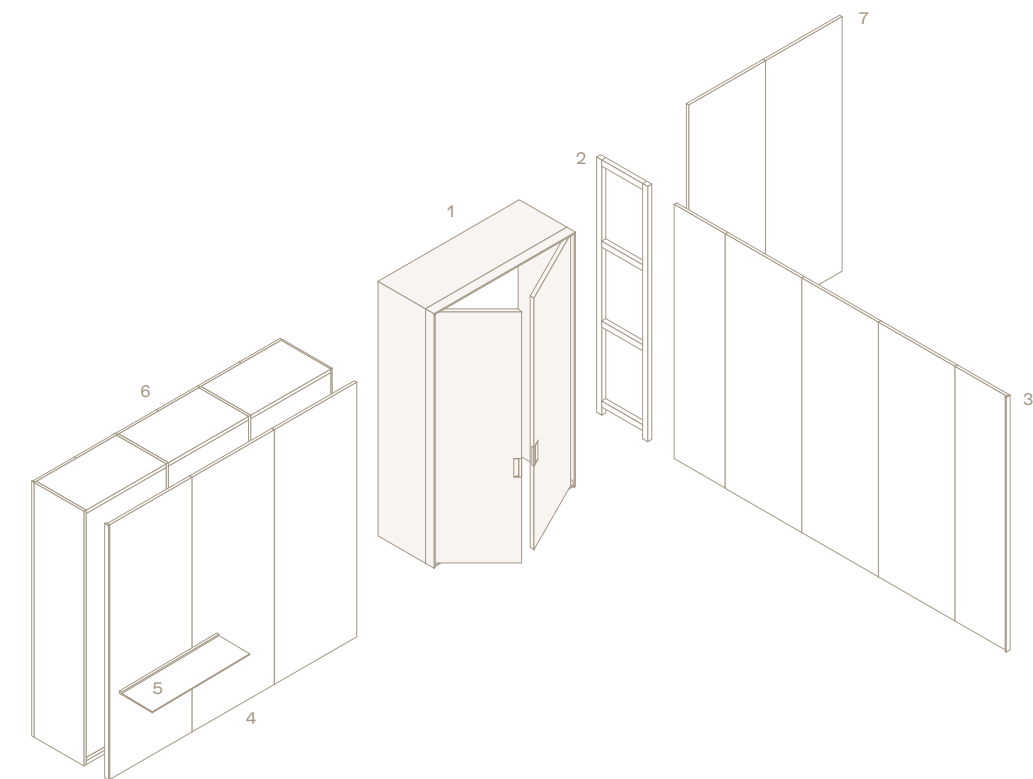
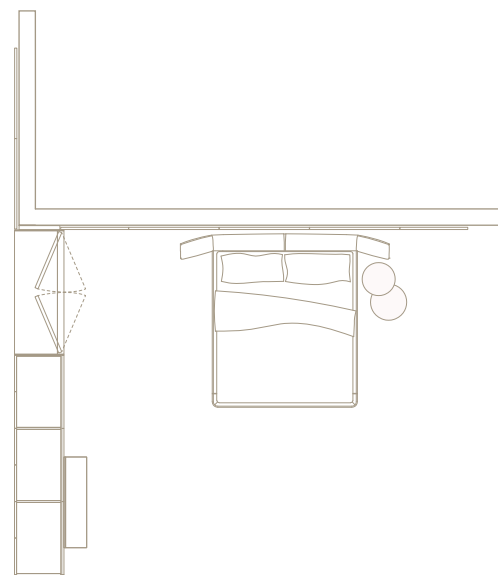

In cucina, Pivot si integra alle colonne della Kitchen Collection. La porta Pivot Plus è in vetro riflettente fumé, mentre la maniglia Plus, il portale e il telaio sono in moka opaco, la stessa finitura usata per i dettagli della cucina.

In the kitchen, Pivot complements the tall units of the Kitchen Collection. The Pivot Plus door is in reflecting fumé glass, while the Plus handle, door, and frame are in mat moka, the same finish used for the kitchen details.









PIVOT
KITCHEN AREA

- 1 Porta Pivot Plus vetro, portale e stipite laccato gofrato moka, porta vetro riflettente fumé con maniglia Plus e telaio moka opaco.
- 2 Cucina Alea Pro, colonne con ante in acciaio PVD bronzo, distanziali e fianchi di finitura in anodizzato moka. Isola centrale e basi con ante, fianchi di finitura e top in Inalco MDi® stone brown, profilo maniglia, sagoma e distanziali in anodizzato moka. Schienale sopra basi attrezzato con Deep Shaker in anodizzato moka e schienali in Inalco MDi® stone brown, mensola superiore in laccato gofrato moka. Piano snack Blade in massello di noce canaletto. Sistema modulare Infinity personalizzato Poliform con modulo aspirante luminoso e moduli luminosi, finitura acciaio scotch brite e vetro fumé.

- 1 Pivot Plus glass door, moka embossed lacquered portal and jamb, door in fumé reflecting glass with Plus handle and frame mat moka.
- 2 Alea Pro kitchen, tall units with doors in PVD steel bronze, moka anodized spacers and finishing sides. Central island and base units with doors, finishing sides and top in Inalco MDi® stone brown, moka anodized handle profile, profile and spacers. Back above base units accessorized with moka anodized Deep Shaker and backs in Inalco MDi® stone brown, upper shelf in moka embossed lacquer. Blade snack top in solid walnut canaletto. Poliform personalized Infinity modular system with lighted extractor module and lighted modules, finish scotch brite steel and fumé glass.

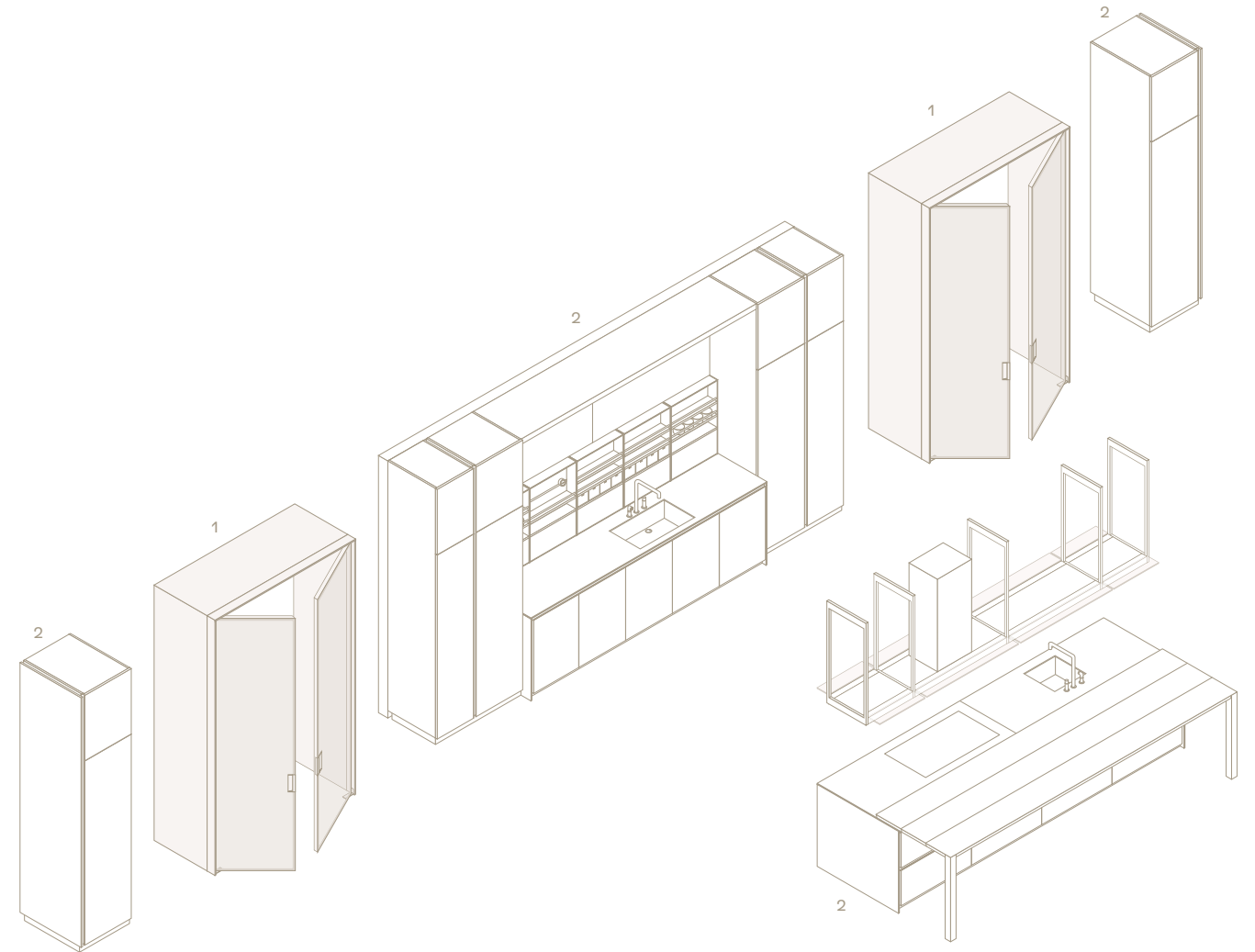
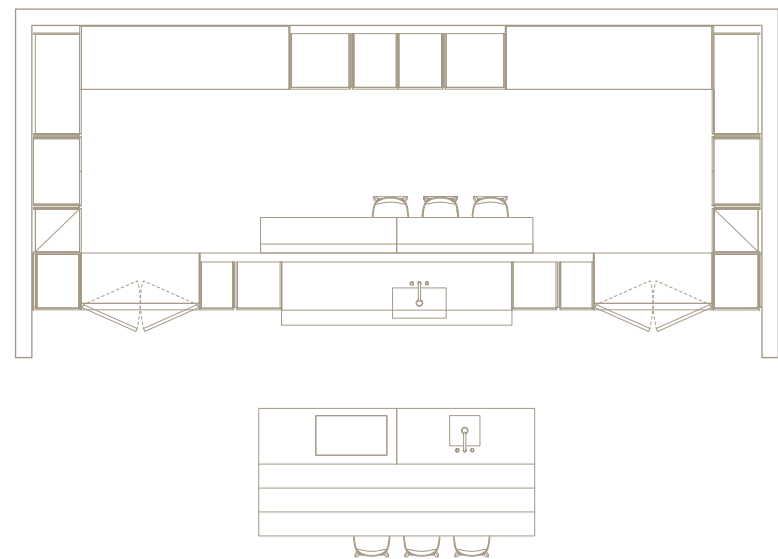



SURFACE BOISERIE SYSTEM

Surface è un sistema di boiserie per il rivestimento di pareti, retro di armadi e interpareti in continuità estetica. Con Surface, con cui si progettano configurazioni angolari e intercape-dini attrezzate, Poliform trasforma un semplice rivestimento in un elemento architettonico capace di esprimere lo spazio al massimo delle sue potenzialità.

Surface is a panelling system for cladding walls, the backs of wardrobes and partitions, providing aesthetic continuity. With Surface, which can be used to design corner configurations and furnished spaces, Poliform transforms a simple wall covering into an architectural element capable of expressing space to its full potential.





Grazie al profilo per angolo aperto, con la boiserie Surface si realizzano anche composizioni angolari. Nell'integrazione con l'armadio Senzafine si crea un angolo home office appartato e discreto. Surface è in tessuto lino chiaro con profili champagne opaco; stesse finiture per l'armadio Senzafine Cover con apertura battente.

Thanks to the open corner profile, Surface panelling can also be used to create corner compositions. Integration with the Senzafine wardrobe creates a secluded and discreet home office corner. Surface is in lino chiaro fabric with mat champagne profiles; the same finishes are used for the Senzafine Cover wardrobe with leaf opening.



SURFACE
DAY AREA 1

- 1 Boiserie Surface tessuto lino chiaro, profili champagne opaco.
- 2 Mensolone sospeso Code olmo nero, canalina ardesia opaco, luce a led.
- 3 Boiserie Surface, soluzione per angolo esterno.
- 4 Presa elettrica, finitura champagne.
- 5 Boiserie Surface, porta ispezionabile.
- 6 Armadio Senzafine Cover, apertura battente, ante tessuto lino chiaro con maniglia Fitted champagne opaco, sagoma fianco tessuto lino chiaro, fianco laterale rovere spessart.
- 7 Boiserie Surface rovere spessart, profili ardesia opaco.
- 8 Coperchio Code, rovere spessart, luce a led, profili ardesia.
- 9 Mensolone sospeso Code, rovere spessart, canalina champagne opaco, luce a led.

- 1 Surface wall panelling fabric lino chiaro, mat champagne profiles.
- 2 Code hanging thick shelf in black elm, mat ardesia channel, led light.
- 3 Surface wall panelling, solution for outer corner.
- 4 Electric socket, finish champagne.
- 5 Surface wall panelling, service opening.
- 6 Wardrobe Senzafine Cover, leaf opening, doors in fabric lino chiaro with mat champagne Fitted handle, side profile in fabric lino chiaro, lateral side in spessart oak.
- 7 Surface wall panelling in spessart oak, mat ardesia profiles.
- 8 Code top shelf, spessart oak, led light, ardesia profiles.
- 9 Code hanging thick shelf, spessart oak, mat champagne channel, led light.

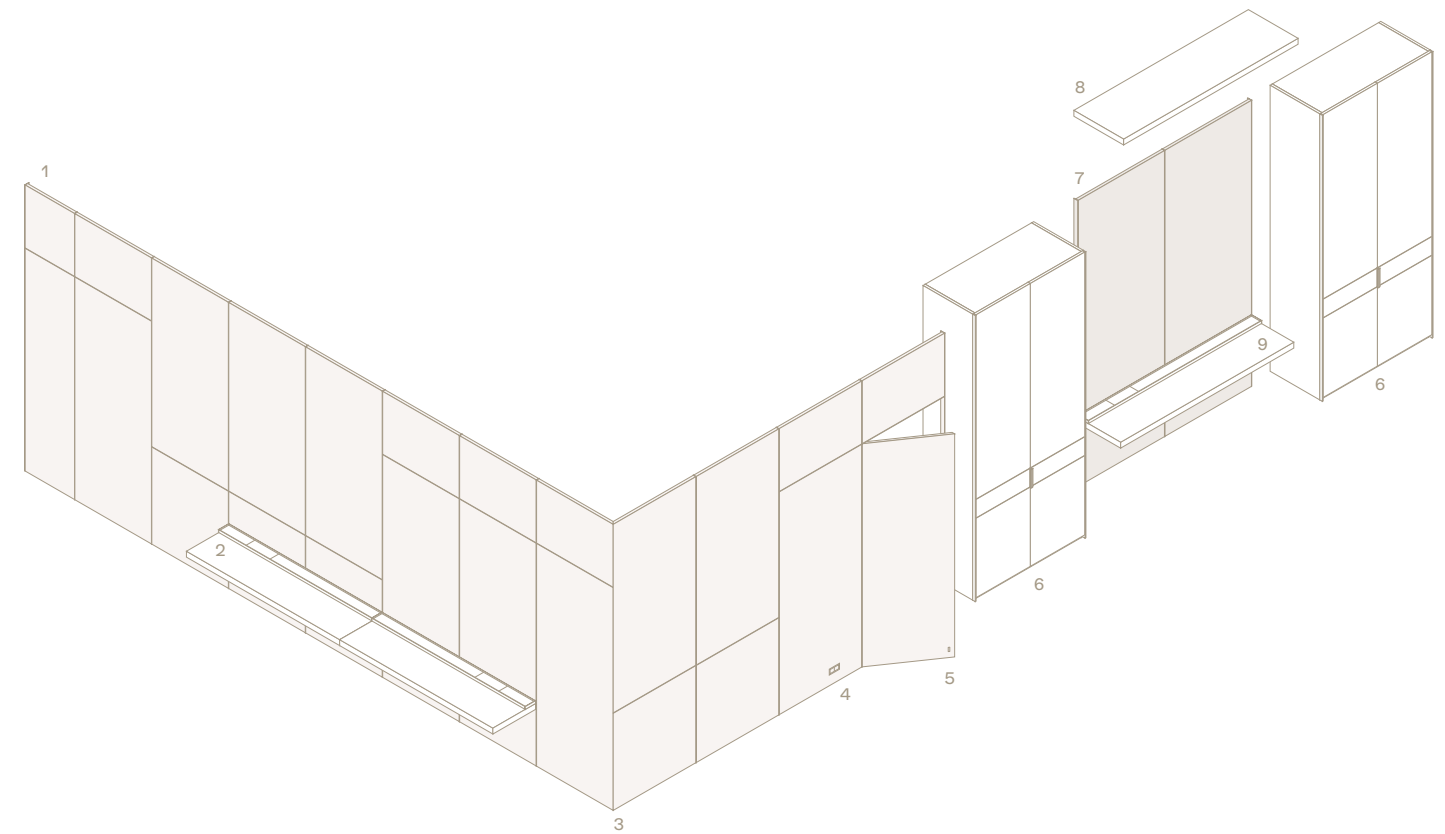
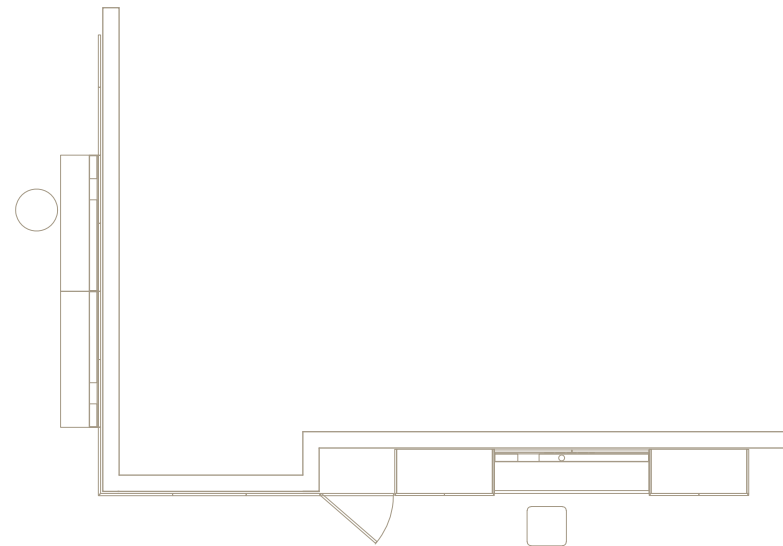



Nella zona giorno, la boiserie Surface, attrezzata con mensolone Code, disegna delle nicchie in cui integrare la libreria Lexington. Tre le finiture della composizione: tessuto lino scuro, Inalco MDi® rigato scuro e olmo nero, sempre con profili in ardesia opaco, come i montanti del sistema Lexington.

In the living area, the Surface panelling, equipped with a Code shelf, creates niches in which the Lexington bookcase can be integrated. There are three finishes for the composition: lino scuro fabric, rigato scuro Inalco MDi® and black elm, again with profiles in mat ardesia, like the uprights of the Lexington system.









SURFACE
DAY AREA 2

- 1 Boiserie Surface tessuto lino scuro, profili ardesia opaco.
- 2 Boiserie Surface in Inalco MDi® rigato scuro, profili ardesia opaco.
- 3 Boiserie Surface olmo nero, profili ardesia opaco.
- 4 Boiserie Surface, soluzione per angolo esterno.
- 5 Specchio Drop, cornice cuoio nero e specchio bronzato.
- 6 Mensolone sospeso Code olmo nero, canalina ardesia opaco, luce a led.
- 7 Libreria Lexington, montanti a soffitto olmo nero e ardesia opaco con piedini di regolazione in nickel ardesia, luce a led. Ripiani e contenitori con anta a ribalta, olmo nero e ardesia opaco.

- 1 Surface wall panelling fabric lino scuro, mat ardesia profiles.
- 2 Surface wall panelling in Inalco MDi® rigato scuro, mat ardesia profiles.
- 3 Surface wall panelling in black elm, mat ardesia profiles.
- 4 Surface wall panelling, solution for outer corner.
- 5 Drop mirror, black hide frame and bronzed mirror.
- 6 Code hanging thick shelf in black elm, mat ardesia channel, led light.
- 7 Lexington bookshelf, floor to ceiling uprights in black elm and mat ardesia with adjustment feet in nickel ardesia, led light. Shelves and storage units with flap door, black elm and mat ardesia.

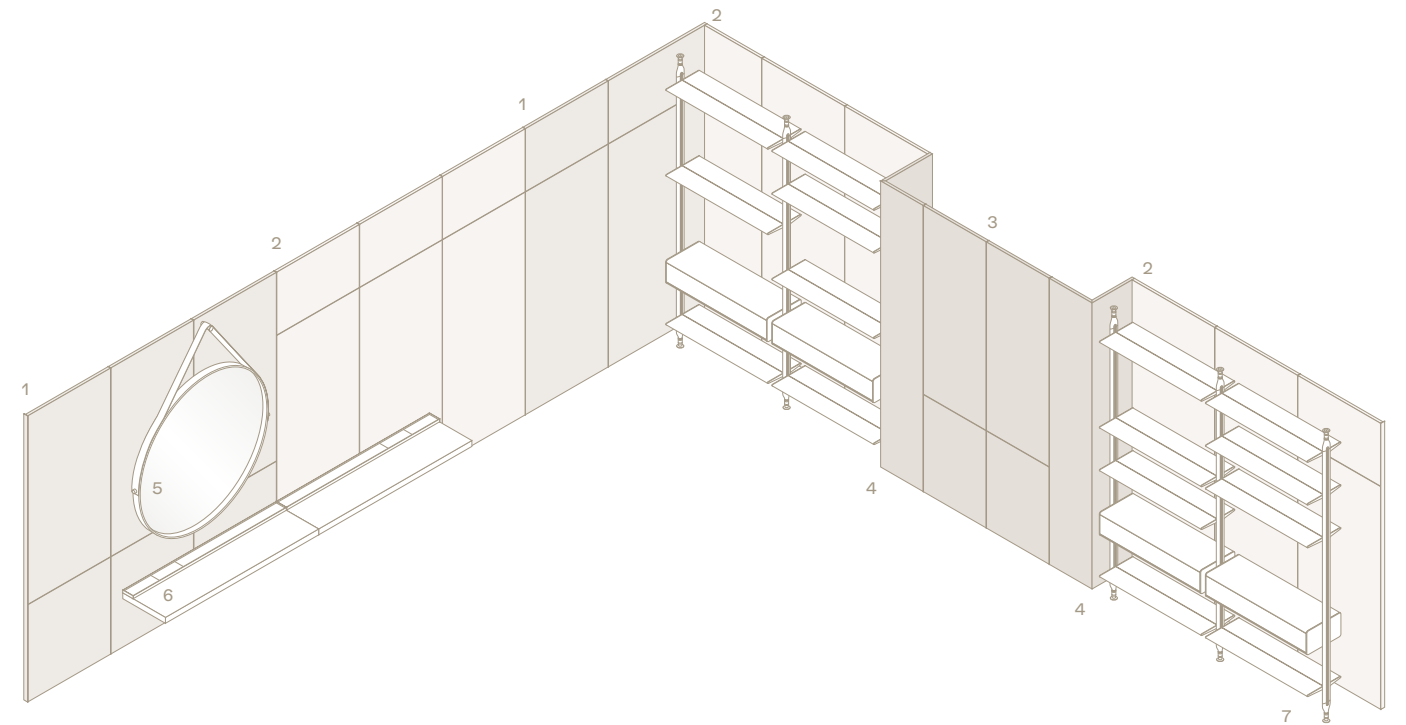
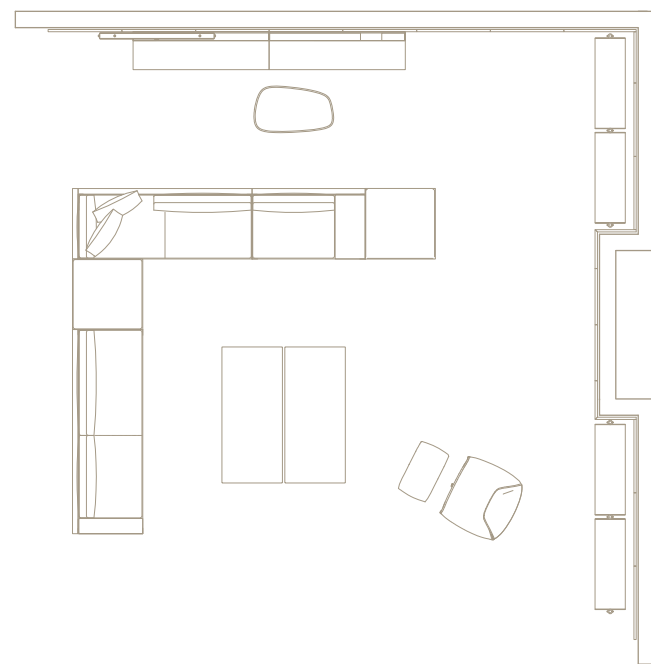

Nell'area guardaroba, la boiserie Surface e la porta Pivot Plus sono usate in combinazione con la cabina armadio Lexington. La boiserie Surface è usata sia a copertura del retro degli armadi, in finitura lino chiaro, sia come schienale del sistema Lexington, in rovere spessart come la porta Pivot. A centro stanza, Surface dà vita all'area specchi e vanity.

In the wardrobe area, the Surface panelling and Pivot Plus door are used in combination with the Lexington walk-in wardrobe. The Surface panelling is used both to cover the back of the wardrobes, in lino chiaro finish, and as a back of the Lexington system, in spessart oak like the Pivot door. In the middle of the room, Surface brings the mirrors and vanity area to life.









**SURFACE
WARDROBE AREA**

- 1 Boiserie Surface tessuto lino chiaro, profili champagne opaco.
- 2 Boiserie Surface rovere spessart, profili ardesia opaco.
- 3 Boiserie Surface rovere spessart print, profili ardesia opaco.
- 4 Boiserie Surface specchio bianco.
- 5 Boiserie Surface, soluzione per angolo esterno.
- 6 Porta Pivot Plus, portale rovere spessart e stipite ardesia opaco, porta rovere spessart con maniglia Plus ardesia opaco.
- 7 Armadi Senzafine.
- 8 Cabina armadio Lexington, montanti a soffitto champagne opaco, luce a led. Ripiani rovere spessart, vetro fumé, tecnocover Grain latte telaio e frontali champagne. Cassettera vetrina laccato opaco champagne con piano superiore vetro fumé, cassetti inferiori vetro riflettente fumé con maniglia Track e bordo champagne opaco. Tubi appendiabiti tecnocover Grain latte e champagne opaco.
- 9 Bacheche Quid laccato opaco bronzo, cassettoni cuoio tortora, schienale vano a giorno specchio bianco.
- 10 Mensolone sospeso Code rovere spessart, canalina ardesia opaco, luce a led, contenitori con vano a giorno laccato opaco bronzo.

- 1 Surface wall panelling in fabric lino chiaro, mat champagne profiles.
- 2 Surface wall panelling in spessart oak, mat ardesia profiles.
- 3 Surface wall panelling in spessart oak print, mat ardesia profiles.
- 4 Surface wall panelling in white mirror.
- 5 Surface wall panelling, solution for outer corner.
- 6 Pivot Plus door, spessart oak portal and mat ardesia jamb, door in spessart oak with mat ardesia Plus handle.
- 7 Senzafine wardrobes.
- 8 Lexington walk-in closet, mat champagne floor to ceiling uprights, led light. Shelves in spessart oak, fumé glass, tecnocover Grain latte with champagne frame and fronts. Display case chest of drawers in mat lacquer champagne with top in fumé glass, lower drawers in fumé reflecting glass with Track handle and mat champagne edge. Hanging rails in tecnocover Grain latte and mat champagne.
- 9 Quid open display cases in mat lacquer bronzo, small drawers in hide tortora, open compartment back in white mirror.
- 10 Code hanging thick shelf in spessart oak, mat ardesia channel, led light, storage units with open compartment in mat lacquer bronzo.

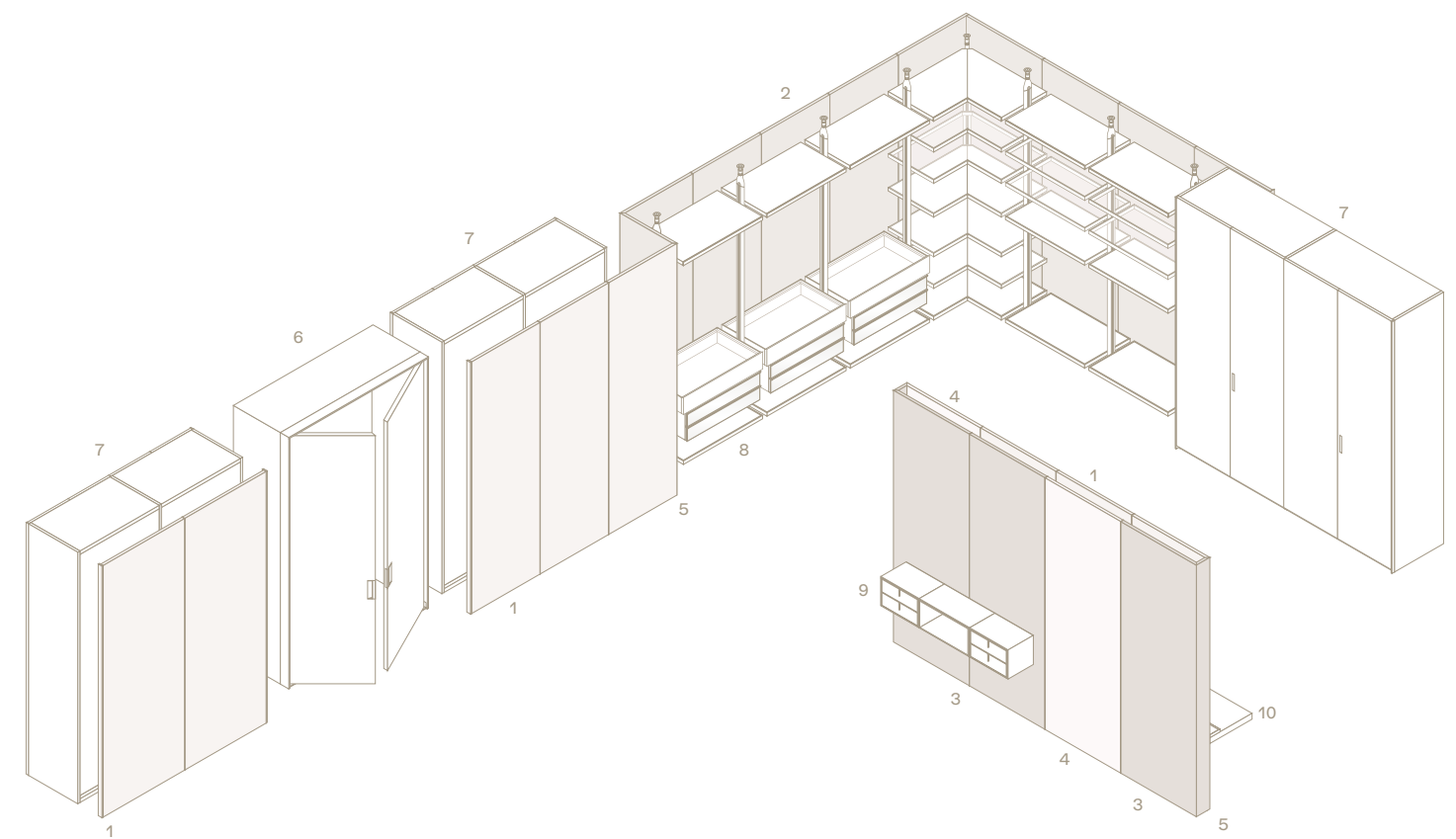
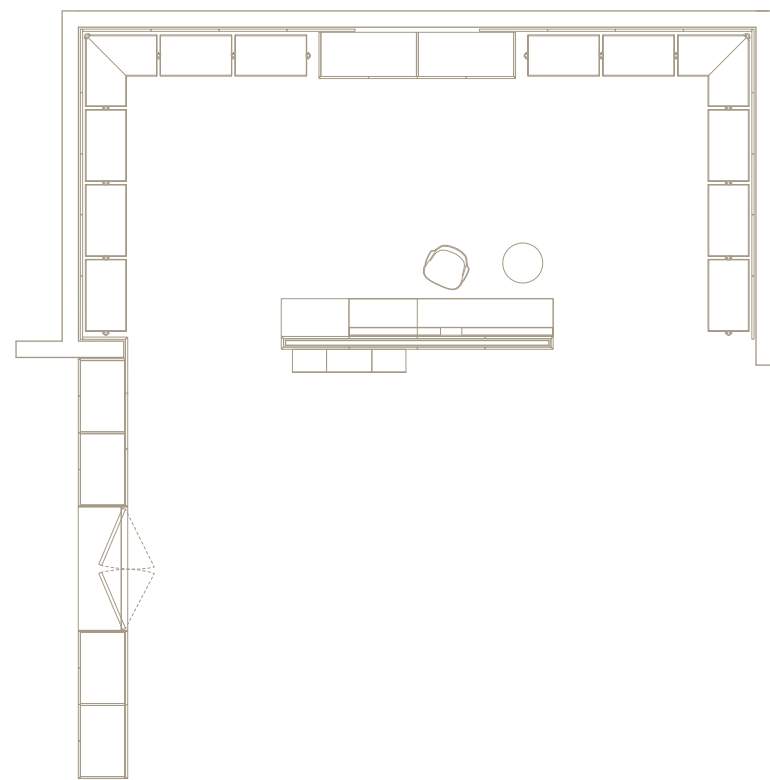



Nella zona notte, la boiserie Surface in rovere spessart print integrata agli armadi Senzafine Cover crea una nicchia con cassettera e mensole e, attrezzata con il mensolone sospeso Code e lo specchio Circle, un angolo vanity.

In the sleeping area, the Surface panelling in spessart oak print integrated with the Senzafine Cover wardrobes creates a niche with drawers and shelves and, equipped with the Code wall-mounted shelf and Circle mirror, a vanity corner.









SURFACE NIGHT AREA

- | | |
|--|--|
| <p>1 Boiserie Surface rovere spessart print, profili champagne opaco.</p> <p>2 Boiserie Surface rovere spessart print, profili ardesia opaco.</p> <p>3 Boiserie Surface tessuto lino chiaro, profili champagne.</p> <p>4 Boiserie Surface rovere spessart, profili ardesia opaco.</p> <p>5 Armadi Senzafine Cover, apertura battente, ante tessuto lino chiaro con maniglia Fitted champagne opaco, fianchi laterali tessuto lino chiaro e rovere spessart.</p> <p>6 Coperchi Code, rovere spessart, luce a led, profili ardesia.</p> <p>7 Mensole Code laccato metallico bronzo, luce a led, profili champagne.</p> <p>8 Contenitori Code laccato metallico bronzo, top in marmo sahara noir levigato, luce a led</p> <p>9 Contenitori Code laccato metallico bronzo, vani a giorno laccato opaco moka.</p> <p>10 Mensolone sospeso Code, rovere spessart, canalina in ardesia opaco, luce a led.</p> <p>11 Specchio Circle, cornice cuoio invecchiato e specchio bianco.</p> <p>12 Armadi Senzafine Cover, apertura battente, ante tessuto lino chiaro con maniglia Fitted champagne opaco, fianchi laterali rovere spessart.</p> <p>13 Contenitori Code laccato metallico bronzo, vani a giorno laccato opaco moka, top in marmo zecevo levigato, luce a led.</p> <p>14 Boiserie Surface, soluzione per angolo esterno.</p> | <p>1 Surface wall panelling in spessart oak print, mat champagne profiles.</p> <p>2 Surface wall panelling in spessart oak print, mat ardesia profiles.</p> <p>3 Surface wall panelling in fabric lino chiaro, mat champagne profiles.</p> <p>4 Surface wall panelling in spessart oak, mat ardesia profiles.</p> <p>5 Wardrobes Senzafine Cover, leaf opening, doors in fabric lino chiaro with mat champagne Fitted handle, lateral sides in fabric lino chiaro and spessart oak.</p> <p>6 Code top shelves, spessart oak, led light, ardesia profiles.</p> <p>7 Code shelves, metal lacquer bronzo, led light, champagne profiles.</p> <p>8 Code storage units in metal lacquer bronzo, top in mat marble sahara noir, led light.</p> <p>9 Code storage units in metal lacquer bronzo, open compartments in mat lacquer moka.</p> <p>10 Code hanging thick shelf, spessart oak, mat ardesia channel, led light.</p> <p>11 Circle mirror, frame in hide invecchiato and white mirror.</p> <p>12 Wardrobes Senzafine Cover, leaf opening, doors in fabric lino chiaro with mat champagne Fitted handle, lateral sides in spessart oak.</p> <p>13 Code storage units in metal lacquer bronzo, open compartments in mat lacquer moka, top in mat marble zecevo, led light.</p> <p>14 Surface wall panelling, solution for outer corner.</p> |
|--|--|

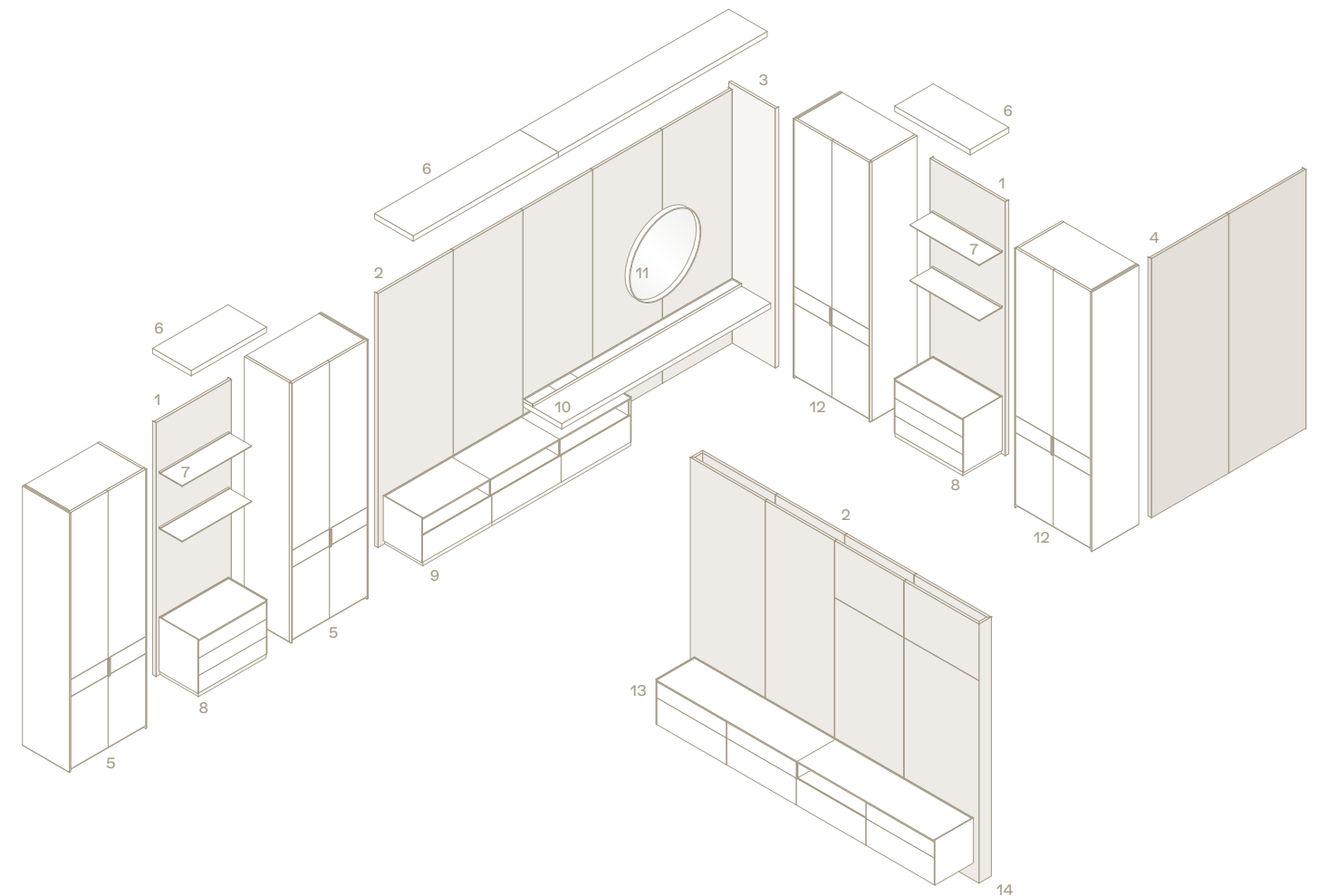
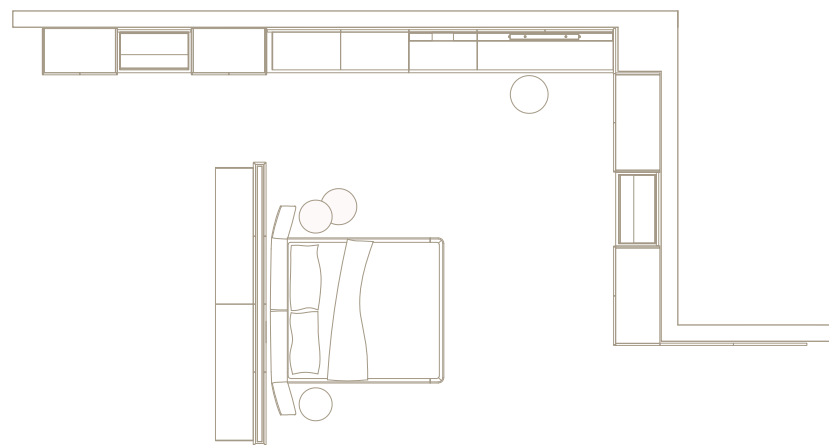

TECHNICAL DATA

PIVOT DOOR SYSTEM

104

SURFACE BOISERIE SYSTEM

124

ARCHITECTURAL

103

PIVOT DOOR SYSTEM

Design Studio Kairos

Pivot è un sistema di porte singole o doppie, apertura a bilico, composte da un portale che si integra con gli armadi del sistema Senzafine e i pannelli boiserie Surface sul retro armadio o con le colonne della collezione cucine. La porta a bilico è una porta che si apre e chiude ruotando attorno ad un asse verticale costituito da due perni. Al portale viene fissato nella parte anteriore o posteriore il telaio per l'aggancio della porta. Le porte Pivot riprendono finiture e maniglie della collezione armadi Senzafine o della collezione Kitchen Collection, per assicurare, in accostamento, una perfetta continuità visiva.

- 1 Portale, costituito da un coperchio con stipite e due fianchi con stipite
- 2 Stipite metallico comprensivo di cerniere a bilico
- 3 Porta singola
- 4 Porta doppia

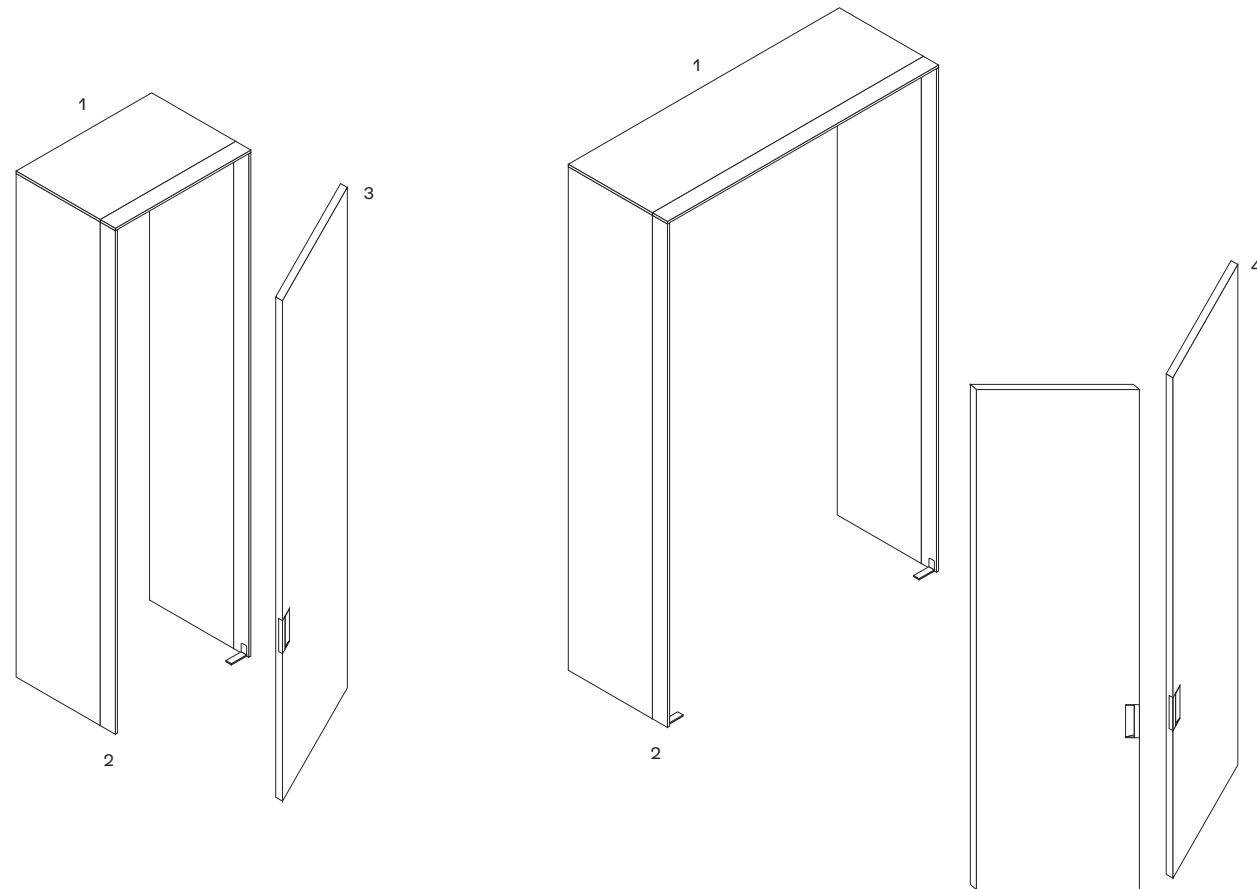

Pivot is a system of single or double doors, pivot opening, composed by a portal integrated with the wardrobes of the Senzafine system and the Surface panels to the back of the wardrobe or with the tall units of the kitchen collection. The pivot door is a door which opens and closes by rotating around a vertical axis consisting of two pins. A frame for the door fixing is applied to the front or rear part of the portal. Pivot doors follow finishes and handles of the wardrobe collection Senzafine or of the Kitchen Collection, to grant perfect visual continuity when combined together.

- 1 Portal, composed by a header with jamb and two side panels with jamb
- 2 Metal jamb comprehensive of pivot hinges
- 3 Single door
- 4 Double door

Pivot tra due armadi Pivot between two wardrobes

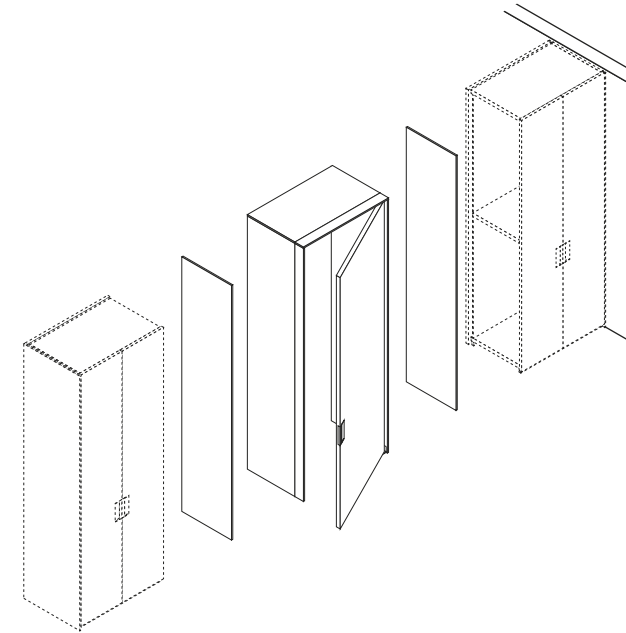

Per l'accostamento del portale all'armadio è necessario utilizzare un fianco interno spessore 15, predisposto per fissare lo stipite, al posto del fianco laterale di serie.

To combine portal and wardrobe it is necessary to use a 1/2" thick internal side, arranged to fix the jamb, instead of the standard lateral side.

Pivot tra armadio e parete Pivot between wardrobe and wall

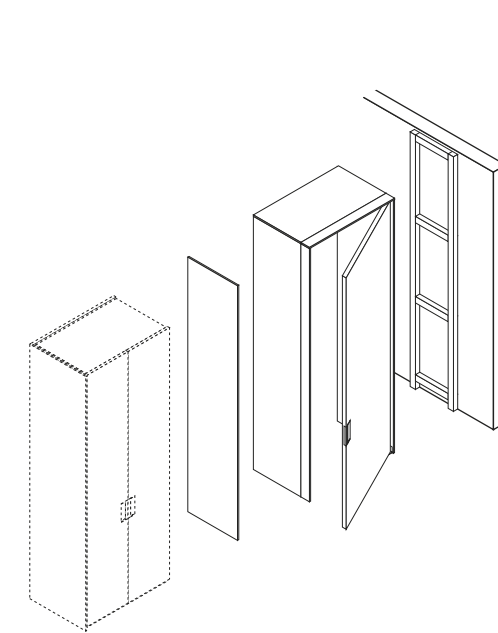

Per l'accostamento del portale alla parete è necessario utilizzare un telaio a parete predisposto per fissare lo stipite. Telaio con regolazione telescopica, spessore da 35 a 55.

To combine portal and wall it is necessary to use a wall frame arranged to fix the jamb. Frame with telescopic adjustment, thickness from 1 1/2" to 2 1/4".

Pivot tra due colonne cucina Pivot between two kitchen tall units

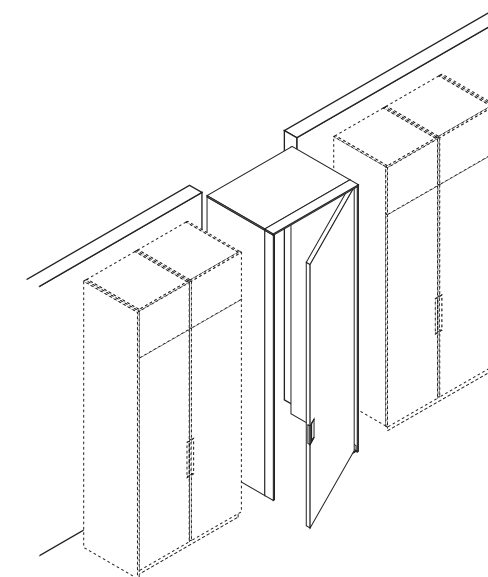

La struttura delle colonne della cucina viene predisposta per il fissaggio del portale.

The structure of the tall units is arranged to fix the portal.

Pivot tra colonna cucina e parete Pivot between kitchen tall unit and wall

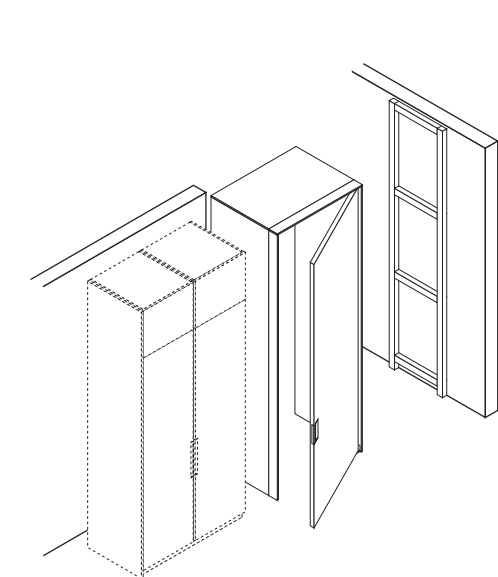

Per l'accostamento del portale alla parete è necessario utilizzare un telaio a parete predisposto per fissare lo stipite. Telaio con regolazione telescopica, spessore da 35 a 55.

To combine portal and wall it is necessary to use a wall frame arranged to fix the jamb. Frame with telescopic adjustment, thickness from 1 1/2" to 2 1/4".

PIVOT CON ARMADIO
PIVOT WITH WARDROBE

Retro armadio
Back of the wardrobe

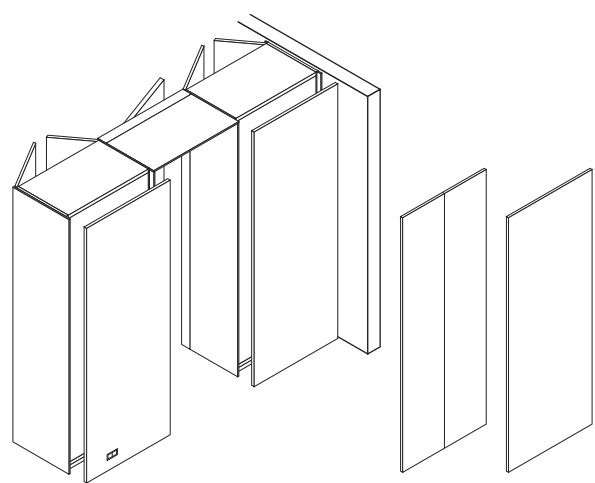

Per gli armadi centro stanza, la boiserie Surface retro armadio può essere sostituita dalle ante fisse o dai pannelli PL a terra spessore 25.

For freestanding wardrobes Surface wall panelling at the back of the wardrobe can be replaced by fixed doors or PL floorstanding panels thickness 1".

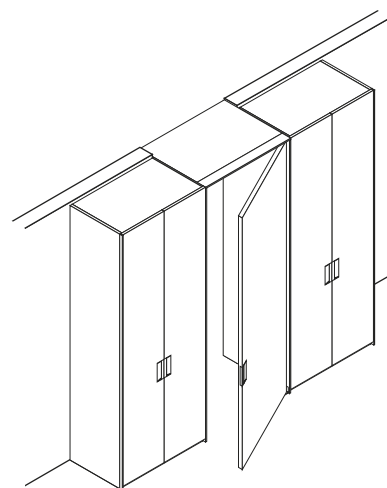

Solo con gli armadi a parete, e il passaggio con la porta Pivot, lo schienale è standard.
Only with wall wardrobes and passage with Pivot door the back panel is standard.

Retro armadio con boiserie
Back of the wardrobe with wall panelling

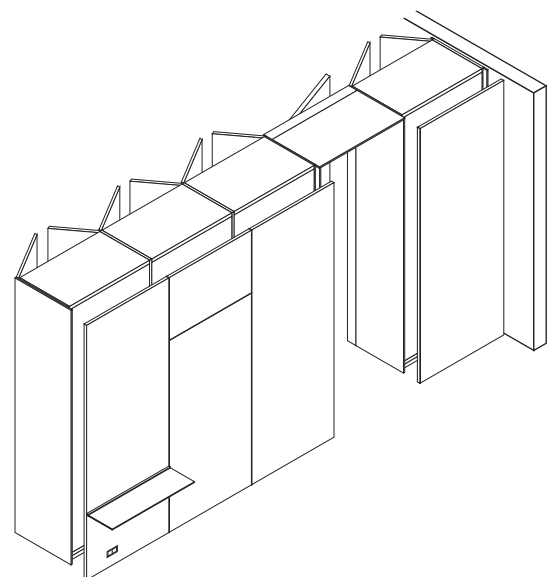

La boiserie retro armadio, ad altezza unica o sovrapposta, può essere attrezzata (escluso specchio) con una sola mensola Code per pannello, con e senza luce a led (p 280-300, spessore 8), con il modulo di cablaggio per una presa elettrica o due prese usb o con gli specchi Drop, Circle e Audrey.

The wall panelling in one piece or superimposed can be accessorized (except mirror) with one Code shelf for panel, with or without led light (d 11"-11 3/4", thickness 1/4"), with the wiring module for one electric socket or for two usb sockets or with Drop, Circle and Audrey mirrors.

Tipologie aperture
Opening typologies

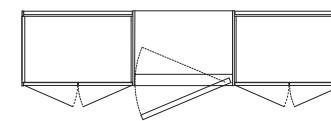

porta singola, allineamento ante armadio - apertura dx
single door, wardrobe doors alignment - right opening

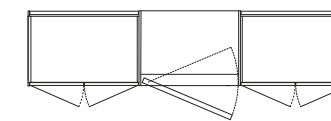

porta singola, allineamento ante armadio - apertura sx
single door, wardrobe doors alignment - left opening

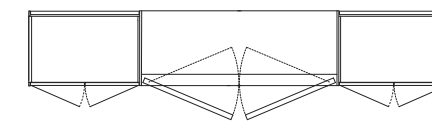

porta doppia, allineamento ante armadio
double door, wardrobe doors alignment

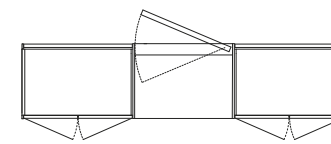

porta singola, allineamento retro armadio - apertura sx
single door, wardrobe back alignment - left opening

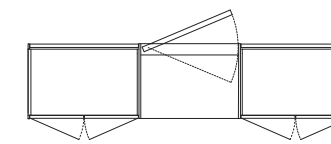

porta singola, allineamento retro armadio - apertura dx
single door, wardrobe back alignment - right opening

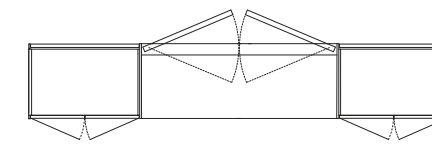

porta doppia, allineamento retro armadio
double door, wardrobe back alignment

Per determinare la tipologia di apertura della porta Pivot singola si deve sempre guardare il disegno dal lato esterno della porta.

To establish the opening type of the Pivot single door always consider the external side of the door.

Tipologie compositive con armadi
Composition typologies with wardrobes

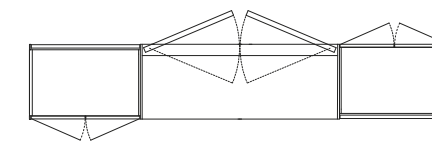
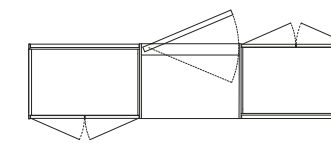
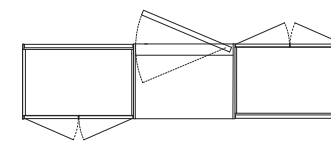

La porta Pivot si può allineare alle ante dell'armadio, al retro armadio o a entrambe.

Pivot door can be aligned with the wardrobe doors, with the back of the wardrobe or with both.

PIVOT CON ARMADIO PIVOT WITH WARDROBE

Il portale Pivot è realizzabile con almeno un lato armadio. L'armadio sul quale viene fissato il portale deve avere apertura battente, la larghezza minima di 941 e la profondità di 584. L'armadio deve necessariamente essere finito sul retro, armadio centro stanza con boiserie, pannelli PL o ante fisse, armadio a parete con schienale standard.

- 1 Fianco laterale spessore 15+15.
- 2 Fianco interno per armadio spessore 15 e fianco esterno portale spessore 14.
- 3 Fianco laterale spessore 25, con sagome di finitura lato ante e lato boiserie retro armadio.
- 4 Fianco laterale spessore 25, con sagome di finitura lato ante.
- 5 Profili telescopici di compensazione Pivot in ardesia o champagne.

Pivot portal can be realized with at least one wardrobe element. The wardrobe must have leaf opening in order to fix the portal, minimum width of the unit 37" and depth 23". The wardrobe must be finished at the back: freestanding wardrobe with wall panelling, PL panels or fixed doors, wall wardrobe with standard back panel.

- 1 Lateral side thickness 1/2"+1/2".
- 2 Inner side for wardrobe thickness 1/2" and external side of the portal thickness 1/2".
- 3 Lateral side thickness 1", with finishing profile on the door side and wall panelling on the back side.
- 4 Lateral side thickness 1", with finishing profiles on the door side.
- 5 Telescopic adjustment profiles Pivot in ardesia or champagne.

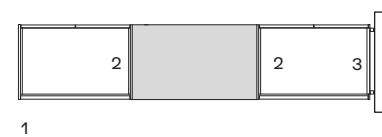

Pivot profondità standard.
La porta Pivot si può allineare alle ante dell'armadio o al retro armadio.
Pivot standard depth.
Pivot door can be aligned with the wardrobe doors or with the back of the wardrobe.

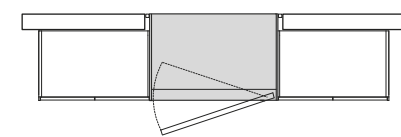
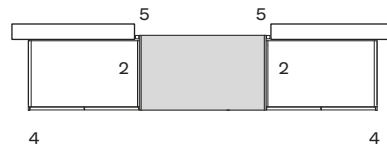

* Pivot profondità a misura.
La porta Pivot non può essere montata a filo muro, perchè lo stipite verticale viene fissato al fianco interno dell'armadio.
Pivot customized depth.
Pivot door can not be installed flush to the wall because the vertical jamb must be fixed to the wardrobe inner side.

Pivot tra due armadi centro stanza Pivot between two freestanding wardrobes

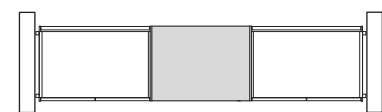

armadi tra due pareti
wardrobe between two walls

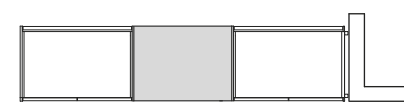

armadio a filo parete ad angolo
wardrobe flush to the corner wall

Per armadio a parete sono previsti profili telescopici di compensazione in ardesia o champagne e fasce d'aggiustaggio fisse.
For wall wardrobe compensation telescopic profiles in ardesia or champagne and fixed fillers are foreseen.

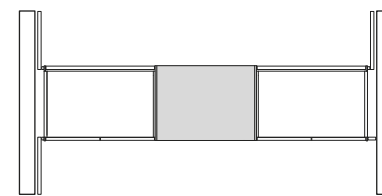

armadi tra due pareti con boiserie
wardrobes between two walls with panelling

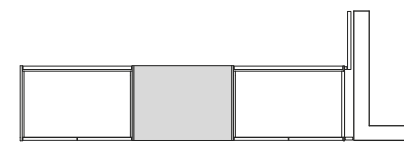

armadio a filo parete ad angolo con boiserie
wardrobe flush to the corner wall with panelling

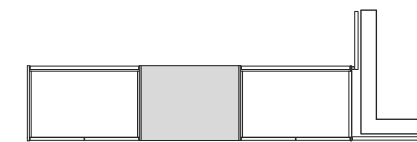

armadio a filo parete ad angolo con boiserie
wardrobe flush to the corner wall with panelling

Pivot tra due armadi a parete Pivot between two wall wardrobes

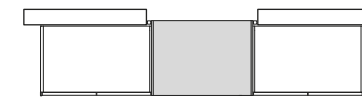

Pivot profondità standard
Pivot with standard depth

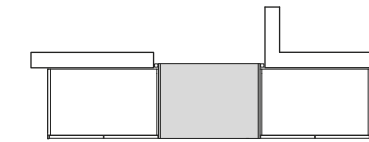

Pivot profondità standard
Pivot with standard depth

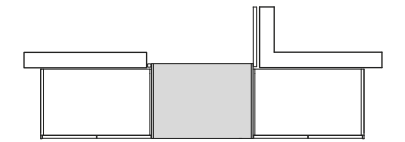

Pivot profondità standard, parete con boiserie
Pivot with standard depth, wall with panelling

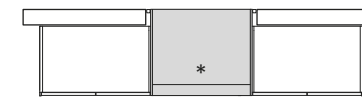

Pivot profondità a misura
Pivot with customized depth

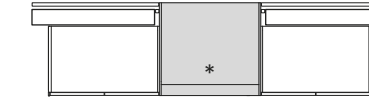

Pivot profondità a misura, parete con boiserie
Pivot with customized depth, wall with panelling

Pivot tra armadio e parete Pivot between wardrobe and wall

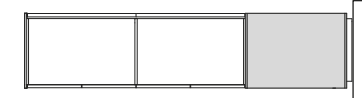

armadio centro stanza e Pivot a parete
freestanding wardrobe and wall mounted Pivot

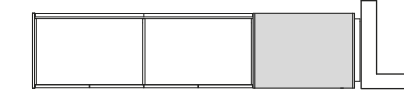

armadio centro stanza e Pivot a filo parete ad angolo
freestanding wardrobe and Pivot flush to the corner wall

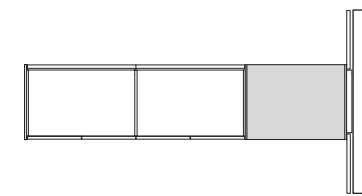

armadio centro stanza e Pivot a parete con boiserie
freestanding wardrobe and wall mounted Pivot with panelling

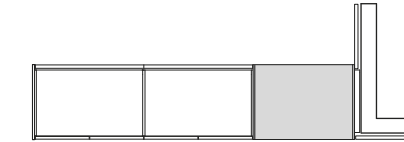

armadio centro stanza e Pivot a filo parete ad angolo con boiserie
freestanding wardrobe and Pivot flush to the corner wall with panelling



armadio a parete, Pivot profondità standard a filo parete ad angolo
wall wardrobe, Pivot in standard depth flush to the corner wall



armadio a parete, Pivot profondità a misura a filo parete ad angolo
wall wardrobe, Pivot in customized depth flush to the corner wall



armadio a parete, Pivot profondità standard a filo parete ad angolo con boiserie
wall wardrobe, Pivot in standard depth flush to the corner wall with panelling

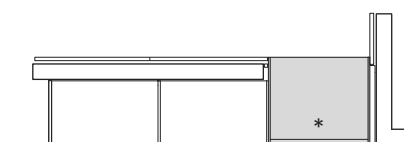

armadio a parete, Pivot profondità a misura a filo parete ad angolo con boiserie
wall wardrobe, Pivot in customized depth flush to the corner wall with panelling

PIVOT CON ARMADIO PIVOT WITH WARDROBE

Dimensioni

Portale Pivot realizzabile al millimetro, da fissare tra due armadi p 584 o tra un armadio p 584 e una parete, in questo caso è necessario il telaio a parete.

Portale disponibile in quattro altezze, riducibile a misura (portale ed armadio).

La larghezza viene gestita al mm.

La profondità è di 664 in accostamento ad armadi centro stanza (armadi p 584 con retro armadio), o viene gestita al mm in accostamento con armadi a parete.

Portale Pivot spessore mm 14, porta Pivot spessore mm 45.

Dimensions

Pivot portal can be customized to the millimeter, to be fixed between two wardrobes d 23" or between a wardrobe d 23" and a wall, in this case the wall frame is necessary.

Portal available in four heights, customizable (portal and wardrobe).

The width is managed to the mm.

The depth is 26 1/4" when combined with freestanding wardrobes (wardrobes d 23" with rear panelling), or managed to the mm when combined with wall wardrobes.

Pivot portal thickness 1/2", Pivot door thickness 1 3/4".

Altezza e larghezza Height and width

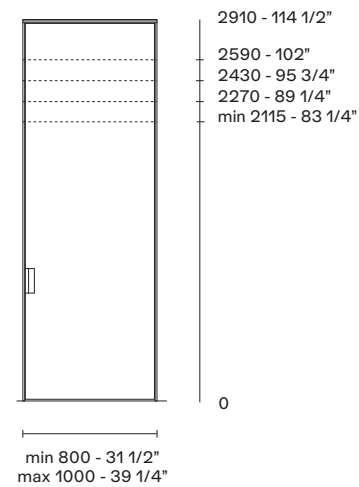

porta singola - single door
per calcolare luce di passaggio togliere mm 140
for actual passage opening deduct 5 1/2"

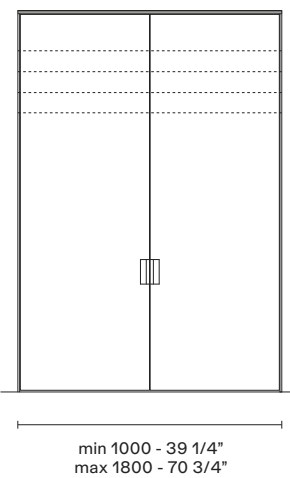

porta doppia - double door
per calcolare luce di passaggio togliere mm 253
for actual passage opening deduct 10"

Altezza minima portale 2115, per luce di passaggio h 2100, larghezza minima riducibile 750, per luce di passaggio l 610.
Portal minimum height 83 1/4", actual passage opening h 82 3/4", minimum customized width 29 1/2", actual passage opening w 24".

Profondità Depth

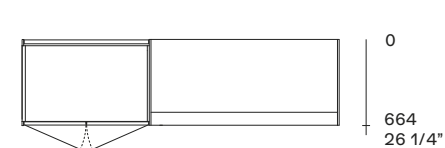

Pivot profondità standard, armadi Senzafine p 584 centro stanza con retro armadio.
Pivot with standard depth, Senzafine freestanding wardrobes d 23" with rear panelling.

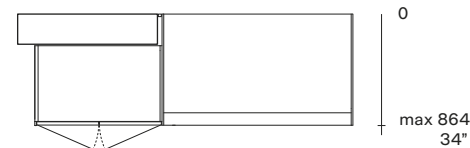

Pivot profondità a misura, per variabile spessore muro, armadi Senzafine p 584 a parete.
Pivot customized depth, for variable wall thickness, Senzafine wall wardrobes d 23".

Modelli

Quattro le possibili soluzioni estetiche, dalla più essenziale, in essenza o laccato a quella in vetro, fino alle più esclusive in tessuto e tecnocover Grain, coordinate alle ante del sistema armadi Senzafine.

- 1 Porta Pivot Plus
- 2 Porta Pivot Plus vetro
- 3 Porta Pivot Cover
- 4 Porta Pivot Match

Models

Four possible aesthetic solutions, from the most essential, in wood or lacquer, to the one in glass, up to the most exclusive in fabric and tecnocover Grain, coordinated with the doors of the wardrobe system Senzafine.

- 1 Pivot Plus door
- 2 Pivot Plus glass door
- 3 Pivot Cover door
- 4 Pivot Match door

1



2



3



4



PORTALE PIVOT CON ARMADIO
PORTAL PIVOT WITH WARDROBE

Laccato opaco
Mat lacquer



82 glacier white



01 bianco



35 canapa



26 corda



88 castoro



46 tortora



64 arena



89 roccia



48 visone



49 moka



04 grafite



91 carbone



60 ghiaccio



09 pioggia



78 ferro



83 ocra



85 caramello



67 muschio



92 vischio

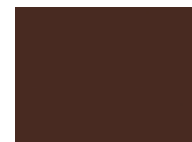

87 granata



86 danubio



70 prussia

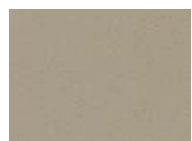

77 champagne



24 ottone

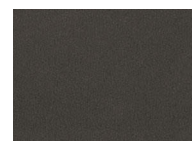

23 bronzo



90 piombo



02 ardesia

Laccato metallico
Metallic lacquer



23 bronzo



24 ottone



25 titanio

Essenza
Wood



rovere gold
gold oak



rovere spessart
spessart oak



noce c
walnut c



olmo nero
black elm

Laccato opaco in tinta a tecnocover Grain
Mat lacquer matching tecnocover Grain



94 latte



97 elefante



93 moro



98 nocciola

Stipite con perni e telaio telescopico
Jamb with pins and telescopic frame



champagne opaco
mat champagne



ardesia opaco
mat ardesia

PIVOT PLUS CON ARMADIO
PIVOT PLUS WITH WARDROBE



Porta - Door



rovere gold
gold oak



rovere spessart
spessart oak



noce c
walnut c



olmo nero
black elm



laccato opaco colori
mat lacquered colours



laccato metallico colori
metallic lacquered
colours



lino chiaro
tessuto - fabric



lino écreu
tessuto - fabric



lino bruciato
tessuto - fabric

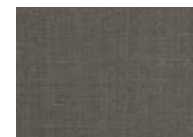

lino scuro
tessuto - fabric

Profili - Profiles



05 latte
tecnocover Grain

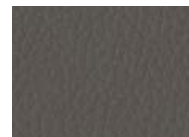

01 elefante
tecnocover Grain

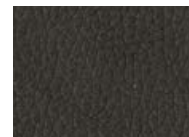

02 moro
tecnocover Grain



06 nocciola
tecnocover Grain

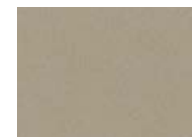

champagne opaco
mat champagne



ardesia opaco
mat ardesia



Plus. Maniglia ardesia o champagne opaco per porta in essenza o laccato - Handle in mat ardesia or champagne for door in wood or lacquer.



Plus. Maniglia ardesia o champagne opaco per porta in tessuto o tecnocover Grain - Handle in mat ardesia or champagne for door in fabric or tecnocover Grain.

PIVOT PLUS VETRO CON ARMADIO
PIVOT PLUS GLASS WITH WARDROBE



Porta vetro - Glass door

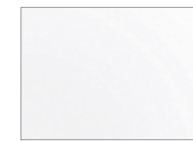

2000 trasparente
extrachiaro-transparent
extralight



3050 fumé



5000 trasparente
riflettente-transparent
reflecting



5051 riflettente bronzato
reflecting bronzed



5059 riflettente fumé
reflecting fumé

Telaio - Frame

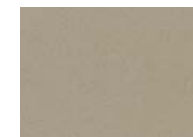

champagne opaco
mat champagne

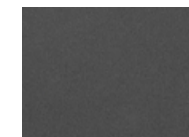

ardesia opaco
mat ardesia



Plus. Maniglia ardesia o champagne opaco - Handle in mat ardesia or champagne.

PIVOT COVER CON ARMADIO
PIVOT COVER WITH WARDROBE



Porta - Door



lino chiaro
tessuto - fabric



lino écreu
tessuto - fabric



lino bruciato
tessuto - fabric



lino scuro
tessuto - fabric



05 latte
tecnocover Grain

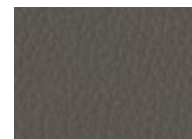

01 elefante
tecnocover Grain

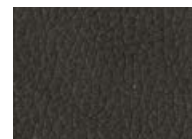

02 moro
tecnocover Grain



06 nocciola
tecnocover Grain

Profili - Profiles

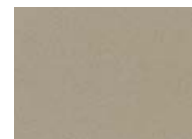

champagne opaco
mat champagne

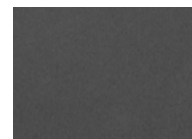

ardesia opaco
mat ardesia



Cover. Maniglia ardesia o champagne opaco per porta in tessuto - Handle in mat ardesia or champagne for door in fabric.



Cover. Maniglia ardesia o champagne opaco e tecnocover Grain 4 colori per porta in tecnocover - Handle in mat ardesia or champagne and tecnocover Grain 4 colours for door in tecnocover.

PIVOT MATCH CON ARMADIO
PIVOT MATCH WITH WARDROBE



Porta - Door



rovere gold
gold oak



rovere spessart
spessart oak



noce c
walnut c



olmo nero
black elm

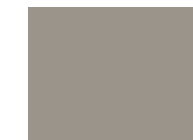

laccato opaco colori
mat lacquered colours



laccato metallico colori
metallic lacquered
colours



lino chiaro
tessuto - fabric



lino écreu
tessuto - fabric

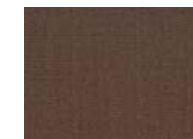

lino bruciato
tessuto - fabric



lino scuro
tessuto - fabric

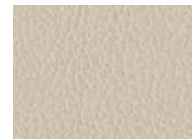

05 latte
tecnocover Grain



01 elefante
tecnocover Grain

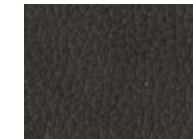

02 moro
tecnocover Grain



06 nocciola
tecnocover Grain

Profili - Profiles



champagne opaco
mat champagne

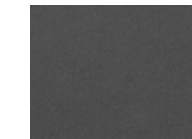

ardesia opaco
mat ardesia



Match. Maniglia essenza e ardesia o champagne opaco per porta in essenza - Handle in wood and mat ardesia or champagne for door in wood.



Match. Maniglia ardesia o champagne opaco per porta in tessuto o laccato - Handle in mat ardesia or champagne for door in fabric or lacquer.



Match. Maniglia ardesia o champagne opaco e tecnocover Grain 4 colori per porta in tecnocover - Handle in mat ardesia or champagne and tecnocover Grain 4 colours for door in tecnocover.

PIVOT CON CUCINA
PIVOT WITH KITCHEN

Dimensioni

L'altezza, la larghezza e la profondità del portale vengono gestite a misura con una larghezza minima e massima rispetto alla porta singola o doppia. La profondità è a misura per variabile spessore muro a cui devono essere necessariamente ancorate le colonne.

Portale Pivot spessore mm 14,
Porta Pivot spessore mm 45.

Dimensions

The height, the width and the depth of the portal are managed to measure with a minimum and maximum width according to single or double door. The depth is customized to measure for variable wall thickness to which the tall units must necessarily be fixed.

Pivot portal thickness 1/2",
Pivot door thickness 1 3/4".

Altezza e larghezza
Height and width

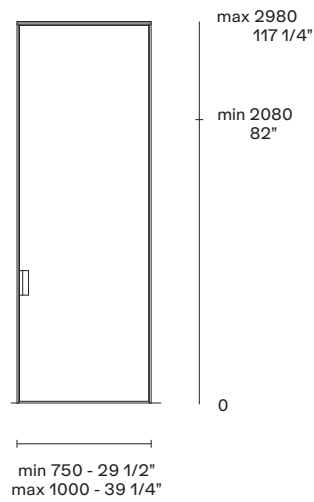

porta singola - single door
per calcolare luce di passaggio
togliere mm 140
for actual passage opening
deduct 5 1/2"

Altezza e larghezza
Height and width

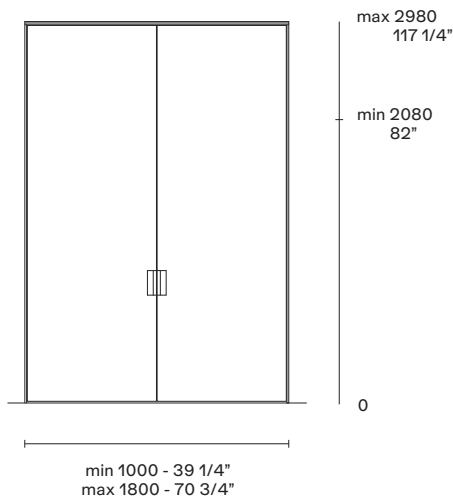

porta doppia - double door
per calcolare luce di passaggio
togliere mm 253
for actual passage opening
deduct 10"

Profondità
Depth

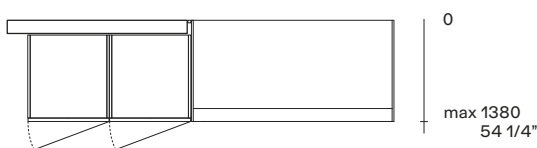

Pivot profondità a misura per variabile spessore muro, colonne cucina a parete.
Pivot customized depth for variable wall thickness, wall kitchen tall units.

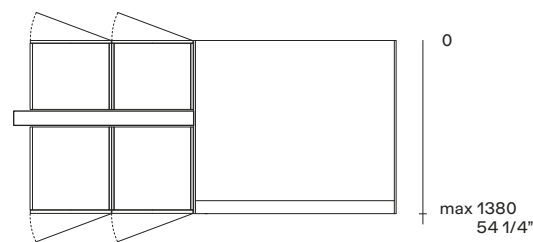

Modelli

Due le possibili soluzioni estetiche, dalla più essenziale, in essenza, massello o laccato a quella in vetro.

- 1 Porta Pivot Plus
- 2 Porta Pivot Plus vetro



Models

Two possible aesthetic solutions, from the most essential, in wood, solid wood or lacquer, to the one in glass.

- 1 Pivot Plus door
- 2 Pivot Plus glass door



PORTALE PIVOT CON CUCINA
PORTAL PIVOT WITH KITCHEN

Laccato goffrato
Embossed lacquer



82 glacier white 01 bianco 35 canapa 26 corda 88 castoro 46 tortora



64 arena 89 roccia 48 visone 49 moka 04 grafite 91 carbone



60 ghiaccio 09 pioggia 78 ferro 83 oca 85 caramello 67 muschio



92 vischio 87 granata 86 danubio 70 prussia

Laccato opaco
Mat lacquer



77 champagne 90 piombo 24 ottone 23 bronzo

Laccato metallico *
Metallic lacquer



03 titanio 01 bronzo 04 rame 05 ottone

Essenza *
Woods



rovere gold
gold oak rovere tinto grigio
grey oak painted rovere spessart
spessart oak olmo
elm olmo nero
black elm noce c.
walnut c.

Stipite con perni e telaio telescopico laccato goffrato
Jamb with pins and telescopic frame embossed lacquer



82 glacier white 01 bianco 35 canapa 26 corda 88 castoro 46 tortora



64 arena 89 roccia 48 visone 49 moka 04 grafite 91 carbone



60 ghiaccio 09 pioggia 78 ferro 83 oca 85 caramello 67 muschio



92 vischio 87 granata 86 danubio 70 prussia

Stipite con perni e telaio telescopico laccato opaco
Jamb with pins and telescopic frame mat lacquer



77 champagne 90 piombo 24 ottone 23 bronzo

* La venatura dell'essenza e la satinatura del metallico nel portale Pivot seguono quelle previste per le ante della cucina a cui viene abbinato.

The grain of the wood and the satin finishing of the metal in the Pivot portal follow those provided for the kitchen doors to which it is combined.

PIVOT PLUS CON CUCINA
PIVOT PLUS WITH KITCHEN



Porta - Door *



rovere gold
gold oak



rovere tinto grigio
grey oak painted



rovere spessart
spessart oak



olmo
elm

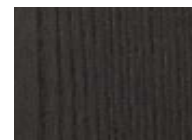

olmo nero
black elm



noce c.
walnut c.

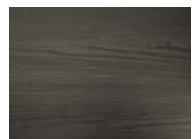

massello black ash
solid black ash



massello rovere fossile
solid fossil oak



massello rovere termico
solid thermic oak

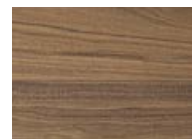

massello noce canaletto
solid walnut canaletto



massello noce canaletto
termico - solid thermic
walnut canaletto



laccato goffrato colori
embossed lacquered
colours



laccato opaco colori
mat lacquered colours

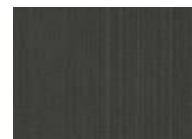

laccato metallico colori
metallic lacquered colours



Plus. Maniglia e profili moka o champagne opaco - Handle and profiles in mat moka or champagne.

* La venatura dell'essenza o massello e la satinatura del metallico nella porta Pivot Plus seguono quelle previste per le ante della cucina a cui viene abbinata.
The grain of the wood or solid wood and the satin finishing of the metal in the Pivot Plus door follow those provided for the kitchen doors to which it is combined.

PIVOT PLUS VETRO CON CUCINA
PIVOT PLUS GLASS WITH KITCHEN



Porta vetro - Glass door



5059 riflettente fumé
reflecting fumé

Telaio e maniglia - Frame and handle

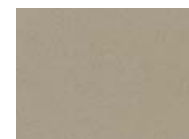

champagne opaco
mat champagne



moka opaco
mat moka



Plus. Maniglia moka o champagne opaco - Handle in mat moka or champagne.

SURFACE BOISERIE SYSTEM

Design R&D Poliform

Surface è un sistema boiserie per rivestire pareti e retro armadi in modo continuo. La boiserie (escluso specchio) si può attrezzare con i componenti del sistema giorno e notte Code ed è integrabile con gli armadi Senzafine e le porte Pivot. Il sistema prevede staffe di fissaggio a muro (ingombro mm 15) per l'aggancio dei pannelli distanziati da profili in alluminio verniciato. I pannelli sono dotati di piedini di regolazione a terra e di profili di chiusura verticali o orizzontali. Possibilità di composizioni con pannelli sovrapposti anche a misura e di soluzioni per angoli chiusi o aperti. La boiserie Surface è disponibile in diversi materiali e finiture, i profili sono verniciati ardesia o champagne opaco.

- 1 Boiserie ad altezza unica pannelli spessore 30
- 2 Boiserie sovrapposte
- 3 Boiserie ispezionabile, (escluso retro armadio e nelle finiture Inalco MDi® e specchio), maniglia ardesia o champagne
- 4 Profili in alluminio mm 4, profondità 30
- 5 Profili di chiusura verticali in alluminio mm 4, profondità 45
- 6 Profilo di chiusura orizzontale mm 4, profondità 45, per boiserie con altezza inferiore o uguale a 1950

Surface is a wall panelling system to cover the walls and the backs of the wardrobes in a continuous way. The wall panelling (except mirror) can be accessorized with the components of the Code day and night system and can be integrated with the Senzafine wardrobes and the Pivot doors. The system works with wall fixing brackets (thickness 1/2") to hang the panels with painted aluminium profiles between each panel. Panels are supplied with adjustment feet to the floor and with vertical and horizontal closing profiles. It is possible to superimpose the panels, also in customized size and solutions for corners and open corners are available, too. Surface wall panelling is available in several materials and finishes, the profiles are painted in mat ardesia or champagne.

- 1 Wall panelling in one piece panels thickness 1 1/4"
- 2 Superimposed wall panelling
- 3 Wall panelling with service opening (except wardrobe back and finishes Inalco MDi® and mirror), ardesia or champagne handle
- 4 Aluminium profiles 1/8", depth 1 1/4"
- 5 Vertical closing profiles in aluminium 1/8", depth 1 3/4"
- 6 Horizontal closing profile 1/8", depth 1 3/4", for wall panelling with height less than or equal to 76 3/4"

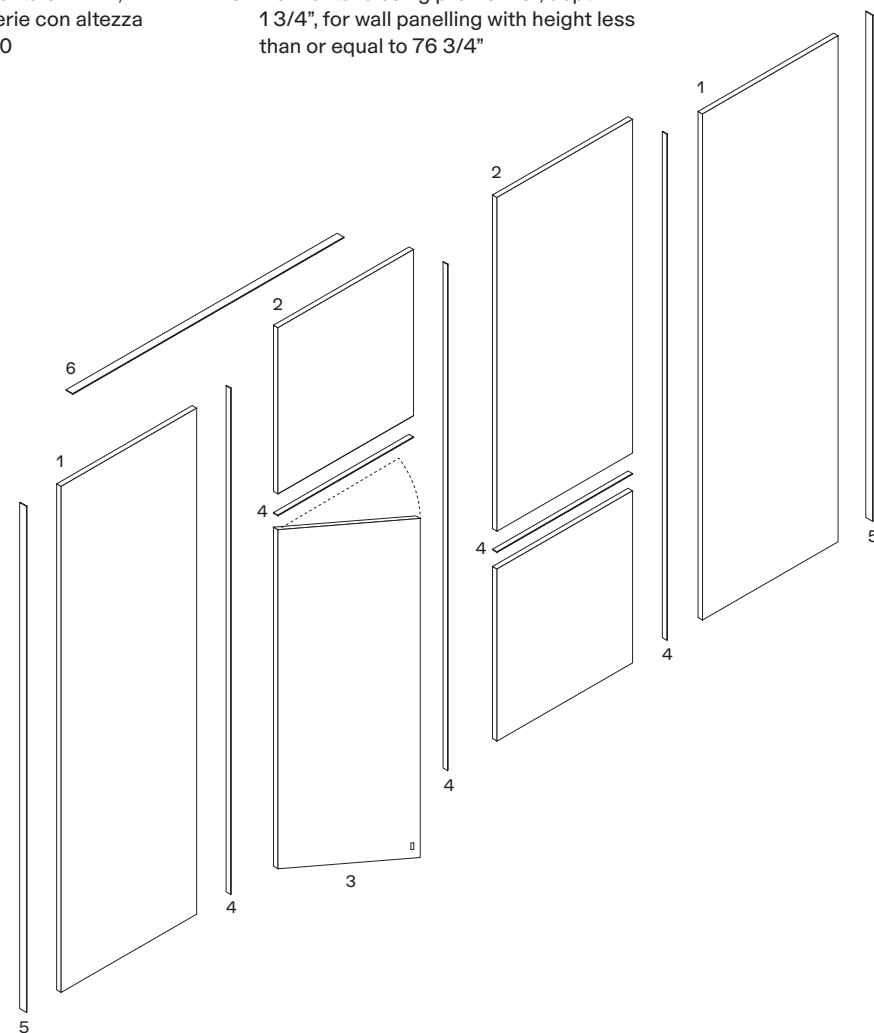

Boiserie in accostamento all' armadio Wall panelling next to the wardrobe

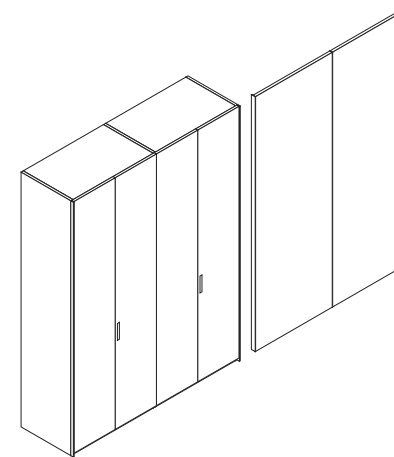

La boiserie può essere accostata a filo ante di un armadio Senzafine, in accostamento il fianco dell'armadio deve avere la sagoma e il pannello boiserie il profilo mm 4.

Wall panelling can be installed flush with the doors of a Senzafine wardrobe, in this case the wardrobe side must have the profile and the wall panel must have the 1/8" profile.

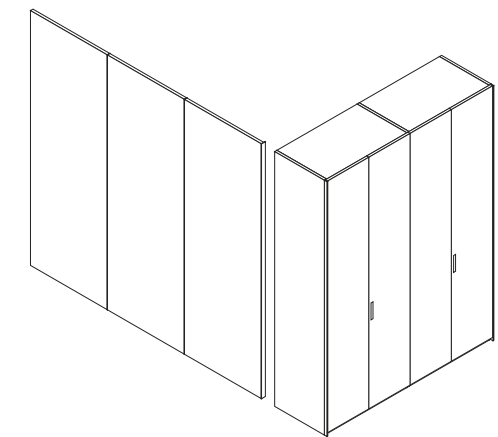

La boiserie può essere accostata al fianco di un armadio Senzafine, in accostamento il pannello boiserie deve avere il profilo mm 4.

Wall panelling can be installed next to the side of a Senzafine wardrobe, in this case the wall panel must have the 1/8" profile.

Boiserie retro armadio Wall panelling to the back of the wardrobe

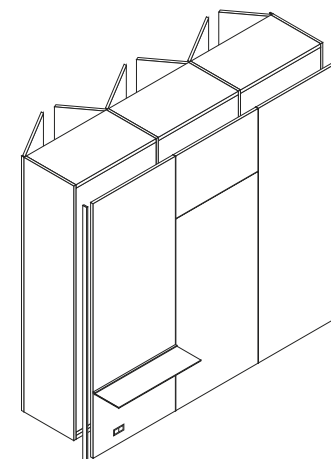

I pannelli boiserie devono essere conclusi ai lati con sagome di finitura per boiserie retro armadio, larghezza mm 14. La boiserie retro armadio, ad altezza unica o sovrapposta, può essere attrezzata (escluso specchio) con una sola mensola Code per pannello, con e senza luce a led (p 280-300, spessore 8), con il modulo di cablaggio per una presa elettrica o due prese usb o con gli specchi Drop, Circle e Audrey.

The wall panels must be closed at the sides with finishing profiles for wall panelling to the back of the wardrobe width 1/2". The wall panelling in one piece or superimposed can be accessorized (except mirror) with one Code shelf for panel, with or without led light (d 11"-11 3/4", thickness 1/4"), with the wiring module for one electric socket or for two usb sockets or with Drop, Circle and Audrey mirrors.

Boiserie tra due armadi Wall panelling between two wardrobes

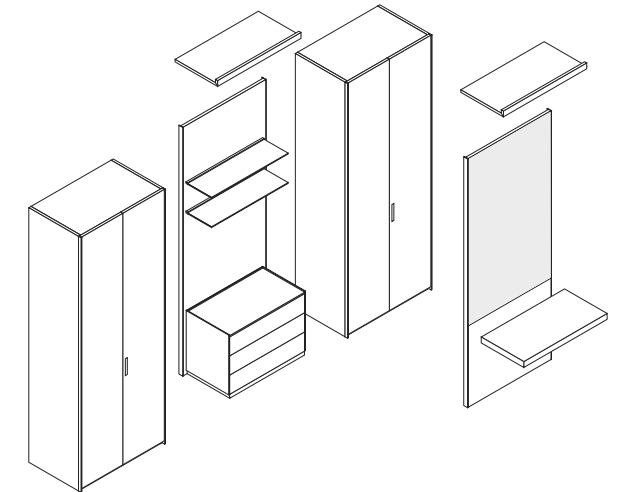

I pannelli boiserie devono essere conclusi ai lati con i profili mm 4 e completati con un coperchio superiore, con e senza luce a led. La boiserie (escluso specchio) può essere attrezzata con mensole, contenitori, modulo di cablaggio per una presa elettrica o due prese usb e mensoloni sospesi Code, con e senza luce a led.

The wall panels must be closed at the sides with 1/8" profiles and on top with a shelf with and without led light. Wall panelling (except mirror) can be accessorized with shelves, storage units, wiring module for one electric socket or for two usb sockets and Code hanging thick shelves, with and without led light.

SURFACE BOISERIE SYSTEM

Dimensioni

Pannelli boiserie disponibili in quattro larghezze e nove altezze, pannelli spessore 30, staffe di fissaggio a muro ingombro 15. Tutti i lati a vista delle boiserie devono essere completi di profilo verticale di chiusura. Per boiserie con altezza inferiore o uguale a 1950 è obbligatorio il profilo orizzontale superiore di chiusura.

Per il montaggio in altezza è richiesto uno spazio superiore di 30 mm. Per il montaggio in larghezza è richiesto uno spazio laterale di 30 mm in presenza di profili verticali di chiusura e di 5 mm se non sono previsti profili verticali di chiusura (in nicchia). Limiti dimensionali: larghezza massima 975, minima 220; altezza massima 2910 (escluso Inalco MDi® altezza massima 1950), minima 600.

Limiti dimensionali boiserie ispezionabile: larghezza massima 975, minima 400; altezza massima 2910, minima 900.)

Dimensions

Wall panels available in four widths and nine heights, panels thickness 1 1/4", wall fixing brackets thickness 1/2". All the exposed sides of the wall panelling must be completed with vertical closing profile. For wall panelling with height less than or equal to 76 3/4" the upper horizontal closing profile is obligatory.

For installation in height a space of 1 1/4" is requested. For installation in width a lateral space of 1 1/4" in case of vertical closing profiles is requested, and of 1/8" if there are no vertical closing profiles (in niche).

Dimensional limits: maximum width 38 1/2", minimum 8 3/4"; maximum height 114 1/2" (except Inalco MDi® maximum height 76 3/4"), minimum 23 1/2". Dimensional limits wall panelling with service opening: maximum width 38 1/2", minimum 15 3/4"; maximum height 114 1/2", minimum 35 1/2".

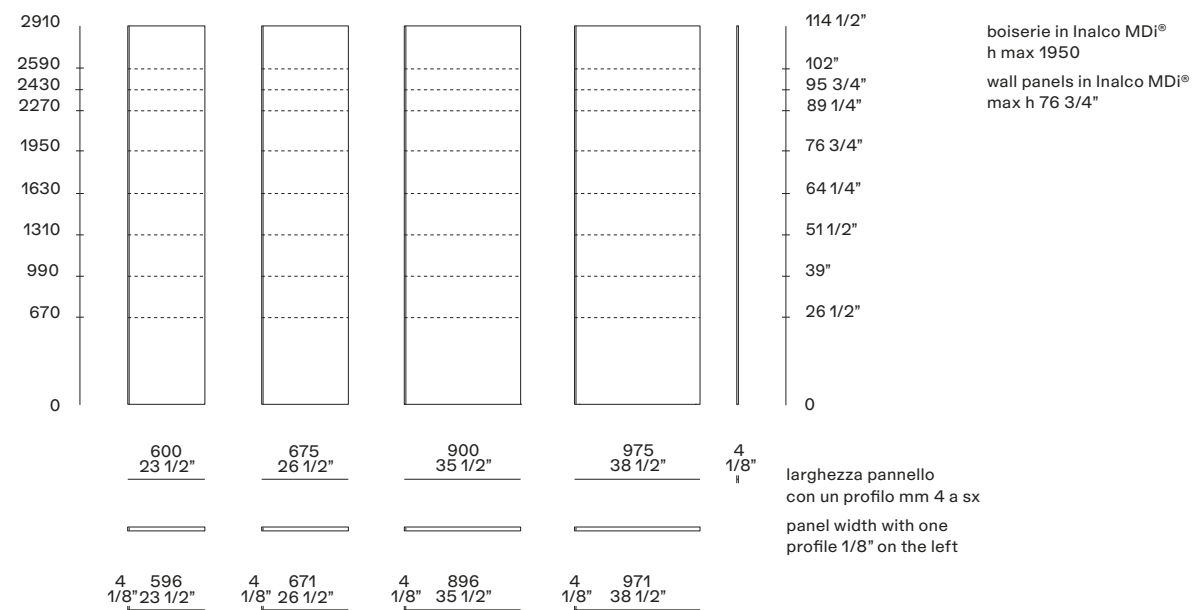

Soluzioni angolo Corner solutions

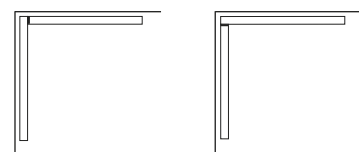

Angolo interno, profilo di serie sul pannello in battuta.

Inner corner, standard profile on the panel with visible edge.

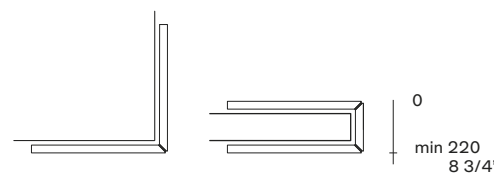

Angolo esterno, pannelli sagomati con profilo per angolo. I pannelli sagomati non possono essere attrezzati.

Outer corner, shaped panels with profile for corner. Shaped panels can not be accessorized.

Boiserie unica altezza

Si possono creare composizioni con pannelli boiserie fino ad altezza massima di 2910. Si possono accostare pannelli boiserie di diverse finiture.

La boiserie (escluso specchio) si può attrezzare con i componenti del sistema giorno e notte Code

Wall panelling in one piece

Compositions with wall panelling up to a maximum height of 114 1/2" are feasible. It is possible to combine wall panels in different finishes.

The wall panelling (except mirror) can be accessorized with the components of the Code day and night system.

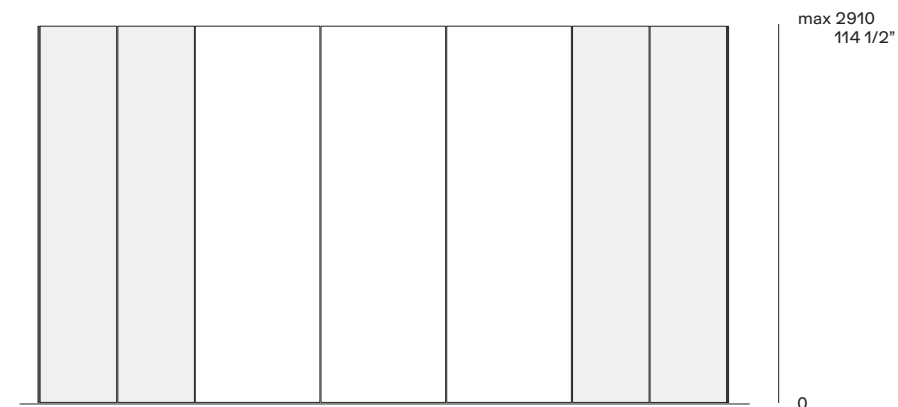

Boiserie sovrapposte

Si possono creare composizioni con pannelli boiserie sovrapposti.

Si possono accostare, e sovrapporre, pannelli boiserie di diverse finiture. Il pannello inferiore dovrà avere un'altezza di serie, quello superiore un'altezza per differenza con quella totale. Eventuali riduzioni a misura devono essere applicate al pannello superiore rispettando l'altezza minima di 600.

Superimposed wall panelling

Compositions with superimposed wall panelling are feasible. Wall panels in different finishes can be put near each other and can be superimposed.

The lower panel must have a standard height; the upper panel has a height by difference with the total one.

Any cuts to size must be applied to the upper panel respecting the minimum height of 23 1/2".

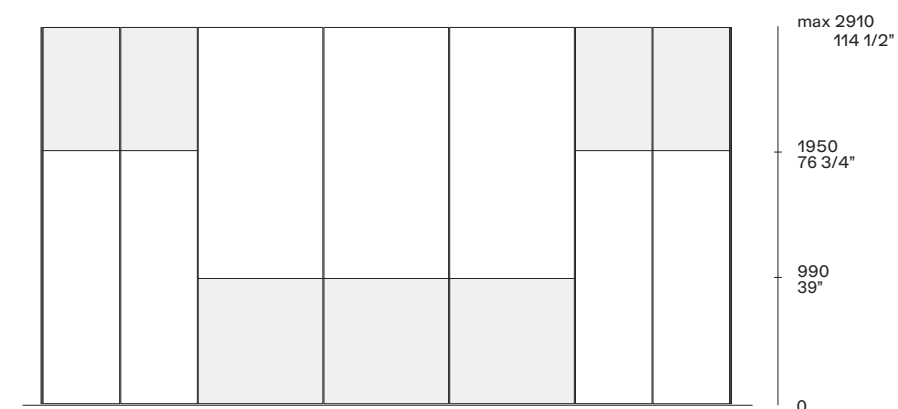

La boiserie in Inalco MDi® non può essere attrezzata con i contenitori living, le librerie e i pensili del sistema giorno Code.

Wall panelling in Inalco MDi® cannot be equipped with storage units living, bookcases and wall units of Code day system.

SURFACE
BOISERIE SYSTEM

Laccato opaco
Mat lacquer



82 glacier white 01 bianco 35 canapa 26 corda 88 castoro 46 tortora



64 arena 89 roccia 48 visone 49 moka 04 grafite 91 carbone



60 ghiaccio 09 pioggia 78 ferro 83 ocra 85 caramello 67 muschio



92 vischio 87 granata 86 danubio 70 prussia



77 champagne 24 ottone 23 bronzo 90 piombo 02 ardesia

Laccato metallico
Metallic lacquer



23 bronzo 24 ottone 25 titanio

Profili
Profiles



champagne opaco
mat champagne ardesia opaco
mat ardesia

Specchio *
Mirror



4000 bianco
white 4051 bronzato
bronzed

* I pannelli boiserie a specchio hanno un profilo perimetrale in ardesia o champagne. Non possono essere attrezzati con i componenti del sistema Code, sono accostabili o sovrapponibili con pannelli di altre finiture.
Mirror wall panels have a perimeter profile in ardesia or champagne. They cannot be equipped with the elements of Code system, panels in other finishes can be put next to them or superimposed to them.

Essenza
Wood

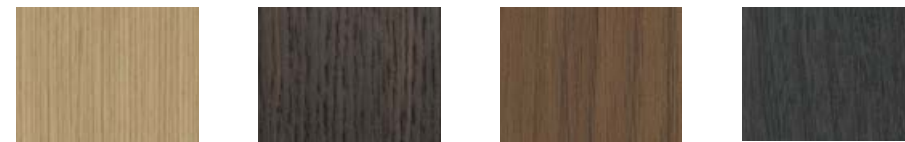

rovere gold
gold oak rovere spessart
spessart oak noce c
walnut c olmo nero
black elm

Essenza Print
Wood Print



rovere gold print
gold oak print rovere spessart print
spessart oak print noce c print
walnut c print olmo nero print
black elm print

Tessuto
Fabric



lino chiaro lino é cru lino bruciato lino scuro

Inalco MDi®
Inalco MDi®

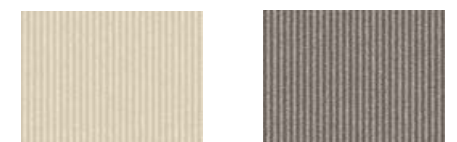

rigato chiaro rigato scuro

Tecnocover Grain
Grain tecnocover



05 latte 01 elefante 02 moro 06 nocciola

Sagome per boiserie retro armadi
Profiles for wall panelling to the back of wardrobes



laccato opaco colori
mat lacquered colours laccato metallico colori
metallic lacquered colours rovere gold
gold oak rovere spessart
spessart oak noce c
walnut c olmo nero
black elm



lino chiaro
tessuto - fabric lino é cru
tessuto - fabric lino bruciato
tessuto - fabric lino scuro
tessuto - fabric champagne opaco
mat champagne ardesia opaco
mat ardesia

Poliform Spa
via Montesanto 28
Casella postale n. 1
22044 Inverigo (CO) Italy
t +39 031 6951
f +39 031 699444
info@poliform.it
poliform.it



2018 Adi Compasso D'oro
Career Award

Poliform realizza tutte le sue collezioni in Italia usando componenti e materie prime selezionate.

All the Poliform collections are manufactured 100% in Italy using top-class components and materials.

Poliform si riserva il diritto di apportare, senza preavviso, ogni modifica mirata al miglioramento funzionale e qualitativo dei propri prodotti. Testi e disegni presenti in questo stampato hanno scopo divulgativo: per ogni aspetto tecnico e dimensionale fare riferimento ai listini aziendali e relativi aggiornamenti. I campioni di colori e materiali hanno valore indicativo.

Poliform reserves the rights at all time to apply modifications for the functional or qualitative improvement of its products. Texts and drawings present in this brochure have a divulgative purpose: for every technical and dimensional aspect please refer to the company's price lists and their relative updatings. The colour and material samples have an indicative value.

Creative Direction
Apartamento Studios

Graphic Design
Apartamento Studios

Interiors Photography
Omar Sartor

Interiors Styling
Poliform Lab

Illustrations
Pol Montserrat

Thanks to: Laurie Poast, @salvatori_official

2nd edition April 2023
cod. 127/R2/2023



