

705-685250-00

Godox

TT685 II S

THINKLITE TTL CAMERA FLASH

迅丽 TTL 机顶闪光灯



说明书
Instruction Manual

深圳市神牛摄影器材有限公司

地址: 深圳市宝安区福海街道塘尾社区耀川工业区厂房2栋

电话: 0755-29609320(8062) 传真: 0755-25723423 邮箱: godox@godox.com

GODOX Photo Equipment Co., Ltd.

Add: Building 2, Yaochuan Industrial Zone, Tangwei Community, Fuhai Street, Bao'an District, Shenzhen, 518103 China Tel: +86-755-29609320(8062)

Fax: +86-755-25723423 E-mail: godox@godox.com

在使用本产品之前:

请先仔细阅读本手册, 以确保您能安全使用。请保存好本手册以备将来查询参考。

Before using this product:

Please read this user manual carefully in order to ensure your safety and the proper operation of this product. Keep for future reference.

godox.com Made in China



感谢您购买神牛产品。

该型号机顶闪光灯适用于索尼系列相机，兼容TTL自动闪光。使用TTL闪光灯，您将获得更简单的拍摄体验，在光线变化复杂的情况下，可以自动获得准确的闪光曝光，拍摄轻松自如。产品特点突出表现在以下几方面：

●约GN60 (ISO 100, @200mm), 81级调光(1/1~1/256)

●兼容索尼相机TTL

支持TTL自动闪光，可作为无线多灯闪光系统的主控或从属单元，拍摄更简单快捷

●点阵液晶屏

显示直观，操作更加简易

●内置2.4G无线传输

收发一体，超远距离，创意无限

●功能齐全，无限享用

支持手动和频闪闪光模式，高速同步/第二帘快门同步/闪光曝光补偿等TTL功能

●光学研究，输出稳定

高速连闪，每次输出亮度和色温连续一致，光线均匀分布

●固件升级，兼容无忧

跟随原厂相机步伐，可对软件进行再升级

01	前言
01	警告
03	部件名称
	机身
	控制面板
	LCD液晶显示屏
	三种模式下的不同LCD屏显示
	标配物品
	可选购附件
	装卸电池
06	装卸闪光灯
06	电源管理
07	闪光模式-- TTL自动闪光模式
	闪光曝光补偿
	高速同步
	第二帘快门同步
09	闪光模式-- M:手动闪光
09	闪光模式-- Multi:频闪闪光
10	无线闪光拍摄:无线电(2.4G)传输
	无线设置
	设置通讯频道
	无线ID设置
	扫描空闲频道设置
	TTL:全自动无线闪光拍摄
	M:手动无线闪光拍摄
	Multi:手动无线闪光拍摄
15	其他应用
	同步插孔触发
	自动辅助对焦灯
	反射闪光
	ZOOM:设置闪光覆盖范围
	电池电量低警示
17	C.Fn:设置自定义功能
18	保护功能
19	规格参数
19	故障排除指南
20	固件升级
20	兼容相机列表
20	维护保养目录

警告

- ⚠ 请保持干燥。
- ⚠ 请勿私自拆卸产品，如产品出现故障须由本公司或授权的维修人员进行检查维修。
- ⚠ 请勿让儿童接触本产品。
- ⚠ 禁止拆卸、撞击、挤压或投入火中，若出现严重鼓胀，请勿继续使用。请勿放置在超过50度的高温环境中。
- ⚠ 请勿将闪光灯头正对人眼闪光(特别是婴儿的眼睛)，否则可能会在短时间内造成视力障碍。
- ⚠ 请勿在化学品、可燃性气体或其他特殊物质附近使用闪光灯，这些物质在特殊情况下可能对闪光灯发出的瞬间强光敏感，有可能导致火灾或电磁干扰。在这些场合下，请注意相关警告标识。
- ⚠ 本产品不能防水，在雨天及潮湿环境下请注意防水。
- ⚠ 若发生任何故障，请立即关闭闪光灯电源。

本说明书中使用的约定

- 此使用说明书中的操作步骤假定相机和闪光灯的电源开关已开启。
- 参考页码由(第**页)表示。
- 此使用说明书中使用以下警告符号：
 - ▲ 该“小心”符号表示避免出现拍摄问题的警告。
 - 该“注意”符号提供补充信息。

部件名称

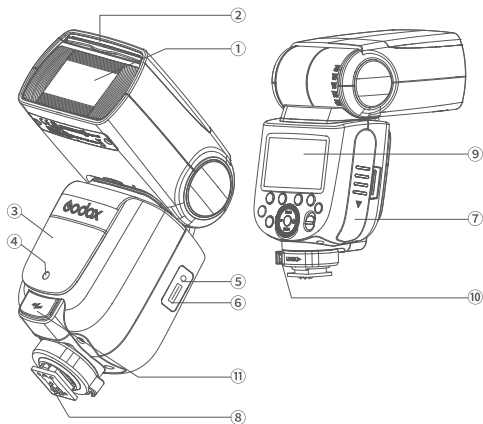

● 机身

- 01. 闪光灯头
- 02. 内置广角散光板
- 03. 无线传感器
- 04. 辅助对焦灯
- 05. 同步插孔
- 06. Type-C USB端口
- 07. 电池仓
- 08. 热靴
- 09. 液晶显示屏
- 10. 固定热靴扣锁
- 11. 外置充电接口

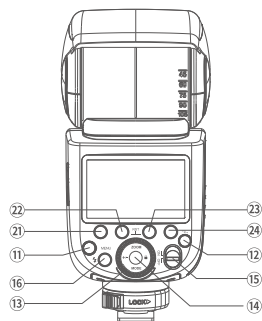
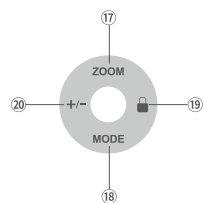

● 控制面板

- 11. <MENU>闪光灯菜单按钮
- 12. <+/->无线按钮
- 13. 调节旋钮
- 14. 设置按钮
- 15. ON/OFF电源开关
- 16. <+>试闪按钮
回电指示灯
- 17. <ZOOM>焦距设置
- 18. <MODE>闪光灯模式选择
- 19. <锁>设定设置
- 20. <+/->功率大小调节
- 21. 功能按钮1
- 22. 功能按钮2
- 23. 功能按钮3
- 24. 功能按钮4

● LCD液晶显示屏

(1) TTL自动闪光

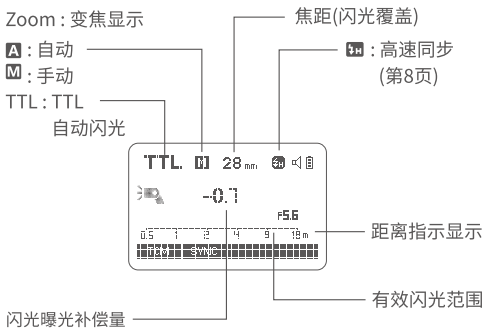

● 显示屏将只显示当前应用的设置。

- 在功能按钮1至功能按钮4上方显示的功能(如<SYNC>和<M/A/B/C>)根据设置的状态发生变化。
- 当操作按钮或拨盘时,液晶显示屏点亮。

(2) M手动闪光

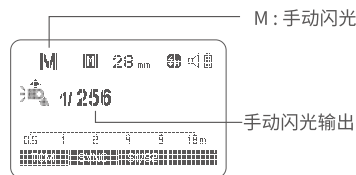

(3) Multi频闪光

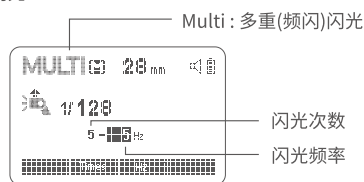

(4) 无线电传输拍摄

● 主控单元

闪光模式

Ⓢ: 无线电传输无线拍摄

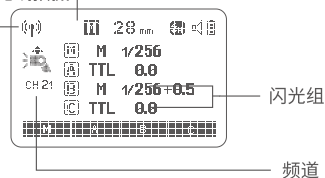

● 从属单元

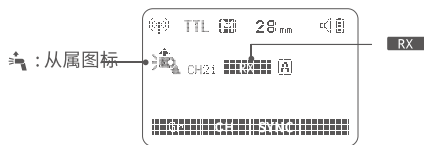

● 装卸电池

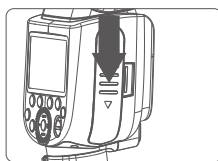

1 拆卸电池。

- 按照电池仓指示方向，用你的双手往下推动电池仓，便可打开电池仓，取出电池。

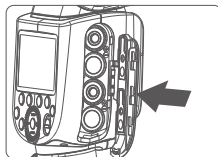

2 安装电池。

- 打开电池仓后，分辨电池正负极，将4节电池一一分别放进电池仓中，最后盖上电池仓，往上推至顶端即可。

小提示：另购神牛外接闪光灯电源盒PB960，搭配TT685HS使用，能够大幅增加闪光次数，缩短回电时间，提高续航能力。

● 三种模式下的不同LCD屏显示

● 机顶模式

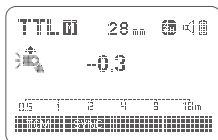

● 2.4G无线传输：作为主控

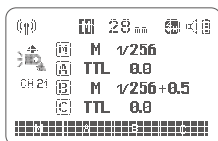

● 2.4G无线传输：作为从属

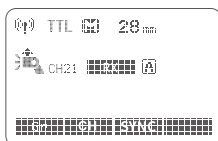

● 标配物品

1、闪光灯 2、微型底座 3、保护包 4、说明书

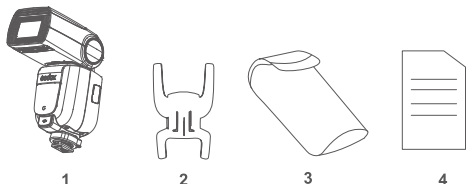

● 可选购附件

可搭配本公司以下摄影附件使用，以获得最佳的拍摄效果和使用体验：XProS、X2T-S、X1S TTL引闪器等。

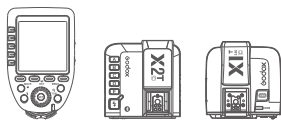

装卸闪光灯

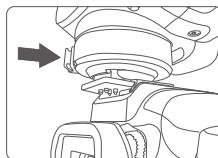

1 安装闪光灯。

- 转动闪光灯旋转钮到左边便可以全插入相机的热靴。



2 扣紧闪光灯。

- 转动闪光灯旋转钮到右边，便可以锁定热靴。

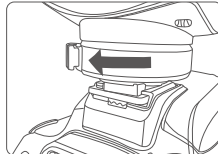

3 取下闪光灯。

- 按下旋转钮上的按键，旋转到左边，便可解除锁定热靴。

电源管理

*ON/OFF电源开关控制该产品的打开和关闭，长时间不使用时请关闭电源。本产品设计有电源自动关闭功能。作为主控单元在长时间（约90秒）无人操作时，闪光灯会自动关闭，半按快门按钮或机身任意键唤醒；作为从属单元在60分钟（或者选择30分钟）无任何操作时，闪光灯会进入休眠状态，此时可按机身任意键唤醒。

C.Fn 离开使用时,建议通过自定义功能使“自动关闭电源”无效。

C.Fn “从属单元自动关闭电源计时器”出厂默认设置为60分钟,也可自定义选择30分钟。

闪光模式:TTL自动闪光模式

该闪光灯有TTL自动闪光, M手动闪光, Multi频闪光三种模式。在TTL模式下,相机的测光系统会侦查从主体反射回来的闪光照明,从而自动调节闪光输出量,使主体和背景得到均衡曝光。支持曝光补偿、高速同步、第二帘快门同步、曝光锁定等功能。

*按下<MODE>模式选择按钮,三种闪光模式将会依次出现在液晶屏上。

TTL模式

通过按<MODE>模式选择按钮,将闪光灯设置为<TTL>,可以使闪光灯进入TTL模式。

- 半按相机快门按钮进行对焦,光圈值和有效闪光范围将会显示在显示屏上。
- 在快门释放前的瞬间进行一次预闪,闪光灯接收相机信息进行主闪光。

闪光曝光补偿

该闪光灯可以在±3档间以1/3档为增量调节闪光曝光补偿。由于环境的需求而需要微调TTL系统时,这个功能非常有用。

设置闪光曝光补偿:

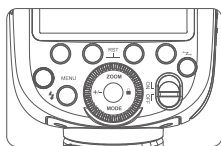

1 按下<+/->按钮,令屏幕显示闪光曝光量,并且闪光曝光补偿量被突出显示

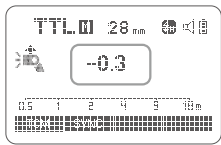

2 设置闪光曝光补偿量。
●转动调节旋钮设置曝光补偿量。
●“0.3”表示1/3档,“0.7”表示2/3档。
●要取消闪光曝光补偿,将闪光曝光补偿量设为“+0”。

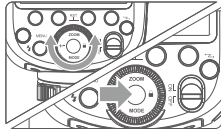

3 按下设置按钮,确定闪光曝光补偿。

高速同步

使用**高速同步(FP闪光)**,您可以在所有的快门速度下同步使用闪光灯。高速同步闪光在使用光圈优先对人像进行填充闪光时特别方便。

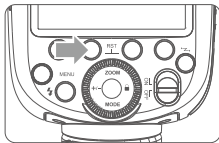

1 按下功能按钮2<SYNC>,令屏幕显示<H>图标。

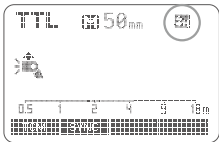

2 在SONY相机上按MENU或快捷键Fn进闪光模式选择强制闪光,再设置相机快门。

- 如果设置快门速度等于或慢于相机的最大闪光同步速度,取景器中将不显示<H>。
- 使用高速同步,快门速度越高,有效的闪光范围就越小。
- 要恢复普通闪光,再次按下<SYNC>按钮。<H>图标会消失。
- 无法设置频闪光。
- 连续高速同步闪光30次后,闪光灯热保护功能可能会被激活。

第二帘快门同步

使用慢速快门,您可以在被摄体后创建一条光线轨迹。在快门关闭前的瞬间闪光灯闪光。

在SONY相机机身设置中,选REAR闪光方式。

闪光模式:M 手动闪光

您可以在1/256功率至1/1全功率间以1/10档为增量设置闪光输出。

为获得正确的闪光曝光,请使用手持的闪光测光表确定所需的闪光输出。

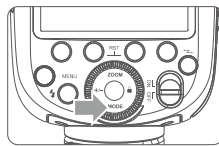

1 按<MODE>模式选择按钮,屏幕显示<M>。

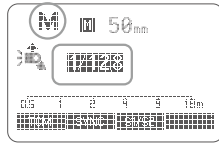

2 先按<+/->选中功率,转动调节旋钮设置闪光输出功率。

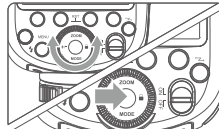

3 按下设置按钮,确定闪光输出功率。

S1光控单元设置

在M手动闪光模式下,可以使用S1功能,闪光灯可作为副灯使用,创造多种照明效果,适用于手动闪光环境。它会与主闪光灯的第一次闪光同步触发闪光,效果与使用无线引闪器一致。

S2光控单元设置

在M手动闪光模式下,可以使用S2功能,闪光灯可作为副灯使用,适用于TTL闪光环境。具有防预闪功能,使用带一次预闪功能的相机能用光控实现同步拍摄。它会与主闪光灯的第二次闪光同步触发闪光,即2次光控引闪。

● 只有在M模式下才支持S1/S2光控引闪模式。

▲ 为防止闪光灯过热并损坏,请勿执行连续10次以上的频闪闪光连拍。闪光10次后,请让闪光灯至少冷却15分钟。如果您试图执行连续10次以上的频闪闪光连拍,为防止闪光灯过热,闪光可能自动停止。如果发生了这种情况,请让闪光灯至少冷却15分钟。

● 反光很强的被摄体在暗背景前使用频闪闪光更加有效。

- 推荐使用三脚架和遥控开关。
- 闪光输出为1/1和1/2时不能设置频闪闪光。
- 频闪闪光时也可以使用“buLb”。
- 如果闪光次数显示为--,则闪光灯会连续闪光,直到快门或电池耗尽。如下表所示,闪光次数将受到限制。

闪光模式:Multi 频闪闪光

使用频闪闪光,可以发出一系列快速的闪光。它可以在一张照片上拍摄移动物体的多个图像。

您可以设置闪光频率(每秒的闪光次数,以Hz表示)、闪光次数和闪光输出。

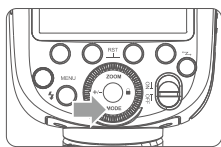

1 按<MODE>闪光模式选择按钮,屏幕显示<MULTI>

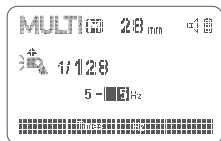

2 设置闪光频率和闪光次数。
● 按功能按钮2<Times>选择闪光次数,旋转调节旋钮设定数字。
● 按功能按钮3<Hz>选择闪光频率,旋转调节旋钮设定数字。

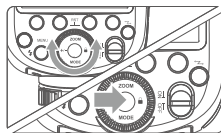

3 转动调节旋钮设置闪光输出功率。
按下设置按钮确定,所有设置都将显示出来。

计算快门速度

在频闪闪光过程中,到闪光停止为止快门应保持开启状态。使用下面的公式计算快门速度,然后用相机进行设置。

$$\text{闪光次数} / \text{闪光频率} = \text{快门速度}$$

例如,如果闪光次数是10,闪光频率是5Hz,快门速度则至少为2秒。

最大频闪闪光次数

闪光输出 \ Hz	1	2	3	4	5	6-7	8-9
1/4	8	6	4	3	3	2	2
1/8	14	14	12	10	8	6	5
1/16	30	30	30	20	20	20	10
1/32	60	60	60	50	50	40	30
1/64	90	90	90	80	80	70	60
1/128	90	90	90	90	90	90	80
1/256	90	90	90	90	90	90	80

闪光输出 \ Hz	10	20-50	60-100
1/4	2	2	2
1/8	4	4	4
1/16	8	8	8
1/32	20	16	12
1/64	50	30	20
1/128	70	40	40
1/256	70	40	40

无线闪光拍摄:无线电(2.4G)传输

● 安装在相机上的TT685IIS称为主控单元,受无线控制的TT685IIS称为从属单元。

- 还可以用闪光灯信号发射器X1T-C(另购)无线控制设为从属单元的TT685IIS。有关设定主控单元功能的详细说明,请参考信号发射器的使用说明书。

使具有无线电传输无线拍摄功能的闪光灯(主控/从属),可按照与普通TTL自动闪光拍摄同样的方法,轻松利用高级无线多重闪光照明进行拍摄。基本相对位置和操作范围如图所示所示,只要将主控单元设定为<TTL>就可以进行无线TTL自动闪光拍摄。

定位和操作范围(无线闪光拍摄的示例)

- 使用一个从属单元进行自动闪光拍摄

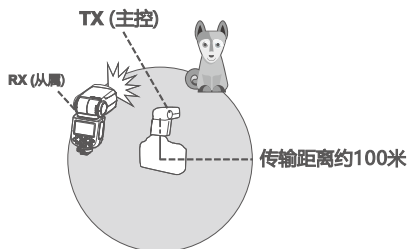

- 使用附带的微型支架定位从属单元。
- 开始拍摄前请进行测试闪光和试拍。
- 受从属单元的位置、周围环境、天气状况等影响,传输距离可能更短。

无线多重闪光拍摄

可以将从属单元分割为两个或三个组并在改变闪光光比(倍率)的同时进行TTL自动闪光拍摄。此外,可以为各闪光灯(最多4个组)设定并用不同的闪光模式拍摄。

- 用两个从属组进行自动闪光拍摄。

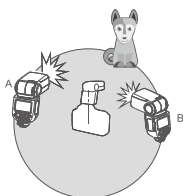

- 用三个从属组进行自动闪光拍摄。

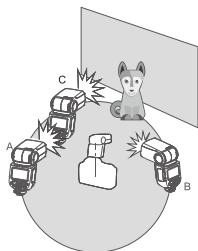

1、无线设置

您可以在普通闪光和无线闪光之间切换。对于普通闪光,请务必将无线设置设为“关”。

主控单元设置

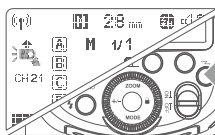

按下<=>无线设置按钮,令屏幕显示<CH>。

从属单元设置

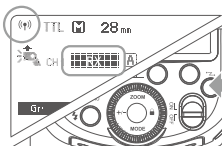

按下<=>无线设置按钮,令屏幕显示<CH>和<RX>。

2、设置通讯频道

如果在拍摄现场不止一个无线闪光系统,您可以通过更改通讯频道来防止信号干扰。保证主控单元和从属单元设置为相同的频道编号即可。

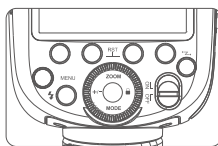

1 按<MENU>菜单键进入自定义CH设置。

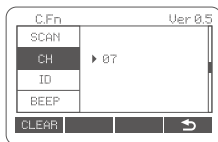

2 在自定义里<CH>中,旋转调节旋钮从1至32中选择频道。

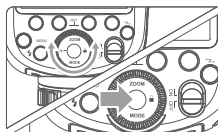

3 按下设置按钮确定。

3、无线ID设置

为了避免信号干扰,除了改变无线通讯频道还可以通过改变无线ID来防止干扰;主控单元和从属单元设为相同的频道和无线ID即可。短按<MENU>菜单键进入C.Fn ID,选择01-99其中任意一数无线ID打开,选OFF无线ID关闭。

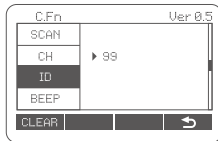

4、扫描空闲频道设置

为了避免其他人使用同样频道受到干扰,可以使用扫描空闲频道功能:进入自定义菜单找到<SCAN>的选项,设置为START时显示会出现1%到100%的扫描,扫描完成后会出现8组频道空闲频道。

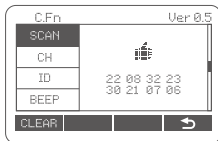

5、TTL: 全自动无线闪光拍摄

使用一个从属单元的自动闪光拍摄

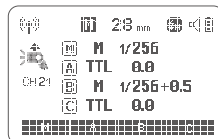

1 设置主控单元。

- 将安装在相机上的 TT685IIS设为主控单元。
- M/A/B/C 都可独立设置为 TTL

2 设置从属单元。

- 将要被无线控制 TT685IIS设为从属单元。

3 检查传输频道。

- 将主控单元和从属单元的频道设为一致。

4 定位相机和闪光灯。

- 将其定位在所示的范围内。

5 检查闪光灯是否准备就绪。

- 检查主控闪光灯就绪指示灯点亮。

6 检查操作。

- 按下主控闪光灯的试闪按钮 <⚡>。
- 从属单元闪光。如果从属单元不闪光，检查是否将其放置在操作范围内。



使用多个从属单元的自动闪光拍摄

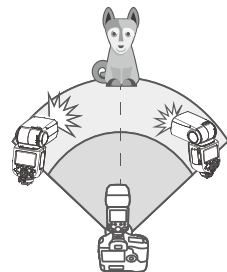

当需要更大的闪光输出或想要更加轻松地进行照明时，可以增加从属单元的数量并将其作为单个闪光灯闪光。

要添加从属单元，使用与“使用一个从属单元的自动闪光拍摄”相同的步骤，可以设定任何闪光组(A/B/C/D/E)。

当增加了从属单元的数量或主控闪光灯闪光设为ON时，执行自动控制以使所有闪光灯以相同的闪光输出闪光并确保总闪光输出能够达到标准曝光。

- 如果从属单元的自动关闭电源生效，按主控单元的测试闪光按钮打开从属单元。请注意在相机的测光定时工作期间，无法进行测试闪光。

- 可以改变到从属单元的自动关闭电源生效为止的时间(C.Fn-RX STBY/第19页)。
- 可以进行设置以使自动对焦辅助发射器在从属单元回电完毕时不闪烁(C.Fn-AF/第19页)。

使用全自动无线闪光

在主控单元上设定的闪光曝光补偿和其他设置也会在从属单元中自动设定。不需要操作从属单元。可按照与普通闪光拍摄相同的方法使用以下设置进行无线闪光拍摄。

- 闪光曝光补偿 (±)

关于主控单元

可以使用两个或两个以上主控单元。通过准备多台装有主控单元的相机，可以在保持相同照明(从属单元)期间更换相机进行拍摄。

6、M:手动无线闪光拍摄

使用手动闪光的无线(多重闪光)拍摄，可以为每个从属单元(闪光组)设定不同的闪光输出进行拍摄。在主控单元上设定所有参数。

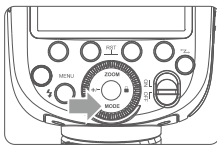

1 将闪光模式设为<M>。

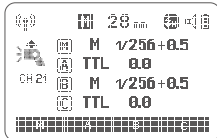

2 设置闪光输出

- 按下功能按钮 1/2/3/4<M/A/B/C>，旋转调节旋钮为闪光组设定闪光输出，并按设置按钮确定。

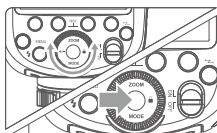

3 拍摄照片

- 各组以设定的闪光比闪光。

设定<M>闪光模式

可以直接操作从属单元以手动设定手动闪光或频闪闪光。



1 设定从属单元。(第12页)

2 设定<M>闪光模式。

- 按下<MODE>模式选择按钮令屏幕显示<M>。
- 设定手动闪光输出。

7、Multi:手动无线闪光拍摄

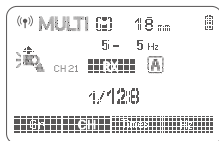

- 1 设定<MULTI>频闪模式。
 - 按下<MODE>模式选择按钮令屏幕显示<MULTI>
 - 设定频闪闪光设置。(第9页)

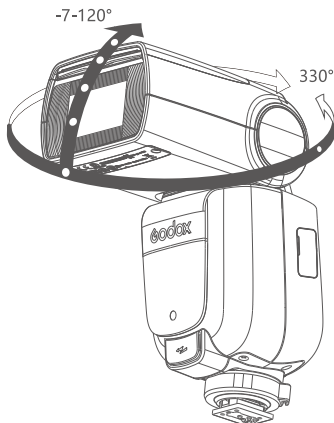

神牛2.4G无线漏闪原因及解决办法

1. 外部环境2.4G信号干扰(如无线基站、2.4Gwifi路由、蓝牙设备等)
 - 请调节引闪器的频道CH设置(建议+10), 找到无干扰的频道来工作, 或者在工作时关闭其他2.4G设备。
2. 请确认闪光灯是否已经回电或者回电速度已经跟上连拍速度(闪光灯就绪指示灯已经亮起), 并且没有处于过热保护或者其他异常状态中
 - 请下调闪光灯的档位, 如是TTL模式可以尝试改为M模式(TTL模式下需要预闪一次)。
3. 是否引闪器和闪光灯距离太近(距离<0.5m)
 - 请在引闪器上打开“近距离无线模式”:
X1系列: 按住引闪按钮不放, 然后开机, 直至指示灯闪2次。
Xpro系列: 设置C.Fn-DIST为0-30m。
4. 是否引闪器和接收端设备在低电状态
 - 请更换电池(引闪器电池建议使用1.5V一次性碱性电池)。

- 如果墙壁或天花板太远, 反射闪光可能太弱并导致曝光不足。
- 墙壁或天花板应该是平坦的、白色的以利于高效的反射。如果反射表面不是白色的, 照片将出现偏色。

创建眼神光

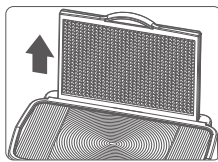

创建眼神光使用眼神光板, 您可以在被摄体的眼睛中创建眼神光以使面部表情更加生动。

1. 将闪光灯头向上旋转90°。
2. 拉出广角散光板, 同时弹出眼神光板。

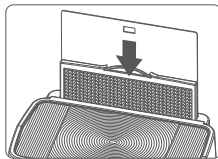

3. 推入广角散光板。
仅推入广角散光板。
按照反射闪光中相同的步骤进行。

注意:

- 请将闪光灯头向前指然后向上旋转90度。如果左右旋转闪光灯头就不会产生眼神光。
- 要获得最好的眼神光效果, 被摄体不能处于相机1.5米/4.9英尺以内。

ZOOM: 设置闪光覆盖范围

该闪光灯有两种变焦方式: 自动变焦和手动变焦。可以设置闪光覆盖范围以匹配20-200毫米的镜头焦距。自动变焦时, 焦距会随着相机变焦镜头的变化而变化, 以提供最佳闪光效果。

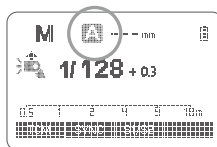

手动变焦时, 按下<ZOOM>变焦按钮。

- 转动调节旋钮更改闪光覆盖范围。
- 在显示<A>状态下, 将自动设置闪光覆盖范围。

其他应用

同步插孔触发

同步插孔规格为Φ2.5mm, 此处可插入同步线或者触发器触发插头对闪光灯进行同步引闪。

自动辅助对焦灯

在低亮度或低对比度的拍摄情况下, 闪光灯内置的自动对焦辅助灯将开启, 使自动对焦更容易。当对焦困难时, 红色辅助对焦灯亮起; 当对焦准确, 辅助对焦灯自动熄灭。

如想关闭自动辅助对焦功能, 在C.Fn设置“AF”至“OFF”。

- 用户在使用时, 如发现辅助对焦灯未亮起, 是因为相机已经处于准确对焦状态。

位置	有效范围
中央	0.6~10米 / 2.0~32.8英尺
边缘	0.6~5米 / 2.0~16.4英尺

反射闪光

通过将闪光灯头指向墙壁或天花板, 闪光在照亮被摄体前被墙面反射。这可以减轻被摄物体背后的阴影, 获得更自然的摄影效果。称之为反射闪光。

旋转闪光灯头来设置反射方向。

- 如果手动设置闪光覆盖范围,确保其覆盖镜头焦距,这样照片就不会出现阴影边缘。

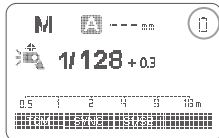

电池电量低时,电池符号< > 会闪烁,此时请更换电池。

C.Fn: 设置自定义功能

请对照以下图表本机应用栏,使用自定义功能来完成设置。

自定义功能符号	功能	设置符号	设置和说明
m/ft	距离指示显示	m	米
		ft	英尺
AF	自动对焦辅助闪光灯	ON	启动
		OFF	关闭
STBY	自动睡眠设置	ON	启动
		OFF	关闭
RX STBY	从属单元自动	60min	60分钟
	关闭电源计时器	30min	30分钟
SCAN	扫描空闲频道	OFF	关闭
		START	开始查找空闲频道
CH	频道设置	01~32	32个频道选择
ID	无线ID	OFF	关闭
		01-99	选择01-99任意一个数字打开
BEEP	蜂鸣器	ON	启动
		OFF	关闭
LIGHT	背光点亮时间	12sec	12秒后自动熄灭
		OFF	一直熄灭
		ON	一直点亮
LCD	液晶屏对比度	-3~+3	7个级别
TX DIST	引闪距离	1~100m 0~30m	1~100m引闪 0~30m引闪

- 按MENU 按钮显示C.Fn 菜单。右上角“Ver x.x”表示软件版本号。
- 选择自定义功能符号。
旋转调节旋钮设置自定义功能符号。
- 更改设置。
 - 按设置按钮,自定义功能编号闪烁。
 - 旋转调节旋钮设置想要的编号,按设置按钮确定。
 - 设置自定义功能后按下 < MENU > 按钮,相机可以进行拍摄。
- 在C.Fn状态下,长按“Clear”按钮2秒直至出现“OK”,表示重置C.Fn的参数。

保护功能

1. 热保护

- 为防止闪光灯过热并损坏,请勿在1/1功率时进行超过40次的快速连续闪光。40次连续闪光后,要让闪光灯至少冷却10分钟。
- 如您在进行超过40次连续闪光后马上继续进行更多次闪光,内部的防过热功能可能会被激活,如果发生这种现象,请让闪光灯冷却约10分钟,闪光灯便会恢复正常。
- 热保护启动后,显示屏上 的符号会显示。

激活热保护功能的连续闪光次数:

尺寸 档位	ZOOM (mm)	20	24	28	35	50	70	80	105	135	200
1/1		40	50	50	60	60	70	70	80	80	80
1/2		50	60	60	75	75	100	100	100	100	100
1/4		100	100	100	100	120	150	150	150	150	150
1/8		200	200	200	200	200	200	200	200	200	200
1/16		300	300	300	300	300	300	300	300	300	300
1/32		500	500	500	500	500	500	500	500	500	500
1/64		1000	1000	1000	1000	1000	1000	1000	1000	1000	1000
1/128		2000	2000	2000	2000	2000	2000	2000	2000	2000	2000
1/256		2000	2000	2000	2000	2000	2000	2000	2000	2000	2000

高速同步模式下,激活热保护功能的连续闪光次数:

尺寸 档位	ZOOM (mm)	20 - 200
1/1		30
1/2		30
1/4		34
1/8		40
1/16		50
1/32		50
1/64		60
1/128		60

2. 其他保护

- 为了保证设备安全的工作,系统时刻进行预防保护,以下提示符号供您参考:

LCD显示	警示内容
E1	闪光灯回电系统出现问题,无法回电引闪,请重新开机,如无法解决请维修
E2	设备内温度过高,请停止引闪10分钟
E3	闪光灯管两端电压过高,请维修
E9	固件升级有误,请进行正确固件升级

规格参数

型号	TT685HS
兼容相机	SONY索尼数码相机单反反光相机
闪光指数(1/1档位, 200mm焦距)	GN≈60 (ISO100) (以米为单位)
闪光覆盖范围	20-200毫米
	•自动变焦(自动设置适合镜头焦距和图像尺寸的闪光覆盖范围) •手动变焦 •闪光灯头旋转/倾斜, 水平0-330°, 垂直-7°-120°(反射闪光)
闪光持续时间	1/300秒-1/20000秒
• 曝光控制	
曝光控制系统	TTL自动闪光、手动闪光
闪光曝光补偿(FEC)	手动, 闪光包围曝光: 在±3档间以1/3档为增量调节 (可以组合使用手动闪光曝光补偿)
同步方式	高速同步(最高1/8000秒), 前帘同步, 后帘同步
频闪闪光	具备(次数: 90次; 100Hz)
• 无线闪光(无线电2.4G传输)	
无线功能	主控单元, 从属单元, 关闭
主控单元组	M,A,B,C
可控制从属单元组	A,B,C,D,E(E组可使用X系列的引闪器控制)
传输范围(约)	100m
频道	32组: 01-32
ID	01-99
• 自动对焦辅助光	
有效范围(约)	中央: 0.6-10米 / 边缘: 0.6-5米
• 电源	
AA电池	镍氢电池(推荐)或LR6类型碱性电池*4节
回电时间	0.1-2.6s
全功率闪光次数	约290次(镍氢充电电池)
节能	闪光灯在无人操作90秒左右将会自动关闭电源。 设置为从属单元时60分钟进入休眠状态。
工作环境温度	-10°C-50°C
• 同步触发方式	热靴, 2.5mm同步线
• 尺寸	
体积	64*76*190 mm
净重(不含电池)	405g
重量(含电池)	489g

故障排除指南

如果遇到问题, 请参阅此故障排除指南。

闪光灯不闪光。

- 闪光灯没有牢固地安装在相机上。
→将闪光灯的固定座牢固地安装在相机上。
- 闪光灯和相机的电子触点变脏。
→请清洁触点。

电源自动关闭。

- 当灯作为主控单元时, 90秒无操作后, 自动电源关闭功能生效。
→半按快门按钮或机身任意按键唤醒。

- 作为从属单元在60分钟(或者选择30分钟)无任何操作时, 闪光灯会进入休眠状态。
→可按机身任意按键唤醒。

自动变焦不工作。

- 闪光灯没有牢固地安装在相机上。
→将闪光灯的固定座牢固地安装在相机上。

闪光曝光不足或过度。

- 使用高速同步。
→使用高速同步, 有效的闪光范围会更小。确保被摄体位于显示的有效闪光范围内。
- 闪光灯使用手动曝光模式。
→改为TTL模式或修改闪光输出功率设置。

相片出现暗角或者被摄物体只有局部能照亮。

- 相机镜头焦距超出闪光灯的覆盖范围。
→请检查闪光灯当前的覆盖焦距。本产品的灯头变焦范围是中画幅系统的20-200mm。

固件升级

- 本产品USB接口为Type-C接口, 请使用Type-C USB线。
- 产品升级固件需要Godox G3程序软件支持, 升级固件前请先下载安装“Godox G3固件升级软件”再选择相应的固件文件。
- 由于产品进行固件升级, 说明书请以最新电子版为准。

兼容相机列表

本机可兼容以下索尼系列的相机型号:

A73 A9 A7R3 a77II a99 RX10 a6000 A7R

注:

1. 此表格仅列举目前已测试的相机型号, 未涵盖所有索尼系列相机。其他相机型号, 用户可自行测试。
2. 本公司保留未来修改此表格内容的权利。

维护保养

- 闪光灯在工作时, 如发现异常, 应立即关掉电源, 查明原因。
- 灯体应避免震动, 平时注意表面除尘。
- 灯体稍有发热为正常现象, 无特别需要时, 勿连续引闪。
- 闪光灯的所有维修概由本厂指定可供原厂配件之维修部负责。
- 1年保修, 消耗品如灯管等, 不在1年保修范围。
- 经发现, 擅自检修此闪光灯的, 将取消闪光灯之一年保修期, 维修需要收取相关费用。
- 如果本品出现故障或者被水淋湿, 在专业人员维修后方可继续使用。
- 如有技术更改, 恕不另行通知。

Foreword

Thank you for purchasing this product.

This TT685IIS camera flash applies to Sony series cameras and is compatible with TTL autofocus. With this TTL compatible flash, your shooting will become simpler. You can easily achieve a correct flash exposure even in complex light-changing environments. This camera flash features:

- Approx. GN60 (ISO 100, @200mm), 81 steps from 1/1 to 1/256.
- Fully support Sony TTL camera flash. Workable as Transmitter or Receiver unit in a wireless flash group.
- Use dot-matrix LCD panel to make clear and convenient operations.
- With built-in 2.4GHz wireless remote system to support transmitting and receiving.
- Provided multiple functions, include HSS (up to 1/8000s), FEC, FEB, etc.
- Stable consistency and color temperature with good even lighting.
- Support with firmware upgrade.

⚠ Warning

- ⚠ Always keep this product dry. Do not use in rain or in damp conditions.
- ⚠ Do not disassemble. Should repairs become necessary, this product must be sent to an authorized maintenance center.
- ⚠ Keep out of reach of children.
Stop using this product if it breaks open due to extrusion, falling or strong hit. Otherwise, electric shock may occur if you touch the electronic parts inside it.
- ⚠ Do not fire the flash directly into the eyes (especially those of babies) within short distances. Otherwise visual impairment may occur.
- ⚠ Do not use the flash unit in the presence of flammable gases, chemicals and other similar materials. In certain circumstance, these materials may be sensitive to the strong light emitting from this flash unit and fire or electromagnetic interference may result.
- ⚠ Do not leave or store the flash unit if the ambient temperature reads over 50°C. Otherwise the electronic parts may be damaged.
- ⚠ Turn off the flash unit immediately in the event of malfunction.

Conventions used in this Manual

- This manual is based on the assumption that both the camera and camera flash's power switches are powered on.
- Reference page numbers are indicated by "p.**".
- The following alert symbols are used in this manual:
 - ⚠ The Caution symbol indicates a warning to prevent shooting problem.
 - 📌 The Note symbol gives supplemental information.

Contents

26	Foreword
26	Warning
28	Name of Parts
	Body
	Control Panel
	LCD Panel
	LCD Panel in Three Modes
	What's in the Box of TT685IIS Kit?
	Separately Sold Accessories
	Loading and Unloading the Battery
28	Attaching to a Camera
28	Power Management
29	Flash Mode – TTL Autoflash
	📌 FEC (Flash Exposure Compensation)
	📌 High-Speed Sync
	📌 Second-Curtain Sync
30	M: Manual Flash
31	Multi: Stroboscopic Flash
33	Wireless Flash Shooting: Radio (2.4G) Transmission
	Wireless Settings
	Setting the Communication Channel
	Wireless ID Settings
	Scan the Spare Channel
	TTL: Fully Automatic Wireless Flash Shooting
	M: Wireless Flash Shooting with Manual Flash
	Multi: Wireless Flash Shooting with Manual Flash
39	Other Applications
	Sync Triggering
	Auto Focus Assist Beam
	Bounce Flash
	ZOOM: Setting the Flash Coverage
	Low Battery Warning
41	C.Fn: Setting Custom Functions
42	Protection Function
43	Technical Data
44	Troubleshooting
45	Firmware Upgrade
45	Compatible Camera Models
45	Maintenance

Name of Parts

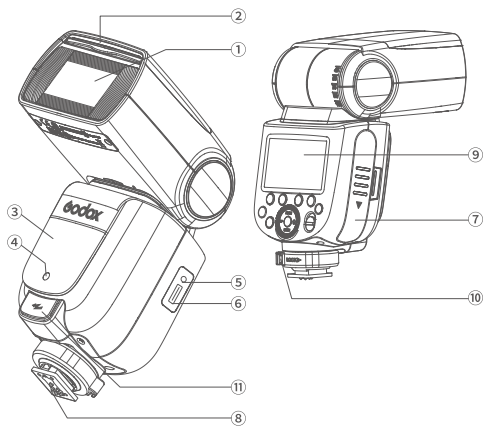

● Body

- 01. Flash Head
- 02. Built-in Wide Panel
- 03. Wireless Sensor
- 04. Focus Assist Beam
- 05. Sync Cord Jack
- 06. Type-C USB Port
- 07. Battery Cover
- 08. Hotshoe
- 09. LCD Panel
- 10. Hotshoe Fixing Buckle
- 11. External Charging Port

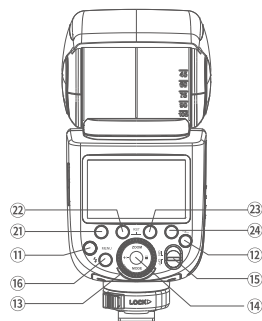
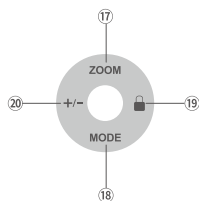

● Control Panel

- 11. <MENU>Flash Menu Button
- 12. <Z>Wireless Selection Button
- 13. Select Dial
- 14. Set Button
- 15. ON/OFF Power Switch
- 16. <L> Test Button / Flash Ready Indicator
- 17. <ZOOM> Focus Length Setting
- 18. <MODE>Mode Selection Button
- 19. <L>Lock Setting
- 20. <+/->Power Output
- 21. Function Button 1
- 22. Function Button 2
- 23. Function Button 3
- 24. Function Button 4

● LCD Panel

(1)TTL Autoflash

Zoom : zoom display (Page 40)

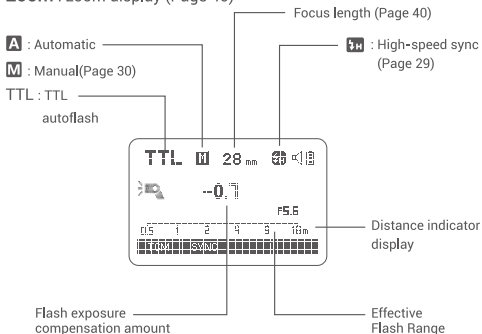

- The display will only show the settings currently applied.
- The functions displayed above function buttons 1 to 4, such as <SYNC> and <M/A/B/C>, change according to settings' status.
- The LCD panel will lighten on when buttons and dials are operated.

(2)M Manual Flash

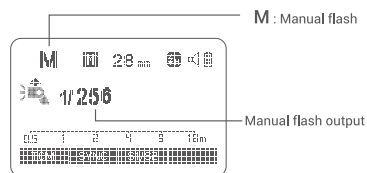

(3)Multi Flash

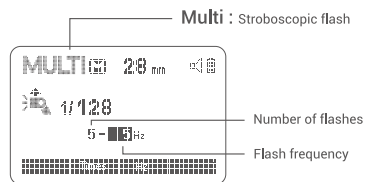

(4) Radio Transmission Shooting

● Transmitter Unit (TX)

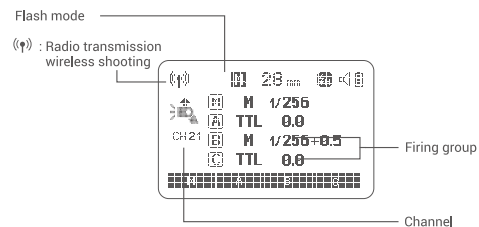

● Receiver Unit (RX)

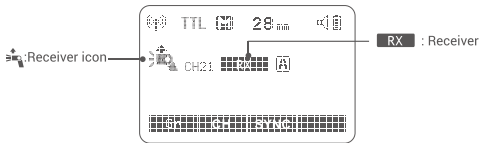

● LCD Panel in Three Modes

● Attached to the Camera

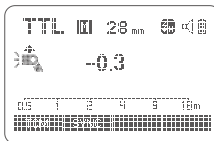

● 2.4G Radio Transmission: As a Transmitter Unit

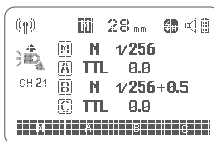

● 2.4G Radio Transmission: As a Receiver Unit



● What's in the Box of TT685IIS Kit?

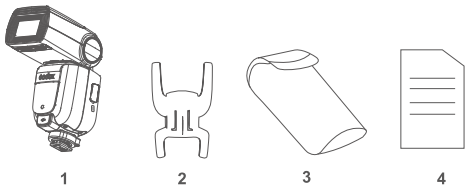

1. Flash Unit 2. Mini Stand 3. Protection Case 4. Instruction Manual

● Separately Sold Accessories

The product can be used in combination with the following accessories sold separately, so as to achieve best photography effects: XProS, X2T-S & X1S TTL wireless flash trigger, etc.

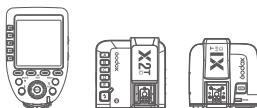

● Loading and Unloading the Battery

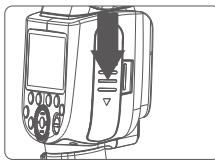

1 To unload the battery, hold down the battery and press compartment and push the battery downwardly to take it out.

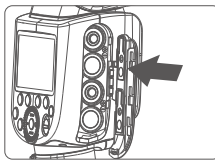

2 Put 4 batteries in with the correct polarity after opening the battery compartment, then close and push it to the top.

Tips: When collocated with the optional Godox Flash Power Box PB960, TT685IIS will have more flash times, shorter recycle time and longer duration.

Attaching to a Camera

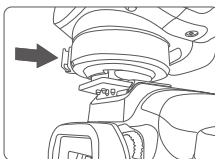

1 Attach the Camera Flash.

- Rotate the hotshoe fixing buckle to the left and insert the camera flash into the camera's hotshoe.

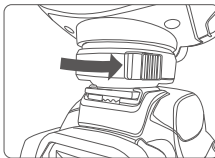

2 Secure the Camera Flash.

- Rotate the hotshoe fixing buckle to the right until it locks up.

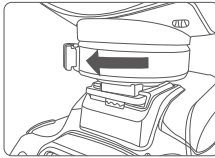

3 Detach the Camera Flash.

- Press the button and rotate the hotshoe fixing buckle to the left until it is loosened.

Power Management

Use ON/OFF Power Switch to power the flash unit on or off. Turn off if it will not be used for an extended period of time. Setting as a transmitter flash, it will turn the power off automatically after a certain period (approx. 90 seconds) of idle use. Pressing the camera shutter halfway or pressing any flash button will wake up the flash unit. Setting as a receiver flash, it will enter sleep mode after a certain period (adjustable, 60 minutes by default) of idle use. Pressing any flash button will wake it up.

C.Fn Disabling Auto Power Off function is recommended when the flash is used off camera. (C.Fn-STBY, Page 41)

C.Fn Receiver Auto Power Off Timer is set to 60 minutes by default. Another option "30 minutes" is available. (C.Fn-RX STBY, Page 41)

Flash Mode—TTL Autoflash

This flash has three flash modes: TTL, Manual (M), and Multi (Stroboscopic). In TTL mode, the camera and the flash will work together to calculate the correct exposure for the subject and the background. In this mode, multiple TTL functions are available: FEC, FEL, HSS, second curtain sync, control with Sony camera's menu screen.

• Press <MODE> Mode Selection Button and three flash modes will display on the LCD panel one by one with each pressing.

TTL Mode

Press <MODE> Mode Selection Button to enter TTL mode. The LCD panel will display.

- Press the camera release button halfway to focus. The aperture and effective flash range will be displayed in the viewfinder.
- When the shutter button is fully pressed, the flash will fire a pre-flash that the camera will use to calculate exposure and flash output the instant before the photo is taken.

FEC: Flash Exposure Compensation

With FEC function, this flash can adjust from -3 to +3 in 1/3rd stops. It is useful in situations where minor adjusting of the TTL system is needed based on the environment.

FEC Setting:

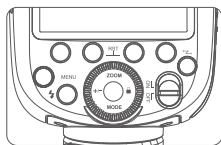

- 1 Press the <+/-> button. The flash exposure compensation amount will be highlighted on the LCD panel.



- 2 Set the flash exposure compensation amount.
 - Turn the Select Dial to set the amount.
 - "0.3" means 1/3 step, "0.7" means 2/3 step.
 - To cancel the flash exposure compensation, set the amount to "+0".

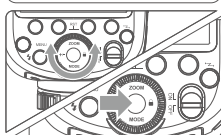

- 3 Press Set Button again to confirm the setting.

High-Speed Sync

High Speed Sync (FP flash) enables the flash to synchronize with all camera shutter speeds. This is convenient when you want to use aperture priority for fill-flash portraits.

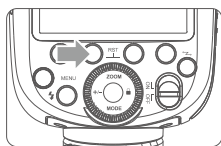

- 1 Press Function Button 2 <SYNCR> so that <H> is displayed.

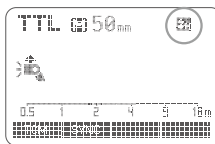

- 2 Press MENU or Fn button on SONY camera to enter Flash Mode and choose Fill-flash, then set the camera hutter.

- If you set a shutter speed that is the same as or slower than the camera's maximum flash sync speed, <+/-> will not be displayed in the viewfinder.
- With high-speed sync, the faster the shutter speed, the shorter the effective flash range.
- To return to normal flash, press <SYNCR> button again. Then <H> will disappear.
- Multi flash mode cannot be set in high-speed sync mode.
- Over-temperature protection may be activated after 15 consecutive high-speed sync flashes.

Second-Curtain Sync

With a slow shutter speed, you can create a light train following the subject. The flash fires right before the shutter closes.

Choose REAR flash mode in the settings of Sony camera.

M: Manual Flash

The flash output is adjustable from 1/1 full power to 1/256th power in 1/10th stop increments. To obtain a correct flash exposure, use a hand-held flash meter to determine the required flash output.

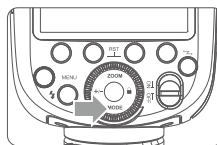

- 1 Press <MODE> button so that <M> is displayed.

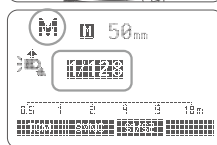

- 2 Press <+/-> to choose power, then turn the Select Dial to choose a desired flash output amount.

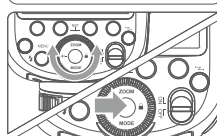

- 2 Press Set Button again to confirm the setting.

Optic S1 Secondary Unit Setting

In M manual flash mode, press <S1/S2> button so that this flash can function as an optic S1 secondary flash with optic sensor. With this function, the flash will fire synchronously when the main flash fires, the same effect as that by the use of radio triggers. This helps create multiple lighting effects.

Optic S2 Secondary Unit Setting

Press <S1/S2> button so that this flash can also function as an optic S2 secondary flash with optic sensor in M manual flash mode. This is useful when cameras have pre-flash function. With this function, the flash will ignore a single "pre-flash" from the main flash and will only fire in response to the second, actual flash from the main unit.

- S1 and S2 optic triggering is only available in M manual flash mode.

Multi: Stroboscopic Flash

With stroboscopic flash, a rapid series of flashes is fired. It can be used to capture a multiple images of a moving subject in a single photograph.

You can set the firing frequency (number of flashes per sec. expressed as Hz), the number of flashes, and the flash output.

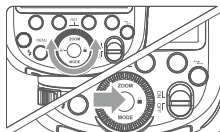
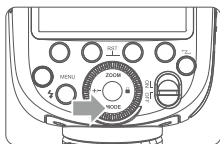

1 Press <MODE> button so that **1** <MULTI> is displayed.

2 Set the flash frequency and flash times.

- Press the Function Button 2 <Times> to select the flash times. Turn the Select Dial to set the number.

- Press the Function Button 3 <Hz> to select the flash frequency. Turn the Select Dial to set the number.

3 Turn the Select Dial to choose a desired flash output. After you finish the setting, press Set Button and all the settings will be displayed.

Calculating the Shutter Speed

During stroboscopic flash, the shutter remains open until the firing stops. Use the formula below to calculate the shutter speed and set it with the camera.

$$\text{Number of Flashes / Flash Frequency} = \text{Shutter Speed}$$

For example, if the number of flashes is 10 and the firing frequency is 5 Hz, the shutter speed should be at least 2 seconds.

- ⚠ To avoid overheating and deteriorating the flash head, do not use stroboscopic flash more than 10 times in succession. After 10 times, allow the camera flash to rest for at least 15 minutes. If you try to use the stroboscopic flash more than 10 times in succession, the firing might stop automatically to protect the flash head. If this happens, allow at least 15 minutes' rest for the camera flash.

- Stroboscopic flash is most effective with a highly reflective subject against a dark background.
- Using a tripod and a remote control is recommended.
- A flash output of 1/1 and 1/2 cannot be set for stroboscopic flash.
- Stroboscopic flash can be used with "buLb".
- If the number of flashes is displayed as "--", the firing will continue until the shutter closes or the battery is exhausted. The number of flashes will be limited as shown by the following table.

Maximum Stroboscopic Flashes:

Flash output \ Hz	1	2	3	4	5	6-7	8-9
1/4	8	6	4	3	3	2	2
1/8	14	14	12	10	8	6	5
1/16	30	30	30	20	20	20	10
1/32	60	60	60	50	50	40	30
1/64	90	90	90	80	80	70	60
1/128	90	90	90	90	90	90	80
1/256	90	90	90	90	90	90	80

Flash output \ Hz	10	20-50	60-100
1/4	2	2	2
1/8	4	4	4
1/16	8	8	8
1/32	20	16	12
1/64	50	30	20
1/128	70	40	40
1/256	70	40	40

Wireless Flash Shooting: Radio (2.4G) Transmission

- The **TT685IIS** attach to the camera is called the transmitter unit, and a TT685IIS that is wirelessly controlled is called the receiver unit.
- You can also wirelessly control the **TT685IIS** set as the receiver unit with the transmitter X1T-C (sold separately). For details on setting the transmitter unit functions, see the transmitter's instructions.

Using a flash (transmitter/receiver) with a radio transmission wireless shooting function make it easy to shoot with advanced wireless multiple flash lighting, in the same way as TTL autoflash shooting.

The basic relative position and operation range are as shown in the picture. You can then perform wireless TTL autoflash shooting just by setting the transmitter unit to <TTL>.

Positioning and Operation Range (Example of wireless flash shooting)

● Autoflash Shooting with One Receiver Unit

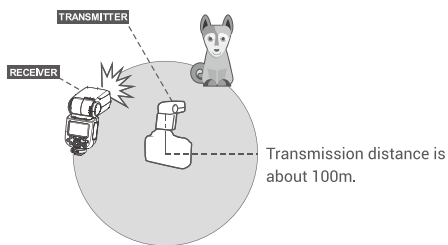

- Use the supplied mini stand to position the Receiver unit.
- Before shooting, perform a test flash and test shooting.
- The transmission distance might be shorter depending on the conditions such as positioning of Receiver units, the surrounding environment and whether conditions.

Wireless Multiple Flash Shooting

You can divide the Receiver units into two or three groups and perform TTL autoflash while changing the flash ratio (factor). In addition, you can set and shoot with a different flash mode for each firing group, for up to 4 groups.

● Auto Shooting with Two Receiver Groups

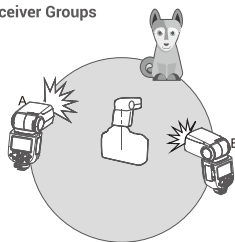

● Auto Shooting with Three Receiver Groups

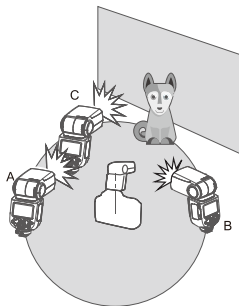

1. Wireless Settings

You can switch between normal flash and wireless flash. For normal flash shooting, be sure to set the wireless setting to OFF.

Transmitter Unit Setting

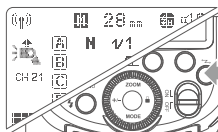

Press < +z. > button so that < () > is displayed on the LCD panel.

Receiver Unit Setting

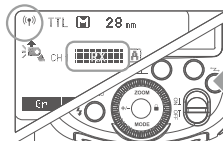

Press < +z. > button so that < () > or < () > are displayed on the LCD panel.

2. Setting the Communication Channel

If there are other wireless flash systems nearby, you can change the channel IDs to prevent signal interference. The channel IDs of the Transmitter unit and the Receiver unit(s) must be set to the same.

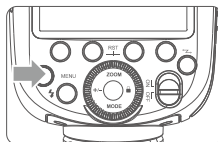

1 Press <MENU> Button to enter C.Fn CH setting.

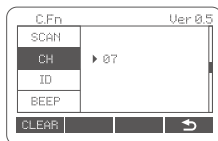

2 In C.Fn CH, turn the Select Dial to choose channel ID from 1 to 32.

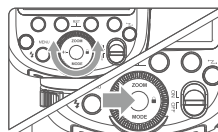

3 Press the Set Button to confirm.

3. Wireless ID Settings

Change the wireless channels and wireless ID to avoid interference for it can only be triggered after the wireless IDs and channels of the Transmitter unit and the Receiver unit are set to the same. Press the <MENU> button to enter C.Fn ID. Press the Set Button to choose OFF channel expansion shutdown, and choose any figure from 01 to 99.

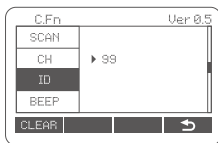

4. Scan the Spare Channel

To avoid the interference of using the same channel by others, this function can be used: enter the C.Fn settings and find the **SCAN** option. When setting it to **START**, it will scan from 1% to 100%. And the 8 spare channels will be displayed after the scan is completed.

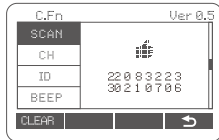

5. TTL: Fully Automatic Wireless Flash Shooting

Using Automatic Wireless Flash with a Single Receiver Unit

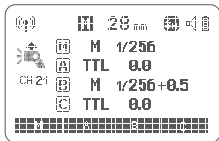

- 1 **Transmitter Unit Setting**
 - Attach a TT685IS camera flash on the camera and set it as the Transmitter unit. M/A/B/C can be set as TTL respectively.
- 2 **Receiver Unit Setting**
 - Set wireless controlled TT685IS as the wireless Receiver Unit. (Page 39)
- 3 **Check the communication channel.**
 - If the Transmitter unit and Receiver unit(s) are set to a different channel, set them to the same channel. (Page 40)
- 4 **Position the camera and flashes.**
 - Position the camera and flashes as the picture shows. (Page 38)
- 5 **Check that the flash is ready.**
 - Check that the Transmitter flash ready indicator is lightened.
- 6 **Check the flash operation.**
 - Press the Transmitter unit's Test Button < ⚡ >.
 - Then, the Receiver unit will fire. If not, adjust the Receiver unit's angle toward the Transmitter unit and distance from the Transmitter unit.

Using Automatic Wireless Flash with Multiple Receiver Units

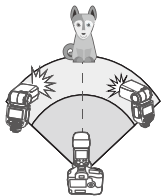

When stronger flash output or more convenient lighting operation is needed, increase the number of Receiver units and set it as a single Receiver unit. To add Receiver units, use the same steps as setting "automatic wireless flash with a single Receiver unit". Any flash group can be set (A/B/C/D/E). When the

number of Receiver units is increased and the Transmitter unit flash firing is ON, automatic control is implemented to make all groups of flashes fire the same flash output and ensure the total flash output up is to standard exposure.

- If the Receiver unit's auto power off function is workable, press the Transmitter unit's test button to power it on. Please note that test firing is unavailable during the camera's regular metering time.
 - The effective time of Receiver auto power off is changeable. (C.Fn-RX STBY Page 41)
 - By making some settings, the auto AF-assist transmitter will not blink after the Receiver unit's flash ready indicator is lightened. (C.Fn-AF Page 41)

Using Fully Automatic Wireless Flash

The FEC and other settings that set on the Transmitter unit will also be appeared on the Receiver unit automatically. The Receiver unit does not need any operation. Use the following settings to make wireless flashes according to the same methods with normal flash shooting.

- Flash Exposure Compensation (Page 29)

About the Transmitter Unit

Use two or more Transmitter units. By preparing several cameras that with Transmitter units flash attached, cameras can be changed in shooting while keeping the same lighting source (Receiver unit).

6. M: Wireless Flash Shooting with Manual Flash

This describes wireless (multiple shooting) using manual flash. You can shoot with a different flash output setting for each Receiver unit (firing group). Set all parameters on the Transmitter unit.

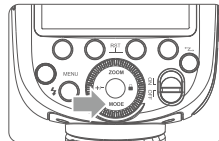

- 1 **Setting the flash mode to <M>.**

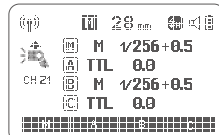

- 2 **Setting flash output.**
 - Press FunctionButton 1/2/3/4-<M/A/B/C>. Turn the Select Dial to set the flash output of the groups. Press Set Button to confirm.

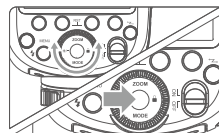

- 3 **Taking the picture.**
 - Each group fires at the set flash ratio.

Setting <M> Flash Mode

You can directly operate the Receiver unit to manually set the manual flash or stroboscopic flash.



1 Setting the Receiver unit.

2 Setting flash mode to <M>.

- Press <MODE> button so that <M> is displayed.
- Set the manual flash output. (Page 30)

7. Multi: Wireless Flash Shooting with Manual Flash

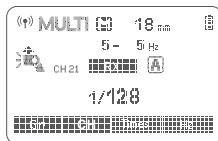

1. Setting <MULTI> stroboscopic flash.

- Press <MODE> button so that <MULTI> is displayed.
- Setting the stroboscopic flash. (Page 31)

⚠ The Reason & Solution of Not Triggering in Godox 2.4G Wireless

1. Disturbed by the 2.4G signal in outer environment (e.g. wireless base station, 2.4G wifi router, Bluetooth, etc.)

→ To adjust the channel CH setting on the flash trigger (add 10+ channels) and use the channel which is not disturbed. Or turn off the other 2.4G equipment in working.

2. Please make sure that whether the flash has finished its recycle or caught up with the continuous shooting speed or not (the flash ready indicator is lightened) and the flash is not under the state of over-heat protection or other abnormal situation.

→ Please downgrade the flash power output. If the flash is in TTL mode, please try to change it to M mode (a preflash is needed in TTL mode).

3. Whether the distance between the flash trigger and the flash is too close or not (< 0.5m)

→ Please turn on the "close distance wireless mode" on the flash trigger

X2 & X1 series: press the test button and hold on, then turning it on until the flash ready indicator blinks for 2 times.

XPro series: Set the C.Fn-DIST to 0-30m.

4. Whether the flash trigger and the receiver end equipment are in the low battery states or not

→ Please replace the battery (the flash trigger is recommended to use 1.5V disposable alkaline battery).

Other Applications

Sync Triggering

The Sync Cord Jack is a $\Phi 2.5\text{mm}$ plug. Insert a trigger plug here and the flash will be fired synchronously with the camera shutter.

Auto Focus Assist Beam

In poorly-lit or low-contrast shooting environments, the built-in auto focus assist beam will automatically light on to make it easier for autofocus. The beam will light up only when autofocus is difficult and get out as soon as the autofocus becomes correct.

If you want to turn off the auto focus assist beam, set the "AF" to "OFF" on the C.Fn settings.

- If you find the auto focus assist beam does not light up, this is because the camera has got a correct autofocus.

Position	Effective Range
Center	0.6~10m / 2.0~32.8 feet
Periphery	0.6~5m / 2.0~16.4 feet

Bounce Flash

By pointing the flash head toward a wall or ceiling, the flash will bounce off the surface before illuminating the subject. This can soften shadows behind the subject for a more natural-looking shot. This is called bounce flash.

To set the bounce direction, hold the flash head and turn it to a satisfying angle.

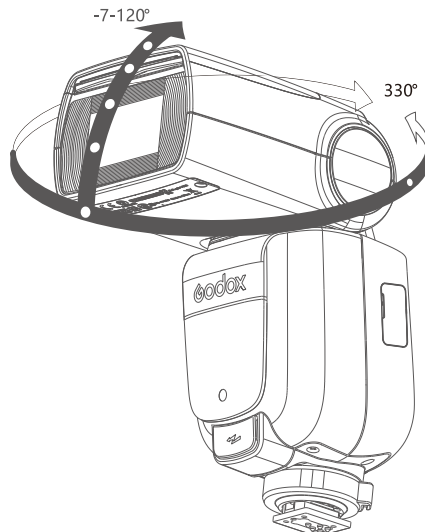

- If the wall or ceiling is too far away, the bounced flash might be too weak and result in underexposure.
- The wall or ceiling should be a plain, white color for high reflectance. If the bounce surface is not white, a color cast may appear in the picture.

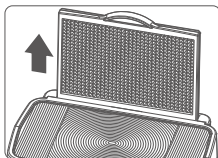

Creating a Catchlight

With the catchlight panel, you can create a catchlight in the subject's eyes to add life to the facial expression.

1. Point the flash head upward by 90°.

2. Pull out the wide panel.

The catchlight panel will come out at the same time.

3. Push the wide panel back in.

● Push in only the wide panel.

● Follow the same procedures as for bounce flash.

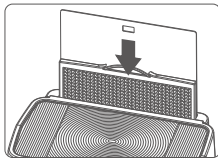

Notes:

● Point the flash head straight ahead and then upward by 90°. The catchlight will not appear if you swing the flash head left or right.

● For maximum catchlight effect, stay 1.5m/4.9ft away from the subject.

ZOOM: Setting the Flash Coverage

The flash coverage can be set automatically or manually. It can be set to match the lens focal length from 20mm to 200mm.

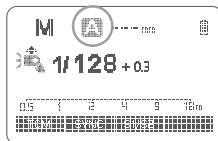

In Manual Zoom mode, press the <ZOOM> button.

● Turn the Select Dial to change the flash coverage.

● If <A> is displayed, the flash coverage will be set automatically.

■ If you set the flash coverage manually, make sure it covers the lens focal length so that the picture will not have a dark periphery.

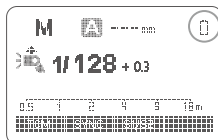

Low Battery Warning

If the battery power is low, < battery icon > will appear and blink on the LCD panel. Please replace the battery immediately.

C.Fn: Setting Custom Functions

The following table lists the available and unavailable custom functions of this flash.

C.Fn Custom Functions

Custom Function Signs	Function	Setting No.	Settings & Description

m/ft	Distance indicator	m	m
		ft	feet
AF	AF-assist beam RX	ON	ON
		OFF	OFF
STBY	Auto sleep setting	ON	ON
		OFF	OFF
RX STBY	Receiver auto power off timer	60min	60min
		30min	30min
SCAN	Scan the spare channel	OFF	OFF
		START	Start to find the spare channel
CH	Channel setting	01 ~ 32	Choose channels from 01-32
ID	Wireless ID	OFF	Off
		01-99	Choose any figure from 01-99
BEEP	Beeper	ON	ON
		OFF	OFF
LIGHT	Backlighting time	12sec	Off in 12 sec.
		OFF	Always off
		ON	Always lighting
LCD	LCD contrast ratio	-3--+3	7 levels
TX DIST	Firing distance	1-100m	1-100m firing
		0-30m	0-30m firing

1. Press<MENU> Button until C,Fn menu is displayed. The "Ver x.x" in the top-right corner refers to the software version.

2. Select the Custom Function No.

● Turn the Select Dial to select the Custom Function No.

3. Change the Setting.

● Press Set Button and the Setting No. blinks.

● Turn the Select Dial to set the desired number. Pressing Set Button will confirm the settings.

● After you set the Custom Function and press <MENU> button, the camera will be ready to shoot.

4. In the C.Fn states, long press the "Clear" button for 2 seconds until "OK" is displayed on the panel, which means the values in C.Fn can be reset.

Protection Function

1. Over-Temperature Protection

● To avoid overheating and deteriorating the flash head, do not fire more than 40 continuous flashes in fast succession at 1/1 full power. After 40 continuous flashes, allow a rest time of at least 10 minutes.

● If you fire more than 40 continuous flashes and then fire more flashes in short intervals, the inner over-temperature protection function may be activated. If this occurs, allow a rest time of about 10 minutes, and the flash unit will then return to normal.

● When the over-temperature protection is started,  is shown on the LCD display.

Number of flashes that will activate over-temperature protection:

Number of Flashes Power Output Level	ZOOM (mm)										
	20	24	28	35	50	70	80	105	135	200	
1/1	40	50	50	60	60	70	70	80	80	80	
1/2	50	60	60	75	75	100	100	100	100	100	
1/4	100	100	100	100	120	150	150	150	150	150	
1/8	200	200	200	200	200	200	200	200	200	200	
1/16	300	300	300	300	300	300	300	300	300	300	
1/32	500	500	500	500	500	500	500	500	500	500	
1/64	1000	1000	1000	1000	1000	1000	1000	1000	1000	1000	
1/128	2000	2000	2000	2000	2000	2000	2000	2000	2000	2000	
1/256	2000	2000	2000	2000	2000	2000	2000	2000	2000	2000	

Number of flashes that will activate over-temperature protection in high-speed sync triggering mode:

Number of Flashes Power Output Level	ZOOM (mm)	
	20	200
1/1	30	
1/2	30	
1/4	34	
1/8	40	

Number of Flashes Power Output Level	ZOOM (mm)	
	20	200
1/16	50	
1/32	50	
1/64	60	
1/128	60	

2. Other Protections

The system provides real-time protection to secure the device and your safety. The following lists prompts for your reference:

Prompts on LCD Panel	Meaning
E1	A failure occurs on the recycling system so that the flash cannot fire. Please restart the flash unit. If the problem still exists, please send this product to a maintenance center.
E2	The system gets excessive heat. Please allow a rest time of 10 minutes.
E3	The voltage on two outlets of the flash tube is too high. Please send this product to a maintenance center.
E9	There are some errors occurred during the upgrading process. Please using the correct firmware upgrade method.

Technical Data

Model	TT685IIS
Compatible Cameras	Sony single-lens reflex camera
Guide No.(1/1 output, 200mm)	GN=60 (m ISO100, in meters)
Flash Coverage	20 to 200mm
	• Auto zoom (Flash coverage set automatically to match the lens focal length and image size) Manual zoom • Swinging/tilting flash head (bounce flash): 0 to 330° horizontally and -7° to 120° vertically
Flash Duration	1/300 to 1/20000 seconds

• Exposure Control	
Exposure control system	TTL autoflash and manual flash
Flash exposure compensation (FEC)	Manual, FEB: 43 stops in 1/3 stop increments (Manual FEC and FEB can be combined.)
Sync mode	High-speed sync (up to 1/8000 seconds), first-curtain sync, and second-curtain sync
Multi flash	Provided (up to 90 times, 100Hz)
• Wireless Flash (2.4G Radio Transmission)	
Wireless flash function	Transmitter, Receiver, Off
Transmitter groups	M,A,B,C
Controllable Receiver groups	A, B, C, D, E (E group can be controlled by X series flash trigger)
Transmission range (approx.)	100m
Channels	32 (1~32)
ID	01~99
• Auto Focus Assist Beam	
Effective range (approx.)	Center: 0.6~10m
	Periphery: 0.6~5m
• Power Supply	
Power source	Ni-MH battery (recommended) or LR6 alkaline battery*4
Recycle time	0.1-2.6s (Rechargeable Ni-MH Battery)
Full power flashes	About 290 times
Power saving	Power off automatically after approx. 90 seconds of idle operation, (60 minutes if set as Receiver)
• Sync Triggering Mode	
Working temperature	Hotshoe, 2.5mm sync line -10 C -50 C

• Dimensions	
W x H x D	64*76*190 mm
Weight without battery	405g
Weight with battery	489g
2.4G Frequency Range	2413.0MHz-2465.0MHz
Max. Transmitting Power	5dbm

Troubleshooting

If there is a problem, refer to this Troubleshooting Guide.

The Camera Flash does not fire.

- The camera flash is not attached securely to the camera.
→ Attach the camera's mounting foot securely to the camera.
- The electrical contacts of the Camera Flash and camera are dirty.
→ Clean the contacts.

The power turns off by itself.

- After 90 seconds of idle operation, auto power off took effect if the flash is set as Transmitter.
→ Press the shutter button halfway or press any flash button to wake up.
- After 60 minutes (or 30 minutes) of idle operation, the flash unit will enter sleep mode if it is set as Receiver.
→ Press any flash button to wake up.

Auto zoom does not work.

- The camera flash is not attached securely to the camera.
→ Attach the camera flash's mounting foot to the camera.

The flash exposure is underexposed or overexposed.

- You used high-speed sync.
→With high-speed sync, the effective flash range will be shorter.
- Make sure the subject is within the effective flash range displayed.
- You used Manual Flash mode.
→Set the flash mode to TTL or modify the flash output.

Photos have dark corners or only parts of the target subject are illuminated.

- The focal length of lens exceeds the flash coverage.
→Check the flash coverage you set. This flash unit has the flash coverage between 20 and 200mm, which fits medium-format cameras.

Firmware Upgrade

- The USB port is a Type-C USB socket. Type-C USB connection line is applicable.
- As the firmware upgrade needs the support of Godox G3 software, please download and install the "Godox G3 firmware upgrade software" before upgrading. Then, choose the related firmware file.
- As the product needs to do firmware upgrade, please refer to instruction manual of the newest electric version as final.

Compatible Camera Models

This flash unit can be used on the following Sony series camera models:

A73 A9 A7R3 a77II a99 RX10 a6000 A7R

ⓘ This table only lists the tested camera models, not all Sony EOS series cameras. For the compatibility of other camera models, a self-test is recommended.
Rights to modify this table are retained.

Maintenance

- Shut down the device immediately should abnormal operation be detected.
- Avoid sudden impacts and the product should be dedusted regularly.
- It is normal for the flash tube to be warm when in use. Avoid continuous flashes if unnecessary.
- Maintenance of the flash must be performed by our authorized maintenance department which can provide original accessories.
- This product, except consumables e.g. flash tube, is supported with a one-year warranty.
- Unauthorized service will void the warranty.
- If the product had failures or was wetted, do not use it until it is repaired by professionals.
- Changes made to the specifications or designs may not be reflected in this manual.

FCC Statement

This device complies with part 15 of the FCC Rules. Operation is subject to the following two conditions: (1) This device may not cause harmful interference, and (2) this device must accept any interference received, including interference that may cause undesired operation.

Any Changes or modifications not expressly approved by the party responsible for compliance could void the user's authority to operate the equipment.

Note: This equipment has been tested and found to comply with the limits for a Class B digital device, pursuant to part 15 of the FCC Rules. These limits are designed to provide reasonable protection against harmful interference in a residential installation. This equipment generates uses and can radiate radio frequency energy and, if not installed and used in accordance with the instructions, may cause harmful interference to radio communications. However, there is no guarantee that interference will not occur in a particular installation. If this equipment does cause harmful interference to radio or television reception, which can be determined by turning the equipment off and on, the user is encouraged to try to correct the interference by one or more of the following measures:

- Reorient or relocate the receiving antenna.
- Increase the separation between the equipment and receiver.
- Connect the equipment into an outlet on a circuit different from that to which the receiver is connected.
- Consult the dealer or an experienced radio/TV technician for help.

The device has been evaluated to meet general RF exposure requirement.

The device can be used in portable exposure condition without restriction.

Warning

Operating frequency:2412.99MHz-2464.49MHz
Maximum EIRP Power:4.94dBm

Declaration of Conformity:

GODOX Photo Equipment Co.,Ltd. hereby declares that this equipment are in compliance with the essential requirements and other relevant provisions of Directive 2014/53/EU. In accordance with Article 10(2) and Article 10(10), this product is allowed to be used in all EU member states.For more information of DoC, Please click this web link:
https://www.godox.com/DOC/Godox_TT685II_Series_DOC.pdf.
The device complies with RF specifications when the device used at 0mm from your body.

产品保修

尊敬的用户,本保修卡是申请保修服务的重要凭证,请您配合销售商填写并妥善保管,谢谢!

产品信息	型号	产品条码
用户信息	姓名	联系电话
	通信地址	
销售商信息	名称	
	联系电话	
	通信地址	
	销售日期	
备注		

注:此表应由销售商盖章确认。

适用产品

本文件适用于相关《产品保修信息》(后面说明)所列产品,其他非属此范围的产品或部件(如促销品、赠品及其他出厂后附加的部件等)不在此保修承诺内。

保修期

产品及部件的相应保修期按相关的《产品保修信息》执行。保修期自产品首次购买日起算,购买日以购买产品时保修卡登记日期为准。

如何获得保修服务

要保修服务,您可直接与销售商或授权服务机构联系,也可拨打神牛产品售后服务电话,与我们联系,由我们的服务人员为您安排服务。申请保修时,您应提供有效的保修卡作为保修凭证,方可获得保修。如您不能提供有效的保修卡,则在我们可确认产品或部件属于保修范围的情况下,也可以为您提供保修,但这不作为我们的义务。

不适用保修的情况

如产品存在下情况,本文件项下的保证和服务将不适用 ①产品或部件超过相应保修期;②错误或不适当使用、维护或保管导致的故障或损坏,如:不当搬运;非按产品合理预期用途使用;不当插拔外接设备;跌落或外力挤压;接触或暴露于不当温度、溶剂、酸碱、水浸或潮湿环境;③由非神牛授权机构或人员安装、修理、更改、添加或拆卸造成的故障或损坏;④产品或部件原有识别信息被修改变更或删除;⑤无有效保修卡;⑥使用非合法授权、非标准或非公开发行的软件造成的故障或损坏;⑦因不可抗力或意外事件造成的故障或损坏;⑧其他非因产品本身质量问题导致的故障或损坏。遇上述情况,您应向相关责任方寻求解决,神牛对此不承担任何责任。因非在保修期或保修范围内的部件、附件或软件导致产品不能正常使用的,不是保修范围内的故障。产品使用过程中正常的褪色,磨损和消耗,不是保修范围内的故障。

产品保修和服务支持信息

产品的保修期和服务类型按以下《产品保修信息》执行:

产品类别	选件名称	保修期(月)	保修服务类型
部件	电路板	12	客户送修
	电池	3	客户送修
	充电器、电源线、同步线等带电性能的部件。	12	客户送修
	其他	如闪光灯、造型灯泡、外壳、保护罩、锁紧装置、包装等。	无

神牛产品售后服务电话 0755-29609320-8062

Warranty

Dear customers, as this warranty card is an important certificate to apply for our maintenance service, please fill in the following form in coordination with the seller and safekeep it. Thank you!

Product Information	Model	Product Code Number
Customer Information	Name	Contact Number
	Address	
Seller Information	Name	
	Contact Number	
	Address	
	Date of Sale	
Note:		

Note: This form shall be sealed by the seller.

Applicable Products

The document applies to the products listed on the Product Maintenance Information (see below for further information). Other products or accessories (e.g. promotional items, giveaways and additional accessories attached, etc.) are not included in this warranty scope.

Warranty Period

The warranty period of products and accessories is implemented according to the relevant Product Maintenance Information. The warranty period is calculated from the day (purchase date) when the product is bought for the first time. And the purchase date is considered as the date registered on the warranty card when buying the product.

How to Get the Maintenance Service

If maintenance service is needed, you can directly contact the product distributor or authorized service institutions. You can also contact the Godox after-sale service call and we will offer you service. When applying for maintenance service, you should provide valid warranty card. If you cannot provide valid warranty card, we may offer you maintenance service once confirmed that the product or accessory is involved in the maintenance scope, but that shall not be considered as our obligation.

Maintenance and Service Support Information

The warranty period and service types of products are implemented according to the following Product Maintenance Information:

Product Type	Name	Maintenance Period(month)	Warranty Service Type
Parts	Circuit Board	12	Customer sends the product to designated site
	Battery	3	Customer sends the product to designated site
	Electrical parts e.g. battery charger, power cord, sync cable, etc.	12	Customer sends the product to designated site
Other Items	Flash tube, modeling lamp, lamp body, lamp cover, locking device, package, etc.	No	Without warranty

Godox After-sale Service Call 0755-29609320-8062