

合格证  
QC PASS

# Godox



Wechat  
Official Account  
神牛微信公众号

## 深圳市神牛摄影器材有限公司

地址: 深圳市宝安区福海街道塘尾社区耀川工业区厂房2栋  
电话: 0755-29609320(8062) 传真: 0755-25723423 邮箱: godox@godox.com

## GODOX Photo Equipment Co.,Ltd.

Add.: Building 2, Yaochuan Industrial Zone, Tangwei Community, Fuhai Street, Bao'an District, Shenzhen 518103, China Tel: +86-755-29609320(8062) Fax: +86-755-25723423  
E-mail: godox@godox.com

[www.godox.com](http://www.godox.com)

Made in China | 705-LUXCAD-00

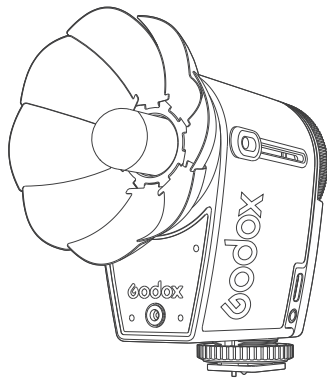

## LUX CADET

复古闪光灯  
Retro Camera Flash

使用手册  
Instruction Manual

## 重要安全提示

本产品属于专业摄影设备,需要专业人员操作使用。

使用时必须遵守以下基本安全预防措施:

使用前必须拆除产品上的所有运输保护材料和包装。

1. 使用本产品前,请仔细阅读并完全理解产品说明书,严格按照说明书中的安全提示操作。否则,可能导致死亡、严重伤害、产品损坏或其他财产损失的安全隐患。
2. 本产品为专业灯具,儿童禁止使用。儿童接近时,成人必须密切监督,防止儿童碰撞灯具或私自使用灯具,造成人身伤害。
3. 本灯具并非普通灯具,不可用于普通照明,任何有过眼部损伤或眼部敏感的人群均应避免使用本灯具或直视本灯具。
4. 使用时必须小心,严禁接触如闪光灯管等高温部件,以避免烫伤。
5. 任何情况下均禁止将闪光灯直接对准人眼(特别是婴儿眼睛),否则短时间内可能导致视力损伤。如感到眼睛不适,应立即关闭灯具,停止使用并及时就医。
6. 闪光灯管损坏时,应立即停止使用,及时联系制造商、服务代理商或合格维修人员更换,以防发生事故。
7. 严禁使用损坏的设备或配件,必须等待专业维修人员检查维修并确认设备正常后,才可继续使用。
8. 使用过程中,如果产品因跌落、挤压或强力冲击导致外壳破裂,应立即停止使用,避免接触内部电子部件而触电受伤。
9. 本设备不防水,请保持干燥,不能浸入水或其他液体;应安装在通风干燥位置,避免在雨天、潮湿、多尘或过热环境中使用。不要在设备上方放置物品,或让液体流入内部,防止发生危险。
10. 未经授权,请不要自行拆卸本产品。产品若出现故障,必须由本公司或授权维修人员检查和维修。
11. 存放设备前,请确保设备已完全冷却。
12. 请勿将设备放置在酒精、汽油等易挥发性溶剂或气体如甲烷、乙烷等附近。
13. 本设备禁止在有爆炸危险的环境中使用或存放。
14. 运行期间和之后,设备灯头与用户和其他人员,以及热敏或可燃物品之间,距离必

须始终保持至少1米。

15. 请勿使用未经本公司认可的配件,以免造成火灾、触电或人身伤害。
16. 清洁设备时,请用干燥软布轻轻擦拭,不可使用湿布,否则可能会损坏设备。
17. 本使用说明基于严格测试制定,设计和规格变更恕不另行通知。您可登录我们官方网站查看最新电子版使用说明,了解产品最新资讯。
18. 产品内置锂电池,必须使用专用充电器充电,并按正确操作说明,在规定电压和温度范围内使用。
19. 本设备整机的保修期为一年。消耗品(如电池)、适配器、电源线等配件不在保修范围内。
20. 私自维修将取消保修资格,需支付维修费用。
21. 不当操作导致故障不在保修范围。

## 前言

感谢您购买神牛闪光灯 Lux Cadet。

Lux Cadet, 外形复古, 小巧便携, 仅重 171g; 支持自动闪光输出 / 手动闪光输出; 内置 3.7V 1700mAh 锂电池; 能在 ISO100 时提供 GN10 闪光指数; 值得一提的是, 灯体反光罩与灯管采用一体设计, 节约空间的同时极具造型魅力; 兼容各类相机。

## 警告

- ▲ 请保持产品干燥。
- ▲ 请勿将闪光灯头正对人眼闪光 (特别是婴儿的眼睛), 否则可能会在短时间内造成视力障碍。
- ▲ 请勿在化学品、可燃性气体或其他特殊物质附近使用闪光灯, 这些物质在特殊情况下可能对闪光灯发出的瞬间强光敏感, 有可能导致火灾或电磁干扰。在这些场合下, 请注意相关警告标识。
- ▲ 本产品不能防水, 在雨天及潮湿环境下请注意防水。
- ▲ 若发生任何故障, 请立即关闭闪光灯电源。
- ▲ 使用中, 反光罩如被刮花属于正常现象, 不影响后续使用。
- ▲ 灯管属于易碎物品, 不使用时请将灯管收缩起来。

## 部件名称

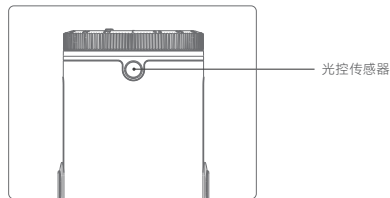
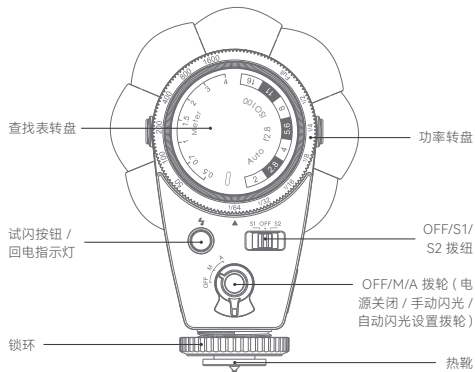



## 物料清单

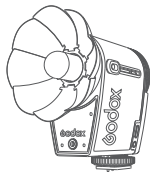

复古闪光灯 ×1



引闪线 ×1

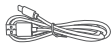

USB-C 充电线 ×1



收纳袋 ×1



说明书 ×1

## 开机/关机

将 OFF/M/A 拨轮拨至 M 手动闪光模式或 A 自动闪光模式,即可开机。将 OFF/M/A 拨轮拨至 OFF,即可关机。

注: 将相机装上闪光灯后,方可开启相机和闪光灯。

## 使用M手动闪光模式

1. 先将 OFF/M/A 拨轮拨至 M 手动闪光模式。

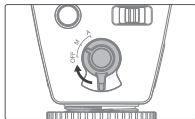

2. 根据相机已设置的感光度(假设 ISO 感光度为 100),找到闪光灯转盘 ISO 感光度 100;再根据当前拍摄距离(假设当前距离为 1m),转动查找表转盘,让拍摄距离值对准 ISO 感光度 100。

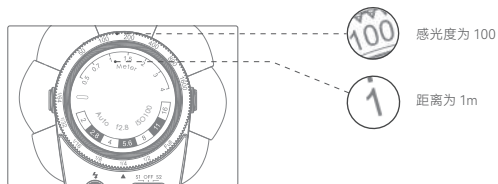

3. 最后看光圈对准的功率值(假设相机光圈为 f10),获取到闪光灯所需功率数据,根据上述假设,图中可知此时闪光灯所需功率为全功率 Full(1)。转动功率转盘,使箭头对准所需功率,即可调好所需功率。

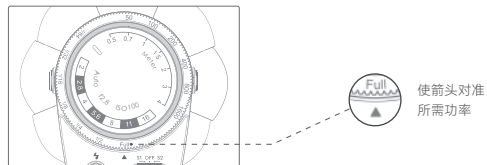
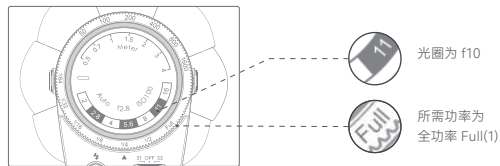

## 实用表

GN 值 \ 光圈 距离 (m)	光圈						
	2	2.8	4	5.6	8	11	16
40	20	14.2	10	7.1	5	3.6	2.5
28.3	14.2	10	7.1	5	3.6	2.5	1.8
20	10	7.1	5	3.6	2.5	1.8	1.3
14.1	7.1	5	3.6	2.5	1.8	1.3	0.9
10	5	3.6	2.5	1.8	1.3	0.9	0.6
7.1	3.6	2.5	1.8	1.3	0.9	0.6	0.5
5	2.5	1.8	1.3	0.9	0.6	0.5	0.3
3.5	1.8	1.3	0.9	0.6	0.5	0.3	0.2
2.5	1.3	0.9	0.6	0.5	0.3	0.2	0.1
1.8	0.9	0.6	0.5	0.3	0.2	0.1	
1.3	0.6	0.5	0.3	0.2	0.1		
0.9	0.5	0.3	0.2	0.1			

闪光功率 \ 感光度 GN 值	感光度						
	50	100	200	400	800	1600	
1	7.1	10	14.1	20	28.3	40	
1/2	5	7.1	10	14.1	20	28.3	
1/4	3.5	5	7.1	10	14.1	20	
1/8	2.5	3.5	5	7.1	10	14.1	
1/16	1.8	2.5	3.5	5	7.1	10	
1/32	1.3	1.8	2.5	3.5	5	7.1	
1/64	0.9	1.3	1.8	2.5	3.5	5	

## 使用A自动闪光模式

将 OFF/M/A 拨轮拨至 A 自动闪光模式。

注：在 A 自动闪光模式下，默认相机感光度 ISO 100 和光圈 f2.8。

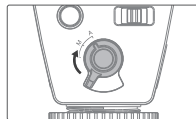

## 实用表

感光度	50	100	200	400	800	1600
光圈	2	2.8	4	5.6	8	11
使用范围	最远 4 米					

注：使用过镜头可能会影响 A 模式光输出。

## 光控模式

### S1 光控单位设置

在 M 手动闪光模式下，可以使用 S1 功能；将 OFF/S1/S2 拨钮推至 S1，闪光灯可作为副灯使用，创造多种照明效果，适用于手动闪光环境。它会与主闪光灯的第一次闪光同步触发闪光，效果与使用无线引闪器一致。

### S2 光控单位设置

在 M 手动闪光模式下，可以使用 S2 功能；将 OFF/S1/S2 拨钮推至 S2，闪光灯可作为副灯使用，适用于 TTL 闪光环境；具有防预闪功能，使用带一次预闪功能的相机能用光控实现同步拍摄。它会与主闪光灯的第二次闪光同步触发闪光，即 2 次光控引闪。

注：只有在 M 手动闪光模式下，才支持 S1/S2 光控引闪模式。

## 规格参数

型号	Lux Cadet
闪光指数 (1/1档位)	GN10(ISO100,以米为单位)
锂电池	3.7V 1700mAh
输入参数	5V $\overline{\text{---}}$ 2A
闪光功率档位	7 档: 1/1-1/64
色温	6200K $\pm$ 300K
焦距	28mm(固定值)
转盘显示	功率: Full, 1/2, 1/4, 1/8, 1/16, 1/32, 1/64 光圈: F2-16 距离: 0.5m, 0.7m, 1m, 1.5m, 2m, 3m, 4m Auto f2.8 ISO100 (自动闪光模式下默认参数)
光控引闪	S1 光控同步引闪 / S2 光控防预闪引闪
工作环境温度	-10°C-50°C
回电时间 (1/1档位)	$\approx$ 2.5s
全功率闪光次数 (1/1档位)	$\approx$ 620 次
电池充电温度范围	0°C-60°C
同步触发	热靴, 同步线
尺寸 (反光罩为收缩状态)	95mm*52mm*70mm
净重 $\approx$	171g

设计和规格如有变更, 恕不另行通知。

## Important Safety Instructions

This product is a professional photographic equipment, to be operated by professional personnel only.

The following basic safety precautions must be followed when using this product: All transport protective materials and packaging on the product must be removed before use.

1. Carefully read and fully understand the instruction manual before use and strictly follow the safety instructions. Failure to do so may result in death, serious injury, damage to the product, or other property damage.
2. This product is a professional lighting fixture, children are prohibited from using it. Children must be closely supervised by adults when approaching the fixture, to prevent collisions with the fixture or unauthorized use that could cause personal injury.
3. This is not an ordinary lighting fixture and must not be used for general illumination. Anyone with a history of eye damage or sensitivity should avoid using this fixture or looking directly at it.
4. Extreme caution must be exercised when using it, do not touch high-temperature parts such as flash tubes to avoid burns.
5. Do not point the flash directly at the eyes (especially baby's eyes) under any circumstances, as this could impair vision in a short time. Turn off immediately if discomfort occurs, stop using, and seek medical attention promptly.
6. If the flash tube is damaged, stop using it immediately and contact the manufacturer, service agent, or qualified repair personnel for a replacement to prevent accidents.
7. Do not use damaged equipment or accessories. Allow professional repair technicians to inspect and confirm normal operation before continuing use after repairs.
8. Stop using immediately if the product shell is cracked due to falling, squeezing, or strong impact, to avoid touching the internal electronic components and

- 9 getting an electric shock.

This device is not waterproof. Keep it dry and avoid immersing it in water or other liquids. It should be installed in a ventilated and dry location and avoid using in rainy, humid, dusty, or overheated environments. Do not place items

10. above the device or allow liquids to flow into it to prevent danger.

Do not disassemble without authorization. If the product malfunctions, it must

11. be inspected and repaired by our company or authorized repair personnel.

12. Before storing the device, ensure it has completely cooled down .

Do not place the device near alcohol, gasoline, or other flammable volatile

13. solvents or gases such as methane and ethane.

14. Do not use or store this device in potentially explosive environments.

Maintain at least 1 meter distance between the lamp head and the user, other

15. people, and heat-sensitive or flammable items during and after use.

Do not use accessories not been approved by our company, as this may cause

16. fire, electric shock or personal injury.

Clean gently with a dry cloth. Do not use a wet cloth as it may damage the

17. device.

This instruction manual is based on rigorous testing. Changes in design and specifications are subject to change without notice. Check official website for

18. latest instruction manual and product updates.

Use only specified charger and follow proper usage instructions for products

19. with built-in lithium batteries, within the rated voltage and temperature range.

The warranty period for this device as a whole is one year. Consumables (such as batteries), adapters, power cords, and other accessories are not covered by

20. the warranty.

21. Unauthorized repairs will void the warranty and will incur charges.

Failures from improper operation is not covered under warranty.

## Foreword

Thank you for purchasing!

Retro camera flash Lux Cadet comes with a vintage style and compact structure, combines the following prominent features: only 171g weight, auto/manual flash output, built-in 3.7V/1700mAh lithium battery, GN10 at ISO100, compatibility with various cameras. Furthermore, its creatively integrated design of flash tube and reflector not only saves space but also brings artistic attraction.

## Warning

- ▲ Always keep this product dry. Do not use in rain or in damp conditions.
- ▲ Do not leave or store the flash unit if the ambient temperature reads over 50°C.
- ▲ Do not fire the flash directly into the eyes (especially those of babies) within short distances. Otherwise, visual impairment may occur.
- ▲ Do not use the flash unit in the presence of flammable gases, chemicals and other similar materials. In certain circumstance, these materials may be sensitive to the strong light emitting from this flash unit and fire or electromagnetic interference may result.
- ▲ Turn off the devices immediately in the event of malfunction.
- ▲ Scratches on the reflector caused during using will not affect the normal use.
- ▲ The flash tube is fragile, please take it in when not in use.



## Name of Parts

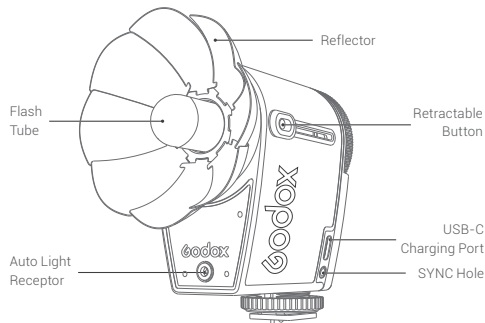
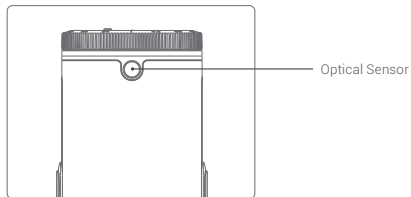
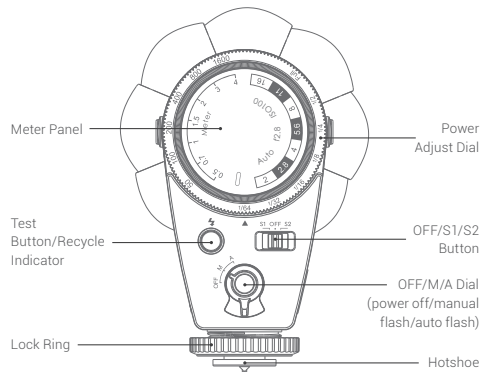

## Power Adjusting Instruction

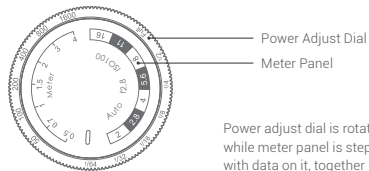

Power adjust dial is rotatable in 7 steps, while meter panel is steplessly rotatable with data on it, together precisely setting and adjusting power.

## Power adjust dial/Meter panel Settings Instruction

ISO Values	50	100	200	400	800	1600	
Flash Power Steps	Full	1/2	1/4	1/8	1/16	1/32	1/64
Aperture Values	2	2.8	4	5.6	8	11	16
Best Shooting Distance (m)	0.5	0.7	1	1.5	2	3	4

## Recycle Indicator Instruction

Switch the OFF/M/A dial to M manual flash mode or A auto flash mode.

1. When the recycle indicator is constant on red, it means recycling.
2. When the recycle indicator is constant on green, it means recycle complete.
3. When the recycle indicator flashes red stably, it means low battery state, please charge the battery in time.
4. When the recycle indicator flashes rapidly, it means high temperature state.
5. When the recycle indicator is off, it means battery is dead.

Switch the OFF/M/A dial to OFF mode.

1. When the recycle indicator is constant on red, it means charging.
2. When the recycle indicator is constant on green, it means charging complete.
3. When the recycle indicator flashes rapidly, it means battery over-temperature and stops charging. (battery charging temperature range: 0°C~60°C)

Switch the OFF/M/A dial to OFF mode then short press the recycle indicator once.

1. The recycle indicator turns to green and blinks four times, it means 75%-100% battery level.
2. The recycle indicator turns to green and blinks three times, it means 50%-75% battery level.
3. The recycle indicator turns to green and blinks twice, it means 25%-50% battery level.
4. The recycle indicator turns to green and blinks once, it means 0-25% battery level, please charge the battery in time.

**Note:** When the flash tube and the reflector are taken in, switch the OFF/M/A to M or A mode, the recycle indicator is constant on red. When the flash tube and the reflector are stretched out, switch the OFF/M/A to M or A mode, the recycle indicator is constant on green.

## What's Inside

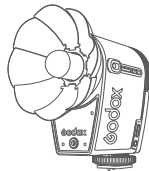

Retro Camera Flash \*1



Triggering Cable\*1



USB-C Charging Cable\*1



Storage Bag\*1



Instruction Manual\*1

## Power Switch

Turn the OFF/M/A dial to M manual flash mode or A auto flash mode, the device can be powered on. Turn it to OFF mode, the device is powered off.

**Note:** Install the flash to the camera then turn on the camera and flash.

## M Manual Flash Mode

1. Turn the OFF/M/A dial to M manual flash mode.

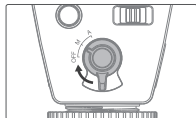

2. According to the ISO value (assuming the ISO value is 100) of the camera, find the ISO value 100 on the power adjust dial. Then turn the meter panel to make the distance value aimed at the ISO value 100 according to the current shooting distance (assuming the distance is 1m).

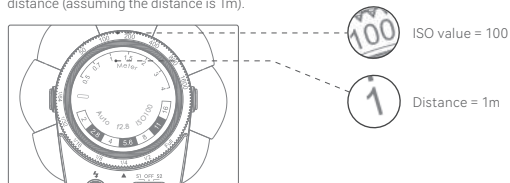

3. The flash power is the value on the dial aimed at the aperture value (assuming the aperture value is f10). In the above assumptive situation, the flash power should be Full (1) power. Turn the power adjust dial to make the power value aimed at the arrow, then the flash is ready for use.

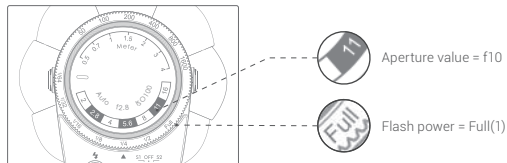

The arrow aimed at the power value.

## Practical Form of M Manual Flash Mode

GN	Aperture							
	Distance (m)							
	2	2.8	4	5.6	8	11	16	
40	20	14.2	10	7.1	5	3.6	2.5	
28.3	14.2	10	7.1	5	3.6	2.5	1.8	
20	10	7.1	5	3.6	2.5	1.8	1.3	
14.1	7.1	5	3.6	2.5	1.8	1.3	0.9	0.6
10	5	3.6	2.5	1.8	1.3	0.9	0.6	0.5
7.1	3.6	2.5	1.8	1.3	0.9	0.6	0.5	0.3
5	2.5	1.8	1.3	0.9	0.6	0.5	0.3	0.2
3.5	1.8	1.3	0.9	0.6	0.5	0.3	0.2	0.1
2.5	1.3	0.9	0.6	0.5	0.3	0.2	0.1	
1.8	0.9	0.6	0.5	0.3	0.2	0.1		
1.3	0.6	0.5	0.3	0.2	0.1			
0.9	0.5	0.3	0.2	0.1				

Flash Power	ISO	50	100	200	400	800	1600
	GN						
1		7.1	10	14.1	20	28.3	40
1/2		5	7.1	10	14.1	20	28.3
1/4		3.5	5	7.1	10	14.1	20
1/8		2.5	3.5	5	7.1	10	14.1
1/16		1.8	2.5	3.5	5	7.1	10
1/32		1.3	1.8	2.5	3.5	5	7.1
1/64		0.9	1.3	1.8	2.5	3.5	5

## A Auto Flash Mode

Turn the OFF/M/A dial to A auto flash mode.

**Note:** The default ISO and aperture values of camera are 100 and f2.8 respectively in A auto flash mode.

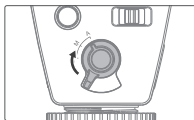

## Practical Form of A Auto Flash Mode

ISO	50	100	200	400	800	1600
Aperture	2	2.8	4	5.6	8	11
Distance	Max. 4 meters					

**Note:** Using improper extra-long lens may affect the output in A auto flash mode.

## Optical Control Mode

### S1 optical control

The S1 optical control function is available in M manual flash mode. Push the OFF/S1/S2 button to S1, the flash can function as an optical S1 secondary flash. With this function, the flash will fire synchronously when the main flash fires, the same effect as that by using of radio triggers. This helps create multiple lighting effects.

### S2 optical control

The S2 optical control function is available in M manual flash mode. Push the OFF/S1/S2 button to S2, the flash can also function as an optical S2 secondary flash to be suitable for TTL flash. This is useful when cameras have pre-flash function. With this function, the flash will ignore a single "pre-flash" from the main flash and will only fire in response to the second, actual flash from the main unit.

**Note:** S1/S2 optical control is only available in M manual flash mode.

## Technical Data

Model	Lux Cadet
GN (1/1 step)	GN10 (ISO100, in meters)
Lithium Battery	3.7V 1700mAh
Input Parameter	5V  2A
Flash Power	7 steps: 1/1-1/64
CCT	6200K±300K
Focal Length	28mm (fixed value)
Panel Display	Power: Full, 1/2, 1/4, 1/8, 1/16, 1/32, 1/64 Aperture: F2-16 Distance: 0.5m, 0.7m, 1m, 1.5m, 2m, 3m, 4m Auto f2.8 ISO100 (default value in A auto flash mode)
Optical Flash	S1 optical control/S2 optical control
Working Environment Temperature	-10°C~50°C
Recycle Time (1/1 step)	≈2.5s
Full Power Flash Times (1/1 step)	≈620 times
Battery Charging Temperature Range	0°C-60°C
SYNC	Hotshoe, SYNC cable
Dimension (when the reflector is taken in)	3.7*2*2.8"
Net Weight=	171g

Specifications and data may subject to changes without notice.

## Declaration of Conformity:

GODOX Photo Equipment Co.,Ltd. hereby declares that the This equipment are in compliance with the essential requirements and other relevant provisions of EU Directive 2014/35/EU、2014/30/EU. They are allowed to be used in all EU member states.

For more information of DoC, Please click this web link:

<https://www.godox.com/eu-declaration-of-conformity/>

## FCC Statement

This device complies with part 15 of the FCC Rules. Operation is subject to the following two conditions:

- (1) This device may not cause harmful interference, and
- (2) this device must accept any interference received, including interference that may cause undesired operation.

Any Changes or modifications not expressly approved by the party responsible for compliance could void the user's authority to operate the equipment.

**Note:** This equipment has been tested and found to comply with the limits for a Class B digital device, pursuant to part 15 of the FCC Rules. These limits are designed to provide reasonable protection against harmful interference in a residential installation. This equipment generates uses and can radiate radio frequency energy and, if not installed and used in accordance with the instructions, may cause harmful interference to radio communications. However, there is no guarantee that interference will not occur in a particular installation. If this equipment does cause harmful interference to radio or television reception, which can be determined by turning the equipment off and on, the user is encouraged to try to correct the interference by one or more of the following measures:

- Reorient or relocate the receiving antenna.
- Increase the separation between the equipment and receiver.
- Connect the equipment into an outlet on a circuit different from that to which the receiver is connected.
- Consult the dealer or an experienced radio/TV technician for help.

## 产品保修

尊敬的用户, 本保修卡是申请保修服务的重要凭证, 请您配合销售商填写并妥善保管, 谢谢!

产品信息	型号	产品条码
用户信息	姓名	联系电话
	通信地址	
销售商信息	名称	
	联系电话	
	通信地址	
	销售日期	
备注		

注: 此表应由销售商盖章确认。

### 产品信息

本文件适用于相关《产品保修信息》(见后面说明)所列产品, 其他非属此范围的产品或部件(如促销品、赠品及其他出厂后附加的部件等)不在此保修承诺内。

### 保修期

产品及部件的相应保修期按相关的《产品保修信息》执行。保修期自产品首次购买日起算, 购买日以购买产品时保修卡登记日期为准。

### 如何获得保修服务

您可直接与产品销售商或授权服务机构联系, 也可拨打神牛产品售后服务电话, 与我们联系, 由我们的服务人员为您安排服务。申请保修时, 您应提供有效的保修卡作为保修凭证, 方可获得保修。如您不能提供有效的保修卡, 则在我们确认产品或部件属于保修范围的情况下, 也可以为您提供保修, 但这不作为我们的义务。

### 不适用保修的情况

如产品存在下列情况, 本文件项下的保证和服务将不适用: ①产品或部件超过相应保修期; ②错误或不适当使用、维护或保管导致的故障或损坏, 如: 不当搬运; 非按产品合理预期用途使用; 不当插拔外接设备; 跌落或外力挤压; 接触或暴露于不适当温度、溶剂、酸碱、水浸或潮湿环境; ③由非神牛授权机构或人员安装、修理、更改、添加或拆卸造成的故障或损坏; ④产品或部件原有识别信息被修改变更或删除; ⑤无有效保修卡; ⑥使用非合法授权、非标准或非公开发行的软件造成的故障或损坏; ⑦因不可抗力或意外事件造成的故障或损坏; ⑧其他非因产品本身质量问题导致的故障或损坏。遇上述情况, 您应向相关责任方寻求解决, 神牛对此不承担任何责任。因非在保修期或保修范围内的部件、附件或软件导致产品不能正常使用的, 不是保修范围内的故障。产品使用过程中正常的脱色, 磨损和消耗, 不是保修范围内的故障。

## 产品保修和服务支持信息

产品的保修期和服务类型按以下《产品保修信息》执行:

产品类别	选件名称	保修期(月)	保修服务类型
部件	电路板	12	客户送修
	电池	3	客户送修
	充电器等带电性能的部位。	12	客户送修
其他	如闪光管、造型灯泡、外壳、保护罩、锁紧装置、包装等。	无	无保修

神牛产品售后服务电话 0755-29609320-8062

## Warranty

Dear customers, as this warranty card is an important certificate to apply for our maintenance service, please fill in the following form in coordination with the seller and safe-keep it. Thank you!

Product Information	Model	Product Code Number
Customer Information	Name	Contact Number
	Address	
Seller Information	Name	
	Contact Number	
	Address	
	Date of Sale	
Note		

**Note:** This form shall be sealed by the seller.

### Applicable Products

The document applies to the products listed on the Product Maintenance Information (see below for further information). Other products or accessories (e.g. promotional items, giveaways and additional accessories attached, etc.) are not included in this warranty scope.

### Warranty Period

The warranty period of products and accessories is implemented according to the relevant Product Maintenance Information. The warranty period is calculated from the day (purchase date) when the product is bought for the first time. And the purchase date is considered as the date registered on the warranty card when buying the product.

### How to Get the Maintenance Service

If maintenance service is needed, you can directly contact the product distributor or authorized service institutions. You can also contact the Godox after-sale service call and we will offer you service. When applying for maintenance service, you should provide valid warranty card. If you cannot provide valid warranty card, we may offer you maintenance service once confirmed that the product or accessory is involved in the maintenance scope, but that shall not be considered as our obligation.

### Inapplicable Cases

The guarantee and service offered by this document are not applicable in the following cases: ① The product or accessory has expired its warranty period; ② Breakage or damage caused by inappropriate usage, maintenance or preservation, such as improper packing, improper usage, improper plugging in/out external equipment, falling off or squeezing by external force, contacting or exposing to the improper temperature, solvent, acid, base, flooding and damp environments, etc; ③ Breakage or damage caused by non-authorized institution or staff in the process of installation, maintenance, alternation, addition and detachment; ④ The original identifying information of product or accessory is modified, alternated, or removed; ⑤ No valid warranty card; ⑥ Breakage or damage caused by using illegally authorized, nonstandard or non-public released software; ⑦ Breakage or damage caused by force majeure or accident; ⑧ Breakage or damage that could not be attributed to the product itself. Once met these situations above, you should seek solutions from the related responsible parties and Godox assumes no responsibility. The damage caused by parts, accessories and software that beyond the warranty period or scope is not included in our maintenance scope. The normal discoloration, abrasion and consumption are not the breakage within the maintenance scope.

## Maintenance and Service Support Information

The warranty period and service types of products are implemented according to the following Product Maintenance Information:

Product Type	Name	Maintenance Period(month)	Warranty Service Type
Parts	Circuit board	12	Customer sends the product to designated site
	Battery	3	Customer sends the product to designated site
	Electrical parts e.g.battery charger, etc.	12	Customer sends the product to designated site
Other Items	Flash tube, modeling lamp, shell, lamp cover, locking device, package, etc.	No	Without warranty

Godox After-sale Service Call +86-755-29609320(8062)