

合格证
QC PASS

Godox

V1^{Pro}
F

TTL 锂电圆头机顶闪光灯

TTL Li-ion Round Head Camera Flash

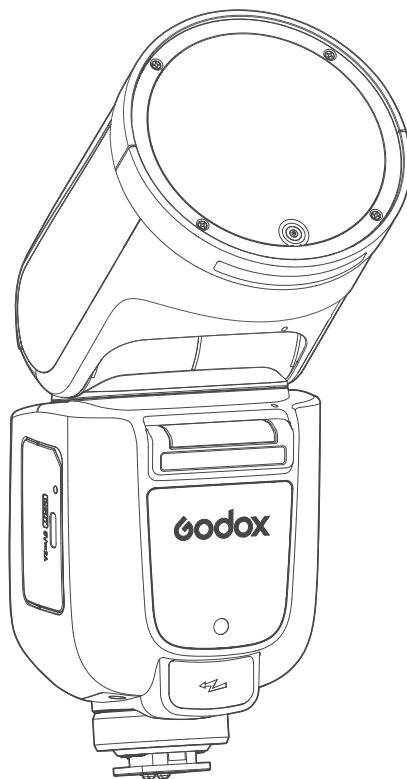

Wechat
Official Account
神牛微信公众号

深圳市神牛摄影器材有限公司

地址：深圳市宝安区福海街道塘尾社区耀川工业区厂房2栋
电话：0755-29609320(8062) 传真：0755-25723423 邮箱：godox@godox.com

GODOX Photo Equipment Co.,Ltd.

Add: Building 2, Yaochuan Industrial Zone, Tangwei Community, Fuhai Street,
Bao'an District, Shenzhen 518103, China Tel: +86-755-29609320(8062)
Fax: +86-755-25723423 E-mail: godox@godox.com

www.godox.com
Made in China | 705-V1PRF0-00



使用手册
Instruction Manual

说明书安全提示

重要安全提示：本产品属于专业摄影设备，需要专业人员操作使用。

使用时必须遵守以下基本安全防护措施：使用前必须拆除产品上的所有运输保护材料和包装。

1. 使用本产品前，请仔细阅读并完全理解产品说明书，严格按照说明书中的安全提示操作。否则，可能导致死亡、严重伤害、产品损坏或其他财产损失的安全隐患。
2. 本产品为专业灯具，儿童禁止使用。儿童接近时，成人必须密切监督，防止儿童碰撞灯具或私自使用灯具，造成人身伤害。
3. 本灯具并非普通灯具，不可用于普通照明，任何有过眼部损伤或眼部敏感的人群均应避免使用本灯具或直视本灯具。
4. 使用时必须小心，严禁接触如闪光管等高温部件，以避免烫伤。
5. 任何情况下均禁止将闪光灯直接对准人眼（特别是婴儿眼睛），否则短时间内可能导致视力损伤。如感到眼睛不适，应立即关闭灯具，停止使用并及时就医。
6. 严禁使用损坏的设备或配件，必须等待专业维修人员检查维修并确认设备正常后，才可继续使用。
7. 使用过程中，如果产品因跌落、挤压或强力冲击导致外壳破裂，应立即停止使用，避免接触内部电子部件而触电受伤。
8. 本设备不防水，请保持干燥，不能浸入水或其他液体；应安装在通风干燥位置，避免在雨天、潮湿、多尘或过热环境中使用。不要在设备上放置物品，或让液体流入内部，防止发生危险。
9. 未经授权，请不要自行拆卸本产品。产品若出现故障，必须由本公司或授权维修人员检查和维修。
10. 存放设备前，请确保设备已完全冷却。
11. 请勿将设备放置在酒精、汽油等易燃挥发性溶剂或气体如甲烷、乙烷等附近。
12. 本设备禁止在有爆炸危险的环境中使用或存放。
13. 运行期间和之后，设备灯头与用户和其他人员，以及热敏或可燃物品之间，距离必须始终保持至少 1 米。
14. 请勿使用未经本公司认可的配件，以免造成火灾、触电或人身伤害。
15. 清洁设备时，请用干燥软布轻轻擦拭，不可使用湿布，否则可能会损坏设备。
16. 本使用说明基于严格测试制定，设计和规格变更恕不另行通知。您可登录我们官方网站查看最新电子版使用说明，了解产品最新资讯。
17. 产品使用锂电池供电。这类锂离子电池使用寿命有限，会逐渐失去储能能力，这种能力下降不可逆。电池老化时，产品续航时间会减少。锂离子电池使用寿命预计 2—3 年。请定期检查电池情况，如果充电时间明显增加或续航时间明显减少，请考虑更换新电池。
18. 产品配备锂电池，其储存建议如下：储存前，将电池充放电至约 50% 电量；至少每 6 个月充电一次，至约 50% 电量；可拆卸电池应单独存放；储存温度在 0° C 至 40° C 范围内。
19. 使用锂电池的注意事项：
 - 不要拆卸、压碎或刺穿电池；
 - 电池没有防水功能，不要把电池浸泡在雾、水中；
 - 避免使电池触点短路；
 - 电池不要靠近和放置于火中；
 - 不要将电池暴露在 60° C 以上高温下；
 - 将电池放在儿童接触不到的位置；
 - 防止电池遭受过度冲击或振动；
 - 不要使用已损坏的电池；
 - 如果电池出现泄漏，请避免接触泄漏液体；
 - 如果眼睛接触电池液体，立即用水冲洗至少 15 分钟，抬起眼睑直到没有液体的迹象后及时就医。
20. 处理任何电池前，请确认并遵守当地相关法律法规。

21. 本设备整机的保修期为一年。消耗品（如电池）、适配器、电源线等配件不在保修范围内。
22. 私自维修将取消保修资格，需支付维修费用。
23. 请收到锂电池时及时检查电池状态、电量情况，如有任何质量问题及时在保修期内联系神牛或神牛所授权的经销商。
24. 不当操作导致故障不在保修范围。

前言

感谢您购买神牛产品。

机顶闪光灯 V1Pro F 适用于富士相机，兼容 TTL 自动闪光。使用 TTL 闪光灯，您将获得更简单的拍摄体验，在光线变化复杂的情况下，可以自动获得准确的闪光曝光，拍摄轻松自如。

主要特点

- 圆头透镜设计，实现光效均匀柔和的同时，打造更多创意的光效；
- 2W LED 造型灯，拥有 1-10 档亮度调节，为摄影起补光效果；
- 1/1 档（M 档）闪光功率为 76Ws，具备 81 级调光（1/1~1/256）；
- 配备 7.2V 2980mAh 锂电池，1/1 档闪光输出时，回电仅需 1.3s；
- 兼容富士相机，支持 TTL 自动闪光，可作为无线输出闪光系主控单位或从属单元，拍摄简单快捷；
- 点阵液晶屏，显示直观，操作更加简单易便捷；
- 拥有 2.4G 无线发射与接收，可远距离控制闪光灯，创意无限；
- 支持外接闪光灯电源盒 PB960，大大提升回电速度；
- 支持外接辅助闪光灯 SU-1，给予人像更好的造型补光，常用于人像拍摄；
- 功能齐全，支持手动闪光模式、频闪闪光模式、高速同步、第二快门同步、闪光曝光补偿等功能；
- 拥有输出稳定的高速连闪，输出亮度和色温连续一致，光线均匀分布；
- 支持固件升级，神牛紧跟原厂相机步伐，及时对闪光灯软件进行优化。

注：闪光灯电源盒 PB960 需另购。

目录

01	前言
01	主要特点
03	部件名称
	机身
	控制面板
	分体式副闪光灯 SU-1
	LCD 液晶显示屏
05	物料清单
06	可另购附件
06	装卸电池
06	电池电量指示
06	电源管理
07	造型灯
07	安装闪光灯 / 拆卸闪光灯
07	安装 / 拆卸分体式副闪光灯 SU-1
08	使用分体式副闪光灯 SU-1
08	闪光模式 -- TTL: 自动闪光
	闪光曝光补偿
	高速同步
	后帘同步
10	闪光模式 -- M: 手动闪光
10	闪光模式 -- Multi: 频闪闪光
12	无线闪光拍摄 (2.4G 无线传输)
	无线电传输无线设置
	设置主控单元闪光
	设置无线频道
	设置 ID
	扫描空闲频道
	TTL: 全自动无线闪光拍摄
	M: 手动无线闪光拍摄
	Multi: 手动无线闪光拍摄
	转 TTL 档 /M 档拨钮功能
	屏幕锁定
	模式锁定
18	神牛 2.4G 无线漏闪原因及解决办法
18	其他应用
	同步插孔触发
	自动辅助对焦灯
	反射闪光
	ZOOM: 设置闪光覆盖范围
	电池电量低警告
19	C.Fn: 设置自定义功能
20	保护功能
21	规格参数
22	故障排除指南
22	固件升级
23	兼容相机列表
23	维护保养

部件名称

机身

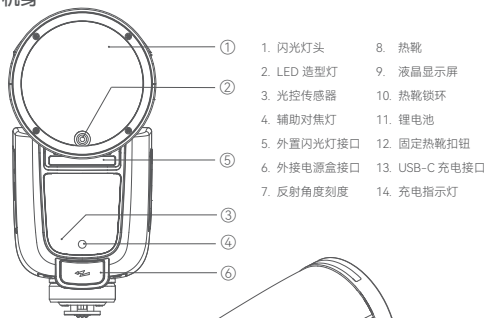

- | | |
|------------|----------------|
| 1. 闪光灯头 | 8. 热靴 |
| 2. LED 造型灯 | 9. 液晶显示屏 |
| 3. 光控传感器 | 10. 热靴锁环 |
| 4. 辅助对焦灯 | 11. 锂电池 |
| 5. 外置闪光灯接口 | 12. 固定热靴扣钮 |
| 6. 外接电源盒接口 | 13. USB-C 充电接口 |
| 7. 反射角度刻度 | 14. 充电指示灯 |

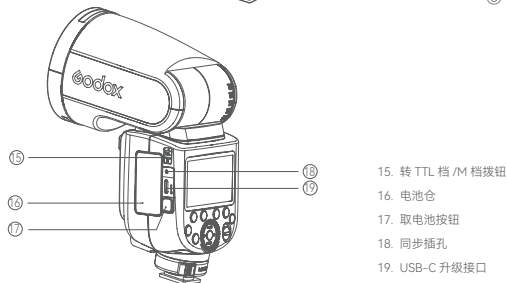
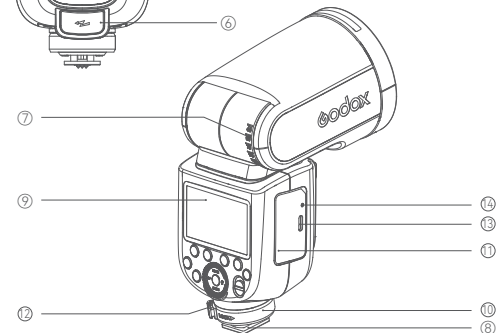

- | |
|--------------------|
| 15. 转 TTL 档 /M 档拨钮 |
| 16. 电池仓 |
| 17. 取电池按钮 |
| 18. 同步插孔 |
| 19. USB-C 升级接口 |

控制面板

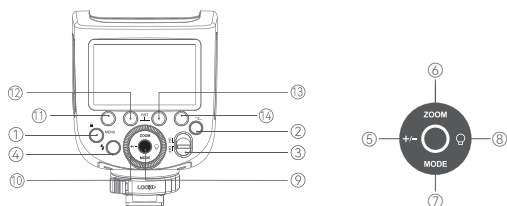

- | | | |
|------------------------------|--------------|------------|
| 1. MENU/◀ 按钮 | 6. ZOOM 变焦按键 | 11. 功能按键 1 |
| 2. < 无线按钮 | 7. MODE 模式按键 | 12. 功能按键 2 |
| 3. ON/OFF 开关按键 | 8. LED 造型灯按键 | 13. 功能按键 3 |
| 4. 试闪按键 / 回电指示灯 | 9. 设置按键 | 14. 功能按键 4 |
| 5. < +/- > 闪光曝光补偿 / 闪光输出设置按键 | 10. 调节拨轮 | |

分体式副闪光灯 SU-1

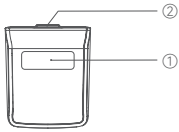

1. 灯管
2. 拆卸推制

LCD 液晶显示屏

TTL 自动闪光

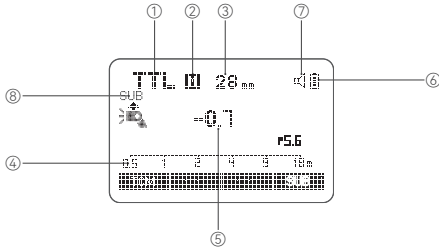

1. TTL: TTL 自动闪光
2. A: 自动变焦 M: 手动变焦
3. 变焦显示 (自动 /28-105mm) 或 (自动 /18-69mm)
4. 有效闪光范围 / 拍摄距离 (米: m、ft: 英尺)
5. 闪光曝光补偿量
6. 电池电量显示
7. 蜂鸣器
8. 辅助闪光灯 SU-1 开启

手动闪光

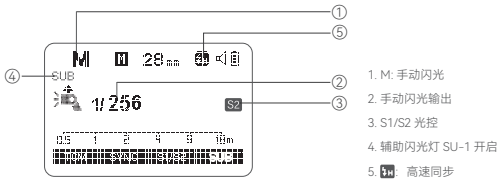

1. M: 手动闪光
2. 手动闪光输出
3. S1/S2 光控
4. 辅助闪光灯 SU-1 开启
5. 高速同步

频闪闪光

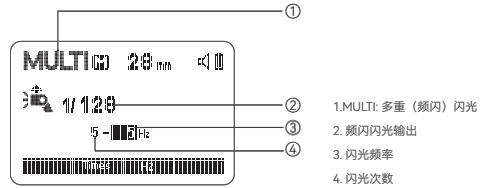

1. MULTI: 多重 (频闪) 闪光
2. 频闪闪光输出
3. 闪光频率
4. 闪光次数

无线电传输拍摄

主控单位 (2.4G 无线发射)

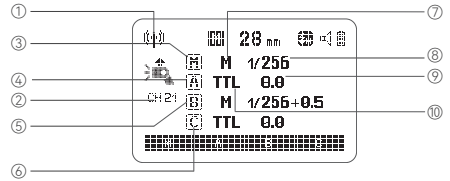

1. 无线电传输拍摄
2. 发射器传输频道
3. 组别 M: 主控单位 M 组
4. 组别 A: 从属单位 A 组
5. 组别 B: 从属单位 B 组
6. 组别 C: 从属单位 C 组
7. M: 手动闪光
8. 闪光输出
9. 闪光曝光补偿量
10. TTL: TTL 自动闪光

从属单位 (2.4G 无线接收)

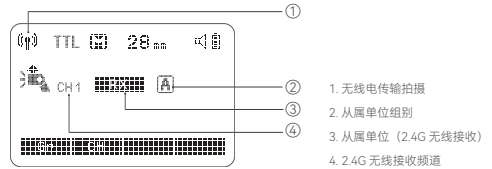

1. 无线电传输拍摄
2. 从属单位组别
3. 从属单位 (2.4G 无线接收)
4. 2.4G 无线接收频道

物料清单

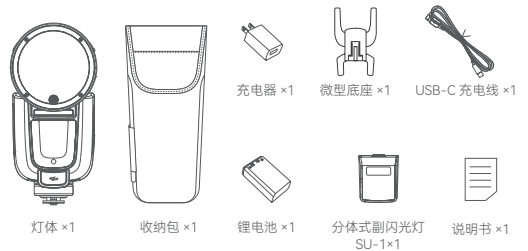

灯体 ×1

收纳包 ×1

锂电池 ×1

分体式副闪光灯 SU-1 ×1

说明书 ×1

充电器 ×1

微型底座 ×1

USB-C 充电线 ×1

注: 1. 显示屏将显示当前应用的设置。

2. 在功能按钮 1 至功能按钮 4 上方显示的功能, 如 <SYNC 和 M/A/B/C> 根据设置的状态发生变化。

3. 当操作按键或调节波轮时, 液晶显示屏点亮。

4. 机顶闪光灯 V1Pro F 需插入辅助闪光灯 SU-1, 界面才会显示 <SUB> 字符。

可另购附件

您可另购本公司以下摄影附件，以获得最佳的拍摄效果和使用体验。



引闪器 X2T F

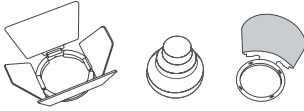

AK-R1 圆形灯附件套装



引闪器 XProII F

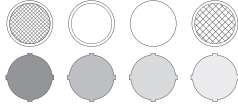

- 注：1. 离机使用时，您可以短按 MENU 按键进入菜单，将 C.Fn-STBY 设为 OFF(关闭)。
2. 闪光灯作为从属单位时，自动关闭电源计时器出厂默认设置为 60 分钟，您也可以短按 MENU 按键进入菜单，将 C.Fn-RX STBY 设为 30min，将自动关闭时间改为 30 分钟。
3. 当操作按键或调节波轮时，液晶显示屏点亮。

造型灯

通过短按造型灯按键进入 / 退出造型灯设置，短按设置按键打开或关闭造型灯。造型灯打开后，旋转调节波轮即可调节造型灯亮度，共有 01-10 个档位。



装卸电池

拆卸电池：

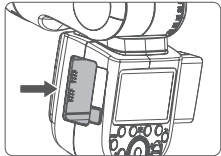

用您的拇指按住电池按钮，往下推动电池便可取出电池。

安装电池：

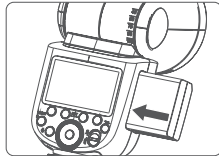

按电池指示方向将锂电池插入电池仓，直至扣件卡住即可。

电池电量指示

将锂电池正确安装在闪光灯上，即可给闪光灯供电。使用时请查看闪光灯屏幕上电池图标，即可随时掌握电量状态。

电池电量显示	说明
3 格	满电
2 格	中电
1 格	低电
无格	电量少，请及时充电
无格闪烁	电量即将用尽，此状态不支持闪光灯工作。 注：此状态请尽快 (10 天内) 充电，才可使用或放置。

电源管理

拨动开关实现开机 / 关机。长时间不使用闪光灯时，请您及时关闭电源。本产品有电源自动关闭功能，作为主控单元时，超过规定时间 (约 90 秒) 无人操作时，闪光灯会自动关闭，半按快门按键或机身任意键唤醒闪光灯；作为从属单元时，超过 60 分钟 (或 30 分钟) 无人操作时，闪光灯会进入休眠状态，使用时可按机身任意键唤醒。

安装闪光灯 / 拆卸闪光灯

安装：

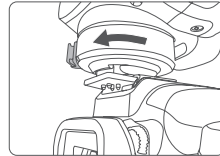

按住固定热靴扣钮的同时旋转到左边，即可插入相机热靴；



随即转动闪光灯热靴锁环到右边便可锁定热靴。

拆卸：

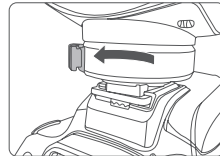

按住固定热靴扣钮的同时旋转到右边，即可解锁热靴，此时取下闪光灯完成拆卸。

安装 / 拆卸分体式副闪光灯 SU-1

安装：

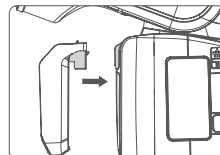

您只需将分体式副闪光灯 SU-1 对准机顶闪光灯 V1Pro F 外接闪光灯接口平行卡入后下压，听到“咔”一声即可安装完成。

拆卸：

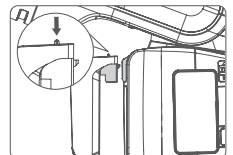

您推动分体式副闪光灯拆卸推剂的同时，往上取出即可拆卸完成。

使用分体式副闪光灯 SU-1

与机顶闪光灯 V1F 相比，机顶闪光灯 V1Pro F 独特之一，增加了外接闪光灯接口，使用分体式副闪光灯 SU-1，可以在 M 档手动闪光输出 / TTL 自动闪光输出时，给予物体更好的补光效果，此功能常用于人像拍摄。

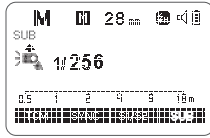

使用步骤

您只需将分体式副闪光灯 SU-1 对准机顶闪光灯 V1Pro F 外接闪光灯接口平行卡入，听到“咔”一声即可安装完成。短按 MODEL 按键令将闪光灯显示屏显示 <M>M 档手动闪光或 <TTL>TTL 自动闪光，短按功能按键 4<SUB> 即可进入辅助闪光灯设置界面，短按功能按键 3<ON/OFF> 可进行关闭 / 开启。



在开启辅助闪光灯状态下，旋转调节波轮可调节辅助闪光灯闪光输出，共 22 档闪光功率，调节范围 1/128-1/1，旋转一次，每档以 + 1/3 档为增量调节。

- 注：1. 无线电传输拍摄时不能使用外接闪光灯 SU-1。
2. 高速同步时不能使用外接闪光灯 SU-1。
3. 闪光灯灯头需抬起，外置闪光灯方可正常使用。

2. 转动调节拨轮设置闪光曝光补偿量。“0.3”表示 1/3 档，“0.7”表示 2/3 档。要取消闪光曝光补偿，将闪光曝光补偿量设为“0”。

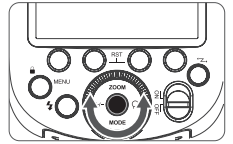

3. 最后短按设置按键，确定闪光曝光补偿值。

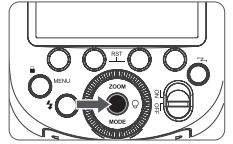

高速同步

使用高速同步 (FP 闪光)，您可以在任意快门速度下同步使用闪光灯。高速同步闪光在使用光圈优先对人像进行填充时，闪光时特别方便。

设置机顶高速同步

使用照相机拍摄菜单中的 < 闪光灯 > 设置 > 闪光灯功能设置选项可调整闪光灯设定。有关详情，请参阅照相机使用手册。



X-T2 的闪光灯功能设置菜单

闪光模式 --TTL: 自动闪光

在 TTL 模式下，相机的测光系统会侦查从主体反射回来的闪光照明，从而自动调节闪光输出量，使主体和背景得到均衡曝光。TTL 模式支持曝光补偿、高速同步、后帘同步等功能。

通过短按 MODE 模式按钮切换至 TTL 模式，此时显示屏左上角显示 <TTL>，表示闪光灯进入 TTL 模式。

- 半按相机快门按钮进行对焦，光圈值和有效闪光范围将会显示在显示屏上。
- 在快门释放前的瞬间进行一次预闪，闪光灯接收相机信息进行主闪光。

- 注：1. 当在“SYNC”选项选择 FP，表示高速同步功能打开。
2. 使用高速同步，快门速度越高，有效的闪光范围就越小。
3. 在高速同步模式下，无法设置频闪闪光。
4. 连续高速同步闪光 60 次后，闪光灯热保护功能可能会被激活。

闪光曝光补偿

该闪光灯可以在 +3 档间以 1/3 档为增量调节闪光曝光补偿。由于环境需求需要微调 TTL 系统时，这个功能非常有用。

设置闪光曝光补偿值

1. 短按 <+/-> 按键，此时闪光曝光补偿值被突出显示。

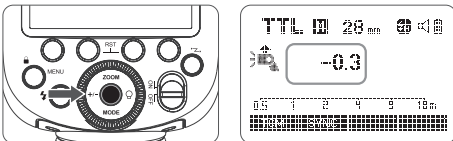

后帘同步

使用慢速快门和后帘同步，您可以在被摄体后创建一条光线轨迹，在快门关闭前的瞬间闪光。

设置后帘同步

使用照相机拍摄菜单中的 < 闪光灯 > 设置 > 闪光灯功能设置选项可调整闪光灯设定。有关详情，请参阅照相机使用手册。



X-T2 的闪光灯功能设置菜单

- 注：当在“SYNC”选项选择 REAR，表示后帘同步功能打开。

闪光模式 --M: 手动闪光

您可以在 1/256 功率至 1/1 全功率间以 1/10 档为增量设置闪光输出。为获得正确的闪光曝光，请使用手持的闪光测光表确定所需的闪光输出。

1. 短按 MODE 按键，令屏幕显示 <M>。

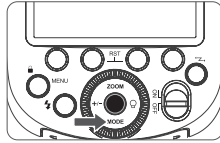

2. 短按 <+/-> 按键选中闪光输出值，接着旋转调节拨轮即可调节闪光输出值，调节完毕短按设置按键完成设置。

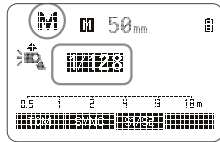

S1 光控单元设置

在 M 手动闪光模式下，可以使用 S1 功能，闪光灯可作为副灯使用，创造多种照明效果，适用于手动闪光环境。它会与主闪光灯的第一次闪光同步触发闪光，效果与使用无线引闪器一致。

S2 光控单元设置

在 M 手动闪光模式下，可以使用 S2 功能，闪光灯可作为副灯使用，适用于 TTL 闪光环境，具有防预闪功能，使用带一次预闪功能的相机能用光控实现同步拍摄。它会与主闪光灯的第二次闪光同步触发闪光，即 2 次光控引闪。

- 注：1. 只有在 M 模式下才支持 S1/S2 光控引闪。
2. 短按功能按键 3<S1/S2>，可切换 S1/S2 或关闭此功能。

闪光模式 --Multi: 频闪闪光

以慢速快门使用频闪闪光时，可以在一张照片上拍摄出多个连贯的动作。您可以设置闪光频率（每秒闪光次数，以 Hz 表示）、闪光次数和闪光输出。

1. 短按 MODE 按键，令屏幕显示 <Multi>。

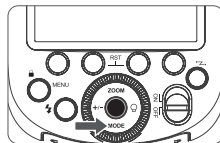

2. 短按功能按键 2<Times> 选中闪光次数，此时旋转调节拨轮即可调节闪光次数，选好短按设置按键完成设置。短按功能按键 3<Hz> 选中闪光频率，此时旋转调节拨轮即可调节闪光频率，选好短按设置按键完成设置。

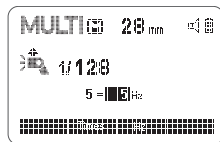

3. 短按 <+/-> 按键选中闪光输出值，接着旋转调节拨轮即可调节闪光输出值，调节完毕短按设置按键完成设置。闪光输出范围：1/256-1/4。

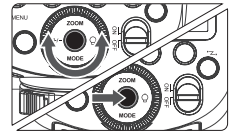

如何确定快门速度

频闪闪光停止之前，快门应保持开启状态。使用下面公式计算快门速度，然后用相机进行设置。

$$\text{闪光次数} \div \text{闪光频率} = \text{快门速度}$$

例如，如果闪光次数设为 10（次）且闪光频率设为 5(Hz)，需将快门速度设为 2 秒或更长。

⚠ 为防止闪光灯过热导致损坏，请勿执行连续 10 次以上的频闪闪光。频闪闪光 10 次后，请让闪光灯至少冷却 15 分钟。如果您执行连续 10 次以上的频闪闪光连拍，为防止闪光灯过热，闪光可能自动停止。如果发生了这种情况，请让闪光灯至少冷却 15 分钟。

- 注：1. 反光很强的被摄体在暗背景前使用频闪闪光更加有效。
2. 推荐使用三脚架和 TTL 引闪器 XPROII。
3. 无法设置 1/1 和 1/2 闪光输出。
4. 即使相机拍摄模式设置为 B 门拍摄 (buLb)，也可以进行频闪闪光。
5. 频闪闪光模式无法设置高速同步。
6. 如果闪光次数显示为 --，闪光灯会连续闪光，直至快门关闭或电量耗尽。最大连续闪光次数如下表所示。

最大连续闪光次数

闪光输出	1	2	3	4	5
1/4	8	6	4	3	3
1/8	14	14	12	10	8
1/16	30	30	30	20	20
1/32	60	60	60	50	50
1/64	90	90	90	80	80
1/128	90	90	90	90	90
1/256	90	90	90	90	90

闪光输出	6-7	8-9	10	20-50	60-100
1/4	2	2	2	2	2
1/8	6	5	4	4	4
1/16	20	10	8	8	8
1/32	40	30	20	16	12
1/64	70	60	50	30	20
1/128	90	80	70	40	40
1/256	90	80	70	40	40

无线闪光拍摄 (2.4G 无线传输)

本章对使用无线电传输发送闪光 / 接收闪光拍摄进行说明。

本章将安装在相机上的 V1Pro F 称为主控单元, 受无线控制的 V1Pro F 称为从属单元。

此外, 您还可以另购 TTL 引闪器 XPROII 无线控制设为从属单位的 V1Pro F, 具体关于引闪器控制的详细说明, 请参考另购的引闪器说明书。

使具有无线电传输无线拍摄功能的闪光灯, 可按照与普通 TTL 自动闪光拍摄同样的方法, 轻松利用高级无线多重闪光拍摄。

只要为主控单位和从属单位设置为一致频道、组别、ID 等相关无线设置, V1Pro F (主控单元) 上的设置会自动应用到无线受控的 V1Pro F (从属单元)。因此, 在拍摄期间不需要操作接收单元。

• 使用三个从属单元进行自动闪光拍摄

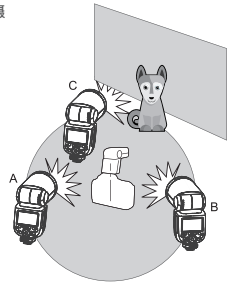

定位和操作范围 (无线闪光拍摄示例)

• 使用一个从属单元进行自动闪光拍摄

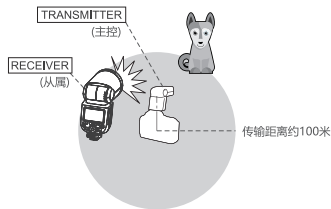

- 注: 1. 开始拍摄前请进行测试闪光和试拍。
2. 受从属单元的位置、周围环境、天气状况等影响, 传输距离可能更短。

使用多个从属单元进行自动闪光拍摄

您可以将从属单元分割为两个或三个组, 并在改变闪光光比 (闪光输出率) 的同时进行 TTL 自动闪光拍摄。此外, 可以为各闪光组 (最多 4 个组) 设定并使用不同的闪光模式进行拍摄。

• 使用两个从属单元进行自动闪光拍摄

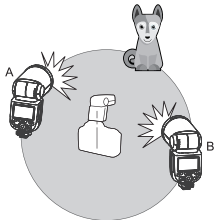

无线电传输无线设置

您可以切换普通闪光 / 无线闪光, 使用普通闪光, 请务必将无线设置为“关”, 即界面不显示 <[无线图标]>。

闪光灯设置为主控单位

短按 <[无线图标]> 无线按键, 令屏幕出现 <[无线图标]> 但不显示 <[RX]>。

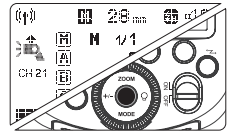

闪光灯设置为从属单位

短按 <[无线图标]> 无线按键, 令屏幕出现 <[无线图标]> 和 <[RX]>。

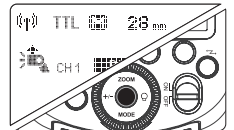

设置主控单元闪光

1. 短按 <[无线图标]> 无线按键, 令屏幕出现 <[无线图标]> 但不显示 <[RX]>。短按功能按键 1<M> 可以在 --/TTL/M 之间切换, 选一种作为主控单元的闪光模式。

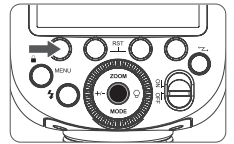

2. 按 MODE 按键可以切换至 Multi 模式。

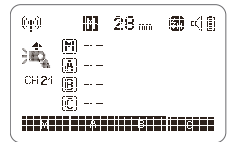

设置无线频道

如果在拍摄现场不止一个无线闪光系统，您可以通过更改无线频道来防止信号干扰，但需保证主控单元和从属单元设置为相同频道。

1. 短按 MENU 按键进入菜单设置。旋转调节拨轮至 <CH>，短按设置按键选中 CH 值。

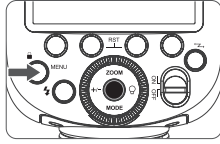

2. 旋转调节拨轮即可调节无线频道，范围为 01-32，选完短按设置按键完成设置。

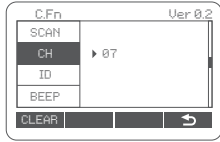

设置 ID

为了避免信号干扰，除了改变无线通讯频道还可以通过改变无线 ID 来防止干扰；主控单元和从属单元设为相同的频道和无线 ID 即可。进入 C.FnID，选择 01-99 其中任意一数字无线 ID 打开，选 OFF 无线 ID 关闭。

1. 短按 MENU 按键进入菜单设置。旋转调节拨轮至 <ID>，短按设置按键选中 ID 值。

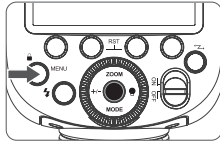

2. 旋转调节拨轮即可调节无线 ID，范围为 OFF/01-99，选完短按设置按键完成设置。

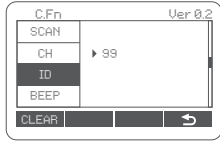

扫描空闲频道

为了避免其他人使用同样频道从而受到干扰，可以使用扫描空闲频道功能。

1. 短按 MENU 按键进入菜单设置。旋转调节拨轮至 <SCAN>，短按设置按键选中 SCAN 值。

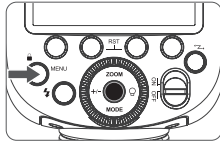

2. 旋转调节拨轮选择 START，选完短按设置按键开始扫描，不一会界面出现 8 组空闲频道，您可以参考扫描出来的频道重新设置主控闪光灯的无线频道。

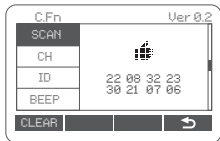

TTL: 全自动无线闪光拍摄

使用一个从属单元的自动闪光拍摄

1. 设置主控单位

短按无线按键，令屏幕显示无线 <TX>，即将安装在相机上的 V1Pro F 设为主控单元。将安装在相机上的 V1Pro F 设为主控单元。M/A/B/C 都可以单独设置 TTL。

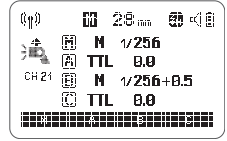

2. 设置从属单位

短按无线按键，令屏幕显示 <RX>，即可将被无线控制的闪光灯设为从属单位，可以选择 A/B/C/D/E。



3. 检查传输频道

主控单位和从属单位的无线频道需一致，举例，主控单位频道为 01，从属单位也为 01。

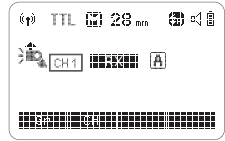
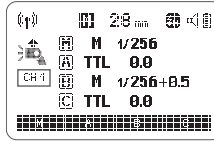

4. 定位相机和闪光灯

主控单位与从属单位传输距离最大约 100 米。

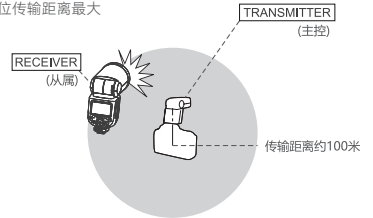

5. 检查闪光灯是否准备就绪

检查主控闪光灯就绪指示灯是否点亮。当从属闪光灯就绪时，自动对焦辅助光发光区域以 1 秒间隔闪烁。

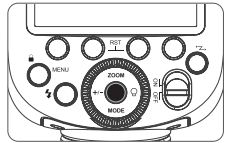

6. 检查操作

按下主控闪光灯的 <A> 试闪按钮，从属单元闪光。如果从属单元不闪光，检查是否将其放置在操作范围内。

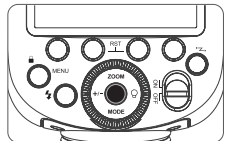

使用多个从属单元的自动闪光拍摄

当需要更大的闪光输出或想要更加轻松地照明时，可以增加从属单元的数量并将其作为单个闪光灯闪光。要添加从属单元，使用与“使用一个从属单元的自动闪光拍摄”相同的步骤，可以设定任何闪光组 (A/B/C/D/E)。

当增加了从属单元的数量或主控闪光灯闪光设为 ON 时，执行自动控制以使所有闪光灯以相同的闪光输出闪光并确保总闪光输出能够达到标准曝光。

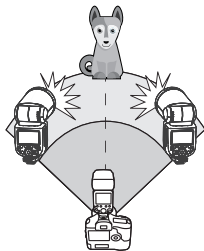

注: 1. 如果从属单元的自动关闭电源生效，按下主控单元的试闪按键可以开启从属单元，请注意在相机的测光定时工作期间，无法进行测试闪光。

2. 您可以短按 MENU 按键进入 C.Fn 自定义设置，更改从属单位自动关闭电源时间，可以将 RX STBY 调为 60min 或 30min。

使用全自动无线闪光

在主控单元上设定的闪光曝光补偿和其他设置也会在从属单元中自动设定，不需要操作从属单元。您可按照与普通闪光拍摄相同的方法使用以下设置进行无线闪光拍摄。

- 闪光曝光补偿

关于主控单位

您可以使用两个或两个以上主控单元，通过准备多台装有主控单元的相机，可以在保持相同照明（从属单元）期间更换相机进行拍摄。

M: 手动无线闪光拍摄

使用手动闪光的无线（多重闪光）拍摄，可以在主控单元上设定所有参数，为每个从属单元（闪光组）设定不同的闪光输出进行拍摄。

1. 将主控单位所有闪光组设为 M

短按无线按键，令屏幕显示无线 <R>，即将安装在相机上的 V1Pro F 设为主控单元。短按对应的功能按键 1/2/3/4<M/A/B/C> 令屏幕出现闪光组全部显示 <M>。

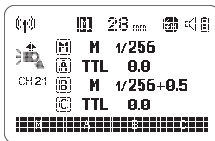

2. 设置各组闪光组的闪光输出

短按功能按键 <M/A/B/C> 选中闪光组后，旋转调节拨轮设置各组闪光输出，设置完毕短按设置按键退出设置。

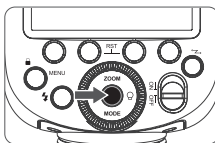

3. 将从属单位频道设置与主控一致

主控单位和从属单位的无线频道需设一致，举例，主控单位频道为 01，从属单位也为 01。

4. 拍摄照片

各组从属单位以设定的闪光输出闪光。

Multi: 手动无线闪光拍摄

1. 将主控单位设为无线频闪

短按 MODE 按键令屏幕出 <Multi> 后，短按无线按键，令屏幕同时出 <Multi> 和 <R>。

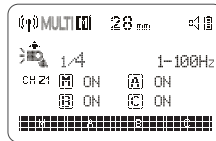

2. 设置无线频闪的闪光输出、闪光次数、闪光频率

短按 <+/-> 按键选中频闪闪光输出，旋转调节拨轮可调节其闪光输出，设置完毕短按设置按键退出。短按设置按键可选中闪光次数或闪光频率，旋转调节拨轮可调节闪光次数或闪光频率，设置完毕短按设置按键退出。

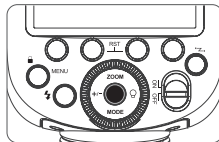

3. 设置从属闪光组无线频闪开/关

您可以直接在主控单位上设置从属单位 A/B/C 的无线频闪的开关。

4. 设置从属单位

短按无线按键，令从属单位屏幕出现 <Multi> 和 <RX>。

5. 将从属单位频道设置与主控一致

主控单位和从属单位的无线频道需设一致，举例，主控单位频道为 01，从属单位也为 01。

注: 在保证主控单位和从属单位频道、ID 设为一致的前提下，从属单位无需调节其参数，可直接在主控单位上调节参数。

转 TTL 档 / M 档拨钮功能

1. 在非无线模式下，拨动 TTL/M 拨钮可快速切换闪光模式。
2. TTL 切换到 M 手动模式时，默认有 TCM 转换。

屏幕锁定

长按 <L> 按键 2 秒，可进行锁定或解锁界面操作功能，锁定时显示屏下方显示 LOCKED。



模式锁定

长按 MODE 按键出现 $\langle \text{M} \rangle$ ，即可锁定当前闪光灯模式（TTL 模式或 M 模式或频闪模式），再次长按 MODE 按键解锁当前闪光灯模式，此时您可以短按 MODE 按键切换模式。

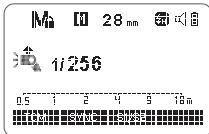

- 注：1. 如果墙壁或天花板太远，反射闪光可能太弱并导致曝光不足。
2. 墙壁或天花板应该是平坦的、白色的，以利于高效的反射。如果反射表面不是白色的，照片将出现偏色。

ZOOM: 设置闪光覆盖范围

该闪光灯有两种变焦方式：**自动变焦和手动变焦**。可以设置闪光覆盖范围以匹配 28-105 毫米 135 系统的镜头焦距。自动变焦时，焦距会随相机变焦镜头的改变而变化，以提供最佳闪光效果。

闪光覆盖范围有 2 种显示方式：APS 和 135 系统，您可以在 C.Fn-Zoom 选择显示方式。

手动变焦时，按下 $\langle \text{ZOOM} \rangle$ 变焦按钮。

- 转动调节旋钮更改闪光覆盖范围。
- 在显示 $\langle \text{A} \rangle$ 状态下，将自动设置闪光覆盖范围。

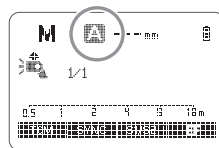

注：如果手动设置闪光覆盖范围，确保其覆盖镜头焦距，这样照片就不会出现阴影边缘。

神牛 2.4G 无线漏闪原因及解决办法

1. 外部环境 2.4G 信号干扰（如无线基站、2.4Gwifi 路由、蓝牙设备等）
→ 请调节引闪器的频道 CH 设置（建议 +10），找到无干扰的频道来工作，或者在工作时关闭其他 2.4G 设备。
2. 请确认闪光灯是否已经回电或者回电速度已经跟上连拍速度（闪光灯就堵指示灯已经亮起），并且没有处于过热保护或者其他异常状态中
→ 请下调闪光灯的档位，如是 TTL 模式可以尝试改为 M 模式（TTL 模式下需要预闪一次）。
3. 是否引闪器和闪光灯距离太近（距离 <0.5m）
→ 请在引闪器上打开“近距离无线模式”：
X1 系列：按住引闪按钮不放，然后开机，直至指示灯闪 2 次。
Xpro、X2T 系列：设置 C.Fn-DIST 为 0-30m。
X nano 系列：设置引闪距离为 0-30m。
4. 是否引闪器和接收端设备在低电状态
→ 请更换电池（引闪器电池建议使用 1.5V 一次性碱性电池）。

电池电量低警示

电池电量低时，电池符号 $\langle \text{B} \rangle$ 会闪烁，此时请更换电池。

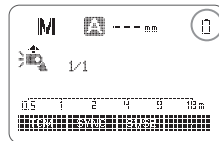

其他应用

同步插孔触发

同步插孔规格为 $\Phi 2.5\text{mm}$ ，此处可插入同步线或者触发器触发插头对闪光灯进行同步引闪。

自动辅助对焦

在低亮度或低对比度的拍摄情况下，闪光灯内置的自动对焦辅助灯将开启，使自动对焦更容易。当对焦困难时，红色辅助对焦灯亮起；当对焦准确，辅助对焦灯自动熄灭。

如想关闭自动辅助对焦功能，短按 MENU 按键进入 C.Fn 设置，可将“AF”调至“OFF”。

注：用户在使用时，如发现辅助对焦灯未亮起，是因为相机已经处于准确对焦状态。可以支持辅助对焦相机列表：X-PRO2、X-T20、X-T2、X-T1、GFX50S、GFX50R

位置	有效范围
中央	0.6-10 米 / 2.0-32.8 英尺
边缘	0.6-5 米 / 2.0-16.4 英尺

反射闪光

通过将闪光灯头指向墙壁或天花板，闪光在照亮被摄体前被墙面反射。这可以减轻被摄物体背后的阴影，获得更自然的摄影效果。称之为反射闪光。

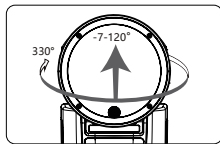

旋转闪光灯头来设置反射方向

C.Fn: 自定义设置

短按 MENU 按键可进入 C.Fn 自定义设置。

自定义功能符号	功能	符号	说明
m/ft	距离指示显示	m	米
		ft	英尺
AF	自动对焦辅助闪光	ON	启动
		OFF	关闭
STBY	自动关闭电源	ON	启动
		OFF	关闭
RX STBY	从属单元自动关闭电源计时器	60min	当闪光灯设为从属单位时，超过 60 分钟没有人操作，从属单位自动关闭电源。
		30min	当闪光灯设为从属单位时，超过 30 分钟没有人操作，从属单位自动关闭电源。
SCAN	扫描空闲频道	OFF	关闭
		START	开启扫描空闲频道
CH	无线频道	01-32	32 个频道
ID	识别号 ID	OFF	关闭
		01-99	99 个无线 ID
BEEP	提示音	ON	开启
		OFF	关闭
LIGHT	背光点亮时间	12sec	12 秒后自动熄灭
		OFF	一直熄灭
		ON	一直点亮
LCD	液晶屏对比度	-3+3	7 个级别
zoom	zoom 显示方式	APS	APS 系统
		135	135 系统

- 提示: 1. 右上角“Verx.x”表示固件版本号。
 2. 旋转调节拨轮可选自定义功能及其某项参数。
 3. 短按设置按钮可选自定义功能或确认某项设置。
 4. 自定义功能设置完毕后, 短按 MENU 按键返回主界面, 相机可以进行拍摄。
 5. 进入 MENU 菜单后, 长按功能按键 1<CLEAR> 直至出现“OK”, 表示 C.Fn 参数已重置完毕。

保护功能

热保护

- 为防止闪光灯过热并损坏, 请勿在 1/1 档位时进行超过 100 次的快速连续闪光。100 次连续闪光后, 要让闪光灯至少冷却 10 分钟。
- 如您在进入超过 100 次连续闪光后马上继续进行更多次闪光, 内部的防过热功能可能会被激活, 使回电时间变为 10 秒以上。如果发生这种现象, 请让闪光灯冷却约 10 分钟, 闪光灯便会恢复正常。
- 热保护启动后, 显示屏上的符号会显示。

激活过热保护功能的连续闪光次数:

功率档位	连续闪光次数
1/1	100
1/2 (+0.1~+0.9)	150
1/4(+0.1~+0.9)	300
1/8(+0.1~+0.9)	300
1/16(+0.1~+0.9)	1100
1/32(+0.1~+0.9)	3500
1/64(+0.1~+0.9)	3500
1/128(+0.1~+0.9)	3500
1/256(+0.1~+0.9)	3500

注: 不同 Zoom 值下同一个档位的热保护次数是一样的。

高速同步模式下, 激活热保护功能的连续闪光次数:

功率档位	连续闪光次数
1/1	60
1/2 (+0.1~+0.9)	70
1/4(+0.1~+0.9)	100
1/8(+0.1~+0.9)	100
1/16(+0.1~+0.9)	100
1/32(+0.1~+0.9)	100
1/64(+0.1~+0.9)	100
1/128(+0.1~+0.9)	100
1/256(+0.1~+0.9)	100

规格参数

型号	V1 Pro F
兼容相机	FUJIFILM 富士数码相机单反反光相机
功率 (1/1 档位)	76Ws
闪光覆盖范围	28 - 105 毫米或 18 - 69 毫米 • 自动变焦 (自动设置适合镜头焦距和图像尺寸的闪光覆盖范围) • 手动变焦 • 闪光灯头旋转 / 倾斜, 水平 0~330°, 垂直 -7°~120° (反射闪光)
闪光持续时间	1/300 秒 - 1/20000 秒
曝光控制	
曝光控制系统	TTL 自动闪光、手动闪光
闪光曝光补偿 (FEC)	手动: 在 ±3 档间以 1/3 档为增量调节
同步方式	高速同步 (最高 1/8000 秒), 前帘同步, 后帘同步
频闪闪光	具备 (最大闪光次数 90 次; 最大闪光频率 100Hz)
无线闪光 (无线电 2.4G 传输)	
无线功能	主控单元发射, 从属单元接收、关闭
主控单元组	M,A,B,C
可控制从属单元组	A,B,C,D,E (E 组可使用 X 系列的引闪器控制)
传输范围 (约)	100m
频道	32 组: 01~32
ID	OFF/01~99
自动对焦辅助光	
有效范围 (约)	中央: 0.6-10 米 / 边缘: 0.6-5 米
LED 造型灯	
功率	2w
色温	3300K±200K
电源	
内置锂电	7.2V/2980mAh 锂电池
回电时间	约 1.3 秒, 闪光灯准备就绪, 回电指示灯亮起
闪光次数 (1/1 档闪光输出)	约 500 次
节能	闪光灯设置为主控单元时超过 90 秒左右会自动关闭电源。设置为从属单元时 60 分钟 (或 30 分钟) 进入休眠状态。
同步触发方式	热靴, 2.5mm 同步线
尺寸	
体积	156mm×76mm×124mm
净重 (不含电池) ≈	466g
净重 (含电池) ≈	580g

规格和参数如有变更, 恕不另行通知。

故障排除指南

如果遇到问题，请参阅此故障排除指南。

闪光灯不闪光

- 闪光灯没有牢固地安装在相机上。
→将闪光灯热靴座牢固地安装在相机上。
- 闪光灯和相机的电子触点变脏。
→请清洁触点。

电源自动关闭

- 当灯作为主控单元时，超过 90 秒无人操作后，自动电源关闭功能生效。
→半按快门按钮或机身任意按键唤醒。
- 作为从属单元在 60 分钟（或者选择 30 分钟）无任何操作时，闪光灯会进入休眠状态。
→可按机身任意按键唤醒。

自动变焦不工作

- 闪光灯没有牢固地安装在相机上。
→将闪光灯的热靴座牢固地安装在相机上。

闪光曝光不足或过度

- 使用高速同步。
→使用高速同步，有效的闪光范围会更小，需要确保被摄体位于显示的有效闪光范围内。
- 闪光灯使用手动曝光模式。
→改为 TTL 模式或修改闪光输出功率设置。

相片出现暗角或者被摄物体只有局部能照亮

- 相机镜头焦距超出闪光灯的覆盖范围。
→请检查闪光灯当前的覆盖焦距，本产品的灯头变焦范围是全画幅系统 28-105mm 或非全画幅系统 18mm-69mm。

固件升级

- 本产品 USB 接口为 USB-C 接口，请使用 USB-C 数据线。
- 产品升级固件需要 Godox G3 程序软件支持，升级固件前请先下载安装 Godox G3 固件升级软件，再选择相应的固件文件。
- 由于产品进行固件升级，说明书请以最新电子版为准。

兼容相机列表

根据富士对闪光灯的的控制不同，分为以下类别进行区分：

A 类：X-Pro2, X-T20, X-T2, X-T1, X-T3, X-T4, X-T30, GFX50S, GFX50R

B 类：X-Pro1, X-T10, X-E1, X-A3

C 类：X100F, X100T

相机兼容及功能支持对照表：

相机	机顶闪光灯						重复闪光
	TTL 闪光控制			M 闪光控制			
	标准	REAR (后帘同步)	HSS (高速同步)	标准	REAR (后帘同步)	HSS (高速同步)	
A 类	√	√	√	√	√	√	
B 类	√	--	--	√	--	--	
C 类	√	√	√	√	√	√	

相机	2.4G 主控从属闪光灯						重复闪光
	TTL 闪光控制			M 闪光控制			
	标准	REAR (后帘同步)	HSS (高速同步)	标准	REAR (后帘同步)	HSS (高速同步)	
A 类	√	√	√	√	√	√	
B 类	√	--	--	√	--	--	
C 类	√	√	--	√	√	--	

相机	AF 辅助对焦灯
A 类	√
B 类	--
C 类	--

注：1. 相机 X100T 无后帘同步功能
2. AF 辅助对焦灯在快门低速 (< 200) 时方可点亮。
3. 此表格仅列举目前已测试的相机型号，未涵盖所有富士系列相机。其他相机型号，用户可自行测试。

维护保养

- 闪光灯在工作时，如发现异常，应立即关掉电源，查明原因。
- 灯体应避免震动，平时注意表面除尘。
- 灯体稍有发热为正常现象，无特别需要时，勿连续引闪。
- 所有维修概由本厂指定的可供原配件的维修部负责。
- 1 年保修，消耗品如灯管等，不在 1 年保修范围。
- 经发现，擅自检修此闪光灯的，将取消闪光灯之一年保修期，维修需要收取相关费用。
- 如果本品出现故障或者被水淋湿，在专业人员维修后方可继续使用。
- 如有技术更改，恕不另行通知。

Important Safety Instructions

This product is a professional photographic equipment, to be operated by professional personnel only. The following basic safety precautions must be followed when using this product: All transport protective materials and packaging on the product must be removed before use.

1. Carefully read and fully understand the instruction manual before use and strictly follow the safety instructions. Failure to do so may result in death, serious injury, damage to the product, or other property damage.
2. This product is a professional lighting fixture, children are prohibited from using it. Children must be closely supervised by adults when approaching the fixture, to prevent collisions with the fixture or unauthorized use that could cause personal injury.
3. This is not an ordinary lighting fixture and must not be used for general illumination. Anyone with a history of eye damage or sensitivity should avoid using this fixture or looking directly at it.
4. Extreme caution must be exercised when using it, do not touch high-temperature parts such as flash tubes to avoid burns.
5. Do not point the flash directly at the eyes (especially baby's eyes) under any circumstances, as this could impair vision in a short time. Turn off immediately if discomfort occurs, stop using, and seek medical attention promptly.
6. Do not use damaged equipment or accessories. Allow professional repair technicians to inspect and confirm normal operation before continuing use after repairs.
7. Stop using immediately if the product shell is cracked due to falling, squeezing, or strong impact, to avoid touching the internal electronic components and getting an electric shock.
8. This device is not waterproof. Keep it dry and avoid immersing it in water or other liquids. It should be installed in a ventilated and dry location and avoid using in rainy, humid, dusty, or overheated environments. Do not place items above the device or allow liquids to flow into it to prevent danger.
9. Do not disassemble without authorization. If the product malfunctions, it must be inspected and repaired by our company or authorized repair personnel.
10. Before storing the device, ensure it has completely cooled down.
11. Do not place the device near alcohol, gasoline, or other flammable volatile solvents or gases such as methane and ethane.
12. Do not use or store this device in potentially explosive environments.
13. Maintain at least 1 meter distance between the lamp head and the user, other people, and heat-sensitive or flammable items during and after use.
14. Do not use accessories not been approved by our company, as this may cause fire, electric shock or personal injury.
15. Clean gently with a dry cloth. Do not use a wet cloth as it may damage the device.
16. This instruction manual is based on rigorous testing. Changes in design and specifications are subject to change without notice. Check official website for latest instruction manual and product updates.
17. This product is powered by lithium batteries, who have limited lifespans and will gradually lose their charging capacities, which is irreversible. As the battery ages, the product's battery life will decrease. The lifespan of lithium battery is estimated to be 2 to 3 years. Please regularly check the battery, and if the charging time significantly increases or the battery life significantly decreases, consider replacing the battery.
18. This product is equipped with lithium batteries. The following are the storage recommendations: Charge the battery to about 50% before storage. Charge it to about 50% at least every six

months. Removable batteries should be stored separately. The storage temperature should be between 0°C and 40°C.

19. Precautions for using lithium batteries:
 - Do not disassemble, crush, or puncture the battery;
 - This battery is not waterproof, keep it dry and avoid immersing it in water or fog.
 - Avoid short-circuiting the battery contacts;
 - Do not expose the battery to or put it into fire;
 - Do not expose the battery to temperatures above 60°C;
 - Keep out of reach of children;
 - Protect the battery from excessive shock or vibration;
 - Do not use a damaged battery;
 - If the battery leaks, avoid contact with the leaking fluid;
 - If the battery fluid comes into contact with your eyes, immediately rinse with water for at least 15 minutes. Lift your eyelids until there are no signs of fluid and seek medical attention promptly.
20. Confirm and comply with all relevant local laws and regulations when handling any batteries.
21. The warranty period for this device as a whole is one year. Consumables (such as batteries), adapters, power cords, and other accessories are not covered by the warranty.
22. Unauthorized repairs will void the warranty and will incur charges.
23. Please check the status and power of the lithium battery upon receipt. If there are any quality issues, please contact Godox or our authorized dealer within the warranty period.
24. Failures from improper operation is not covered under warranty.

Foreword

Thank you for purchasing!

This V1Pro F camera flash applies to FUJIFILM cameras and is compatible with TTL auto flash. With this TTL compatible flash, you will get a simpler and better shooting experience, easily achieve a correct flash exposure even in complex light-changing environments.

Main Features

- With round lens to achieve soft, even and more creative light effects.
- 2W LED modeling lamp with brightness adjustment from 1 to 10.
- 76Ws flash power output at 1/1 step in M mode, 81 steps adjustable from 1/1 to 1/256.
- 7.2V/2980mAh lithium battery provides 1.3s recycle time at 1/1 step.
- Fully support FUJIFILM TTL camera flash. Workable as transmitter or receiver unit in a wireless flash group.
- Use dot-matrix LCD panel to achieve clear and convenient operations.
- With built-in 2.4GHz wireless system to support remote transmitting and receiving.
- Can be collocated with power pack PB960 to achieve quicker recycle time.
- Support use with detachable sub flash SU-1 for better filling light.
- Provide multiple functions, include manual flash, multi flash, HSS, Second-Curtain Sync, FEC, etc.
- Stable consistency in brightness and color temperature with good even lighting.
- Support firmware upgrade to better compatible with Canon cameras.

Note: Power pack PB960 is sold separately.

Contents

25	Foreword
25	Main Features
27	Name of Parts
	Body
	Control Panel
	Detachable Sub Flash SU-1
	LCD Panel
29	What's Inside
29	Separately Sold Accessories
30	Battery
30	Battery Level Indication
30	Power Management
30	Modeling Lamp
30	Mounting/Detaching the Camera Flash
31	Installing/Detaching SU-1
31	Using SU-1
32	Flash Mode – TTL: Auto Flash
	FEC (Flash Exposure Compensation)
	High-Speed Sync
	Second-Curtain Sync
33	Flash Mode – M: Manual Flash
34	Flash Mode – Multi: Stroboscopic Flash
35	Wireless Flash Shooting: 2.4G Wireless Transmission
	Wireless Settings
	Setting the Transmitter Unit Flash Mode
	Wireless Channel Settings
	ID Settings
	Scan the Spare Channel
	TTL: Fully Automatic Wireless Flash Shooting
	M: Wireless Flash Shooting with Manual Flash
	Multi: Wireless Flash Shooting with Manual Flash
	TTL/M Mode Switch Function
	Screen Lock
	Mode Lock
42	The Reason & Solution of Not Triggering in Godox
	2.4G Wireless
42	Other Applications
	Sync Triggering
	Auto Focus Assist Beam
	Bounce Flash
	ZOOM: Setting the Flash Coverage
	Low Battery Warning
44	C.Fn: Setting Custom Functions
44	Protection Function
46	Technical Data
47	Troubleshooting
47	Firmware Upgrade
47	Compatible Camera Models
49	Maintenance

Name of Parts

Body

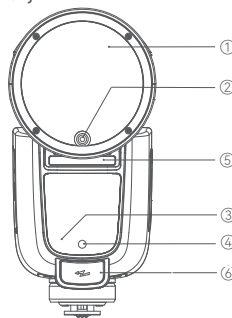

1. Flash Head
2. LED Modeling Lamp
3. Optical Sensor
4. Focus Assist Beam
5. External Flash Interface
6. External Power Pack Port
7. Bounce Angle Scale
8. Hot Shoe
9. LCD Panel
10. Hot Shoe Fixing Buckle
11. Lithium Battery
12. Hot Shoe Lock Ring
13. USB-C Charging Port
14. Charging Indicator

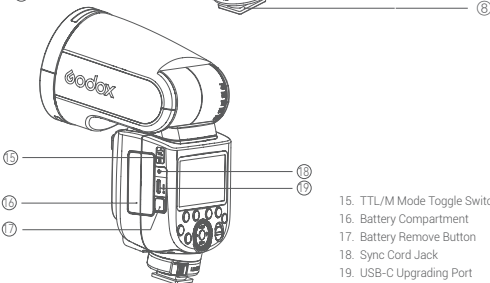
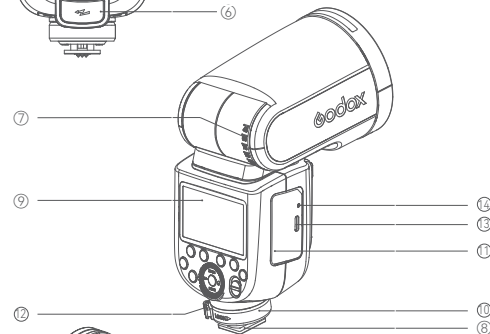

15. TTL/M Mode Toggle Switch
16. Battery Compartment
17. Battery Remove Button
18. Sync Cord Jack
19. USB-C Upgrading Port

Control Panel

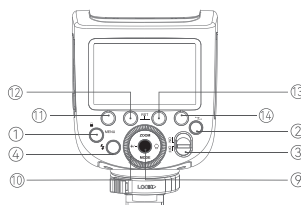

1. MENU/☑ Button
2. <←Z> Wireless Button
3. ON/OFF Power Switch
4. Test Button / Recycle Indicator
5. <+/->FEC/Flash Output Setting Button
6. <ZOOM> Zoom Button
7. <MODE> Mode Button

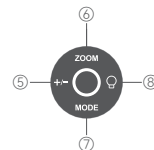

8. LED Modeling Lamp Button
9. Set Button
10. Select Dial
11. Function Button 1
12. Function Button 2
13. Function Button 3
14. Function Button 4

Detachable Sub Flash SU-1

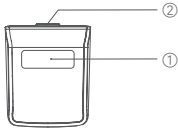

1. Flash Tube
2. Detaching Pusher

LCD Panel

TTL Auto Flash

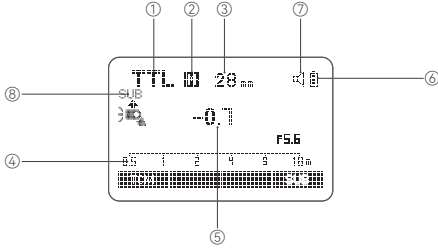

1. TTL: TTL Auto Flash
2. A: Auto Zoom M: Manual Zoom
3. Zoom Display (Auto/28-105mm) or (Auto/18-69mm)
4. Effective Flash Range/Shooting Distance (m/ft)
5. Flash Exposure Compensation Amount
6. Battery Level Indication
7. Beeper
8. Sub Flash SU-1 ON

Manual Flash

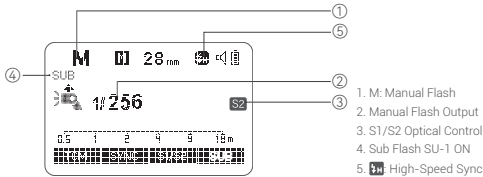

1. M: Manual Flash
2. Manual Flash Output
3. S1/S2 Optical Control
4. Sub Flash SU-1 ON
5. High-Speed Sync

Note: 1. The display will only show the settings currently applied.
 2. The functions displayed above function buttons 1 to 4, such as <sync> and M/A/B/C/, change according to settings's status.
 3. When a button or dial is operated, the LCD panel will be illuminated.
 4. The <SUB> icon will display on the panel only after the sub flash is inserted into the flash.

Multi Flash

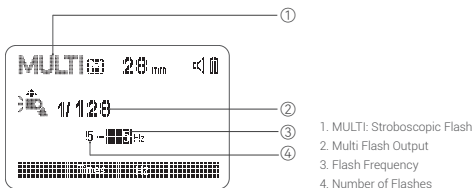

1. MULTI: Stroboscopic Flash
2. Multi Flash Output
3. Flash Frequency
4. Number of Flashes

28

Radio Transmission Shooting:

Transmitter Unit (2.4G Wireless Transmitting)

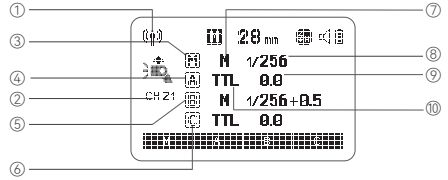

1. Radio Transmission Shooting
2. Transmitter Channel
3. Group M: Transmitter Unit Group M
4. Group A: Receiver Unit Group A
5. Group B: Receiver Unit Group B
6. Group C: Receiver Unit Group C
7. M: Manual Flash
8. Flash Output
9. Flash Exposure Compensation Amount
10. TTL: TTL Auto Flash

Receiver Unit (2.4G Wireless Receiving)

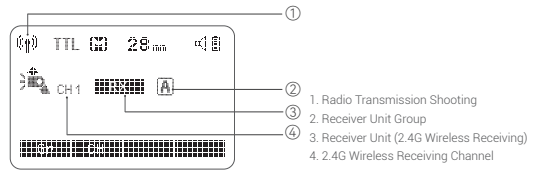

1. Radio Transmission Shooting
2. Receiver Unit Group
3. Receiver Unit (2.4G Wireless Receiving)
4. 2.4G Wireless Receiving Channel

What's Inside

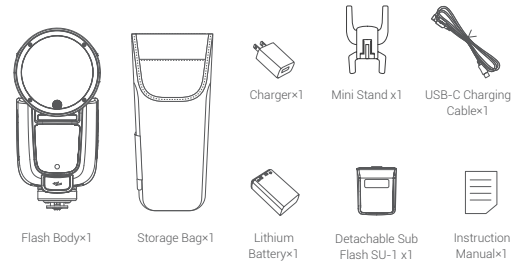

Separately Sold Accessories

The product can be used in combination with the following accessories sold separately, so as to achieve the best photography effects:

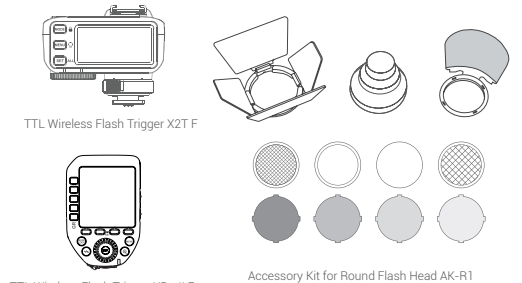

Accessory Kit for Round Flash Head AK-R1

29

Battery

Detaching battery:

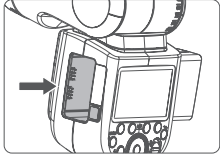

Press and hold the battery remove button, then push the battery out of the battery compartment.

Installing battery:

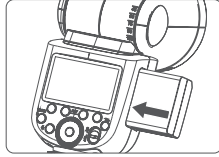

Insert the battery into the battery compartment in the direction as referred below until it's firmly locked.

Battery Level Indication

Make sure the battery pack is securely loaded in the flash. Check the battery level indication on the LCD panel to see the remaining battery level.

Battery Level Indication	Meaning
3 grids	Full
2 grids	Middle
1 grid	Low
Blank grid	Lower battery, please recharge it.
Blinking	The battery level is going to be used out, and the flash is not functional in this status. Note: Please recharge the battery as soon as possible (within 10 days). Then, the battery can be used or be placed for long period.

Power Management

Use ON/OFF power switch to power the flash unit on or off. Turn off if it will not be used for an extended period of time.

Setting as a transmitter unit, the flash will turn the power off automatically after a certain period (approx. 90 seconds) of idle use. Press the camera shutter halfway or press any flash button will wake up the flash unit. Setting as a receiver flash, it will enter sleep mode after 60 minutes (or 30 minutes) of idle use. Pressing any flash button will wake it up.

- Note:
1. Setting the C.Fn-STBY function to OFF is recommended when the flash is used off camera.
 2. Auto power off timer function of a receiver unit is set to 60 minutes by default. Another option "30 minutes" is available in C.Fn-RX.
 3. The LCD panel will lighten on when operating the buttons or select dial.

Modeling Lamp

Press the modeling lamp button to set the modeling lamp, press the set button to turn on or off the modeling lamp. When turning the modeling lamp on, turn the select dial to adjust its brightness in 10 levels (01~10).

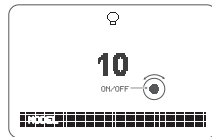

Mounting/Detaching the Camera Flash

Mounting the camera flash:

Press the hot shoe fixing buckle and rotate it to the left, insert the camera flash into the camera's hot shoe.

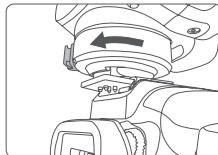

Then rotate it to the right until it locks up.



Detaching the camera flash:

Press and rotate the hot shoe fixing buckle to the left until it is loosened, then take off the camera flash.

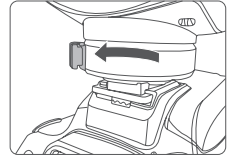

Installing/Detaching SU-1

Installing:

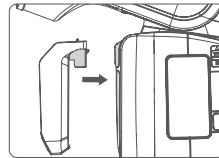

Align the detachable sub flash SU-1 with the external flash interface of V1Pro F and insert it parallelly, then press it down, a "click" sound means it's properly installed.

Detaching:

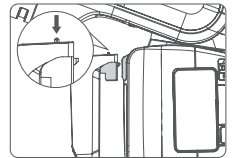

Push the detaching pusher on SU-1 and pull it up at the same time to detach it.

Using SU-1

With detachable sub flash SU-1 attached to the external flash interface of V1Pro F, better filling light effects can be achieved in M (manual) flash/TTL auto flash mode, this is helpful for portrait shooting.

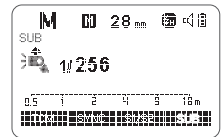

Instructions for Using
Mount SU-1 directly to the external flash interface of V1Pro F, press the MODEL button to set the flash to M (manual) flash/TTL auto flash mode, then press function button 4 <SUB> to enter sub flash settings interface, and press function button 3 <ON/OFF> to turn on/off.



When the sub flash is turned on, turn the select dial can adjust flash output of the sub flash from 1/128 to 1/1 in 22 flash steps, with +1/3 increment each step.

- Note:
1. SU-1 is not useable in wireless transmission shooting.
 2. SU-1 is not useable in high-speed sync.
 3. The flash head need to be uplifted in order to use SU-1 properly.

Flash Mode – TTL: Auto Flash

In TTL mode, the camera's metering system detects the flash reflected from the subject and automatically adjusts the flash output so that the subject and background are evenly exposed. In this mode, multiple functions are available: FEC, HSS, second curtain sync, etc.

Press <MODE> mode button to enter TTL mode, the LCD panel will display <TTL>.

- Press the camera shutter halfway to focus. The aperture value and effective flash range will be displayed in the LCD panel.
- When the shutter is fully pressed, the flash will fire a pre-flash that the camera will use to calculate exposure and flash output the instant before the photo is taken.

FEC (Flash Exposure Compensation)

With FEC function, this flash can adjust from -3 to +3 with 1/3 increment each step. It is useful in situations where minor adjustment of the TTL system is needed based on the environment.

Setting FEC Amount

1. Press the <+/-> button, FEC amount will be highlighted on the LCD panel.

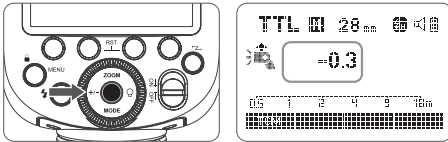

2. Turn the select dial to set the FEC amount. "0.3" means 1/3 step, "0.7" means 2/3 step. To cancel the FEC, set the amount to "0".

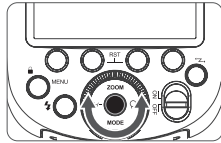

3. Press set button again to confirm the setting.

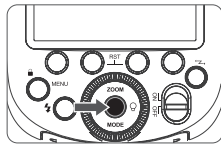

High-Speed Sync

High speed sync (FP flash) enables the flash to synchronize with all camera shutter speeds. This is convenient when you want to use aperture priority for fill-flash portraits.

Setting the flash to high-speed sync mode when it is on the camera:

Use the <Flash Setting> Flash Light Function Setting on the camera's shooting menu to adjust settings the flash. More details please refer to camera's instruction menu.

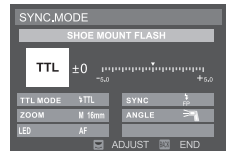

Flash Light Function Setting Interface of X-T2

- Note:
1. When choosing FP on the "SYNC" setting, it means the high-speed sync function is turned on.
 2. With high-speed sync, the faster the shutter speed, the shorter the effective flash range.
 3. Multi flash mode cannot be set in high-speed sync mode.
 4. Over-temperature protection may be activated after 60 consecutive high-speed sync flashes.

Second-Curtain Sync

With a slow shutter speed and second-curtain sync, you can create a light train following the subject. The flash fires right before the shutter closes.

Setting second-curtain sync:

Use the <Flash Setting> Flash Light Function Setting on the camera's shooting menu to adjust settings of the flash. More details please refer to camera's instruction menu.

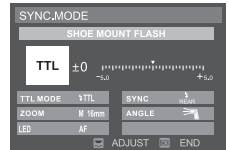

Flash Light Function Setting Interface of X-T2

- Note:
- When choosing REAR on the "SYNC" setting, it means the second-curtain sync function is turned on.

Flash Mode – M: Manual Flash

The flash output is adjustable from 1/1 full power to 1/256 power with 1/10 increment each step. To obtain a correct flash exposure, use a hand-held flash meter to determine the required flash output.

1. Press <MODE> mode button so that <M> is displayed on the LCD panel.

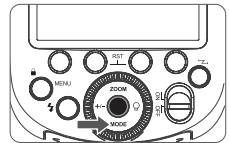

2. Press the <+/-> button to select flash output amount, then turn the select dial to adjust it. Press the set button again to confirm the setting.

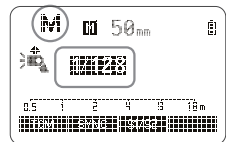

S1 Optic Control Unit Setting

In M manual flash mode, press <S1/S2> button so that this flash can function as an optic S1 secondary flash with optic sensor. With this function, the flash will fire synchronously when the main flash fires, the same effect as that by the use of wireless triggers. This helps create multiple lighting effects.

S2 Optic Control Unit Setting

In M manual flash mode, press <S1/S2> button so that this flash can also function as an optic S2 secondary flash with optic sensor. This is useful when cameras have pre-flash function. With this function, the flash will ignore a single "pre-flash" from the main flash and will only fire in response to the second, actual flash from the main flash.

- Note: 1. S1 and S2 optic control triggering is only available in M manual flash mode.
2. Press function 3 button <S1/S2> to switch between S1/S2 optic control or turn off this function.

Flash Mode – Multi: Stroboscopic Flash

With slow shutter speed in multi flash mode, a rapid series of flashes is fired. It can be used to capture multiple images of a moving subject in a single photograph.

You can set the flash frequency (number of flashes per sec. expressed as Hz), the number of flashes, and the flash output.

1. Press <MODE> mode button so that <Multi> is displayed on the LCD panel. .

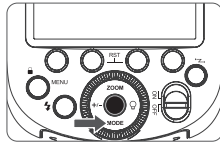

2. Press the function button 2 <Times> to select the number of flashes. Turn the select dial to set the number, then press it to confirm the settings. Press the function button 3 <Hz> to select the flash frequency. Turn the select dial to set the frequency, then press it to confirm the settings.

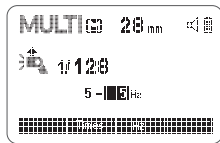

3. Press <+/-> button to select flash output amount. Turn the select dial to set the amount, then press it to confirm the settings.
Flash output range: 1/256-1/4.

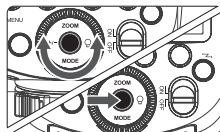

Calculating the Shutter Speed

During multi flash, the shutter remains open until the firing stops. Use the formula below to calculate the shutter speed and set it with the camera.

$$\text{Number of Flashes / Flash Frequency} = \text{Shutter Speed}$$

For example, if the number of flashes is 10 and the flash frequency is 5Hz, the shutter speed should be at least 2 seconds.

⚠ To avoid overheating and deteriorating the flash head, do not use multi flash more than 10 times in succession. After 10 times, allow the camera flash to rest for at least 15 minutes. If you try to use the multi flash more than 10 times in succession, the firing might stop automatically to protect the flash head. If this happens, allow at least 15 minutes' rest for the camera flash.

- Note: 1. Multi flash is most effective with a highly reflective subject against a dark background.
2. Using a tripod and TTL flash trigger XPROII is recommended.
3. A flash output of 1/1 and 1/2 cannot be set for multi flash.
4. Multi flash can also be used with "butb" mode.
5. Multi flash mode cannot be set in high-speed sync mode.
6. If the number of flashes is displayed as "--", the firing will continue until the shutter closes or the battery is exhausted. The number of flashes will be limited as shown by the following table.

Maximum Time of Consecutive Flashes

Flash output Hz	1	2	3	4	5
1/4	8	6	4	3	3
1/8	14	14	12	10	8
1/16	30	30	30	20	20
1/32	60	60	60	50	50
1/64	90	90	90	80	80
1/128	90	90	90	90	90
1/256	90	90	90	90	90

Flash output Hz	6-7	8-9	10	20-50	60-100
1/4	2	2	2	2	2
1/8	6	5	4	4	4
1/16	20	10	8	8	8
1/32	40	30	20	16	12
1/64	70	60	50	30	20
1/128	90	80	70	40	40
1/256	90	80	70	40	40

Wireless Flash Shooting: 2.4G Wireless Transmission

This section explains wireless transmitting/receiving flash shooting.

The V1Pro F attached to the camera is referred as the transmitter unit, while a V1Pro F that is wirelessly controlled is referred as the receiver unit.

You can also wirelessly control the V1Pro F set as the receiver unit with the TTL flash trigger XPROII (sold separately). For details on setting the flash trigger functions, see the its instruction manual.

Using a flash with a radio transmission wireless shooting function make it easy to shoot with advanced wireless multiple flash shooting, in the same way as TTL auto flash shooting.

As long as the channel, group, ID, and other relevant wireless settings of the transmitter and receiver units are set to the same, the settings on the V1Pro F (transmitter unit) will be automatically applied to the wirelessly controlled V1Pro F (receiver unit). Therefore, there is no need to operate the receiver unit during shooting.

Positioning and Operation Range (Example of wireless flash shooting)

• Auto Flash Shooting with One Receiver Unit

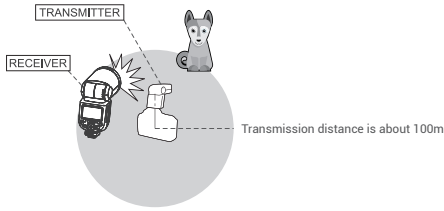

- Note: 1. Before shooting, perform a test flash and test shooting.
2. The transmission distance might be shorter depending on the conditions such as positioning of receiver units, the surrounding environment and whether conditions.

Auto Flash Shooting with Multiple Receiver Groups

You can divide the receiver units into two or three groups and perform TTL auto flash while changing the flash ratio (flash output ratio). In addition, you can set and shoot with a different flash mode for each firing group, for up to 4 groups.

• Auto Flash Shooting with Two Receiver Groups

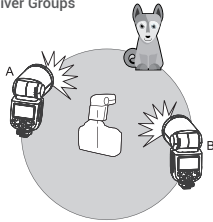

• Auto Flash Shooting with Three Receiver Groups

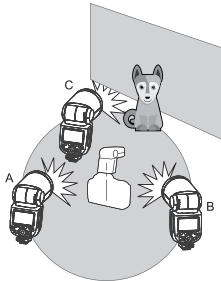

Wireless Settings

You can switch between normal flash and wireless flash. For normal flash shooting, be sure to set the wireless setting to "OFF", and the <☺> won't be displayed on the LCD panel.

Setting the Flash as A Transmitter Unit

Press <Z> button so that <☺> is displayed on the LCD panel, but the <RX> won't be displayed.

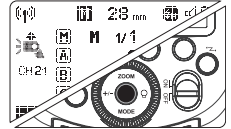

Setting the Flash as A Receiver Unit

Press <Z> button so that <☺> and <RX> are displayed on the LCD panel.

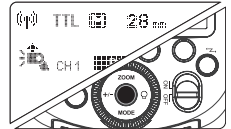

Setting the Transmitter Unit Flash Mode

1. Press the <Z> wireless button to make <☺> is displayed on the panel while <RX> is not displayed. Press the function button 1 <M> to select --/TTL/M. Choose one of them as the flash mode of the transmitter unit.

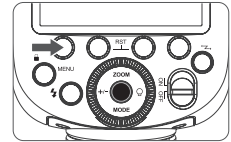

2. Press <MODE> button to switch to Multi mode.

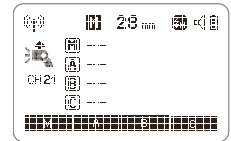

Wireless Channel Settings

If there are other wireless flash systems nearby, you can change the wireless channels to prevent signal interference. The wireless channels of the transmitter unit and the receiver unit(s) must be set to the same.

1. Press <MENU> menu button to enter menu setting. Turn the select dial to <CH>, then press the set button to choose CH.

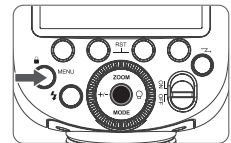

2. Turn the select dial to adjust wireless channel from 01 to 32. Press the set button to confirm.

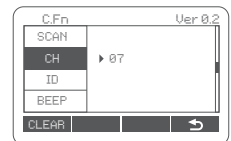

ID Settings

Change the wireless channels and wireless ID to avoid interference for it can only be triggered after the wireless channels and IDs of the transmitter unit and the receiver unit are set to the same. Press the menu button to enter C.Fn ID, press the set button to choose OFF to turn off the wireless ID, or choose any figure from 01 to 99.

1. Press <MENU> menu button to enter menu setting. Turn the select dial to <ID>, then press the set button to choose ID.

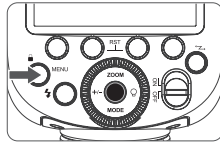

2. Turn the select dial to adjust wireless ID from 01 to 99 or OFF. Press the set button to confirm.

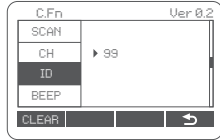

Scan the Spare Channel

You can scan the spare channel to avoid the interference of using the same channel by others.

1. Press <MENU> menu button to enter menu setting. Turn the select dial to <SCAN>, then press the set button to choose SCAN.

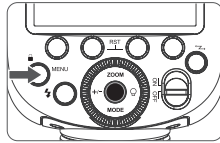

2. Turn the select dial to choose START, then press the set button to scan. And the 8 spare channels will be displayed for your choice.

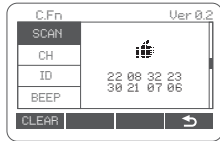

TTL: Fully Automatic Wireless Flash Shooting

Using Automatic Wireless Flash with a Single Receiver Unit

1. Transmitter Unit Setting

Press the wireless button and the <RX> icon is displayed on the LCD panel, then the V1Pro F attached to the camera is set as the transmitter unit.

Set the V1Pro F mounted on the camera as a transmitter unit, then M/A/B/C group can be set as TTL mode separately.

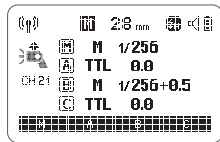

2. Receiver Unit Setting

Press the wireless button and the <RX> is displayed on the LCD panel, then the V1Pro S wirelessly controlled is set as the receiver unit A/B/C/D/E.



3. Check the Communication Channel

Set the wireless channels of transmitter unit and receiver unit to the same. For example, if the transmitter unit channel is set to 01, then the receiver unit channel needs to be 01 as well.

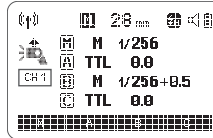

4. Position the Camera and Flashes

The transmission distance of the transmitter unit and receiver unit is about 100m.

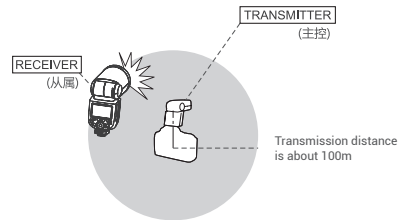

5. Check Whether the Flash is Ready

Check whether the transmitter unit's flash ready indicator is lightened. When the receiver unit's flash is ready, the AF-assist beam lighting area will blink at 1 second intervals.

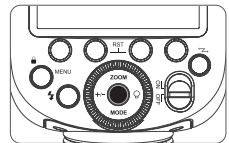

6. Check the Flash Operation

Press the transmitter unit's test button <T>. Then, the receiver unit will fire. If not, adjust the distance from the transmitter unit.

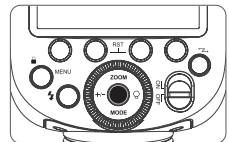

Using Automatic Wireless Flash with Multiple Receiver Units

When stronger flash output or more convenient lighting operation is needed, increase the number of receiver units and set it as a single receiver unit. To add receiver units, use the same steps as setting "using automatic wireless flash with a single receiver unit". Any flash group can be set (A/B/C/D/E).

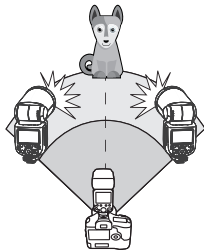

When the number of receiver units is increased or the transmitter unit flash firing is ON, automatic control is implemented to make all groups of flashes fire the same flash output and ensure the total flash output is up to standard exposure.

- Note:
1. If the receiver unit's auto power off function is on, press the transmitter unit's test button to power it on. Please note that test firing is unavailable during the camera's regular metering time.
 2. By pressing the menu button to enter C.Fn setting, the effective time of receiver unit's auto power off is changeable between 60min or 30min (RX STBY).

Using Fully Automatic Wireless Flash

The FEC and other settings that set on the transmitter unit will also be appeared on the receiver unit automatically. The receiver unit does not need any operation. Use the following settings to make wireless flash shooting according to the same methods with normal flash shooting.

- Flash Exposure Compensation

About Transmitter Unit

Use two or more transmitter units. By preparing several cameras that with transmitter units attached, cameras can be changed in shooting while keeping the same lighting source (receiver unit).

M: Wireless Flash Shooting with Manual Flash

Using wireless (multiple flash) shooting with manual flash, you can shoot with a different flash output setting for each receiver unit (flash group) while setting all parameters on the transmitter unit.

1. Set the Transmitter Unit's Flash Group to <M>

Press the wireless button and the icon is displayed on the LCD panel, then the V1 Pro F attached to the camera is set as the transmitter unit. Press the corresponding function button 1/2/3/4-<M/A/B/C> to make <M> is displayed in all the flash groups on the LCD panel.

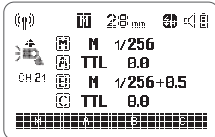

2. Set the Flash Output of Each Flash Group

Press function button <M/A/B/C> to choose a group. Turn the select dial to set the flash output of the group, then press the set button to confirm.

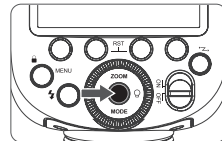

3. Set the Wireless Channels of Transmitter Unit and Receiver Unit to the Same

For example, if the transmitter unit channel is set to 01, then the receiver unit channel needs to be 01 as well.

4. Take Picture

Each receiver unit fires at the set flash ratio.

Multi: Wireless Flash Shooting with Manual Flash

1. Set the Transmitter Unit to Wireless Multi Flash

Press <MODE> mode button so that <Multi> is displayed on the LCD display, then press the wireless button so that <Multi> and are displayed on the LCD display at the same time.

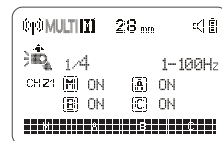

2. Set the Flash Output, Number of Flashes and Flash Frequency of the Wireless Multi Flash

Press <+/-> button to select flash output of multi flash. Turn the select dial to set the flash output amount, then press the set button to confirm the settings and exit. Press the set button to select number of flashes of flash frequency. Turn the select dial to set the number of flashes of flash frequency, then press the set button to confirm the settings and exit.

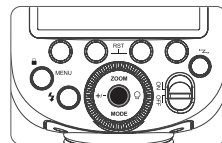

3. Turn On/Off the Wireless Multi Flash of Receiver Unit Group

The wireless multi flash of receiver unit A/B/C can be turned on or off directly on the transmitter unit.

4. Set the Receiver Unit

Press the wireless button to make the <Multi> and <RX> are displayed on the LCD panel of the receiver unit.

5. Set the Wireless Channels of Transmitter Unit and Receiver Unit to the Same

For example, if the transmitter unit channel is set to 01, then the receiver unit channel needs to be 01 as well.

Note: The parameters of receiver unit can be directly set on the transmitter unit on the condition that channels and IDs of them are set to the same.

TTL/M Mode Switch Function

1. Toggle the TTL/M mode toggle switch in non-wireless mode can switch flash mode.
2. TCM switch function is workable by default when switched to M manual mode from TTL mode.

Screen Lock

Press and hold the  button for 2s can lock or unlock the screen. "LOCKED" is displayed on the LCD panel when the screen is locked.



Mode Lock

Press and hold the <MODE> button to make the  is displayed on the panel, the current flash mode (TTL/M/RPT flash mode) is locked, press and hold again to unlock, then the flash mode can be switched by pressing the <MODE> button.

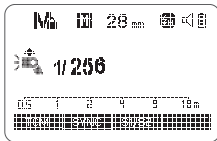

The Reason & Solution of Not Triggering in Godox 2.4G Wireless

1. **Disturbed by the 2.4G signal in outer environment (e.g. wireless base station, 2.4G wifi router, Bluetooth, etc.)**
→ To adjust the channel CH setting on the flash trigger (add 10+ channels) and use the channel which is not disturbed. Or turn off the other 2.4G equipment in working.
2. **Please make sure that whether the flash has finished its recycle or caught up with the continuous shooting speed or not (the flash ready indicator is lightened) and the flash is not under the state of over-heat protection or other abnormal situations.**
→ Please downgrade the flash power output. If the flash is in TTL mode, please try to change it to M mode (a pre-flash is needed in TTL mode).
3. **Whether the distance between the flash trigger and the flash is too close or not (< 0.5m).**
→ Please turn on the "close distance wireless mode":
X1 Series: Press and hold the triggering button then turn on the device until the indicator blinks twice.
Xpro and X2T Series: Set the C.Fn-DIST to 0-30m.
X nano: Set the trigger distance to 0-30m.
4. **Whether the flash trigger and the receiver end equipment are in the low battery states or not**
→ Please replace the battery.

Other Applications

Sync Triggering

The sync cord jack is a $\Phi 2.5\text{mm}$ plug. Insert a trigger plug here and the flash will be fired synchronously with the camera shutter.

Auto Focus Assist Beam

In poorly-lit or low-contrast shooting environments, the built-in auto focus assist beam will automatically light on to make it easier for auto focus. The beam will light up only when auto focus is difficult and get out as soon as the auto focus becomes correct.

If you want to turn off the auto focus assist beam, set the "AF" to "OFF" in the C.Fn settings.

Note: If you find the auto focus assist beam does not light up, this is because the camera has got a correct auto focus.
Camera models that supports auto focus assist beam: X-PRO2, X-T20, X-T2, X-T1, GFX50S, GFX50R.

Position	Effective Range
Center	0.6~10m / 2.0~32.8 feet
Periphery	0.6~5m / 2.0~16.4 feet

Bounce Flash

By pointing the flash head toward a wall or ceiling, the flash will bounce off the surface before illuminating the subject. This can soften shadows behind the subject for a more natural-looking shot. This is called bounce flash.

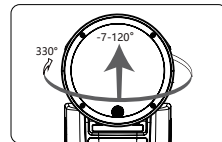

To set the bounce direction, hold the flash head and turn it to a satisfying angle.

- Note: 1. If the wall or ceiling is too far away, the bounced flash might be too weak and result in underexposure.
2. The wall or ceiling should be a plain, white color for high reflectance. If the bounce surface is not white, a color cast may appear in the picture.

ZOOM: Setting the Flash Coverage

The flash coverage can be set automatically or manually. It can be set to match the lens focal length from 28mm to 105mm(135 system). In auto zoom mode, the focal length changes in response to the camera's zoom lens to provide optimal flash results.

Choose APS or 135 system in the C.Fn-ZOOM

In manual zoom mode, press the <ZOOM> button.

- Turn the select dial to change the flash coverage.
- If <A> is displayed, the flash coverage will be set automatically.

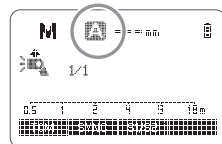

Note: If you set the flash coverage manually, make sure it covers the lens focal length so that the picture will not have a dark periphery.

Low Battery Warning

If the battery power is low,  will appear and blink on the LCD panel. Please replace the battery immediately.

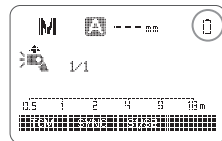

C.Fn: Setting Custom Functions

Press the menu button to enter C.Fn settings.

Custom Function Signs	Function	Options	Settings & Description
m/ft	Distance indicator	m	m
		ft	Feet
AF	AF-assist beam	ON	ON
		OFF	OFF
STBY	Auto sleep setting	ON	ON
		OFF	OFF
RX STBY	Receiver auto power off timer	60min	Power off automatically after 60 minutes of idle use when the flash is set as a receiver unit.
		30min	Power off automatically after 30 minutes of idle use when the flash is set as a receiver unit.
SCAN	Scan the spare channel	OFF	OFF
		START	Start to scan the spare channel
CH	Wireless Channel	01-32	Choose channels from 01-32
ID	ID	OFF	OFF
		01-99	Choose any figure from 01-99
BEEP	Beeper	ON	ON
		OFF	OFF
LIGHT	Backlighting time	12sec	Off in 12 sec.
		OFF	Always off
		ON	Always lighting
LCD	LCD contrast ratio	-3~+3	7 levels
ZOOM	Zoom display	APS	APS system
		135	135 system

- Note: 1. The "Verx.x" in the top-right corner refers to the software version.
 2. Turn the select dial to select the custom function No. and its parameters.
 3. Press set button to select the custom function No. and confirm its setting.
 4. After you set the custom function and press <MENU> menu button, the camera will be ready to shoot.
 5. Press and hold the function button 1 <CLEAR> in the MENU interface until "OK" is displayed on the panel, which means the parameters in C.Fn are reset.

Number of flashes that will activate over-temperature protection:

Power Output Level	Number of Flashes
1/1	100
1/2 (+0.1~+0.9)	150
1/4(+0.1~+0.9)	300
1/8(+0.1~+0.9)	300
1/16(+0.1~+0.9)	1100
1/32(+0.1~+0.9)	3500
1/64(+0.1~+0.9)	3500
1/128(+0.1~+0.9)	3500
1/256(+0.1~+0.9)	3500

Note: Numbers of flashes of over-temperature protection are different in different zoom values and different levels.

Number of flashes that will activate over-temperature protection in HSS mode:

Power Output Level	Number of Flashes
1/1	60
1/2 (+0.1~+0.9)	70
1/4(+0.1~+0.9)	100
1/8(+0.1~+0.9)	100
1/16(+0.1~+0.9)	100
1/32(+0.1~+0.9)	100
1/64(+0.1~+0.9)	100
1/128(+0.1~+0.9)	100
1/256(+0.1~+0.9)	100

Protection Function

Over-Temperature Protection

- To avoid overheating and deteriorating the flash head, do not fire more than 100 continuous flashes in fast succession at 1/1 full power. After 100 continuous flashes, allow a rest time of at least 10 minutes.
- If you fire more than 100 continuous flashes and then fire more flashes in short intervals, the inner over-temperature protection function may be activated and make the recycle time over 10 seconds. If this occurs, allow a rest time of about 10 minutes, and the flash unit will then return to normal.
- When the over-temperature protection is started, <> is shown on the LCD display.

Technical Data

Model	V1Pro F
Compatible Cameras	FUJIFILM cameras (TTL auto flash)
Power(1/1 output)	76Ws
Flash Coverage	28 to 105mm or 18 to 69mm <ul style="list-style-type: none"> • Auto zoom (flash coverage is set automatically to match the lens focal length and image size) • Manual zoom • Swinging/tilting flash head (bounce flash): 0 to 330° horizontally and -7° to 120° vertically
Flash Duration	1/300 to 1/20000 seconds
Exposure Control	
Exposure Control System	TTL auto flash and manual flash
Flash Exposure Compensation (FEC)	Manual: ±3 steps with 1/3 increment each step
Sync Mode	High-speed sync (up to 1/8000 seconds), first-curtain sync, and second-curtain sync
Multi Flash	Provided (up to 90 times, 100Hz)
Wireless Flash (Radio 2.4G Transmission)	
Wireless Function	Transmitter, Receiver, Off
Transmitter Unit Groups	M, A, B, C
Controllable Receiver Groups	A, B, C, D, E (E group can be controlled by X series flash trigger)
Transmission Range (approx.)	100m
Channels	32 (01~32)
ID	OFF/01~99
Auto Focus Assist Beam	
Effective Range (approx.)	Center: 0.6~10m / 2.0~32.8 feet Periphery: 0.6~5m / 2.0~16.4 feet
LED Modeling Lamp	
Power	2w
Color Temperature	3300K±200K
Power Supply	
Built-in Lithium Battery	7.2V/2980mAh
Recycle Time	Approx. 1.3 seconds. Green LED indicator will light up when the flash is ready.
Number of Flashes at 1/1 step	Approx. 500
Power Saving	Power off automatically after approx. 90s of idle use when set as a transmitter unit. Screen sleep automatically after approx. 60min (or 30min) of idle use when set as a receiver unit.
Sync Triggering Mode	Hot shoe, 2.5mm sync cord
Dimension	
W x H x D	6.14"×2.99"×4.88"
Net Weight Without Battery ≈	466g
Net Weight With Battery ≈	580g

Specifications and data may subject to changes without notice.

Troubleshooting

If there is a problem, refer to this troubleshooting guide.

The camera flash does not fire.

- The camera flash is not attached securely to the camera. Attach the camera's mounting foot securely to the camera.
- The electrical contacts of the camera flash and camera are dirty. → Clean the contacts.

The power turns off by itself.

- After 90 seconds of idle operation, auto power off took effect if the flash is set as a transmitter unit. → Press the shutter button halfway or press any flash button to wake up.
- After 60 minutes (or 30 minutes) of idle operation, the flash enter sleep mode if it is set as receiver unit. → Press any flash button to wake up.

Auto zoom does not work.

- The camera flash is not attached securely to the camera. → Attach the camera flash's mounting foot to the camera.

The flash exposure is underexposed or overexposed.

- You used high-speed sync. → With high-speed sync, the effective flash range will be shorter. Make sure the subject is within the effective flash range displayed.
- You used manual flash mode. → Set the flash mode to TTL or modify the flash output.

Photos have dark corners or only parts of the target subject are illuminated.

- The focal length of lens exceeds the flash coverage. → Check the flash coverage you set. This flash unit has the flash coverage between 28 to 105mm or 18mm to 69mm, which fits medium-format cameras.

Firmware Upgrade

1. This product supports firmware upgrade through the USB-C port, please use USB-C cable (sold separately).
2. As the firmware upgrade needs the support of Godox G3 software, please download and install the "Godox G3 firmware upgrade software" before upgrading. Then, choose the related firmware file.
3. Please refer to the latest electronic version of the instruction manual.

Compatible Camera Models

FUJIFILM cameras are divided into three kinds according to their different Controlling ways to camera flash:

- A: X-Pro2, X-T20, X-T2, X-T1, X-T3, X-T4, X-T30, GFX50S, GFX50R
 B: X-Pro1, X-T10, X-E1, X-A3
 C: X100F, X100T

Compatible camera models and functions support:

Camera	Camera Flash						Multi Flash
	TTL Flash			M Manual Flash			
	Standard	REAR	HSS	Standard	REAR	HSS	
A	✓	✓	✓	✓	✓	✓	✓
B	✓	--	--	✓	--	--	✓
C	✓	✓	✓	✓	✓	✓	✓

Camera	2.4G Wireless Control						Multi Flash
	TTL Flash			Manual Flash			
	Standard	REAR	HSS	Standard	REAR	HSS	
A	✓	✓	✓	✓	✓	✓	✓
B	✓	--	--	✓	--	--	✓
C	✓	✓	--	✓	✓	--	✓

Camera	AF Assist Beam
A	✓
B	--
C	--

Note: 1. X100T do not have second curtain sync (REAR) function.
 2. The AF assist beam will light up when the shutter is at low speed (< 200).
 3. This table only lists the tested camera models, not all Sony cameras. For the compatibility of other camera models, a self-test is recommended.
 4. Rights to modify this table are retained.

Maintenance

- Shut down the device immediately should abnormal operation be detected. Avoid sudden impacts and the product should be dedusted regularly.
- It is normal for the flash tube to be warm when in use. Avoid continuous flashes if unnecessary.
Maintenance of the flash must be performed by our authorized maintenance department which can provide original accessories.
- This product, except consumables e.g. flash tube, is supported with a one-year warranty.
Unauthorized service will void the warranty.
- If the product had failures or was wetted, do not use it until it is repaired by professionals.
Changes made to the specifications or designs may not be reflected in this manual.

FCC Statement

This device complies with part 15 of the FCC Rules. Operation is subject to the following two conditions: (1) This device may not cause harmful interference, and (2) this device must accept any interference received, including interference that may cause undesired operation.
 Any Changes or modifications not expressly approved by the party responsible for compliance could void the user's authority to operate the equipment.

Note: This equipment has been tested and found to comply with the limits for a Class B digital device, pursuant to part 15 of the FCC Rules. These limits are designed to provide reasonable protection against harmful interference in a residential installation. This equipment generates uses and can radiate radio frequency energy and, if not installed and used in accordance with the instructions, may cause harmful interference to radio communications. However, there is no guarantee that interference will not occur in a particular installation. If this equipment does cause harmful interference to radio or television reception, which can be determined by turning the equipment off and on, the user is encouraged to try to correct the interference by one or more of the following measures:

- Reorient or relocate the receiving antenna.
- Increase the separation between the equipment and receiver.
- Connect the equipment into an outlet on a circuit different from that to which the receiver is connected.
- Consult the dealer or an experienced radio/TV technician for help.

The device has been evaluated to meet general RF exposure requirement. The device can be used in portable exposure condition without restriction.

Warning

Operating frequency: 2403MHz-2483.0MHz
 Maximum EIRP Power: -10.82dBm

Declaration of Conformity
 GODOX Photo Equipment Co.,Ltd. hereby declares that this equipment are in compliance with the essential requirements and other relevant provisions of Directive 2014/53/EU. In accordance with Article 10(2) and Article 10(10), this product is allowed to be used in all EU member states.

For more information of DoC, Please click this web link:
<https://www.godox.com/eu-declaration-of-conformity/>
 The device complies with RF specifications when the device used at 0mm from your body.

产品保修

尊敬的用户，本保修卡是申请保修服务的重要凭证，请您配合销售商填写并妥善保管，谢谢！

产品信息	型号	产品条码
用户信息	姓名	联系电话
	通信地址	
销售商信息	名称	
备注	联系电话	
	通信地址	
	销售日期	

注：此表应由销售商盖章确认。

适用产品

本文件适用于相关《产品保修资讯》（见后面说明）所列产品，其他非属此范围的产品或部件（如促销品、赠品及其他出厂后附加的部件等）不在此保修承诺内。

保修期

产品及部件的相应保修期按相关的产品保修信息执行。保修期自产品首次购买日起算，购买日以购买产品时保修卡登记日期为准。

如何获得保修服务

您可直接与产品销售商或授权服务机构联系，也可拨打神牛产品售后服务电话，与我们联系，由我们的服务人员为您安排服务。申请保修时，您应提供有效的保修卡作为保修凭证，方可获得保修。如您不能提供有效的保修卡，则在我们确认产品或部件属于保修范围的情况下，也可以为您提供保修，但这不作为我们的义务。

不适用保修的情况

如产品存在下列情况，本文件项下的保证和服务将不适用：①产品或部件超过相应保修期；②错误或不适当使用、维护或保管导致的故障或损坏，如：不当搬运；非按产品合理预期用途使用；不当插拔外接设备；跌落或外力挤压；接触或暴露于不适当温度、溶剂、酸碱、水浸或潮湿环境；③由非神牛授权机构或人员安装、修理、更改、添加或拆卸造成的故障或损坏；④产品或部件原有识别信息被修改变更或删除；⑤无有效保修卡；⑥使用非合法授权、非标准或非公开发行的软件造成的故障或损坏；⑦因不可抗力或意外事件造成的故障或损坏；⑧其他非因产品本身质量问题导致的故障或损坏。遇上述情况，您应向相关责任方寻求解决，神牛对此不承担任何责任。因非在保修期或保修范围内的部件、附件或软件导致产品不能正常使用的，不是保修范围内的故障。产品使用过程中正常的脱色，磨损和消耗，不是保修范围内的故障。

产品保修

产品的保修期和服务类型按以下《产品保修信息》执行：

产品类别	选项名称	保修期(月)	保修服务类型
部件	主机	12	客户送修
	电池	3	客户送修
	充电器等带电性能的部件。	12	客户送修
其他	如电源线、同步线、外壳、保护罩、锁紧装置、包装等。	无	无保修

神牛产品售后服务电话：0755-29609320-8062

Warranty

Dear customers, as this warranty card is an important certificate to apply for our maintenance service, please fill in the following form in coordination with the seller and safe-keep it. Thank you!

Product Information	Model Name	Product Code Number Contact Number
Customer Information	Address Name	
Seller Information	Contact Number	
Note	Address Date of Sale	

Note: This form shall be sealed by the seller.

Applicable Products

The document applies to the products listed on the Product Maintenance Information (see below for further information). Other products or accessories (e.g. promotional items, giveaways and additional accessories attached, etc.) are not included in this warranty scope.

Warranty Period

The warranty period of products and accessories is implemented according to the relevant Product Maintenance Information. The warranty period is calculated from the day (purchase date) when the product is bought for the first time, and the purchase date is considered as the date registered on the warranty card when buying the product.

How to Get the Maintenance Service

If maintenance service is needed, you can directly contact the product distributor or authorized service institutions. You can also contact the Godox after-sale service call and we will offer you service. When applying for maintenance service, you should provide valid warranty card. If you cannot provide valid warranty card, we may offer you maintenance service once confirmed that the product or accessory is involved in the maintenance scope, but that shall not be considered as our obligation.

Inapplicable Cases

The guarantee and service offered by this document are not applicable in the following cases: ① The product or accessory has expired its warranty period; ② Breakage or damage caused by inappropriate usage, maintenance or preservation, such as improper packing, improper usage, improper plugging in/out external equipment, falling off or squeezing by external force, contacting or exposing to the improper temperature, solvent, acid, base, flooding and damp environments, etc; ③ Breakage or damage caused by non-authorized institution or staff in the process of installation, maintenance, alteration, addition and detachment; ④ The original identifying information of product or accessory is modified, alternated, or removed; ⑤ No valid warranty card; ⑥ Breakage or damage caused by using illegally authorized, nonstandard or non-public released software; ⑦ Breakage or damage caused by force majeure or accident; ⑧ Breakage or damage that could not be attributed to the product itself. Once met these situations above, you should seek solutions from the related responsible parties and Godox assumes no responsibility. The damage caused by parts, accessories and software that beyond the warranty period or scope is not included in our maintenance scope. The normal discoloration, abrasion and consumption are not the breakage within the maintenance scope.

Maintenance and Service Support Information

The warranty period and service types of products are implemented according to the following Product Maintenance Information:

Product Type	Name	Maintenance Period(month)	Warranty Service Type
Parts	Circuit board	12	Customer sends the product to designated site
	Battery	3	Customer sends the product to designated site
	Electrical parts e.g.battery charger, etc.	12	Customer sends the product to designated site
Other Items	Power cord, sync cable, lamp body, lamp cover,lockingdevice, package, etc.	No	Without warranty

Godox After-sale Service Call +86-755-29609320(8062)