

## Cutout Adapter Plate for Steam Table

<input type="checkbox"/> RO-ACC-STFE-APC1	<input type="checkbox"/> RO-ACC-STFE-APC3	<input type="checkbox"/> RO-ACC-STFE-APC5
<input type="checkbox"/> RO-ACC-STFE-APC2	<input type="checkbox"/> RO-ACC-STFE-APC4	<input type="checkbox"/> RO-ACC-STFE-APC6

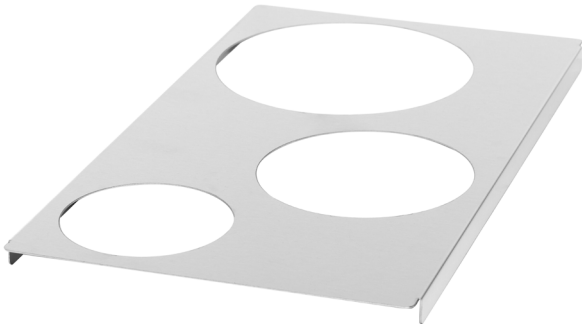

RO-ACC-STFE-APC1

### Features

- Made of grade 304 stainless steel
- Compact construction for quick washing
- Front and rear brackets
- Lateral structural reinforcements
- Compatible for all round inset container sizes
- Designed to replace one (1) full size 12" x 20" pan
- Quick and easy installation

RO-ACC-STFE-APC1

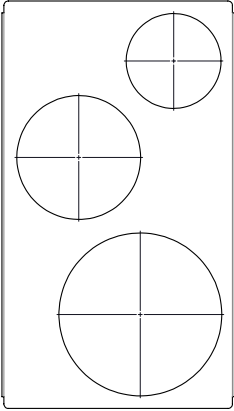

RO-ACC-STFE-APC2

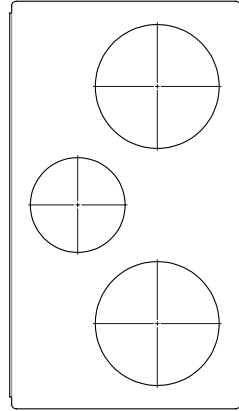

RO-ACC-STFE-APC3

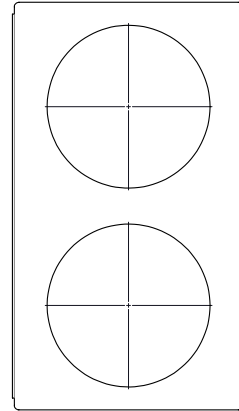

RO-ACC-STFE-APC4

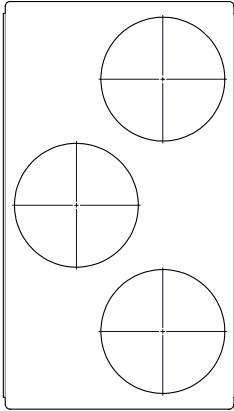

RO-ACC-STFE-APC5

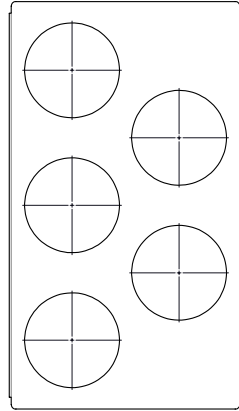

RO-ACC-STFE-APC6

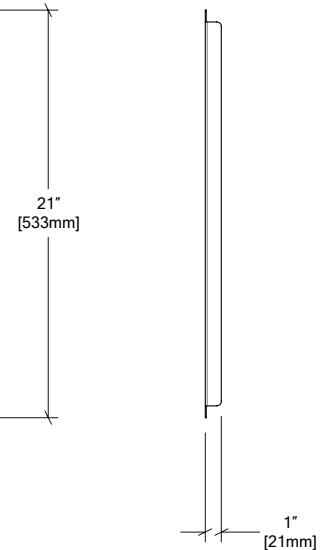
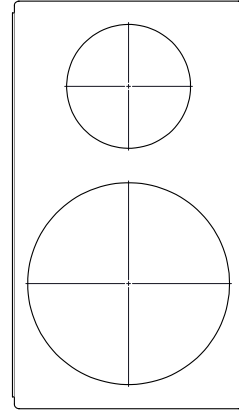

Model	Width	Depth	Height	Weight	Packaging dimensions (W x D x H)
All models	12" – 305 mm	21" – 533 mm	1" – 25 mm	3 lb – 2 kg	13 x 22 x 2" 330 x 559 x 51 mm

Model	Number of 2.2L	Number of 3.9L	Number of 6.7L	Number of 10.4L
RO-ACC-STFE-APC1	1	1	1	N/A
RO-ACC-STFE-APC2	1	2	N/A	N/A
RO-ACC-STFE-APC3	N/A	N/A	2	N/A
RO-ACC-STFE-APC4	N/A	3	N/A	N/A
RO-ACC-STFE-APC5	5	N/A	N/A	N/A
RO-ACC-STFE-APC6	N/A	1	N/A	1