

N – SERIES



N – 12000 PICTURED

MEMBRANE SYSTEM USER MANUAL

This page is Intentionally
left blank

TABLE OF CONTENTS

INTRODUCTION.....	5
SAFETY	6
PRECAUTIONARY STATEMENTS.....	6
OPERATING DO'S AND DON'TS	7
FEED WATER AND OPERATION SPECIFICATIONS.....	8
OPERATING LIMITS*.....	8
N – SERIES SYSTEM SPECIFICATION CHART	9
N – SERIES COMPONENT IDENTIFICATION DESCRIPTION.....	10
CONTROLLER	11
PRE-FILTRATION	12
PRE-FILTER PRESSURE GAUGES.....	12
PERMEATE FLUSH PORT AND PLUG.....	12
CHEMICAL INJECTION PORT AND PLUG.....	12
LOW PRESSURE SWITCH.....	13
PUMP.....	13
PUMP THROTTLE VALVE.....	13
PUMP PRESSURE GAUGE.....	14
MEMBRANES.....	14
PERMEATE FLOW METER.....	14
CONCENTRATE FLOW METER	14
CONCENTRATE RECYCLE FLOW METER	14
MEMBRANE INFORMATION	15
MEMBRANE ELEMENT SPECIFICATIONS	15
MEMBRANE PERFORMANCE	17
REJECTION.....	17
RECOVERY.....	17
SYSTEM INSTALLATION.....	18
MOUNTING	18
FEED WATER CONNECTION.....	18
PERMEATE WATER (PRODUCT) CONNECTION	18
CONCENTRATE WATER (WASTE) CONNECTION.....	19
ELECTRICAL.....	20
HIGH PRESSURE SWITCH.....	20
LIQUID LEVEL (FLOAT) SWITCH FOR ATMOSPHERIC TANKS	20
MEMBRANE INFORMATION AND HANDLING	21
MEMBRANE INSTALLATION / REPLACEMENT	22
SYSTEM PURGING / INITIAL START UP.....	24
FLUSHING THE SYSTEM.....	25
PREPARING UNIT FOR STORAGE	25
TEMPERATURE CORRECTION FACTORS FOR MEMBRANES	26

TEMPERATURE CORRECTION TABLE	27
REVERSE OSMOSIS SYSTEM OPERATION LOG	28
TROUBLESHOOTING CHART	29
TECHNICAL ASSISTANCE	29
AX – 8000 CONTROLLER SPECIFICATIONS AND INSTRUCTIONS	30
CONTROLLER SPECIFICATIONS	30
SIMPLIFIED SCHEMATICS	31
CONTROLLER OVERVIEW	32
MANUFACTURER’S DRAWINGS	33
N – 2000 FLOW DIAGRAM	33
N – 4000 FLOW DIAGRAM	34
N – 6000 FLOW DIAGRAM	35
N – 8000 FLOW DIAGRAM	36
N – 12000 FLOW DIAGRAM	37
N – 16000 FLOW DIAGRAM	38
SYSTEM WARRANTY	39

INTRODUCTION

The N – Series Reverse Osmosis System is a durable piece of equipment which, with proper care, will last for many years. This User Manual outlines installation, operation, maintenance and troubleshooting details vital to the sustained performance of your system.

If your system is altered at the site of operation, or if the feedwater conditions change, please contact your local dealer or distributor to determine the proper recovery for your application.

MEMBRANE ELEMENTS DO NOT COME PRE-LOADED. INSTALL MEMBRANES IN ACCORDANCE WITH THIS MANUAL BEFORE BEGINNING OPERATION.

DO NOT UNDER ANY CIRCUMSTANCE REMOVE ANY CAUTION, WARNING, OR OTHER DESCRIPTIVE LABELS FROM THE SYSTEM.

PRIOR TO OPERATING OR SERVICING THE REVERSE OSMOSIS SYSTEM, THIS USER'S MANUAL MUST BE READ AND FULLY UNDERSTOOD. KEEP THIS AND OTHER ASSOCIATED INFORMATION NEAR THE SYSTEM FOR FUTURE REFERENCE.

IN ORDER TO MAINTAIN THE MANUFACTURER'S WARRANTY, AN OPERATING LOG MUST BE MAINTAINED. COPIES WILL NEED TO BE SENT TO YOUR LOCAL DEALER OR DISTRIBUTOR FOR REVIEW IN THE EVENT OF A WARRANTEE COVERAGE ISSUE.

SAFETY

Defined below are the three safety headings used throughout this User Manual's text.



WARNING: INDICATES STATEMENTS THAT ARE USED TO IDENTIFY DANGEROUS CONDITIONS OR PRACTICES. FAILURE TO FOLLOW WARNINGS COULD RESULT IN SERIOUS INJURY OR DEATH.



CAUTION: INDICATES STATEMENTS THAT ARE USED TO IDENTIFY CONDITIONS OR PRACTICES THAT COULD RESULT IN EQUIPMENT OR OTHER PROPERTY DAMAGE



ELECTRICAL HAZARD: INDICATES STATEMENTS THAT ARE USED TO IDENTIFY HIGH-VOLTAGE AND POTENTIAL SHOCK / ELECTROCUTION.

STATEMENTS IN BOLD AND ALL CAPITALS ARE ADVISORY OR INFORMATIONAL STATEMENTS OF PARTICULAR IMPORTANCE TO THE HEADING UNDER WHICH THEY ARE FOUND.

PRECAUTIONARY STATEMENTS



DO NOT USE WHERE THE WATER IS MICROBIOLOGICALLY UNSAFE OR OF UNKNOWN QUALITY WITHOUT ADEQUATE DISINFECTION BEFORE OR AFTER THE SYSTEM.



ALWAYS TURN OFF THE UNIT, SHUT OFF THE FEEDWATER, RELIEVE PRESSURE, AND DISCONNECT THE ELECTRICAL POWER BEFORE WORKING ON THE UNIT.



DO NOT CLOSE THE CONCENTRATE VALVE COMPLETELY.



PRE-TREATMENT MUST BE SUFFICIENT TO ELIMINATE CHEMICALS, ORGANICS OR INORGANICS THAT COULD ATTACK THE MEMBRANE MATERIAL.



DO NOT OPERATE THE SYSTEM WITH INSUFFICIENT FEED FLOW. NEVER ALLOW THE PUMP TO RUN DRY.



NEVER ALLOW THE UNIT TO FREEZE OR OPERATE WITH A FEEDWATER TEMPERATURE ABOVE 85°F.



DO NOT PERMIT CHLORINE TO BE PRESENT IN THE FEED WATER.



DO NOT SHUT DOWN THE SYSTEM FOR EXTENDED PERIODS. IT IS BEST TO RUN THE SYSTEM AS MUCH AS POSSIBLE ON A CONTINUOUS BASIS.



ELECTRICAL INSTALLATION SHOULD BE DONE BY QUALIFIED, TRAINED ELECTRICIANS. INSTALLATION SHOULD BE TO LOCAL CODES.

OPERATING DO'S AND DON'TS

DO

- Change the cartridge filters regularly.
- Monitor the system and keep a daily log.
- Run the system as much as possible on a continuous basis.
- Always feed the pump with filtered water.



DON'T

- Permit chlorine to enter or be present in the feed water.
- Shut down the system for extended periods.
- Operate the system with insufficient feed flow or pressure.
- Operate the pump dry.



FEED WATER AND OPERATION SPECIFICATIONS

Nothing has a greater effect on a reverse osmosis system than the feed water quality. If your system is altered at the site of operation or if the feed water conditions change, please contact your local dealer or distributor to determine the proper recovery for your application. Before starting the RO system it is strongly suggested to obtain an up to date water analysis of the water to be treated.



IT IS VERY IMPORTANT TO MEET THE MINIMUM FEED WATER AND OPERATING REQUIREMENTS OUTLINED IN THIS MANUAL. FAILURE TO DO SO WILL CAUSE DAMAGE OR FAILURE OF THE SYSTEM COMPONENTS AND MEMBRANES. DAMAGE TO THE SYSTEM DUE TO OPERATION OUTSIDE OF THE SPECIFICATIONS OUTLINED IN THIS MANUAL WILL VOID THE MANUFACTURERS WARRANTY. CHECK YOUR FEED WATER CHEMISTRY AND, IF NECESSARY, CONSULT WITH YOUR LOCAL DEALER OR DISTRIBUTOR BEFORE START UP OF THE SYSTEM.

OPERATING LIMITS*

Design Temperature, °F	77	Maximum Turbidity, NTU	1
Maximum Feed Temperature, °F	85	Maximum SDI Rating	<3
Minimum Feed Temperature, °F	40 [†]	Maximum Free Chlorine, ppm	0
Maximum Ambient Temperature, °F	120	Maximum TDS, ppm	2,000 [†]
Minimum Ambient Temperature, °F	40	Maximum Hardness, gpg	0
Maximum Feed Pressure, PSI	85	Maximum pH (continuous)	10
Minimum Feed Pressure, PSI	45	Minimum pH (continuous)	4
Maximum Operating Pressure, PSI	200	Maximum pH (cleaning 30 minutes)	12
Operating Range, PSI	150 – 200 ^{††}	Minimum pH (cleaning 30 minutes)	2

[†] Low temperatures and feedwater quality, such as high TDS levels will significantly affect the systems production capabilities and performance. Computer projections must be run for individual applications which do not meet or exceed minimum and maximum operating limits for such conditions.

^{††} System Operating Pressure is based on 60 psi feed pressure, minimum concentrate flow as stated and an average of 2000 gpd flow per membrane at 77°F.

*If any of the feed water parameters are not within the limits given, consult your local dealer or distributor for assistance.



HIGHER TDS AND/OR LOWER TEMPERATURES WILL REDUCE THE SYSTEM'S PRODUCTION.



DO NOT EXCEED THE MAXIMUM OPERATING PRESSURE.

N – SERIES SYSTEM SPECIFICATION CHART

MODELS	N – 2000	N – 4000	N – 6000	N – 8000	N – 12000	N – 16000
DESIGN						
Configuration	Single Pass	Single Pass	Single Pass	Single Pass	Single Pass	Single Pass
Feedwater TDS max ppm	2,000	2,000	2,000	2,000	2,000	2,000
Standard Recovery % ^{†††}	32	48	58	65	58	65
FLOW RATES						
Permeate Flow Rate (gpd / lpd) ^{†††}	2,000 / 7,570	4,000 / 15,141	6,000 / 22,712	8,000 / 30,283	12,000 / 45,425	16,000 / 60,566
Permeate Flow Rate (gpm / lpm) ^{†††}	1.39 / 5.26	2.78 / 10.52	4.16 / 15.75	5.56 / 21.05	8.33 / 31.53	11.11 / 42.06
Minimum Concentrate Flow Rate (gpm / lpm)	3.00 / 11.36	3.00 / 11.36	3.00 / 11.36	3.00 / 11.36	6.00 / 22.72	6.00 / 22.72
Concentrate Recycle Flow Rate (gpm / lpm)	Up to 2.00 / 7.57	Up to 5.00 / 18.93	Up to 5.00 / 18.93	Up to 5.00 / 18.93	Up to 5.00 / 18.93	Up to 5.00 / 18.93
CONNECTIONS						
Feed (inch)	1 FNPT	1 FNPT	1 FNPT	1 FNPT	1 FNPT	1 FNPT
Permeate (inch)	1/2 QC	1/2 QC	1 FNPT	1 FNPT	1 FNPT	1 FNPT
Concentrate (inch)	1/2 QC	1/2 QC	1 FNPT	1 FNPT	1 FNPT	1 FNPT
MEMBRANES						
Membrane(s) Per Vessel	1	1	1	1	1	1
Membrane Quantity	1	2	3	4	6	8
Membrane Size	4040	4040	4040	4040	4040	4040
Nominal TDS Rejection %	98.50	98.50	98.50	98.50	98.50	98.50
VESSELS						
Vessel Array	1	1:1	1:1:1	1:1:1:1	2:2:2	2:2:2:2
Vessel Quantity	1	2	3	4	6	8
PUMPS						
Pump Type	Multi-Stage	Multi-Stage	Multi-Stage	Multi-Stage	Multi-Stage	Multi-Stage
Motor HP	1.5	1.5	2	2	2	2
RPM at 60 Hz	3480	3480	3480	3480	3480	3480
SYSTEM ELECTRICAL						
Standard Voltage + Amp Draw	220V, 60HZ, 1PH, 8.5A	220V, 60HZ, 1PH, 8.5A	220V, 60HZ, 1PH, 11.0A	220V, 60HZ, 1PH, 11.0A	220V, 60HZ, 1PH, 11.0A	220V, 60HZ, 1PH, 11.0A
SYSTEM DIMENSIONS						
Approximate Dimensions ^{††††} L x W x H (in / cm)	25 x 16 x 55 / 63.3 x 40.6 x 140	25 x 16 x 55 / 63.3 x 40.6 x 140	32 x 24 x 55 / 81.3 x 61.0 x 140	32 x 24 x 55 / 81.3 x 61.0 x 140	32 x 24 x 55 / 81.3 x 61.0 x 140	32 x 24 x 55 / 81.3 x 61.0 x 140
Approximate Weight ^{†††††} (lbs / kg)	120 / 55	130 / 59	180 / 82	210 / 95	240 / 109	270 / 123

^{†††} Product flow and standard recovery rates are based on feedwater conditions as stated above. Do not exceed the recommended permeate flow.

^{††††} Does not include operating space requirements.

^{†††††} Does not include membrane(s).

Test Parameters: 550 TDS Filtered (5 - Micron), Dechlorinated, Municipal Feedwater, 65 psi / 4.50 bar Feed Pressure, 100 psi / 6.9 bar Operating Pressure, 77°F / 25°C, Recovery as stated, 7.0 pH. Data taken after 60 minutes of operation.

To Obtain the System's Maximum Recovery please contact your local dealer in order to provide details on the specific application and feed water composition. Maximum recovery of the system varies depending on feed water composition.

N – SERIES COMPONENT IDENTIFICATION DESCRIPTION

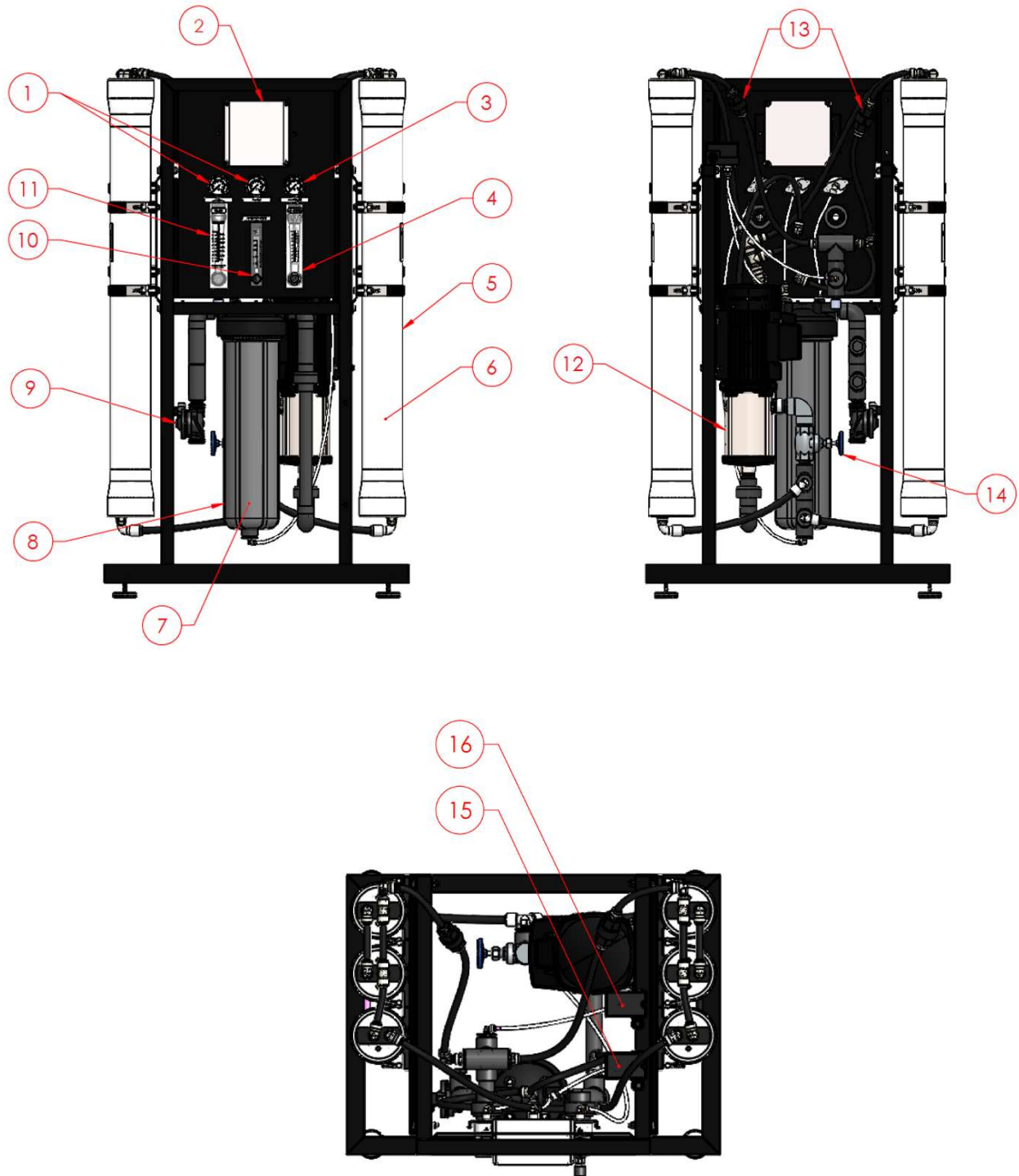

ITEM NUMBER	PART NUMBER	DESCRIPTION	MODEL(S)
1	210702	GAUGE, PM, GLY FILL, 0–100 PSI/BAR, 2" DIA, 1/4" MNPT, AXEON	N 2000 - 16000
2	211454	CONTROLLER, COMPUTER, AX-8000, 220V, 1PH	N 2000 - 16000
3	210703	GAUGE, PM, GLY FILL, 0–300 PSI/BAR, 2" DIA, 1/4" MNPT, AXEON	N 2000 - 16000
4	205104	METER, FLOW, PM, 1-5 GPM, SS VALVE, 1/2" MNPT X 1/4" FNPT, AXEON	N 2000 - 4000
4	205105	METER, FLOW, PM, 1-10 GPM, SS VALVE, 1" MNPT X 1/2" FNPT, AXEON	N 6000 - 16000
5	209853	HOUSING, MEMBRANE, FRP-300E, 4040, 1/2" P x 1/2" C FNPT, AXEON	N 2000 - 16000
6	211064	MEMBRANE, HE, 4040, AXEON	N 2000 - 16000
7	200640	CARTRIDGE, SEDIMENT, POLYPRO, 4.5" X 20", 5 MIC, SDF-45-2005, AXEON	N 2000 - 16000
8	207290	HOUSING, FILTER, BLK/GRY, 4.5" X 20", SGL O-RING, NPR, 1" FNPT, AXEON	N 2000 - 16000
9	204914	VALVE, SOLENOID, N/C, UL, 220V, 1" FNPT, NO DIN, GC	N 2000 - 16000
10	205103	METER, FLOW, PM, 0.2-2 GPM, SS VALVE, 1/2" MNPT X 1/4" FNPT, AXEON	N 2000
10	205104	METER, FLOW, PM, 1-5 GPM, SS VALVE, 1/2" MNPT X 1/4" FNPT, AXEON	N 4000 - 16000
11	200897	METER, FLOW, PM, 0.2–2 GPM, 1/2" MNPT x 1/2" MNPT, AXEON	N 2000
11	200898	METER, FLOW, PM, 1–5 GPM, 1/2" MNPT x 1/2" MNPT, AXEON	N 4000
11	200899	METER, FLOW, PM, 1–10 GPM, 1" MNPT x 1" MNPT, AXEON	N 6000 - 8000
11	200900	METER, FLOW, PM, 2–20 GPM, 1" MNPT x 1" MNPT, AXEON	N 12000 - 16000
12	211008	PUMP, BOOSTER, 1.5HP, 115/230V, 1PH, CM1-7 GRUNDFOS	N 2000 - 4000
12	211007	PUMP, BOOSTER, 2HP, 115/230V, 1PH, CM3-8 GRUNDFOS	N 6000 - 16000
13	200965	VALVE, CHECK, PP, GLASS FILLED, BLACK, 1/2" FNPT X 1/2" FNPT	N 2000 - 16000
14	202270	VALVE, GLOBE, SS, 1/2" FNPT	N 2000 - 4000
14	200994	VALVE, GLOBE, SS, 3/4" FNPT	N 6000 - 8000
14	200995	VALVE, GLOBE, SS, 1" FNPT	N 12000 - 16000
15	200907	SWITCH, PRESSURE, HIGH, N/C, 40–60 PSI, 1/4" FNPT	N 2000 - 16000
16	200906	SWITCH, PRESSURE, LOW, N/O, 15–30PSI, 1/4"FNPT	N 2000 - 16000

CONTROLLER

The N – Series systems come standard with an AX – 8000 Controller. The AX – 8000 Series controller is a state of the art, microprocessor controlled system for commercial and industrial reverse osmosis.

The AX – 8000 includes numerous standard features such as pressure switch control, motor contactor, TDS / Conductivity monitor with programmable setpoints, pretreatment lock out, tank level switch controls, flush valve control, and programmable membrane flush type and mode. The AX – 8000 Series controller displays system, sensor, and switch input status on an easy to read 4 line, 20 character backlit display. User programmable setpoints allow fast and easy adjustment of system parameters.

PRE-FILTRATION

N – Series systems are supplied with a 5 micron sediment filter. Change the filtration cartridge when a 10 - 15 psi differential exists between the filter in and filter out pressure.



THE SYSTEM MUST BE OPERATED ON FILTERED WATER ONLY.

PRE-FILTER PRESSURE GAUGES

These gauges measure the feed water pressure when it enters and exits the pre-filter. A pressure differential of 10 - 15 psi or more between the two pressure gauges indicates that the pre-filters require replacement.

EXAMPLE: If the inlet pressure is 40 psi, the filter should be changed when the outlet pressure is 25 - 30 psi or below.

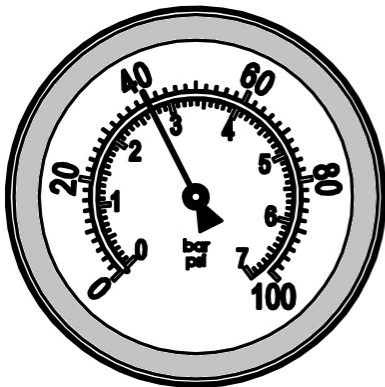

FILTER IN

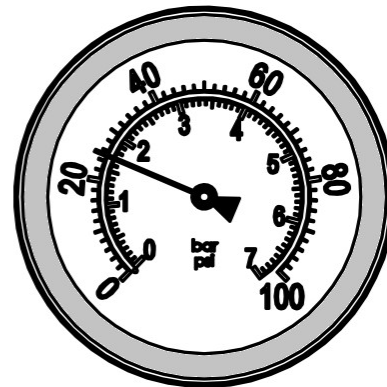

FILTER OUT

PERMEATE FLUSH PORT AND PLUG

The permeate flush port is to be used with an optional permeate flush kit. The 1/2" PVC plug is located before the chemical injection port and after the feed solenoid valve, as shown in the picture. The plug should be removed and the kit should be installed as per the instructions provided with the kit.

CHEMICAL INJECTION PORT AND PLUG

The chemical injection port is to be used with an optional chemical injection system. The 1/2" PVC plug is located before the filter and after the permeate flush port, as shown in the picture. The plug should be removed and a chemical injector should be installed in its place when using a chemical injection system.

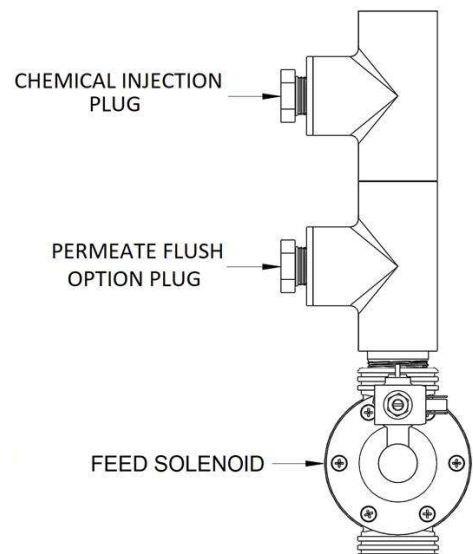



N – SERIES SYSTEMS COME STANDARD WITH A CHEMICAL INJECTION ELECTRICAL PLUG. THIS PLUG IS INTENDED ONLY FOR CHEMICAL INJECTION PUMPS. DO NOT USE THIS PLUG FOR ANYTHING OTHER THAN ITS INTENDED PURPOSE. DO NOT EXCEED 5 AMPS.

LOW PRESSURE SWITCH

The low pressure switch shuts off the system when the feed water pressure drops below 15 PSI, preventing damage to the pump. The system restarts automatically when there is a constant pressure of 35 PSI or more.

PUMP

The N – Series systems use a multi-stage centrifugal stainless steel pump. If any damage occurs to your system’s pump, contact your local dealer or distributor and inform them of your system and pump model.



NEVER RUN THE PUMP DRY. OPERATING THE PUMP WITHOUT SUFFICIENT FEED FLOW WILL CAUSE DAMAGE OR FAILURE.

PUMP THROTTLE VALVE

The pump throttle valve is installed as a standard feature on the N – Series Reverse Osmosis Systems. It provides an adjustment for pump pressure. As the feed water temperature decreases, and/or the feed water TDS increases, the system will require a higher operating pressure to produce the specified permeate flow.

To decrease the pressure, turn the handle clockwise. To increase the pressure, turn the handle counter clockwise as shown below.

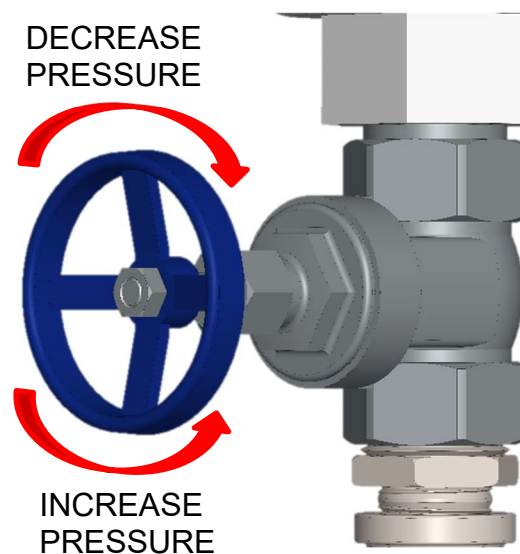

PUMP PRESSURE GAUGE

The pump pressure gauge measures the pressure of the water as it exits the pump to enter the first membrane in the system.

MEMBRANES

The reverse osmosis system is equipped with AXEON HE – Series RO membranes. These membranes separate impurities from water through the reverse osmosis process.

PERMEATE FLOW METER

A clear acrylic analog flow meter is provided to measure the amount of product water the RO system is producing as gallons/liters per minute.



CONCENTRATE FLOW METER

A clear acrylic analog flow meter is provided to measure the amount of wastewater the RO system is sending to the drain as gallons/liters per minute. The concentrate flow meter is equipped with an integrated needle valve to control flow and pressure through the system.



CONCENTRATE RECYCLE FLOW METER

Water that would normally go down the drain as waste is diverted back into the system before the pump for reprocessing, thus increasing the system's percent of recovery. The concentrate recycle flow meter measures the amount of water the system is recycling as gallons/liters per minute. The concentrate recycle flow meter is equipped with an integrated needle valve to control the amount of concentrate water being recycled through the system.



RECYCLING CONCENTRATE WATER WILL INCREASE THE DISSOLVED SOLIDS IN THE WATER BEING PROCESSED BY THE MEMBRANES THUS AFFECTING THE PERMEATE QUALITY. EXCESSIVE RECYCLING MAY CAUSE PREMATURE FOULING OR SCALING OF THE MEMBRANE ELEMENTS.

MEMBRANE INFORMATION

N – Series reverse osmosis systems come standard with HE – Series Low Energy membranes. General membrane element performance characteristics are listed on the following membrane specification chart.

MEMBRANE ELEMENT SPECIFICATIONS

HE – Series Ultra Low Energy Membranes (Standard)

Membrane Type: Polyamide Thin – Film Composite	pH Range, Short Term Cleaning (30 Min.): 2 – 12
Maximum Operating Temperature: 113°F (45°C)	Maximum Feed Silt Density Index (SDI): 5
Maximum Operating Pressure: 400 psi (27.58 bar)	Chlorine Tolerance: 0 ppm
pH Range, Continuous Operation*: 3 – 10	Maximum Feed Flow Rate (gpm): 14

*Maximum temperature for continuous operations above pH 10 is 95 °F (35 °C).

Product Specifications				Dimension inch / mm			
Part Number	Description	Applied Pressure psi / bar	Permeate Flow Rate gpd / lpd	A	B	C	D
211064	HE – 4040	100 / 6.9	2400 / 9084.99	40 / 1016.00	1.04 / 26.50	0.75 / 19.05	3.90 / 99.20

Warranty Evaluation Test Conditions: Permeate flow and salt rejection based on the following test conditions – 550 ppm, filtered and dechlorinated municipal tap water, 77°F / 25°C, 15% recovery and the specified operating pressure. Minimum salt rejection is 96%. Permeate flows for warranty evaluation may vary +/-20%. Maximum pressure drop at 15 psig / 0.9 bar.

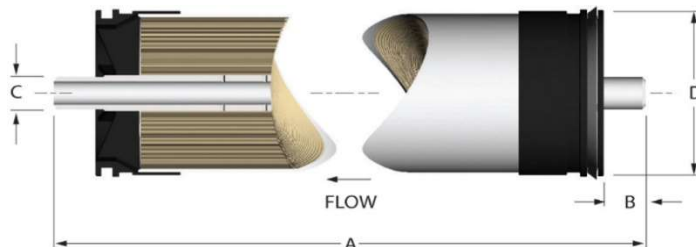

All 4040 elements fit nominal 4.00" I.D. membrane housings.

Proper start-up of reverse osmosis water treatment systems is essential to prepare the membranes for operating service and to prevent membrane damage due to overfeeding or hydraulic shock. Before initiating system start-up procedures, membrane pretreatment, loading of the membrane elements, instrument calibration and other system checks should be completed.

Avoid any abrupt pressure or crossflow variations on the spiral elements during start-up, shutdown, cleaning or other sequences to prevent possible membrane damage. During start-up, a gradual change from a standstill to operating state is recommended as follows:

- Feed pressure should be increased gradually over a 30 – 60 second time frame.
- Cross – flow velocity at set operating point should be achieved gradually over 15 – 20 seconds.
- Permeate obtained from first hour of operation should be discarded.
- Maximum pressure drop across an entire single membrane pressure vessel (housing) can be up to 15 psi / 1.03 bar.
- Avoid static permeate – side backpressure at all times.

Under certain conditions, the presence of free chlorine, chloramines and other oxidizing agents will cause premature membrane failure. Since oxidation damage is not covered under warranty, the manufacturer recommends removing all oxidizing agents by pretreatment prior to membrane exposure. Please contact the manufacturer or your supplier for more information.

Do not use this initial permeate for drinking water or food preparation. Keep elements moist at all times after initial wetting. To prevent biological growth during prolonged system shutdowns, it is recommended that membrane elements be immersed in a preservative solution. Rinse out the preservative before use. For membrane warranty details, please contact the manufacturer or your supplier for more information.

If operating limits and guidelines given in this product specification sheet are not strictly followed, the warranty will be null and void. The customer is fully responsible for the effects of incompatible chemicals and lubricants on elements. Use of any such chemicals or lubricants will void the warranty. These membranes may be subject to drinking water application restrictions in some countries; please check the application status before use and sale. The use of this product in and of itself does not necessarily guarantee the removal of cysts and pathogens from water. Effective cyst and pathogen reduction is dependent on the complete system design and on the operation and maintenance of the system.

No freedom from infringement of any patent owned by the manufacturer or others is to be inferred. Because use conditions and applicable laws may differ from one location to another and may change with time, customer is responsible for determining whether products and the information in this document are appropriate for customer's use and for ensuring that customer's workplace and disposal practices are in compliance with applicable laws and other governmental enactments. The claims made may not have been approved for use in all countries. The manufacturer assumes no obligation or liability for the information in this document. **NO WARRANTIES ARE GIVEN; ALL IMPLIED WARRANTIES OF MERCHANTABILITY OR FITNESS FOR A PARTICULAR PURPOSE ARE EXPRESSLY EXCLUDED.**

MEMBRANE PERFORMANCE

N – Series Reverse Osmosis Systems are designed to produce 2,000 GPD at 77°F (nominal) of permeate water per membrane at 98.5% rejection under the proper conditions. For example, the N – 8000 produces 8,000 gallons per day of permeate water at the listed operating test conditions.

REJECTION

The amount of total dissolved solids (TDS) rejected by the membrane is expressed as a percentage. N – Series reverse osmosis systems are designed to reject up to 98.5% NaCl depending on feed water chemistry. A 98.5% rejection rate means that 98.5% of total dissolved solids do not pass through the membrane. To calculate the percent of rejection, use the following formula:

$$\% \text{ REJECTION} = \frac{\text{FEED TDS} - \text{PERMEATE TDS}}{\text{FEED TDS}} \times 100$$

Example:

$$\frac{550 \text{ TDS} - 8.25 \text{ TDS}}{550 \text{ TDS}} \times 100 = 98.5\% \text{ REJECTION}$$

RECOVERY

The amount of permeate water recovered for use is expressed as a percentage. To calculate percent of recovery, use the following formula:

$$\% \text{ RECOVERY} = \frac{\text{PRODUCT WATER FLOW RATE}}{\text{FEED WATER FLOW RATE}} \times 100$$

Example:

$$\frac{5.55 \text{ GPM}}{8.55 \text{ GPM}} \times 100 = 65\% \text{ RECOVERY}$$



ALL FLOW RATES MUST BE EXPRESSED IN THE SAME UNITS, TYPICALLY GALLONS PER MINUTE (GPM).

SYSTEM INSTALLATION

MOUNTING

When choosing a location to install the system, select an area with enough room to remove the membranes and easily access components and connections. Make sure there is enough room for service to be performed on the system. Take into consideration where your electrical power supply is located and where the nearest drain is located. Do not install system in direct sunlight or subject the system to temperature extremes and/or excess humidity.

The N – Series system should be secured in compliance with state and local regulations.

FEED WATER CONNECTION

Attach the water supply plumbing to the 1" FNPT solenoid valve labeled "FEED".



N – SERIES SYSTEMS MUST HAVE A FEED WATER LINE TO THE SYSTEM NO LESS THAN 1". USING SMALLER LINE SIZES WILL CAUSE PRESSURE FLUCTUATIONS AND POSSIBLY AFFECT THE PUMP PERFORMANCE.

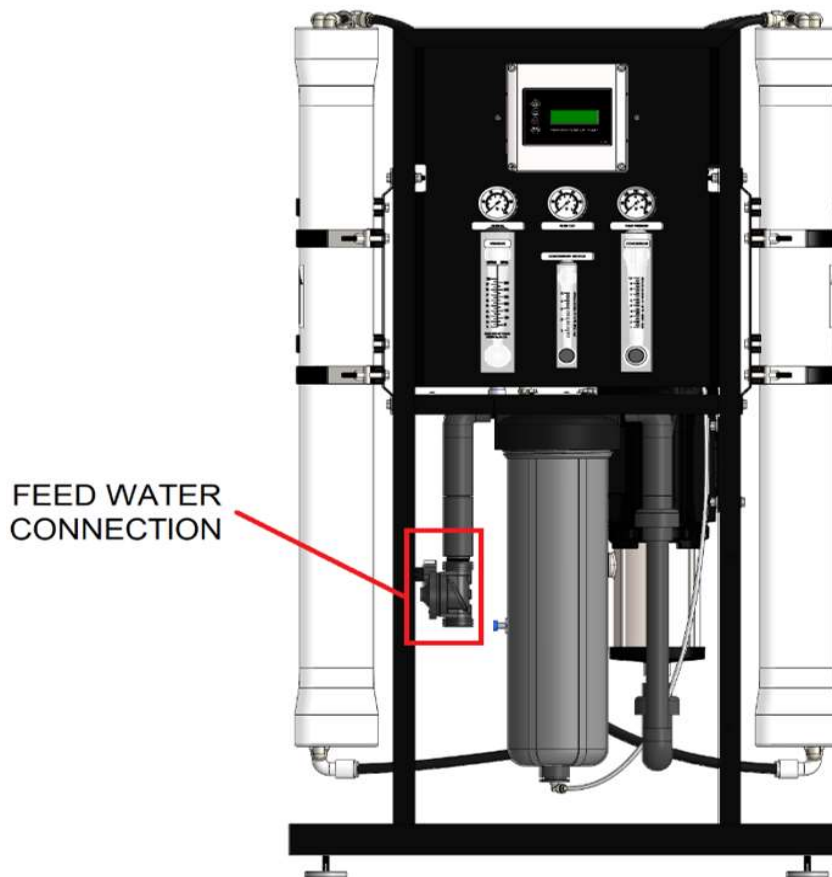

PERMEATE WATER (PRODUCT) CONNECTION

Locate the 1/2" quick connection (N – 2000 and N – 4000) or 1" union (N – 6000 thru N – 16000) on the outlet of the permeate flow meter labeled "PERMEATE", and run plumbing to a storage tank.



THE PH OF THE REVERSE OSMOSIS PERMEATE WATER WILL TYPICALLY BE 1-2 POINTS LOWER THAN THE FEED WATER PH. A LOW PH CAN BE VERY AGGRESSIVE TO SOME PLUMBING MATERIALS SUCH AS COPPER PIPING.

CONCENTRATE WATER (WASTE) CONNECTION

Locate the 1/2" quick connection (N – 2000 and N – 4000) or 1" union (N – 6000 thru N – 16000) on the outlet of the concentrate flow meter labeled "CONCENTRATE", and run plumbing to a drain. It is advised that an air-break be used on the concentrate line to prevent siphoning of water from the pressure vessels when the system is in standby.



ANY RESTRICTIONS OR BLOCKAGE IN THE DRAIN LINE CAN CAUSE BACKPRESSURE, WHICH WILL INCREASE THE SYSTEM'S OPERATING PRESSURE. THIS CAN RESULT IN DAMAGE TO THE SYSTEM'S MEMBRANES AND COMPONENTS.

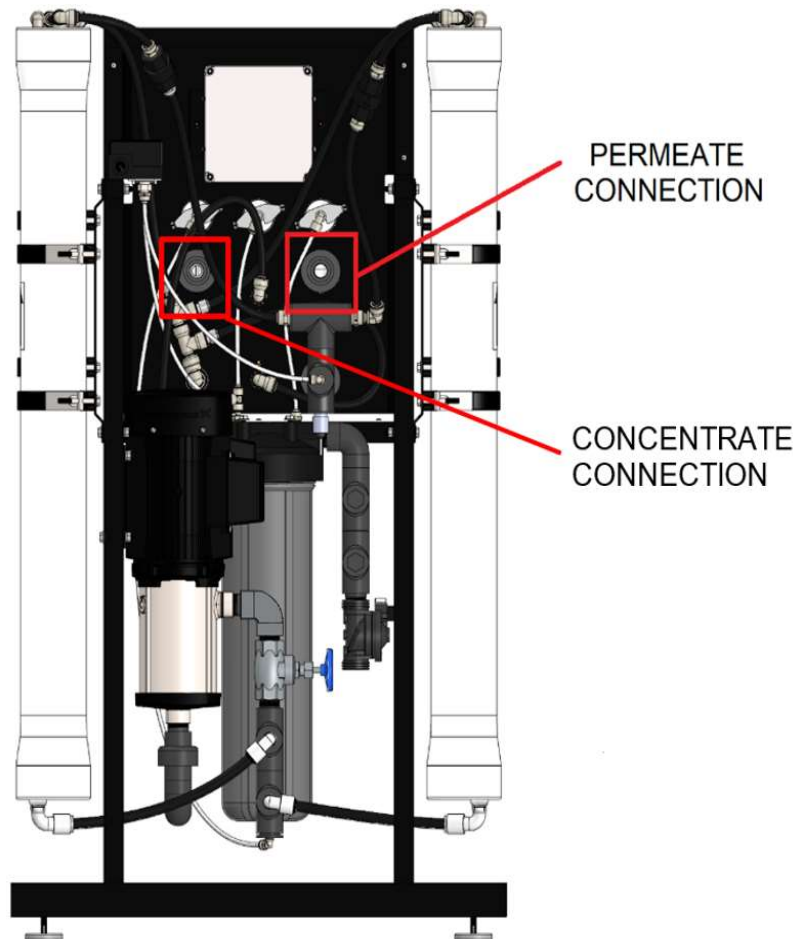

ELECTRICAL

N – Series systems are available in 220V/60HZ/1PH. Each N – Series system is equipped with an 8 foot electrical cord.

It is best that the N – Series system be wired to a dedicated electrical circuit. Ensure that the electrical circuit supplying the system is compatible with the requirements of the specific N - Series model you are installing.



TO REDUCE THE RISK OF ELECTRICAL SHOCK, THE INCOMING POWER SUPPLY MUST INCLUDE A PROTECTIVE EARTH GROUND.



IT IS RECOMMENDED THAT A LICENSED ELECTRICIAN WIRE YOUR SYSTEM IN ACCORDANCE WITH LOCAL AND NATIONAL ELECTRICAL CODES (NEC).

HIGH PRESSURE SWITCH

N-Series systems are controlled with a normally closed high pressure switch to be used with a bladder tank or a float valve. The high pressure switch turns the system off when the pressure reaches 60psi and turns on when the pressure drops below 40psi.

LIQUID LEVEL (FLOAT) SWITCH FOR ATMOSPHERIC TANKS

Although controlled with a permeate high pressure switch, a float switch can be installed to work in conjunction with the high pressure switch. The liquid level switch turns the system on when the water level in the tank drops, and off when the tank is full. Liquid level switches can be obtained by your local dealer or distributor. If a liquid level switch is to be used, install it at this time. To install a normally closed float switch, locate the high pressure switch (Item 15) and remove the the red wire from terminal 2 and relocate it to terminal 4. Cut the float switch pigtails and strip back ½” of each of the wire insulations. Install the float switch leads to terminals 2 and 3. See electrical diagram below.

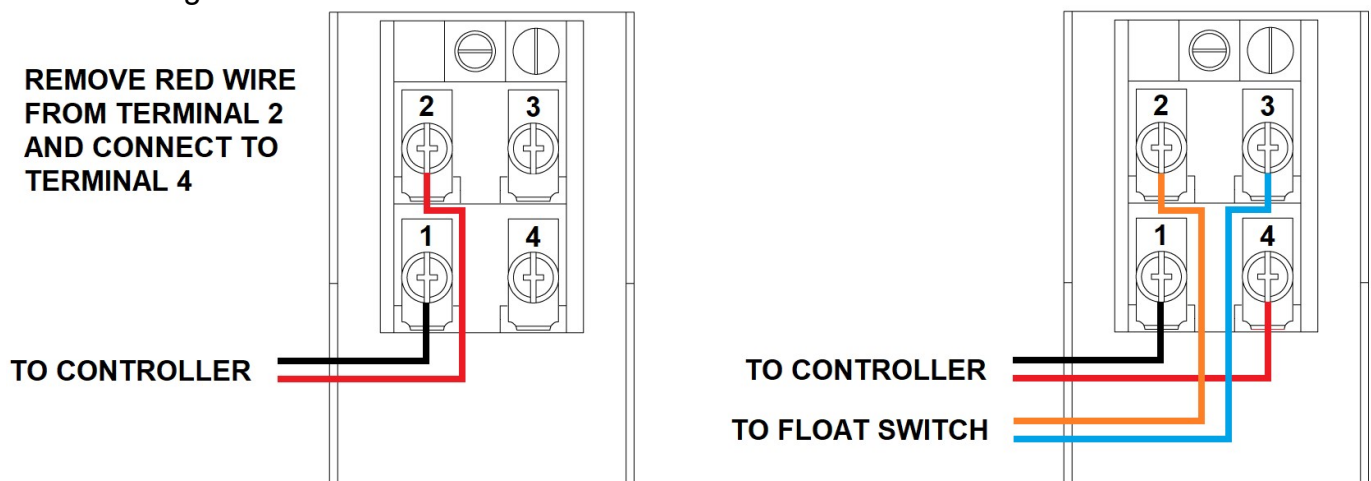

MEMBRANE INFORMATION AND HANDLING



ALL PRESSURE GAUGES MUST READ ZERO BEFORE BEGINNING THIS PROCEDURE. TURN THE SYSTEM OFF, DISCONNECT THE POWER, AND BLEED ALL WATER PRESSURE FROM THE SYSTEM



THE BRINE SEAL MUST BE IN THE CORRECT POSITION FOR EACH MEMBRANE HOUSING IN ORDER FOR THE MEMBRANE TO FUNCTION CORRECTLY.

Pay close attention to the flow direction arrows on the membrane housings when installing new membranes. Refer to the following chart:

N – 2000



N – 4000

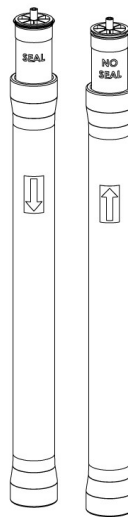

N – 6000

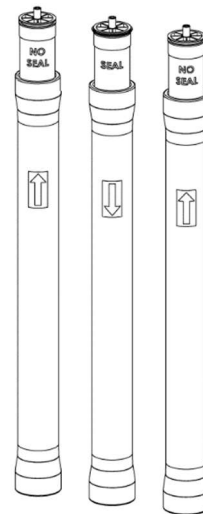

N – 8000

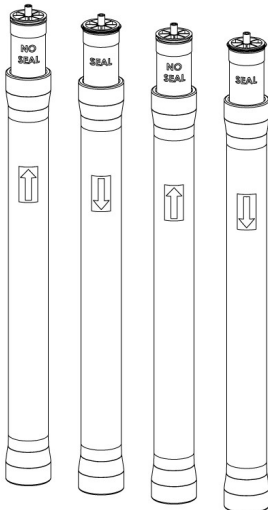

N – 12000

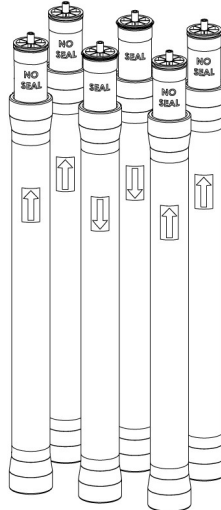

N – 16000

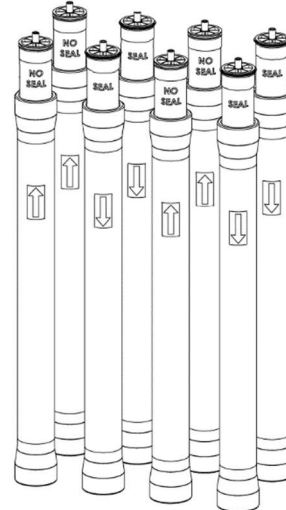

MEMBRANE INSTALLATION / REPLACEMENT



WEAR GLOVES FOR THE FOLLOWING STEPS IN ORDER NOT TO CONTAMINATE THE MEMBRANE.

1. Remove the permeate plumbing and/or fittings from the permeate port of the top end plug on the pressure vessel. Unscrew and remove the two locking crescents using a #5 Hex wrench. Use a 1/2" x 6" PVC nipple (or similar material) and thread it into the end plug permeate port to hand tightness. Pull the pipe outward to remove the end plug. If the pressure vessel has been in operation for an extended time, a slight rocking motion or forceful tug may be required. Set the end plug aside in a clean area where the O-ring will not pick up dirt or debris.

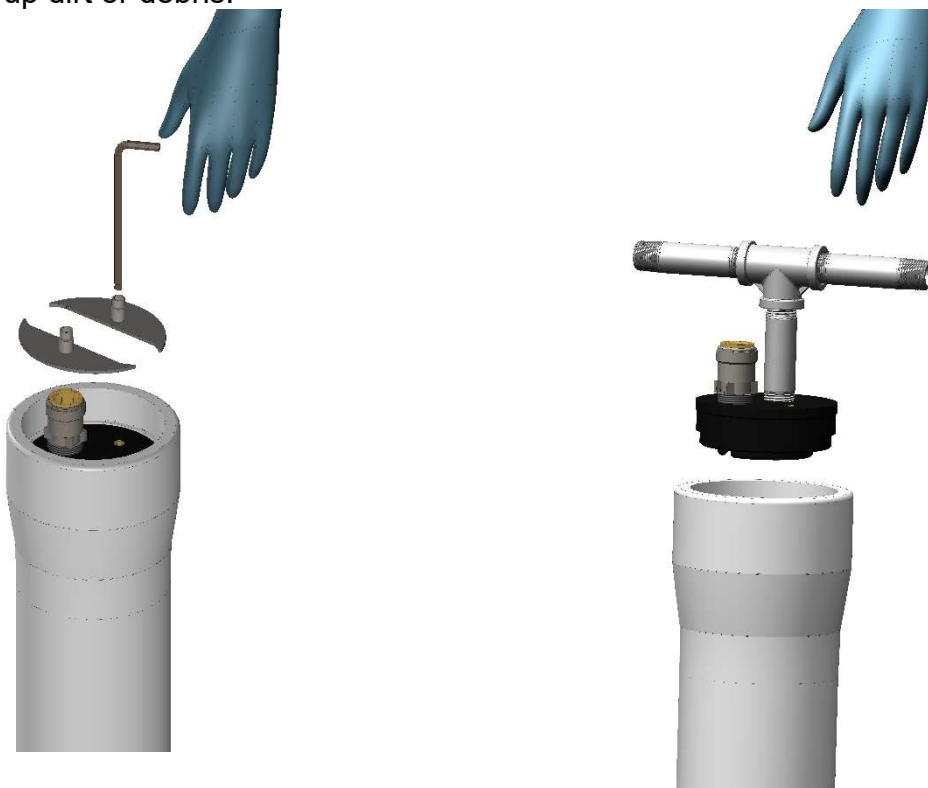

2. Remove the membrane bag containing the membrane element from the shipping box.
3. Cut the bag open as close as possible to the seal at the end of the bag, so the bag may be re-used if necessary.
4. Make sure that all parts are clean and free from dirt. Examine the brine seal and permeate tube for nicks or cuts. Replace the O-rings or brine seal if damaged.
5. Remove the old membranes from the pressure vessels. Use long nose pliers to pull the old membrane out of the pressure vessel.
6. Lubricate the brine seal and O-rings on the new membranes with a non-petroleum based lubricant, such as Dow Corning® 111. Do not use a petroleum-based lubricant.
7. Apply the same lubricant to the inside of the pressure vessel below the groove for the locking crescents, where the membrane brine seal will make contact when inserted.
8. Install membranes with brine seal location depicted in the membrane flow chart on the previous page.

9. When loading a membrane brine seal first, insert the membrane at a slight angle while gently rotating, being careful not to tear or flip the brine seal. With a smooth and constant motion, carefully push the membrane into the pressure vessel. A slow twisting motion should be used while inserting the membrane to ensure the brine seal stays in place. If there is considerable resistance when attempting to insert the membrane remove it and re-lube the brine seal and pressure vessel entrance as necessary. Pushing the membrane into the pressure vessel forcefully will cause the brine seal to flip at which point the membrane will no longer operate properly.
10. The membrane should stop when fully seated on the bottom end plug.
11. Reassemble the top end plugs.



MAKE SURE THE O-RINGS AND END PLUGS ARE FREE FROM DIRT AND DEBRIS BEFORE RE-INSTALLING. DIRT AND OTHER FOREIGN MATERIALS LEFT ON THE END PLUGS CAN CAUSE LEAKS AND/OR DAMAGE THE MEMBRANES AND CAUSE CONTAMINATION.

12. Re-install the end plugs by gently and evenly pushing them onto the pressure vessel. Ensure that you do not pinch or fatigue any O-rings while re-installing the end plug. Push the end plug in until it is seated just below the groove for the locking crescents.
13. Reinstall the locking crescents and securely tighten the screws.
14. Reconnect any fittings that may have been disconnected when the pressure vessels were disassembled.
15. To start-up the system, please refer to the System Purging/Initial Start-Up section of this User's Manual.



THE MEMBRANES MUST BE FLUSHED FOR AT LEAST 1 HOUR TO REMOVE THE PRESERVATIVE FROM THE MEMBRANE. DISCARD ALL OF THE PERMEATE PRODUCED DURING THE FLUSH PERIOD.

SYSTEM PURGING / INITIAL START UP



CAREFULLY INSPECT YOUR SYSTEM BEFORE INITIAL START UP. CHECK THAT ALL THE PLUMBING AND ELECTRICAL CONNECTIONS ARE IN PLACE AND SECURELY FASTENED.

LEAVE THE POWER TO THE SYSTEM OFF UNTIL STEP 8 OF THIS PROCEDURE.

1. Redirect permeate water to the drain for this procedure.
2. Fully open the concentrate valve. (counterclockwise).
3. Fully close the recycle valve. (clockwise).

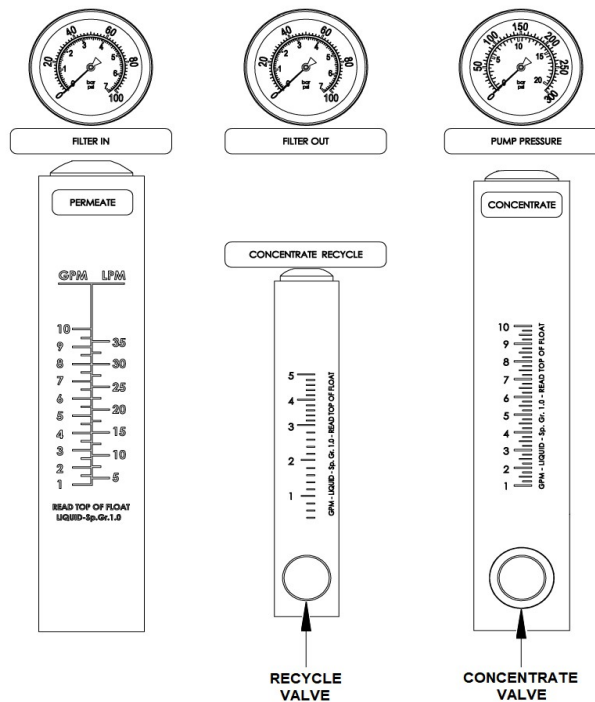

4. Fully open the throttle valve by turning it counterclockwise. Refer to pg. 13 for throttle valve instruction.
5. Open the small lever located on the top of the inlet solenoid valve (shown below).
6. Turn the feedwater on and let the system purge until there are no visible air bubbles in the concentrate flow meter.
7. Close the small lever on the top of the solenoid valve.
8. Turn the system on. Adjust the pump throttle valve, concentrate valve, and the recycle valve to allow the system to run at the designed flows and pressures.
9. Allow the system to run uninterrupted for at least 1 hour to flush the preservative solution from the system.
10. Inspect the system for leaks.
11. After 1 hour, shut down the system.
12. Re-direct the permeate water back to the tank and then turn the system back on.
13. Using the Reverse Osmosis System Operation Log provided on page 28, record your system's readings daily for a week. After a week, record the readings at a minimum of once a week. It is suggested to make several copies of this sheet for future use before recording initial readings.



FLUSHING THE SYSTEM

As time progresses, the efficiency of the membrane will be reduced. In general, the salt rejection does not change significantly until two or three years after installation when operated on properly pretreated feed water. The permeate flow rate will begin to decline slightly after one year of operation, but can be extended with diligent flushing and cleaning of the membranes. The system should be flushed regularly to remove sediment from the surface of the membranes. N – Series systems are preprogrammed to flush for 60 seconds on shut down, 2 minutes for permeate flush and 5 minutes for manual flush.

PREPARING UNIT FOR STORAGE

If the system is to be shut down for an extended period, a membrane preservative should be used to preserve the membranes.



PRIOR TO STORING YOUR SYSTEM, THE SYSTEM SHOULD BE CLEANED WITH AXEON C – 10 AND C – 20 CLEANERS, FLUSHED WITH PERMEATE WATER AND M – 100 SOLUTION FOR MEMBRANES TO PROTECT IT FROM BIOLOGICAL ATTACK.



THE PRESSURE VESSELS AND PLUMBING LINES OF THE SYSTEM MUST BE COMPLETELY DRAINED OR FILLED WITH 20-40% POLYGLYCOL MIX (TO PREVENT FREEZING). ANY WATER REMAINING IN THE PLUMBING OF A SYSTEM MAY FREEZE, CAUSING SERIOUS DAMAGE.

1. Completely immerse the elements in the membrane housings using 2% M – 100 solution*.
*For cold weather/winter storage add 20 - 40% by weight Polyglycol to the 2% M – 100 solution. Add Polyglycol AFTER the 2% M – 100 solution has been mixed.
2. Separate the preservative solution from the air outside by closing all valves. Any contact with oxygen will oxidize the M – 100 solution.
3. Check the pH once a week. When the pH becomes 3 or lower, change the preservation solution.
4. Repeat this process at least once a month.

TEMPERATURE CORRECTION FACTORS FOR MEMBRANES

A membrane's stated permeate production rate is based on a water temperature of 77 °F degrees Fahrenheit. Temperatures above or below 77 °F will increase or decrease the membrane's production rate.

Find the temperature correction factor (TCF) for your water temperature on the table located on the next page. Divide the rated permeate flow by the temperature correction factor. The result is the nominal permeate flow rate the system should achieve at actual water temperature. Permeate flow should be within 20% of the rated production, after correcting the feed water temperatures above or below 77 °F. Check your permeate flow meter to determine the permeate flow rate.

Example:

$$5 \text{ GPM at } 59 \text{ }^{\circ}\text{F} \rightarrow \frac{5 \text{ GPM}}{1.422} = 3.52 \text{ GPM}$$

$$5 \text{ GPM at } 77 \text{ }^{\circ}\text{F} \rightarrow \frac{5 \text{ GPM}}{1} = 5 \text{ GPM}$$

$$5 \text{ GPM at } 84 \text{ }^{\circ}\text{F} \rightarrow \frac{5 \text{ GPM}}{.892} = 5.62 \text{ GPM}$$

TEMPERATURE CORRECTION TABLE

Temperature °F (°C)	Temperature Correction Factor	Temperature °F (°C)	Temperature Correction Factor	Temperature °F (°C)	Temperature Correction Factor	Temperature °F (°C)	Temperature Correction Factor	Temperature °F (°C)	Temperature Correction Factor
50.0 (10.0)	1.711	57.2 (14.0)	1.475	64.4 (18.0)	1.276	71.6 (22.0)	1.109	78.8 (26.0)	0.971
50.2 (10.1)	1.705	57.4 (14.1)	1.469	64.6 (18.1)	1.272	71.8 (22.1)	1.105	79.0 (26.1)	0.968
50.4 (10.2)	1.698	57.6 (14.2)	1.464	64.8 (18.2)	1.267	72.0 (22.2)	1.101	79.2 (26.2)	0.965
50.5 (10.3)	1.692	57.7 (14.3)	1.459	64.9 (18.3)	1.262	72.1 (22.3)	1.097	79.3 (26.3)	0.962
50.7 (10.4)	1.686	57.9 (14.4)	1.453	65.1 (18.4)	1.258	72.3 (22.4)	1.093	79.5 (26.4)	0.959
50.9 (10.5)	1.679	58.1 (14.5)	1.448	65.3 (18.5)	1.254	72.5 (22.5)	1.090	79.7 (26.5)	0.957
51.1 (10.6)	1.673	58.3 (14.6)	1.443	65.5 (18.6)	1.249	72.7 (22.6)	1.086	79.9 (26.6)	0.954
51.3 (10.7)	1.667	58.5 (14.7)	1.437	65.7 (18.7)	1.245	72.9 (22.7)	1.082	80.1 (26.7)	0.951
51.4 (10.8)	1.660	58.6 (14.8)	1.432	65.8 (18.8)	1.240	73.0 (22.8)	1.078	80.2 (26.8)	0.948
51.6 (10.9)	1.654	58.8 (14.9)	1.427	66.0 (18.9)	1.236	73.2 (22.9)	1.075	80.4 (26.9)	0.945
51.8 (11.0)	1.648	59.0 (15.0)	1.422	66.2 (19.0)	1.232	73.4 (23.0)	1.071	80.6 (27.0)	0.943
52.0 (11.1)	1.642	59.2 (15.1)	1.417	66.4 (19.1)	1.227	73.6 (23.1)	1.067	80.8 (27.1)	0.940
52.2 (11.2)	1.636	59.4 (15.2)	1.411	66.6 (19.2)	1.223	73.8 (23.2)	1.064	81.0 (27.2)	0.937
52.3 (11.3)	1.630	59.5 (15.3)	1.406	66.7 (19.3)	1.219	73.9 (23.3)	1.060	81.1 (27.3)	0.934
52.5 (11.4)	1.624	59.7 (15.4)	1.401	66.9 (19.4)	1.214	74.1 (23.4)	1.056	81.3 (27.4)	0.932
52.7 (11.5)	1.618	59.9 (15.5)	1.396	67.1 (19.5)	1.210	74.3 (23.5)	1.053	81.5 (27.5)	0.929
52.9 (11.6)	1.611	60.1 (15.6)	1.391	67.3 (19.6)	1.206	74.5 (23.6)	1.049	81.7 (27.6)	0.926
53.1 (11.7)	1.605	60.3 (15.7)	1.386	67.5 (19.7)	1.201	74.7 (23.7)	1.045	81.9 (27.7)	0.924
53.2 (11.8)	1.600	60.4 (15.8)	1.381	67.6 (19.8)	1.197	74.8 (23.8)	1.042	82.0 (27.8)	0.921
53.4 (11.9)	1.594	60.6 (15.9)	1.376	67.8 (19.9)	1.193	75.0 (23.9)	1.038	82.2 (27.9)	0.918
53.6 (12.0)	1.588	60.8 (16.0)	1.371	68.0 (20.0)	1.189	75.2 (24.0)	1.035	82.4 (28.0)	0.915
53.8 (12.1)	1.582	61.0 (16.1)	1.366	68.2 (20.1)	1.185	75.4 (24.1)	1.031	82.6 (28.1)	0.913
54.0 (12.2)	1.576	61.2 (16.2)	1.361	68.4 (20.2)	1.180	75.6 (24.2)	1.028	82.8 (28.2)	0.910
54.1 (12.3)	1.570	61.3 (16.3)	1.356	68.5 (20.3)	1.176	75.7 (24.3)	1.024	82.9 (28.3)	0.908
54.3 (12.4)	1.564	61.5 (16.4)	1.351	68.7 (20.4)	1.172	75.9 (24.4)	1.021	83.1 (28.4)	0.905
54.5 (12.5)	1.558	61.7 (16.5)	1.347	68.9 (20.5)	1.168	76.1 (24.5)	1.017	83.3 (28.5)	0.902
54.7 (12.6)	1.553	61.9 (16.6)	1.342	69.1 (20.6)	1.164	76.3 (24.6)	1.014	83.5 (28.6)	0.900
54.9 (12.7)	1.547	62.1 (16.7)	1.337	69.3 (20.7)	1.160	76.5 (24.7)	1.010	83.7 (28.7)	0.897
55.0 (12.8)	1.541	62.2 (16.8)	1.332	69.4 (20.8)	1.156	76.6 (24.8)	1.007	83.8 (28.8)	0.894
55.2 (12.9)	1.536	62.4 (16.9)	1.327	69.6 (20.9)	1.152	76.8 (24.9)	1.003	84.0 (28.9)	0.892
55.4 (13.0)	1.530	62.6 (17.0)	1.323	69.8 (21.0)	1.148	77.0 (25.0)	1.000	84.2 (29.0)	0.889
55.6 (13.1)	1.524	62.8 (17.1)	1.318	70.0 (21.1)	1.144	77.2 (25.1)	0.997	84.4 (29.1)	0.887
55.8 (13.2)	1.519	63.0 (17.2)	1.313	70.2 (21.2)	1.140	77.4 (25.2)	0.994	84.6 (29.2)	0.884
55.9 (13.3)	1.513	63.1 (17.3)	1.308	70.3 (21.3)	1.136	77.5 (25.3)	0.991	84.7 (29.3)	0.882
56.1 (13.4)	1.508	63.3 (17.4)	1.304	70.5 (21.4)	1.132	77.7 (25.4)	0.988	84.9 (29.4)	0.879
56.3 (13.5)	1.502	63.5 (17.5)	1.299	70.7 (21.5)	1.128	77.9 (25.5)	0.985	85.1 (29.5)	0.877
56.5 (13.6)	1.496	63.7 (17.6)	1.294	70.9 (21.6)	1.124	78.1 (25.6)	0.982	85.3 (29.6)	0.874
56.7 (13.7)	1.491	63.9 (17.7)	1.290	71.1 (21.7)	1.120	78.3 (25.7)	0.979	85.5 (29.7)	0.871
56.8 (13.8)	1.486	64.0 (17.8)	1.285	71.2 (21.8)	1.116	78.4 (25.8)	0.977	85.6 (29.8)	0.869
57.0 (13.9)	1.480	64.2 (17.9)	1.281	71.4 (21.9)	1.112	78.6 (25.9)	0.974	85.8 (29.9)	0.866

*F=(°C x 9/5) + 32

Corrected Flow Rate= (Measured Flow Rate) * (TCF @ Feed Water Temp.)

REVERSE OSMOSIS SYSTEM OPERATION LOG

- Company Name

- Day of Start Up

- Location

- Date of Last Cleaning

- Week Of

- System Serial No.

Date					
Time					
Hour of Operation					
Filter Inlet Pressure (PSI)					
Filter Outlet Pressure (PSI)					
Concentrate Pressure (PSI)					
Pump Discharge Pressure (PSI)					
Feed Flow (GPM)					
Permeate Flow (GPM)					
Concentrate Flow (GPM)					
Recycle Flow (GPM)					
Recovery %					
Feed Temperature					
Feed TDS (PPM)					
Permeate TDS (PPM)					
Rejection %					
Feed pH					
Permeate pH					
Scale Inhibitor Feed (PPM)					
Iron (mg/L)					
Free Chlorine (mg/L)					
Hardness (GPG CaCO ₃)					

TROUBLESHOOTING CHART

SYMPTOMS	POSSIBLE CAUSES	CORRECTIVE ACTION
Low Inlet Pressure	Low supply pressure	Increase inlet pressure
	Cartridge filters plugged	Change filters
	Leaks	Fix any visible leaks
	Low inlet flow	Adjust concentrate valve
Low Permeate Flow	Low operating pressure	See low inlet pressure
	Cold feed water	See temperature correction sheet
	Defective membrane brine seal	Inspect and/or replace brine seal
	Fouled or scaled membrane	Clean membranes
High permeate flow	Exceeding maximum feed water temperature	See temperature correction sheet
	Damaged or oxidized membrane	Replace membrane
	Damage product tube O-rings	Inspect and/or replace
Poor permeate quality	Damaged or oxidized membrane	Replace membrane
	Metal Oxide Fouling	Improve pretreatment to remove metals. Clean with acid cleaners.
	Colloidal Fouling	Optimize pretreatment for colloid removal. Clean with high pH anionic cleaners.
Membrane fouling	Scaling (CaSO ₄ , CaSO ₃ , BaSO ₄ , SiO ₂)	Increase acid addition and antiscalant dosage for CaCO ₃ and CaCO ₄ . Reduce recovery. Clean with acid cleaners
	Biological Fouling	Shock dosage of Sodium Bi-Sulfate. Continuous feed of Sodium Bi-Sulfate at reduced pH. Chlorination and de-chlorination. Replace cartridge filters.
	Organic Fouling	Activated Carbon or other pretreatment. Clean with high pH cleaner.
	Chlorine Oxidation	Check chlorine feed equipment and de-chlorination system.
	Abrasion of membrane by Crystalline Material	Improve pretreatment. Check all filters for media leakage.

TECHNICAL ASSISTANCE

If technical assistance is required:

- Contact your local dealer or distributor
- Prior to making the call, have the following information available:
 - System installation date
 - Serial number
 - Daily log sheets
 - Current operating parameters (e.g., flow, operating pressures, pH, etc.)
 - Detailed description of the problem

AX – 8000 CONTROLLER SPECIFICATIONS AND INSTRUCTIONS



CONTROLLER SPECIFICATIONS

Inputs	
Tank Level Switches	(2) Normally-Closed. Preprogrammed with a single level switch prewired to a High Pressure switch. The Tank, Low Pressure and Pretreat inputs are 50% duty cycle square wave, 10VDC peak @ 10mA max. The switch inputs are dry contacts only. Applying voltage to these terminals will damage the controller.
Inlet Pressure Switch	Normally-Open.
Pretreat Lockout Switch	Normally-Closed.
Controller Power	110-120/208-240 VAC, 60/50Hz (Range: 110-240 VAC)
Permeate Conductivity	0-3000 PPM, 0-6000 μ s (standard sensor, CP-1, K=.75)
Output Circuit Ratings	
Feed Solenoid	1A. Voltage is the same as motor/supply voltage.
Flush Solenoid	1A. Voltage is the same as motor/supply voltage.
Motor	1.0 HP/110-120V, 2.0 HP/208-240V.
Circuit Protection	
Relay Fuse	F1, 5x20mm, 2 Amp, BelFuse 5ST 2-R Note: The fuse shown above is for supplemental protection only. Branch circuit protection and disconnect means must be provided externally. See Field Wiring Diagram for Branch Circuit protection requirements.
Other	
Dimensions	7" tall, 7" wide, 4" deep. Nema 4X* Polycarbonate Hinged Enclosure.
Weight	2.6 lb. (Basic Configuration).
Environment	0-50°C, 10-90%RH (non-condensing). *Note: After our modification the enclosure rating is Nema 1.

SIMPLIFIED SCHEMATICS

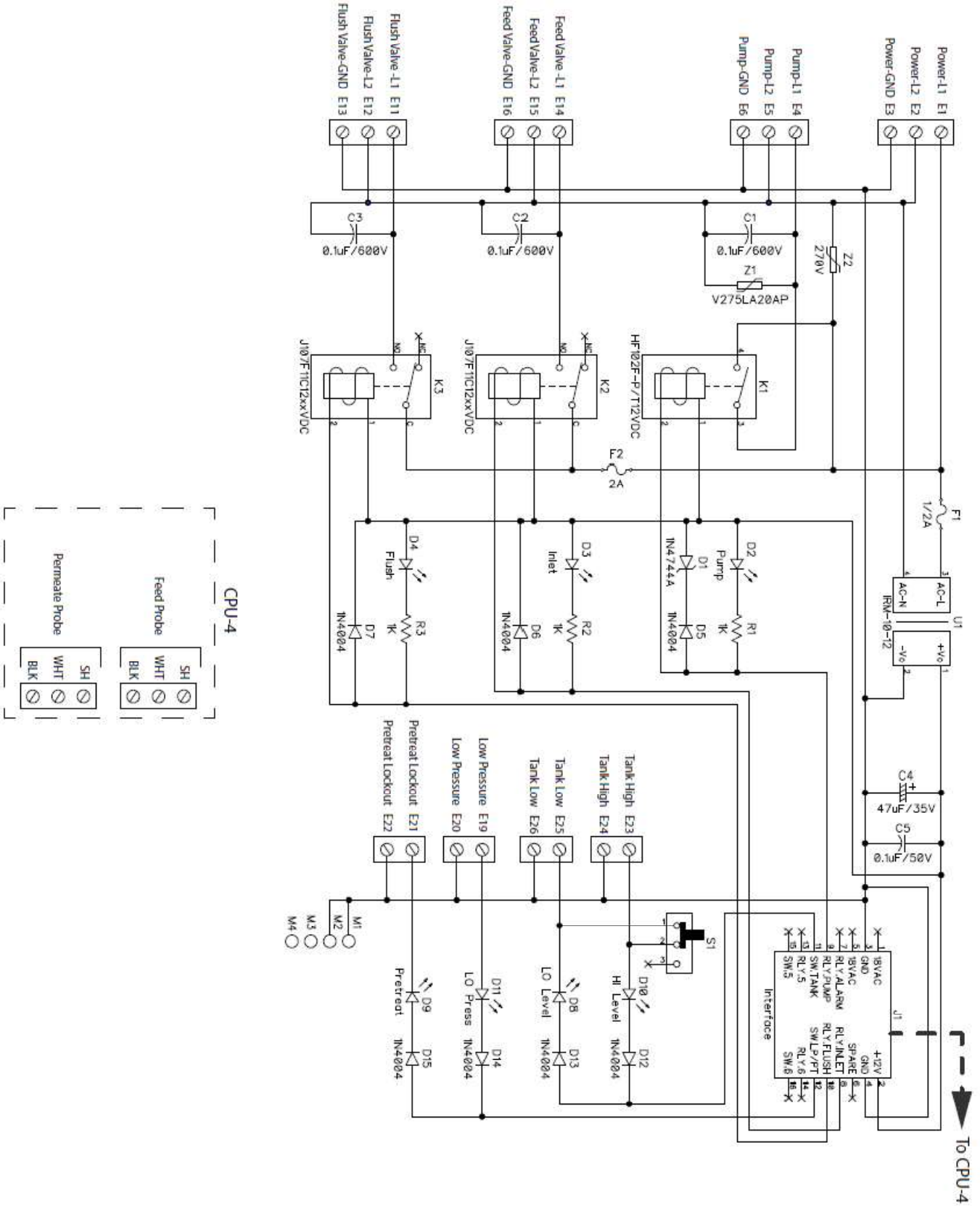

CONTROLLER OVERVIEW

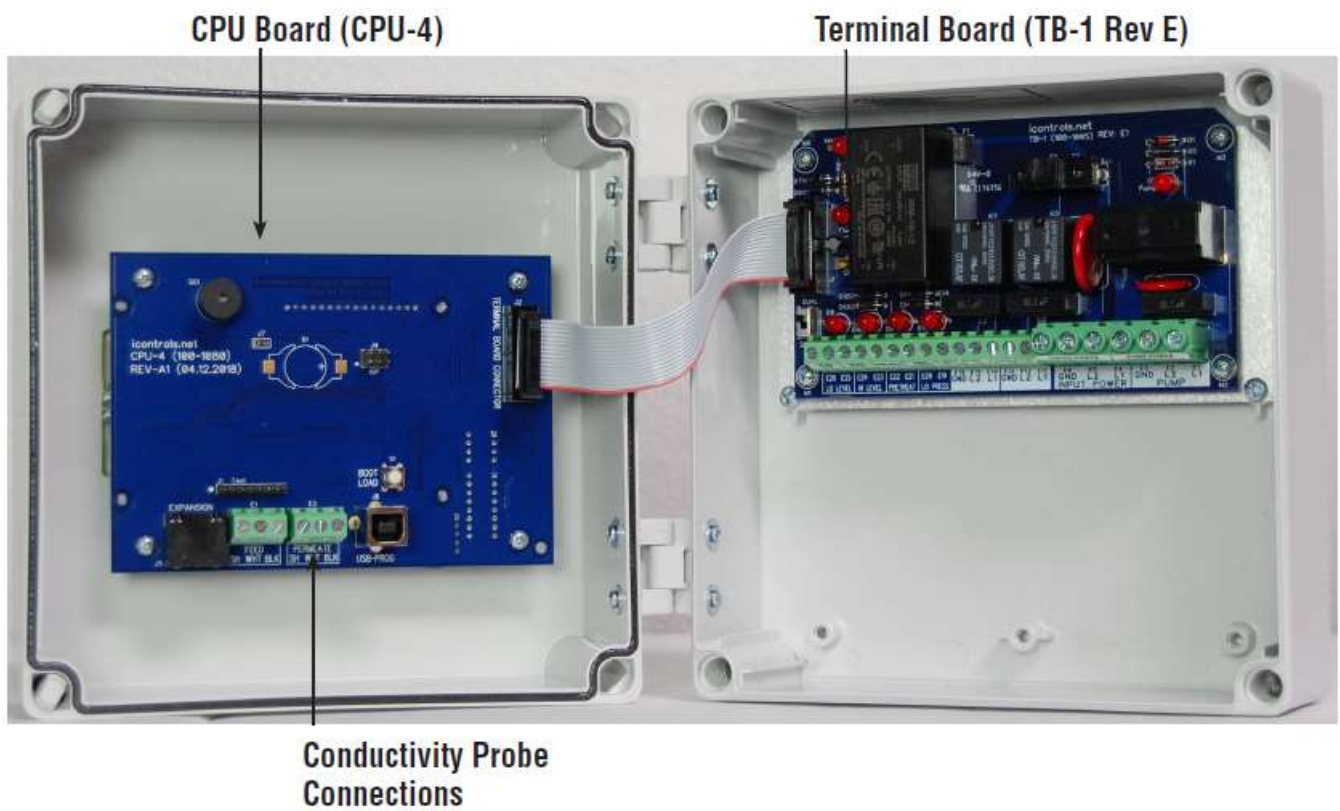
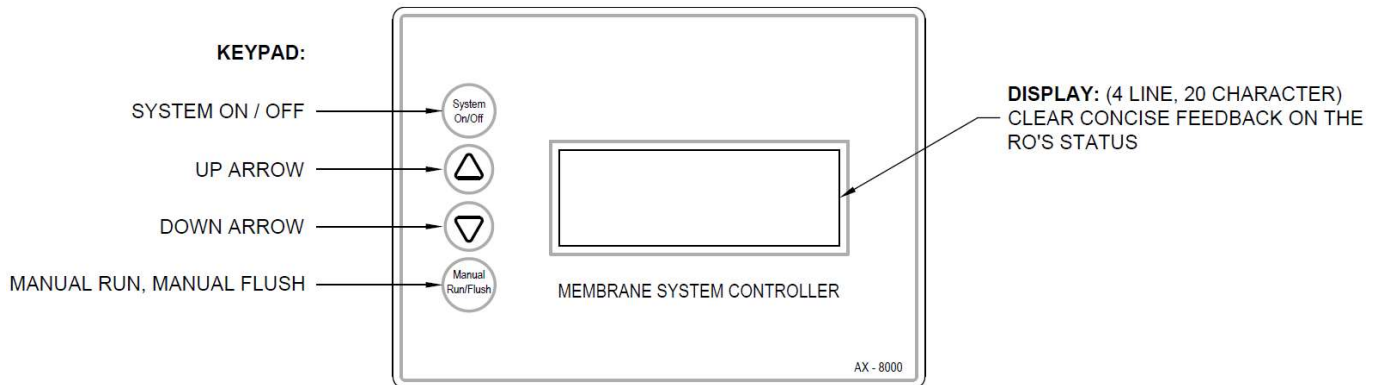

MANUFACTURER'S DRAWINGS

N – 2000 FLOW DIAGRAM

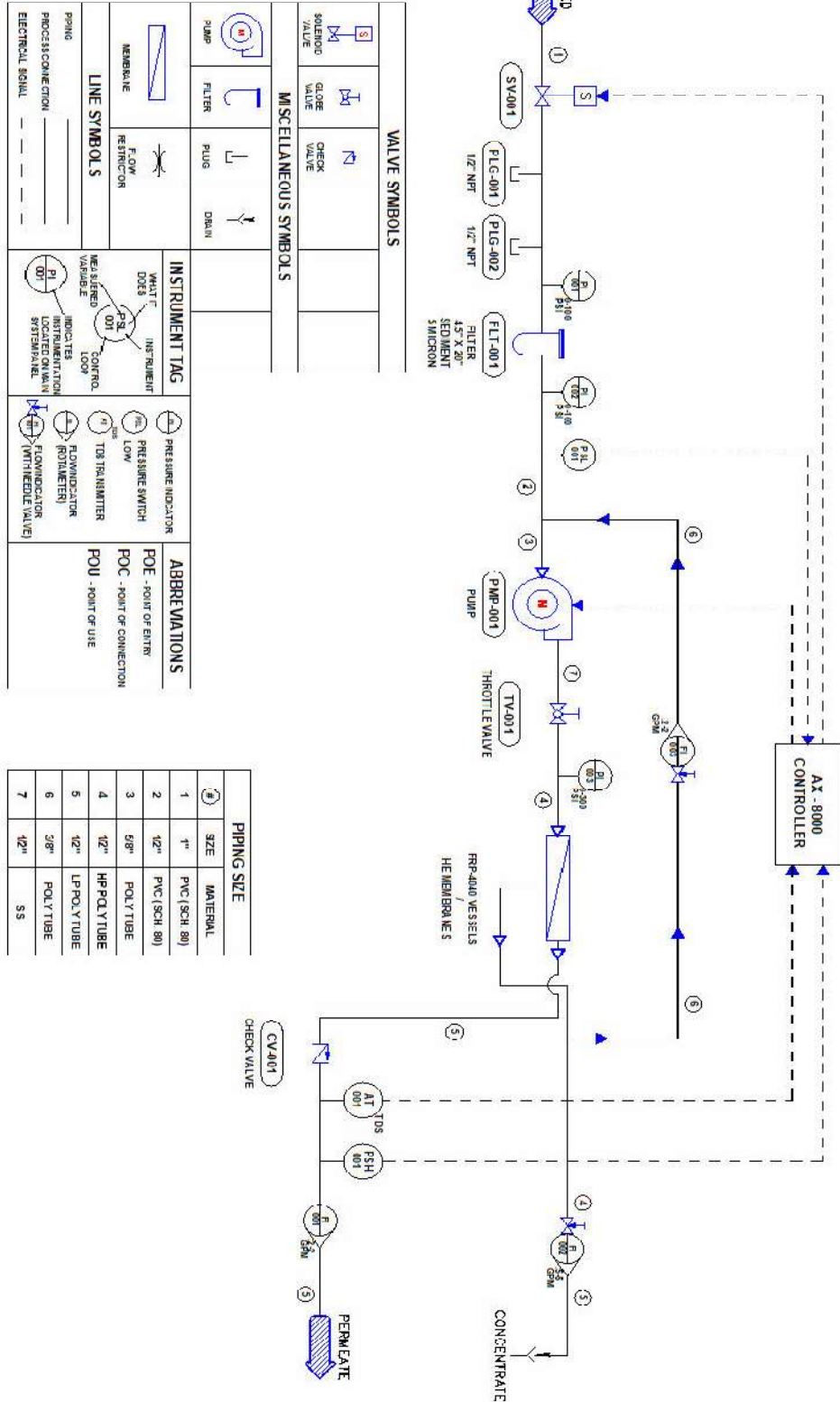

N – 4000 FLOW DIAGRAM

VALVE SYMBOLS		MISCELLANEOUS SYMBOLS		INSTRUMENT TAG		ABBREVIATIONS	

PIPING SIZE	
④	SIZE MATERIAL
1	1" PVC (SCH. 80)
2	1/2" PVC (SCH. 80)
3	5/8" POLY TUBE
4	1/2" HP POLY TUBE
5	1/2" LP POLY TUBE
6	3/8" POLY TUBE
7	1/2" SS

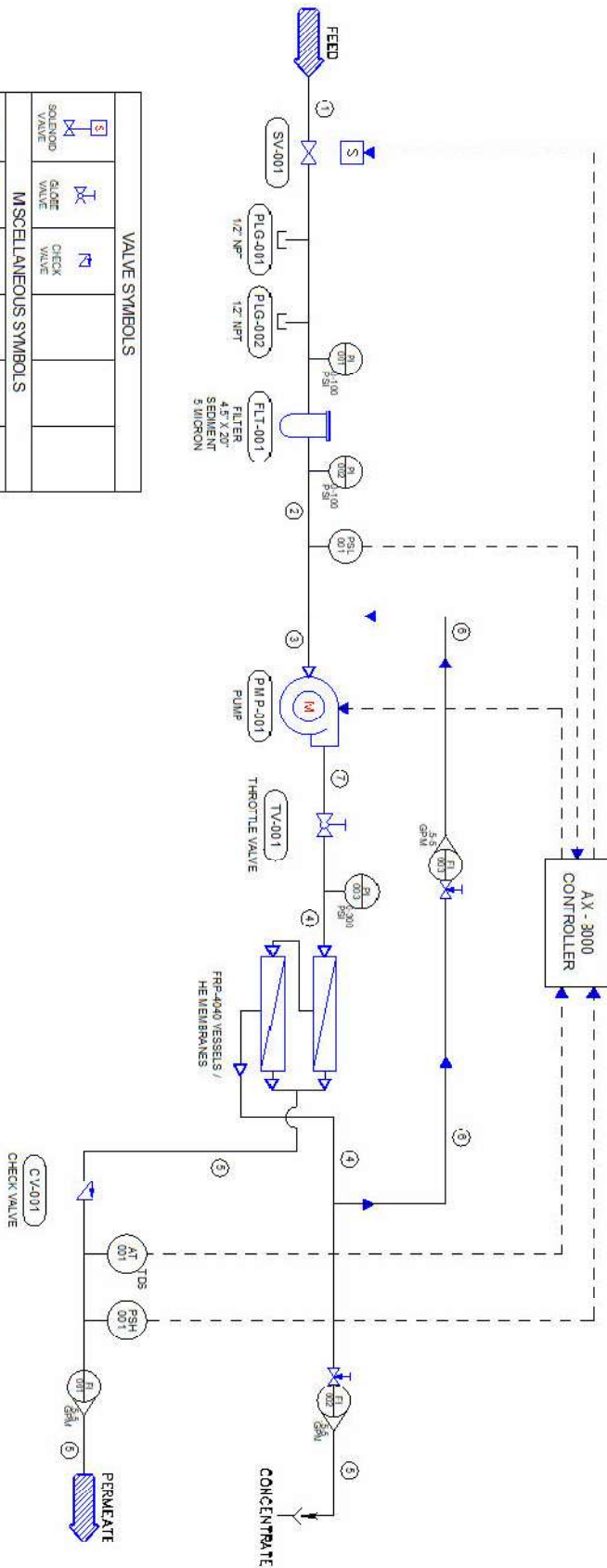

N – 6000 FLOW DIAGRAM

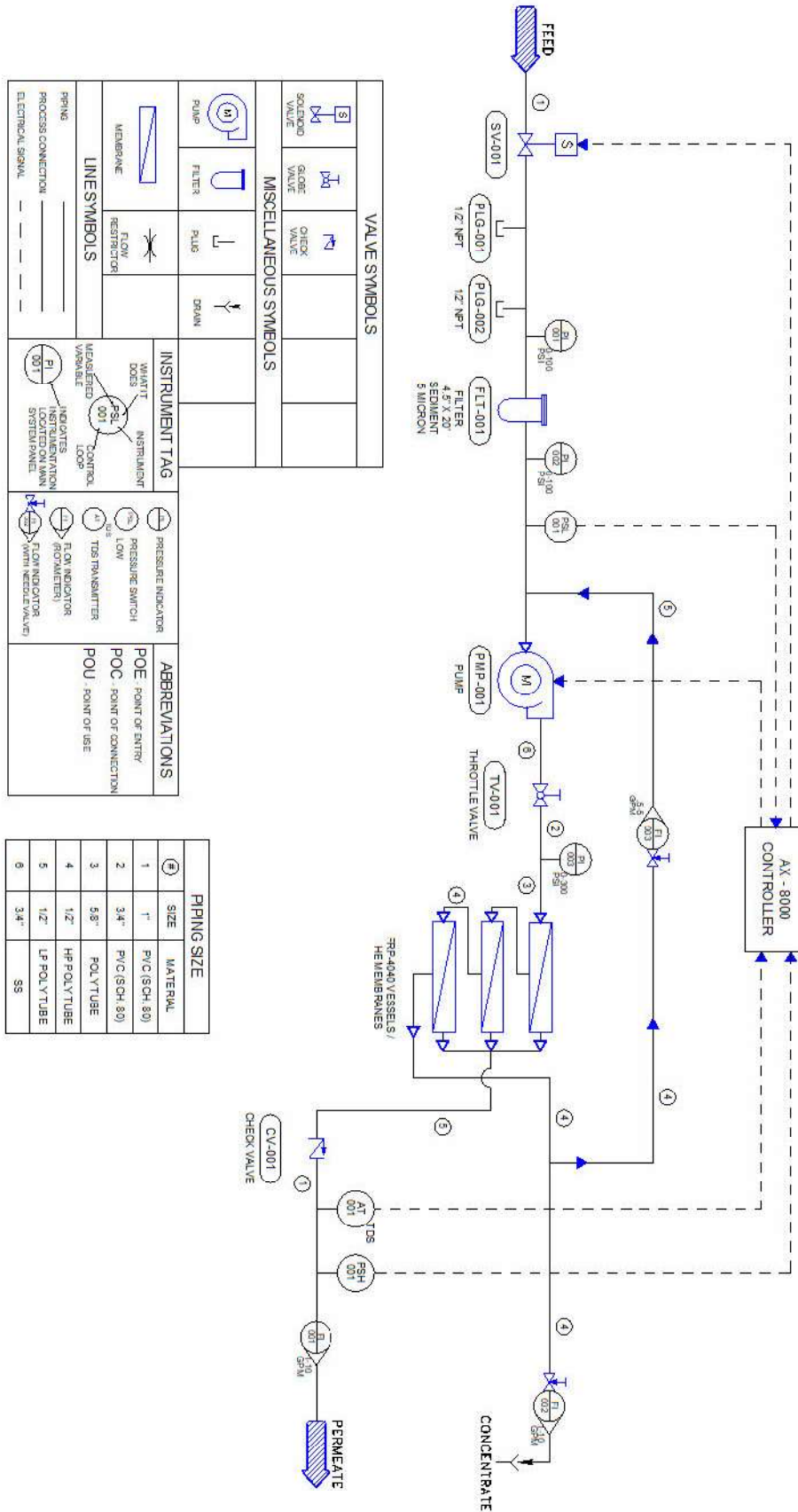

211468-PID
 SYSTEM, RO, N-6000, 220V
 60HZ, 1 PH, AXEON

N – 8000 FLOW DIAGRAM

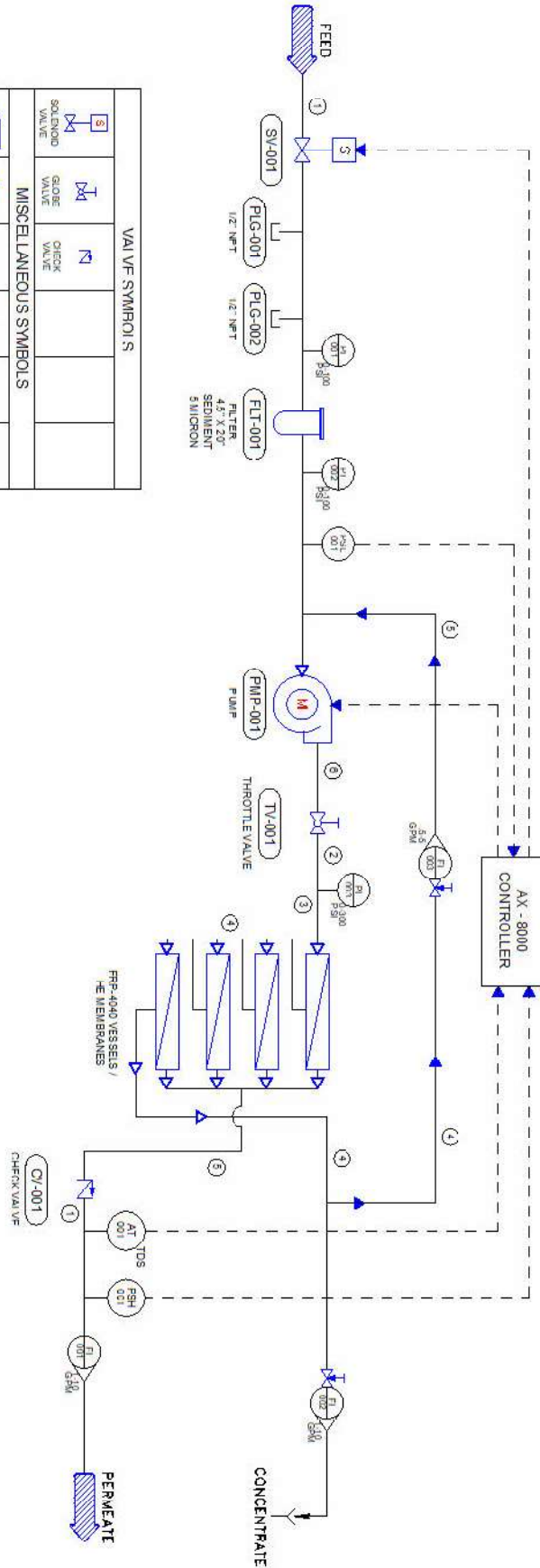

VALVE SYMBOLS		MISCELLANEOUS SYMBOLS		INSTRUMENT TAG		ABBREVIATIONS	
	SOLID VALVE		GLOBE VALVE		WANTED INSTRUMENT TAG		POE - POINT OF ENTRY
	CHECK VALVE		RESTRICTOR		PSL - INSTRUMENT LOCATED ON MAIN SYSTEM PANEL		POC - POINT OF CONNECTION
	PUMP		FILTER		MISER - INSTRUMENT LOCATED ON MAIN SYSTEM PANEL		POU - POINT OF USE
	MEMBRANE		PLUG		PRESSURE INDICATOR		
	FLOW RESTRICTOR		DRAW		PRESSURE SWITCH		
	PROCESS CONNECTION				TDS TRANSMITTER		
	ELECTRICAL SIGNAL				FLOW INDICATOR (ROTAMETER)		
					FLOW INDICATOR (W/MTI NEEDLE VALVE)		

PIPING SIZE		
④	SIZE	MATERIAL
1	1"	PVC (SCH 80)
2	3/4"	PVC (SCH 80)
3	5/8"	POLY TUBE
4	1/2"	HP POLY TUBE
6	1/2"	LP POLY TUBE
8	3/4"	SS

N – 12000 FLOW DIAGRAM

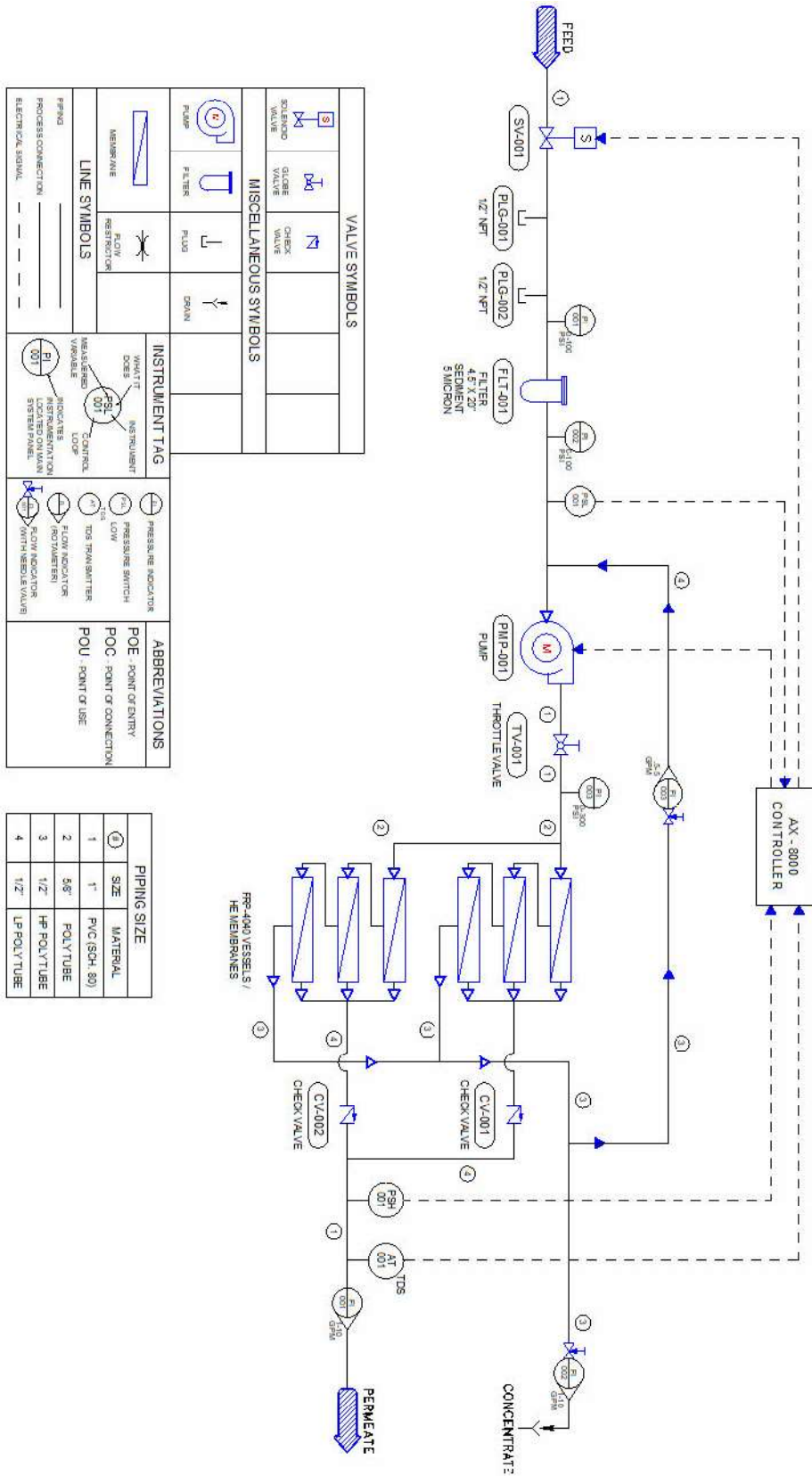

N – 16000 FLOW DIAGRAM

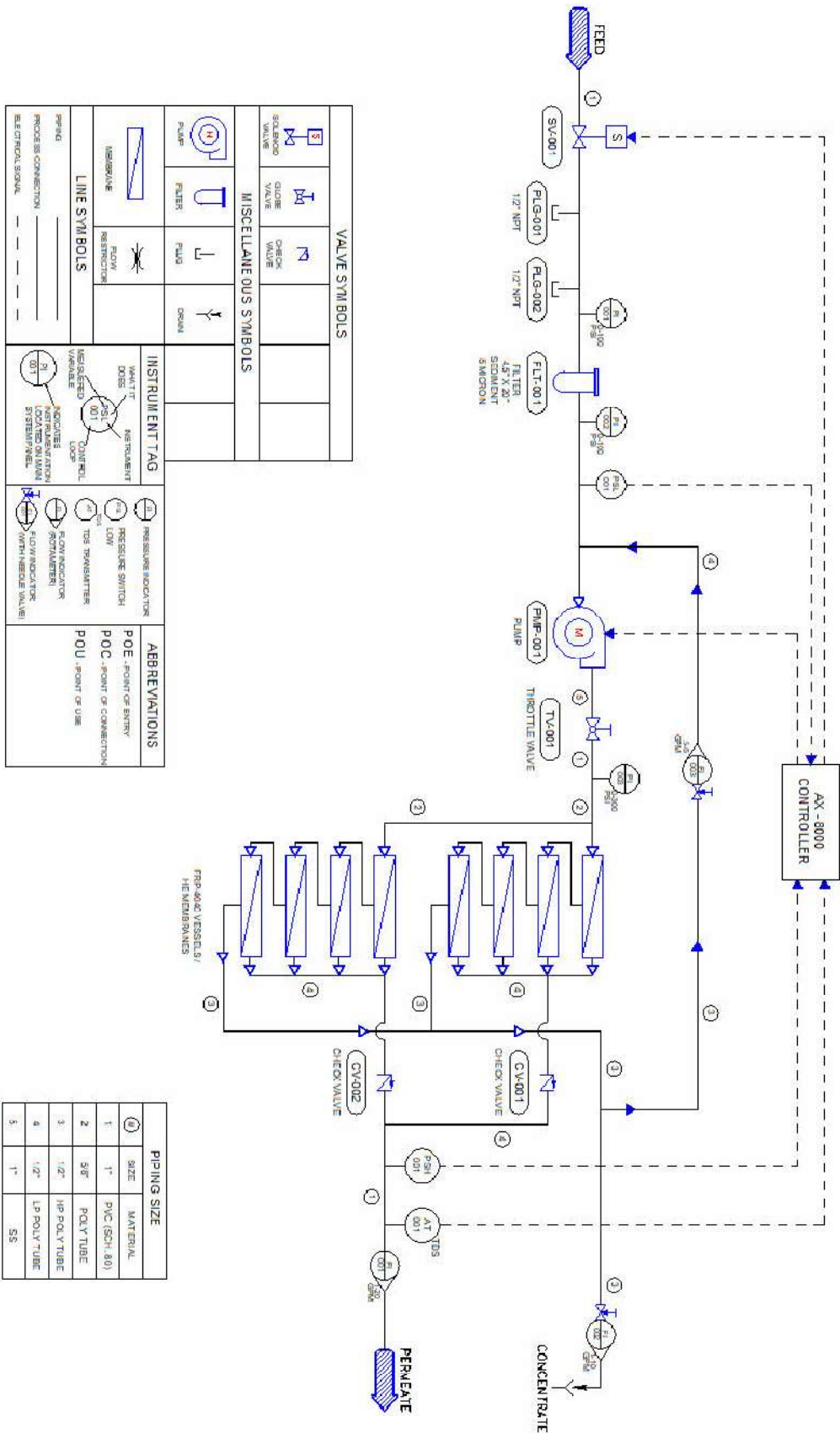

SYSTEM WARRANTY

One-Year Limited Warranty

Warranty Terms

Subject to the terms and conditions set forth hereinafter, the manufacturer (hereafter "Manufacturer") warrants to the original purchaser (hereafter the "Customer") that the systems and products manufactured by the Manufacturer are free from defects in material and in workmanship for twelve (12) months from the Warranty Commencement Date (as defined below) only when used strictly in accordance with the applicable operating instructions and within the range of the operating conditions specified by the Manufacturer for each such product.

This Warranty does not extend to systems, equipment, or components manufactured by others, nor to systems, equipment, or components manufactured by others and distributed by the Manufacturer. This Warranty does not extend to equipment or components manufactured by others which have been incorporated into a Manufacturer product but, if allowable the, Manufacturer hereby assigns, without warranty, to the Customer its interest, if any, under any Warranty made by the Manufacturer of such equipment or component. This Warranty does not cover disposable items such as fuses, O-rings, regeneration materials/chemicals, or other such disposable items, which must be replaced periodically under the normal and foreseeable operating conditions of the goods warranted hereby.

Warranty Commencement Date

The Warranty Commencement Date for each Manufacturer product shall be the later of the date of: (1) receipt by the Customer, or (2) the date of installation at the Customer's premises provided that such installation must occur within three (3) months of shipment from the Manufacturer's manufacturing facility. In no event shall the Warranty Commencement Date exceed three (3) months from the shipment from the Manufacturer's manufacturing facility. The Customer shall provide proof of purchase in order to exercise rights granted under this Warranty. If requested by the Manufacturer, the Customer must also provide proof of the installation date.

Warranty Service

THE MANUFACTURER'S OBLIGATION UNDER THIS WARRANTY IS LIMITED TO THE REPAIR OR REPLACEMENT (AT MANUFACTURER'S SOLE DISCRETION) OF ANY PRODUCT, OR COMPONENT THEREOF, PROVED TO BE DEFECTIVE IN MATERIAL OR WORKMANSHIP WITHIN THE COVERED WARRANTY PERIOD.

The Customer, at the Customer's risk and expense, shall be responsible for returning such product or component, only after obtaining a Return Goods Authorization (RGA) number from the Manufacturer, arranging for freight prepaid, and in conformance with any special packaging and shipping instructions set forth on the operation documentation or RGA instructions, or as otherwise reasonably required, to the Manufacturer, together with (1) RGA number issued by the Manufacturer at Customer's request; (2) proof of purchase and, if necessary, proof of installation date; (3) a Return Goods Authorization Form; (4) a description of the suspected defects; (5) the serial number of the Manufacturer product alleged to be defective; (6) a description of the type of water and pretreatment equipment which has been utilized in connection with the product, if any. The Manufacturer shall, in the Manufacturer's reasonable discretion, be the sole judge of whether a returned product or component is defective in material or workmanship. Required or replaced products or components shall be returned surface freight. In genuine emergency situations, the Manufacturer will (at the Manufacturer's sole discretion) forward replacement parts to the Customer without waiting for authorized return of the questionable part(s). In such cases, Customer will issue a purchase order or other payment guarantee prior to shipment. If the returned part is found to have been misused or abused, or the defective part is not received by the Manufacturer within thirty (30) days; the Customer will be invoiced for the replacement part(s) provided. This Warranty does not cover or include labor and/or travel to the Customer's premise or location or any other location. Charges of \$1000 per day plus associated travel expenses will be incurred by the Customer in providing the Warranty Service at any location other than the Manufacturer's main headquarters; that is if the Manufacturer deems that the product is not covered by said Warranty. The Manufacturer reserves the right to precondition such travel to Customer's premises upon prepayment of the Manufacturer's anticipated costs of attending such premises.

Voidability of Warranty

This Warranty shall be void and unenforceable as to any Manufacturer product which has been damaged by accident, mishandling, abuse or has been repaired, modified, altered, disassembled or otherwise tampered with by anyone other than the Manufacturer or an authorized Manufacturer service representative; or, if any replacement parts are not authorized by the Manufacturer have been used, or, the product has not been installed, operated and maintained in strict accordance and adherence with the operating documentation and manuals for such product. Any expressed Warranty, or similar representation of performance set forth in the operation documentation for media or resin incorporated into the Manufacturer product shall be void and unenforceable unless the feed water requirements set forth in the operating documentation for such product are unequivocally and strictly adhered to.

Limitations and Exclusions

THIS WARRANTY AND REMEDIES DESCRIBED HEREIN AND HEREINABOVE ARE EXCLUSIVE AND IN LIEU OF ANY AND ALL OTHER WARRANTY OR REMEDIES, EXPRESSED OR IMPLIED, INCLUDING WITHOUT LIMITATION, ANY IMPLIED WARRANTY OF MERCHANTABILITY OR FITNESS FOR A PARTICULAR PURPOSE. IN NO EVENT SHALL THE MANUFACTURER BE LIABLE FOR ANY CONSEQUENTIAL, INCIDENTAL OR OTHER SIMILAR TYPES OF DAMAGES, DAMAGES FOR THE LOSS OF PRODUCTION OR PROFITS, OR INJURY TO PERSON OR PROPERTY. NO PERSON HAS ANY AUTHORITY TO BIND THE MANUFACTURER TO OTHER THAN WHAT IS SET FORTH ABOVE.

THIS WARRANTY GIVES THE CUSTOMER SPECIFIC LEGAL RIGHTS AND THE CUSTOMER MAY ALSO HAVE OTHER RIGHTS WHICH VARY FROM JURISDICTION TO JURISDICTION. THE PARTIES RECOGNIZE AND AGREE, THAT IN ALL RESPECTS THE LAWS OF THE STATE OF CALIFORNIA SHALL APPLY TO AND SHALL GOVERN ANY INTERPRETATION OR LEGAL SIGNIFICANCE OF THIS DOCUMENT.

NO WARRANTY OR OTHER LIABILITY OF THE MANUFACTURER TO CUSTOMER UNDER THIS AGREEMENT OR OTHERWISE WILL IN ANY EVENT EXCEED THE COST OF REPLACEMENT OF THE APPLICABLE MANUFACTURER PRODUCT, PART, OR ACCESSORY THAT IS SUBJECT TO ANY BREACH OF THE MANUFACTURER'S WARRANTY. THE MANUFACTURER WILL NOT BE LIABLE FOR ANY DAMAGE TO ANY PROPERTY OF CUSTOMER OR TO CUSTOMER'S CUSTOMERS FOR ANY CONSEQUENTIAL, INCIDENTAL, OR ECONOMIC LOSS OR COMMERCIAL DAMAGE WHATSOEVER. REMEDIES HEREIN PROVIDED ARE EXPRESSLY MADE THE SOLE AND EXCLUSIVE REMEDIES FOR BREACH OF ANY WARRANTY OR OTHER OBLIGATION HEREUNDER EXPRESS OR IMPLIED OR FROM THE OPERATION OF LAW.