

Bissell®

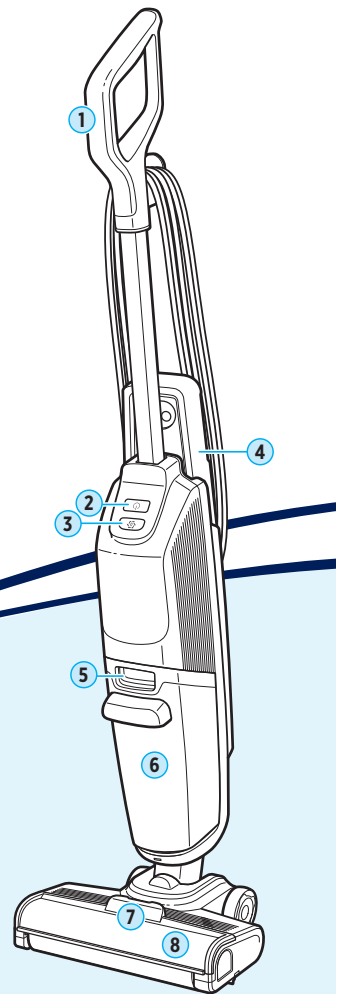

CROSSWAVE® HARD FLOOR EXPERT® ALL-IN-ONE MULTI-SURFACE CLEANER 3848 SERIES

Important Safety Instructions.....	2
What's in the Box?	3
Assembly	3
Changing the Brush Roll	4
Filling the Formula Tank	5
Cleaning Your Floors.....	6
Emptying the Dirty Water Tank.....	7
Using the Clean Out Cycle.....	7
After-Cleaning Care	8
Storing Your Machine.....	8
Troubleshooting.....	9
Limited Warranty	10



Product Overview

1. Handle
2. Power Button
3. Cleanout Cycle Button
4. Clean Water Tank
5. Dirty Water Tank Removal Button
6. Dirty Water Tank with Filter
7. Brush Roll Window Release Button
8. Brush Roll Window

SYMBOL	EXPLANATION
	Caution.
	Read operator's manual.
	Risk of fire.
	Risk of electric shock.
	For indoor use only.
	Use only BISSELL® cleaning formulas intended for use with this machine.
	Disconnect power before servicing.
	Protection against moving parts.

SYMBOL	EXPLANATION
	Risk of automatic start-up.
	Allow parts to dry.
	Use warm water, temperature up to 60°C.
	Check the manufacturer's tag before cleaning textile. "W" on the tag as shown means you can use your cleaner.
	Do not freeze.
	Warning: Slippery surface.
	Power ON/Stand-by Switch.

SYMBOL	EXPLANATION
	Clean out cycle. Automatic self-cleaning cycle after use.
	This symbol on the product and/or accompanying documents means that used electrical and electronic products should not be mixed with general household waste. For proper treatment, recovery and recycling, please take this product to designated collection points. Please contact your local authority for further details of your nearest designated collection point.

IMPORTANT SAFETY INSTRUCTIONS



READ ALL INSTRUCTIONS BEFORE USING YOUR APPLIANCE.

When using an electrical appliance, basic precautions should be observed, including the following:



WARNING

TO REDUCE THE RISK OF FIRE, ELECTRIC SHOCK OR INJURY:

- This appliance is not intended for use by persons (including children) with reduced physical, sensory or mental capabilities, or lack of experience and knowledge, unless they have been given supervision or instruction concerning use of the appliance by a person responsible for their safety.
- Children should be supervised to ensure that they do not play with the appliance.
- Floor slippery when wet.
- The appliance has to be unplugged after use and before carrying out user maintenance on the appliance.
- The plug must be removed from the socket-outlet before cleaning or maintaining the appliance.
- Connect to a properly grounded outlet only. See grounding instructions. Do not modify the three-prong grounded plug.
- Do not leave appliance when it is plugged in. Unplug from outlet when not in use and before servicing.
- Use indoors only.
- Use only cleaning products intended for use with this appliance to prevent internal component damage. See the Cleaning Formulas section of this guide. Use only BISSELL cleaning products.
- Do not allow to be used as a toy. Close attention is necessary when used by or near children.
- Do not use for any purpose other than described in this user guide. Use only manufacturer's recommended attachments.
- Do not use with damaged cord or plug. If appliance is not working as it should, has been dropped, damaged, left outdoors, or dropped into water; do not attempt to operate it and have it repaired at an authorized service center.
- Do not pull or carry by cord, use cord as a handle, close door on cord, or pull cord around sharp edges or corners. Do not run appliance over cord. Keep cord away from heated surfaces.
- A hazard may occur if the appliance runs over the supply cord.
- Do not unplug by pulling on cord. To unplug, grasp the plug, not the cord.
- Do not handle plug or appliance with wet hands.
- Do not put any object into openings. Do not use with any opening blocked; keep openings free of dust, lint, hair, and anything that may reduce air flow.
- Keep hair, loose clothing, fingers, and all parts of body away from openings and moving parts of the appliance and its accessories.
- Turn OFF all controls before plugging or unplugging appliance.
- Use extra care when cleaning on stairs.
- Do not use to pick up flammable or combustible materials (lighter fluid, gasoline, kerosene, etc.) or use in areas where they may be present.
- Do not pick up anything that is burning or smoking, such as cigarettes, matches, or hot ashes.
- Do not use without filters in place.
- Risk of injury from moving parts. brush may start unexpectedly. Unplug before cleaning or servicing.
- Do not turn your appliance ON until you are familiar with all instructions and operating procedures.
- Do not use appliance in an enclosed space filled with vapors given off by oil-based paint, paint thinner, some moth-proofing substances, flammable dust, or other explosive or toxic vapors.
- Do not use to pick up toxic material (chlorine bleach, ammonia, drain cleaner, etc.)
- Plastic film can be dangerous. To avoid danger of suffocation, keep away from children.
- This appliance must be connected to a grounded wiring system. If it should malfunction or breakdown, grounding provides a path of least resistance for electric current, reducing the risk of electric shock. The cord for this has an equipment-grounding conductor and a grounding plug. It must only be plugged into an outlet that is properly installed and grounded in accordance with all local codes and ordinances.

SAVE THESE INSTRUCTIONS

ORIGINAL INSTRUCTIONS.

FOR OPERATION ON A 220-240 VOLT A.C. 50-60 HZ POWER SUPPLY ONLY.

THIS MODEL IS FOR HOUSEHOLD USE ONLY.

IMPORTANT INFORMATION

- To reduce the risk of a leaking condition, do not store where freezing may occur. Damage to internal components may result.
- When finished using the product, wrap cord around cord wrap for storage. Store unit indoors in a dry location in an area where the product is not likely to get damaged.
- Any other maintenance or servicing not included in this manual should be performed by an authorised service representative.
- Keep appliance on a level surface.
- If your appliance has a motorised Brush Roll, do not leave machine running in the same spot without the handle fully upright.
- Plastic tanks are not dishwasher safe. Do not put tanks in dishwasher.

⚠️ WARNING

GROUNDING INSTRUCTIONS: This appliance must be connected to a earthed wiring system. If it should malfunction or break down, earthing provides a safe path of least resistance for electrical current, reducing the risk of electrical shock. The cord for this appliance has an equipment-earthing conductor and an earthing plug. It must only be plugged into an outlet that is properly installed and earthed in accordance with all local codes and ordinances.

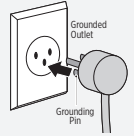

What's in the Box?

Standard accessories vary by model. To identify what should be included with your purchase, please refer to the "Carton Contents" list located on the carton top flap.

Body	Handle	Clean Tank	Tray	Trial Formula

Assembly

▶ Go to [global.BISSELL.com](https://www.global.BISSELL.com) for assembly videos.



1. Insert handle until it clicks into place.	2. Insert clean tank into back of machine until it clicks into place.	3. Wrap cord. To easily unwrap, turn Quick Release™ Cord Wrap down.

Note: Remove cardboard insert from bottom of foot before first use.

Changing the Brush Roll

Visit global.BISSELL.com to purchase additional brush rolls.

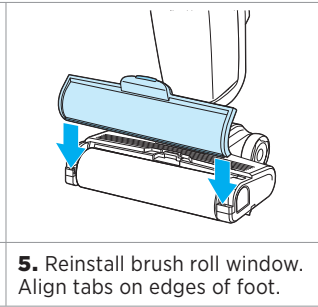
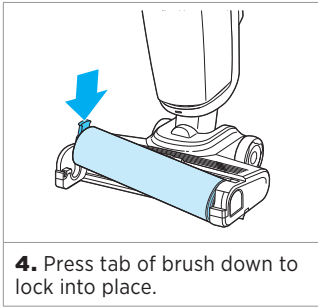
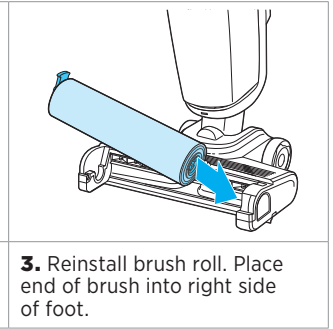
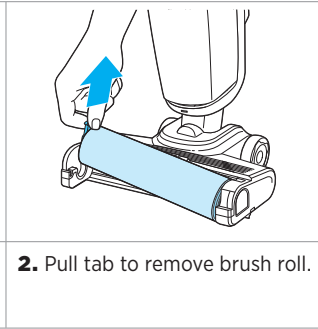
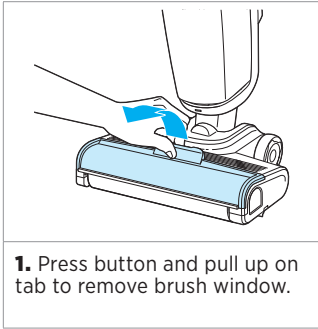

Filling the Formula Tank



This machine is compatible with BISSELL® formulas made for multi-surface cleaners. Always use genuine BISSELL formulas in your machine. Other formulas may harm the machine.
Note: Fill with warm (140°F/60°C MAX) tap water and add the appropriate BISSELL® formula. Do not use boiling water. Do not heat water or tank in microwave.

<p>1. Pull clean water tank up to remove.</p>	<p>2. Unscrew cap.</p>	<p>3. Choose your formula.* Scan the QR code with your smartphone camera or visit global.BISSELL.com for formulas.</p>
<p>4. Fill clean water tank with warm water (140°F/60°C) to water fill line (621.04 mL).</p>	<p>5. Add formula* to the formula line (88.72 mL).</p>	<p>6. Screw cap back on. Align clean water tank with grooves on back of machine and slide it until it clicks into place.</p>

*Compatible formulas include: Multi-Surface Pet, Wood Floor, Hard Floor Sanitise.

Cleaning Your Floors

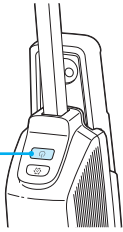

1. Press power button to turn machine ON.

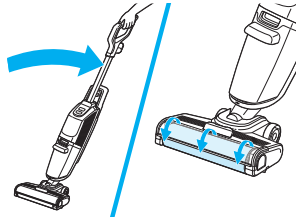

2. Recline machine to start brush roll spinning. Brush roll will not spin when machine is upright.



3. Fluid will begin once machine is reclined and may take up to 10 seconds to fully wet brush roll. Use steady forward and backward strokes to ensure best performance.

Note: This product is intended for hard floor use only. Do not use on carpet or area rugs.

Cleaning with Hard Floor Sanitise Formula

Please read "DIRECTIONS FOR USE" on Hard Floor Sanitise label. Use on hard nonporous floors only.



4. Follow steps above to remove surface dirt and debris.
To sanitise: Hold the trigger to apply solution to floor. Make forward and backward passes.



5. With wet mode ON, clean floors keeping the device in motion to apply solution to floor. Allow floor to remain visibly wet for five minutes. This may require additional passes. Do not use vacuum during this time.

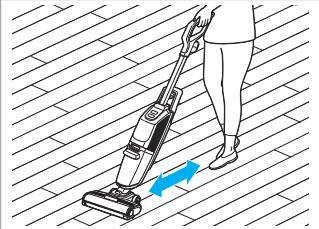

6. With the trigger released, make forward and backward passes to extract formula. Allow to air dry.

Emptying the Dirty Water Tank

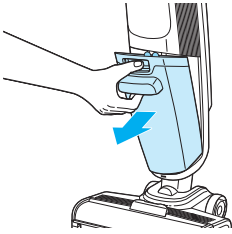

1. Press button on top of dirty water tank, grab front handle and pull out.



2. Hold top of tank near sides of filter and pull up to remove.

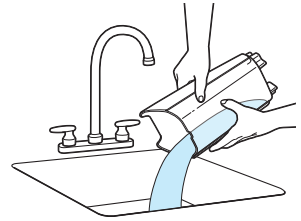

3. Pour dirty water into a sink or similar wastewater receptacle and thoroughly rinse tank.

Using the Clean Out Cycle



Note: Empty dirty water tank before beginning and make sure filter stays dry. Use clean-out cycle after each use.

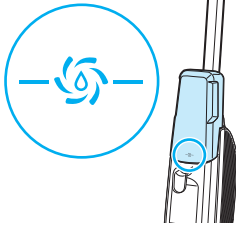

1. Make sure water reaches clean-out cycle line on clean water tank. Refill with water if needed.

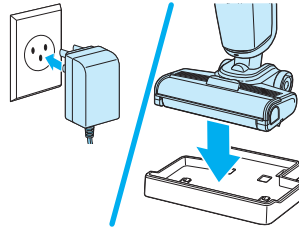

2. Plug in machine and place in storage tray.
Note: Clean-out cycle will only run with machine in tray.

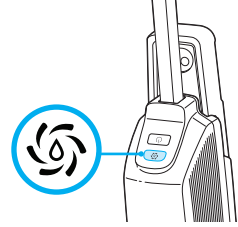

3. Press the clean-out cycle button to begin.

⚠ WARNING To reduce the risk of fire, electric shock or injury, turn power OFF and disconnect plug from electrical outlet before performing maintenance or troubleshooting.

After-Cleaning Care

For more helpful maintenance tips, check out global.BISSELL.com.

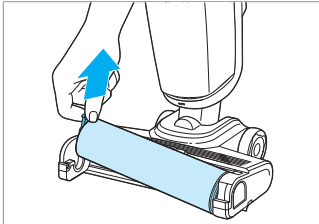

1. Remove brush roll following steps on page 4. Pull brush roll tab and let dry completely. If brush roll window is dirty, wipe excess dirt or rinse to clean.

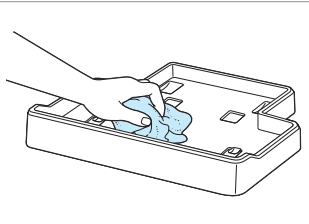

2. Remove machine from tray and wipe excess water or dirt.

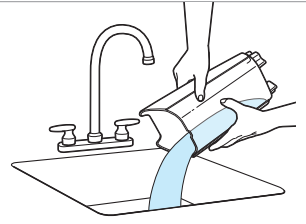

3. Empty dirty water tank and strainer following steps on page 7.

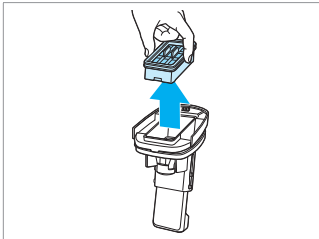

4. Remove filter from lid. Open screen and remove debris.

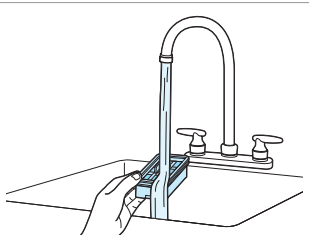

5. Wash filter in warm water and mild detergent. Clean and dry filter after each use. Replace every 3 months.

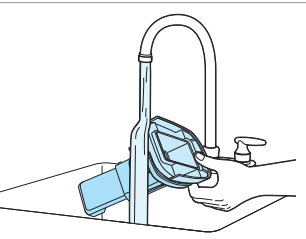

6. Rinse the bottom of the tank cover to remove wet debris.

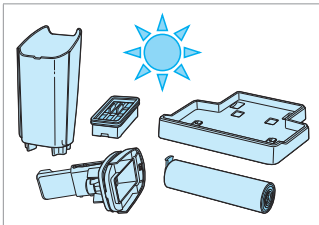

7. Let parts air dry for 24 hours, or until fully dry before next use.

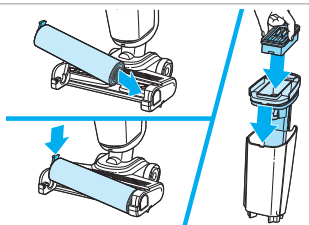

8. Reinstall brush roll following steps on page 4. Reinstall filter, strainer, and tank lid.

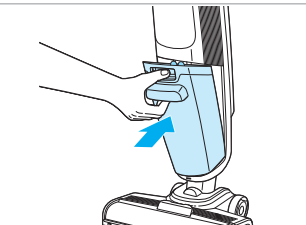

9. Insert bottom of tank first. Pivot top toward the machine until it clicks.

Note: Any other maintenance or servicing not included in this manual should be performed by an authorised service representative.

Storing Your Machine

When finished using the product, wrap cord around cord wrap for storage. Store machine indoors in a dry location in an area where the product is not likely to get damaged.

NOTICE To reduce the risk of a leaking condition, do not store machine where freezing may occur. Damage to internal components may result.

Troubleshooting

Below are some of the issues you may run into. If you don't see the issue you're experiencing below, visit global.BISSELL.com.

Problem	Possible Cause	Remedies
Reduced or no spray	Clean water tank may be empty or seated incorrectly.	Refill and reinstall the clean water tank.
	System isn't completely primed.	Allow machine to run for 15-20 seconds to fully prime.
	Brush window is not latched in place.	Unplug machine and reinstall brush window.
	Clean tank filter is dirty.	Remove clean tank from machine and locate small white foam filter under where the tank connects to the body. Clean any debris from foam filter and reinstall.
Loss of suction or streaking	Tanks may not be seated properly.	Remove both tanks and reseal them so they fit properly on machine.
	Dirty water tank is full.	Empty dirty water tank.
	Brush window is not latched in place.	Unplug machine and reinstall window.
	Debris channel in foot is clogged by debris.	Clean channel with a paper towel.
	Filter clogged by debris.	Remove debris clogging filter screen and clean filter.
Brush roll is not turning	Brush roll is not installed properly.	Follow instructions on page 4 for replacing brush roll.
	Machine is standing upright.	Step on foot and recline body of machine to turn brush roll on.
	Brush roll stalled by debris.	Unplug machine. Remove brush window and brush roll to remove obstruction.
Machine won't turn on	Brush roll stalled by debris.	Unplug machine. Remove brush window and brush roll to remove obstruction.
Machine is leaking	Cap of clean water tank is not closed properly.	Remove clean water tank and reinstall cap.
Brush roll stops turning unexpectedly and motor continues to operate	Machine is overheating.	Unplug machine from power and allow to cool for 30 minutes.

⚠ WARNING To reduce the risk of fire, electric shock or injury, turn power OFF and disconnect plug from electrical outlet before performing maintenance or troubleshooting.

Limited Warranty

This limited warranty is provided by BISSELL® International Trading Company B.V. ("BISSELL") and applies in Australia and New Zealand. It gives you specific rights. It is offered as an additional benefit to your rights under law. You also have other rights under The Australian Consumer Law or New Zealand Consumer Laws, whichever applies to you. You can find out about your legal rights and remedies by contacting your local consumer advice service. Nothing in this warranty will replace or lessen any of your legal rights or remedies. If you need additional instruction regarding this warranty or have questions regarding what it may cover, please contact BISSELL Consumer Care or contact your local distributor.

This warranty is given to the current owner of the product with the original sales receipt. The original sales receipt must include the product(s) purchased, the date purchased, and which country it was purchased from new. You must be able to evidence the date of purchase and show the product was purchased in Australia or New Zealand to submit a claim under this warranty. You will receive the warranty that is applicable to the country where your product was originally purchased, as shown on the original sales receipt. If you use the product outside of the country where it was purchased, your warranty may be void in BISSELL's sole discretion. It may be necessary to obtain some of your personal information, such as a mailing address, to fulfill the terms of this warranty. Any personal data will be handled pursuant to BISSELL's Privacy Policy, which can be found at global.BISSELL.com/privacy-policy.

Limited Two-Year Warranty

For two years from the date of purchase by the original purchaser, subject to the *EXCEPTIONS AND EXCLUSIONS identified below, BISSELL will repair or replace (with new, refurbished, lightly used, or remanufactured components or products), at BISSELL's option, free of charge, any defective or malfunctioning part or product.

BISSELL recommends that the original packaging and original proof of purchase with the date of purchase and country where purchased be kept for the duration of the warranty period in case you want to redeem the warranty during the warranty period. Keeping the original packaging will assist with any necessary re-packaging and transportation but is not a condition of the warranty.

If your product is replaced by BISSELL under this warranty, then the new item will benefit from the remainder of the term of this warranty (calculated from the date of the original purchase). The period of this warranty shall not be extended whether or not your product is repaired or replaced.

*Conditions of Warranty

This warranty applies to products used for personal domestic use and not commercial or hire purposes. Consumable components and attachments such as filters, belts, shells, water tanks, scraping strips, brushes, and mop pads, which must be replaced or serviced by the user from time to time, are not covered by this warranty.

This warranty does not apply to any defect arising from fair wear and tear, including but not limited to the battery discharging time shortening due to the aging or use. Damage or malfunction caused by the user or any third party whether as a result of accident, negligence, abuse, neglect, or any other use not in accordance with the user guide is not covered by this warranty. An unauthorised repair (or attempted repair) may void this warranty whether or not damage has been caused by that

repair/attempt. Removing or tampering with the Product Rating Label on the product or rendering it illegible will void this warranty.

Except as set out below, BISSELL and its distributors are not liable for any loss or damage that is not foreseeable or for incidental or consequential damages of any nature associated with the use of this product including without limitation loss of profit, loss of business, business interruption, loss of opportunity, distress, inconvenience, or disappointment. Except as set out below, BISSELL's liability will not exceed the purchase price of the product.

BISSELL does not exclude or limit in any way its liability for (a) death or personal injury caused by our negligence or the negligence of our employees, agents or subcontractors; (b) fraud or fraudulent misrepresentation; (c) or for any other matter which cannot be excluded or limited under law.

To make a claim under this warranty contact BISSELL Australia PTY LTD (details below). Contact BISSELL prior to returning any goods. Where agreed, BISSELL will reimburse reasonable postage / handling costs (if any) for returning goods to BISSELL. To claim expenses incurred in making a claim under this warranty please provide BISSELL with a copy of the receipt of the expenses by email or post.

For Australian Consumers Only: Our goods come with guarantees that cannot be excluded under the Australian Consumer Law. You are entitled to a replacement or refund for a major failure and compensation for any other reasonably foreseeable loss or damage. You are also entitled to have the goods repaired or replaced if the goods fail to be of acceptable quality and the failure does not amount to a major failure.

Important Notes

Please keep your original sales receipt. It provides proof of the date of purchase and where it was purchased in the event of a warranty claim. See warranty for details.

Please note that using your BISSELL machine outside of its country of original purchase and/or use with a power converter may damage your BISSELL machine and damage caused by mismatched power voltage will not be covered by your warranty.

Please note that putting vinegar, bleach, dish soap, detergent, homemade soap, and other non-BISSELL products in your BISSELL machine may damage your BISSELL machine. Damage caused by using non-BISSELL products in your machine will not be covered by your warranty.

Consumer Care

If your BISSELL product should require service or to claim under our limited guarantee, please contact us.

Australia

Telephone: 1300 247 735

Website: BISSELL.com.au

Address: 789 Springvale Road, Mulgrave, Victoria 3170

Email: consumercareau@bissell.com

New Zealand

Telephone: 0800 247 735

Website: BISSELL.co.nz

Address: 789 Springvale Road, Mulgrave, Victoria 3170

Email: consumercarenz@bissell.com

But wait, there's more!

Join us online for a complete guide to your new product, including troubleshooting, parts and more.

Go to global.BISSELL.com.



INFO



VIDEOS



PARTS



©2024 BISSELL Inc. All rights reserved.
Part Number 1640745 12/23 v4