

INSTALLATION, OPERATION & APPLICATION GUIDE

For more information on our complete range of American-made products – plus wiring diagrams, troubleshooting tips and more, visit us at www.icmcontrols.com



**DYNAMIC
START DELAY
BUILT IN!**



FEATURES

- Starting current reduction and self-learning algorithm
- Built-in start capacitor
- Over-current protection
- Over/under voltage monitoring
- Diagnostic indicators
- Sealed enclosure

SPECIFICATIONS

Semi-Conductor Soft-Start Motor Controller, Form 2, Bypassed Controller

- SCCR: 5kA
- Uimp = 4kv
- Ue = 240 VAC
- Pollution degree 3
- Ui = 240 VAC

Input (L1, L2) – 100-240 VAC 50/60Hz

- Over voltage limits:** 115 VAC nominal = 140 VAC, 240 VAC nominal = 264 VAC
- Under voltage limits:** 115 VAC nominal = 95 VAC, 240 VAC nominal = 195 VAC

Outputs: Compressor

- Solid state/relay**
- Current:** Max. nominal = 32A
- Over current limits:** ICM870-32A = 40A

Environmental:

- Ambient temperature:** 40°C @ 32 FLA, 8 hour duty
- Storage temperature:** -40°F to 149°F (-40°C to 65°C)
- Humidity:** 0-95% non-condensing
- Enclosure:** IP65
- Dimensions:** 7.94" x 4.20" x 2.10"
- Screw hole center points:** 7.36" x 2.97"

IMPORTANT SAFETY INFORMATION



HIGH VOLTAGE WARNING – Always turn off power at the main service panel before installing.

CAUTION: The ICM870-32A must be mounted in an area where it will not be exposed to water or the elements. Exposure of the ICM870-32A soft start to water can cause failure of the control and is a risk for fire or other electrical safety hazards.

Suitable for use on a circuit capable of delivering no more than 5,000 RMS Symmetrical Amperes, 240 V maximum when protected by a circuit breaker with no more than 60 A.

Installation of any ICM870-32A soft start must be done by a certified HVAC technician or licensed electrician. All installations are to be done in accordance with local, state, and national electrical codes.

WARNING: Using an undersized generator or inverter with the ICM870 soft start can result in a dangerous condition. Always size your generator or inverter appropriately for your application.

APPLICATION

The **ICM870-32A** is intended for Marine, Recreational Vehicle, HVAC and commercial applications. The **ICM870-32A** integrates compressor in-rush current over startup time, thus reducing peak current demand on a power supply source (such as a generator). The **ICM870-32A** will monitor system health including voltage, current, compressor startup and self integrity. Upon a fault condition, the **ICM870-32A** will halt operation and initiate a 4-minute anti-short cycle routine while providing diagnostic fault information by means of an LED indicator.

ICM870-32A COMPARABLE AMPERAGE CROSSES

The **ICM870-32A** model replaces amperage-corresponding models from the following manufacturers:

- Micro-Air** (EasyStart)
- Hyper Engineering** (Sure-Start)
- Dometic** (SmartStart)
- Carlo Gavazzi** (Smooth Starter)
- Network RV** (SoftStartRV)

STANDARD AND TEST RESULTS

- UL 60947-1
- IP65
- UL 60947-4-2
- CSA C22.2 NO. 60947-1
- Altitude: 2000 m
- CSA C22.2 NO. 60947-4-2

LED INDICATORS

START = Green • **RUN** = Green • **FAULT** = Red (flashing)

FLASH CODES

Flashes	Flash Conditions
1	High or low voltage
2	Compressor not sensed or open fuse
3	High current
4	Compressor start error
5	Invalid operating frequency
Rapid	Normal start delay active

FOR RESIDENTIAL A/C's

WIRING DIAGRAM (GENERAL LAYOUT)

Figure 1

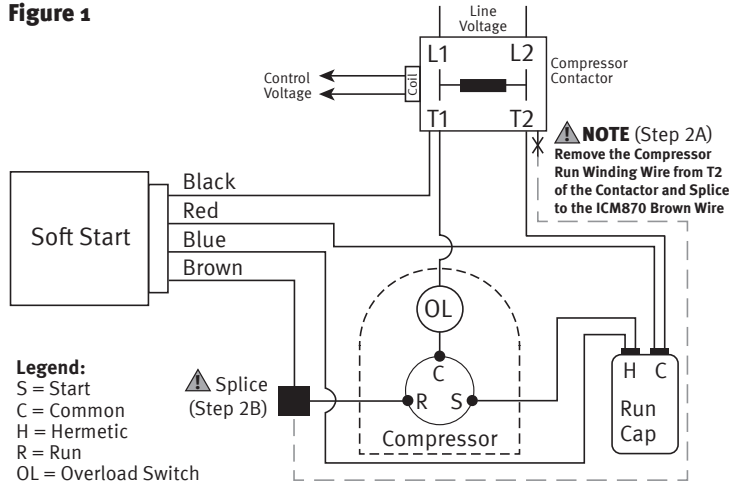

Special attention should be made with respect to the termination of the field wiring leads, only at terminals suitable for a 90°C wire at minimum.

TYPICAL INSTALLATION

NOTE: For Trane or American Standard units, T1 and T2 are labeled differently from Figure 1. Wire according to Figure 3 for those units.

Step #1 Connect the (ICM870 RED WIRE) > to the run capacitor terminal (c/common/T2). See Figure 3 for Trane and American Standard.

Step #2 a) Disconnect factory installed compressor run wire from the contactor terminal (T2). See Figure 3 for Trane and American Standard.

b) Splice the (ICM870 BROWN WIRE) > to the compressor run wire previously disconnected in (Step 2A)

If there is a Start Capacitor and/or Start Relay already in place, disconnect them prior to installing the ICM870.

Step #3 Connect the (ICM870 BLUE WIRE) > to the run capacitor terminal (herm/hermetic/start)

Step #4 Connect or splice the (ICM870 BLACK WIRE) > to the contactor terminal (T1). See Figure 3 for Trane and American Standard.

WIRING DIAGRAM FOR TRANE & AMERICAN STANDARD HVAC UNITS

Figure 3

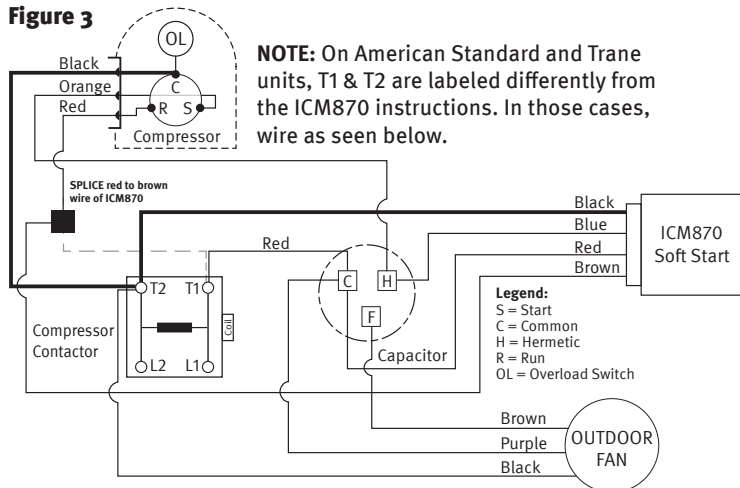

FOR RV & MARINE A/C's

WIRING DIAGRAM (GENERAL LAYOUT)

Figure 2

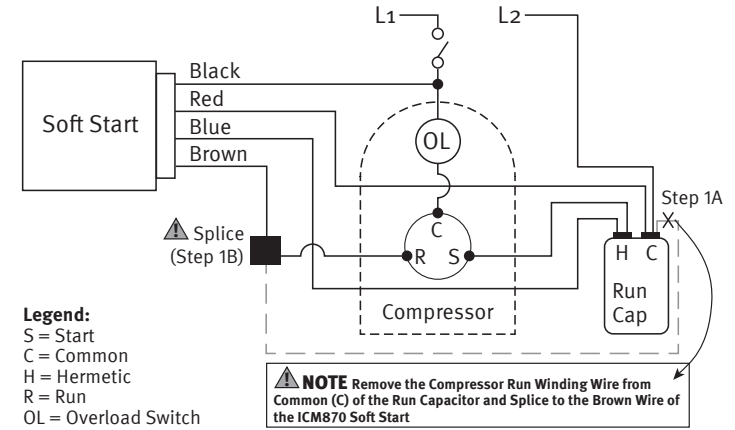

INSTALLATION

Step #1 a) Disconnect factory installed compressor run wire from the common run capacitor / L2 terminal

b) Splice the ICM870 BROWN WIRE > to the factory installed compressor run wire previously disconnected in step #1A.

If there is a Start Capacitor and/or Start Relay already in place, additional steps will be required to disconnect them.

Step #2 ICM870 RED WIRE > to the run capacitor (c/common/L2) terminal

Step #3 Connect the ICM870 BLUE WIRE > to the run capacitor (herm/hermetic/start) terminal

Step #4 Splice the ICM870 BLACK WIRE > with the factory install compressor Overload Switch wire (OL/L1)

WHICH MODEL DO I NEED?

ICM870-9A: For AC's with a Compressor Rated Load Amps (RLA) of up to 9A

ICM870-16A: For AC's with a Compressor Rated Load Amps (RLA) of 9.1-16A

ICM870-32A: For AC's with a Compressor Rated Load Amps (RLA) of 16.1-32A

This chart reflects average conversions of Single-Phase Air Conditioning and Heat Pump Tonnage, BTU's, HP, and RLA. Please refer to your user manual or service panel to determine your actual RLA before deciding which model ICM870 you need.

Air Conditioning & Heat Pump Loads – Average

Size	BTU	RLA	ICM870 Model
3 Ton *	36,000	16	16A
4 Ton	48,000	22	32A
5 Ton	60,000	26	32A
6 Ton	72,000	32	32A

* NOTE: for 3-ton units, use ICM870-32A if RLA exceeds 16A