

LSPU8653X



Product family	Dishwashers
Width	24"
Commercial height	86 cm
Installation	Under counter built-in
N° baskets	3, FlexiDuo
Engine	Single phase
EAN code	8017709303754



Programs / Functions



Number of programs	10+1	Daily (half load)	Yes
Washing temperatures	100, 113, 122, 130, 150, 158, 167 °F	Delicates	Yes
Soak	Yes	Auto	Yes
Express 27'	Yes	Crystal & China	Yes
Mix	Yes	Eco express	Yes
Self Clean	Yes	Pots & Pans	Yes
Sterilize	Yes		

Options



Dry Assist option	Yes	FlexiZone half-load option	Yes
Delay start	Up to 24 hours	Special programs option	Yes

Baskets



Basket components finish	Gray	Lower basket	With 4 foldable racks
Upper basket	3 foldable racks	Lower basket with anti-drip inserts	Yes
Upper basket height adjustment	On 3 levels	Largest loadable dish in lower basket	13 3/4 inches

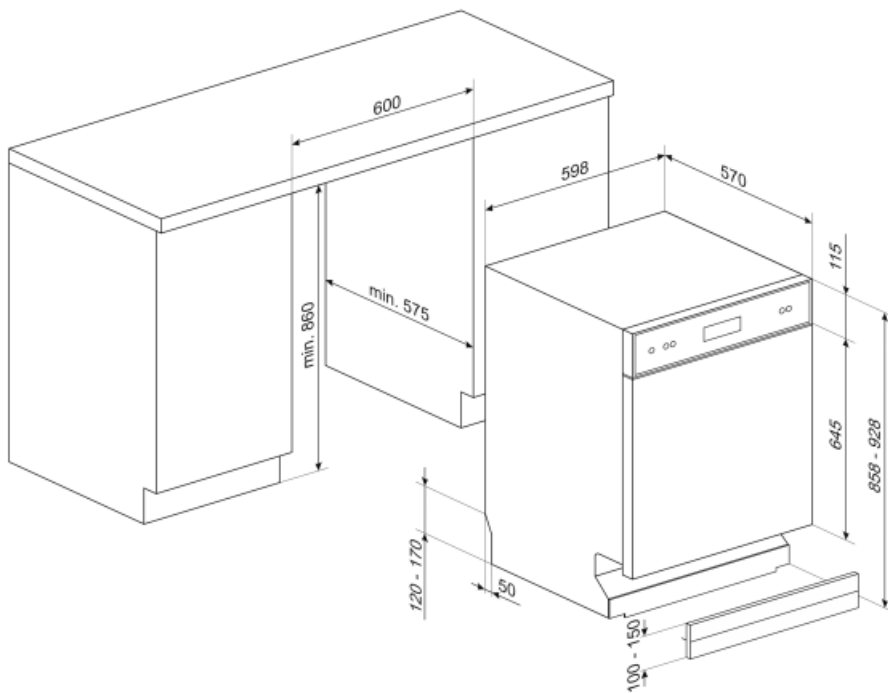

Not included accessories



KITPL60N

Toekick Kit in Black colour with adjustable height and deepness. Can be installed over all the fully integrated and underbench models with variable fulcrum or flexifit hinges.



KITPL60B

Toekick Kit in White colour with adjustable height and deepness. Can be installed over all the fully integrated and underbench models with variable fulcrum or flexifit hinges.

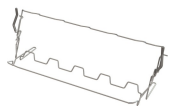

KITGH

Kit glass holder. It has to be fitted on the first basket but only if there are foldable racks



KITPL60X























Toekick Kit in Stainless Steel with adjustable height and deepness. Can be fitted over all the fully integrated and underbench models with variable fulcrum or flexifit hinges.



KITPLV2

Kit extension for dishwasher and washing machine: lenght mt. 2

Symbols glossary (TT)

	Aquatest measures the clarity of the water during an auto program, and automatically ensures the minimum consumption of water and energy.		Anti-drip: Some models of dishwashers are equipped with special polymer nozzles anti-drip, that improve the process of drying.
	COMM_HEIGHT_86_72dpi		Delay Timer: The delay timer can postpone the start of the program by up to 24 hours.
	LED display: to show programmes, functions and options selected and the time to the end of the cycle.		Enersave: At the end of the drying cycle a special device slowly automatically opens the door a few centimeters, to ensure perfect drying and to save up to 20% of energy on some models.
	FlexiDuo: The FlexiDuo 3rd cutlery basket allows you to arrange cutlery or small cups, ladles, or bulky utensils however you like: it consists of two separate and moveable modules.		FlexiZone: The 1/2 load flexizone allows you to wash a reduced load saving energy, water and time and there are no restrictions on where the items are placed.
	The new ExtraGlide guide system, available on top of the range models, makes the second basket even smoother and softer. In fact, it facilitates the extraction of the introduction, even at full load and, for the greater excursion, the insertion of crockery is also facilitated in the rear part.		Noise Level: Excellent insulation and special devices keep noise to a minimum.
	PLANETARIUM_WASHING_SYSTEM_72dpi		Delicate: Delicate washing program is designed for delicate dishes which are not heavily soiled.
	1/2 load: This program is designed for washing dishes not heavily soiled with partial load of the dishwasher.		Delicate: Delicate washing program is designed for delicate dishes which are not heavily soiled.
	Normal programme: The normal programme is suitable for normal degrees of dirt for everyday use.		Soak programme: The soak programme provides a rinse to prevent dirt from drying.
	Rapid 27 Mins: The rapid 27 mins quick program takes just 27 minutes to wash a load.		The symbols show the number of plate settings of the dishwasher.
	Total Acquastop: In addition to the partial Acquastop protection present in all Smeg dishwashers, some models have an electronic device fitted to the water intake hose, which monitors water levels in the machine, detects leaks in the hose and switches off the water supply immediately when necessary.		...
	...		...