



User Guide

MANTLE – REPLACEMENT PCB

The creators of beautiful, sustainable lighting.

Discover the full Tala family at tala.co.uk

PREPARATION

Please read instructions thoroughly before installation and keep them for future reference.

Improper assembly can undermine the safety and longevity of the product.

IMPORTANT

The product is designed to work with the Mantle Batteries provided. Do not use alternative batteries as product will not work effectively. For replacements, visit the Tala website or contact us for assistance.

Avoid turning on product in hot temperatures above 35°C. Doing so will reduce lumen output and bulb lifespan.

WARNING

Ensure bulb and PCB are fully installed and base is sealed before exposing to damp environments and do not allow internal components and surfaces to be exposed to water.

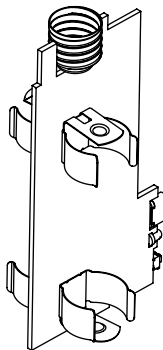
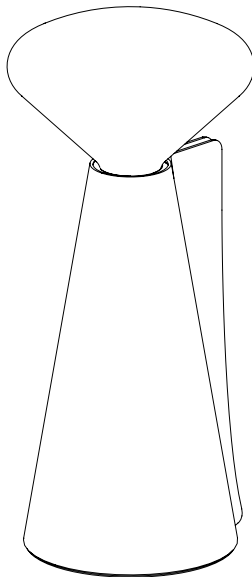

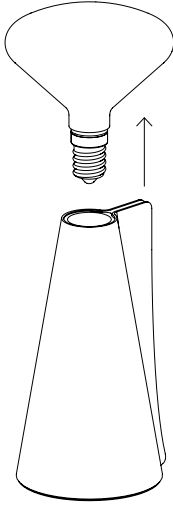
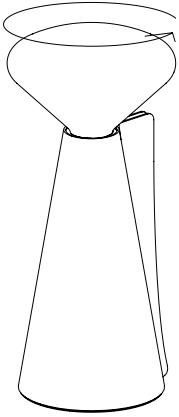

STEP 1

Ensure the fixture is turned off by pressing the dimmer button at the back of the fixture until light source is off.

Remove the bulb by screwing anti-clockwise until released from the fixture.

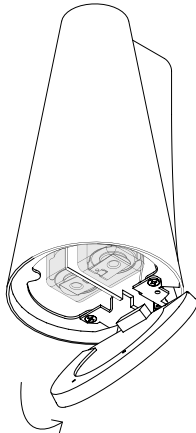
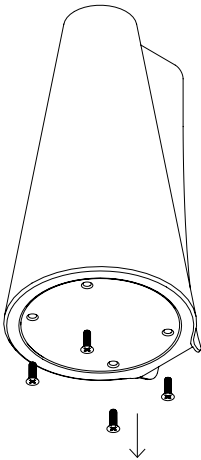

STEP 2

Using a screwdriver, remove the four screws on the underside of the fixture.

Pull back the silicone on the base of the fixture to reveal the internal construction. Ensure the silicone is completely free from the internal structure.

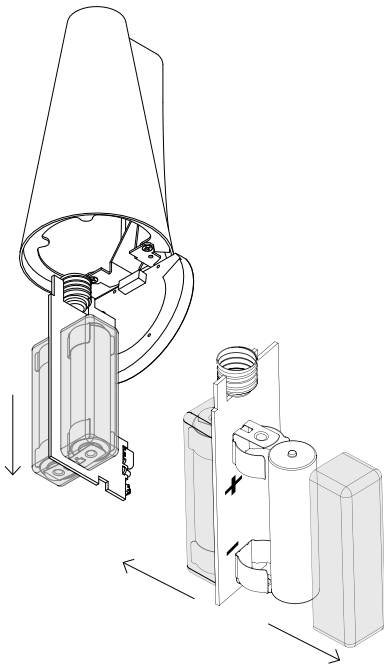

STEP 3

Carefully pull the PCB down and out of the fixture.

Remove the battery cover and batteries from the battery clips. Take care to note the battery orientation.

Place the batteries into the new PCB. Take care to install the batteries in the correct orientation. Incorrect orientation will result in damage to the fixture. Replace the battery covers.

Do not use any other battery than provided by Tala.

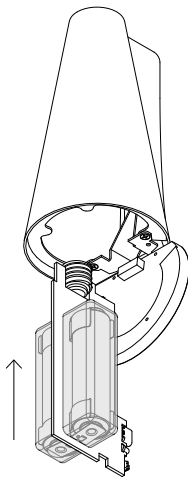

STEP 4

Return the PCB inside the fixture.

Ensure the USB-C socket and LED are located correctly in the silicone.

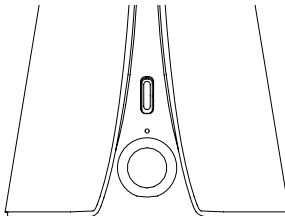

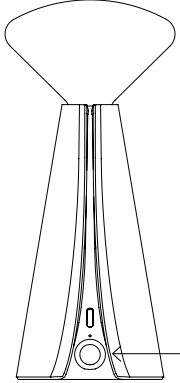
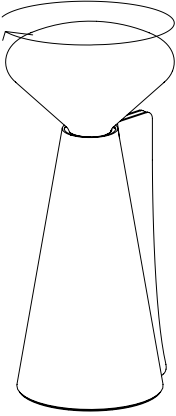

STEP 5

Re-install the base and screws.

Screw in the bulb until tight. The silicone around the bulb neck is tight to prevent water ingress, the bulb may need tightened more than expected.

Test the lamp by pressing the dimmer button. The battery indicator light should illuminate if the PCB is inserted correctly.

If bulb does not turn on at this point, first make sure the bulb is fully installed in the fixture before re-adjusting the PCB.

CARE AND CLEANING

We recommend cleaning with a soft dry cloth. Do not use abrasive materials as these will damage the finish of the product. Do not use alcohol or other solvents.

Join the Community

Instagram: @tala | Facebook: talaHQ | Pinterest: TalaLED | Tag: lighttoliveby

Tala Studios, 25B Vyner Street, London E2 9DG | hello@tala.co.uk

Tala Europe B.V, Bertus Aafjeshove 40, Nieuwegein 3437JN, Netherlands

Tala North America, Inc., 2 Research Place, Suite 300, Rockville, MD 20850, United States of America