

BUTTERFLY PENDANT

Product Specification

Tom Raffield

Butterfly Pendant

Ash - £475 Oak - £485 Walnut - £495

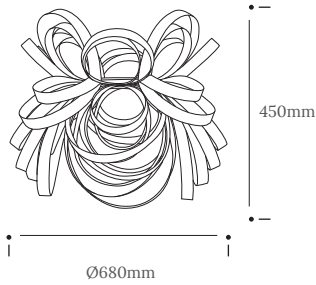

Butterfly Pendant Giant

Oak - £965 Walnut - £995

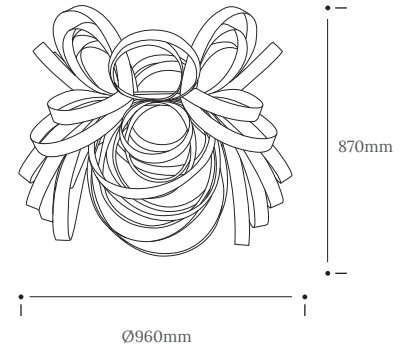





A medley of layered strips arc in swooping curves. Beating wings in full flight. Our Butterfly Lighting Range balances beauty and energy to striking effect.

Dynamic. Bold. Wild. A surge of vitality; a precision of craftsmanship. Shaped from sustainably sourced ash, oak or walnut, in its loops light collects, then falls free. Casting a subtle, warm glow alongside lively shadows – the Butterfly creates an atmosphere that's truly arresting.

Introduce vitality. Invite admiration.

The Butterfly Lighting Range is also available as a floor light.

Product Type : Pendant Light	SKU	Wood types	Dimensions L x W x H (mm)		Weight (kg)	
			Unboxed	Boxed	Unboxed	Boxed
Butterfly Pendant	TR-BUT-P-A	Ash	Ø680 x 450	620 x 615 x 530	1.1	3.3
	TR-BUT-P-O	Oak				
	TR-BUT-P-W	Walnut				
Butterfly Pendant Giant	-	-	Ø960 x 870	930 x 930 x 940	2.6	9.35
	TR-BUT-P-O-GNT	Oak				
	TR-BUT-P-W-GNT	Walnut				
Materials	Ash 	Oak 	Walnut 	Other materials Birch ply hanging disk 		
Finish	Non-toxic, hard wearing water based varnish - satin					
Ceiling kit options	Brushed steel ceiling rose and bulb holder 	Ceiling kit	Flex		Reccomended light bulb	
		Ceiling rose: Ø100mm E27 (240v) / E26 (110v)	Flex colour: clear plastic Flex length: 2m or 4m (Adjustable)		Max 25W LED	
Care information	Dusting your light regularly and with a light feather duster should keep your light looking clean, otherwise wipe with a damp cloth and remove any moisture with a dry cloth. Gentle furniture polishes can also be used.					
Additional information	<ul style="list-style-type: none"> This light can be used with your existing E27/E26 pendant fitting. Suitable for use on 240v and 110v circuits. A shade ring adaptor can be supplied so the light can be used on a bayonet (B22) pendant fitting. Installation instructions included. 					

Tom Raffield Ltd, F3 Church View Business Park, Bickland Water Rd, Falmouth TR11 4FZ, UK
 tomraffield.com contact@tomraffield.com +44 (0) 1326 722725 #tomraffield @tomraffield

Due to the character of handcrafted natural products, all dimensions are approximate. Wood colour may slightly vary.
 All products, prices and leadtimes are correct at time of print and are subject to change without notice.