

BUTTERFLY PENDANT

Product Specification

Tom Raffield

Butterfly Pendant

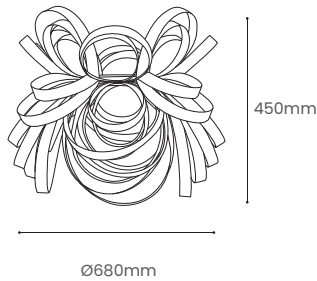

Butterfly Pendant Giant

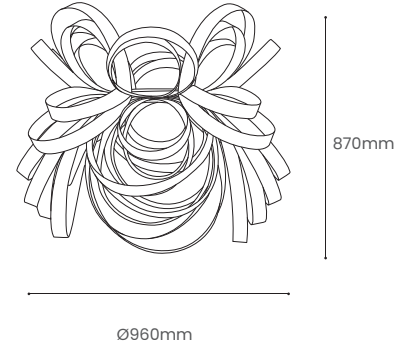





A medley of layered strips arc in swooping curves. Beating wings in full flight. Our Butterfly Lighting Range balances beauty and energy to striking effect.

Dynamic. Bold. Wild. A surge of vitality; a precision of craftsmanship. Shaped from sustainably sourced ash, oak or walnut, in its loops light collects, then falls free. Casting a subtle, warm glow alongside lively shadows — the Butterfly creates an atmosphere that's truly arresting.

Introduce vitality. Invite admiration.

The Butterfly Lighting Range is also available as a floor light.

Product Type : Pendant Light	SKU	Wood types	Dimensions L x W x H (mm)		Weight (kg)	
			Unboxed	Boxed	Unboxed	Boxed
Butterfly Pendant	TR-BUT-P-A	Ash	Ø680 x 450	620 x 615 x 530	1.1	3.3
	TR-BUT-P-O	Oak				
	TR-BUT-P-W	Walnut				
Butterfly Pendant Giant	-	-	Ø960 x 870	930 x 930 x 940	2.6	9.35
	TR-BUT-P-O-GNT	Oak				
	TR-BUT-P-W-GNT	Walnut				
Materials	Ash 	Oak 	Walnut 	Other materials Birch ply hanging disk 		
Finish	Non-toxic, hard wearing water based varnish - satin					
Wiring kit option : 1	Black ceiling rose and brass bulb holder 	Ceiling kit	Flex		Recommended light bulb	
		Ceiling rose: Ø100mm E27 (240v) / E26 (110v)	Flex colour: black fabric Flex length: 2m (Adjustable)		Max 25W LED	
Wiring kit option : 2	Brushed steel ceiling rose and bulb holder 	Ceiling kit	Flex		Recommended light bulb	
		Ceiling rose: Ø100mm E27 (240v) / E26 (110v)	Flex colour: light grey fabric Flex length: 2m (Adjustable)		Max 25W LED	
Care information	Dusting your light regularly and with a light feather duster should keep your light looking clean, otherwise wipe with a damp cloth and remove any moisture with a dry cloth. Gentle furniture polishes can also be used.					
Additional information	<ul style="list-style-type: none"> This light can be used with your existing E27/E26 pendant fitting. Suitable for use on 240v and 110v circuits. A shade ring adaptor can be fitted so the light can be used on a bayonet (B22) pendant fitting. Installation instructions included. 					