

# HELIX DRUM PENDANT

## Product Specification

# Tom Raffield

Helix Drum Pendant

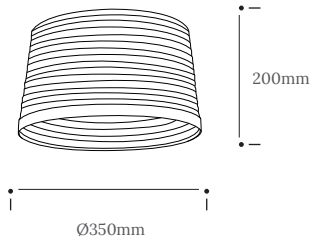

Helix Drum Pendant Large

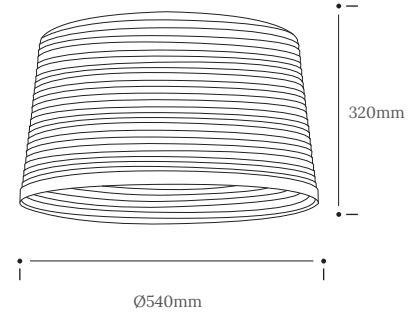





An infinite stretch of wood, skilfully coiled into a sleek curve. Watertight design echoing the hull of its namesake, our Helix Lighting Range makes minimalist look effortless.

With a nod to Scandinavia and a heartbeat from the edge of the Atlantic, this is utilitarian style the Tom Raffield way. Understated. Impactful. Hard working. Through hours of careful wrapping, the Helix drum takes shape.

Sustainably sourced oak or walnut throws wells of light down for focus, while ash diffuses brightness through the grain, for atmosphere.

Highlight. Spotlight. Accentuate, your way.

The Helix Drum Pendant is also available as a floor light.

Product Type : Pendant Light	SKU	Wood types	Dimensions L x W x H (mm)		Weight (kg)	
			Unboxed	Boxed	Unboxed	Boxed
Helix Drum Pendant	TR-HLX-DRM-P-A	Ash	Ø350 x 200	470 x 465 x 325	1.4	3.5
	TR-HLX-DRM-P-O	Oak				
	TR-HLX-DRM-P-W	Walnut				
Helix Drum Large	TR-HLX-DRM-P-A-LRG	Ash	Ø540 x 320	615 x 615 x 390	1.5	5.05
	TR-HLX-DRM-P-O-LRG	Oak				
	TR-HLX-DRM-P-W-LRG	Walnut				
Materials	Ash 	Oak 	Walnut 	Other materials Birch ply hanging disk 		
Finish	Non-toxic, hard wearing water based varnish - satin					
Ceiling kit options	Brushed steel ceiling rose and bulb holder 	Ceiling kit	Flex		Reccomended light bulb	
		Ceiling rose: Ø100mm E27 (240v) / E26 (110v)	Flex colour: clear plastic Flex length: 2m or 4m (Adjustable)		Max 25W LED (not included)	
Care information	Dusting your light regularly and with a light feather duster should keep your light looking clean, otherwise wipe with a damp cloth and remove any moisture with a dry cloth. Gentle furniture polishes can also be used.					
Additional information	<ul style="list-style-type: none"> <li>This light can be used with your existing E27/E26 pendant fitting. Suitable for use on 240v and 110v circuits.</li> <li>A shade ring adaptor can be supplied so the light can be used on a bayonet (B22) pendant fitting.</li> <li>Installation instructions included.</li> </ul>					