

# SKIPPER PENDANT

## Product Specification

Tom Raffield

Skipper Pendant Small

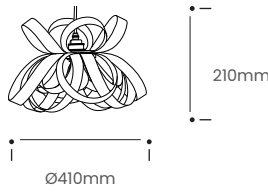

Skipper Pendant

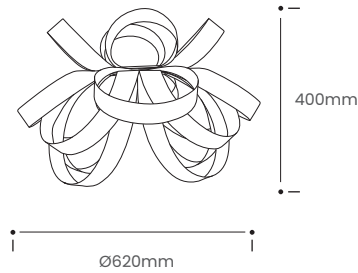

Skipper Pendant Large

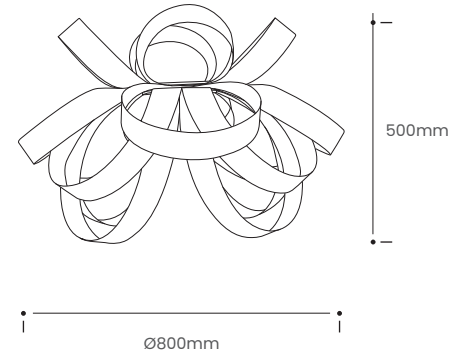





Undulating loops of timber navigate over and around. Where pared back design meets our signature curves, the Skipper Lighting Range leads the charge.

Scandinavian design principles and our sought-after aesthetic, merged. In the Skipper, sustainable ash, oak or walnut is hand-shaped to create an open light that casts out and up, in a bright, bold contrast of light and shadow.

Achieve impact with a lighter touch. Embrace simplicity. Make a statement in your space.

The Skipper Pendant is also available as a floor light.

Product Type : Pendant Light	SKU	Wood types	Dimensions L x W x H (mm)		Weight (kg)	
			Unboxed	Boxed	Unboxed	Boxed
Skipper Pendant Small	TR-SKIP-P-A-SML	Ash	Ø410 x 210	470 x 470 x 330	0.2	1.3
	TR-SKIP-P-O-SML	Oak				
	TR-SKIP-P-W-SML	Walnut				
Skipper Pendant	TR-SKIP-P-A	Ash	Ø620 x 400	615 x 615 x 490	0.6	3.65
	TR-SKIP-P-O	Oak				
	TR-SKIP-P-W	Walnut				
Skipper Pendant Large	TR-SKIP-P-A-LRG	Ash	Ø800 x 500	745 x 745 x 570	1.15	4.8
	TR-SKIP-P-O-LRG	Oak				
	TR-SKIP-P-W-LRG	Walnut				
Materials	Ash 	Oak 	Walnut 	Other materials Birch ply hanging disk 		
Finish	Non-toxic, hard wearing water based varnish - satin					
Wiring kit option : 1	Black ceiling rose and brass bulb holder 	Ceiling kit	Flex		Recommended light bulb	
		Ceiling rose: Ø100mm E27 (240v) / E26 (110v)	Flex colour: black fabric Flex length: 2m (Adjustable)		Max 25W LED	
Wiring kit option : 2	Brushed steel ceiling rose and bulb holder 	Ceiling kit	Flex		Recommended light bulb	
		Ceiling rose: Ø100mm E27 (240v) / E26 (110v)	Flex colour: clear plastic Flex length: 2m (Adjustable)		Max 25W LED	
Care information	Dusting your light regularly and with a light feather duster should keep your light looking clean, otherwise wipe with a damp cloth and remove any moisture with a dry cloth. Gentle furniture polishes can also be used.					
Additional information	<ul style="list-style-type: none"> <li>This light can be used with your existing E27/E26 pendant fitting. Suitable for use on 240v and 110v circuits.</li> <li>A shade ring adaptor can be fitted so the light can be used on a bayonet (B22) pendant fitting.</li> <li>Installation instructions included.</li> </ul>					

Tom Raffield Ltd, F3 Church View Business Park, Bickland Water Rd, Falmouth TR11 4FZ, UK  
tomraffield.com contact@tomraffield.com +44 (0) 1326 722725 #tomraffield @tomraffield

Due to the character of handcrafted natural products, all dimensions are approximate. Wood colour may slightly vary.  
All products, prices and leadtimes are correct at time of print and are subject to change without notice.