

# MOORING FLOOR LIGHT

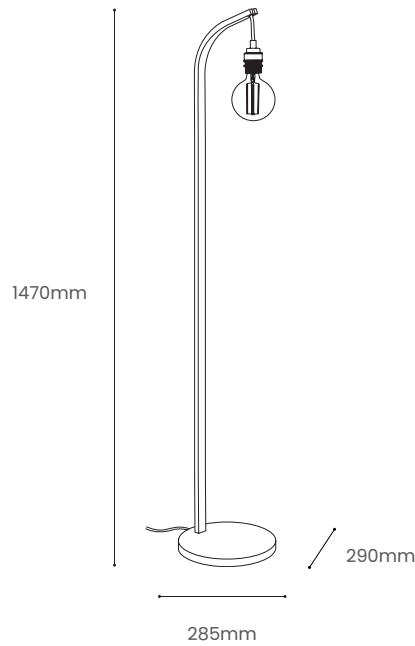





Product Specification

Tom Raffield

Mooring Floor Light



Handcrafted in sustainably sourced solid oak, the Mooring Floor Light's steam bent curve arches from its oak base. A naked bulb haloes out light, bright and striking in the dark, perfectly positioned for illuminating a side table or desk. Use the wooden floor light to create ambience in your living space or accentuate your reading nook. Radiating endless illumination; this minimalist wooden floor light is the ultimate balance between form and function.

Product Type : Floor Light	SKU	Wood types	Dimensions L x W x H (mm)		Weight (kg)	
			Unboxed	Boxed	Unboxed	Boxed
Mooring Floor Light	TR-MRG-FLR-O	Oak	285 x 1470 x 290	315 x 1550 x 315	2.30	7.80
Materials	Oak 	Other materials				
		Brass Brackets 		Birch ply frame 		
Finish	Wooden floor stand - Finished with a blend of natural wax oils to give a protective, hardwearing and beautiful finish. Shade - Non-toxic, hard wearing water based varnish - satin					
Wiring kit options	Brass bulb holder with black inline dimmer switch and plug  	Wiring kit	Flex		Recommended light bulb	
		Plastic inline foot switch E27 (240v)	Flex colour: grey fabric  Cable length: 240cm from switch to bulb holder. 115cm from switch to plug.			Max 25W LED
Care information	Dusting your light regularly and with a light feather duster should keep your light looking clean, otherwise wipe with a damp cloth and remove any moisture with a dry cloth. Gentle furniture polishes can also be used.					
Additional information	<ul style="list-style-type: none"> <li>Suitable for use on 240v circuits.</li> <li>This product can be plugged straight into a 240v outlet.</li> <li>Assembly instructions and fixings included.</li> </ul>					