

SKIPPER FLOOR LIGHT

Product Specification

Tom Raffield

Skipper Floor Light

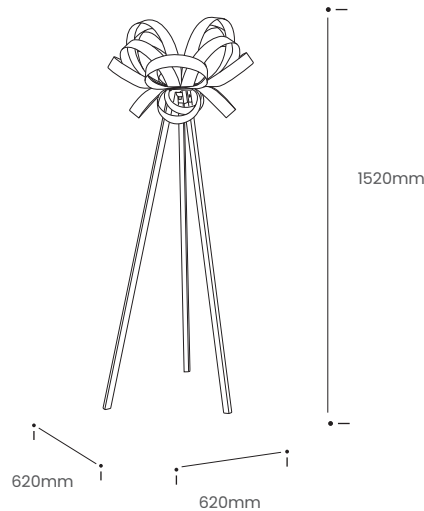







Undulating loops of timber navigate over and around. Where pared back design meets our signature curves, the Skipper Lighting Range leads the charge.

Scandinavian design principles and our sought-after aesthetic, merged. In the Skipper, sustainable ash, oak or walnut is hand-shaped to create an open light that casts out and up, in a bright, bold contrast of light and shadow. Use the Skipper Floor Light to illuminate specific areas, to layer light and create ambiance in your space.

Achieve impact with a lighter touch. Embrace simplicity. Make a statement in your space.

The Skipper is also available as a standard or large pendant light.

Product Type : Floor Light	SKU	Wood types	Dimensions L x W x H (mm)		Weight (kg)	
			Unboxed	Boxed	Unboxed	Boxed
Skipper Floor Light	TR-SKIP-WDFLR-O	Oak	620 x 620 x 1520	Shade 615 x 615 x 490	3.5	7.25
	TR-SKIP-WDFLR-W	Walnut		Stand 1260 x 135 x 135		
Materials	Oak 	Walnut 	Other materials			
			Brass Brackets 	Birch ply mounting disk 		
Finish	Wooden floor stand - Finished with a blend of natural wax oils to give a protective, hardwearing and beautiful finish. Shade - Non-toxic, hard wearing water based varnish - satin					
Wiring kit options	Brass bulb holder with black inline foot switch and plug 	Wiring kit	Flex	Recommended light bulb		
		Plastic inline foot switch	Flex colour: grey fabric 			
		E27 (240v)	Cable length: 240cm from switch to bulb holder. 115cm from switch to plug.	Max 25W LED		
Care information	Dusting your light regularly and with a light feather duster should keep your light looking clean, otherwise wipe with a damp cloth and remove any moisture with a dry cloth. Gentle furniture polishes can also be used.					
Additional information	<ul style="list-style-type: none"> Suitable for use on 240v circuits. This product can be plugged straight into a 240v outlet. Assembly instructions and fixings included. 					