

WHEEL WALL LIGHT

Product Specification

Tom Raffield

Wheal Wall Light

Oak - £175

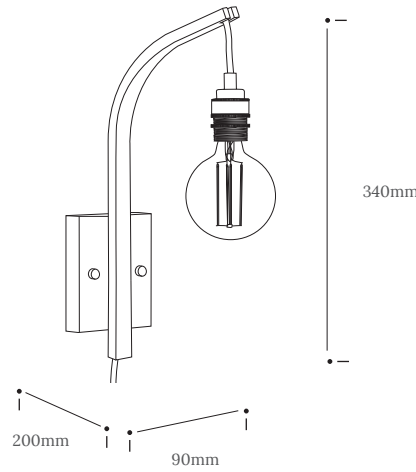







Reflecting metal shines under a suspended filament bulb. Our Wheal Lighting Range blends nature with elegance to put the lustre in illumination.

An arching curve of steam bent oak towers up from a brass base plate. An alluring contrast of wood and metal. Clasped in a polished brass fitting, bright light catches and bounces off its surface. Modern. Refined. Enticing. The Wheal brings sophistication into any space.

Introduce opulence. Amplify.

The Wheal Lighting Range is also available as a table light and a floor light.

Product Type : Wall Light	SKU	Wood types	Dimensions L x W x H (mm)		Weight (kg)	
			Unboxed	Boxed	Unboxed	Boxed
Wheal Wall Light : Hardwired	TR-WHL-WL-O	Oak	90 x 200 x 340	540 x 312 x 165	0.65	1.6
Wheal Wall Light : Plug and switch	TR-WHL-WL-O-PLG	Oak				
Materials	Oak 				Other materials Brass plate 	
Finish	Finished with a blend of natural wax oils to give a protective, hardwearing and beautiful finish.					
Wiring kit option : 1 Hardwired	Brass bulb holder with electrical connection block 	Wiring kit option 1 connection block included E27 (240v)	Flex Flex colour: grey fabric 		Reccomended light bulb Max 25W LED	
Wiring kit option : 2 Plug and switch	Brass bulb holder with black inline switch and plug 	Wiring kit option 2 Plastic inline switch E27 (240v)	Flex Flex colour: grey fabric  Cable length: 228cm from plug to bulb holder		Reccomended light bulb Max 25W LED	
Care information	Dusting your light regularly and with a light feather duster should keep your light looking clean, otherwise wipe with a damp cloth and remove any moisture with a dry cloth. Gentle furniture polishes can also be used.					
Additional information	<ul style="list-style-type: none"> Suitable for use on 240v circuits. Installation instructions and fixings included. This product can be plugged straight into a 240v outlet. If hardwiring into the main supply, this product must be installed by a qualified electrician. 					