

EVOLU[®]
electronics
www.evolu.health

Model: Air Pro

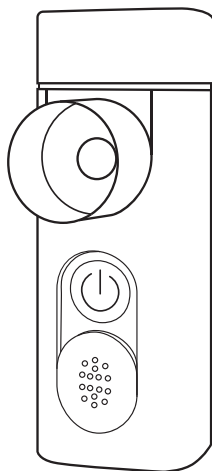

USER MANUAL for PORTABLE MESH NEBULIZER

n a n o
A i R

the best reason to take care of yourself {YES, YOU}

Content

| | |
|--|----|
| 1. Important Safety Notes | 3 |
| 2. Product | 4 |
| 3. Installation and User Instructions | 7 |
| 4. How to use | 8 |
| 5. Cleaning and Disinfection | 10 |
| 6. Storage and Maintenance | 11 |
| 7. Contraindications, Precautions, Notice and Warning | 12 |
| 8. Trouble Shooting Tips | 14 |
| 9. After-sales Service | 14 |
| 10. Symbol Description & Electromagnetic Compatibility | 15 |
| 11. Configuration list | 19 |
| Warranty card | 21 |

Thank you very much for purchasing

EVOLU nano AiR

Nebulizer

- Be sure to read this user manual carefully before using the Unit, so that you can use it safely and correctly.
- Please keep this user manual properly in place for easy reading.
- Illustrations contained in this user manual are schematic.

1. Important Safety Notes

- ▲ For the type, dose, and regimen of the medication, be sure to follow the instructions of a doctor.
- ▲ The use of this product for children and persons with special needs must be carried out under correct guidance and supervision.
- ▲ This unit is only used for specified purposes, only for nebulization. Do not use the device for any other purpose.
- ▲ Clean and disinfect the medication cup and accessories before using or not using the unit for quite a while.
- ▲ Please stop using the device if the components are damaged or fall into the water accidentally.

2. Product

1. **Product Name:** Portable Mesh Nebulizer

2. **Model No.:** Air Pro

3. Working Principle and Mechanism

The portable nebulizer is driven by a rapid oscillation of a circuit, making a piezoelectric ceramic. The working principle of the portable atomizer is driven by the rapid oscillation of the circuit, making the piezoelectric ceramic transducer chip resonant oscillation, which drives the micro-metal mesh rapid oscillation, forces the liquid through the tiny holes ($3\ \mu\text{m}$) in metal mesh, and quickly pops-up the formation of numerous tiny atomized particles through the suction mask or nozzle to guide the patient's respiratory system, in order to achieve the purpose of inhalation therapy. The respiratory system is an open system, so the liquid is atomized into particles, converts into drug fog, the drug can be directly deposited and absorbed in the patient's mouth, throat, trachea, bronchi, alveoli, etc., by its mucous membranes tissues absorption to achieve the purpose of treatment.

4. Specification

| | |
|--|-------------------------------------|
| Power Consumption | <4.0 W |
| Nebulization Rate | 0.15~0.9 ml/min |
| Particalsize | $1\ \mu\text{m}\sim 5\ \mu\text{m}$ |
| Working Frequency | $110\ \text{kHz}\pm 10\ \text{kHz}$ |
| MMAD(Mass median aerodynamic diameter) | $2.5\ \mu\text{m}\pm 30\%$ |
| Fine particle fraction (FPF) | 83,13% |
| Medication Liquid Temperature | $\leq 45\ ^\circ\text{C}$ |

Power Supply

DC 4.8V (Inbuilt lithium battery) or DC5.0V with AC adapter



Product Size

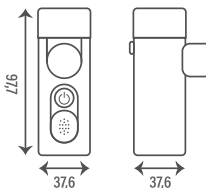

Medication Cup Capacity:

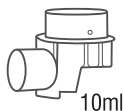

Working Environment



+40°C
-5°C



30%~85%
R.H.



86.0~106.0 kPa

Temperature

Relative Humidity

Atmospheric pressure

Storage/delivery Environment



+ 50°C
-10°C



30%~85%
R.H.



86.0~106.0 kPa

Temperature

Relative Humidity

Atmospheric pressure

Product Weight



100 g

The median particle size in this nebulizer is measured with 0.9% physiological saline under conditions of a temperature of $25 \pm 3^\circ\text{C}$ and a humidity of $60\% \pm 5\%$ R.H. And the equivalent particle size distribution curve of the fog particles measured under these conditions is as follows

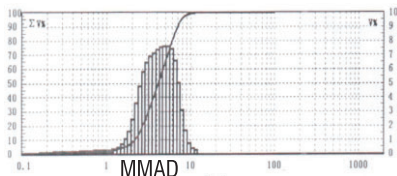

▲ Note: the horizontal axis is the particle size value, the value is logarithmic distribution; The left vertical axis is the cumulative percentage of the volume, corresponding to the rising trend of the curve; The right vertical axis is the volume percentage of a certain section, corresponding to the histogram or undulating.

5. Package contents

▲ Note: Mask and Mouthpiece are available for purchasing separately.

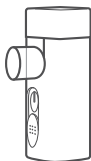

Nebulizer

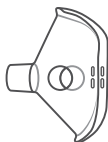

Mask



Mouthpiece



Portable Bag



User Manual



Micro USB Cable

6. Product Contents

- A. Medication Cup Cover
- B. Medication Cup
- C. Spray Connector
- D. Main Unit
- E. ON/OFF Switch
- F. Slide
- G. "PRESS" Button
- H. Micro USB Cable

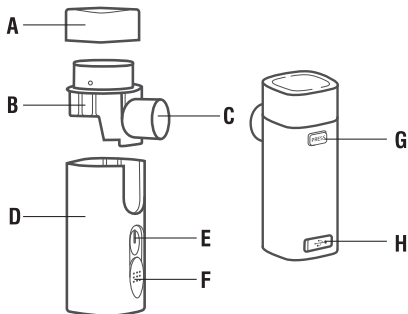

7. Intended User

- For medical institutions and family for atomization. The atomizer for drug inhalation therapy. Applicable to adults, the elderly breathing, infants and children should be use dunder adult supervision.
- The user should also be capable of understanding general operation of AIR Pro and the content of user manual.

3. Installation and User Instructions

Power supply

- 1) The nebulizer has a USB cable for charging, it is not equipped with power adapter, please use an IEC 60601-1 approved AC adapter (output: DC 5.0V 1.0A) for charging.
- 2) The power system of the device is equipped by two rechargeable lithium batteries.
- 3) When the device is running low, please charge it Micro USB cable, then it will be able to work again (as in the figure).
- 4) Battery Charging:
 - a. The battery group can supply power up to 60 minutes continually after full charging.
 - b. When the low battery level is detected, the green indicator flashes.
 - c. Please use the power adapter (DC5.0V, 1A) to charge the batteries for about 1.5 hours.
 - d. The green indicator flashes when charging and keeps lighting when full-charging.

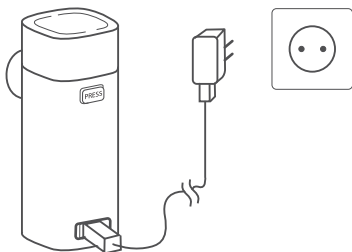

▲ Note:

- 1) Battery has been loaded, do not privately disassemble.
- 2) Rechargeable batteries shall not be replaced by user, only replaced by manufacture.
- 3) Keep charging the device at least once per month during the storage period exceed one month.
- 4) Alkaline lithium-ion or other batteries are not applied to the device.
- 5) Please charge at least 30 minutes before using for the first time.

▲ Warning:

- Please dispose the used batteries according to the local environmental regulation. Do not dispose together with the rubbish to avoid environment pollution.
- Do not dismantle or repair the equipment or components, do not dismantle, replace the battery.

4. How to use

• Add liquid to the medication cup

1. Prepare: Cleaning and disinfecting the components and spray connector, medication cup when use.
2. Inject the liquid: open the medication cover and Inject liquid in to the medication cup, then screw the lip (as the following Figure 1).

▲ Note: Follow the doctor's advice to inject the liquid, do not exceed the maximum capacity of the medication cup, the maximum capacity can be seen on medication cup scale. After injecting the medication, do not open the medication cover, so as not to spill liquid.

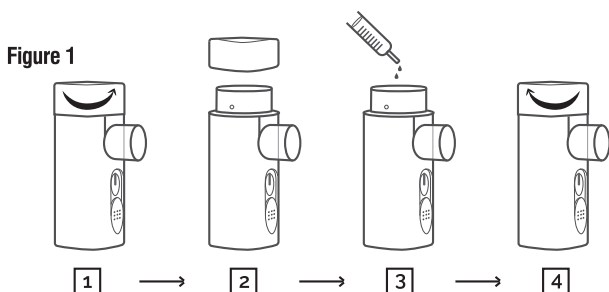

• Nebulization

- 1) Connect mask or mouthpiece, click ON/OFF switch to power on, start nebulization.

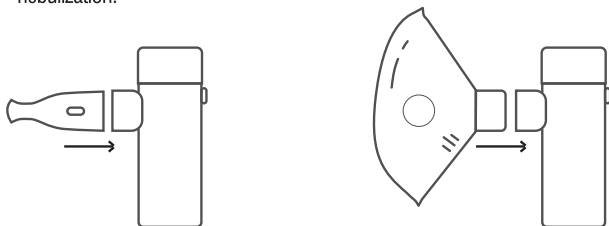

a. Connect the mouthpiece

b. Connect the mask

▲ Note: Clean, disinfect, dry all parts before installation.

- 2) Hold the nebulizer to keep medication contact with the vibrating mesh, using the following three ways of inhalation according to individual needs.



a. direct inhalation



b. by mouthpiece



c. by mask

- 3) When finishing nebulization, press ON/OFF switch to power off. Pour out the residual liquid in the medication cup (see below figures).

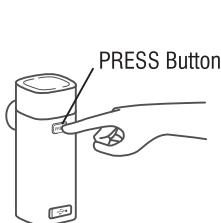

1. Press the button

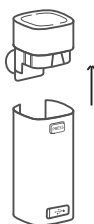

2. Pull up the medication cup

- 4) The nebulizer can set the working time to 10 minutes, and it will shut down automatically after 10 minutes. If you need to continue to use, press the ON / OFF switch. Please make sure there is enough liquid in the medication cup.
- 5) Use clear water to clean the medication cup, Spray Connector, medication cup cover, and accessories, and then disinfect.

▲ Note:

- 1) Hold nebulizer to keep the liquid and nebulization mesh disc in full contact. slight swing does not affect the use but do not shake the equipment in the process of nebulization.
- 2) Receiving treatment according to the doctors' recommendation. Keep quiet and relaxed in the course of treatment.
- 3) If you need to replace the suction method, you need to replace the mask, mouthpiece, Please clean the spray interface section after each use (see "Cleaning and Disinfection").

- 4) Liquid will be coagulated around the spray connector and mesh disc, which will affect the nebulization effect after nebulization. It should stop nebulization, remove the mask, mouthpiece and other accessories. Then use a clean medical gauze to wipe the residue. Do not touch the mesh disc center spray area to prevent damage to the mesh disc.

5. Cleaning and Disinfection

After use, the medication cup, mouthpiece, mask and other components should be cleaned and disinfected as below:

1. Cleaning

Please cut off the power before cleaning.

- 1) Remove the components from the device: medication cup, medication cover, mouthpiece, mask etc.
- 2) Clean them with not more than 40 °C warm pure water for about 5 minutes.
- 3) Please use the clean medical gauze to dry the accessories after cleaning;
- 4) Please wipe the main unit. Please wipe dirt and residue if any at the electrode connection with clean medical gauze and put it dry in the air; place
- 5) Please store the device and accessories in dry ventilated place in case of contamination.

▲ Note:

- Please avoid cleaning the main unit in water in case water entering;
- Please keep the main unit and accessories dry and clean for the following safe use;
- Please avoid using distilled water or multiple filtering water to start nebulation.

2. Disinfection

Medication cup, Spray Connector, medication cup cover, mask, mouthpiece etc should be disinfected after use. Methods are as below:

- 1) Put medication cup, medication cover, mask, mouthpiece and other parts into 40 °C maximum water or medical disinfectants or distilled water for daily disinfection.
- 2) Put all parts into 40° C maximum water/medical disinfectant for 30 minutes and add non-toxic cleaners to warm water at temperatures not exceeding 40 °C and rinse the parts.
- 3) Final, wipe the water with a clean medical gauze.
- 4) Remove all surfaces: mask and nozzle, wipe the surface with 75% medical alcohol, than dry thoroughly.

▲ Note:

- Please avoid cleaning the main unit in water in case water entering;
- Please keep the main unit and accessories dry and clean for the following safe use;

6. Storage and Maintenance



+50°C
-10°C

**Environment
temperature**



30%~85%
R.H.

**Relative
Humidity**



86.0~106.0 kPa

**Atmospheric
pressure**

1. Nebulizer Storage

- 1) Storage conditions others: Non-corrosive gas, good ventilation, avoid high temperature, humidity and direct sunlight.
- 2) Storage instructions:
 - a. The device is valid for 5 years in the above mentioned storage condition.
 - b. The nebulizer should be promptly cleaned and disinfected after use, the medication cup and other accessories should store into the packing box after completely drying. Stored in the required environmental condition, avoiding impact.



+40°C
-5°C

**Environment
temperature**



30%~85%
R.H.

**Relative
Humidity**



86.0~106.0 kPa

**Atmospheric
pressure**

2. Nebulizer Maintenance

- 1) Normal working conditions Power: DC 4.8V (Inbuilt lithium battery) or DC5.0V with AC adapter (purchased by user, technical specification please refer to Chapter 2 for details).
- 2) Maintenance Instructions:
 - a. Please use nebulizer under normal conditions.
 - b. Do not use the nebulizer near the heating device or open flame. Do not use a microwave oven, fan and other dry nebulizer and accessories.
 - c. Do not expose the nebulizer and accessories to corrosive liquids and gases.
 - d. Do not wrap the power cord around the unit.
 - e. When using a nebulizer, if any irregularities are encountered, seek a solution in accordance with Chapter 8. If the nebulizer still does not work properly, please contact our distributor.



7. Contraindications, Precautions, Notice and Warning

1. Contraindications



- 1) This product is not suitable for Pentamidine drugs.
- 2) Pulmonary edema patients are prohibited to use.
- 3) Acute asthma and acute pulmonary infarction episodes are prohibited to use.

2. Notice and suggestion

| | |
|---|---|
| <ul style="list-style-type: none"> • The nebulizer is a medical device and is intended for human use only. Please follow the instructions in the manual or under the guidance of a doctor, infants and young children and special care crowd should be used under the supervision of the guardian. |  |
| <ul style="list-style-type: none"> • Please use original parts and accessories. Warranty service is not provided for damage caused by accessory beyond our list and damaged by the user's personal causes. | |
| <ul style="list-style-type: none"> • Please refer to the "Troubleshooting" section when there are problems or contact the distributor for maintenance. Do not attempt to repair the equipment personally. | |
| <ul style="list-style-type: none"> • Please clean and disinfect the unit after use, refer to the "Cleaning and Disinfection" chapter. | |
| <ul style="list-style-type: none"> • The nebulizer is for medication atomization. | |
| <ul style="list-style-type: none"> • Please do not place or move the device when there is liquid inside medication cup. | |
| <ul style="list-style-type: none"> • Please confirm all the accessories are intact before use it. | |
| <ul style="list-style-type: none"> • The nozzle is disposable accessory, only for single person using to avoid cross-infection. | |
| <ul style="list-style-type: none"> • Try to keep the liquid fully reach the mesh disc when use. | |
| <ul style="list-style-type: none"> • Don't use the device at shower room. | |
| <ul style="list-style-type: none"> • Do not use the unit near flammable gas atmospheres or near oxygen and anesthetic mixtures. | |
| <ul style="list-style-type: none"> • The device is expected to be used in radioactive radiation controlled electromagnetic environment, as far as possible away from the source of hazard. | |
| <ul style="list-style-type: none"> • Do not use the device in a high temperature environment, or it may cause trouble and fire. | |
| <ul style="list-style-type: none"> • Keep the device and parts away from strong vibrations, such as impact. | |

| | |
|--|---|
| <ul style="list-style-type: none"> • Please do not use liquid which contains esters, oil or suspended particles, including herbal extract. |  |
| <ul style="list-style-type: none"> • Do not wash the whole unit with running water to avoid water come inside the device, especially the USB connector. | |
| <ul style="list-style-type: none"> • Do not use the microwave ovens to dry or disinfect the unit, it may cause fire. | |
| <ul style="list-style-type: none"> • Please keep away from the reach of children, infants and psychotic patients. | |
| <ul style="list-style-type: none"> • Please use qualified manufacturers of lithium battery power charger (output 5.0V/1.0A). | |
| <ul style="list-style-type: none"> • Do not touch the center of spray mesh by hand or other sharp objects. May cause damage, and can not be used. | |
| <ul style="list-style-type: none"> • The nebulizer does not have moisture and dust protective functions, so the product should not be stored in a wet or dusty environment. | |
| <ul style="list-style-type: none"> • Do not drop and avoid strong impact on the device, medication cup, it may cause damage and malfunction of the nebulizer. | |
| <ul style="list-style-type: none"> • Do not disassemble, repair or modify the device, it may cause electric shock, leakage and fire. |  |
| <ul style="list-style-type: none"> • Dispose the wasted device and accessories in accordance with local regulations. Illegal disposal may pollute environment. | |

3. Warning

| | |
|--|---|
| <ul style="list-style-type: none"> • Please refer to the doctor before use the device if you have diabetes or other illnesses. |  |
| <ul style="list-style-type: none"> • Use and purchase of the device should be advised by a doctor. Please refer to the doctor's advisements regarding the medication type, dosing and way of use. | |
| <ul style="list-style-type: none"> • Please stop using the device if you feel uncomfortable and seek medical advice. | |
| <ul style="list-style-type: none"> • Volatile oil are not allowed, may cause damage to module. | |
| <ul style="list-style-type: none"> • Water-soluble medication and saline dilutions medication are allowed to nebulization, but may cause bronchospasm. | |
| <ul style="list-style-type: none"> • Oily medication are not allowed. | |
| <ul style="list-style-type: none"> • The device is not intended for atomization anesthetic agents in respiratory system. |  |
| <ul style="list-style-type: none"> • Do not spill liquid to the device to avoid leakage, the possibility of electric shock and cause malfunction, failure to use. | |

8. Trouble shooting tips

Trouble shooting for nebulizer

| | TROUBLE | POSSIBLE CAUSE/SOLUTION |
|---|---|--|
| 1 | Dose not work when turn on | 1) Check the nebulizer if there is electricity. 2) Check if the medication cup been full filled. |
| 2 | Low nebulization | 1) Check if the medication cup been filled with the right medication, which should be water-solubility, non-corrosive medication. 2) Tilt the unit, so that the medication in contact with the spray mesh. 3) Check whether the amount of the liquid is too enough. 4) The spray mesh maybe blocked, you can drop 2 or 3 drops of white vinegar into the medication cup with 3-6 ml of water, then fully nebulize. Clean the medication cup for disinfection for next nebulization. |
| 3 | What medication is more suitable for nebulization | 1) Consult your doctor for advice. 2) Only doctors can advise the users what drug are used for treatment. 3) Don't use over sticky medication. |
| 4 | Some medication residual | It is a normal sign, if there is some strange noises or the unit shut off due to insufficient medication, please stop nebulization. |
| 5 | Special care for children's | 1) Please choose a child mask to cover mouth and nose for better effect. NOTE: Children should be helped and watched by an adult when using the device. Keep it away from the children when not in use. |

9. After-sales service

- The device is warranted to be free from defects materials and workmanship appearing within 2 year from the date of purchase, when used in accordance with the instructions provided with the device. We will repair or replace at our discretion without extra charge. On the any repair service out of the scope of warranty will be charged accordingly.
- Please contact our distributor to obtain warranty service.

Others, please refer to the user manual

The company reserves the right of final interpretation of the warranty card, which may be subject to change without prior notice

10. Symbol description & Electromagnetic compatibility

1. Signs and symbols



Refer to instruction manual



Separate collection for electrical and electronic equipment



General imperative



No toxic and harmful substances and elements



Keep away from sunlight/heat

IP22

Solid particle protection and Waterproof Grade



Upward



Fragile, handle with care



Keep dry



The application part of Type BF



Note, Warning refer to enclosed file



Representative in the European Community



Do not disassemble



Manufacturer



Product batch number tab



Date of manufacture



CE identification + Notified Body number



Product serial number tag



Prohibition (absolute prohibition)



LF electromagnetic radiation



Be careful of electric shock



Precautions

2. Electromagnetic compatibility

1) EMC information.

| Guidance and Manufacturer's declaration – electromagnetic emissions | | |
|--|------------|--|
| <p>This device is intended for use in the electromagnetic environment specified below. The customer or the user of the device should assure that it is used in such environment.</p> | | |
| Electromagnetic emission IEC 60601-1-2 | | |
| Emissions | Compliance | Electromagnetic environment-guidance. |
| RF emissions GB 4824 | Group 1 | This device uses RF energy only for its internal function. Therefore, its RF emissions are very low and are not likely to cause any interference in nearby electronic equipment. |
| RF emissions CISPR 11 | Class B | This device is suitable for use in all establishments, including domestic establishments and those directly connected to the public low-voltage power supply network that supplies buildings used for domestic purposes. |
| Harmonic emissions IEC 61000-3-2 | Class A | |
| Voltage fluctuations/ flicker emissions IEC 61000-3-3 | Compliance | |

| Guidance and Manufacturer's declaration – electromagnetic immunity | | | |
|--|--|---|---|
| <p>The device is intended for use in the electromagnetic environment specified below. The customer or the user of the device should assure that it is used in such an environment.</p> | | | |
| Immunity test | IEC 60601 test level | Compliance level | Electromagnetic environment-guidance. |
| Electro-static discharge (ESD) IEC 61000-4-2 | ± 6 kV contact ± 8 kV air | ± 6 kV contact ± 8 kV air | Floors should be wood, concrete or ceramic tile. If floors are covered with synthetic material, the relative humidity should be at least 30%. |
| Electrical fast transient/burst IEC 61000-4-4 | ± 2 kV for power supply lines ± 1 kV for input/output lines | ± 2 kV for power supply lines*1) | Mains power quality should be that of a typical commercial or hospital environment. |
| Surge IEC 61000-4-5 | ± 1 kV line to line ± 2 kV line to earth | ± 1 kV line to line ± 2 kV line to earth | Mains power quality should be that of a typical commercial or hospital environment. |

| | | | |
|---|--|--|---|
| Voltage dips, short interruptions and voltage variations on power supply IEC 61000-4-11 | <5 % UT(>95 % dip in UT) for 0.5 cycle | <5 % UT(>95 % dip in UT) for 0.5 cycle | Mains power quality should be that of a typical commercial and/or hospital environment. If the user of this device requires continued operation during power mains interruptions, it is recommended that the device be powered from an uninterruptible power supply or battery. |
| | 40 % UT(60 % dip in UT) for 5 cycles | 40 % UT(60 % dip in UT) for 5 cycles | |
| | 70 % UT(30 % dip in UT) for 25 cycles | 70 % UT(30 % dip in UT) for 25 cycles | |
| | <5 % UT(>95 % dip in UT) for 5 sec | <5 % UT(>95 % dip in UT) for 5 sec | |
| Power frequency (50/60 Hz) magnetic field IEC 61000-4-8 | 3A/m | 3A/m | Power frequency magnetic fields should be at levels characteristic of a typical location in a typical commercial or hospital environment. |
| Conducted RF IEC 61000-4-6 | 3V rms 15KHz to 80 MHz | 3V/m | <p>Portable and mobile RF communications equipment should be used no closer to any part of this device, including cables, than the recommended separation distance calculated from the equation applicable to the frequency of the transmitter. Recommended separation distance</p> $d=1.2\sqrt{P}$ $d=1.2\sqrt{P}$ <p>80 MHz to 800 MHz</p> $d=2.3\sqrt{P}$ <p>800 MHz to 2,5 GHz</p> <p>where P is the maximum output power rating of the transmitter in watts (W) according to the transmitter manufacturer and d is the recommended separation distance in meters (m). Field strengths from fixed RF transmitters, as determined by an electromagnetic site survey,*2) should be less than the compliance level in each frequency range.*3) Interference may occur in the vicinity of equipment marked with the following symbol: </p> |
| Radiated RF IEC 61000-4-3 | 3V/m 80MHz to 2.5GHz | 3V/m | |

NOTE 1: At 80 MHz and 800 MHz, the higher frequency range applies.

NOTE 2: These guidelines may not apply in all situations. Electromagnetic propagation is affected by absorption and reflection from structures, objects and people.

1. Field strengths from fixed transmitters, such as base stations for radio (cellular/cordless) telephones and land mobile radios, amateur radio, AM and FM radio broadcast and TV broadcast cannot be predicted theoretically with accuracy. To assess the electromagnetic environment due to fixed RF transmitters, an electromagnetic site survey should be considered. If the measured field strength in the location in which the device is used exceeds the applicable RF compliance level above, the device should be observed to verify normal operation. If abnormal performance is observed, additional measures may be necessary, such as reorienting or relocating this device.
2. Over the frequency range 150 kHz to 80 MHz, field strengths should be less than 3 V/m.

Recommended separation distances between portable and mobile RF communications equipment and the device.

The device is intended for use in an electromagnetic environment in which radiated RF disturbances are controlled. The customer or the user of the device can help prevent electromagnetic interference by maintaining a minimum distance between portable and mobile RF communications equipment (transmitters) and the device as recommended below, according to the maximum output power of the communications equipment.

| maximum output power rate of transmitters (w) | separation distance according to frequency of transmitter | | |
|---|---|--------------------------------------|--------------------------------------|
| | 150 kHz to 80 MHz $d=1.2$ | 80 MHz to 800 MHz $d=1.2\sqrt{P}$ | 800 MHz to 2,5 GHz $d=23\sqrt{P}$ |
| 0.01 | 0.12 | 0.12 | 0.23 |
| 0.1 | 0.38 | 0.38 | 0.73 |
| 1 | 1.2 | 1.2 | 2.3 |
| 10 | 3.8 | 3.8 | 7.3 |
| 100 | 12 | 12 | 23 |

For transmitters rated at a maximum output power not listed above, the recommended separation distance in meters (m) can be estimated using the equation applicable to the frequency of the transmitter, where P is the maximum output power rating of the transmitter in watts (W) according to the transmitter manufacturer.

Precautions

- 1) In order to regulate the requirements for EMC with the aim to prevent unsafe product situations, the EN60601-1-2 standard has been implemented. The nebulizer Air Pro conforms to the EN60601-1-2:2007 standard for both immunity and emissions.
- 2) Portable and mobile RF communication equipment may affect the performance of the nebulizer, avoid strong electromagnetic interference when using, such as close to mobile phones, microwave ovens and so on.

Warning

- 1) Equipment or systems should not be used or stacked with other equipment. If they must be close to or stacked use, it should be observed that the verification in its use of the configuration can be normal operation.
- 2) It is not recommended to use spare parts, cables or other accessories of another manufacturer, which may result in deterioration of the device operation or its breakage.

11. Configuration list

| Item | Quantity | If Included | |
|---------------------------|----------|-------------------------------------|--------------------------|
| | | Yes | No |
| Main Unit | 1 | <input checked="" type="checkbox"/> | <input type="checkbox"/> |
| Medication cup | 1 | <input checked="" type="checkbox"/> | <input type="checkbox"/> |
| Adult mask | 1 | <input checked="" type="checkbox"/> | <input type="checkbox"/> |
| Child mask | 1 | <input checked="" type="checkbox"/> | <input type="checkbox"/> |
| Mouthpiece | 1 | <input checked="" type="checkbox"/> | <input type="checkbox"/> |
| User manual | 1 | <input checked="" type="checkbox"/> | <input type="checkbox"/> |
| Warranty card | 1 | <input checked="" type="checkbox"/> | <input type="checkbox"/> |
| Certificate of inspection | 1 | <input checked="" type="checkbox"/> | <input type="checkbox"/> |
| User Guidance | 1 | <input checked="" type="checkbox"/> | <input type="checkbox"/> |
| Velvet bag | 1 | <input checked="" type="checkbox"/> | <input type="checkbox"/> |
| Micro USB cable | 1 | <input checked="" type="checkbox"/> | <input type="checkbox"/> |
| Warning badge | 1 | <input checked="" type="checkbox"/> | <input type="checkbox"/> |
| Warning board | 1 | <input checked="" type="checkbox"/> | <input type="checkbox"/> |

EVOLU is a trademark of FORANS International AG, Switzerland 

 Feellife Health Inc., Room 1903, Building A, No.9 Furong Road, Tantou Community, Songgang Subdistrict, Bao'an District, Shenzhen, 518104, Guangdong, China, Tel: +0086-755-2699 3192

Distributor: FORANS SIA, "Piepilsētas", Krustkalni, Ķekavas nov., LV-2111, Latvija, tel.: +371 67462367

Service life: 5 years



compact portable device
ideal for home

stamp

warranty card

Type of product: _____ Serial No: _____

Name of customer: _____ Date of purchase: _____

Contact number: _____

Address: _____

Sale company: _____ Contact number: _____

Address of sales company: _____



stamp

warranty card

Type of product: _____ Serial No: _____

Name of customer: _____ Date of purchase: _____

Contact number: _____

Address: _____

Sale company: _____ Contact number: _____

Address of sales company: _____

- The period of host free for maintain service is 2 years. Medication cup is 6 month.
- During the warranty period, we will decide to repair or replace damaged parts or accessories according to the case.
- The accessories (mask, nozzle) does not come in the warranty category since it is consumable item, details please refer to the manual.

The following case does not include the warranty.

- Damage cause by human behaviours, holding, touching, soaking and wetting.
- Damage cause by not correctly operating the product according to the manual.
- Damage cause by accident.
- The user disassemble and change the product without authorization.
- No invoice, warranty card, the product serial being torn or can not identify.

Attantion: please contact our distributor when the device needs maintenance. Please keep the packing of product so that it could be used when return the device to maintenance.



- The period of host free for maintain service is 2 years. Medication cup is 6 month.
- During the warranty period, we will decide to repair or replace damaged parts or accessories according to the case.
- The accessories (mask, nozzle) does not come in the warranty category since it is consumable item, details please refer to the manual.

The following case does not include the warranty.

- Damage cause by human behaviours, holding, touching, soaking and wetting.
- Damage cause by not correctly operating the product according to the manual.
- Damage cause by accident.
- The user disassemble and change the product without authorization.
- No invoice, warranty card, the product serial being torn or can not identify.

Attantion: please contact our distributor when the device needs maintenance. Please keep the packing of product so that it could be used when return the device to maintenance.

CERTIFICATE OF INSPECTION

Feellife Health Inc.

Product: Portable mesh nebulizer

Model: Air Pro

Inspection date:

Inspector:

CE 0197



Lotus NL B.V.

Koningin Julianaplein 10, 1e Verd, 2595AA, The Hague, Netherlands.

feel better A hand-drawn graphic consisting of a heart shape followed by three small dots, all in a simple, sketchy style.