

**EVOLU**<sup>®</sup>  
electronics

[www.evolu.health](http://www.evolu.health)

Model: Air Mask II

**GB** User manual  
**DE** Bedienungsanleitung  
**RU** Инструкция по применению

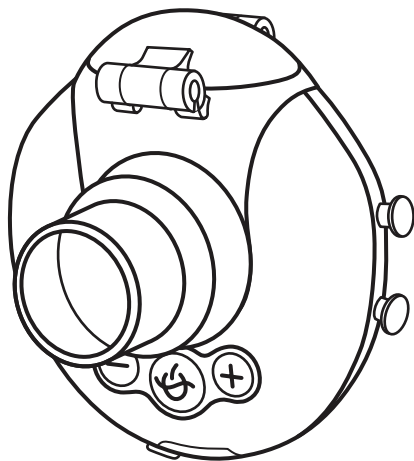

USER MANUAL  
PORTABLE MESH  
NEBULIZER

n a n o

**A i R**  
**M I N I**

the best reason to take care of yourself

{YES, YOU}

## Content

1. Important Safety Notes .....	3
2. Product Description .....	4
3. Installation Instructions .....	6
4. Use Instructions .....	7
5. Cleaning and Disinfection Method .....	10
6. Storage and Maintenance .....	11
7. Contraindications, Precautions, Notices and Warnings. ....	12
8. Trouble Shooting Tips .....	14
9. Disposal .....	15
10. After-sales Service. ....	15
11. Symbol description & Electromagnetic compatibility .....	16
12. Configuration list .....	21
13. Warranty Card .....	22
14. Manufacturer information .....	24

# Thank you very much for purchasing EVOLU Portable Mesh Nebulizer Nano AiR MINI

- In order to make sure that this product can be used correctly, please read this manual carefully before use.
- Please keep this manual in a convenient place for easy access.
- Illustrations contained in this user manual are schematic.

## 1. Important Safety Notes

- ▲ Before use, ensure that there is no visible damage to the device or accessories. In case of any doubt, do not use the device and contact your retailer or the specified Customer Service address.
- ▲ Do not use health products or medicines containing essential oils for nebulization.
- ▲ You should always follow the instructions of your doctor regarding the type of medication to use, the dosage, and the frequency and duration of inhalation. Only use medication prescribed or recommended by your doctor or pharmacist.
- ▲ The use of this product for children and persons with special needs must be carried out under correct guidance and supervision.
- ▲ This unit is only used for specified purposes, only for nebulization. Do not use the device for any other purpose.
- ▲ Clean and disinfect the medication cup and accessories before using or not using the unit for quite a while.
- ▲ Please stop using the device if the components are damaged or fall into the water accidentally.
- ▲ Keep the device away from your eyes when it is in use, as the nebulised medication could be harmful.
- ▲ Keep packaging material away from children (risk of suffocation).
- ▲ Do not use any additional parts that are not recommended by the manufacturer.
- ▲ If any serious incident that has occurred in relation to the device, please report to the manufacturer or the distributor immediately.

## 2. Product Description

**2.1. Product Name:** EVOLU Portable Mesh Nebulizer Nano AIR MINI.

**2.2. Model:** Air Mask II

### 2.3. Working Principle and Mechanism

The working principle of the product is driven by the rapid oscillation of the circuit, making the piezoelectric ceramic transducer chip resonant oscillation, which drives the micro-metal mesh rapid oscillation, the liquid through the metal mesh on the tiny mesh and is quickly pop-up, the formation of numerous tiny atomized particles, through the mask or mouthpiece to guide the patient's respiratory system, in order to achieve the purpose of inhalation therapy. Respiratory system is an open system, the liquid is atomized into particles, the patient inhalation of these drug fog, the drug can be directly adsorbed deposited in the patient's mouth, throat, trachea, bronchi, alveoli, etc., by its mucous membrane tissue absorption to achieve the purpose of treatment.

### 2.4. Applicable scope and intended user

The device is a mesh nebulizer designed aerosolize liquid medication for inhalation therapy in professional healthcare environment and in home healthcare environment. Suitable for pediatric and adult patient. Infants, children and compromised individuals should be used under adult supervision.

### 2.5. Specification

**Power Supply:** DC 3.7 V (Li-ion Battery) or DC 5.0 V/1.0 A IEC 60601-1 with AC adapter.

**Power consumption:** < 4.0 W

**Nebulization Rate:** 0.15 ml/min ~ 0.90 ml/min

**Particle Size:** MMAD < 5 $\mu$ m

**Working Frequency:** 130 kHz  $\pm$  10 kHz

**Medication Cup Capacity:** 6 ml (Max)

**Product Size/Weight:** 72.5 mm (L)  $\times$  67.5 mm (W)  $\times$  50.5 mm (H) / 72 g

**Working Environment:**

Temperature: +5 $^{\circ}$ C ~ +40 $^{\circ}$ C

Relative Humidity:  $\leq$  80% R.H.

Non-condensing state

Atmospheric pressure:

86.0 ~ 106.0 kPa

**Storage/Delivery Environment:**

Temperature: -20 $^{\circ}$ C ~ +55 $^{\circ}$ C,

Relative Humidity:  $\leq$  80% R.H.

Non-condensing state,

Atmospheric pressure:

86.0 ~ 106.0 kPa

The median particle size in this nebulizer is measured with 0.9% physiological saline under conditions of a temperature of 25 $^{\circ}$ C and a humidity of 59% R.H. The equivalent particle size distribution curve of the fog particles measured under these conditions is as follows:

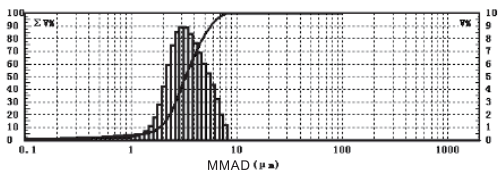

**▲ Note:** The horizontal axis is the particle size value, the value is logarithmic distribution;

The left vertical axis is the cumulative percentage of the volume, corresponding to the rising trend of the curve;

The right vertical axis is the volume percentage of a certain section, corresponding to the histogram or undulating;

## 2.6. Product Composition

Nebulizer nano AIR MINI is composed mainly by the main unit and medication cup, spray nozzle and micro USB cable.

## 2.7. Product Contents

- |                     |                          |                      |
|---------------------|--------------------------|----------------------|
| 1. Medication Cover | 5. Main Unit             | 9. Adult Mask (PVC)  |
| 2. Medication cup   | 6. Power Switch          | 10. Child Mask (PVC) |
| 3. Spray Nozzle     | 7. Electrode Contact pin | 11. Mouthpiece (PP)  |
| 4. Mesh Diaphragm   | 8. USB Charging Port     | 12. Headband         |

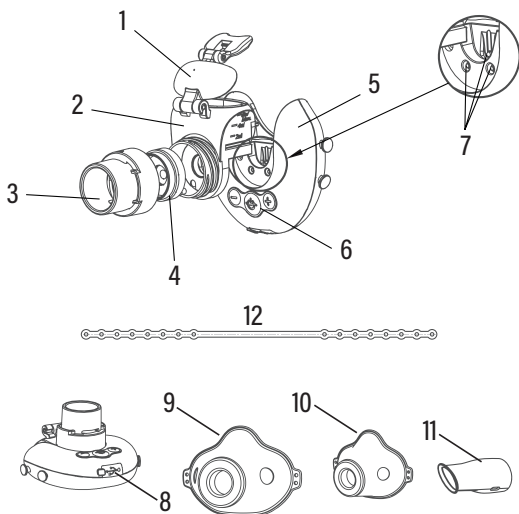

Schematic diagram of host structure

### 3. Installation Instructions

- 3.1. Remove all packings, then remove the unit and accessories.
- 3.2. Install the assembled bottle on the main body. When you install it, you should hear the crisp clasp sound (as shown in the schematic diagram of the installation of the liquid bottle).
- 3.3. Install the suction mask and the nozzle as shown in the schematic.

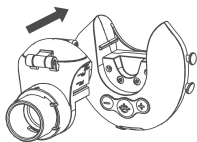

Please be sure to install it in place.  
Connect the medication cup.

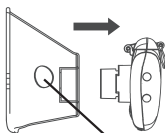

Air intake

Connect the mask

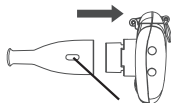

Air intake

Connect the mouth-piece

**▲ Note:** Clean, disinfect, dry all parts before installation.

#### 3.4. Power Supply

- 1) The nebulizer has a USB cable for charging, it is without power adapter, please use an IEC 60601-1 approved AC adapter (output: DC 5.0 V, 1.0 A) for charging.
- 2) The power system of the device is equipped with one rechargeable lithium battery.
- 3) When the device is running low, please charge it using Micro USB cable, then it will be able to work again.

**▲ Note:** Before charging, please make sure the socket connected is normally charged.

**▲ Note:** This device has independent charging. Please do not charge with any other electronic equipment.

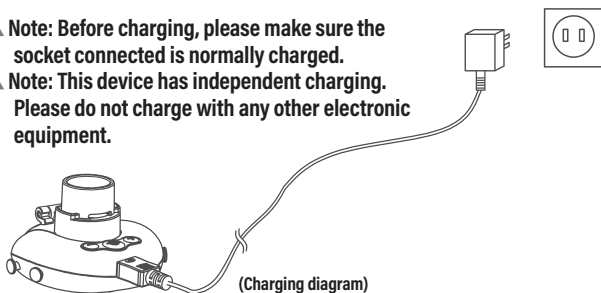

#### 4) Battery Charging

- a. The battery group can supply power up to 60 minutes continually after full charging.

- b. When the low battery level is detected, the blue indicator flashes for 5 times and then turns off.
- c. Please use the power adapter (DC 5.0 V, 1 A) to charge the batteries for about 2 hours.
- d. The blue indicator flashes when charging and keeps lighting when full-charging.

### **▲ Note:**

- 1) Battery has been loaded, do not privately disassemble.
- 2) Rechargeable batteries shall not be replaced by user, only replaced by manufacturer.
- 3) Keep charging the device at least once per month during the storage period exceed one month.
- 4) Alkaline, lithium-ion or other batteries are not applied to the device.
- 5) Please charge at least 30 minutes before using for the first time.
- 6) In order to achieve as long a battery service life as possible, fully charge the battery at least once a month.

### **▲ Warning:**

- Please dispose the used batteries according to the local environmental regulation. Do not dispose together with the rubbish to avoid environment pollution.
- Do not dismantle or repair the equipment or components, do not dismantle, replace the battery.
- If you need to replace the battery, please contact the distributor.
- If your skin or eyes come into contact with fluid from a rechargeable battery cell, flush out the affected areas with water and seek medical assistance.
- Choking hazard! Small children may swallow and choke on batteries. Store batteries out of the reach of small children.
- Risk of explosion! Never throw batteries into a fire.
- Do not disassemble, split or crush the batteries.
- Only use chargers as specified in the instructions for use.
- Batteries must be charged correctly prior to use. The instructions from the manufacturer and the specifications regarding correct charging given in these instructions must be observed at all times.

## **4. Use Instructions**

### **4.1. Indicator description form**

Green light keeps on (uniform nebulization mode):	Working
Green light flashes (micro-wave mode):	
Green light flashes 3 times:	Long press for 3 seconds to switch the atomization mode
Blue light flashes 5 times:	Battery low, shut down
Orange light flashes 10 times:	Without medicine and shut down
Blue light flashes:	Charging
Blue light keeps on:	Full charged
Green light flashes 10 times:	10 minutes set time

▲ **Note:** There is enough liquid, but the orange light flashes 10 times, during orange light flashing, please press switch key once to continue work.

**4.2. Prepare:** Cleaning and disinfecting the components, spray nozzle and medication cup before using.

**4.3. Inject the liquid:** open the cap, inject the solution and cover the cap clockwise.



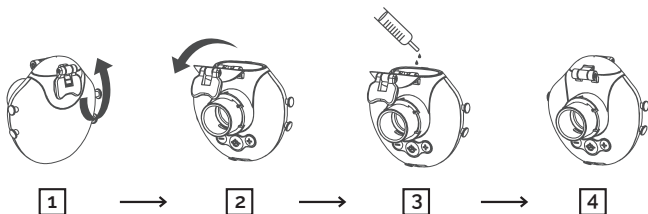

▲ **Note:** Please add the liquid before turning on the device.



▲ **Note:** Leakage protection! When pouring medication into the medication container, ensure that you only fill it up to the maximum mark (6 ml). The recommended filling quantity is between 2 and 6ml. Nebulisation only occurs while the substance to be nebulised is in contact with the mesh. If this is not the case, nebulisation stops automatically. So please try to hold the device as vertically as possible.



## 4.4. Nebulization

- 1) Connect mask or mouthpiece, press  power button to turn on, start nebulization.
- 2) It starts with a medium spray rate, and the spray rate can be adjusted by pressing  &  as needed.
- 3) This device has a Micro-wave mode in which the spray rate is changed automatically from max to mini rate or converse in 6 seconds. After switching to the micro-wave mode, long press  button for 3s (when the green light flashes 3 times) to switch to the uniform nebulization mode.
- 4) Boot before atomization, please shake slight level, make solution to fully contact with atomization, using the following three ways of inhalation according to individual needs.





a. direct inhalation



b. by mask



c. by mouthpiece

- 5) Slowly taking a deep breath and then breathing in drugs.
- 6) The nebulizer will shut down automatically after 10 minutes. If you need to continue to use, press the Power Button . Please make sure there is enough liquid in the medication cup.
- 7) After nebulization, press the Power Button  to turn off the nebulization. Pour out the trace of residual liquid from the medication cups and do not reuse it. (disassembly like showed below).

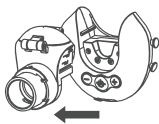

a. Remove the liquid cup horizontally



b. Pour out the liquid



c. Rotate the spray nozzle counter clockwise

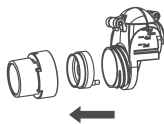

d. Take out the mesh diaphragm

- 8) Use purified water to clean the medication cup, spray assembly, lid, thread assemblies and accessories, and then follow the recommended method of disinfection.
- ▲ **Note:** 1) Host nebulizer to keep the liquid and nebulization mesh disc in full contact. Slight swing does not affect the use but do not lean back the nebulization.
- 2) Receiving treatment according to the doctors' recommendation. Keep quiet and relaxed in the course of treatment.
- 3) Liquid will be coagulated around the spray assembly and mesh disc, which will affect the nebulization effect after nebulization. It should stop nebulization, remove the mouthpiece and other accessories. Then use a clean medical gauze to wipe the residue. Do not touch the mesh disc center spray area to prevent damage to the mesh disc.
- 4) Essential oils, cough syrups, gargling solutions and drops to be used as a rub or in a steam bath are wholly unsuitable for inhalation using a nebuliser. These additives are often viscous and can impair the correct functioning of the device and therefore the effectiveness of the application in the long term.

## 5. Cleaning and Disinfection Method

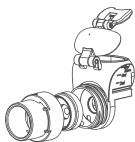

After each use, it is necessary to clean and disinfect the cup components (including medication cup, lid), spray assembly, mask or mouthpiece. The specific methods of cleaning and disinfection are recommended as follows:

### 5.1. Cleaning:

Please turn off the power when cleaning device. Do not connect the device with power supply.

- 1) Remove the components from the main unit: the cup components (including medication cup, lid), spray assembly, mask or mouthpiece, and soak all the components the main unit excluding in clean warm water (which is no more than 40°C) for about 5 minutes.
- 2) After cleaning, wipe all the components with clean medical gauze, and leave on open air to dry completely.
- 3) Wipe the outer shell of main unit. If there is medicine residue remaining at the electrode contact, please clean it with wet clean medical gauze. After cleaning, keep the main unit dry.
- 4) Store all the parts in a dry and clean place to avoid contamination.

#### ▲ **Note:**

- The main unit can not be washed with water to prevent water from entering the main unit.
- Use clean medical gauze to wipe the moisture of the main unit and components and keep them dry to ensure safe use next time.
- The masks must not be placed in hot water!

### 5.2. Disinfection

After each use, it is necessary to disinfect the components of the cup, spray nozzle, mask, mouthpiece, etc., as follows:

1) Disinfection with hydrogen peroxide:

Disinfect all the components by placing them in 3% hydrogen peroxide for 10 minutes, including cup components (medication cup, lid), spray assembly, mask or mouthpiece, the main unit excluding.

After disinfection, rinse all the parts with water, then wipe with clean and medical gauze or air-dry naturally to keep all parts dry.

A. Please study the user guidance of hydrogen peroxide and do not immerse in solution for a long time.

B. Do not use strong oxidizing agents such as perchlorate or disinfectants that are corrosive to metals, polymer compounds or polymers.

2) Ethanol disinfection:

Place the cup components (including medication cup, lid), spray assembly, mask in 75% medical ethanol for 10 minutes for disinfection. Or wipe and disinfect the cup components (including medication cup, lid) spray assembly, mask. After disinfection, rinse all the parts with water, then wipe with clean medical gauze or air-dry naturally to keep all parts dry.

**▲ Note:**

Disinfectants remaining on components need to be wiped with clean medical gauze to ensure safe use next time. Do not touch the central area of the mesh disc when washing or cleaning the spray connector, so as to avoid damaging the mesh diaphragm.

## 5.3. Drying

- Dry the parts carefully using a soft cloth.
- Shake the spray assembly gently from side to side (5 – 10 times), so that the water inside the mesh is removed from the tiny holes.
- Place the individual parts on a clean, dry and absorbent surface and leave them to dry completely (at least 4 hours).

**▲ Note:** Please ensure that the parts are completely dry after cleaning, otherwise the risk of bacterial growth is increased. Put the parts together again if they are completely dry and place the parts in a dry, sealed container. Ensure that the spray assembly is completely dried off by the shaking. Otherwise, the nebulisation may not work after reassembling the device. If this is the case, shake the spray assembly again so that the water can escape. The nebuliser should then work as normal.

## 6. Storage and Maintenance

### 6.1. Nebulizer Storage

1) Storage conditions:

- a. Environment temperature:  $-20^{\circ}\text{C} \sim +55^{\circ}\text{C}$ ;
- b. Relative humidity:  $\leq 80\%$  R.H. Non-condensing state;
- c. Atmospheric:  $86.0 \text{ kPa} \sim 106.0 \text{ kPa}$ ;
- d. Others: Non-corrosive gas, good ventilation, avoid high temperature, humidity

and direct sunlight.

## 2) Storage instructions:

- The device is valid for 5 years in the above mentioned storage condition.
- The nebulizer should be promptly cleaned and disinfected after use, the medication cup and other accessories should store into the packing box after completely drying. Stored in the required environmental condition, avoiding impact.

## 6.2. Nebulizer Maintenance

### 1) Normal working conditions

- Environment temperature: +5°C ~ +40°C;
- Relative humidity: ≤80% R.H. Non-condensing state;
- Atmospheric pressure: 86.0 ~ 106.0 kPa;
- Power: DC 3.7 V (Li-ion Battery) or DC 5.0 V/1.0 A with AC adapter (purchased by user, technical specification please refer to Chapter 2 for details).

### 2) Maintenance Instructions:

- Please use nebulizer under normal conditions.
- Do not use the nebulizer near the heating device or open flame. Do not use a microwave oven, fan and other dry nebulizer and accessories.
- Do not expose the nebulizer and accessories to corrosive liquids and gases.
- Do not wrap the power cord around the unit.
- When using a nebulizer, if any irregularities are encountered, seek a solution in accordance with Chapter 8.
- Dry the parts immediately after washing. Store the device and the components in the environment that meets the requirements, and be careful to avoid collisions.
- Direct sunlight, lint, dust may cause vibrating mesh rusted and oxydised and decrease nebulisation rate.
- If the nebulizer still does not work properly, please contact the distributor.





## 7. Contraindications, Precautions, Notices and Warnings

### 7.1. Contraindications



- This product is not suitable for Pentamidine drugs.
- Pulmonary oedema patients are prohibited to use.
- Acute asthma and acute pulmonary infarction episodes are prohibited to use.

### 7.2. Notice and suggestion:

<p>•The nebulizer is a medical device and is intended for human use only. Please follow the instructions in the manual or under the guidance of a doctor, infants and young children and special care crowd should be used under the supervision of the guardian.</p>	
<p>•Please use original parts and accessories. Warranty service is not provided for damage caused by accessory beyond our list and damaged by the user's personal causes.</p>	

<ul style="list-style-type: none"> <li>-The equipment waterproof classification is IP22, main unit can't be washed, and prevent the ingress of water.</li> </ul>	
<ul style="list-style-type: none"> <li>-Please refer to Chapter 8 (Trouble Shooting Tips) when there are problems or contact the distributor for maintenance. Do not attempt to repair the equipment personally.</li> </ul>	
<ul style="list-style-type: none"> <li>-Please clean and disinfect the unit after use and refer to Chapter 5 (Cleaning and Disinfection Method) for details.</li> </ul>	
<ul style="list-style-type: none"> <li>-The nebulizer is for medication atomization.</li> </ul>	
<ul style="list-style-type: none"> <li>-Remove the liquid before or storing the device.</li> </ul>	
<ul style="list-style-type: none"> <li>-Please confirm all the accessories are intact before use it.</li> </ul>	
<ul style="list-style-type: none"> <li>-The nozzle is a disposable accessory, only for a single person using to avoid cross-infection.</li> </ul>	
<ul style="list-style-type: none"> <li>-Try to keep the liquid fully reach the mesh disc when use.</li> </ul>	
<ul style="list-style-type: none"> <li>-Never submerge the device in water and do not use it in the bathroom. Under no circumstances may liquid enter the device.</li> </ul>	
<ul style="list-style-type: none"> <li>-Do not use the unit near flammable gas atmospheres or near oxygen and anaesthetic mixtures.</li> </ul>	
<ul style="list-style-type: none"> <li>-The instrument is expected to be used in radioactive radiation harassment controlled electromagnetic environment, as far as possible away from the source of harassment.</li> </ul>	
<ul style="list-style-type: none"> <li>-Do not use the device in a high temperature environment, as this may cause malfunction and fire.</li> </ul>	
<ul style="list-style-type: none"> <li>-Keep the device and parts away from strong vibrations, such as impact.</li> </ul>	
<ul style="list-style-type: none"> <li>-Please do not use liquid which contains esters, oil or suspended particles, including herbal extract.</li> </ul>	
<ul style="list-style-type: none"> <li>-Do not wash the main unit with running water to avoid water come inside the device, especially the USB connector.</li> </ul>	
<ul style="list-style-type: none"> <li>-Do not use the microwave ovens to dry or disinfect the unit, as this may cause fire.</li> </ul>	
<ul style="list-style-type: none"> <li>-Please place it in a place where children, infants and psychotic patients can not reach it.</li> </ul>	
<ul style="list-style-type: none"> <li>-Please use qualified manufacturers of lithium battery power charger (output 5.0 V/1.0 A).</li> </ul>	
<ul style="list-style-type: none"> <li>-Do not touch the center of spray mesh by hand or other sharp objects, as this may cause damage, and can not be used.</li> </ul>	
<ul style="list-style-type: none"> <li>-The nebulizer has no moisture proof and dustproof function, and the product should not be stored in a wet or dusty environment.</li> </ul>	
<ul style="list-style-type: none"> <li>-If the device has been dropped, exposed to high levels of moisture or suffered any other damage, it must no longer be used. If in doubt, contact Customer Services or the retailer.</li> </ul>	
<ul style="list-style-type: none"> <li>- Do not disassemble, repair, modify the device, as this may cause electric shock, leakage or fire.</li> </ul>	
<ul style="list-style-type: none"> <li>- Dispose of the wasted device and accessories in accordance with local regulations. Illegal disposal may pollute environment.</li> </ul>	
<ul style="list-style-type: none"> <li>- Users can dispose the device as general waste recycling and reduce environment pollution.</li> </ul>	

## 7.3. Warning

-Please refer to the doctor before use the device if you have diabetes or other illnesses.	
-Using and purchasing the device should be advised by a doctor, please refer to the doctor's advisements regardign the medication type, dosing and way of use.	
-Please stop using the device if feeling uncomfortable and ask for a doctor for help.	
-Volatile oil are not allowed, may cause damage to module.	
-Only water-soluble medicines containing alcohol or saline-diluted medicines can be used for nebulization treatment,otherwise bronchospasm may be caused.	
-Oily medication are not allowed.	
-The device is not workable for respiration anesthesia system and respirator system.	
-Check the leaflet of the medication for any contraindications for use with the usual systems for aerosol treatment.	
-Do not use any liquids with a viscosity of more than 5, as this can irreparably damage the mesh.	
-Only use the medication with a saline solution.	
-When the user needs to carry out product maintenance, the manufacturer can provide the product circuit diagram, key component list and other information according to the requirements, for the user's qualified technical personnel maintenance reference, can contact the manufacturer's after-sales service department to obtain.	
-DO NOT turn on without liquid in the medication cup!	
- Do not spill liquid to the device to avoid leakage, the possibility of electric shock and cause malfunction, failure to use.	

## 8. Trouble Shooting Tips

### Trouble shooting for nebulizer

	TROUBLE	POSSIBLE CAUSE/SOLUTION
1	Do not work when turn on	1) Check whether the nebulizer has enough power, when the blue and green indicator is always on, please recharge the device. 2) Check if the medication cup been full filled.
2	Low volume	1) Check if the medication cup been filled with right medication which should be water-solubility, non-corrosive medication. 2) Check whether the amount of liquid is too enough. 3) The spray mesh maybe blocked, you can drop 2 or 3 drops of white vinegar into the medication cup with 3-6 ml water, then fully nebulized. Clean the medication cup to disinfection for next nebulization.

3	What medication is more suitable for nebulization	1) Please refer to and follow doctor's advise. 2) Don't use over sticky medication.
4	Some medication residual	It is a normal sign, if there is some strange noises or the unit shut off due to insufficient medication, please stop nebulization.
5	Special care for babies and children	1) For infants, the mask should cover the nose and mouth to ensure effective inhalation. 2) On children, the mask should also cover both the nose and mouth. It is not very useful to carry out nebulisation on someone who is sleeping, as not enough of the medication will reach the lungs in this case. Note: Inhalation should only be carried out under the supervision of an adult and with their assistance, and the child should not be left alone.
6	Each user needs individual consumable item	Each user should use individual consumable items, including mask and mouthpiece.

## 9. Disposal

### Battery disposal

The empty, completely flat rechargeable batteries must be disposed of through specially designated collection boxes, recycling points or electronics retailers. You are legally required to dispose of the batteries.

### General disposal



For environmental reasons, do not dispose of the device in the household waste at the end of its useful life. Dispose of the device at a suitable local collection or recycling point in your country. Dispose of the device in accordance with EC Directive – WEEE (Waste Electrical and Electronic Equipment).

If you have any questions, please contact the local authorities responsible for waste disposal.

## 10. After-sales Service

10.1. Please contact our distributor to obtain warranty service.

10.2. If necessary, you can provide the circuit diagram and the necessary information for the repair. If there is any problem in the maintenance of the electrical circuit, you can contact the manufacturer or the distributor.

### Others please refer to the user manual

*\*The company reserves the right of final interpretation of the warranty card, which may be subject to change without prior notice*

# 11. Symbol description & Electromagnetic compatibility

## 11.1. Signs and symbols



Refer to instruction manual/  
booklet NOTE ON  
ME EQUIPMENT



Separate collection  
for electrical  
and electronic  
equipment



General  
imperative



ON/OFF Switch



keep away from  
sunlight

IP22

Waterproof  
Grade



Fragile



Keep dry



The application  
part of Type BF



Note, Warning  
refer to enclosed  
file

EC REP

Authorized  
representative  
in the European  
Community



Precautions



Manufacturer

LOT

Batch code



Production date

CE 0197

CE identification  
+ Notified Body  
number



Cause for electric  
shock



Increase  
nebulization rate



Decrease  
nebulization rate

MD

Medical Device



Humidity  
limitation



Temperature  
limitation



Atmospheric  
pressure limita-  
tion



Charging Interface



Do not  
disassemble



LF electromag-  
netic radiation



Importer



Disributor



Do not litter!



Product can be  
recycled

REF

Catalogue  
number



## 11.2. EMC Declarations

Nano AIR MINI Portable Mesh Nebulizer meet the requirement of electromagnetic compatibility in IEC60601-1-2.

The user needs to install and use according to electromagnetic compatibility information which is attached with it.

Portable and mobile RF communication device and some household appliances, such as mobile, interphone, microwave oven, dry blower, may influence nebulizer performance, so nebulizer should be kept away from them during using.

Guidance and manufacturer's declaration stated in the appendix.

### 1) EMC information.

With the increased number of electronic devices such as PC's and mobile (cellular) telephones, medical devices in use may be susceptible to electromagnetic interference from other devices. Electromagnetic interference may result in incorrect operation of the medical device and create a potentially unsafe situation.

Medical devices should also not interfere with other devices.

In order to regulate the requirements for EMC (Electro Magnetic Compatibility) with the aim to prevent unsafe product situations, the IEC60601-1-2 standard has been implemented. This standard defines the levels of immunity to electromagnetic interferences as well as maximum levels of electromagnetic emissions for medical devices.

The device is conform to IEC60601-1-2 standard for both immunity and emissions.

Nevertheless, special precautions need to be observed:

- ▲ **1. NOTE:** The EMISSIONS characteristics of this equipment make it suitable for use in a residential environment (for which CISPR 11 class B is normally required)
- 2. WARNING:** The use of accessories and cables other than those specified, with the exception of cables sold by EVOLU as replacement parts for internal components, may result in increased emission or decreased immunity of the device.
- 3. WARNING:** The medical devices should not be used adjacent to or stacked with other equipment. In case adjacent or stacked use is necessary, the medical device should be observed to verify normal operation in the configuration in which it will be used.
- 4. PORTABLE RF** communications equipment (including peripherals such as antenna cables and external antennas) should be used no closer than 30 cm (12 inches) to any part of [ME EQUIPMENT or ME SYSTEM], including cables specified by the MANUFACTURER. Otherwise, degradation of the performance of this equipment could result.
- 5.** Do not use mobile (cellular) telephones and other devices (such as MRI, diathermy, electrocautery, RFID and electromagnetic security systems) which generate strong electrical or electromagnetic fields, near the medical device. This may result in incorrect operation of the unit and create a potentially unsafe situation. Recommendation is to keep a minimum distance of 7 m. Verify correct operation of the device in case the distance is shorter.

Cables:	Length (m):	Whether to block:	Note:
USB Cable	1	No	-

Guidance and Manufacturer's declaration – electromagnetic emissions

This device is intended for use in the electromagnetic environment specified below. The customer or the user of the device should assure that it is used in such environment.

Electromagnetic emission IEC 60601-1-2

Emissions text	Compliance	Electromagnetic environment-guidance
RF emissions CISPR 11	Group 1	This device uses RF energy only for its internal function. Therefore, its RF emissions are very low and are not likely to cause any interference in nearby electronic equipment.
RF emissions CISPR 11	Class B	This device is suitable for use in all establishments, including domestic establishments and those directly connected to the public low-voltage power supply network that supplies buildings used for domestic purposes.
Harmonic emissions IEC 61000-3-2	Class A	
Voltage fluctuations/flicker emissions IEC 61000-3-3	Compliance	

Guidance and Manufacturer's declaration – electromagnetic immunity

The device is intended for use in the electromagnetic environment specified below. The customer or the user of the device should assure that it is used in such an environment.

Immunity test	IEC 60601 test level	Compliance level	Electromagnetic environment-Guidance
Electrostatic discharge (ESD) IEC 61000-4-2	$\pm 8$ kV contact $\pm 2$ kV, $\pm 4$ kV, $\pm 8$ kV, $\pm 15$ kV, air	$\pm 8$ kV contact $\pm 2$ kV, $\pm 4$ kV, $\pm 8$ kV, $\pm 15$ kV, air	Floors should be wood, concrete or ceramic tile. If floors are covered with synthetic material, the relative humidity should be at least 30%.
Electrical fast transient/burst IEC 61000-4-4	$\pm 2$ kV for power supply lines $\pm 1$ kV for input/output lines	$\pm 2$ kV for power supply lines *1)	Mains power quality should be that of a typical commercial or hospital environment.
Surge IEC 61000-4-5	$\pm 0.5 \pm 1$ kV Line to line $\pm 0.5$ kV $\pm 1$ kV, $\pm 2$ kV line to earth	$\pm 0.5$ kV $\pm 1$ kV line to line	Mains power quality should be that of a typical commercial or hospital environment.
Voltage dips, short interruptions and voltage variations on power supply IEC 61000-4-11	<5% UT (>95% dip in UT) for 0.5 cycle	<5 % UT (>95 % dip in UT) for 0.5 cycle	Mains power quality should be that of a typical commercial and/or hospital environment. If the user of this device requires continued operation during power mains interruptions, it is recommended that the device be powered from an uninterruptible power supply or battery.
	<5% UT (>95% dip in UT) for 1 cycle	<5% UT (>95% dip in UT) for 1 cycle	
	70%UT (30% dip in UT) for 25/30 cycles	70%UT (30% dip in UT) for 25/30 cycles	
	<5% UT (>95% dip in UT) for 5/6 sec	<5% UT (>95% dip in UT) for 5/6 sec	

Power frequency (50/60 Hz) magnetic field IEC 61000-4-8	30 A/m	30 A/m	Power frequency magnetic fields should be at levels characteristic of a typical location in a typical commercial or hospital environment.
Conducted RF IEC 61000-4-6	3V rms 150KHz to 80 MHz 6Vrms in ISM and amateur radio bands	3V/m	Portable and mobile RF communications equipment should be used no closer to any part of this device, including cables, than the recommended separation distance calculated from the equation applicable to the frequency of the transmitter. Recommended separation distance $d=1.2\sqrt{P}$ 150 KHz to 80 MHz $d=1.2\sqrt{P}$ 80 MHz to 800 MHz $d=2.3\sqrt{P}$ 800 MHz to 2,5 GHz Where P is the maximum output power rating of the transmitter in watts (W) according to the transmitter manufacturer and d is the recommended separation distance in meters (m). Field strengths from fixed RF transmitters, as determined by an electromagnetic site survey, *2) should be less than the compliance level in each frequency range *3) Interference may occur in the vicinity of equipment marked with the following symbol: 
Radiated RF IEC 61000-4-3	10 V/m 80 MHz to 2.7 GHz 385 MHz-5785 MHz Test specifications for ENCLOSURE PORT IMMUNITY TO RF wireless communication equipment (Refer to table 9 of IEC 60601-1-2)	3V/m	

**▲ NOTE 1:** At 80 MHz and 800 MHz, the higher frequency range applies.

**▲ NOTE 2:** These guidelines may not apply in all situations. Electromagnetic propagation is affected by absorption and reflection from structures, objects and people.

1. Field strengths from fixed transmitters, such as base stations for radio (cellular/cordless) telephones and land mobile radios, amateur radio, AM and FM radio broadcast and TV broadcast cannot be predicted theoretically with accuracy. To assess the electromagnetic environment due to fixed RF transmitters, an electromagnetic site survey should be considered. If the measured field strength in the location in which the device is used exceeds the applicable RF compliance level above, the device should be observed to verify normal operation. If abnormal performance is observed, additional measures may be necessary, such as reorienting or relocating this device.

2. Over the frequency range 150 kHz to 80 MHz, field strengths should be less than 3 V/m.

Recommended separation distances between portable and mobile RF communications equipment and the device.

The device is intended for use in an electromagnetic environment in which radiated RF disturbances are controlled. The customer or the user of the device can help prevent electromagnetic interference by maintaining a minimum distance between portable and mobile RF communications equipment (transmitters) and the device as recommended below, according to the maximum output power of the communications equipment.

Maximum output power rate of transmitters (W)	Separation distance according to frequency of transmitter		
	150 kHz to 80 MHz $d=1.2\sqrt{P}$	80 MHz to 800 MHz $d=1.2\sqrt{P}$	800 MHz to 2,5 GHz $d=2.3\sqrt{P}$
0.01	0.12	0.12	0.23
0.1	0.38	0.38	0.73
1	1.2	1.2	2.3
10	3.8	3.8	7.3
100	12	12	23

For transmitters rated at a maximum output power not listed above, the recommended separation distanced in meters (m) can be estimated using the equation applicable to the frequency of the transmitter, where P is the maximum output power rating of the transmitter in watts (W) according to the transmitter manufacturer.

## Precautions

- 1) In order to regulate the requirements for EMC with the aim to prevent unsafe product situations, the EN 60601-1-2 standard has been implemented. The nebulizer Nano AIR MINI conforms to the EN 60601-1-2 standard for both immunity and emissions.
- 2) Portable and mobile RF communication equipment may affect the performance of the nebulizer, avoid strong electromagnetic interference when using, such as close to mobile phones, microwave ovens and so on.

## Warning

- 1) Equipment or systems should not be used or stacked with other equipment. If they must be close to or stacked use, it should be observed that the verification in its use of the configuration can be normal operation.
- 2) Expect where the manufacturer of the unit is sold as a spare part for internal components, accessories and cables may cause an increase in the emission of this nebulizer or a reduction in immunity.

## Configuration list

Item	Quantity	If Included	
		Yes	No
Main unit	1	<input checked="" type="checkbox"/>	<input type="checkbox"/>
Medication cup	1	<input checked="" type="checkbox"/>	<input type="checkbox"/>
Adult mask	1	<input checked="" type="checkbox"/>	<input type="checkbox"/>
Child mask	1	<input checked="" type="checkbox"/>	<input type="checkbox"/>
Mouthpiece	1	<input checked="" type="checkbox"/>	<input type="checkbox"/>
User Manual	1	<input checked="" type="checkbox"/>	<input type="checkbox"/>
Warranty Card	1	<input checked="" type="checkbox"/>	<input type="checkbox"/>
User Guidance	1	<input checked="" type="checkbox"/>	<input type="checkbox"/>
Storage bag	1	<input checked="" type="checkbox"/>	<input type="checkbox"/>
Micro USB Cable	1	<input checked="" type="checkbox"/>	<input type="checkbox"/>
Warning badge	1	<input checked="" type="checkbox"/>	<input type="checkbox"/>
Warning card	1	<input checked="" type="checkbox"/>	<input type="checkbox"/>

# warranty card

stamp

Type of product: \_\_\_\_\_ Serial No: \_\_\_\_\_

Name of customer: \_\_\_\_\_ Date of purchase: \_\_\_\_\_

Contact number: \_\_\_\_\_

Address: \_\_\_\_\_

Sale company: \_\_\_\_\_ Contact number: \_\_\_\_\_

Address of sales company: \_\_\_\_\_



# warranty card

stamp

Type of product: \_\_\_\_\_ Serial No: \_\_\_\_\_

Name of customer: \_\_\_\_\_ Date of purchase: \_\_\_\_\_

Contact number: \_\_\_\_\_

Address: \_\_\_\_\_

Sale company: \_\_\_\_\_ Contact number: \_\_\_\_\_

Address of sales company: \_\_\_\_\_

- The period of host free for maintain service is 2 years. Medication cup is 6 months.
- During the warranty period, we will decide to repair or replace damaged parts or accessories according to the case.
- The accessories (mask, mouthpiece) does not come in the warranty category since it is consumable item, details please refer to the manual.

**The following case does not include in the warranty.**

- Damage caused by human behaviours, holding, touching, soaking and wetting.
- Damage cause by not correctly operating the product according to the manual.
- Damage cause by accident.
- The user disassembles and change the product without authorization.
- No invoice, warranty card, the product serial being torn or can not identify.
- Attention:** please contact our distributor when the device needs maintenance.
- Please keep the packing of product so that it could be used when return the device to maintenance.
- Product inspection and calibration are carried out by an accredited laboratory and are not a warranty service!



- The period of host free for maintain service is 2 years. Medication cup is 6 months.
- During the warranty period, we will decide to repair or replace damaged parts or accessories according to the case.
- The accessories (mask, mouthpiece) does not come in the warranty category since it is consumable item, details please refer to the manual.

**The following case does not include in the warranty.**

- Damage caused by human behaviours, holding, touching, soaking and wetting.
- Damage cause by not correctly operating the product according to the manual.
- Damage cause by accident.
- The user disassembles and change the product without authorization.
- No invoice, warranty card, the product serial being torn or can not identify.
- Attention:** please contact our distributor when the device needs maintenance.
- Please keep the packing of product so that it could be used when return the device to maintenance.
- Product inspection and calibration are carried out by an accredited laboratory and are not a warranty service!

**EVOLU® is a registered Trade Mark of FORANS International AG, Switzerland** 



**FEELLIFE HEALTH INC.**

Room 1903, Building A, No.9 Furong Road, Tantou Community, Songgang Subdistrict, Bao'an District, Shenzhen 518104 Guangdong, China.

Tel.: 0086-755-6686 7080, e-mail: [info@feellife.com](mailto:info@feellife.com)



**Lotus NL B.V.**, Koningin Julianaplein 10, 1e Verd, 2595AA, The Hague, Netherlands.

E-mail: [peter@lotusnl.com](mailto:peter@lotusnl.com), Tel: +31645171879 (English), +31626669008 (Dutch)



**EE:** FORANS Eesti AS, Mustamäe tee 55, Tallinn, 10621, Estonia,

tel.: +372 6776426, email: [info@forans.ee](mailto:info@forans.ee)



**LV:** FORANS SIA, "Piepilsētas", Krustkalni, Ķekavas nov., LV-2111, Latvija

tel. +37167462367, email: [info@forans.lv](mailto:info@forans.lv)

Service life: 5 years



*feel better* 