

DMX 226

Dosing pump

Installation and operating instructions



DMX 226
Installation and operating instructions
(all available languages)
<http://net.grundfos.com/qri/i/99558952>





DMX 226

| | |
|---|------------|
| English (GB) | |
| Installation and operating instructions | 4 |
| Čeština (CZ) | |
| Montážní a provozní návod | 35 |
| Deutsch (DE) | |
| Montage- und Betriebsanleitung | 62 |
| Español (ES) | |
| Instrucciones de instalación y funcionamiento | 89 |
| Français (FR) | |
| Notice d'installation et de fonctionnement | 117 |
| Hrvatski (HR) | |
| Montažne i pogonske upute | 145 |
| Magyar (HU) | |
| Telepítési és üzemeltetési utasítás | 172 |
| Italiano (IT) | |
| Istruzioni di installazione e funzionamento | 199 |
| Nederlands (NL) | |
| Installatie- en bedieningsinstructies | 227 |
| Polski (PL) | |
| Instrukcja montażu i eksploatacji | 254 |
| Português (PT) | |
| Instruções de instalação e funcionamento | 282 |
| Română (RO) | |
| Instrucțiuni de instalare și utilizare | 310 |
| Srpski (RS) | |
| Uputstvo za instalaciju i rad | 338 |
| Svenska (SE) | |
| Monterings- och driftsinstruktion | 365 |
| Slovensko (SI) | |
| Navodila za montažo in obratovanje | 392 |
| Türkçe (TR) | |
| Montaj ve kullanım kılavuzu | 419 |
| 中文 (CN) | |
| 安装和使用说明书 | 447 |
| Appendix A | 473 |
| Appendix B | 478 |

English (GB) Installation and operating instructions

Original installation and operating instructions

Table of contents

| | | | |
|---|-----------|---|-----------|
| 1. Original safety instructions | 0 | 11.5 Venting | 30 |
| 2. General information | 4 | 11.6 Fault finding chart | 30 |
| 2.1 Introduction | 4 | 12. Maintenance | 31 |
| 2.2 Applications | 4 | 12.1 General notes | 31 |
| 3. Safety | 5 | 12.2 Cleaning and maintenance intervals | 31 |
| 3.1 Identification of safety instructions in this manual | 5 | 12.3 Cleaning the suction and discharge valves | 31 |
| 3.2 Qualification and training of personnel | 5 | 12.4 Maintenance of the relief valve | 32 |
| 3.3 Risks when safety instructions are not observed | 5 | 12.5 Replacing the diaphragm | 32 |
| 3.4 Safety-conscious working | 5 | 13. Fault finding chart | 33 |
| 3.5 Safety instructions for the operator/user | 5 | 13.1 Dosing pump does not run. | 33 |
| 3.6 Safety instructions for maintenance, inspection and installation work | 5 | 13.2 Dosing pump does not suck in. | 33 |
| 3.7 Unauthorised modification and manufacture of spare parts | 5 | 13.3 Dosing pump does not dose. | 33 |
| 3.8 Improper operating methods | 5 | 13.4 Dosing flow of the pump is inaccurate. | 33 |
| 3.9 Safety of the system in the event of a failure in the dosing system | 5 | 14. Dosing curves | 34 |
| 4. Technical data | 6 | 15. Disposing of the product | 34 |
| 4.1 Identification | 6 | | |
| 4.2 Pump models and pump types | 7 | 2. General information | |
| 4.3 Pump performance | 8 |  Read this document before you install the product. Installation and operation must comply with local regulations and accepted codes of good practice. | |
| 4.4 Suction heights | 9 | 2.1 Introduction | |
| 4.5 Ambient and operating conditions | 10 | These installation and operating instructions contain all the information required for starting up and handling the DMX 226 dosing pump. | |
| 4.6 Dosing medium | 10 | If you require further information or if any problems arise, which are not described in detail in this manual, please contact Grundfos. | |
| 4.7 Electrical data | 11 | 2.2 Applications | |
| 4.8 AR control unit | 11 | The DMX 226 pump is suitable for liquid, non-abrasive and non-flammable media strictly in accordance with the instructions in this manual. | |
| 4.9 Materials | 11 |  Warning | |
| 4.10 Weights | 12 | Other applications or the operation of pumps in ambient and operating conditions, which are not approved, are considered improper and are not permitted. Grundfos accepts no liability for any damage resulting from incorrect use. | |
| 4.11 Dimensional sketches | 13 | If a pump is explosion-proof, it is marked on the pump and motor nameplates. | |
| 5. Transport and storage | 17 |  Note | |
| 5.1 Delivery | 17 | The declaration of conformity supplied with explosion-proof pumps approved according to the 2014/34/EU directive replaces the declaration of conformity in this manual. | |
| 5.2 Intermediate storage | 17 |  Warning | |
| 5.3 Unpacking | 17 | When using explosion-proof pumps in potentially explosive areas according to the 2014/34/EU directive, the instructions "ATEX-approved pumps" as well as the instructions in this manual must be observed. | |
| 5.4 Return | 17 | | |
| 6. Installation | 18 | | |
| 6.1 Optimum installation | 18 | | |
| 6.2 Installation tips | 19 | | |
| 6.3 Mounting | 20 | | |
| 6.4 Hose / pipe lines | 20 | | |
| 6.5 Connecting the suction and discharge lines | 21 | | |
| 7. Electrical connections | 22 | | |
| 7.1 Versions with mains plug | 22 | | |
| 7.2 Versions without mains plug | 22 | | |
| 8. Commissioning | 22 | | |
| 8.1 Checks before start-up | 22 | | |
| 8.2 Start-up | 22 | | |
| 9. Operation | 23 | | |
| 9.1 Description of the pump | 23 | | |
| 9.2 Switching on/off | 24 | | |
| 9.3 Adjusting the dosing flow via the stroke length | 24 | | |
| 9.4 Stroke-length adjustment | 24 | | |
| 9.5 Adjustment of stroke rate using a frequency converter | 25 | | |
| 9.6 Using the AR control unit | 25 | | |
| 10. Operation with other electronics | 26 | | |
| 10.1 Electronic version stroke sensor | 26 | | |
| 10.2 Electronic diaphragm leakage sensor | 26 | | |
| 11. Integral relief valve | 29 | | |
| 11.1 Function | 29 | | |
| 11.2 Permissible media | 29 | | |
| 11.3 Connections | 29 | | |
| 11.4 Setting of opening pressure | 29 | | |

3. Safety

This manual contains general instructions that must be observed during installation, operation and maintenance of the pump. This manual must therefore be read by the installation engineer and the relevant qualified personnel/operators prior to installation and start-up, and must be available at the installation location of the pump at all times.

It is not only the general safety instructions given in this "Safety" section that must be observed, but also all the specific safety instructions given in other sections.

3.1 Identification of safety instructions in this manual

If the safety instructions or other advice in this manual are not observed, it may result in personal injury or malfunction and damage to the pump. The safety instructions and other advice are identified by the following symbols:



Warning

If these safety instructions are not observed, it may result in personal injury.

Caution

If these safety instructions are not observed, it may result in malfunction or damage to the equipment.

Note

Notes or instructions that make the job easier and ensure safe operation.

Information provided directly on the pump, e.g. labelling of fluid connections, must be observed and must be maintained in a readable condition at all times.

3.2 Qualification and training of personnel

The personnel responsible for the operation, maintenance, inspection and installation must be appropriately qualified for these tasks. Areas of responsibility, levels of authority and the supervision of the personnel must be precisely defined by the operator.

If the personnel do not have the necessary knowledge, the necessary training and instruction must be given. If necessary, training can be performed by the manufacturer/supplier at the request of the operator of the pump. It is the responsibility of the operator to make sure that the contents of this manual are understood by the personnel.

3.3 Risks when safety instructions are not observed

Non-observance of the safety instructions may have dangerous consequences for the personnel, the environment and the pump. If the safety instructions are not observed, all rights to claims for damages may be lost.

Non-observance of the safety instructions may lead to the following hazards:

- failure of important functions of the pump/system
- failure of specified methods for maintenance
- harm to humans from exposure to electrical, mechanical and chemical influences
- damage to the environment from leakage of harmful substances.

3.4 Safety-conscious working

The safety instructions in this manual, applicable national health and safety regulations and any operator internal working, operating and safety regulations must be observed.

3.5 Safety instructions for the operator/user

Hazardous hot or cold parts on the pump must be protected to prevent accidental contact.

Leakages of dangerous substances (e.g. hot, toxic) must be disposed of in a way that is not harmful to the personnel or the environment. Legal regulations must be observed.

Damage caused by electrical energy must be prevented (for more details, see for example the regulations of the VDE and the local electricity supply company).

3.6 Safety instructions for maintenance, inspection and installation work

The operator must ensure that all maintenance, inspection and installation work is carried out by authorised and qualified personnel, who have been adequately trained by reading this manual.

All work on the pump should only be carried out when the pump is stopped. The procedure described in this manual for stopping the pump must be observed.

Pumps or pump units which are used for media that are harmful to health must be decontaminated.

All safety and protective equipment must be immediately restarted or put into operation once work is complete.

Observe the points described in the initial start-up section prior to subsequent start-up.



Warning

Electrical connections must only be carried out by qualified personnel!

The pump housing must only be opened by personnel authorised by Grundfos!

3.7 Unauthorised modification and manufacture of spare parts

Modification or changes to the pump are only permitted following agreement with the manufacturer. Original spare parts and accessories authorised by the manufacturer are safe to use. Using other parts can result in liability for any resulting consequences.

3.8 Improper operating methods

The operational safety of the supplied pump is only ensured if it is used in accordance with section Technical data. The specified limit values must under no circumstances be exceeded.

Related information

[4.1.1 Nameplate](#)

3.9 Safety of the system in the event of a failure in the dosing system

DMX 226 dosing pumps are designed according to the latest technologies and are carefully manufactured and tested. However, a failure may occur in the dosing system. Systems in which dosing pumps are installed must be designed in such a way that the safety of the entire system is still ensured following a failure of the dosing pump. Provide the relevant monitoring and control functions for this.

4. Technical data

4.1 Identification

4.1.1 Nameplate

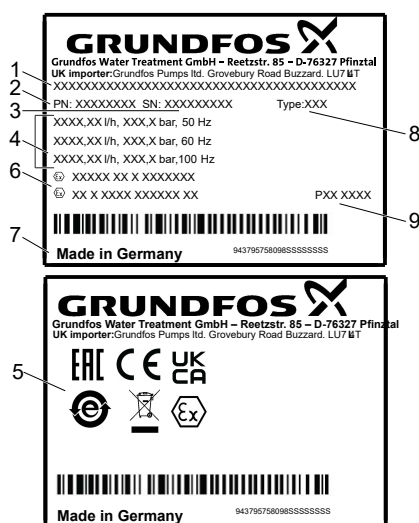

TM080167

| Pos. | Description |
|------|---------------------------------|
| 1 | Type designation |
| 2 | Product number |
| 3 | Serial number |
| 4 | Pump performance by frequency |
| 5 | Marks of approval |
| 6 | ATEX designation |
| 7 | Country of origin |
| 8 | Pump model |
| 9 | Production code (year and week) |

4.1.2 Type key

The type key is used to identify the precise pump and is not used for configuration purposes.

Type

DMX132-10D B-PVC/V/C-X-E1U3U3XEMAG

Nominal dosing capacity [l/h]

DMX132-10D B-PVC/V/C-X-E1U3U3XEMAG

Max. pressure [bar]

DMX132-10D B-PVC/V/C-X-E1U3U3XEMAG

10D Pumps marked with a "D" after the pressure value are double-head pumps.

Control variant

DMX132-10D B-PVC/V/C-X-E1U3U3XEMAG

| | |
|-----|---|
| B | Standard (manual control) |
| S1 | Stroke counter NAMUR, NC output |
| AR* | AR control unit, pump-mounted |
| AW* | AR control unit, wall-mounted |
| D3 | Servomotor, 1AC 115-230 V, 50/60 Hz, 4-20 mA control (without manual operation) |
| D4 | Servomotor, 24 VDC, 4-20 mA control (without manual operation) |

* Only for pumps ≤ 0.37 kW

Dosing head variant

DMX132-10D B-PVC/V/C-X-E1U3U3XEMAG

| | |
|------|--|
| PP | Polypropylene |
| PV | Polyvinylidene fluoride (PVDF) |
| SS | Stainless steel, 1.4571 (EN 10027-2), 316Ti (AISI) |
| PVC | Polyvinyl chloride |
| PPL | PP with Diaphragm Leakage Detection (DLD) |
| PVL | PV with Diaphragm Leakage Detection (DLD) |
| SSL | SS with Diaphragm Leakage Detection (DLD) |
| PVCL | PVC with Diaphragm Leakage Detection (DLD) |
| PVCR | PVC with integrated PRV |
| PVR | PV with integrated PRV |

Gasket material

DMX132-10D B-PVC/V/C-X-E1U3U3XEMAG

| | |
|---|------|
| E | EPDM |
| V | FKM |
| T | PTFE |

Valve ball material

DMX132-10D B-PVC/V/C-X-E1U3U3XEMAG

| | |
|----|--|
| G | Glass (from DN 32) |
| T | PTFE |
| SS | Stainless steel, 1.4401 (EN 10027-2), 316 (AISI) |
| C | Ceramic (up to DN 20) |

Terminal box position (also AR control or VFD position)

DMX132-10D B-PVC/V/C-X-E1U3U3XEMAG

| | |
|---|--|
| X | Opposite side of dosing head (3 o'clock) |
| D | Towards dosing head (9 o'clock) |
| S | Towards adjusting knob (6 o'clock) |
| R | Opposite side of adjusting knob (12 o'clock) |

Supply voltage

DMX132-10D B-PVC/V/C-X-E1U3U3XEMAG

| | |
|---|---|
| E | 3AC 230/400 V, 50/60 Hz, 440-480 V, 60 Hz (motors < 0.75 kW) |
| G | 1AC 230 V, 50/60 Hz (motors ≤ 0.09 kW) 1AC 230 V, 50 Hz (motors 0.18 - 0.37 kW) |
| H | 1AC 115 V, 50/60 Hz (motors ≤ 0.09 kW) 1AC 115 V, 60 Hz (motors 0.18 - 0.37 kW) |
| F | Without motor, NEMA flange |
| 0 | Without motor, IEC flange |
| 4 | 3AC 230/400 V, 50 Hz (EX motors) |
| 5 | 3AC 220/380 V, 60 Hz (EX motors) |
| K | 3AC 500 V, 50 Hz |
| L | 3AC 240/415 V, 50 Hz |
| P | 3AC 240/415 V, 60 Hz |
| N | 3AC 255/440 V, 60 Hz |
| M | 3AC 400/690 V, 50 Hz (standard in power plants) |

| Valve type (inlet/outlet) | |
|------------------------------------|---|
| DMX132-10D B-PVC/V/C-X-E1U3U3XEMAG | |
| 1 | Standard valves, not spring-loaded |
| 3 | Spring-loaded inlet valve (0.05 bar) and outlet valve (0.8 bar) |
| 4 | Spring-loaded outlet valve (0.8 bar), inlet valve not spring-loaded |
| 5 | For abrasive media |

Hydraulic connections (first = outlet, second = inlet)

| | |
|------------------------------------|--|
| DMX132-10D B-PVC/V/C-X-E1U3U3XEMAG | |
| U3 | G 5/4, for hoses with internal diameter 19 or 20 mm and for pipes with external diameter 25 mm |
| U7 | G 5/8, for hoses 0.17" x 1/4", 1/4" x 3/8", 3/8" x 1/2" (PVC, PP, PVDF) |
| A1 | G 5/4, for pipes with internal thread Rp 3/4 (SS) |
| A8 | Flange DN 32, for pipes with internal thread 1 1/4 NPT (PVC, PP, PVDF) |
| B5 | Flange DN 32, for pipes with external diameter 40 mm (PP, PVDF) |
| A2 | G 2, for pipes with internal thread Rp 1 1/4 (SS) |
| A3 | G 5/4, for pipes with internal thread 3/4 NPT (SS) |
| A7 | G 5/4, for pipes with external thread 3/4 NPT (PVC, PVDF) |
| A4 | G 2, for pipes with internal thread 1 1/4 NPT (SS) |
| K | G 2, for pipes with external diameter 40 mm (PVC) |

Mains plug (only 1AC motors)

| | |
|------------------------------------|--------------------------------|
| DMX132-10D B-PVC/V/C-X-E1U3U3XEMAG | |
| X | No plug |
| F | EU (Schuko) |
| B | USA, Canada |
| I | Australia, New Zealand, Taiwan |
| E | Switzerland |

Motor variant and certification

| | |
|------------------------------------|--|
| DMX132-10D B-PVC/V/C-X-E1U3U3XEMAG | |
| EM | Standard motor (without certificates) |
| E0 | Motor with PTC for thermal protection (without certificates) |
| E1 | EX motor, type EX II 2G EEx e II T3 (without certificates) |
| E2 | EX motor, type EX II 2GD EEx de IIC T4, without PTC (without certificates) |
| E5 | EX motor, type EX II 2GD EEx de IIC T4, with PTC (without certificates) |
| FA | VFD (variable frequency drive) (without certificates) |
| FB | VFD with I/O extension board (without certificates) |
| FC | VFD with internal Profibus (without certificates) |
| MP | Standard motor (with certificates) |
| K0 | Motor with PTC for thermal protection (with certificates) |
| K1 | EX motor, type EX II 2G EEx e II T3 (with certificates) |
| K2 | EX motor, type EX II 2GD EEx de IIC T4, without PTC (with certificates) |
| K5 | EX motor, type EX II 2GD EEx de IIC T4, with PTC (with certificates) |

Pump housing material

| | |
|------------------------------------|-----------|
| DMX132-10D B-PVC/V/C-X-E1U3U3XEMAG | |
| A | Aluminium |

Pump design

| | |
|------------------------------------|----------|
| DMX132-10D B-PVC/V/C-X-E1U3U3XEMAG | |
| G | Grundfos |
| N | Neutral |

4.2 Pump models and pump types

The pump nameplate shows various data of the pump like the type designation and the pump model. For an explanation of the nameplate see section Nameplate.

The pump type is the left part of the type designation and consists of the type abbreviation, the nominal dosing capacity and the maximum counterpressure. For an explanation of the type designation see section Type key.

| Pump model | Pump type | Dosing head size | Stroke volume [ml] | Motor power [kW] |
|------------|------------|------------------|--------------------|------------------|
| DMX 226M | DMX 24-8 | 1 | 13.8 | 0.18 |
| | DMX 37-5 | 2 | 22 | |
| | DMX 52-8 | 1 | 13.8 | |
| | DMX 60-3 | 3 | 36 | |
| | DMX 82-5 | 2 | 22 | |
| | DMX 100-8 | 1 | 13.8 | |
| | DMX 130-3 | 3 | 36 | |
| | DMX 142-8 | 1 | 13.8 | |
| | DMX 160-5 | 2 | 22 | |
| | DMX 224-5 | 2 | 22 | |
| DMX 226L | DMX 255-3 | 3 | 36 | 0.37* |
| | DMX 380-3 | 3 | 36 | |
| | DMX 67-10 | 1 | 18.5 | |
| | DMX 95-8 | 2 | 27.8 | |
| | DMX 132-10 | 1 | 18.5 | |
| | DMX 152-6 | 3 | 44.6 | |
| | DMX 190-10 | 1 | 18.5 | |
| | DMX 199-8 | 2 | 27.8 | |
| | DMX 249-3 | 4 | 73 | |
| | DMX 280-8 | 2 | 27.8 | |
| DMX 315-3 | 4 | 73 | | |
| DMX 321-6 | 3 | 44.6 | | |
| DMX 460-6 | 3 | 44.6 | | |
| DMX 525-3 | 4 | 73 | | |
| DMX 765-3 | 4 | 73 | | |

* With PTC thermistor: 0.55 kW.

4.3 Pump performance

4.3.1 Accuracy

- Dosing flow fluctuation: $\pm 1.5\%$ within the control range 1:10.
- Linearity deviation: $\pm 4\%$ of the full-scale value. Adjustment from max. to min. stroke length, within the control range 1:5.

Applies to:

- water as dosing medium
- fully deaerated dosing head
- standard pump version.

4.3.2 Performance

Applies to:

- maximum counterpressure
- water as dosing medium
- flooded suction 0.5 mWC
- fully deaerated dosing head

| Pump type | 50 Hz | | | | 60 Hz | | | | 100 Hz | | |
|------------|-------|------------------|----------|-------|-------|------------------|----------|-------|--------|------------------|----------|
| | Q* | Max. stroke rate | p max.** | | Q* | Max. stroke rate | p max.** | | Q* | Max. stroke rate | p max.** |
| | | | 3 AC | 1 AC | | | 3 AC | 1 AC | | | |
| | [l/h] | [n/min] | [bar] | [bar] | [l/h] | [n/min] | [bar] | [bar] | [l/h] | [n/min] | [bar] |
| DMX 24-8 | 24 | 29 | 8 | 8 | 28 | 34.8 | 8 | 8 | 48 | 58 | 8 |
| DMX 37-5 | 37 | 29 | 5 | 5 | 45 | 34.8 | 5 | 5 | 75 | 58 | 5 |
| DMX 52-8 | 52 | 63 | 8 | 8 | 62 | 75.6 | 8 | 8 | 104 | 126 | 8 |
| DMX 60-3 | 60 | 29 | 3 | 3 | 72 | 34.8 | 3 | 3 | 120 | 58 | 3 |
| DMX 67-10 | 67 | 57 | 10 | 10 | 80 | 68.4 | 10 | 10 | 134 | 114 | 10 |
| DMX 82-5 | 82 | 63 | 5 | 5 | 98 | 75.6 | 5 | 5 | 164 | 126 | 5 |
| DMX 95-8 | 95 | 57 | 8 | 8 | 114 | 68.4 | 8 | 8 | 190 | 114 | 8 |
| DMX 100-8 | 100 | 120 | 8 | 8 | 120 | 144 | 8 | 8 | - | - | - |
| DMX 130-3 | 130 | 63 | 3 | 3 | 156 | 75.6 | 3 | 3 | 260 | 126 | 3 |
| DMX 132-10 | 132 | 120 | 10 | 10 | 158 | 144 | 10 | 10 | - | - | - |
| DMX 142-8 | 142 | 168 | 8 | 8 | - | - | - | - | - | - | - |
| DMX 152-6 | 152 | 57 | 6 | 6 | 182 | 68.4 | 6 | 6 | 304 | 114 | 6 |
| DMX 160-5 | 160 | 120 | 5 | 5 | 192 | 144 | 5 | 5 | - | - | - |
| DMX 190-10 | 190 | 175 | 10 | 8 | - | - | - | - | - | - | - |
| DMX 199-8 | 199 | 120 | 8 | 8 | 239 | 144 | 8 | 8 | - | - | - |
| DMX 224-5 | 224 | 168 | 5 | 5 | - | - | - | - | - | - | - |
| DMX 249-3 | 249 | 57 | 3 | 3 | 299 | 68.4 | 3 | 3 | 498 | 114 | 3 |
| DMX 255-3 | 255 | 120 | 3 | 3 | 306 | 144 | 3 | 3 | - | - | - |
| DMX 280-8 | 280 | 175 | 8 | 6 | - | - | - | - | - | - | - |
| DMX 315-3 | 315 | 72 | 3 | 3 | 378 | 86.4 | 3 | 3 | 630 | 144 | 3 |
| DMX 321-6 | 321 | 120 | 6 | 4 | 385 | 144 | 6 | - | - | - | - |
| DMX 380-3 | 380 | 168 | 3 | 3 | - | - | - | - | - | - | - |
| DMX 460-6 | 460 | 175 | 6 | 3.5 | - | - | - | - | - | - | - |
| DMX 525-3 | 525 | 120 | 3 | 3 | 630 | 144 | 3 | 3 | - | - | - |
| DMX 765-3 | 765 | 175 | 3 | - | - | - | - | - | - | - | - |

* Dosing capacity per dosing head; double the capacity for double-head pumps.

** Dosing capacity per dosing head; double the capacity for double-head pumps.

4.4 Suction heights

4.4.1 Media with a viscosity similar to water

Applies to:

- counterpressure of 1.5 to 3 bar
- non-degassing and non-abrasive media
- temperature of 20 °C
- stroke length 100 %
- standard pump version.

| Pump type | 50 Hz | | 60 Hz | | 100 Hz | | Max. suction line length [m] |
|------------|------------------|-----------------|------------------|-----------------|------------------|-----------------|---------------------------------|
| | Suction height * | Suction lift ** | Suction height * | Suction lift ** | Suction height * | Suction lift ** | |
| | [mWC] | [mWC] | [mWC] | [mWC] | [mWC] | [mWC] | |
| DMX 24-8 | 3 | 1 | 2.5 | 1 | 2.5 | 1 | 4 |
| DMX 37-5 | 3 | 1 | 2.5 | 1 | 2 | 1 | 3 |
| DMX 52-8 | 3 | 1 | 2.5 | 1 | 2.5 | 1 | 4 |
| DMX 60-3 | 2 | 1 | 2 | 1 | 1.5 | 1 | 3 |
| DMX 67-10 | 3 | 1 | 2.5 | 1 | 2.5 | 1 | 4 |
| DMX 82-5 | 3 | 1 | 2.5 | 1 | 2 | 1 | 3 |
| DMX 95-8 | 3 | 1 | 2.5 | 1 | 2 | 1 | 3 |
| DMX 100-8 | 3 | 1 | 2.5 | 1 | - | - | 4 |
| DMX 130-3 | 2 | 1 | 2 | 1 | 1.5 | 1 | 3 |
| DMX 132-10 | 3 | 1 | 2.5 | 1 | - | - | 4 |
| DMX 142-8 | 3 | 1 | - | - | - | - | 4 |
| DMX 152-6 | 2 | 1 | 2 | 1 | 1.5 | 1 | 3 |
| DMX 160-5 | 3 | 1 | 2.5 | 1 | - | - | 3 |
| DMX 190-10 | 3 | 1 | - | - | - | - | 4 |
| DMX 199-8 | 3 | 1 | 2.5 | 1 | - | - | 3 |
| DMX 224-5 | 3 | 1 | - | - | - | - | 3 |
| DMX 249-3 | 1.5 | 1 | 1 | 0.5 | 1 | 0.5 | 2 |
| DMX 255-3 | 2 | 1 | 2 | 1 | - | - | 3 |
| DMX 280-8 | 3 | 1 | - | - | - | - | 3 |
| DMX 315-3 | 1.5 | 1 | 1 | 0.5 | - | - | 2 |
| DMX 321-6 | 2 | 1 | 2 | 1 | - | - | 3 |
| DMX 380-3 | 2 | 1 | - | - | - | - | 3 |
| DMX 460-6 | 2 | 1 | - | - | - | - | 3 |
| DMX 525-3 | 1 | 0.5 | 1 | 0.5 | - | - | 2 |
| DMX 765-3 | 0 | 0 | - | - | - | - | 2 |

* Suction line and dosing head filled (continuous operation).

With stronger restoring spring, the values for dosing head size 1 are increased by 2 metres, and for dosing head sizes 2 and 3 by 1 metre.

** Suction line and dosing head not filled, but dosing head and valves moistened (start-up).

4.4.2 Suction heights for media with maximum permissible viscosity

Applies to:

- Newtonian liquids
- non-degassing and non-abrasive media
- temperature of 20 °C
- standard pump version.

| Pump type | Maximum viscosity | Suction height |
|------------|-------------------|----------------|
| | [m Pas] | [mWC] |
| DMX 24-8 | 1000 | 1 |
| DMX 37-5 | 600 | 1 |
| DMX 52-8 | 700 | 1 |
| DMX 60-3 | 500 | 0 |
| DMX 67-10 | 700 | 1 |
| DMX 82-5 | 500 | 1 |
| DMX 95-8 | 500 | 1 |
| DMX 100-8 | 400 | 1 |
| DMX 130-3 | 400 | 0 |
| DMX 132-10 | 400 | 1 |
| DMX 142-8 | 200 | 0 |
| DMX 152-6 | 400 | 0 |
| DMX 160-5 | 200 | 0 |
| DMX 190-10 | 200 | 0 |
| DMX 199-8 | 200 | 0 |
| DMX 224-5 | 150 | 0 |
| DMX 249-3 | 100 | 0 |
| DMX 255-3 | 100 | 0 |
| DMX 280-8 | 150 | 0 |
| DMX 315-3 | 100 | 0 |
| DMX 321-6 | 100 | 0 |
| DMX 380-3 | 50 | 0 |
| DMX 460-6 | 50 | 0 |
| DMX 525-3 | 50 | 0 |
| DMX 765-3 | 10 | 0 |

4.5 Ambient and operating conditions

- Permissible ambient temperature: 0 °C to +40 °C.
- Permissible storage temperature: -20 °C to +50 °C.
- Permissible air humidity: max. relative humidity (non-condensing): 70 % at +40 °C, 90 % at +35 °C.

The installation site must be under cover!

Ensure that the enclosure class of motor and pump are not affected by the atmospheric conditions.

Caution

Pumps with electronics are only suitable for indoor use! Do not install outdoors!

Warning



Risk of hot surfaces!

Pumps with AC motors may become hot.

Allow a minimum space of 100 mm above the fan cover!

- Sound pressure level: ± 55 dB(A), testing according to DIN 45635-01-KL3
- Minimum counterpressure: 1 bar at the pump discharge valve. Pay attention to the pressure losses along the way to the injection point inclusively.

Pumps with AR control unit only

Maximum permissible mains impedance: $0.084 + j 0.084 \Omega$ (testing according to EN 61000-3-11).

4.6 Dosing medium

In the event of questions regarding the material resistance and suitability of the pump for specific dosing media, please contact Grundfos.

Caution

The dosing medium must have the following basic characteristics:

- liquid
- non-abrasive
- non-flammable.

4.6.1 Permissible media temperature

| Dosing head material | Temperature range p < 10 bar |
|----------------------|-------------------------------------|
| PVC | 0 °C to +40 °C |
| Stainless steel* | -10 °C to +70 °C |
| PP | 0 °C to +40 °C |
| PVDF | -10 °C to +60 °C +70 °C at 9 bar |

* For SIP/CIP applications (not with ATEX): A temperature of 145 °C at a counterpressure of max. 2 bar is permitted for a short period (15 minutes).

Caution Observe the freezing and boiling points of the dosing medium!

4.7 Electrical data

4.7.1 Enclosure class

The enclosure class depends on the motor variant selected, see motor nameplate.

The specified enclosure class can only be ensured if the power supply cable is connected with the same degree of protection.

Pumps with electronics: The enclosure class is only met if the sockets are protected! The data regarding the enclosure class applies to pumps with correctly inserted plugs or screwed-on caps.

4.7.2 Motor

Version: see motor and pump nameplates.

4.8 AR control unit

Functions of pumps with electronics:

- "Continuous operation" button for function test and dosing head deaeration
- memory function (stores a maximum of 65,000 pulses)
- two-stage tank-empty signal (e.g. via Grundfos tank empty sensor)
- stroke signal/pre-empty signal (adjustable), e.g. as a feedback to the control room
- dosing controller function (only with sensor - optional)
- diaphragm leakage detection (only with sensor - optional)
- access-code-protected settings
- remote on/off
- hall sensor
- operating hours counter
- motor monitoring.

Operating modes:

- manual
Stroke frequency: manually adjustable between zero and maximum
- contact signal control
Multiplier (1:n) and divisor (n:1)
- current signal control 0-20 mA / 4-20 mA
Adjustment of stroke frequency proportional to the current signal.
Weighting of current input.

4.8.1 Inputs and outputs

| Inputs | |
|--|--|
| Contact signal | Maximum load: 12 V, 5 mA |
| Current 0-20 mA | Maximum load: 22 Ω |
| Remote on/off | Maximum load: 12 V, 5 mA |
| Two-stage tank-empty signal | Maximum load: 12 V, 5 mA |
| Dosing controller and diaphragm leakage sensor | |
| Outputs | |
| Current 0-20 mA | Maximum load: 350 Ω |
| Error signal | Maximum ohmic load: 50 VDC / 75 VAC, 0.5 A |
| Stroke signal | Contact time/stroke: 200 ms |
| Pre-empty signal | Maximum ohmic load: 50 VDC / 75 VAC, 0.5 A |

AR control unit factory settings

- Inputs and outputs: NO (normally open)
or
- inputs and outputs: NC (normally closed).

4.9 Materials

Pump

- Pump housing: Al 226
- Diaphragm flanges: GG 25
- Stroke-length adjustment knob: ABS.

AR control unit enclosure

- Upper part of enclosure: PPO blend
- Lower part of enclosure: aluminium.

Optoelectronic diaphragm sensor

- Housing: ABS.

4.10 Weights

| Single pump | Approx. weight [kg] | | Double pump | Approx. weight [kg] | |
|-------------|----------------------|-----------------|--------------|----------------------|-----------------|
| | Dosing head material | | | Dosing head material | |
| | PVC | Stainless steel | | PVC | Stainless steel |
| DMX 24-8 | 15 | 21 | DMX 24-8D | 24 | 36 |
| DMX 37-5 | 15 | 21 | DMX 37-5D | 24 | 36 |
| DMX 52-8 | 15 | 21 | DMX 52-8D | 24 | 36 |
| DMX 60-3 | 15 | 21 | DMX 60-3D | 24 | 36 |
| DMX 67-10 | 21 | 30 | DMX 67-10D | 30 | 48 |
| DMX 82-5 | 15 | 21 | DMX 82-5D | 24 | 36 |
| DMX 95-8 | 21 | 30 | DMX 95-8D | 30 | 48 |
| DMX 100-8 | 15 | 21 | DMX 100-8D | 24 | 36 |
| DMX 130-3 | 15 | 21 | DMX 130-3D | 24 | 36 |
| DMX 132-10 | 21 | 30 | DMX 132-10D | 30 | 48 |
| DMX 142-8 | 15 | 21 | DMX 142-8D | 24 | 36 |
| DMX 152-6 | 21 | 30 | DMX 152-6D | 30 | 48 |
| DMX 160-5 | 15 | 21 | DMX 160-5D | 24 | 36 |
| DMX 190-8 | 21 | 30 | DMX 190-8D | 30 | 48 |
| DMX 190-10 | 21 | 30 | DMX 190-10D | 30 | 48 |
| DMX 199-8 | 21 | 30 | DMX 199-8D | 30 | 48 |
| DMX 224-5 | 15 | 21 | DMX 224-5D | 24 | 36 |
| DMX 249-3 | 21 | 30 | DMX 249-3D | 30 | 48 |
| DMX 255-3 | 15 | 21 | DMX 255-3D | 24 | 36 |
| DMX 280-6 | 21 | 30 | DMX 280-6D | 30 | 48 |
| DMX 280-8 | 21 | 30 | DMX 280-8D | 30 | 48 |
| DMX 315-3 | 21 | 30 | DMX 315-3D | 30 | 48 |
| DMX 321-4 | 21 | 30 | DMX 321-4D | 30 | 48 |
| DMX 321-6 | 21 | 30 | DMX 321-6D | 30 | 48 |
| DMX 380-3 | 15 | 21 | DMX 380-3D | 24 | 36 |
| DMX 460-3,5 | 21 | 30 | DMX 460-3,5D | 30 | 48 |
| DMX 460-6 | 21 | 30 | DMX 460-6D | 30 | 48 |
| DMX 525-3 | 21 | 30 | DMX 525-3D | 30 | 48 |
| DMX 765-3 | 21 | 30 | DMX 765-3D | 30 | 48 |

4.11 Dimensional sketches

4.11.1 Dimensions of DMX 226M single-head pumps

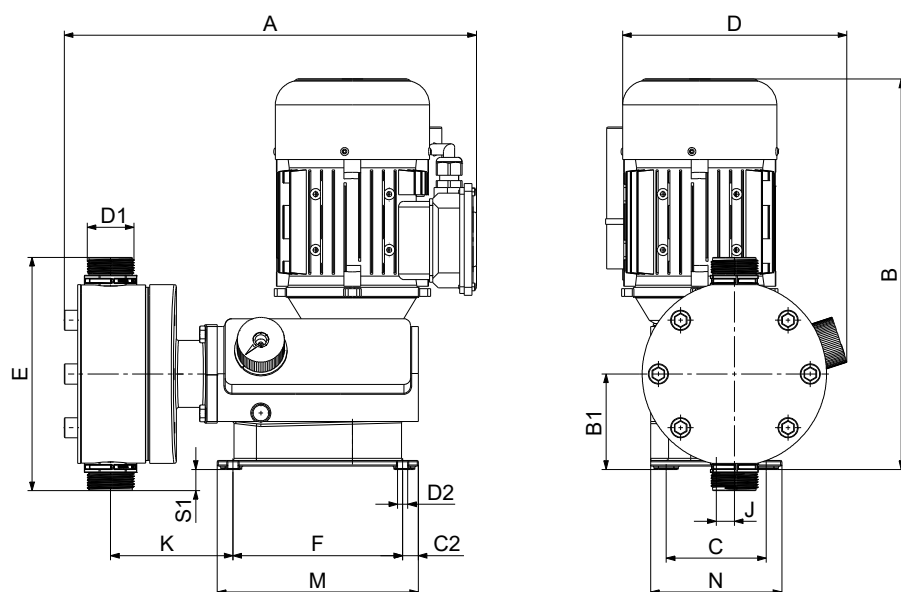

TM073717

All dimensions are in mm, except for the thread designations.

| Pump type | A | B | C | C2 | D | D1 | D2 | F | B1 | K | M | N | J |
|-----------|-----|-----|------|------|-----|--------|----|-----|------|-------|-----|-----|----|
| All | 302 | 310 | 97.5 | 24.5 | 190 | G1 1/4 | 9 | 152 | 85.5 | 104.5 | 180 | 118 | 16 |

| Pump type | E | S1 |
|-----------|-----|----|
| DMX 24-8 | 178 | 4 |
| DMX 37-5 | 188 | 9 |
| DMX 52-8 | 178 | 4 |
| DMX 60-3 | 208 | 19 |
| DMX 82-5 | 188 | 9 |
| DMX 100-8 | 178 | 4 |
| DMX 130-3 | 208 | 19 |
| DMX 142-8 | 178 | 4 |
| DMX 160-5 | 188 | 9 |
| DMX 224-5 | 188 | 9 |
| DMX 255-3 | 208 | 19 |
| DMX 380-3 | 208 | 19 |

4.11.2 Dimensions of DMX 226M double-head pumps

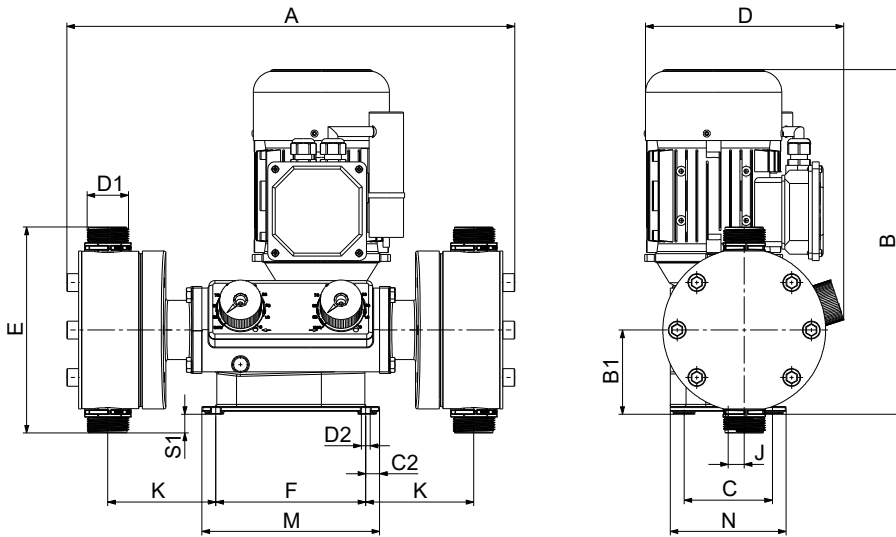

All dimensions are in mm, except for the thread designations.

| Pump type | A | B | C | C2 | D | D1 | D2 | F | B1 | K | M | N | J |
|-----------|-----|-----|------|------|-----|--------|----|-----|------|-------|-----|-----|----|
| All | 425 | 310 | 97.5 | 24.5 | 190 | G1 1/4 | 9 | 152 | 85.5 | 104.5 | 180 | 118 | 16 |

| Pump type | E | S1 |
|------------|-----|----|
| DMX 24-8D | 178 | 4 |
| DMX 37-5D | 188 | 9 |
| DMX 52-8D | 178 | 4 |
| DMX 60-3D | 208 | 19 |
| DMX 82-5D | 188 | 9 |
| DMX 100-8D | 178 | 4 |
| DMX 130-3D | 208 | 19 |
| DMX 142-8D | 178 | 4 |
| DMX 160-5D | 188 | 9 |
| DMX 224-5D | 188 | 9 |
| DMX 255-3D | 208 | 19 |
| DMX 380-3D | 208 | 19 |

TM073723

4.11.3 Dimensions of DMX 226L single-head pumps

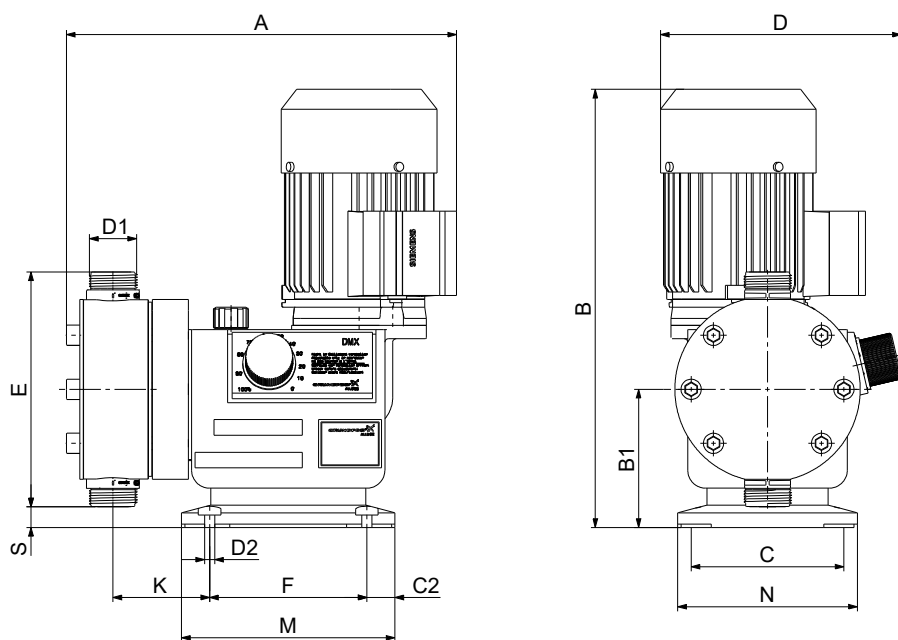

TM073716

All dimensions are in mm, except for the thread designations.

| Pump type | C | C2 | D | D2 | F | B1 | M | N |
|-----------|-----|----|-----|----|-----|-----|-----|-----|
| All | 136 | 25 | 222 | 9 | 140 | 123 | 190 | 160 |

| Pump type | A | B | D1 | E | K | S |
|-------------|-----|-----|--------|-----|----|----|
| DMX 95-8 | 366 | 372 | G1 1/4 | 188 | 80 | 29 |
| DMX 132-10 | 366 | 372 | G1 1/4 | 178 | 80 | 34 |
| DMX 152-6 | 381 | 372 | G1 1/4 | 208 | 83 | 19 |
| DMX 190-8 | 366 | 372 | G1 1/4 | 178 | 80 | 34 |
| DMX 190-10 | 366 | 372 | G1 1/4 | 178 | 80 | 34 |
| DMX 199-8 | 366 | 372 | G1 1/4 | 188 | 80 | 29 |
| DMX 249-3 | 395 | 390 | G2 | 240 | 92 | 3 |
| DMX 280-6 | 366 | 372 | G1 1/4 | 188 | 80 | 29 |
| DMX 280-8 | 366 | 372 | G1 1/4 | 188 | 80 | 29 |
| DMX 315-3 | 395 | 390 | G2 | 240 | 92 | 3 |
| DMX 321-4 | 381 | 372 | G1 1/4 | 208 | 83 | 19 |
| DMX 321-6 | 381 | 372 | G1 1/4 | 208 | 83 | 19 |
| DMX 460-3,5 | 381 | 372 | G1 1/4 | 208 | 83 | 19 |
| DMX 460-6 | 381 | 372 | G1 1/4 | 208 | 83 | 19 |
| DMX 525-3 | 395 | 390 | G2 | 240 | 92 | 3 |
| DMX 765-3 | 395 | 390 | G2 | 240 | 92 | 3 |
| DMX 67-10 | 366 | 372 | G1 1/4 | 178 | 80 | 34 |

4.11.4 Dimensions of DMX 226L double-head pumps

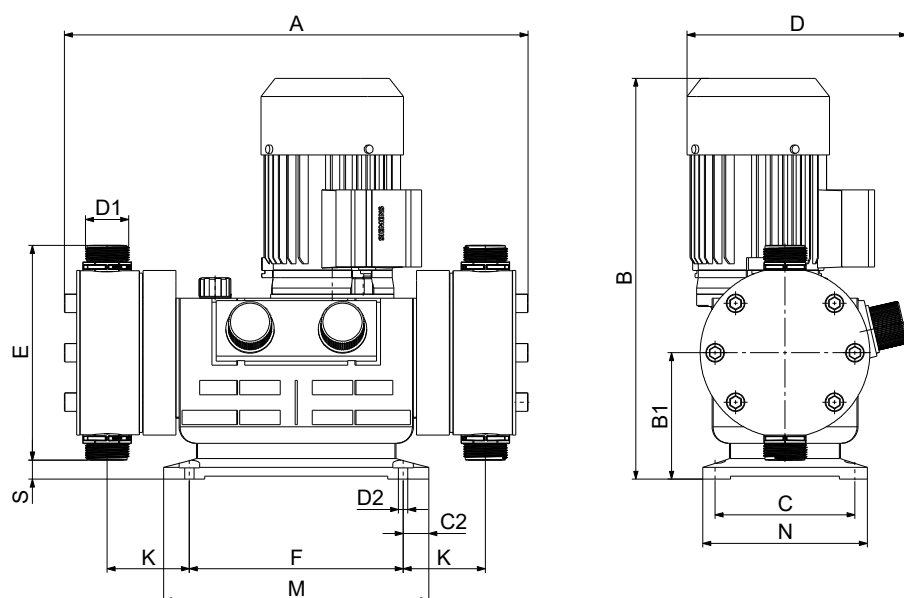

TM073722

All dimensions are in mm, except for the thread designations.

| Pump type | C | C2 | D | D2 | F | B1 | M | N |
|-----------|-----|----|-----|----|-----|-----|-----|-----|
| All | 136 | 25 | 222 | 9 | 208 | 123 | 258 | 160 |

| Pump type | A | B | D1 | E | K | S |
|--------------|-----|-----|--------|-----|----|----|
| DMX 67-10D | 440 | 372 | G1 1/4 | 178 | 80 | 34 |
| DMX 95-8D | 444 | 372 | G1 1/4 | 188 | 80 | 29 |
| DMX 132-10D | 440 | 372 | G1 1/4 | 178 | 80 | 34 |
| DMX 152-6D | 453 | 372 | G1 1/4 | 208 | 83 | 19 |
| DMX 190-8D | 440 | 372 | G1 1/4 | 178 | 80 | 34 |
| DMX 190-10D | 440 | 372 | G1 1/4 | 178 | 80 | 34 |
| DMX 199-8D | 444 | 372 | G1 1/4 | 188 | 80 | 29 |
| DMX 249-3D | 498 | 390 | G2 | 240 | 92 | 3 |
| DMX 280-6D | 444 | 372 | G1 1/4 | 188 | 80 | 29 |
| DMX 280-8D | 444 | 372 | G1 1/4 | 188 | 80 | 29 |
| DMX 315-3D | 498 | 390 | G2 | 240 | 92 | 3 |
| DMX 321-4D | 453 | 372 | G1 1/4 | 208 | 83 | 19 |
| DMX 321-6D | 453 | 372 | G1 1/4 | 208 | 83 | 19 |
| DMX 460-3,5D | 453 | 372 | G1 1/4 | 208 | 83 | 19 |
| DMX 460-6D | 453 | 372 | G1 1/4 | 208 | 83 | 19 |
| DMX 525-3D | 498 | 390 | G2 | 240 | 92 | 3 |
| DMX 765-3D | 498 | 390 | G2 | 240 | 92 | 3 |

5. Transport and storage

Do not throw or drop the pump.

Store the pump in a dry and cool place.

Store the pump in upright position so that the gear grease cannot leak out.

Caution

Do not use the protective packaging as transport packaging.

Observe the permissible storage temperature!

5.1 Delivery

The DMX 226 dosing pumps are supplied in different packaging, depending on pump type and the overall delivery. For transport and intermediate storage, use the correct packaging to protect the pump against damage.

5.2 Intermediate storage

- Permissible storage temperature: -20 °C to +50 °C.
- Permissible air humidity: max. relative humidity: 92 % (non-condensing).

5.3 Unpacking

Retain the packaging for future storage or return, or dispose of the packaging in accordance with local regulations.

5.4 Return

Return the pump in its original packaging or equivalent.

The pump must be thoroughly cleaned before it is returned or stored. It is essential that there are no traces of toxic or hazardous media remaining on the pump.

Caution

Grundfos accepts no liability for damage caused by incorrect transportation or missing or unsuitable packaging of the pump!

Before returning the pump to Grundfos for service, the **safety declaration** at the end of these instructions must be filled in by authorised personnel and attached to the pump in a visible position.

Caution

If a pump has been used for a medium which is injurious to health or toxic, the pump will be classified as contaminated.

If Grundfos is requested to service the pump, it must be ensured that the pump is free from substances that can be injurious to health or toxic. If the pump has been used for such substances, the pump must be cleaned before it is returned.

If proper cleaning is not possible, all relevant information about the chemical must be provided.

If the above is not fulfilled, Grundfos can refuse to accept the pump for service. Possible costs of returning the pump are paid by the customer.

The safety declaration can be found at the end of these instructions.

Caution

The replacement of the supply cable must be carried out by an authorised Grundfos service workshop.

6. Installation

6.1 Optimum installation

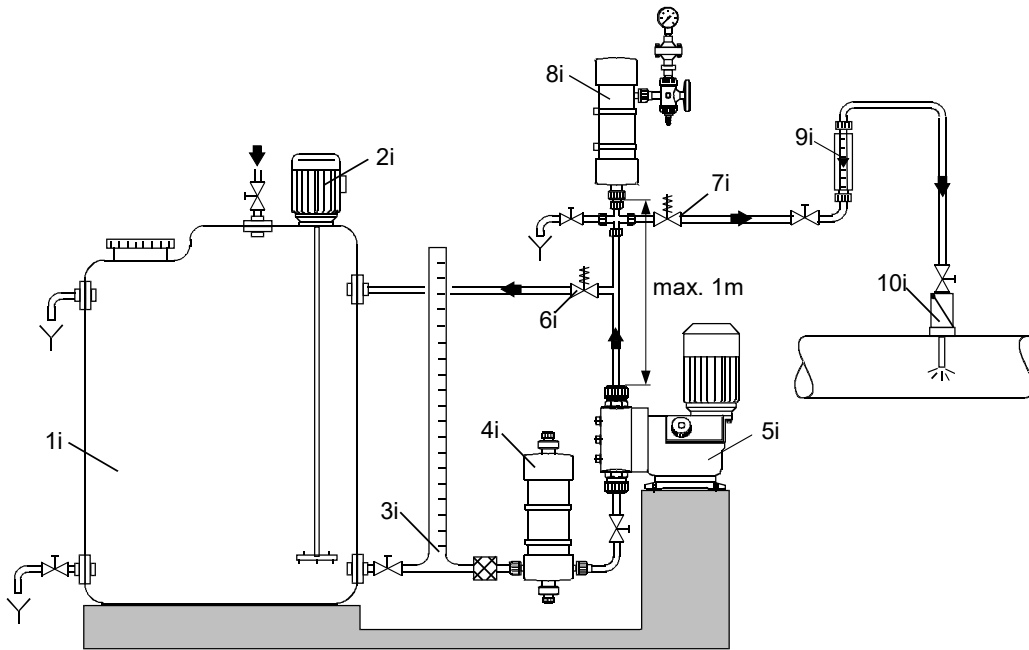

Example of optimum installation

| Pos. | Components |
|------|--------------------------|
| 1i | Dosing tank |
| 2i | Electric agitator |
| 3i | Extraction device |
| 4i | Suction pulsation damper |
| 5i | Dosing pump |
| 6i | Relief valve |
| 7i | Pressure-loading valve |
| 8i | Pulsation damper |
| 9i | Measuring glass |
| 10i | Injection unit |

6.2 Installation tips

- For easy deaeration of the dosing head, install a ball valve (11i) with bypass line (back to the dosing tank) immediately after the discharge valve.
- In the case of long discharge lines, install a non-return valve (12i) in the discharge line.

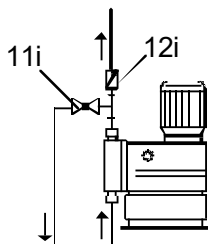

Installation with ball valve and non-return valve

- When installing the suction line, observe the following:
 - Keep the suction line as short as possible. Prevent it from becoming tangled.
 - If necessary, use swept bends instead of elbows.
 - Always route the suction line up towards the suction valve.
 - Avoid loops which may cause air bubbles.

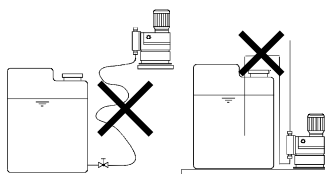

Installation of suction line

- For non-degassing media with a viscosity similar to water, the pump can be mounted on the tank (observe the maximum suction height).
- Flooded suction preferred.
- For media with a tendency to sedimentation, install the suction line with filter (13i) so that the suction valve remains a few millimetres above the possible level of sedimentation.

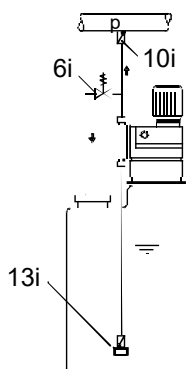

Tank installation

- Note for suction-side installation: In dosing systems with a suction line longer than 1 metre, depending on the dosing flow, it may be necessary to install a properly sized pulsation damper (4i) immediately before the pump suction valve.

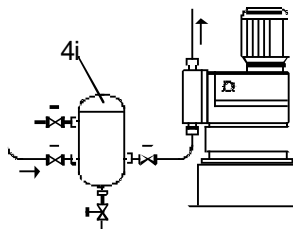

Installation with suction-side pulsation damper

- Note for discharge-side installation: To protect the piping, use a pulsation damper (8i) for rigid piping longer than 3 metres and tubing longer than 5 metres.

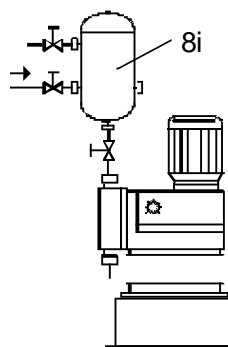

Installation with discharge-side pulsation damper

- For degassing and viscous media: flooded suction.
- To protect the dosing pump and the discharge line against excessive pressure build-up, install a relief valve (6i) in the discharge line.

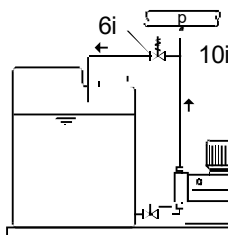

Installation with relief valve

With open outflow of the dosing medium or a counterpressure below 1 bar

- Install a pressure-loading valve (7i) immediately before the outlet or the injection unit.

A positive pressure difference of at least 1 bar must be ensured between the counterpressure at the injection point and the pressure of the dosing medium at the pump suction valve.

- If this cannot be ensured, install a pressure-loading valve (7i) in the discharge line.

TM036300

TM036297

TM036301

TM036298

TM036302

TM036299

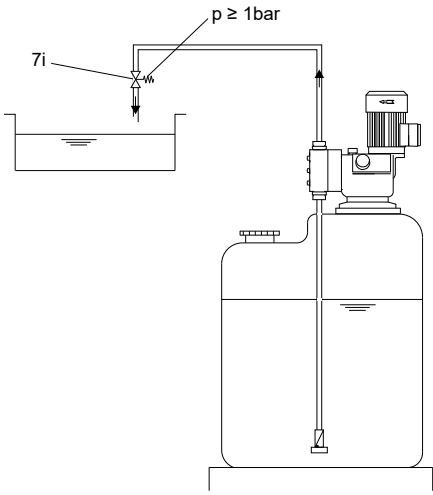

TM077840

Installation with pressure-loading valve

- To avoid the siphon effect, install a pressure-loading valve (7i) in the discharge line and, if necessary, a solenoid valve (14i) in the suction line.

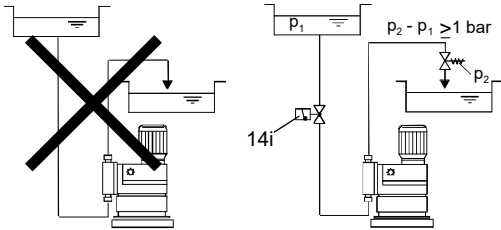

TM036304

Installation to avoid the siphon effect

Warning



Risk of hot surfaces!

Pumps with AC motors may become hot.

Allow a minimum space of 100 mm to the fan cover!

6.3 Mounting

- Mount the pump horizontally on the tank or on a console using four M8 screws.
- Replace the screw plugs by the deaeration screws supplied with the pump.



Gently tighten the screws in order not to damage the plastic enclosure!

6.4 Hose / pipe lines

6.4.1 General

Warning

To protect the dosing pump against excessive pressure build-up, install a relief valve in the discharge line.

Only use the prescribed line types!

All lines must be free from strain!

Avoid loops and buckles in the hoses!



Keep the suction line as short as possible to avoid cavitation!

If necessary, use swept bends instead of elbows.

Observe the chemical manufacturer's safety instructions when handling chemicals!

Make sure that the pump is suitable for the actual dosing medium!

The flow must run in the opposite direction to gravity!



The resistance of the parts that come into contact with the media depends on the media, media temperature and operating pressure. Ensure that parts in contact with the media are chemically resistant to the dosing medium under operating conditions!

6.5 Connecting the suction and discharge lines



Warning
 All lines must be free from strain!
 Only use the prescribed line types!

- Connect the suction line to the suction valve.
 - Install the suction line in the tank so that the foot valve remains 5 to 10 mm above the bottom of the tank or the possible level of sedimentation.
- Connect the discharge line to the discharge valve.

Connection of hose lines

- Push the hose firmly onto the connection nipple and, depending on the connection, secure using a connection counterpart or hose support clip.
- Fit the gasket.
- Screw onto the valve using the union nut.

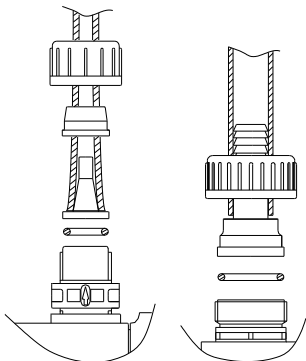

Connection of hose lines

Connection of DN 20 pipe lines

- Depending on the pipe material and connection, glue it (PVC), weld it (PP, PVDF or stainless steel) or press it in (stainless steel).
- Fit the gasket.
- Screw onto the valve using the union nut.

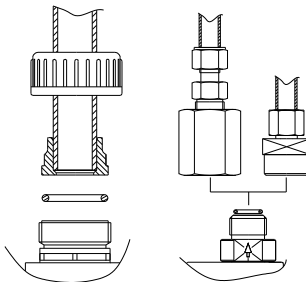

Connection of DN 20 pipe lines

Connection of DN 32 pipe lines

- Depending on the pipe material, fit the pipe to the welding neck flange and weld it (stainless steel) or insert it into the headed bush and weld it (PP, PVDF).

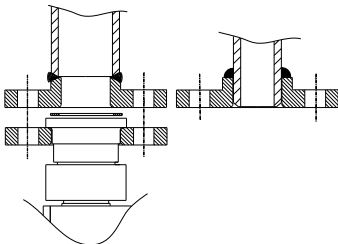

Connection of DN 32 pipe lines

Using a dosing controller

- Screw the dosing controller onto the discharge valve.

- Connect the discharge line to the dosing controller.

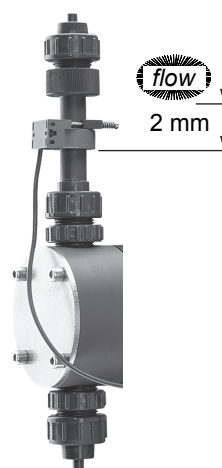

Dosing controller

TM036456

TM036457

TM03_6458_4506

TM036379

7. Electrical connections

Make sure that the pump is suitable for the electricity supply on which it will be used.

Warning



Electrical connections must only be carried out by qualified personnel!

Disconnect the power supply before connecting the power supply cable and the relay contacts!

Observe the local safety regulations!



Warning

The pump housing must only be opened by personnel authorised by Grundfos!



Warning

Protect the cable connections and plugs against corrosion and humidity.

Only remove the protective caps from the sockets that are being used.



The power supply must be electrically isolated from the signal inputs and outputs.

The pump is switched off by switching off the power supply.



Do not switch on the power supply until the pump is going to be started.

7.1 Versions with mains plug

- Insert the mains plug in the mains socket.

7.2 Versions without mains plug

- Connect the motor according to the wiring diagram in the terminal box.

Observe the direction of rotation!

A motor protector, adjusted to the rated motor current, must be provided by the customer. This is also necessary for versions with AR control unit!



When the pump is used with a frequency converter, the jumpers in the terminal box have to be set according to the converter voltage.

The jumpers of three-phase motors are factory-set for star connection.

8. Commissioning

8.1 Checks before start-up

- Check that the rated voltage stated on the pump nameplate corresponds to the local conditions!
- Check that all connections are secure and tighten, if necessary.
- Check that the dosing head screws are tightened with the specified torque and tighten, if necessary.
- Check that all electrical connections are correct.

8.2 Start-up

Before start-up, replace the screw plug by the deaeration screw!



During transport, the deaeration opening must be closed with the screw plug!

After initial start-up and after each time the diaphragm is changed, tighten the dosing head screws.



After approximately 6-10 operating hours or two days, cross-tighten the dosing head screws using a torque wrench.

Maximum torque: 6 Nm.

1. Open the suction and discharge isolating valves (15, 16), if installed.

2. Open the deaeration valve (17), if installed, in the discharge line, or relieve the pressure on the discharge side so that the medium can run out without a counterpressure.
3. Switch on the power supply.
4. Pumps with AR control unit only: Press the "Start/Stop" button and keep it pressed.
 - The pump switches to continuous operation.
5. Set the stroke-length adjustment knob to 100 %.
6. Leave the pump running until the dosed medium is free of air bubbles.
7. Close the deaeration valve (17), if installed.

The pump is now ready for operation.

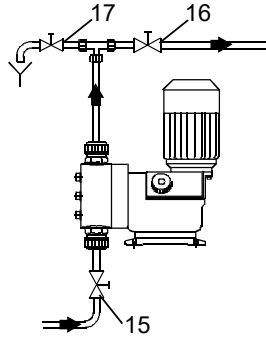

Initial start-up

9. Operation

Caution

In the event of a diaphragm leakage, the dosing liquid may leak out of the hole in the intermediate flange between the pump and the dosing head. The parts inside the housing are protected from the dosing liquid for a short time (depending on the type of liquid) by the housing sealing. It is necessary to check regularly (daily) if liquid is leaking out of the intermediate flange. For maximum safety, we recommend the pump version with diaphragm leakage detection.

9.1 Description of the pump

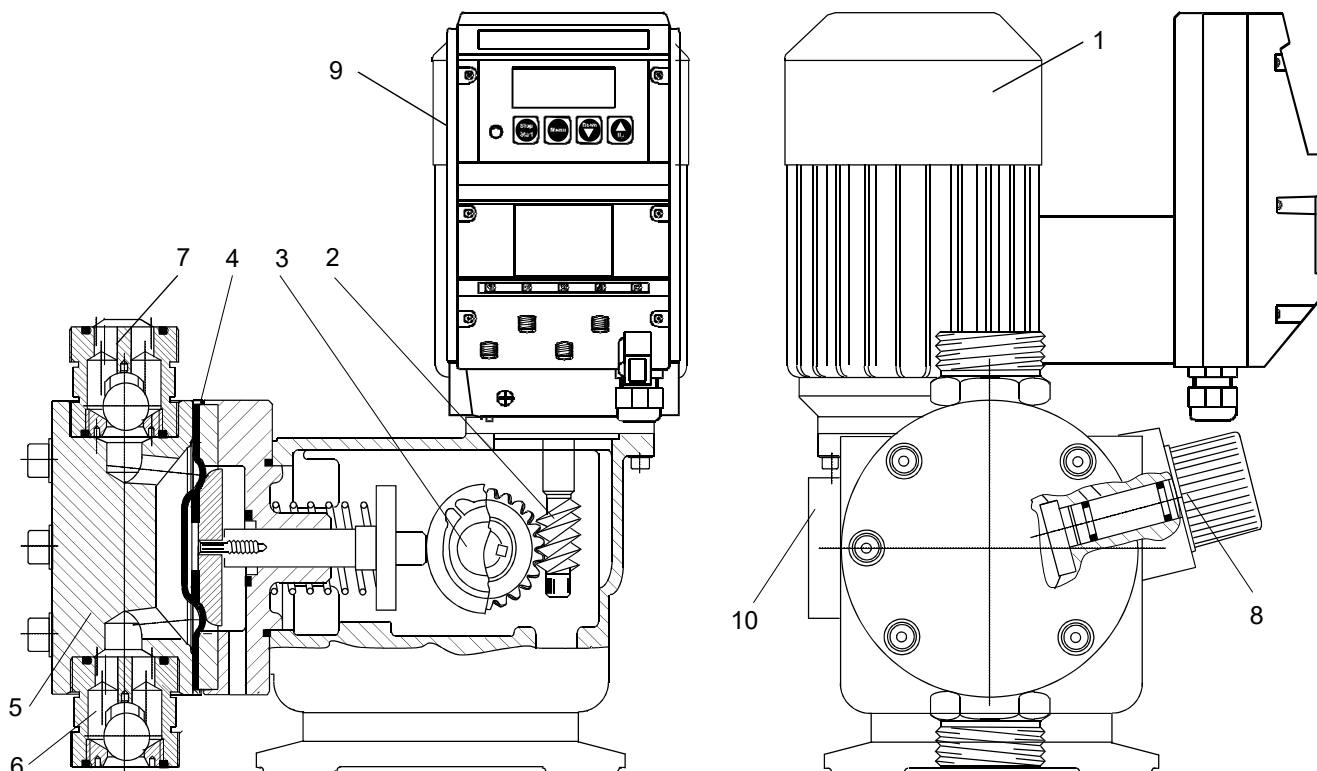

TM03_6380_4506

DMX 226

| Pos. | Components |
|------|-------------------------------|
| 1 | Motor |
| 2 | Gears |
| 3 | Eccentric |
| 4 | Dosing diaphragm |
| 5 | Dosing head |
| 6 | Suction valve |
| 7 | Discharge valve |
| 8 | Stroke-length adjustment knob |
| 9 | AR control unit (optional) |
| 10 | Stroke sensor |

Functional principle

- Reciprocating positive displacement pump with electric motor and mechanical diaphragm control.
- The rotation of the motor is transformed into the reciprocating movement of the dosing diaphragm by the eccentric and the tappet.
- The dosing flow can be set by adjusting the stroke length of the tappet.

9.2 Switching on/off

Caution Before switching on the pump, check that it is installed correctly. Refer to sections Installation and Commissioning.

- To start the pump, switch on the power supply.
- To stop the pump, switch off the power supply.

Related information

- [6.1 Optimum installation](#)
- [8.1 Checks before start-up](#)

9.3 Adjusting the dosing flow via the stroke length

Caution Adjust the stroke length only while the pump is running!

- Slacken the locking screw (A) on the stroke-length adjustment knob (8) a little using a screwdriver.
- To increase the dosing flow, turn the stroke-length adjustment knob (8) slowly to the left until the desired dosing flow is reached.
- To decrease the dosing flow, turn the stroke-length adjustment knob (8) slowly to the right until the desired dosing flow is reached.
- Gently retighten the locking screw (A) using a screwdriver.

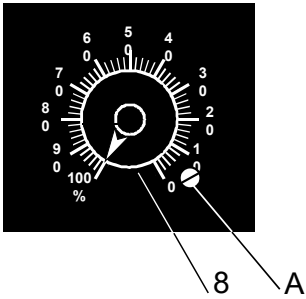

Stroke-length adjustment knob

9.4 Stroke-length adjustment



Warning

Wear protective clothing (gloves and goggles) when working on the dosing head, connections or lines!



Adjust the stroke length only while the pump is running!

The zero point (no dosing) of the dosing pump is factory-set to a counterpressure of 3 bar. See section Dosing curves.

If the operating counterpressure at the injection unit deviates considerably from this value, it is advisable to readjust the zero point to obtain more precise values.

1. Install a graduated pipe at the suction valve.
 - If such a pipe is not available, insert the suction line into a graduated measuring jug.
2. Start the dosing pump.
3. Set the dosing flow to 15 %.
4. For pumps with tank-empty indication, remove the electric plug of the tank-empty indication.
5. Remove the locking screw (A) from the stroke-length adjustment knob (8) using a screwdriver. See fig. Stroke-length adjustment knob.
6. Turn the adjustment knob slowly clockwise (towards the zero point) until the medium level stops falling in the measuring jug or pipe.
7. Remove the plug with a small screwdriver without changing the position of the adjustment knob and unscrew the cheese-head screw together with the flat spiral spring.
8. Gently pull off the adjustment knob and fit it on the adjusting spindle so that the zero line on the scale and the mark on the adjustment knob coincide.
9. Screw in the cheese-head screw and the spiral spring until the spring is preloaded, but does not block. Even when adjusted to 100 %, the spring of the adjustment knob must remain preloaded.
10. Insert the locking screw (A) using a screwdriver and tighten gently.

TM037203

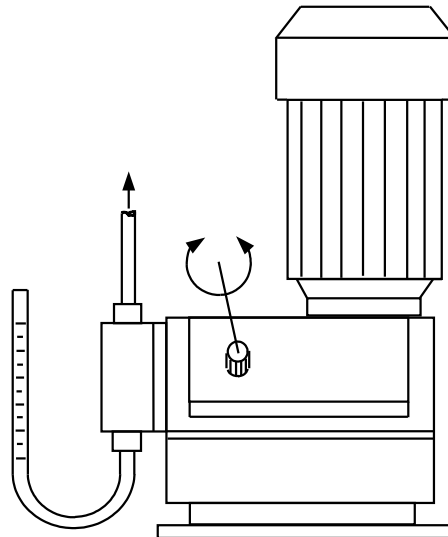

Stroke-length adjustment

Related information

- [9.3 Adjusting the dosing flow via the stroke length](#)
- [14. Dosing curves](#)

TM036310

9.5 Adjustment of stroke rate using a frequency converter

If a frequency converter is connected, the stroke rate can only be adjusted in the range 10-100 % of max. stroke rate. See installation and operating instructions for the frequency converter!



Warning

Observe the manufacturer's instructions!

The connections must be carried out according to these instructions.

Settings of frequency converter when used with Grundfos dosing pumps

Pay special attention to the following parameters of the frequency converter:

- P013 (maximum motor frequency):
 - Set the frequency converter to maximum 100 Hz.
 - Due to this setting, the maximum stroke frequency of the pump cannot be exceeded.
- P086 (motor current limit):
 - Do not change the default setting (150 %).
 - The motor is protected by a PTC resistor. Therefore, this parameter is not necessary.
- P081 - P085 (motor data):
 - Set these parameters to the values stated on the motor nameplate.
 - Observe the manufacturer's instructions!

9.6 Using the AR control unit

When using the AR control unit, observe the installation and operating instructions supplied with the unit in addition to the instructions in this manual.

10. Operation with other electronics

Caution First refer to the general section Operation. This section only describes the additional functions.

Related information

9. Operation

10.1 Electronic version stroke sensor

Pump type with inductive-proximity switch of two-wire design according to NAMUR DIN 19234 for signalling the strokes.

The sensor can be installed in potentially explosive atmospheres if PTB-approved isolating switching amplifiers with an intrinsically safe control circuit [EExia] or [EExib] are connected. The sensor can be used up to zone 1 depending on the isolating amplifier. The specifications in the declaration of conformity for the isolating amplifier must be observed.

Supply voltage U_B : 7.7 to 10 V.

10.2 Electronic diaphragm leakage sensor

10.2.1 Technical data

Model 230 V (+10 % / -10 %)

Model 115 V (+10 % / -10 %)

- Contact load: 250 V / 6 A, max. 550 VA
- Power consumption: 1.15 VA
- Enclosure class: IP65
- Permissible temperature range: 0 °C to +40 °C.

10.2.2 Dimensional sketch (electronics enclosure)

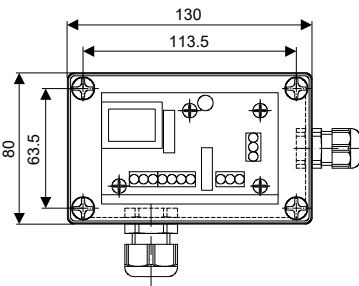

Electronics enclosure

10.2.3 Function

Pumps prepared for diaphragm leakage detection:

- Special dosing head flange for inserting the optoelectronic sensor
- The optoelectronic sensor contains
 - infrared sender
 - infrared receiver.

In case of a leaking diaphragm

- The dosing liquid penetrates the dosing head flange.
 - The light refraction will be changed.
- The sensor produces a signal.
 - The electronics switches two contacts. These contacts can for instance be used to trigger an alarm device or to switch off the pump.

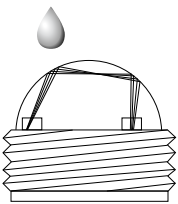

Diaphragm leakage sensor

10.2.4 Electrical connection of the electronics

Warning

Electrical connections must only be carried out by qualified personnel!



Disconnect the power supply before connecting the power supply cable and the relay contacts!

Observe the local safety regulations!

Protect the cable connections and plugs from corrosion and moisture.

Before connecting the power supply cable, check that the supply voltage stated on the pump nameplate corresponds to the local electricity supply. An incorrect power supply could destroy the unit!

Caution

To ensure electromagnetic compatibility (EMC), the input cables and current output cables must be screened.

1. Connect the screen at one end to PE.
 - Refer to the connection diagram!
2. Route input cables, current output cables and power supply cables in separate ducts.
3. Connect the device to the power supply according to the connection diagram.
4. Connect the electronics with the sensor according to the connection diagram.

Warning



The potential-loaded contact 1, terminals 6 and 7, is loaded with supply voltage.

Switch off the power supply before connecting contact 1!

The contacts have no protective circuits.

Only pure ohmic loads may be switched.

Caution

For switching the pump motor, a contactor has to be connected inbetween.

5. Connect contacts 1 and 2 according to individual needs.

Related information

7. Electrical connections

TM03_6381_4506

TM036382

10.2.5 Relay outputs

Note The relay output connection depends on the application and the connected actuators.

- Interference suppression is required for inductive loads (also relays and contactors).
- If this is not possible, protect the relay contacts using a suppressor circuit as described below.

With AC voltage

| Current up to | Capacitor C | Resistor R |
|---------------|--------------------|--------------------|
| 60 mA | 10 μ F, 275 V | 390 Ω , 2 W |
| 70 mA | 47 μ F, 275 V | 22 Ω , 2 W |
| 150 mA | 100 μ F, 275 V | 47 Ω , 2 W |
| 1.0 A | 220 μ F, 275 V | 47 Ω , 2 W |

With DC voltage

- Connect the free-wheeling diode parallel to the relay or contactor.

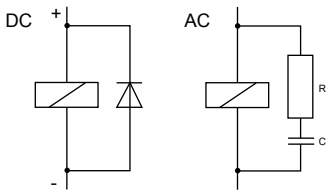

Suppressor circuit DC/AC

Caution Provide relay outputs on site with an appropriate back-up fuse!

Note These connections depend on the type of actuator used and should only be understood as guidelines. Refer to actuator documentation.

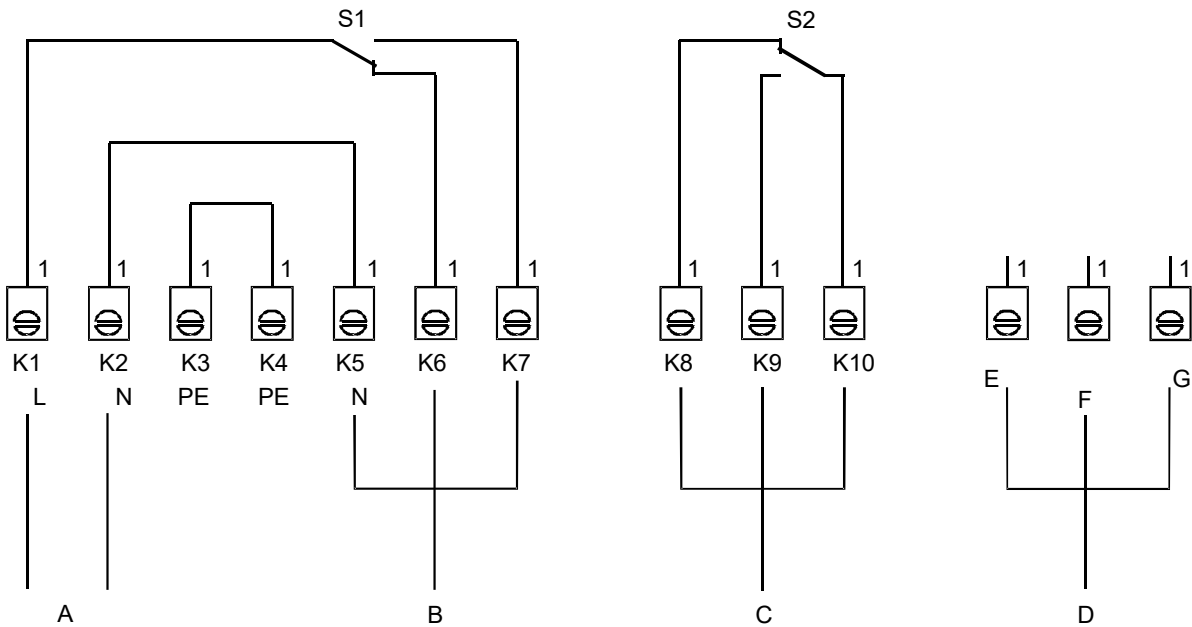

Electrical connection of the electronics

TM037209

TM077801

| Pos. | Description |
|------|--|
| A | 230 VAC / 115 VAC |
| B | Contact 1 (non floating 230 VAC / 115 VAC) |
| C | Contact 2 (floating) |
| D | Sensor |
| E | Green |
| F | Yellow |
| G | White |

10.2.6 Screwing the sensor into the dosing head

- Screw the sensor from the lower side into the hole of the dosing head flange (M14 x 1.5).
 - Now the diaphragm leakage sensor is ready for start-up.

10.2.7 Start-up

Caution Carry out a functional check before start-up!

Functional check

- Dip the sensor into water.
 - Green and red LEDs are on: Sensor and electronics are ready for operation!
 - One or more LEDs are off: Sensor or electronics is defective! Call Grundfos service.
- Carefully dry the sensor.
 - Only the green LED is still on: Sensor and electronics are ready for operation!
 - The red LED is still on: Sensor or electronics is defective! Call Grundfos service.



Warning

Do not open the electronics or sensor!

Repairs must only be carried out by authorised and qualified personnel!

10.2.8 Using the contacts

- Terminals 6 and 7 (potential-loaded)
 - for instance for switching off the pump in case of a diaphragm leakage.
- Terminals 8, 9 and 10 (potential-free)
 - for instance for triggering an alarm device.

10.2.9 Description of the device

There are a green and a red light-emitting diode (LED) at the electronics.

- Green LED
 - shows that the system is ready for operation.
 - The LED is only on when the sensor is connected to the electronics. If the LED is off in this case, either the sensor or the cable is defective or wrongly connected.
- Red LED
 - shows that a diaphragm leakage has been detected.
 - The green LED is still on.

10.2.10 Maintenance



Warning

Do not open the electronics or sensor!

Repairs must only be carried out by authorised and qualified personnel!

Sensor

Optoelectronic sensor with 3 metres cable.

- Clean the sensor in case of malfunction.
- If the sensor still does not operate correctly, replace it.

Electronics

- No maintenance is possible by the user.
- If the electronics does not operate correctly, call Grundfos service.

11. Integral relief valve

11.1 Function

If the pump is the only pump in the system, the integral relief valve (optional) protects the complete discharge side of the discharge line system from an excessive pressure build-up.

The valve opens if the pressure rises above its set opening pressure, and the dosing medium can return to the dosing tank.

In contrast to relief valves connected in series, the integral valve also provides pump protection if the discharge valve is dirty or blocked.

11.2 Permissible media



Warning

Dosing heads with integral relief valve must not be used for abrasive or crystallising media.

11.3 Connections

1. Connect the suction line to the suction valve (A).
2. Connect the discharge line to the discharge valve (B).
3. Connect the overflow line to the relief valve (C) and allow the medium to flow by gravity into the tank or to an appropriate overflow.

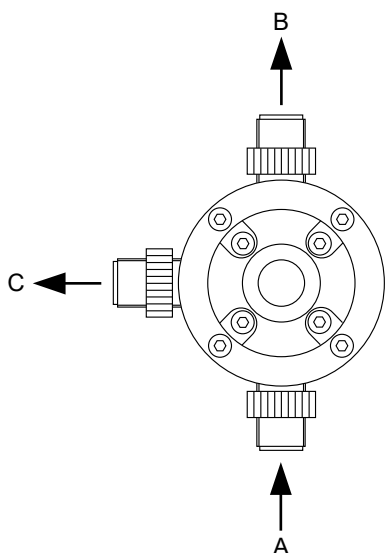

Connections



Warning

Never start the pump if the overflow line is not correctly connected to the relief valve.

11.4 Setting of opening pressure

11.4.1 General

The opening pressure can only be set if a pressure gauge is installed in the system between the pump and the next isolating valve or pressure-loading valve.



Warning

Settings on the relief valve must only be carried out by authorised and qualified personnel!

The opening pressure of the relief valve is factory-set to the maximum pump counterpressure specified in the technical data. The opening pressure during operation depends on various factors, e.g. the flow, the stroke frequency of the pump, or the counterpressure. If an exact setting is required, the relief valve must be adapted to the local conditions.



Warning

Never set the opening pressure to values higher than the maximum permissible operating pressure of the dosing system and dosing pump.



Warning

When dosing dangerous media, observe the corresponding safety precautions!

Wear protective clothing (gloves and goggles) when working on the dosing head, connections or lines!

11.4.2 Setting the valve opening pressure

To change the factory-set opening pressure, proceed as follows:

The pump must be running.

1. Remove the cap from the top part of the relief valve.
2. Close the isolating valve after the pressure gauge.
3. When overflowing of the dosing medium is heard, read the current opening pressure on the pressure gauge.

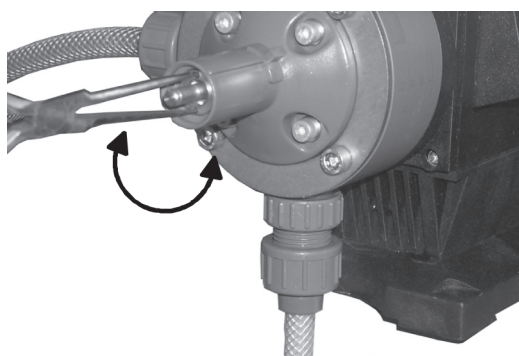

Setting of opening pressure

4. Change the pressure as follows:
 - To increase the pressure, turn the knob clockwise using pointed pliers until the desired opening pressure is reached.
 - To reduce the pressure, turn the knob counter-clockwise using pointed pliers until the desired opening pressure is reached.
5. Open the isolating valve after the pressure gauge.
6. Refit the cap.

TM036311

TM036312

11.5 Venting

The relief valve can also be opened manually, thus serving as a venting valve at the same time. If manual venting is required (e.g. during start-up or when the tank has been replaced), proceed as follows:

- Turn the knob so that the smaller cut-out rests on the nub of the dosing head (the rotary knob is then further away from the dosing head). The valve spring is unloaded (position B).
- Once the pump has been completely vented, turn the knob back into position A "Operating".

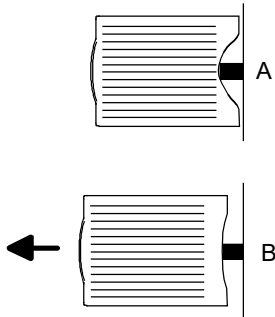

TMO36313

| Pos. | Description |
|------|-------------|
| A | Operating |
| B | Venting |

Knob position

11.6 Fault finding chart

| Fault | Cause | Remedy |
|---|---|--|
| Permanent output from the relief valve. | Discharge line blocked. | Check and possibly correct the discharge-side dosing system. |
| | Relief valve incorrectly set (too low). | Set the relief valve to a higher opening pressure. |
| | Diaphragm faulty. | Replace the diaphragm. |
| | Relief valve dirty. | Clean the relief valve. |

12. Maintenance

12.1 General notes

Warning

When dosing dangerous media, observe the corresponding safety precautions!



Risk of chemical burns!

Wear protective clothing (gloves and goggles) when working on the dosing head, connections or lines!

Do not allow any chemicals to leak from the pump. Collect and dispose of all chemicals correctly!

Warning

The pump housing must only be opened by personnel authorised by Grundfos!



Repairs must only be carried out by authorised and qualified personnel!

Switch off the pump and disconnect it from the power supply before carrying out maintenance work and repairs!

During transport, the deaeration opening must be closed with the screw plug!

Caution

Before start-up, replace the screw plug by the deaeration screw!

12.2 Cleaning and maintenance intervals

In the event of a diaphragm leakage, the dosing liquid may leak out of the hole in the intermediate flange between the pump and the dosing head. The parts inside the housing are protected from the dosing liquid for a short time (depending on the type of liquid) by the housing sealing. It is necessary to check regularly (daily) if liquid is leaking out of the intermediate flange. For maximum safety, we recommend the pump version with diaphragm leakage detection.

Caution

12.2.1 Changing the gear grease

Warning



The gear grease must only be changed by authorised and qualified personnel.

For this purpose, send the pump to Grundfos or an authorised service workshop.

To ensure trouble-free operation, it is recommended to have the gear grease changed after five years or after 20,000 operating hours.

12.2.2 Cleaning the diaphragm and valves

Clean the diaphragm and valves, and replace, if necessary (with stainless-steel valves: inner valve parts):

- At least every 12 months or after 4,000 operating hours. When operating with a counterpressure of 16 bar, every six months or after 2,000 operating hours.
- In the event of a fault.

12.3 Cleaning the suction and discharge valves

Caution If possible, rinse the dosing head, e.g. by supplying it with water.

If the pump loses capacity, clean the suction and discharge valves as follows:

1. Unscrew the valve.
2. Unscrew the screw part resp. valve seat with round pliers.
3. Clean all parts. Replace faulty parts by new ones.
4. Re-assemble the valve.
5. Replace the O-rings by new ones. Refit the valve. Observe the direction arrow on the valve.

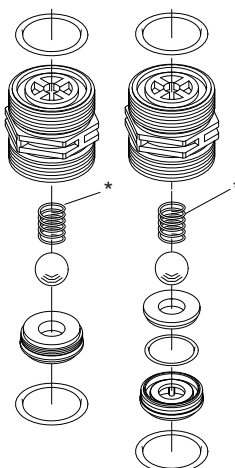

*Stainless-steel or plastic valve DN 20, * spring-loaded as an option*

Caution The O-rings must be correctly placed in the specified groove. Observe the flow direction (indicated by an arrow on the valve)!

TM036470

12.4 Maintenance of the relief valve

12.4.1 Cleaning and maintenance intervals

Clean the relief valve, and replace the diaphragm, if necessary.

- At least every 12 months or after 8,000 operating hours.
- In the event of a fault.

12.4.2 Replacing the diaphragm of the relief valve

1. Switch off the pump and disconnect it from the power supply.
2. Make it impossible for a return flow or overpressure to occur.
3. Loosen the four screws on the top part of the relief valve.
4. Remove the top part of the relief valve.
5. Remove the diaphragm.
6. Insert a new diaphragm.
7. Refit the top part of the relief valve and cross-tighten the screws.
Maximum torque: 6 Nm.
8. Start up the dosing system.
9. Tighten the screws on the top part of the relief valve after 48 operating hours.
Maximum torque: 6 Nm.

12.5 Replacing the diaphragm

Caution Adjust the stroke length only while the pump is running!

Caution During transport, the deaeration opening must be closed with the screw plug!

Note If possible, rinse the dosing head, e.g. by supplying it with water.

12.5.1 Switching off the pump

1. While the pump is running, set the stroke-length adjustment knob to 100 %.
2. Switch off the pump and disconnect it from the power supply.
3. Depressurise the system.
4. Take suitable steps to ensure that the returning dosing medium is safely collected.

12.5.2 Replacing the diaphragm

1. Loosen the six dosing head screws.
2. Remove the dosing head.
3. Turn the fan blades until the diaphragm reaches the front dead centre (the diaphragm detaches itself from the diaphragm flange).
4. Unscrew the diaphragm by manually turning it counter-clockwise.
5. Check the parts and replace by new ones, if necessary.
6. Screw in the new diaphragm completely. Then turn it back until the holes in the diaphragm and the flange coincide.
7. Turn the fan blades until the diaphragm reaches the bottom dead centre (the diaphragm is pulled onto the diaphragm flange).
8. Refit the dosing head carefully and cross-tighten the screws.
Maximum torque: 6 Nm.
9. Deaerate and start the dosing pump.

Caution Before start-up, replace the screw plug by the deaeration screw!

After initial start-up and after each time the diaphragm is changed, tighten the dosing head screws.

Caution After approximately 6-10 operating hours or two days, cross-tighten the dosing head screws using a torque wrench.

Maximum torque: 6 Nm.

13. Fault finding chart

Caution For further error signals for the control unit, refer to the relevant section.

13.1 Dosing pump does not run.

| Cause | Remedy |
|--|---------------------------------|
| Not connected to the power supply. | Connect the power supply cable. |
| Incorrect supply voltage. | Replace the dosing pump. |
| Electrical failure. | Return the pump for repair. |
| The empty indication has responded. | Remove the cause. |
| The diaphragm leakage detection has responded. | Replace the diaphragm. |

13.2 Dosing pump does not suck in.

| Cause | Remedy |
|---|---|
| Leaking suction line. | Replace or seal the suction line. |
| Cross-section of the suction line too small or suction line too long. | Check with Grundfos specification. |
| Clogged suction line. | Rinse or replace the suction line. |
| Foot valve covered by sediment. | Suspend the suction line from a higher position. |
| Buckled suction line. | Install the suction line correctly. Check for damage. |
| Crystalline deposits in the valves. | Clean the valves. |
| Diaphragm broken or diaphragm tappet torn out. | Replace the diaphragm. |

13.3 Dosing pump does not dose.

| Cause | Remedy |
|---|--|
| Air in the suction line and dosing head. | Wait until the pump has deaerated. |
| Stroke-length adjustment knob set to zero. | Turn the adjustment knob in the "+" direction. |
| Viscosity or density of medium too high. | Check the installation. |
| Crystalline deposits in the valves. | Clean the valves. |
| Valves not correctly assembled. | Assemble the inner valve parts in the right order and check and possibly correct the flow direction. |
| Injection point blocked. | Check and possibly correct the flow direction (injection unit), or remove the obstruction. |
| Incorrect installation of lines and peripheral equipment. | Check the lines for free passage and correct installation. |

13.4 Dosing flow of the pump is inaccurate.

| Cause | Remedy |
|---|---|
| Dosing head not fully deaerated. | Repeat the deaeration. |
| Degassing medium. | Check the installation. |
| Parts of the valves covered in dirt or incrusted. | Clean the valves. |
| Zero point misadjusted. | Adjust the zero point to the actual counterpressure. |
| Counterpressure fluctuations. | Install a pressure-loading valve and a pulsation damper. |
| Suction height fluctuations. | Keep the suction level constant. |
| Siphon effect (inlet pressure higher than counterpressure). | Install a pressure-loading valve. |
| Leaking or porous suction line or discharge line. | Replace the suction line or discharge line. |
| Parts in contact with the medium are not resistant to it. | Replace with resistant materials. |
| Dosing diaphragm worn (incipient tears). | Replace the diaphragm. Also observe the maintenance instructions. |
| Supply voltage fluctuations. | Decrease the counterpressure of the pump. |
| Variation of the dosing medium (density, viscosity). | Check the concentration. Use an agitator, if necessary. |

14. Dosing curves

The dosing curves in the appendix are trend curves. See appendix: Dosing curves

They apply to:

- performance of single pump (the flow rate is doubled for the double pump),
- water as dosing medium,
- zero point of pump Q_0 for specified pressure, see table below,
- standard pump version.

| Abbreviation | Description |
|--------------|---|
| Q | Dosing flow |
| Q_0 | Zero point of the pump The pumps are calibrated so that Q is 0 at 3 bar. |
| h | Stroke length |

Related information

[A.1. Dosing curves](#)

15. Disposing of the product

This product or parts of it must be disposed of in an environmentally sound way.

1. Use the public or private waste collection service.
2. If this is not possible, contact the nearest Grundfos company or service workshop.



The crossed-out wheellie bin symbol on a product means that it must be disposed of separately from household waste. When a product marked with this symbol reaches its end of life, take it to a collection point designated by the local waste disposal authorities. The separate collection and recycling of such products will help protect the environment and human health.

See also end-of-life information at www.grundfos.com/product-recycling.

A.1. Dosing curves

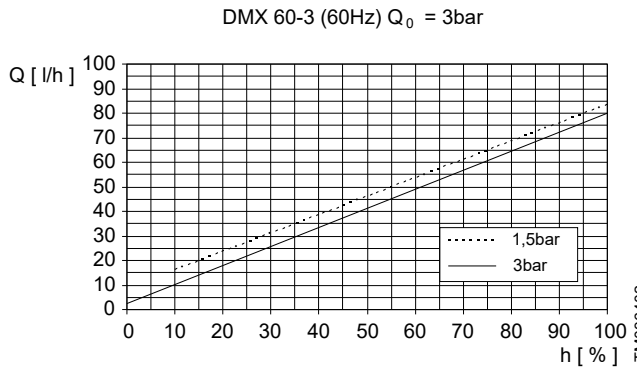
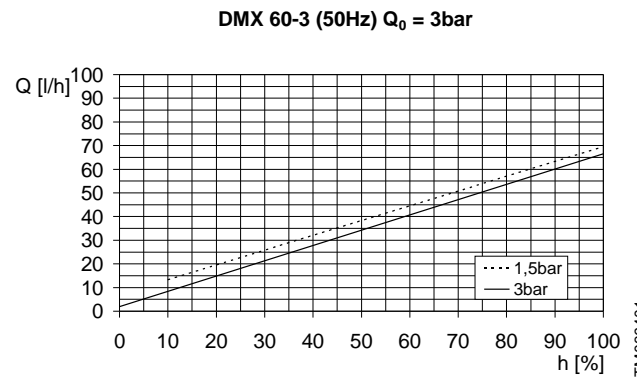
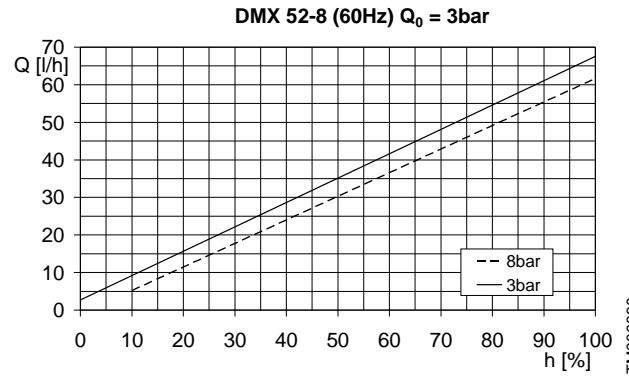
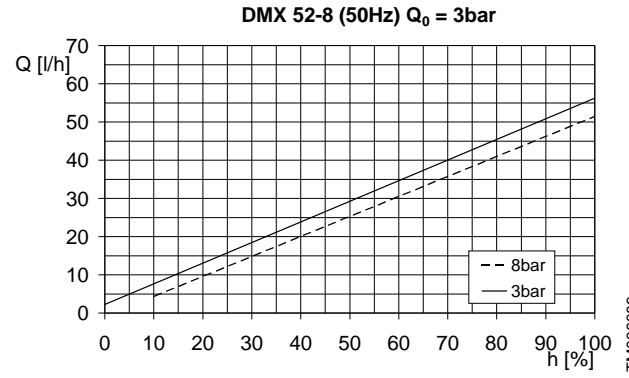
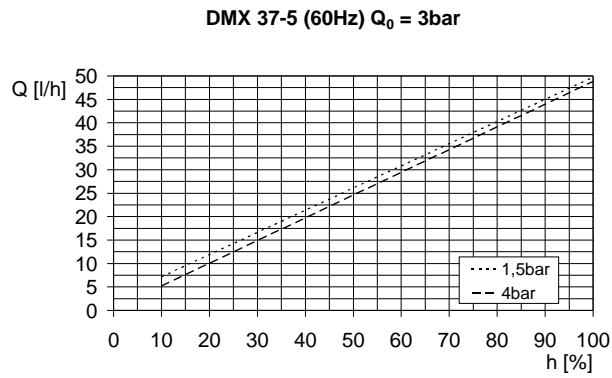
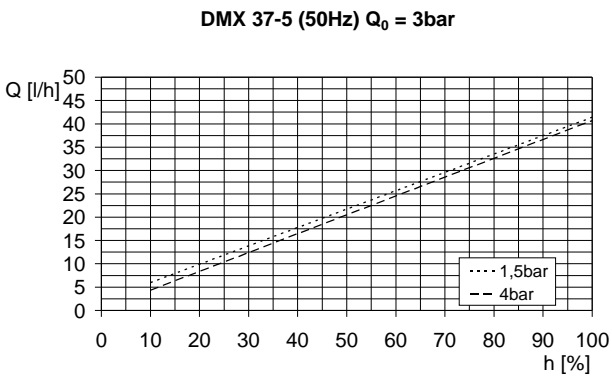
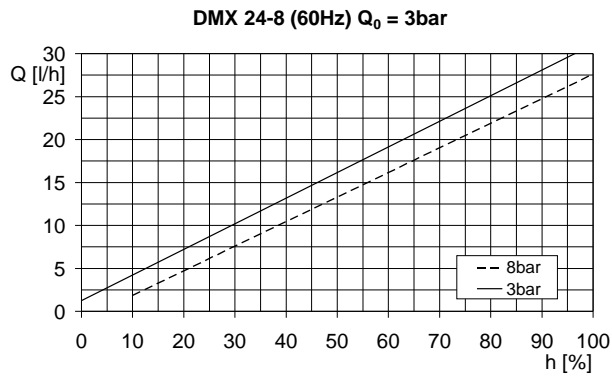
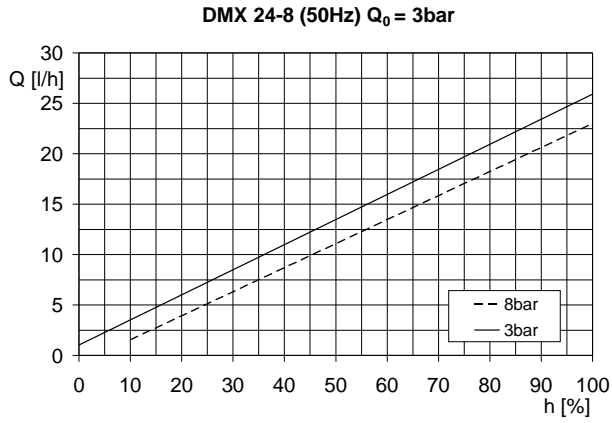

DMX 67-10 (50Hz) $Q_0 = 3\text{bar}$

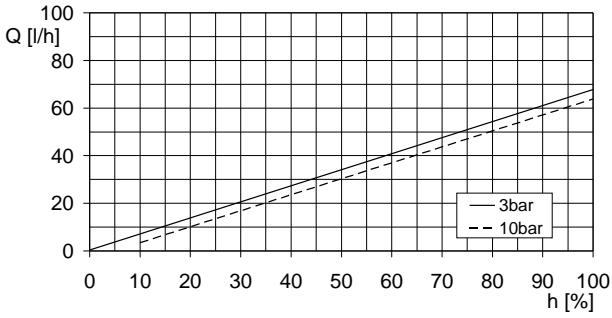

TM036408

DMX 95-8 (60Hz) $Q_0 = 3\text{bar}$

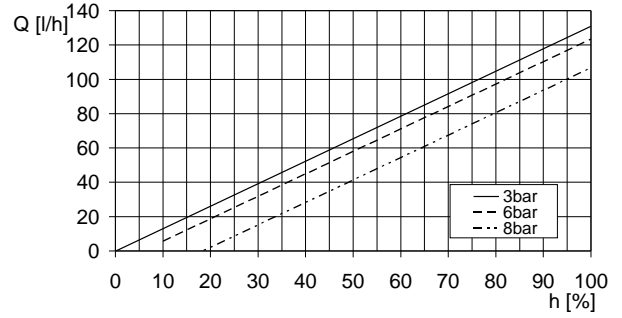

TM036415

DMX 67-10 (60Hz) $Q_0 = 3\text{bar}$

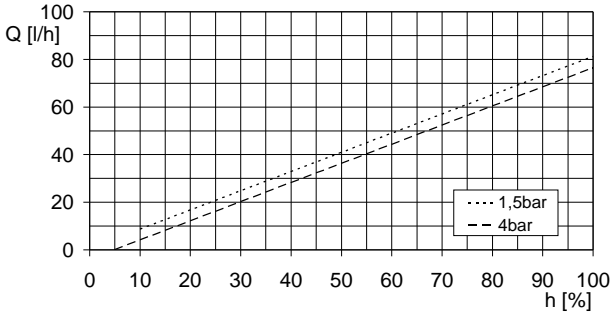

TM036409

DMX 100-8 (50Hz) $Q_0 = 3\text{bar}$

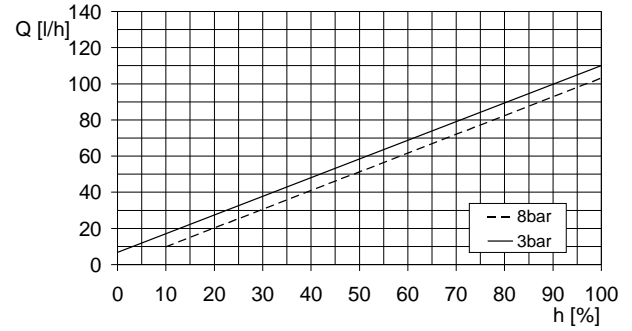

TM036391

DMX 82-5 (50Hz) $Q_0 = 3\text{bar}$

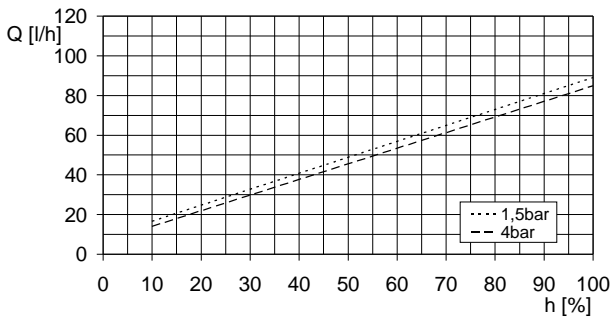

TM036396

DMX 100-8 (60Hz) $Q_0 = 3\text{bar}$

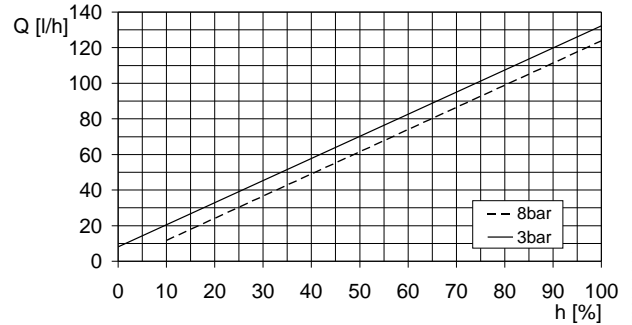

TM036392

DMX 82-5 (60Hz) $Q_0 = 3\text{bar}$

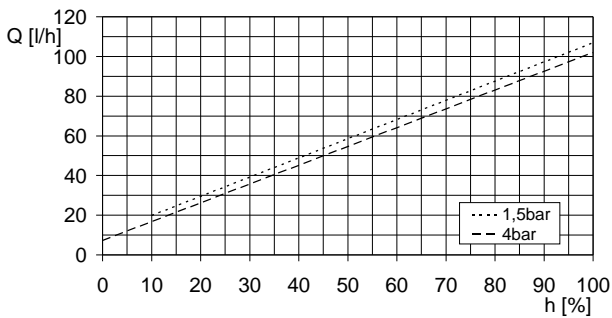

TM036397

DMX 130-3 (50Hz) $Q_0 = 3\text{bar}$

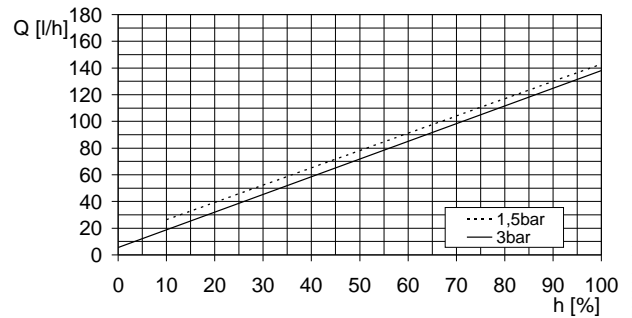

TM036403

DMX 95-8 (50Hz) $Q_0 = 3\text{bar}$

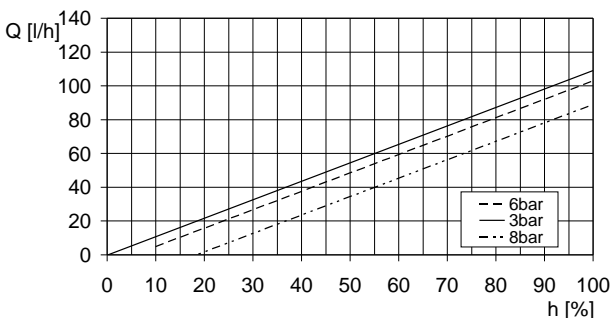

TM036414

DMX 130-3 (60Hz) $Q_0 = 3\text{bar}$

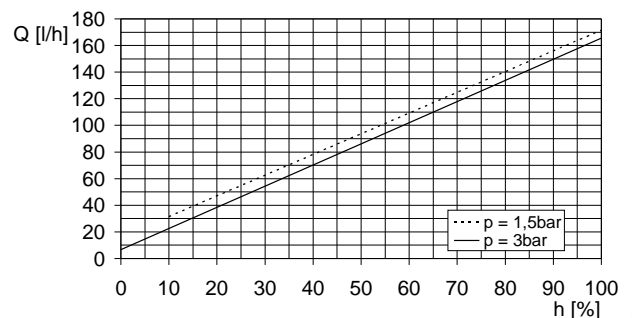

TM036404

DMX 132-10 (50Hz) $Q_0 = 3\text{bar}$

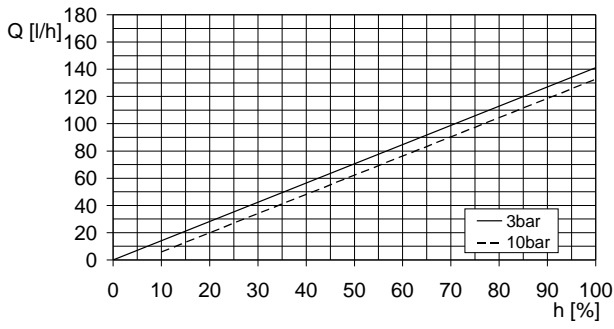

DMX 160-5 (50Hz) $Q_0 = 3\text{bar}$

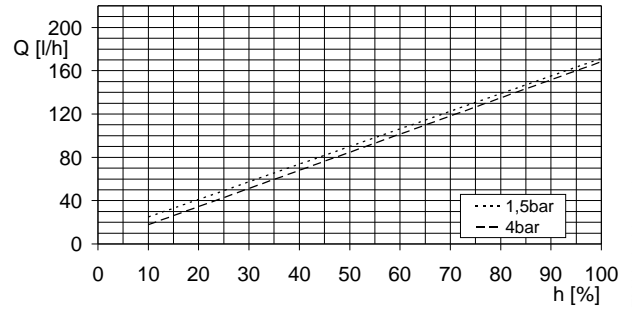

DMX 132-10 (60Hz) $Q_0 = 3\text{bar}$

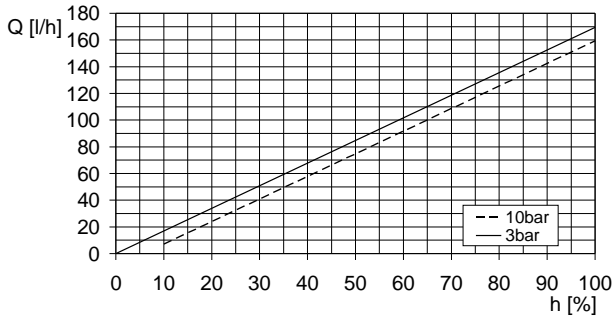

DMX 160-5 (60Hz) $Q_0 = 3\text{bar}$

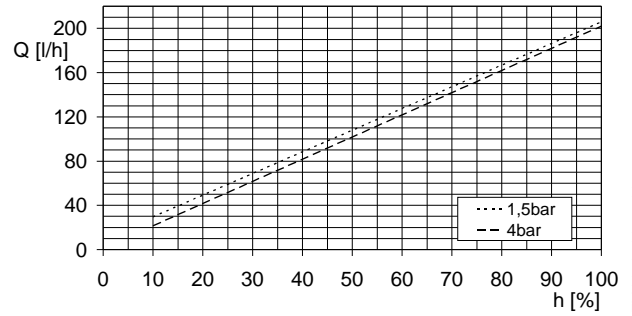

DMX 142-8 (50Hz) $Q_0 = 3\text{bar}$

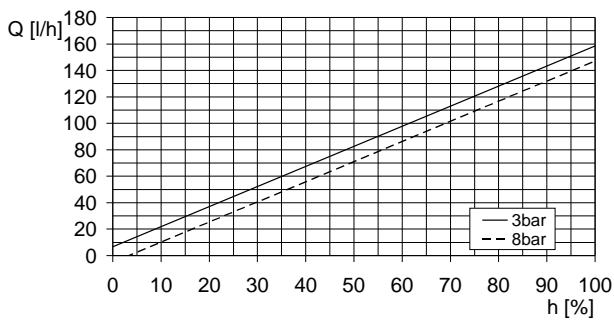

DMX 190-8 (50Hz) $Q_0 = 3\text{bar}$

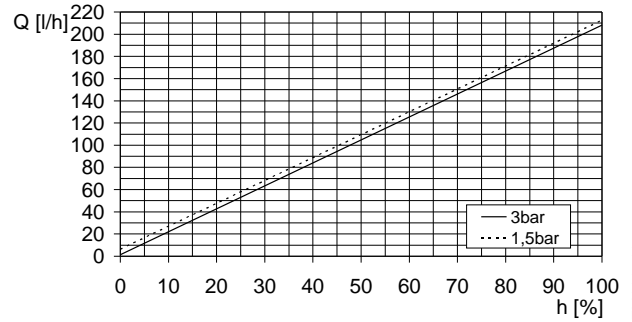

DMX 152-6 (50Hz) $Q_0 = 3\text{bar}$

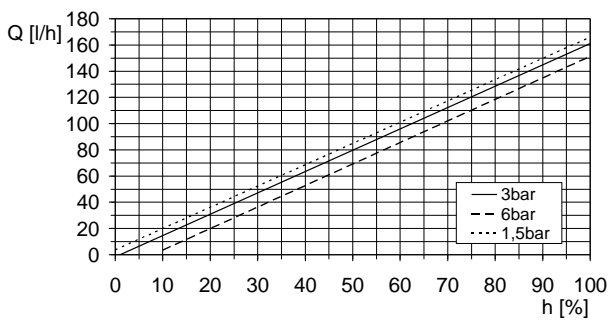

DMX 190-10 (50Hz) $Q_0 = 3\text{bar}$

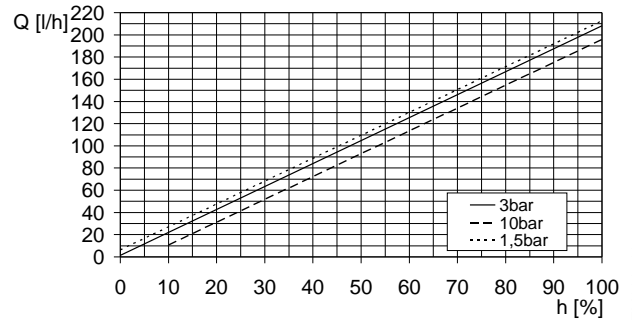

DMX 152-6 (60Hz) $Q_0 = 3\text{bar}$

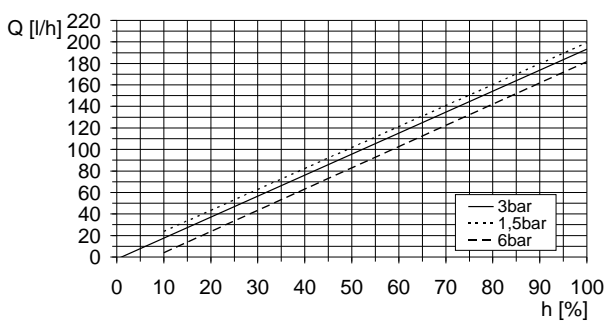

DMX 199-8 (50Hz) $Q_0 = 3\text{bar}$

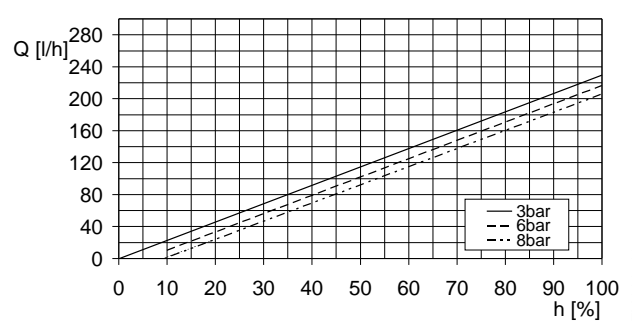

DMX 199-8 (60Hz) $Q_0 = 3\text{bar}$

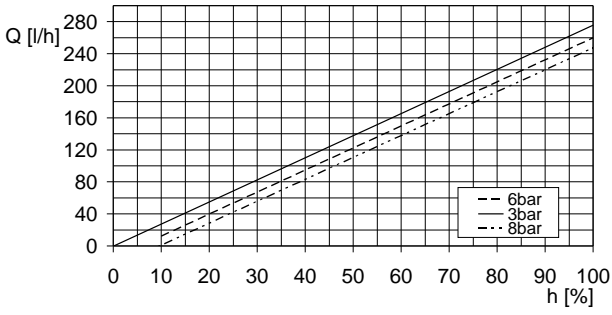

DMX 255-3 (60Hz) $Q_0 = 3\text{bar}$

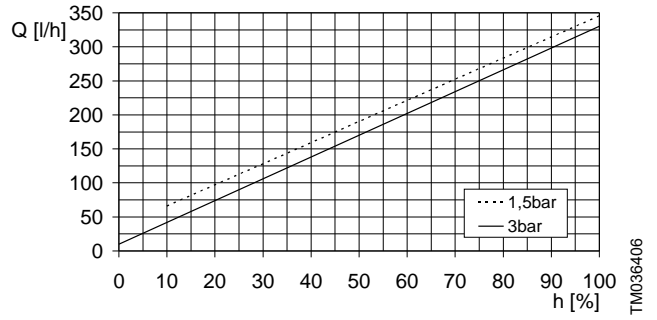

DMX 224-5 (50Hz) $Q_0 = 3\text{bar}$

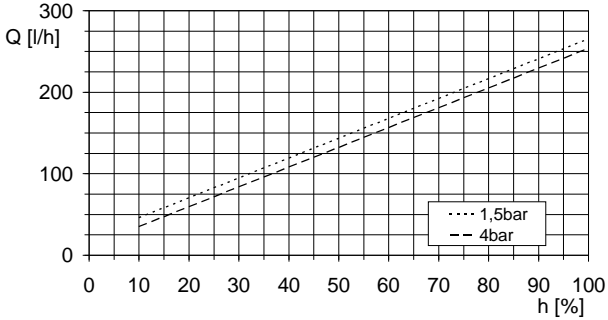

DMX 280-6 (50Hz) $Q_0 = 3\text{bar}$

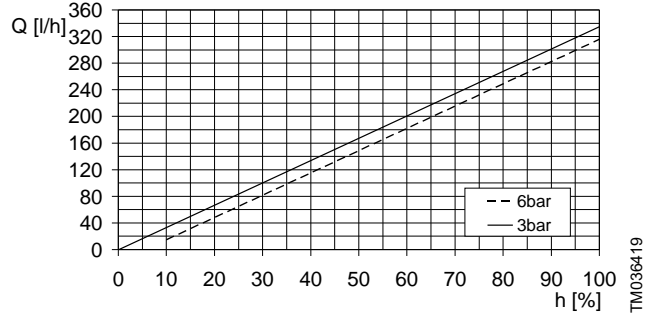

DMX 249-3 (50Hz) $Q_0 = 3\text{bar}$

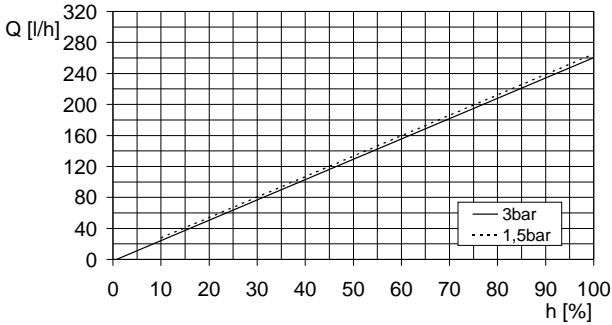

DMX 280-8 (50Hz) $Q_0 = 3\text{bar}$

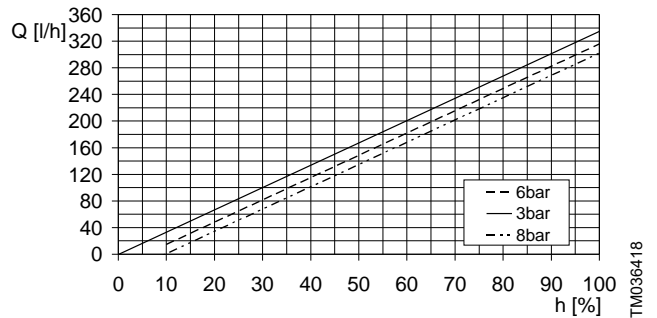

DMX 249-3 (60Hz) $Q_0 = 3\text{bar}$

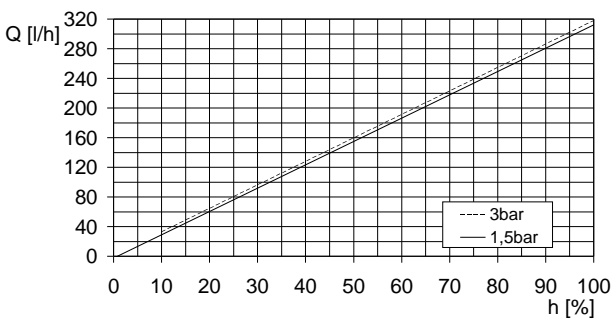

DMX 315-3 (50Hz) $Q_0 = 3\text{bar}$

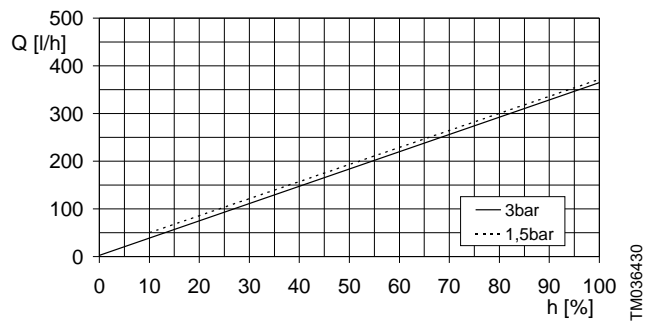

DMX 255-3 (50Hz) $Q_0 = 3\text{bar}$

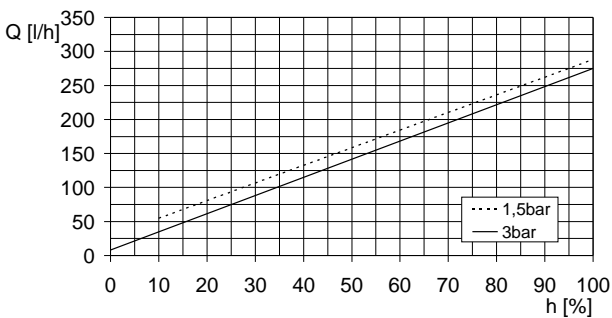

DMX 315-3 (60Hz) $Q_0 = 3\text{bar}$

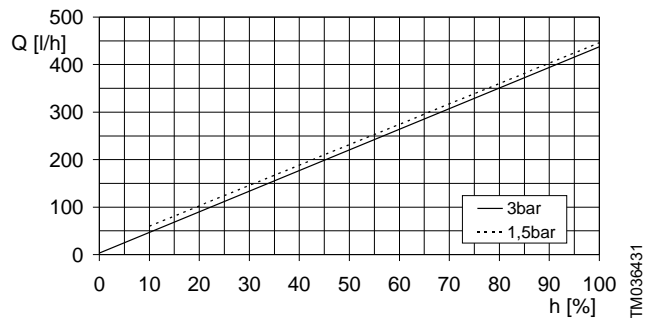

DMX 321-4 (50Hz) $Q_0 = 3\text{bar}$

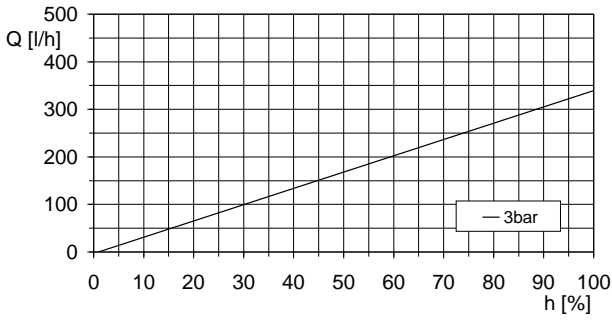

DMX 460-3,5 (50Hz) $Q_0 = 3\text{bar}$

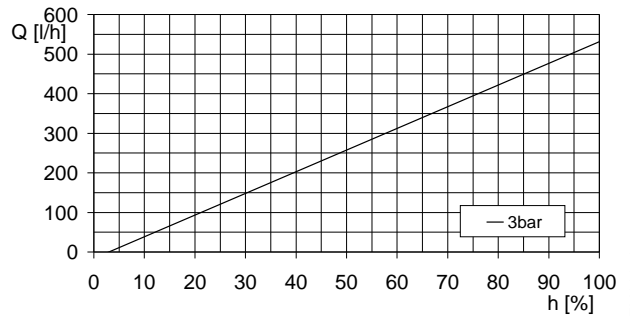

DMX 321-4 (60Hz) $Q_0 = 3\text{bar}$

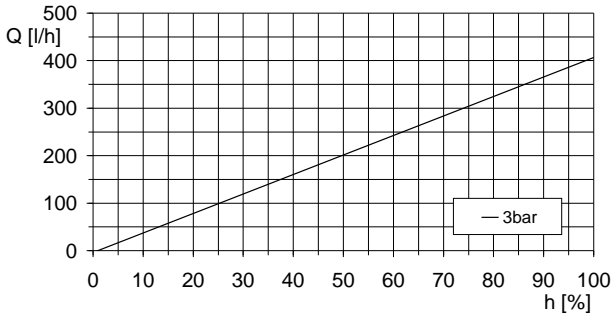

DMX 460-6 (50Hz) $Q_0 = 3\text{bar}$

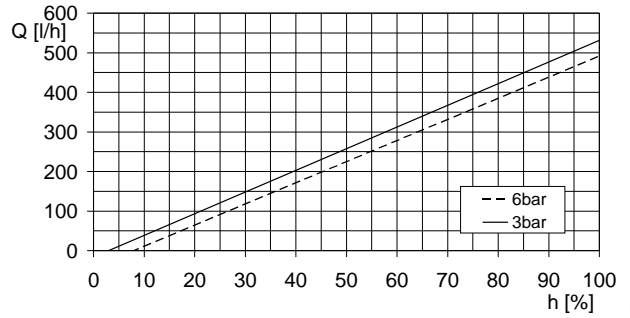

DMX 321-6 (50Hz) $Q_0 = 3\text{bar}$

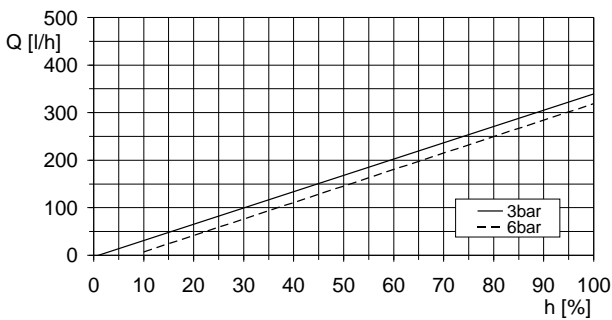

DMX 525-3 (50Hz) $Q_0 = 3\text{bar}$

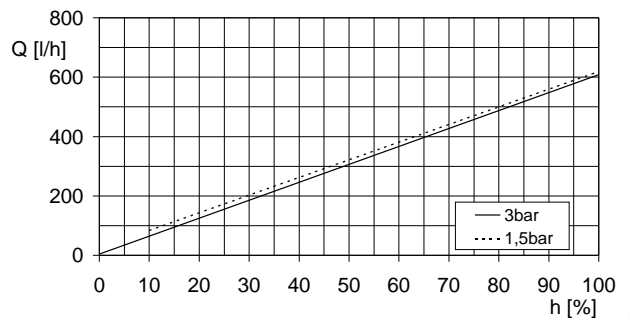

DMX 321-6 (60Hz) $Q_0 = 3\text{bar}$

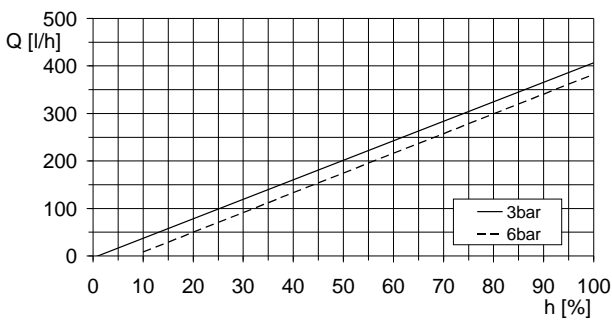

DMX 525-3 (60Hz) $Q_0 = 3\text{bar}$

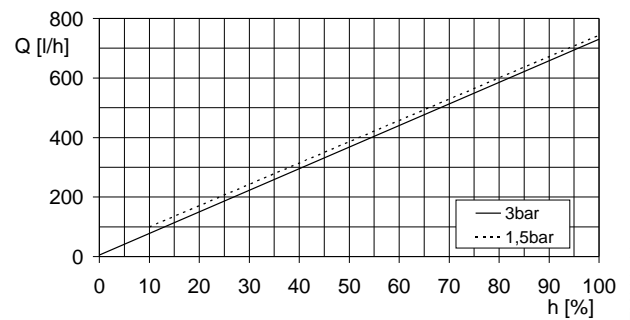

DMX 380-3 (50Hz) $Q_0 = 3\text{bar}$

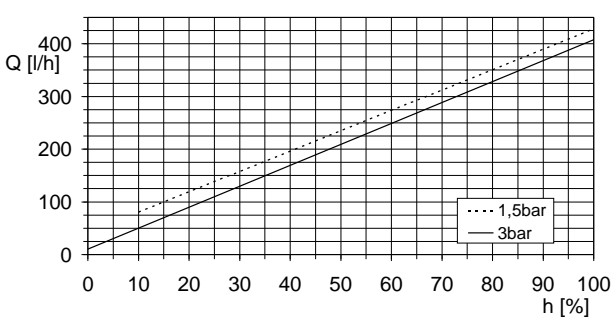

DMX 765-3 (50Hz) $Q_0 = 3\text{bar}$

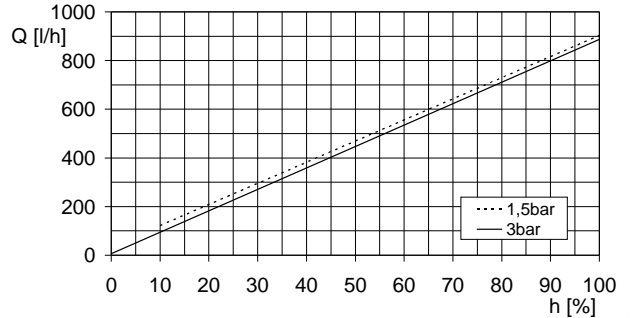

Appendix B

B.1. Safety declaration

- Please copy, fill in and sign this sheet and attach it to the product returned for service.
- Fill in this document using English or German language.

Fault description

- Please make a circle around the damaged part.
- In the case of an electrical or functional fault, please mark the cabinet.
- Please give a short description of the fault and indicate if the diaphragm is damaged:



TM074682

Declaration

We hereby declare that this product is free from hazardous chemicals, biological and radioactive substances:

| |
|-----------------------------------|
| Type designation (see nameplate): |
|-----------------------------------|

| |
|-----------------|
| Product number: |
|-----------------|

The product was used with the following dosing medium:

| |
|----------------------------|
| No dosing medium or water: |
|----------------------------|

| |
|----------------------------|
| A chemical solution, name: |
|----------------------------|

| |
|---------------------|
| Date and signature: |
|---------------------|

Company stamp:

- Argentina**
Bombas GRUNDFOS de Argentina S.A.
Ruta Panamericana km. 37.500 Industiun
1619 - Garin Pcia. de B.A.
Tel.: +54-3327 414 444
Fax: +54-3327 45 3190
- Australia**
GRUNDFOS Pumps Pty. Ltd.
P.O. Box 2040
Regency Park
South Australia 5942
Tel.: +61-8-8461-4611
Fax: +61-8-8340-0155
- Austria**
GRUNDFOS Pumpen Vertrieb Ges.m.b.H.
Grundfosstraße 2
A-5082 Grödig/Salzburg
Tel.: +43-6246-883-0
Fax: +43-6246-883-30
- Belgium**
N.V. GRUNDFOS Bellux S.A.
Boomsesteenweg 81-83
B-2630 Aartselaar
Tel.: +32-3-870 7300
Fax: +32-3-870 7301
- Belarus**
Представительство ГРУНДФОС в Минске
220125, Минск
ул. Шафарьянская, 11, оф. 56, БЦ «Порт»
Tel.: +375 17 397 397 3
+375 17 397 397 4
Факс: +375 17 397 397 1
E-mail: minsk@grundfos.com
- Bosnia and Herzegovina**
GRUNDFOS Sarajevo
Zmaj od Bosne 7-7A
BiH-71000 Sarajevo
Tel.: +387 33 592 480
Fax: +387 33 590 465
www.ba.grundfos.com
E-mail: grundfos@bih.net.ba
- Brazil**
BOMBAS GRUNDFOS DO BRASIL
Av. Humberto de Alencar Castelo Branco,
630
CEP 09850 - 300
São Bernardo do Campo - SP
Tel.: +55-11 4393 5533
Fax: +55-11 4343 5015
- Bulgaria**
Grundfos Bulgaria EOOD
Slatina District
Iztochna Tangenta street no. 100
BG - 1592 Sofia
Tel.: +359 2 49 22 200
Fax: +359 2 49 22 201
E-mail: bulgaria@grundfos.bg
- Canada**
GRUNDFOS Canada inc.
2941 Brighton Road
Oakville, Ontario
L6H 6C9
Tel.: +1-905 829 9533
Fax: +1-905 829 9512
- China**
GRUNDFOS Pumps (Shanghai) Co. Ltd.
10F The Hub, No. 33 Suhong Road
Minhang District
Shanghai 201106 PRC
Tel.: +86 21 612 252 22
Fax: +86 21 612 253 33
- Columbia**
GRUNDFOS Colombia S.A.S.
Km 1.5 vía Siberia-Cota Conj. Potrero
Chico,
Parque Empresarial Arcos de Cota Bod. 1.A.
Cota, Cundinamarca
Tel.: +57(1)-2913444
Fax: +57(1)-8764586
- Croatia**
GRUNDFOS CROATIA d.o.o.
Buzinski prilaz 38, Buzin
HR-10010 Zagreb
Tel.: +385 1 6595 400
Fax: +385 1 6595 499
www.hr.grundfos.com
- Czech Republic**
GRUNDFOS Sales Czechia and Slovakia
s.r.o.
Čajkovského 21
779 00 Olomouc
Tel.: +420-585-716 111
- Denmark**
GRUNDFOS DK A/S
Martin Bachs Vej 3
DK-8850 Bjerringbro
Tel.: +45-87 50 50 50
Fax: +45-87 50 51 51
E-mail: info_GDK@grundfos.com
www.grundfos.com/DK
- Estonia**
GRUNDFOS Pumps Eesti OÜ
Peterburi tee 92G
11415 Tallinn
Tel.: + 372 606 1690
Fax: + 372 606 1691
- Finland**
OY GRUNDFOS Pumput AB
Trukkikuja 1
FI-01360 Vantaa
Tel.: +358-(0) 207 889 500
- France**
Pompes GRUNDFOS Distribution S.A.
Parc d'Activités de Chesnes
57, rue de Malacombe
F-38290 St. Quentin Fallavier (Lyon)
Tel.: +33-4 74 82 15 15
Fax: +33-4 74 94 10 51
- Germany**
GRUNDFOS GMBH
Schlüterstr. 33
40699 Erkrath
Tel.: +49-(0) 211 929 69-0
Fax: +49-(0) 211 929 69-3799
E-mail: infoservice@grundfos.de
Service in Deutschland:
kundendienst@grundfos.de
- Greece**
GRUNDFOS Hellas A.E.B.E.
20th km. Athinon-Markopoulou Av.
P.O. Box 71
GR-19002 Peania
Tel.: +0030-210-66 83 400
Fax: +0030-210-66 46 273
- Hong Kong**
GRUNDFOS Pumps (Hong Kong) Ltd.
Unit 1, Ground floor, Siu Wai industrial
Centre
29-33 Wing Hong Street & 68 King Lam
Street, Cheung Sha Wan
Kowloon
Tel.: +852-27861706 / 27861741
Fax: +852-27858664
- Hungary**
GRUNDFOS Hungária Kft.
Tópark u. 8
H-2045 Törökbálint
Tel.: +36-23 511 110
Fax: +36-23 511 111
- India**
GRUNDFOS Pumps india Private Limited
118 Old Mahabalipuram Road
Thoraiakkam
Chennai 600 097
Tel.: +91-44 2496 6800
- Indonesia**
PT GRUNDFOS Pompa
Graha intirub Lt. 2 & 3
Jin. Cillitan Besar No.454. Makasar,
Jakarta Timur
ID-Jakarta 13650
Tel.: +62 21-469-51900
Fax: +62 21-460 6910 / 460 6901
- Ireland**
GRUNDFOS (Ireland) Ltd.
Unit A, Merrywell Business Park
Ballymount Road Lower
Dublin 12
Tel.: +353-1-4089 800
Fax: +353-1-4089 830
- Italy**
GRUNDFOS Pompe Italia S.r.l.
Via Gran Sasso 4
I-20060 Truccazzano (Milano)
Tel.: +39-02-95838112
Fax: +39-02-95309290 / 95838461
- Japan**
GRUNDFOS Pumps K.K.
1-2-3, Shin-Miyakoda, Kita-ku
Hamamatsu
431-2103 Japan
Tel.: +81 53 428 4760
Fax: +81 53 428 5005
- Korea**
GRUNDFOS Pumps Korea Ltd.
6th Floor, Aju Building 679-5
Yeoksam-dong, Kangnam-ku, 135-916
Seoul, Korea
Tel.: +82-2-5317 600
Fax: +82-2-5633 725
- Latvia**
SIA GRUNDFOS Pumps Latvia
Deglava biznesa centrs
Augusta Deglava ielā 60
LV-1035, Rīga,
Tel.: + 371 714 9640, 7 149 641
Fax: + 371 914 9646
- Lithuania**
GRUNDFOS Pumps UAB
Smolensko g. 6
LT-03201 Vilnius
Tel.: + 370 52 395 430
Fax: + 370 52 395 431
- Malaysia**
GRUNDFOS Pumps Sdn. Bhd.
7 Jalan Peguam U1/25
Glenmarie industrial Park
40150 Shah Alam, Selangor
Tel.: +60-3-5569 2922
Fax: +60-3-5569 2866
- Mexico**
Bombas GRUNDFOS de México
S.A. de C.V.
Boulevard TLC No. 15
Parque industrial Stiva Aeropuerto
Apodaca, N.L. 66600
Tel.: +52-81-8144 4000
Fax: +52-81-8144 4010
- Netherlands**
GRUNDFOS Netherlands
Veluwezoom 35
1326 AE Almere
Postbus 22015
1302 CA ALMERE
Tel.: +31-88-478 6336
Fax: +31-88-478 6332
E-mail: info_gnl@grundfos.com
- New Zealand**
GRUNDFOS Pumps NZ Ltd.
17 Beatrice Tinsley Crescent
North Harbour Industrial Estate
Albany, Auckland
Tel.: +64-9-415 3240
Fax: +64-9-415 3250
- Norway**
GRUNDFOS Pumper A/S
Stramsveien 344
Postboks 235, Leirdal
N-1011 Oslo
Tel.: +47-22 90 47 00
Fax: +47-22 32 21 50
- Poland**
GRUNDFOS Pompy Sp. z o.o.
ul. Klonowa 23
Baranowo k. Poznania
PL-62-081 Przemierowo
Tel.: (+48-61) 650 13 00
Fax: (+48-61) 650 13 50
- Portugal**
Bombas GRUNDFOS Portugal, S.A.
Rua Calvet de Magalhães, 241
Apartado 1079
P-2770-153 Paço de Arcos
Tel.: +351-21-440 76 00
Fax: +351-21-440 76 90
- Romania**
GRUNDFOS Pompe România SRL
S-PARK BUSINESS CENTER, Clădirea
A2, etaj 2
Str. Tipografilor, Nr. 11-15, Sector 1, Cod
013714
Bucuresti, Romania
Tel.: 004 021 2004 100
E-mail: romania@grundfos.ro
- Russia**
ООО Грундфос Россия
ул. Школьная, 39-41
Москва, RU-109544, Russia
Тел. (+7) 495 564-88-00 (495) 737-30-00
Факс (+7) 495 564 8811
E-mail grundfos.moscow@grundfos.com
- Serbia**
Grundfos Srbija d.o.o.
Omladinskih brigada 90b
11070 Novi Beograd
Tel.: +381 11 2258 740
Fax: +381 11 2281 769
www.rs.grundfos.com
- Singapore**
GRUNDFOS (Singapore) Pte. Ltd.
25 Jalan Tukang
Singapore 619264
Tel.: +65-6681 9688
Fax: +65-6681 9689
- Slovakia**
GRUNDFOS s.r.o.
Prievozská 4D 821 09 BRATISLAVA
Tel.: +421 2 5020 1426
sk.grundfos.com
- Slovenia**
GRUNDFOS LJUBLJANA, d.o.o.
Leskoškova 9e, 1122 Ljubljana
Tel.: +386 (0) 1 568 06 10
Fax: +386 (0) 1 568 06 19
E-mail: tehnika-si@grundfos.com
- South Africa**
GRUNDFOS (PTY) LTD
16 Lascelles Drive, Meadowbrook Estate
1609 Germiston, Johannesburg
Tel.: (+27) 10 248 6000
Fax: (+27) 10 248 6002
E-mail: lgradidge@grundfos.com
- Spain**
Bombas GRUNDFOS España S.A.
Camino de la Fuentequilla, s/n
E-28110 Algete (Madrid)
Tel.: +34-91-848 8800
Fax: +34-91-628 0465
- Sweden**
GRUNDFOS AB
Box 333 (Lunnagårdsgatan 6)
431 24 Mölndal
Tel.: +46 31 332 23 000
Fax: +46 31 331 94 60
- Switzerland**
GRUNDFOS Pumpen AG
Bruggacherstrasse 10
CH-8117 Fällanden/ZH
Tel.: +41-44-806 8111
Fax: +41-44-806 8115
- Taiwan**
GRUNDFOS Pumps (Taiwan) Ltd.
7 Floor, 219 Min-Chuan Road
Taichung, Taiwan, R.O.C.
Tel.: +886-4-2305 0868
Fax: +886-4-2305 0878
- Thailand**
GRUNDFOS (Thailand) Ltd.
92 Chaloem Phrakiat Rama 9 Road
Dokmai, Pravej, Bangkok 10250
Tel.: +66-2-725 8999
Fax: +66-2-725 8998
- Turkey**
GRUNDFOS POMPA San. ve Tic. Ltd. Sti.
Gebze Organize Sanayi Bölgesi
Ihsan dede Caddesi
2. yol 200. Sokak No. 204
41490 Gebze/ Kocaeli
Tel.: +90 - 262-679 7979
Fax: +90 - 262-679 7905
E-mail: satis@grundfos.com
- Ukraine**
ТОВ "ГРУНДФОС УКРАЇНА"
Бізнес Центр Європа
Столицьне шосе, 103
м. Київ, 03131, Україна
Tel.: (+38 044) 237 04 00
Fax: (+38 044) 237 04 01
E-mail: ukraine@grundfos.com
- United Arab Emirates**
GRUNDFOS Gulf Distribution
P.O. Box 16768
Jebel Ali Free Zone, Dubai
Tel.: +971 4 8815 166
Fax: +971 4 8815 136
- United Kingdom**
GRUNDFOS Pumps Ltd.
Grovebury Road
Leighton Buzzard/Beds. LU7 4TL
Tel.: +44-1525-850000
Fax: +44-1525-850011
- U.S.A.**
GRUNDFOS Water Utility Headquarters
856 Koomey Road
Brookshire, Texas 77423 USA
- Uzbekistan**
Grundfos Tashkent, Uzbekistan
The Representative Office of Grundfos
Kazakhstan in Uzbekistan
38a, Oybek street, Tashkent
Tel.: (+998) 71 150 3290 / 71 150 3291
Fax: (+998) 71 150 3292

| |
|-------------------------|
| 99558952 02.2022 |
| ECM: 1335276 |